

We are IntechOpen, the world's leading publisher of Open Access books Built by scientists, for scientists

5,900

Open access books available

145,000

International authors and editors

180M

Downloads

Our authors are among the

154

Countries delivered to

TOP 1%

most cited scientists

12.2%

Contributors from top 500 universities



WEB OF SCIENCE™

Selection of our books indexed in the Book Citation Index
in Web of Science™ Core Collection (BKCI)

Interested in publishing with us?
Contact book.department@intechopen.com

Numbers displayed above are based on latest data collected.
For more information visit www.intechopen.com



Applications of Modern Pyrolysis Gas Chromatography for the Study of Degradation and Aging in Complex Silicone Elastomers

James P. Lewicki and Robert S. Maxwell

Additional information is available at the end of the chapter

<http://dx.doi.org/10.5772/57509>

1. Introduction

1.1. Silicones – Complex and challenging synthetic polymeric materials

Silicone based materials (polymers, polymeric network elastomers, composites and hybrid materials) are a ubiquitous class of synthetic polymeric system – encountered commonly in the research, industrial and commercial areas [1]. Silicones find use in diverse areas, ranging from industrial power distribution [1], as biomedical implants [2], in the advanced electronics sector [3, 4] and the aerospace industry [5]. No one material can be considered a representative ‘silicone’ as the definition ranges from low viscosity liquids through compliant elastomers and gums, to intractable high modulus solids. In general however, silicones can be considered to be polymeric materials based upon an $[(R_2Si)-O]$ repeating unit and they are most often structurally complex, multi-component systems which incorporate both chemically and physically diverse structural architectures. (See Figure 1)

It is important to understand from the outset in this chapter that gaining an understanding of the relationship between the multi-scale structure of a complex silicone system such as a commercial silicone elastomer and the resultant macroscopic properties and performance must be the goal of any informed approach to both performance and lifetime prediction of current service materials [6] and the rational development of the next generation of high performance silicone systems. [7-10]

Of all the silicone based materials in use today, it is arguably *silicone elastomers* that are both the most complex in overall structure and challenging in their analysis: Polymer structure, cure chemistry, network functionality, filler type and loading levels are just some of the

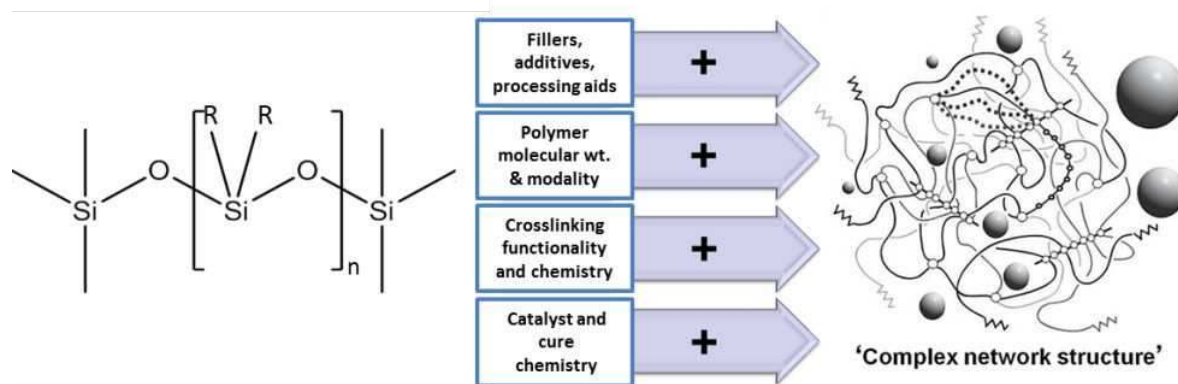

Figure 1. Left: The basic repeating structure of a polysiloxane (silicone) polymer. Right: A representation of some of the main factors that make up the overall, complex structural architecture of a silicone material.

variables that go into defining a final 3-dimensional, multi-scaled silicone ‘network’ elastomer. However there is a very real lack of data available on the specific structure of many important classes of silicone elastomer, due to both the proprietary nature of many industrial formulations and the simple fact that these materials are difficult to analyze at high fidelity: Silicone elastomer systems are most often chemically crosslinked networks with an effective infinite molecular weight and are as such, insoluble & *intractable*. Therefore they are inaccessible to the majority of spectroscopic and chromatographic techniques which are commonly employed for chemical Identification, characterization of structure-property relationships in polymeric systems and powerful techniques such as GCMS cannot be directly employed for the analysis of silicone elastomers. In the past these issues were not as prevalent as they are today due to the less intensive requirements of, and demands on silicone elastomers in application [11]. Simple empirically based additive methodologies were often relied upon for investigating structure-property relationships in silicone elastomers for the elucidation of chemical structure and the prediction of materials performance. [12-15] However, using these comparatively basic approaches, all but the most coarse grain information on network structure were obtained and the specifics of the ‘network architecture’ were largely overlooked. Today, it is accepted that the macroscopic properties and dynamic performance of a silicone elastomer system over time are subject to the multi-scale structure of the material over a range of size scales and that even comparatively small alterations to the network structure can lead to significant changes in materials properties [16, 17] (see Figure 2).

With this information in hand, it is clear that there is a need to move beyond basic ‘bulk’ empirical approaches to defining structure property relationships in silicones. Instead, we must employ higher resolution analytical methodologies to these materials - in order to relate the underlying network structure, (from an atomistic to a meso-scale level) directly to macroscopic materials behavior.

In spite of the intractability of silicone elastomers towards standard spectroscopic and analytical techniques, much progress has been made towards enhancing understanding of

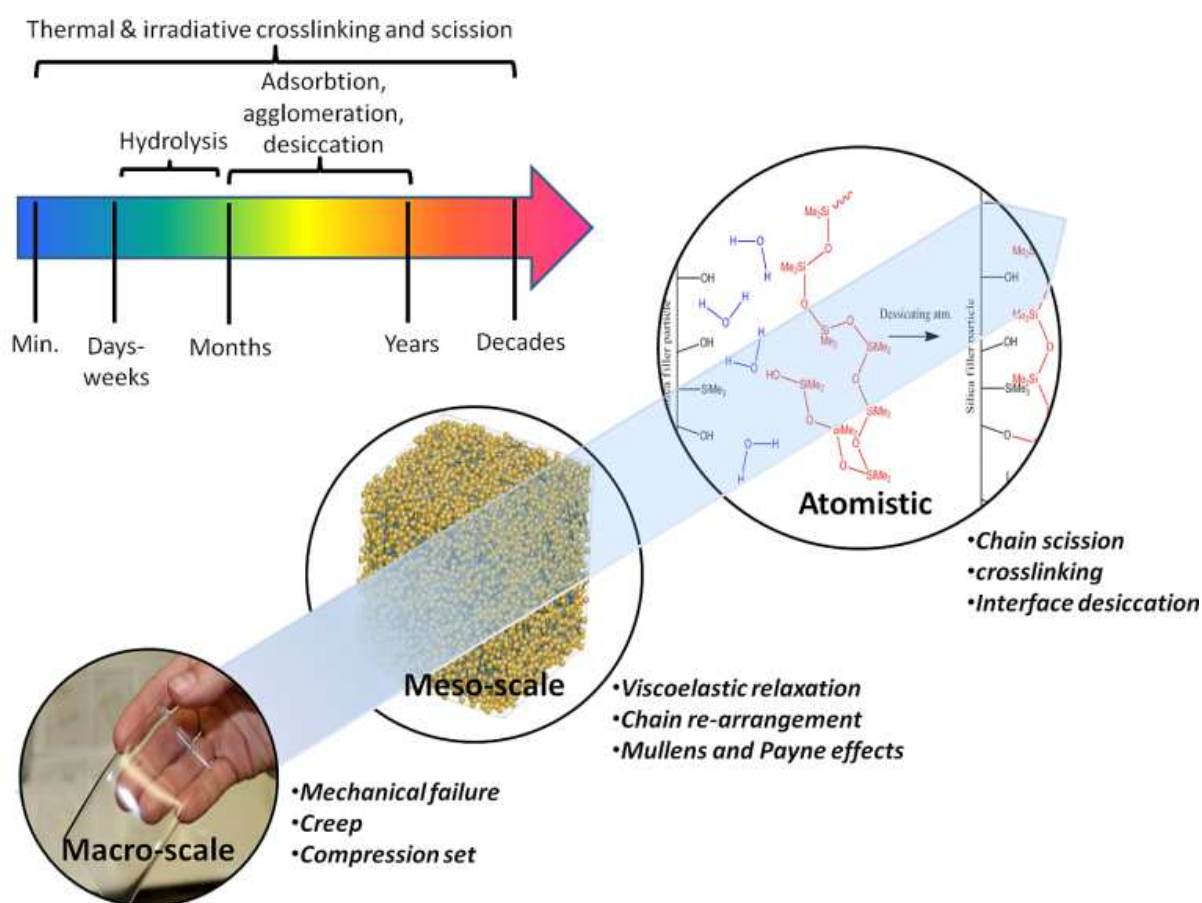

Figure 2. Main: Illustration of the complex relationship between materials properties/performance and structure over a range of size scale, from atomistic to a macro-scale. Inset: the time dependencies of various 'aging' processes that effect silicone systems in a service environment.

structure-property relations in complex siloxanes. Many researchers have made extensive use of solid state Nuclear Magnetic Resonance (NMR) both as a method of determining the chemical content/makeup of the polymer backbone in commercial silicone formulations [18] and as a tool for probing segmental dynamics of silicone networks in the solid state. [6, 19, 20] While NMR in particular has been shown extensively [21-23] as a powerful tool for elucidating the chemical identity and network architecture of complex siloxane networks, the methods employed are typically non-trivial, can be time intensive and potentially costly; requiring both significant investment in instrumentation and expertise.

Degradative thermal analysis (the thermally induced de-polymerization of a polymer or polymer network) offers an alternate route to the analysis of such complex materials. Through a destructive analysis of silicone networks and the characterization of the resultant products of thermal degradation, a surprising amount of information on the chemical identity, structural architecture and even service history of the material can be gleaned. And indeed, various incarnations of pyrolytic analysis and gravimetry have been used extensively for the analysis of 'unknown' polymeric materials for many years. [24-27] The temperature at which a

polymeric material degrades, the mechanism and the products of the thermal degradation are all a function of its *underlying chemical structure* and even physical morphology. Different polymeric materials can therefore be 'fingerprinted' by their thermal or thermo-oxidative degradation behavior. Importantly for the purposes of this discussion, such degradative analyses also re-open the possibility of utilizing GC/MS as a characterization tool. However it must be noted that the complex speciation of degradation products from silicone elastomers can make the interpretation of the data with respect to the original structure challenging.

2. A silicone degradation primer

Silicones, as with all polymeric materials will chemically degrade into a range of other compounds as a consequence of exposure to thermal, radiative or chemical processes with energy sufficient to scission, oxidize, hydrolyze or otherwise break the bonds of the polymer. It is the thermal stability of a silicone system however that is most often the defining factor in its application, performance and lifetime during service. Temperature broadly affects the rates and energetic favorability of all of the major degradation processes that occur in silicone systems (with the exception of non-oxidative ionizing radiation induced scission). For example, a system that is stable to acidic hydrolysis for years at room temperature may only last weeks before failing at 75°C (see Figure 3).

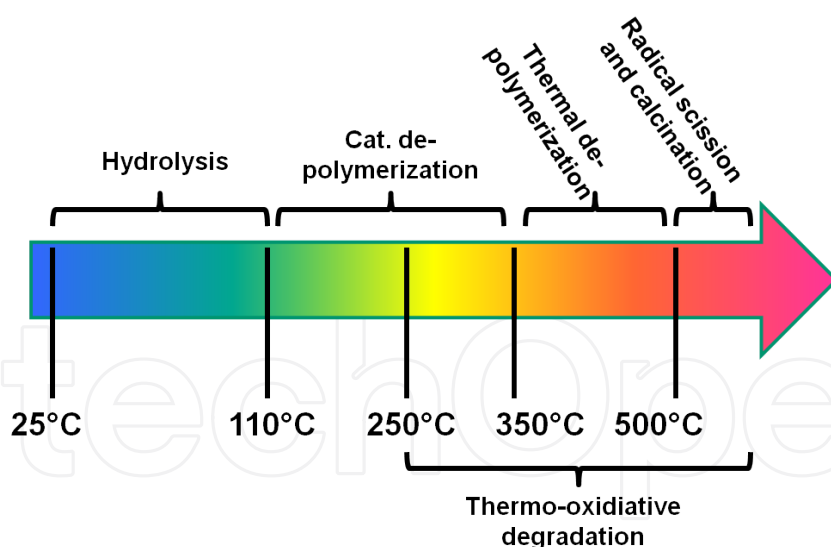

Figure 3. The primary mechanisms of silicone degradation as a function of temperature. Differing mechanisms are dominant over specific temperature ranges with more energetic process becoming dominant (within a specific time-frame) at higher temperatures.

It is unsurprising therefore, that since their introduction as usable materials some 60 years ago, there has been interest in the thermal stability and the mechanisms by which silicones degrade at elevated temperatures. The most influential work on the subject of the thermal degradation of the silicone polymers was carried out by Grassie et al. [28-35] who studied in detail the

thermal and thermo-oxidative degradation of a range of linear silicone polymers using a combination of Thermal Volatilization Analysis (TVA) and Thermogravimetric Analysis (TGA). Building upon earlier work by Pantode and Wilcock [36] and Thomas and Kendrick, [37, 38] Grassie demonstrated through an in-depth analysis of the products of thermal degradation that silicones, in general, at elevated temperatures degrade via a de-polymerization reaction to yield cyclic oligomeric siloxanes. This thermal de-polymerization reaction proceeds from both free chain ends and as a result of intra-molecular backbiting reactions of continuous chain segments (see Figure 4). For linear poly(dimethylsiloxane) (PDMS) Grassie and Macfarlane reported the major degradation products to be cyclic oligomeric siloxanes of ring sizes D_3 – D_{12} and higher oligomeric siloxane species.

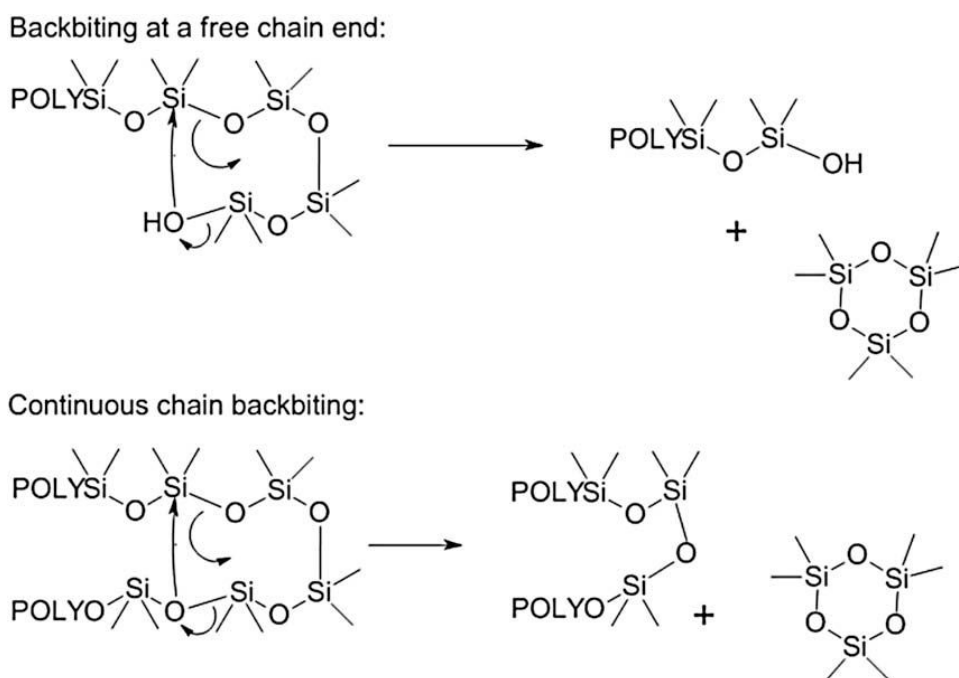

Figure 4. Intramolecular chain backbiting mechanisms. Upper scheme illustrates the attack of a chain by its own OH terminated free end to form a cyclic siloxane. Lower scheme illustrates the case where a closed, continuous chain folds back upon itself and re-arrangement occurs to form a new Si-O bond and a free cyclic siloxane

Uncatalyzed backbiting and cyclization reactions such as those proposed by Grassie in Figure 4 are typically reported to occur at temperatures of 350–400 °C and are in essence, the reverse of the ring-opening polymerization reactions that are employed to synthesize high molar mass silicones from cyclic oligomeric silicone pre-cursors. From a thermodynamic standpoint the ceiling temperature for the polymerization of cyclic silicones to form PDMS is relatively low (~110 °C). The implication is therefore that the reverse reaction – de-polymerization to reform cyclic oligomers is thermodynamically favored above temperatures of 110°C. However as Grassie demonstrated [28] in the late 1970s even linear unmodified PDMS in the absence of catalyst residues or impurities is stable up to a temperature of 350°C and in practice, a silicone can rarely be expected to de-polymerize at a significant rate (unaided) at temperatures below 250 °C. It is therefore reasonable to assume that the influence of kinetic, steric and other factors

in real materials all contribute to higher experimentally observed thermal stabilities of silicones.

Backbiting cyclization reactions are recognized in the literature [28, 39] as one of the primary thermal degradation mechanisms that occur in silicone systems. Importantly, however these backbiting reactions become significantly more favorable in the presence of acid or base. [28, 40] The presence of catalytic levels of Lewis acids or bases is now known to accelerate the depolymerization reaction and lower the degradation temperature of silicones significantly. Such catalyzed backbiting reactions are dominant over a temperature range of 110-260 °C. Silicones are also highly susceptible to hydrolysis: The ([R₂Si]-O) bond is comparatively strong, having an average bond disassociation energy of 452 KJ mol⁻¹, it is strongly polar and sterically unhindered, making the Si center highly susceptible to nucleophilic attack. A practical consequence of this nucleophilic susceptibility is that silicones are readily hydrolyzed under mildly acidic or basic conditions. At temperatures below 110 °C, thermal hydrolysis is one of the most significant processes that contribute to the long term aging and failure of silicone elastomers. [41]

Today, the thermal degradation chemistry of simple, linear siloxane systems is relatively well understood. However, many commercial siloxane polymer systems are significantly more complex. Such systems may contain inorganic fillers, crosslinking agents, catalysts, processing aids, synthesis residues, curing reaction by-products and other chemical 'complications' – all of which can alter their degradation behavior significantly. [42-46] Such systems are non-trivial to both analyze structurally, predict the properties of long-term and are the subject of much research today. [5, 27, 47-49]

3. Analytical degradative thermal analysis

3.1. Introduction

There are a number of degradative thermal analysis techniques available for the analysis of silicones which include Thermal-Gravimetric Analysis (TGA), Differential Scanning Calorimetry (DSC) Pyrolysis-Gas Chromatography/Mass Spectrometry (Py-GC/MS). These methods (and others), their application and the broader field of thermal analysis of polymers have been reviewed thoroughly in the excellent text by Wunderlich. [50] However, for the purposes of discussing analytical thermal methods for the determination of structural information from complex silicone networks, we will focus ourselves only on those techniques capable of providing chemical information on the products of silicone degradation as a function of temperature with the potential for quantification. Specifically, pyrolysis methods coupled with chromatography/spectrometry/scopy - such as Py-GC/MS.

Silicones degrade to form a range of degradation products and it has been established that both gross alterations in the chemical nature of the silicone polymer [28-35] and relatively subtle alterations in the network architecture of a silicone material [51, 52] can alter the speciation of products formed. It follows therefore that the purposeful, analytical degradation

of a silicone material coupled with the subsequent analysis of the products of degradation may allow the elucidation of an unknown network structure and even enable forensic identification (fingerprinting) of unknown engineering elastomers by their degradation profiles. [53]

3.2. Vacuum pyrolysis-mass spectrometry

Analytical pyrolysis (the controlled thermal degradation of organic or inorganic materials with the subsequent identification of the gas-phase products of degradation) has long been employed for the study of polymeric materials degradation. [26] In general, analytical pyrolytic methodologies involve the rapid thermal degradation (>100 °C/min) of a polymeric sample to complete thermal degradation under a controlled atmosphere. The effluent gas stream is analyzed by a secondary chromatographic and/or spectroscopic technique to identify the products of the thermal decomposition of the material. Pyrolytic methodologies rely on small sample masses, high analyte detection sensitivity and operate in a non-diffusion limited regime (See Figure 5).

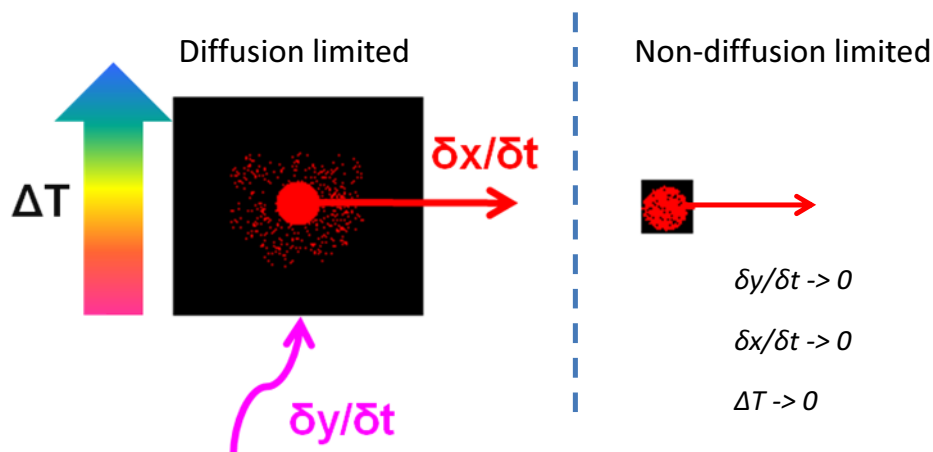

Figure 5. In bulk degradation analyses (5-50 mg sample size) (left) the sample mass requirements and the limitations of experimental geometry give rise to significant diffusion and thermal gradients, rates of diffusion for reactants into the materials and products out (dy/dt and dx/dt) are often ignored despite their importance in any kinetic or mass transport model derived from the data. A technique that allows the use sub-milligram samples or thin films, sidesteps many of these complications - simply on the basis of surface to volume ratio (right).

Pyrolytic analysis methodologies are therefore typically regarded as more versatile, less biased, chemical information rich techniques which can rapidly and more reliably access the mechanistic degradation behavior of polymeric materials. Early applications of what would later become analytical pyrolysis of silicone systems include work by Wacholtz et. al [54] in which the pyrolysis products of the thermal degradation of a silicone system were sampled and analyzed in-line using a combination of FTIR and GC/MS. Such early in-line pyrolysis studies of silicone degradation would later form the basis of modern micro-analytical pyrolysis methodologies for the analysis of silicone degradation. However, until comparatively recent times the field of analytical degradative analysis of silicones was almost entirely dominated by the vacuum pyrolysis technique –Thermal Volatilization Analysis (TVA).

TVA is essentially an evolved gas analysis technique which is based upon the principle of accurate measurement of the pressure of volatile species evolved from a material undergoing a heating regime. TVA effectively monitors the evolution of volatile degradation products of a sample as a function of pressure vs. temperature as the sample is subjected to a linear heating ramp under vacuum. The technique was originally developed in the 1960s by Ian McNeill and co-workers [55] as a tool for studying polymer degradation. Being related to other vacuum based thermal analysis techniques used at this period to study polymer degradation, [56, 57] it rapidly became popular amongst polymer degradation groups and was utilized in many of the seminal studies of polymer degradation. [28] There were several incarnations of the basic technique and it saw its most advanced development in sub-ambient thermal volatilization analysis (SATVA) - which combined the differential monitoring of degradation behavior as a function of pressure, with the collection and separation of condensable volatile products by cryo-trapping and sub-ambient differential distillation. A general schematic diagram of a TVA system is shown in Figure 6.

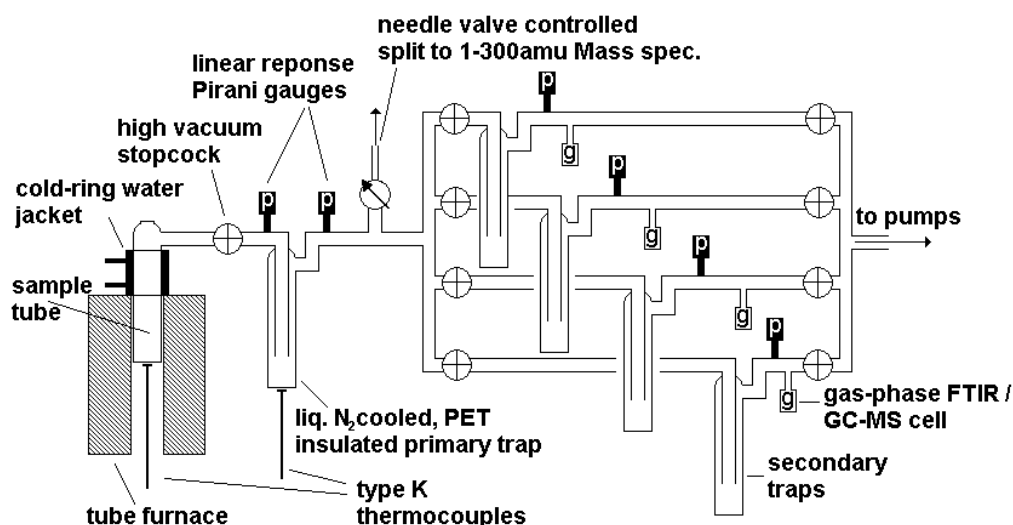

Figure 6. A general schematic representation of a TVA vacuum pyrolysis system

The apparatus consists of a sample chamber (heated by a programmable tube furnace) connected in series to a primary liquid nitrogen cooled cryo-trap and a set of four secondary cold traps. The system is continuously pumped to a vacuum of $\sim 1 \times 10^{-4}$ torr. Volatile condensable products can be initially trapped at two stages: The water jacket cooled 'cold-ring' ($T \sim 12^\circ\text{C}$) immediately above the heated area of sample tube which condenses high boiling point materials and the main cryo trap ($T \sim -196^\circ\text{C}$) which collects all the lower boiling point condensable species. Two linear response pressure gauges are positioned at the entrance and exit of the main cryo-trap to monitor the evolution of both condensable and non-condensable volatiles as a function of pressure vs. temperature/time from the sample. The primary cryo-trap captures all of the condensable lower boiling point species evolved during the pyrolysis of a sample. This trapped condensate can then be distilled into separate secondary liquid

nitrogen cooled cold traps by controlled heating of the primary trap to ambient or elevated temperatures. A mass spectrometer samples the gas stream continuously at the exit of the primary cryo-trap, providing a means of identifying non-condensable species such as methane or hydrogen evolved from a sample in addition to mass spectral identification of products in as they are separated during the differential distillation stage. Data from the mass spectrometer can be correlated with the sub-ambient distillation pressure peak plots and greatly aids in the identification of volatile species. Distilled product fractions can be subsequently removed into gas-phase cells for offline FTIR and GC/MS analysis. A series of secondary pressure gauges are placed at the entrance and exits of all secondary traps to monitor the distillation of specific product fractions into separate traps and gas cells.

The TVA technique is a vacuum pyrolysis method, coupled with a thermal trap/desorption system for volatile product separation and in many ways it is a predecessor to the modern pyrolysis-gas chromatography systems commonly in use today. The relative complexity both in design and operation of the method, along with the molecular weight range and resolution limitations of vacuum distillation separation prevented TVA and related vacuum pyrolysis 'line' systems from ever becoming more than a niche technique. And with the introduction of commercial gas chromatography systems directly coupled to fast quadrupolar mass filters throughout the 1970-1980s – the technique has been largely superseded by simpler and more versatile in-line pyrolysis GC/MS systems. That being said, a limited number of academics still utilize TVA as a means of studying polymer degradation [58-60] and indeed, it has even been used in recent years for the study of complex silicone nanocomposite elastomer systems. [51, 61] One such example is given in Figure 7.

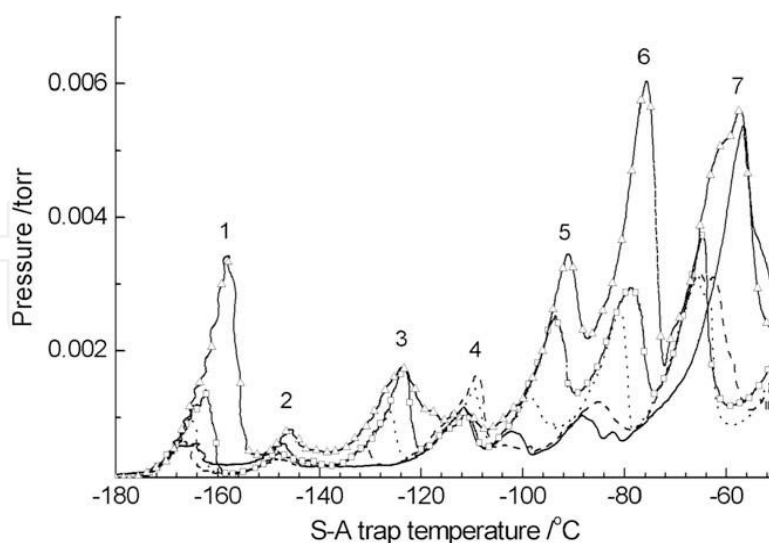

Figure 7. Sub-ambient differential distillation traces of the captured volatiles from the thermal degradation of an unfilled silicone and a range silicone-nanoclay composite systems. Solid, dashed, dotted, squares & circles represent 0, 2, 4, 6, & 8% clay filled composites respectively. Degradation products elute as a function of their boiling point as the trap is heated at a rate of 10 °C/min. The peaks labeled 1-7 were identified by a combination of gas-phase MS, gas-phase FTIR and GC-MS and are listed in Table 1. Reprinted with permission from. [51] Copyright Elsevier (2009).

Peak number	Product ID	Relative Abundance	Detector	Source
N/A non-condensable	Methane	minor	MS	high temp radical reactions
1	Propene & CO ₂	trace	MS/FTIR	elimination reaction of x-linker residues
2	butene	minor	MS/FTIR	catalyst residue elimination
3	the enolate form of dimethylsilanone	trace	MS/FTIR	main chain radical scission
4	Linear silicone –	minor	MS	x-linker residues
5	Propanal	trace	MS/FTIR	scission of chain end modifier
6	Benzene	minor	MS/FTIR	catalyst residue elimination
7	Ethyl hexanoic acid	minor	FTIR/GCMS	Catalyst residue (intact)
8 (not shown due to scale)	D ₃ -D ₅ cyclic oligomers	major	GCMS	thermal backbiting reactions
N/A semi-volatile	Higher oligomeric siloxanes	major	GCMS	thermal backbiting reactions & equilibration

Table 1. Identified products from the TVA analysis of a range of silicone nano-composite elastomers.

From the TVA data given in Figure 7 and Table 1 it is clear that while the quality of the chromatography from differential distillation is poor compared with GC/MS, there is still much data that can be obtained from such analyses. The speciation and distribution of products observed in this particular study allowed the authors to determine that a clay filler additive in a particular silicone network significantly changes the speciation of minor products formed via catalyzing secondary radical scission reactions at high temperatures.

3.3. Modern micro-pyrolysis-GC/MS

A more versatile approach to the analytical degradative analysis of the complex silicone based materials is modern Micro-Pyrolysis-coupled Gas Chromatography / Mass Spectrometry. More commonly referred to as Pyrolysis GC/MS, this technique was developed by and grew popular in the materials research and the oil industries. Py-GC/MS paralleled the development of commercial GC systems and found extensive application in the study of materials degradation and destructive analysis of intractable organic materials. The technique today remains disarmingly simple: a low thermal mass oven which is directly in-line with a detector (GC/MS etc.) heats a very small sample of analyte rapidly under inert or reactive carrier gas to destruction and the volatile products of degradation are passed by means of the carrier gas for analysis and optional separation by the detection instrument (see Figure 8).

Owing to the fact that the effluent stream of the furnace can be directly fed into the inlet of a sensitive GC/MS system, modern pyrolysis requires only extremely small analyte masses; from 1×10^{-3} to 1 mg is typical for an analytical pyrolysis of an organic containing material. Added to that, the thermal mass of a pyrolysis furnace is typically low and often in the form of a platinum coil/quartz tube 'probe' type geometry (See Figure 9). A broad range of heating rates

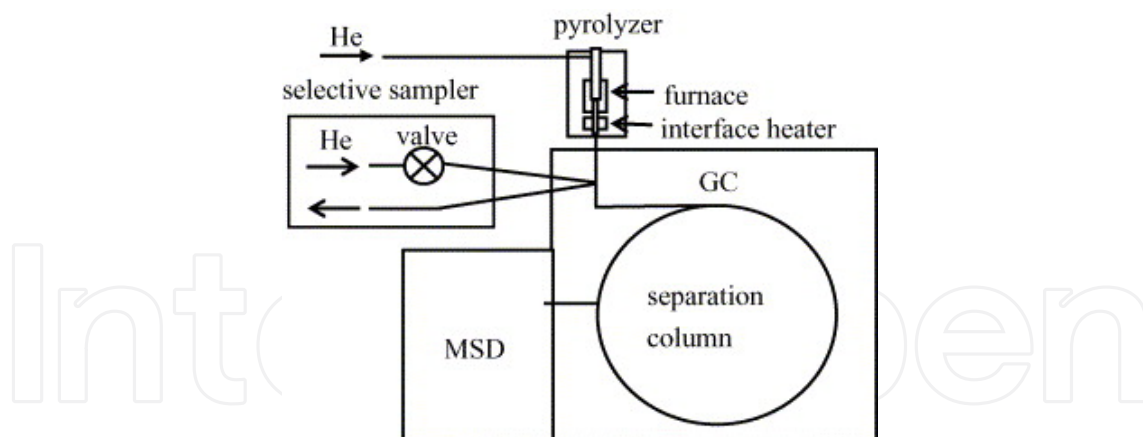

Figure 8. Schematic representation of an inline pyrolysis GC/MS system. Reprinted with permission from. [62] Copyright Elsevier (2006).

and a high maximum temperature are therefore accessible (0.01 to 999°C/min with a maximum of 1200 °C are typical).

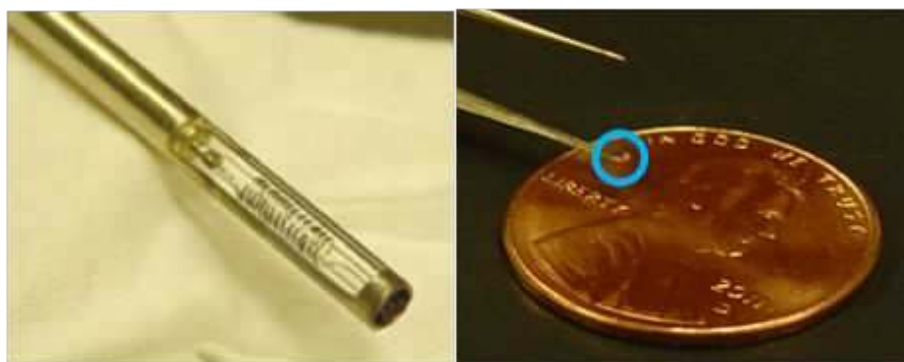

Figure 9. On the left is a modern pyrolysis probe showing the platinum coil heater and quartz sample tube. Right is an example of the typical mass of a silicone elastomer (highlighted by the blue circle) required for an analytical degradative analysis.

The ability to analyze such small samples of material; importantly allows degradation and off-gassing processes to be studied in a more ideal non-diffusion limited regime, negating the limitations of bulk analysis techniques such as TGA. One of the other great advantages of analytical Py-GC/MS is that it can provide both hi-fidelity, in-depth chemical speciation data in addition to rate/loss thermogram type data simply by means of changing the elution conditions of the GC column (see Figure 10).

Using pyrolysis-GC/MS we can monitor the degradation of a silicone system in real time (as in the left plot of Figure 10) to yield assessments of thermal stability, overall degradation profile and level of volatiles released. For example, in this study it was observed that the level of volatiles released from a silicone elastomer decrease markedly with increasing carbon nano-tube content. Importantly, however, we can also obtain full product separation and identifi-

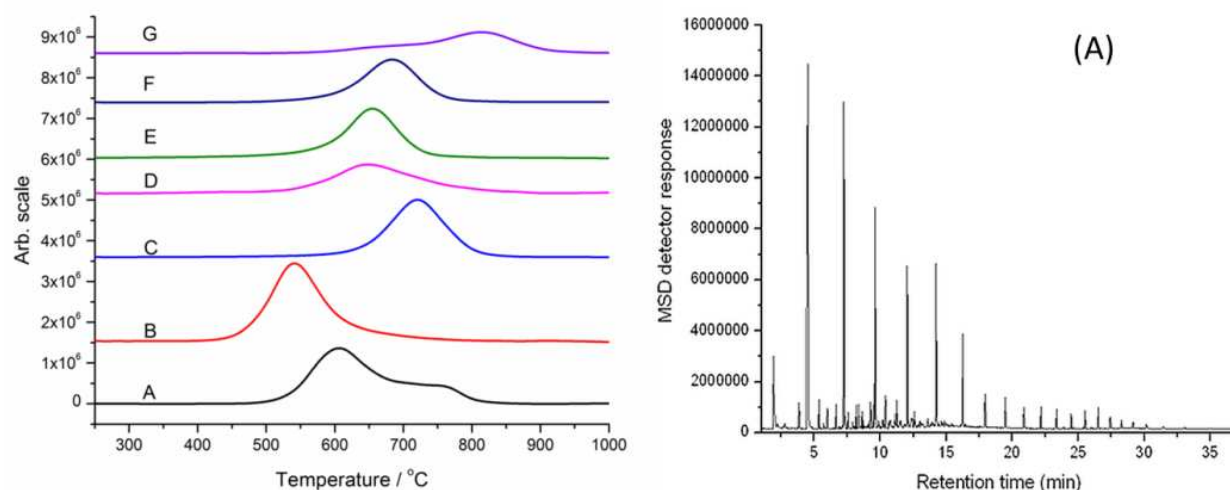

Figure 10. Degradative analysis of a series of silicone-carbon nanotube composites using Py-GC/MS. Left: pyrolysis thermogram data obtained by pyrolysing a series of silicone composites at a ramp rate of 100°C/min while using the GC/MS in a non-separating direct detection mode. A-G corresponds to silicone formations with increasing levels of carbon nanotubes. Right: full product speciation obtained from the ballistic pyrolysis of sample 'A' at 999 °C/min with the subsequent separation and speciation of the degradation products by GC/MS.

cation for a given degradation process using the same apparatus, now operating in the more conventional flash or 'ballistic' heating mode with full GC/MS separation and detection of analytes (right hand Figure 10). In this particular study it was shown from an analysis of the degradation products provided by Py-GC/MS that while the carbon nanotube additive did not significantly change the chemistry of the silicone degradation, it did physically retard the release of volatile species and increase the yield of calcined 'char' – thus leading to improved thermal stability.

3.4. Quantitative Py-GC/MS methods

As with the majority of GC based techniques, Py-GC/MS can through calibration, be fully quantitative with respect to the outgassing or degradation species being monitored. Through the use of an external calibrant standard (in the following example, analytical grade NaHCO₃) the instrument response to various gaseous species as a function of the total number of moles evolved from the pyrolysis event can be used to build a calibration curve. See Figure 11.

In the relatively simple example shown in Figure 11 varying masses of NaHCO₃ were pyrolysed under He in-line to 400 °C. This rapidly decomposed the bicarbonate to carbonate, CO₂ and H₂O in a fixed stoichiometric ratio. The pyrolysates were trapped on a cryo-cooled column to collimate them and then allowed to elute through the detector separately. Both ions 44 and 18 were monitored during chromatographic separation to yield a detector response as a function of moles of CO₂ and H₂O. With enough data points over a suitable mass range, instrument/method dependent calibration curves can be constructed which allow quantification of analyte gasses from unknown samples.

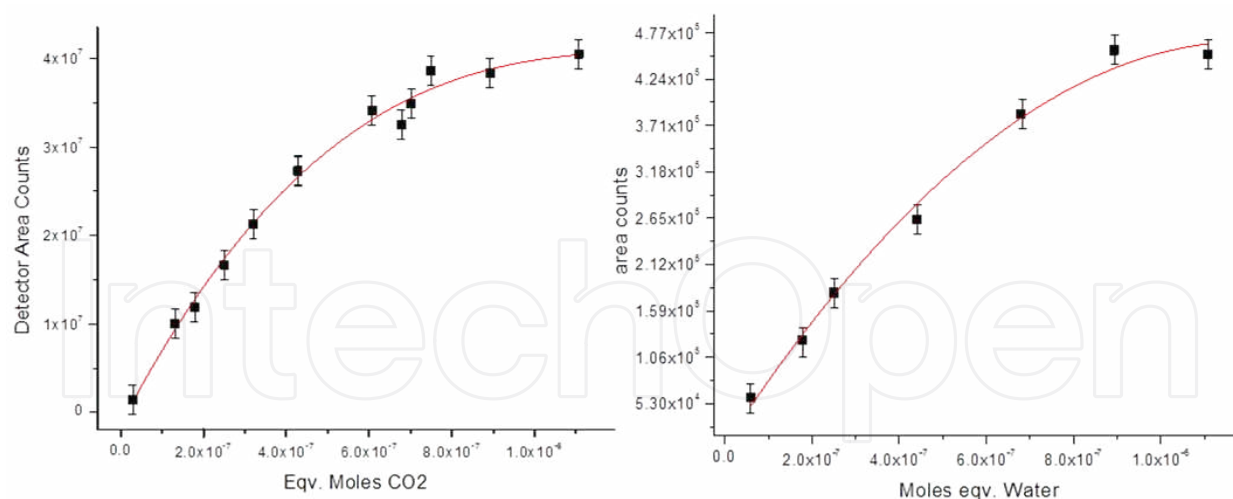

Figure 11. Py-GC/MS calibration curves obtained from the pyrolysis of known quantities of NaHCO₃. Both ions 44 and 18 were monitored during chromatographic separation to yield a detector response as a function of moles of CO₂ and H₂O.

Indeed, these data have been used in the following example to quantify the diffusion of CO₂ through a silicone membrane directly and as a function of temperature using Py-GC/MS. Shown in Figure 12 are the results of quantitative Py-GC/MS analysis of the diffusion of a sealed, finite CO₂ source through a 250 μm thick silicone membrane at a temperature of 120°C as a function of time.

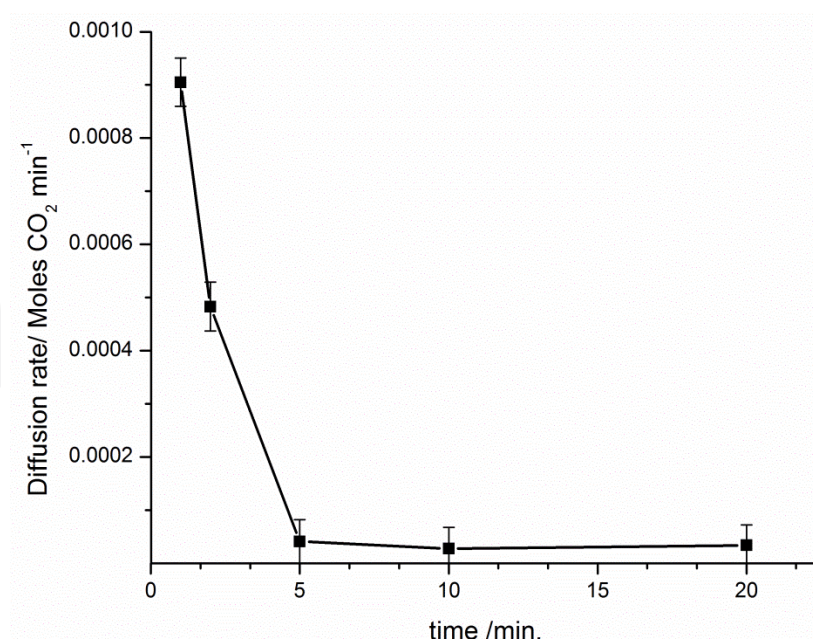

Figure 12. Evolution of CO₂ from a finite source, as measured by Py-GC/MS through a thin silicone membrane at elevated temperatures (quantitative on CO₂). Note that the initial rate of diffusion through the membrane is rapid but as the CO₂ source is depleted, a sharp decrease rate is observed.

4. The application of chemometric techniques to large Py-GC/MS datasets

Pyrolysis GC/MS data from silicone systems can be complex, with ion chromatograms from a single degradation or off-gassing process often having many hundred eluted products and a single study may yield many such individual chromatograms which must be interpreted. Often, therefore we must rely on more advanced data processing and mining techniques to both analyze these data in a timely manner and ensure that significant trends or processes are not lost in the sheer volume of data produced. A comparatively simple, yet highly effective chemometric technique that lends itself well to the analysis of such large chromatographic datasets is multivariate statistical analysis – specifically, Principle Components Analysis (PCA).

In PCA as with many other multivariate statistical techniques, sample-to-sample or object-to-object variation can be represented by a series of principal components (PCs), which preserve the structure of the underlying variance between two or more variables. The general aim of PCA is the reduction of the dimensionality of a data set by the computation of a small number of these components (typically much less than the number of variables) that are parameterized by so-called scores and loadings. See Figure 13.

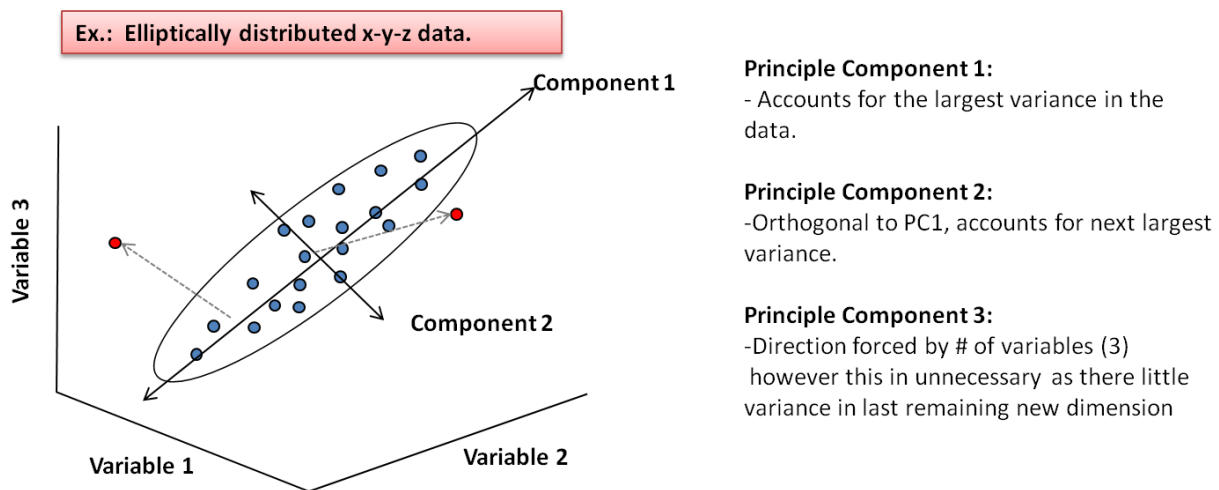

Figure 13. An illustration of the dimensional reduction that allows PCA to de-convolute large datasets. In this example there is elliptically distributed x, y, & z data (blue). Through an orthogonal coordinate rotation the largest variances in the data can be separated into principle components each with their own dimensionality. At the same time we reduce the overall dimensionality of the dataset by separating and discarding unwanted variables such as spectral noise. Finally, outliers are clearly identified outside of confidence limits in each PC.

Each component derived from PCA contains within it some proportion of the overall variance (generally expressed as a percentage of the total), with the first principal component (PC1) being the latent variable which describes the maximum amount of variance over a given dataset. PC2, the second principal component, is uncorrelated with (orthogonal to) the first PC

and accounts for the second largest percentage of the overall variance. Additional PCs can be defined similarly. For the pyrolysis data considered presently, the loading vectors profile the extent of retention time, with peaks representing regions of significant variance among samples. Scores provide information about the degree to which a given loading is important for a particular sample/chromatogram. In other terms, scores can be thought of as weights or as “concentrations” of loadings for the latent variables. [63]

PCA analysis has recently been applied to a number of studies of silicone degradation. [5, 52, 53] And in the first of two such studies we will discuss, the thermal degradation behavior of a series of well-defined model poly (dimethylsiloxane) model networks were investigated with Py-GC/MS and PCA in order to probe the influence of controlled network architectures on degradation chemistries and product profiles. A matrix of model silicone networks were formulated to incorporate a range of well-defined network architectures. Specifically; monomodal over a range of chain molar masses above and below the critical entanglement molar mass, M_c (~12 KDa); bimodal with varying mol. percentages of short (8 KDa) and long (133 KDa) chains; free chain end containing (a monomodal network with 1-20 mol. percent free chain ends). Samples were pyrolysed at a ballistic heating rate to 1000 °C under helium. The products of degradation were analyzed using in-line GC/MS to yield total ion chromatograms. Shown in Figure 14 is an example of a typical GC trace obtained from the pyrolysis of one of the model silicone networks.

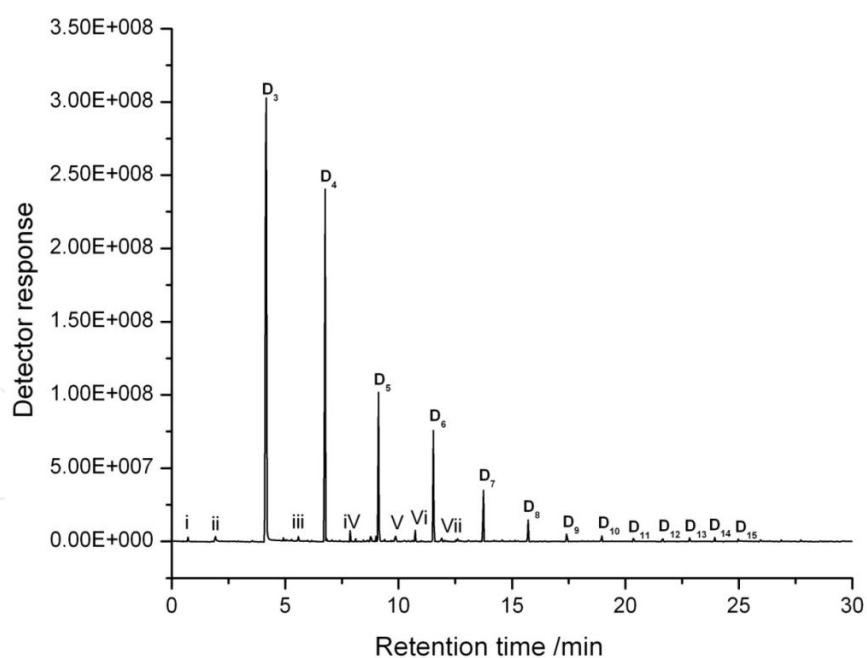

Figure 14. GC total ion chromatogram (TIC) of the pyrolysis products from a 0.04 mg sample of a 54.4 KDa monomodal crosslinked PDMS elastomer. The products of pyrolytic degradation are labeled D₃ to D₁₅ (cyclic siloxanes) and i-vii (misc small molecule, branched and linear species). Due the large size of the datasets obtained from such a study (>100 high resolution chromatograms each with 20-40 identified products) PCA was applied to the datasets. Shown in Figure 15 is a ‘samples and ‘scores’ plot for principal components 1 & 2 of a PCA model capturing 90% of the total variance in the complete matrix of silicones studied.

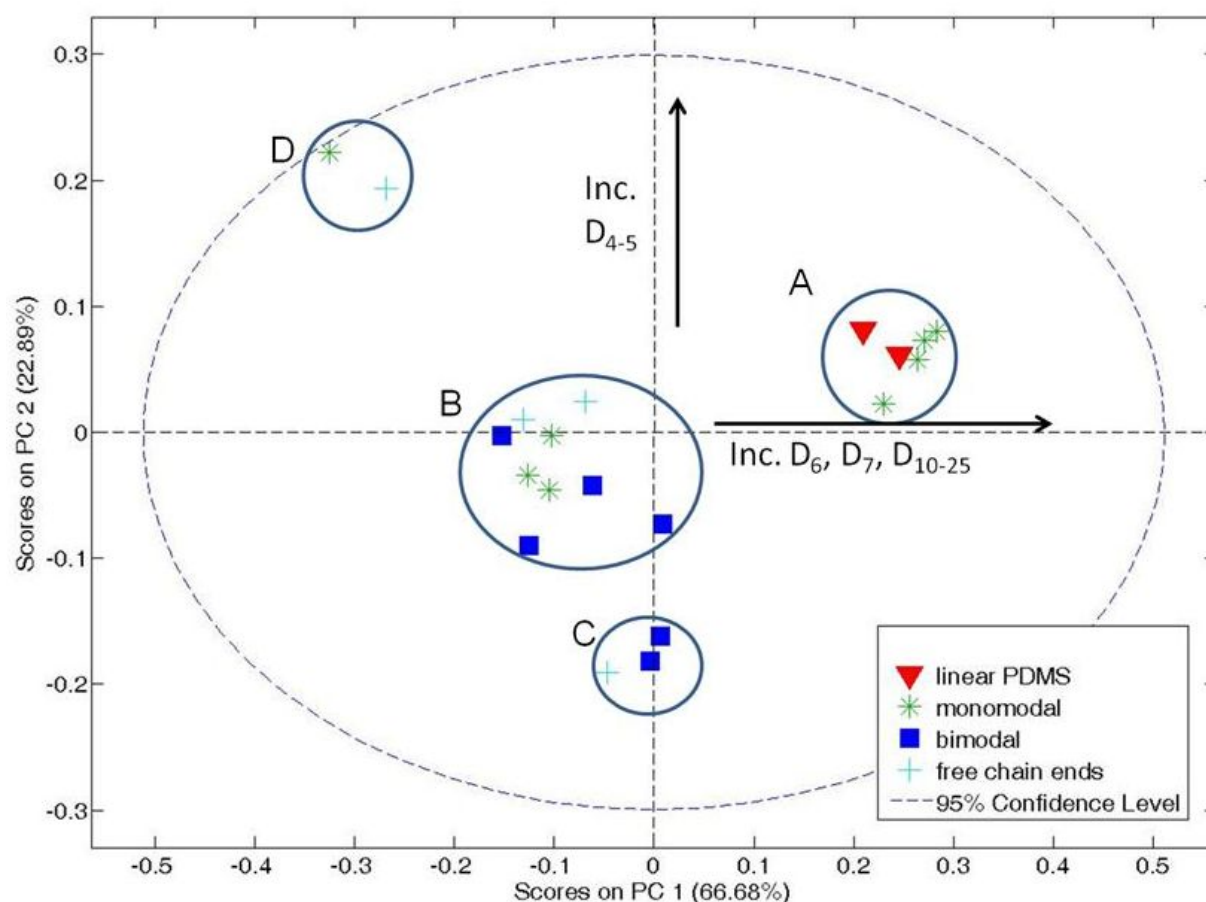

Figure 15. Samples-scores plot for PC's 1&2, complete sample matrix. The matrix had been grouped into four classes of data, corresponding to the linear PDMS, the monomodal, bimodal and free chain end subsets respectively. Groupings of samples are circled and labeled A-D.

From Figure 15 it is apparent that there are a number of significant groupings of samples (labeled A-D) suggesting that samples within these groupings degrade in a similar manner. Positive scores on PC1 (x-axis) have been correlated with increased relative yields of D_6 , D_7 & D_{10-25} cyclics. Positive scores on PC2 have been correlated with increased relative yields of D_4 & D_5 cyclics. These correlations are obtained from the analysis of variable 'loadings' plots as shown in Figure 16.

Loadings data such as the example shown in Figure 16 allow the variables responsible for a component to be readily examined. Here positive loadings correlate with increases in D_4 & D_5 cyclics and negative loadings relate to decreases in methane, propene levels and D_6 cyclics

From an examination of the scores and loadings of a valid PCA model we can make confident assertions as to both global trends and specific changes in degradation chemistry. From an examination of our PCA model in this example it can be observed that global degradation behavior of a large series of model silicones can be readily mapped using PCA. Trends made apparent through scores analysis can be related back to the underlying chemical information by means of the variable loadings data. These relations can in turn be used to correlate a specific chemical degradation behavior to the underlying network architecture. For example, Group

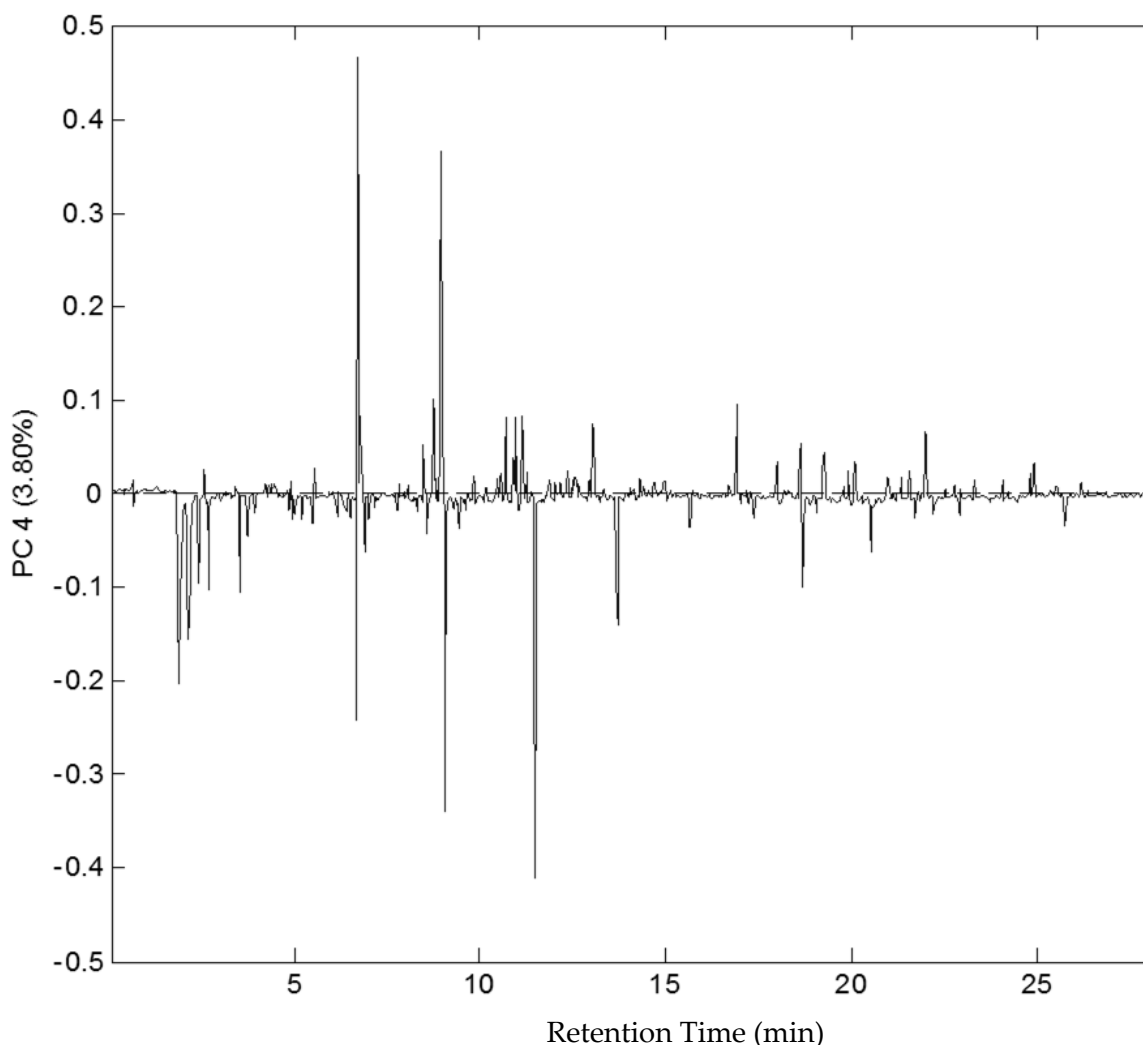

Figure 16. A loadings plot generated from a PCA model of silicone degradation pyrolysis data. Shown for example here is are the variables responsible for the 4th principle component of the model.

'A' in Figure 15 includes both 8 and 132 KDa linear PDMS and a series of 8, 10, 33 and 54 KDa monomodal networks. The strong positive score on PC1 for this group indicates that they yield increased levels of larger cyclic siloxanes relative the rest of the matrix. The samples in group 'B' include 1 and 10% free chain end samples, a 68 KDa monomodal material and a series 90, 80, 70 & 50% short chain bimodal networks. Group 'B' is representative of the mean degradation behavior of the model networks. Group 'C' includes a 5% free chain end, 80% and 95% short chain bimodal systems. Group 'C' displays broadly similar behavior to the mean group (B) however there are a somewhat reduced level of D₄₋₅ cyclics produced in this group of samples. The final group 'D' includes the 132 KDa monomodal sample and the 20% free chain end sample. Both of these samples evolve significantly reduced quantities of larger cyclics and increased levels of smaller D₄₋₅ cyclic siloxanes.

In the first example we demonstrated that Py-GC/MS methodologies can effectively discriminate between specific network architectures in simple model silicone systems as a function of

their degradation chemistry. Significantly, it has also recently been demonstrated [53] that valid structure property correlations can be drawn from the pyrolytic analysis of complex, real-world silicone elastomers. In this second example the thermal degradation behavior of a series of commercial and specialty silicones are compared, using a combination of py-GC/MS and PCA. A summary of the formulations analyzed are given in Table 2.

Elastomer	Base polymer(s)	Network Modality	Filler type and loading level	Cure Chemistry
DC 745 (Dow Corning)	Polydimethylsiloxane Polydiphenylsiloxane	Bimodal	30 Wt. % SiO ₂ (Mixture of high surface area fumed silica and low surface area quartz)	Free radical vinyl addition cure Organic peroxide catalyst.
TR-55 (Dow Corning)	PDMS Polydimethylhydrosilane Polymethylvinylsiloxane	Tri-modal	15-40% trimethylated silica	Free radical vinyl addition cure Organic peroxide catalyst.
M97 (LLNL)	PDMS PDPS PMVS	Bimodal	21.6% Cab-o-Sil M7-D silica 4% Hi Sil 233 silica	Free radical vinyl addition cure Organic peroxide catalyst.
Sylgard® 184 (Dow Corning)	PDMS PMHS	Bimodal	30% Vinyl functionalized Silica	Platinum mediated vinyl addition cure Platinum (0) complex catalyst
S5370 (Dow Corning)	PDMS PMHS	Bimodal	30% diatomaceous earth silicate filler (Celite 30 B)	Silanol-silane condensation cure Stannous Octanoate Catalyst

Table 2. Formulation reference data for each engineering silicone elastomer system studied categorized by base polymer, final network modality, filler type/loading and cure chemistry. Reprinted with permission from. [53] Copyright Elsevier (2013).

Using standard micro-pyrolysis methodologies, these silicone elastomers were analyzed and with the application of PCA, the following data were obtained; shown in Figure 17 is the global PC1&2 scores plot encapsulating >95% of the total variance in the complete dataset under a single four component model.

PCA of the complete pyrolysis dataset show distinct groupings (labeled A-D in Figure 17) of various elastomer types. These groupings can be correlated with aspects of their underlying network chemistries: The S5370 samples (A) are clear outliers due to the fact that they are the

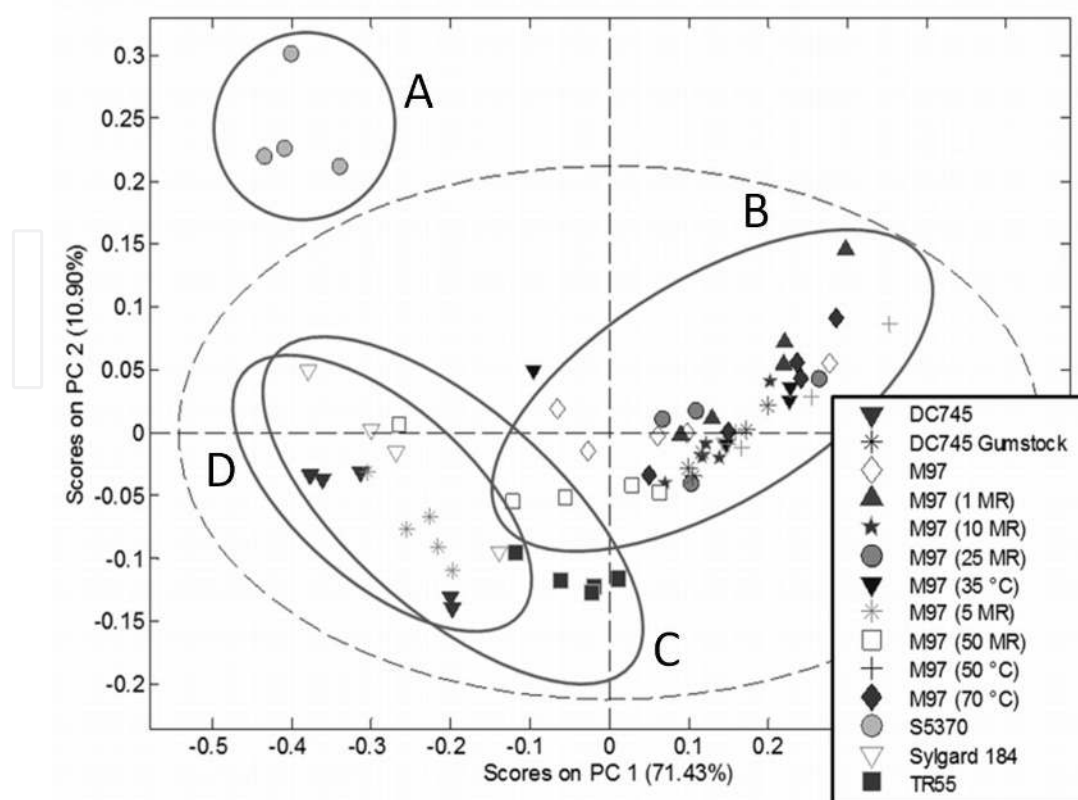

Figure 17. Global PC1 vs. PC2 Scores plots from the PCA of pyrolysis data of a series of commercial silicone elastomer formulations. The center of the plot at 0,0 can be considered represent the 'mean' of the degradation profiles averaged across the dataset as a whole. Solid lines are drawn for emphasis of groupings and labeled A-D and the dotted line represents the 95% confidence interval. Reprinted with permission from. [53] Copyright Elsevier (2013).

only system that is condensation cured and therefore significantly different in formulation to the other systems studied. In grouping (B) the M97 systems are observed to broadly group together on one axis *irrespective of their thermal or irradiative history*. This group of elastomers is in whole positive in PC1, however scattering is observed in the more extreme aged/irradiated samples; suggesting that the starting network structure is a more significant factor in determining the degradation behavior than any subsequent environmental factor. Moreover, the M97 series despite being peroxy cured addition networks and thus similar in chemistry to the majority of the other systems, remain distinct from the related commercial materials (TR55, DC745 and Sylgard 184). This distinction demonstrates that chemically similar silicone elastomers can be differentiated by means of pyrolysis GC/MS and multivariate analysis. Grouping (C) encompasses the behavior of TR55, which is neutral with respect to PC1 and negative on PC2. Finally grouping (D) highlights a correlation between The DC745 and Sylgard 184 degradation profiles.

It can therefore be shown that it is possible to link these distinct degradation 'fingerprints' to underlying chemical features of the networks themselves. The elastomers showing negative PC1 scores include those systems that are peroxy-cured: DC 745 and TR-55. DC 745 and an uncured DC 745 gumstock also group significantly in the lower left quadrant and are correlated

with Sylgard 184, a Pt catalyzed addition cured system (C-D). The most notable grouping on the PC1 vs. PC2 scores is that of S5370 (group A). Notably, S5370 is the only system which employs tin catalyzed condensation crosslinking chemistry [27] rather than radical or Pt mediated addition crosslinking. As such, the network structure of S5370 has no alkyl linkages at crosslinks and is therefore significantly different to that of all the other materials. S5370 is also only one of two materials in this study that are foams (the other being M97). There is however no correlation between M97 and S5370 on the PCA map, suggesting that the physical foam structure of these materials is not the predominant factor in determining their degradation behavior. The distinct S5370 grouping therefore appears to reflect a significantly different degradation behavior as a direct result of its differing network chemistry (a fully [Si-O] based network which retains an active tin catalyst residue, capable of promoting degradation reactions). [46, 64, 65]

The data clearly show that the degradation product profiles of the studied elastomers fall into distinct observable groupings which appear to correlate directly to major features of these systems formulation chemistry, e.g. the network chemistry and catalyst type. The physical structure of the materials (fully dense vs. cellular) does not appear to be a major factor in the degradation behavior; an observation that is consistent with the fact that microgram scale ballistic pyrolytic degradation occurs in a non-diffusion limited regime and should remain broadly independent of bulk sample effects. All of these observations are both notable and consistent with what is known about silicone network thermal degradation: Addition cured networks contain alkyl linkages and are as such not purely [Si-O] networks. Both the peroxy and Pt cured systems retain no active catalyst residues (unlike the tin cured systems) therefore backbiting thermolysis and catalytic de-polymerization reactions may be expected to occur at differing rates and with differing favorability to those of a purely [Si-O] based network which retains an active catalyst residue.

5. Conclusion

The aim of this chapter has been to demonstrate that analytical degradative analysis, when supported by modern gas-chromatography techniques is an effective and versatile tool for the in-depth study of highly complex, yet important silicone elastomers systems that are challenging to analyze with other established techniques. The case studies and reviews discussed in this chapter, demonstrate that silicone materials formulated via differing cure chemistries have distinct degradation fingerprints observable by means of analytical pyrolysis. The application of PCA statistical methodologies to Py-GC/MS data allows these unique signatures to be rapidly and reliably identified. Furthermore, PCA allows the chemical origins of the degradation fingerprints to be assessed with comparative ease. The structural architecture of a network elastomer and crosslinking chemistries employed in its formation can be related to its degradative behavior. It has also been demonstrated that the analytical pyrolysis methodologies currently employed are *insensitive* to those comparatively subtle chemical and physical alterations to a network as a result of thermal or irradiative 'aging' of a particular silicone elastomer system. Despite these limitations, degradative pyrolysis-GC/MS coupled with PCA

has been shown to be a rapid and effective investigative and predictive tool for analysis of complex silicone elastomers.

Acknowledgements

Portions of this work were performed under the auspices of the U.S. Department of Energy by Lawrence Livermore National Laboratory under Contract DE-AC52-07NA27344. The authors also gratefully acknowledge Mark E. Pearson and Cynthia T. Alviso (LLNL) for their assistance with TGA and photography.

Author details

James P. Lewicki and Robert S. Maxwell

Lawrence Livermore National Laboratory, Livermore, CA, USA

References

- [1] Arkles B. Look what you can make out of silicones. *Chem Tech.* 1983;13 (9):542-55. PubMed PMID: WOS:A1983RF44300007.
- [2] Yoda R. Elastomers for biomedical applications. *Journal of Biomaterials Science-Polymer Edition.* 1998;9 (6):561-626. PubMed PMID: WOS:000074512300004.
- [3] Allen KJ. Reel to real: Prospects for flexible displays. *Proceedings of the Ieee.* 2005 Aug;93 (8):1394-9. PubMed PMID: ISI:000230737600002.
- [4] Yoon J, Baca AJ, Park SI, Elvikis P, Geddes JB, Li LF, et al. Ultrathin silicon solar microcells for semitransparent, mechanically flexible and microconcentrator module designs. *Nature Materials.* 2008 Nov;7 (11):907-15. PubMed PMID: WOS:000260472800025.
- [5] Chinn SC, Alviso CT, Berman ESF, Harvey CA, Maxwell RS, Wilson TS, et al. MQ NMR and SPME Analysis of Nonlinearity in the Degradation of a Filled Silicone Elastomer. *J Phys Chem B.* 2010 Aug;114 (30):9729-36. PubMed PMID: WOS:000280361100002.
- [6] Maxwell RS, Chinn SC, Alviso CT, Harvey CA, Giuliani JR, Wilson TS, et al. Quantification of radiation induced crosslinking in a commercial, toughened silicone rubber, TR55 by H-1 MQ-NMR. *Polym Degrad Stab.* 2009 Mar;94 (3):456-64. PubMed PMID: WOS:000264010500023.

- [7] Wang SJ, Long CF, Wang XY, Li Q, Qi ZN. Synthesis and properties of silicone rubber organomontmorillonite hybrid nanocomposites. *J Appl Polym Sci.* 1998 Aug;69 (8):1557-61. PubMed PMID: WOS:000075150700010.
- [8] Phillips SH, Haddad TS, Tomczak SJ. Developments in nanoscience: polyhedral silsesquioxane (POSS)-polymers oligomeric. *Current Opinion in Solid State & Materials Science.* 2004 Jan;8 (1):21-9. PubMed PMID: WOS:000222987600004.
- [9] Liu C. Recent developments in polymer MEMS. *Adv Mater.* 2007 Nov;19 (22):3783-90. PubMed PMID: WOS:000251383900003.
- [10] Lewicki JP, Patel M, Morrell P, Liggat J, Murphy J, Pethrick R. The stability of polysiloxanes incorporating nano-scale physical property modifiers. *Science and Technology of Advanced Materials.* 2008;9 (2):024403.
- [11] Pocknell D, Thomas DR, Kendrick TC. Reinforcement in silicone rubber. Rheological studies of reinforcing and non-reinforcing fillers in silicone fluids. *Rubber and Plastics Age.* 1969;50 (9):690-&. PubMed PMID: WOS:A1969E371600019.
- [12] Traeger RK, Castongu.Tt. Effect of gamma-radiation on dynamic mechanical properties of styrene-butadiene rubbers. *J Appl Polym Sci.* 1966;10 (3):491-&. PubMed PMID: WOS:A19667468700013.
- [13] Bajaj P, Babu GN, Khanna DN, Varshney SK. Room temperature-vulcanized silicone elastomer - effect of curing conditions and the nature of filler on mechanical and thermal-properties. *J Appl Polym Sci.* 1979;23 (12):3505-14. PubMed PMID: WOS:A1979GZ79600007.
- [14] Hadjoudj A, David JC, Vergnaud JM. Model for predicting mechanical-properties of silicone sheet during pyrolysis with constant heating rate. *Thermochim Acta.* 1986 Jan;97:271-9. PubMed PMID: WOS:A1986AXN2400028.
- [15] Tobolsky AV, Prettyman IB, Dillon JH. Stress relaxation of natural and synthetic rubber stocks. *J Appl Phys.* 1944 Apr;15 (4):380-95. PubMed PMID: WOS:000200100400012.
- [16] Lewicki JP, Liggat JJ, Pethrick RA, Patel M, Rhoney I. Investigating the ageing behavior of polysiloxane nanocomposites by degradative thermal analysis. *Polym Degrad Stab.* 2008 Jan;93 (1):158-68. PubMed PMID: WOS:000253305500020.
- [17] Lewicki JP, Beavis PW, Robinson MWC, Maxwell RS. A Dielectric Relaxometry Study of Segmental Dynamics in PDMS/Boron Composite and Hybrid Elastomers. *Polymer.* submitted.
- [18] Maxwell RS, Chinn SC, Solyom D, Cohenour R. Radiation-induced cross-linking in a silica-filled silicone elastomer as investigated by multiple quantum H-1 NMR. *Macromolecules.* 2005 Aug;38 (16):7026-32. PubMed PMID: WOS:000230978500040.

- [19] Saalwachter K. Proton multiple-quantum NMR for the study of chain dynamics and structural constraints in polymeric soft materials. *Prog Nucl Magn Reson Spectrosc.* 2007 Aug;51 (1):1-35. PubMed PMID: ISI:000247284300001.
- [20] Saalwachter K, Ziegler P, Spyckerelle O, Haidar B, Vidal A, Sommer JU. H-1 multiple-quantum nuclear magnetic resonance investigations of molecular order distributions in poly (dimethylsiloxane) networks: Evidence for a linear mixing law in bimodal systems. *J Chem Phys.* 2003 Aug;119 (6):3468-82. PubMed PMID: ISI:000184350300056.
- [21] Kimmich R, Fatkullin N. Polymer chain dynamics and NMR. *Nmr - 3d Analysis - Photopolymerization.* 2004;170:1-113. PubMed PMID: WOS:000227578100001.
- [22] Spiess HW. Interplay of Structure and Dynamics in Macromolecular and Supramolecular Systems. *Macromolecules.* 2010 Jul;43 (13):5479-91. PubMed PMID: WOS:000279573600001.
- [23] Mayer BP, Lewicki JP, Weisgraber TH, Small W, Chinn SC, Maxwell RS. Linking Network Microstructure to Macroscopic Properties of Siloxane Elastomers Using Combined Nuclear Magnetic Resonance and Mesoscale Computational Modeling. *Macromolecules.* 2011 Oct;44 (20):8106-15. PubMed PMID: WOS:000295907200027.
- [24] Provder T, Urban MW, Barth HG, editors. *Differential scanning calorimetry—fourier transform IR spectroscopy and thermogravimetric analysis—fourier transform IR spectroscopy to differentiate between very similar polymer materials: American Chemical Society; 1994.*
- [25] Ettore K, Varadi PF. Pyrolysis-gas chromatographic technique for direct analysis of thermal degradation products of polymers. *Anal Chem.* 1962;34 (7):752-&. PubMed PMID: WOS:A19624029A00020.
- [26] Ke B. Differential thermal analysis of high polymers.6. comments on some material and experimental factors. *Journal of Polymer Science Part a-General Papers.* 1963;1 (4):1453-&. PubMed PMID: WOS:A19636802B00017.
- [27] Patel M, Chinn S, Maxwell RS, Wilson TS, Birdsell SA. Compression set in gas-blown condensation-cured polysiloxane elastomers. *Polym Degrad Stab.* 2010 Dec;95 (12):2499-507. PubMed PMID: WOS:000285851800036.
- [28] Grassie N, Macfarlane IG. Thermal-degradation of polysiloxanes.1. poly (dimethylsiloxane). *Eur Polym J.* 1978;14 (11):875-84. PubMed PMID: WOS:A1978FX16600001.
- [29] Grassie N, Macfarlane IG, Francey KF. Thermal-degradation of polysiloxanes.2. poly (methylphenylsiloxane). *Eur Polym J.* 1979;15 (5):415-22. PubMed PMID: WOS:A1979GY96900001.
- [30] Grassie N, Francey KF. The thermal-degradation of polysiloxanes.3. poly (dimethylmethyl phenyl siloxane). *Polym Degrad Stab.* 1980;2 (1):53-66. PubMed PMID: WOS:A1980KS80700004.

- [31] Grassie N, Francey KF, Macfarlane IG. The thermal-degradation of polysiloxanes.4. poly (dimethyl-diphenyl siloxane). *Polym Degrad Stab.* 1980;2 (1):67-83. PubMed PMID: WOS:A1980KS80700005.
- [32] Grassie N, Beattie SR. The thermal-degradation of polysiloxanes.8. poly (methyl-phenyl-para-silphenylene-siloxane). *Polym Degrad Stab.* 1984;9 (1):23-40. PubMed PMID: WOS:A1984TD79000003.
- [33] Grassie N, Beattie SR. The thermal-degradation of polysiloxanes.7. mechanism of degradation of poly (tetramethyl-para-silphenylene siloxane) and copolymers with dimethylsiloxane. *Polym Degrad Stab.* 1984;8 (3):177-93. PubMed PMID: WOS:A1984TA17300004.
- [34] Grassie N, Beattie SR. The thermal-degradation of polysiloxanes.5. synthesis, characterization and thermal-analysis of poly (tetramethyl-p-silphenylene siloxane) and copolymers with dimethylsiloxane. *Polym Degrad Stab.* 1984;7 (2):109-26. PubMed PMID: WOS:A1984SL20500004.
- [35] Grassie N, Beattie SR. The thermal-degradation of polysiloxanes.6. products of degradation of poly (tetramethyl-para-silphenylene siloxane) and copolymers with dimethylsiloxane. *Polym Degrad Stab.* 1984;7 (4):231-50. PubMed PMID: WOS:A1984SV05800004.
- [36] Patnode W, Wilcock DF. Methylpolysiloxanes. *J Am Chem Soc.* 1946;68 (3):358-63. PubMed PMID: WOS:A1946UB30600004.
- [37] Thomas TH, Kendrick TC. Thermal analysis of polydimethylsiloxanes.i. thermal degradation in controlled atmospheres. *Journal of Polymer Science Part a-2-Polymer Physics.* 1969;7 (3PA2):537-&. PubMed PMID: WOS:A1969D456700008.
- [38] Thomas TH, Kendrick TC. Thermal analysis of polysiloxanes.2. thermal vacuum degradation of polysiloxanes with different substituents on silicon and main siloxane chain. *Journal of Polymer Science Part a-2-Polymer Physics.* 1970;8 (10):1823-&. PubMed PMID: WOS:A1970H518800016.
- [39] Camino G, Lomakin SM, Lageard M. Thermal polydimethylsiloxane degradation. Part 2. The degradation mechanisms. *Polymer.* 2002 Mar;43 (7):2011-5. PubMed PMID: WOS:000173952000005.
- [40] Osthoff RC, Bueche AM, Grubb WT. Chemical stress relaxation of polydimethylsiloxane elastomers. *J Am Chem Soc.* 1954;76 (18):4659-63. PubMed PMID: WOS:A1954UB507000051.
- [41] Lewis FM. The Science and Technology of Silicone Rubber. *Rubber Chem Technol.* 1962;35 (5):1222-75.
- [42] Vanderweij FW. The action of tin-compounds in condensation-type rtv silicone rubbers. *Makromolekulare Chemie-Macromolecular Chemistry and Physics.* 1980;181 (12):2541-8. PubMed PMID: WOS:A1980KX11500011.

- [43] Patel M, Skinner AR. Thermal ageing studies on room-temperature vulcanised polysiloxane rubbers. *Polym Degrad Stab.* 2001;73 (3):399-402. PubMed PMID: WOS:000170825400006.
- [44] Patel M, Skinner AR. The effect of thermal aging on the non-network species in room temperature vulcanized polysiloxane rubbers. In: Clarson SJ, Fitzgerald JJ, Owen MJ, Smith D, VanDyke ME, editors. *Synthesis and Properties of Silicones and Silicone-Modified Materials.* Acs Symposium Series. 8382003. p. 138-50.
- [45] Patel M, Soames M, Skinner AR, Stephens TS. Stress relaxation and thermogravimetric studies on room temperature vulcanised polysiloxane rubbers. *Polym Degrad Stab.* 2004 Jan;83 (1):111-6. PubMed PMID: WOS:000187855300014.
- [46] Patel M, Skinner AR, Maxwell RS. Sensitivity of condensation cured polysiloxane rubbers to sealed and open-to air thermal ageing regimes. *Polym Test.* 2005 Aug;24 (5):663-8. PubMed PMID: WOS:000229979000019.
- [47] Maiti A, Weisgraber T, Dinh LN, Gee RH, Wilson T, Chinn S, et al. Controlled manipulation of elastomers with radiation: Insights from multiquantum nuclear-magnetic-resonance data and mechanical measurements. *Physical Review E.* 2011 Mar;83 (3). PubMed PMID: WOS:000288698800003.
- [48] Maxwell RS, Gee RH, Baumann T, Lacevic N, Herberg JL, Chinn SC. Characterization of Complex Engineering Silicones by H-1 Multiple Quantum NMR and Large Scale Molecular Dynamics Simulations. *Advances in Silicones and Silicone-Modified Materials.* 2010;1051:75-84. PubMed PMID: WOS:000305197500007.
- [49] Chasse W, Lang M, Sommer JU, Saalwachter K. Cross-Link Density Estimation of PDMS Networks with Precise Consideration of Networks Defects. *Macromolecules.* 2012 Jan;45 (2):899-912. PubMed PMID: WOS:000299366300032.
- [50] Wunderlich B. *Thermal Analysis of Polymeric Materials.* New York: Springer Publishing; 2005.
- [51] Lewicki JP, Liggat JJ, Patel M. The thermal degradation behaviour of polydimethylsiloxane/montmorillonite nanocomposites. *Polym Degrad Stab.* 2009 Sep;94 (9):1548-57. PubMed PMID: WOS:000269106300031.
- [52] Lewicki JP, Mayer BP, Alviso CT, Maxwell RS. Thermal Degradation Behavior and Product Speciation in Model Poly (dimethylsiloxane) Networks. *Journal of Inorganic and Organometallic Polymers and Materials.* 2012 May;22 (3):636-45. PubMed PMID: WOS:000303417300011.
- [53] Lewicki JP, Albo RLF, Alviso CT, Maxwell RS. Pyrolysis-gas chromatography/mass spectrometry for the forensic fingerprinting of silicone engineering elastomers. *Journal of Analytical and Applied Pyrolysis.* 2013 Jan;99:85-91. PubMed PMID: WOS:000315240700012.
- [54] Wachholz S, Keidel F, Just U, Geissler H, Kappler K. Analysis of a mixture of linear and cyclic siloxanes by cryo-gas chromatography fourier-transform infrared-spectro-

- scopy and gas-chromatography mass-spectrometry. *J Chromatogr A*. 1995 Feb;693 (1):89-99. PubMed PMID: WOS:A1995QJ64300011.
- [55] McNeill IC, Ackerman L, Gupta SN, Zulfiqar M, Zulfiqar S. Analysis of degradation products by thermal volatilization analysis at subambient temperatures. *Journal of Polymer Science Part a-Polymer Chemistry*. 1977;15 (10):2381-92. PubMed PMID: WOS:A1977DW34100008.
- [56] C. MI. Thermal analysis of polymers. In: N. G, editor. *Developments in Polymer Degradation*. 1: Applied Science Publishers; 1984. p. 43-67.
- [57] J. MW. Evolved gas analysis using vacuum pyrolysis. In: N. G, editor. *Developments in Polymer Degradation*. 5: Applied Science Publishers; 1977. p. 1-31.
- [58] Allan D, Daly J, Liggat JJ. Thermal volatilisation analysis of TDI-based flexible polyurethane foam. *Polym Degrad Stab*. 2013 2//;98 (2):535-41.
- [59] France LJ, Apperley DC, Ditzel EJ, Hargreaves JSJ, Lewicki JP, Liggat JJ, et al. An investigation of the nature and reactivity of the carbonaceous species deposited on mordenite by reaction with methanol. *Catalysis Science & Technology*. 2011;1 (6): 932-9. PubMed PMID: WOS:000294016600010.
- [60] Lewicki JP, Pielichowski K, De la Croix PT, Janowski B, Todd D, Liggat JJ. Thermal degradation studies of polyurethane/POSS nanohybrid elastomers. *Polym Degrad Stab*. 2010 Jun;95 (6):1099-105. PubMed PMID: WOS:000278750800025.
- [61] Lewicki JP, Liggat JJ, Hayward D, Pethrick RA, Patel M. Degradative Thermal Analysis and Dielectric Spectroscopy Studies of Aging in Polysiloxane Nanocomposites. In: Celina MC, Wiggins JS, Billingham NC, editors. *Polymer Degradation and Performance*. ACS Symposium Series. 10042009. p. 239-54.
- [62] Kumooka Y. Analysis of deteriorated rubber-based pressure sensitive adhesive by pyrolysis-gas chromatography/mass spectrometry and attenuated total reflectance Fourier transform infrared spectrometry. *Forensic Science International*. 2006 Nov; 163 (1-2):132-7. PubMed PMID: WOS:000241463200014.
- [63] K. V, P. F. *Introduction to Multivariate Statistical Analysis in Chemometrics*. Boca Raton: CRC Press; 2009.
- [64] Hall AD, Patel M. Thermal stability of foamed polysiloxane rubbers: Headspace analysis using solid phase microextraction and analysis of solvent extractable material using conventional GC-MS. *Polym Degrad Stab*. 2006 Oct;91 (10):2532-9. PubMed PMID: WOS:000239536200035.
- [65] Patel M, Morrell P, Cunningham J, Khan N, Maxwell RS, Chinn SC. Complexities associated with moisture in foamed polysiloxane composites. *Polym Degrad Stab*. 2008 Feb;93 (2):513-9. PubMed PMID: WOS:000254146200025.