

# ARM 7 based Intelligent System for Surveillance and Street Light Management

T.Hareesh

M. Tech Student, Dept. of ECE,  
Madanapalle Institute of Technology & Science,  
Angallu, Kurabalakota Mandal, Chittoor Dist., A.P,  
India.

J. L. Mazher Iqbal

Professor, Department of ECE,  
Madanapalle Institute of Technology & Science,  
Angallu, Kurabalakota Mandal, Chittoor Dist., A.P,  
India.

## ABSTRACT:

The proposed intelligent street light management system with surveillance optimizes management efficiency of street lighting. Usually street lights are in ON condition for twelve hours per day. Sensors are used to reduce the power consumption also wireless controlling and monitoring system. Street lights can be wirelessly monitored and control with the help of the ZigBee wireless transceiver. The transceiver collects and monitors the total data of particular lamp. Whenever vehicle crosses, the intelligent street light management system, surveillance camera and the street light are switched on and image is captured using surveillance camera. The proposed novel intelligent street light management system with surveillance count and record the number of vehicles crossing the road along with date and time records. If there is any accident happens on the road the recorded information automatically sent to the monitoring system using Global System for Mobile Communications (GSM) and ZigBee.

## Keywords

ARM7, wireless sensors, ZigBee module, Light sensor, IR Sensors, GPRS, GSM modem, Flash magic, relays, Wireless camera.

## 1. INTRODUCTION

In the present world basically road lighting framework fits in with open area. This devours 20% of the aggregate force and likewise it will contain numerous obstacles in the upkeep, for example, supplanting the harmed one's furthermore needs to check climate all the lights are at living up to expectations condition or not and exchanging on and off every day at specific times furthermore cost calculate additionally is high [1] [2]. At present numerous innovations created in the whole fields than additionally the road light framework is out linked and created on old strategies so to enhance the stands off road light framework.

We are attempting to actualize latest innovations in this field too. What's more the greater part of the organization are indicating much critics to most recent innovations by thinking of some as of the components, for example, wellbeing of the walkers and night voyagers et cetera. In the current framework by rolling out little improvements there are numerous conceivable outcomes to create road light framework agreeing to our present day existence without squandering time, power and cash too. The most importantly probability is supplanting the current light with the LED (light Emitting diode) light which expends less power and unwavering quality time is high when contrasted and different lights.

The second is to supplant the force supply from force lines of sunlight based vitality which is accessible for free of expense [3]. The third probability is including some additional

hardware which comprises of sensors, for example, vicinity sensor, crisis gadget, working sensor, light sensor, and IR (infra-red) sensor. By which the support of the framework get to be less complex when contrasted and old technique [4]. The last and vital probability is by including robotized and remote control framework focused around a sagacious light post that send data to the base station in regards to the working condition utilizing the latest advances, for example, GPRS(general parcel radio administration)/ GSM(global system for machine) by which we can give improved administration and support issues [5]. Lighting frameworks, particularly in people in general part, are still signed as per the old benchmarks of dependability and they frequently don't exploit the most recent mechanical improvements. By and large, this is identified with the plant overseers finished the reappearance of development offices. Then most natural, is the utilization of new wellsprings [6]. Outlining a progressed road lighting framework based in Leeds. The second conceivable result, the most progressive, utilization framework light presents focal control, this rearranging administration, and then supports issues created a road light bundle administration [7].

In this proposed Intelligent System, we are using a wireless camera for video, audio, image capturing for the System [8]. The main purpose of the System is to restrict the use of power and also to provide security to the campus being used [9].

## 2. SYSTEM DESCRIPTION

### 2.1 Micro controller:

This area structures the control unit of the entire task. This segment fundamentally comprises of a Microcontroller with its related hardware like Crystal with capacitors, Reset hardware, Pull up resistors (if necessary) et cetera. The Microcontroller structures the heart of the task on the grounds that it controls the gadgets being interfaced and speaks with the gadgets as indicated by the project being composed.

### 2.2 ARM7TDMI:

ARM is the shortening of Advanced RISC Machines, it is the name of a class of processors, and is the name of a kind innovative as well. The RISC guidelines set, and related disentangle component is much less complex than those of Complex Instruction Set Computer plans [9].

### 2.3 Liquid Crystal Display (LCD):

This is a level board show, electronic visual show that uses the light tweak properties of fluid gems. Fluid gems don't transmit light specifically. LCDs are accessible to show discretionary pictures or altered pictures which can be shown or stowed away, for example, preset words, digits, and 7 portion shows as in a computerized clock. They utilize the same essential engineering, with the exception of that subjective pictures are made up of an extensive number of

little pixels, while different showcases have bigger components.

### 2.4 GSM Modem Section:

This area comprises of a GSM modem. The modem will correspond with microcontroller utilizing serial correspondence. The modem is interfaced to microcontroller utilizing, a serial driver.

### 2.5 PC Section:

This area fundamentally contains a PC with Serial correspondence related fittings. Separated from this, the web cam is likewise associated with the PC. The serial correspondence related fittings, hardware incorporates the transport connector for PC to Microcontroller.

## 3. PROPOSED SYSTEM

In this section, we used the ARM 7TDMI processor, which utilizes a special structured procedure known as thumb, which makes it in a perfect word suited to high-volume applications with memory limitations, or applications where code

thickness is an issue. The LCD Display is used to display the intensity values from IR sensor and ZigBee to transmit the data corresponding to the entry of a vehicle / intruder and the camera being used captures the image and also the images are also transmitted to the monitoring unit. The block diagram of the intelligent system and monitoring section is shown with respective unit is stated.

In the event that the road light is not ceased after the night, the misfortune will proceed for the duration of the day. Furthermore the road light is a bit much when there are no human developments in the road. So to eliminate these burdens, this paper presents a ZigBee based road lighting framework. An application will be made for this specific framework and by utilizing this application the road light could be worked remotely by utilizing ZigBee. The human activity at any point across the streetlight is recorded using surveillance camera. After the daylight has been diminished in the road, then the street light is gleam by utilizing a light sensor. By utilizing this task wastage of power is decreased and human impact likewise diminished.

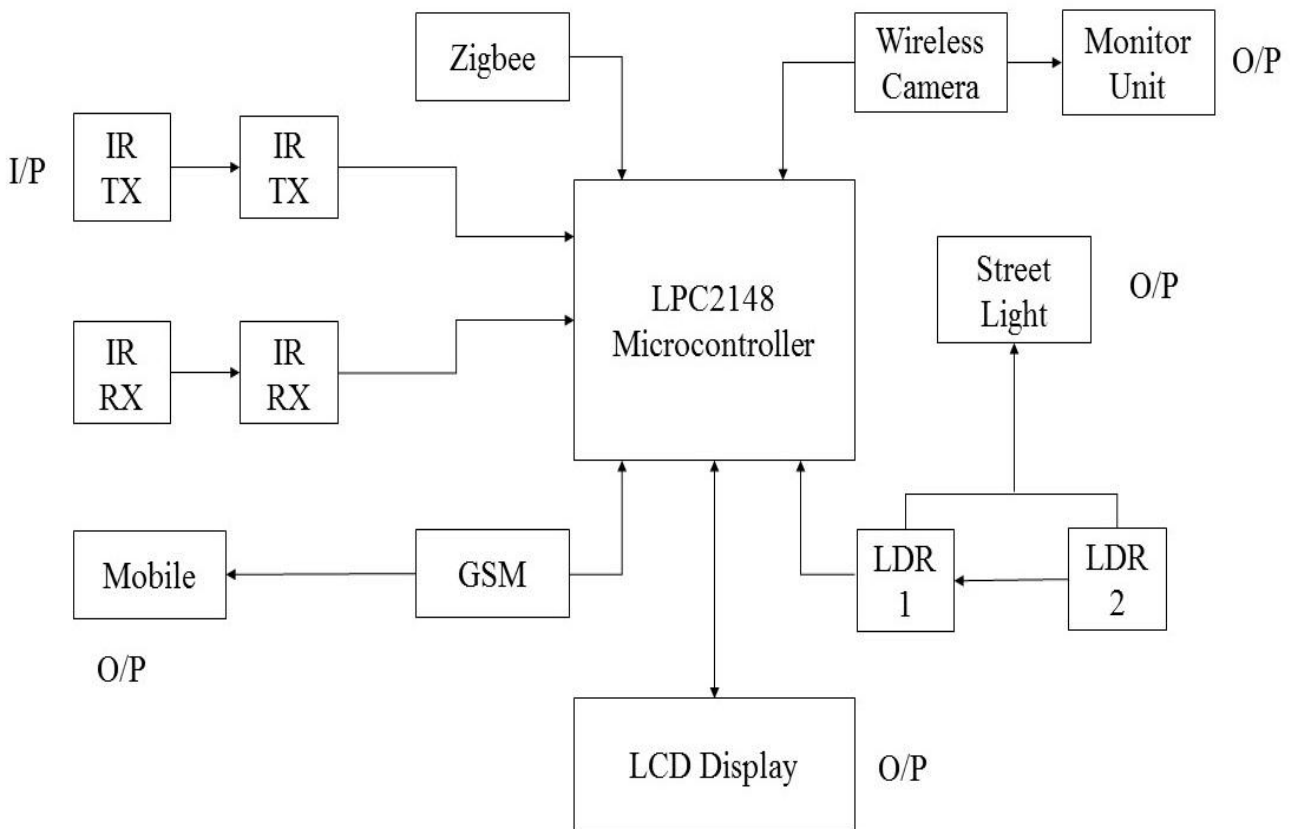


Fig.1: Block diagram of proposed system

### 3.1 Zigbee:

ZigBee modules emphasize a UART interface, which permits microcontroller or chip to instantly utilize the administrations of the ZigBee convention. All a ZigBee fittings created need to do in this as is guaranteed that the host's serial port rationale levels are good with the Xebec's

2.8- to 3.4-V rationale levels. The rationale level change might be performed utilizing either a standard RS-232 IC or

rational level interpreters, for example, when the host is straightforwardly associated with the UART. The beneath table gives the pin portrayal of the transceiver.

ZigBee modules emphasize a UART interface, which permits any microcontroller or chip to instantly utilize the administrations of the ZigBee convention. All a ZigBee fittings creator need to do in this as is guaranteed that the host's serial port rationale levels are good with the Xebec's 2.8- to 3.4-V rationale levels. The rationale level change might

be performed utilizing either a standard RS-232 IC or rationale level interpreters, for example, when the host is straightforwardly associated with the ZigBee UART. The beneath table gives the pin portrayal of the transceiver.

Specification of system: VCC, GND, DOUT & DIN

- Signal Direction is determined regarding the component.
- The element incorporates force awake device appended to reorganize.
- Then a few of the information force might arrange utilizing the summons.
- New pinches ought to think.

Information is displayed in the X-Bee module through it DIN pin, and it must be in the offbeat serial configuration, which comprises of a begin bit, 8 information bits, and a stop bit. Since the info information goes straightforwardly into the data of a UART inside the X-Bee module, no bit reversals are

Essential inside the offbeat serial information stream. The majority of the obliged timing and equality checking is naturally dealt with by the X-Bee's UART. Just on the off chance that you are delivering information speedier than the X-Bee can handle and transmit it, both X-Bee modules, fuse an agreeable to-send (CTS) capacity to throttle the information being exhibited to the X-Bee module's DIN pin.

### 3.2 Light Dependent Resistor:

The LDR exceptionally valuable, particularly in light/dim antenna. Ordinarily safety, some, of the time, however, light up, the safety drastically. Along these lines in this venture, LDR assumes an imperative part in exchanging on the lights focused around the force of light, i.e., if the power of light is all the more (amid daytime) the lights will be in off condition. Furthermore, if the force of light is less (amid nights), the lights will be exchanged on.

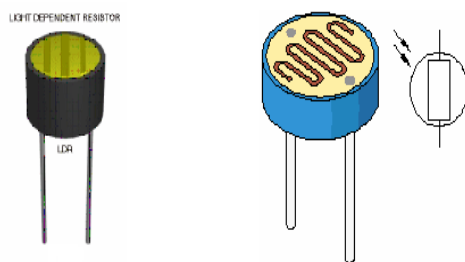


Fig2: Light Dependent Resistor

### 3.3 Ir Sensor:

Here the IR source is just the ultraviolet lighting. He basically takes after a common LED yet conducts this infra-red indicator. Letters infra-red pillars remain available clear degree we can't watch the bars after bringer. These are electromagnetic headed; yield discernible in the senses. Could stay used as exchange headed on behalf of imperceptible shaft, etc.

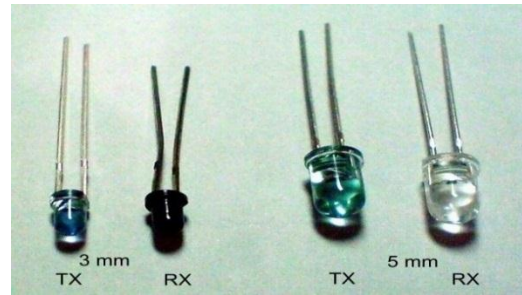


Fig3: IR sensor

### 3.4 GSM:

Here the IR transmitter is just the lighting. It basically takes after a common, yet transmits the IR signals. Since the IR pillars are out of the clear degree we can't watch the bars from the transmitter. These are infra-red headed; the light yield is not discernible in our eyes. They could be used as exchange headed for remote controls, night vision for camcorders, imperceptible shaft sensors, etc. Profiting from economies of scale. This is a situated of principles determining the base for a computerized cell administration. The provisions worldwide title, interpretation tables that are utilized to focus the connected with the point when stand out exists, the interpretation tables are inconsequential. At the point when more than one is utilized on the other hand, the interpretations get to be greatly difficult, with one interpretation record for every endorser. Consuming decided the suitable location, the sends a routing information request to it.

## 4. WIRELESS CAMERA



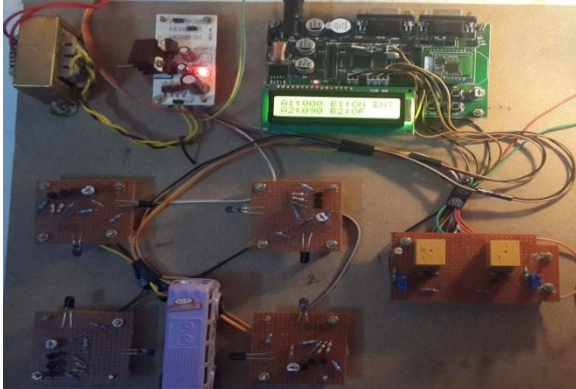
Fig4: Wireless Camera

A surveillance camera is a video camera that is used to remotely monitor on an area or building by transmitting recorded images to a central control room. The area is observed using Surveillance cameras/ video cameras. Generally the output of surveillance camera/video camera is monitored by human such as security guard or law enforcement officer as it is connected to IP network or recorded device. This human monitoring leads to several limitations. The proposed system overcomes those limitations to some extends.

Wireless camera working (small mini wireless camera is connecting for transceiver and joint red, yellow cables and power supply cable connecting. The camera for connecting the personal computer for one chip for the driver is there and audio, video receiver and connects the antenna beside the tune is there and next side connect the power supply and two cable pin, audio, video. The run the software and audio, video, image vehicle entry and exit capturing the image.

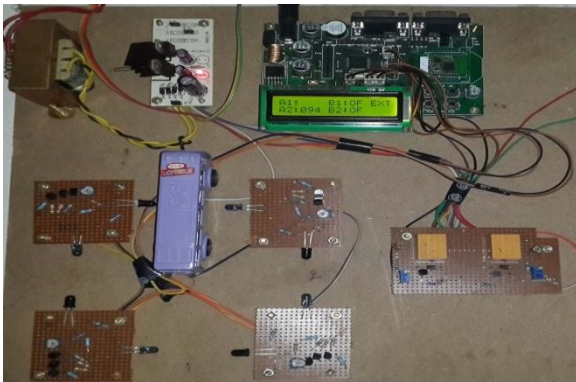
## 5. RESULT & DISCUSSIONS:

The proto type of the Intelligent System is shown below which contains two sections through which the proportionate values of the efficient power supply is done and the surveillance of the area is done using the wireless camera and the images captured are transferred to the PC. Message to the remote location using the GSM technology and the respective prototype images are shown below,

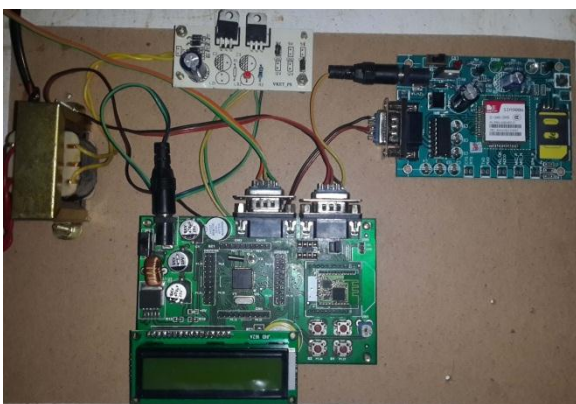


**Fig 5: Proto type of the Enabled Street Light Section**

Fig.5 and Fig.6 show prototype of street section, this section has two areas one for entry and other for the exit. When the vehicle enters the lights automatically gets ON. And the intelligent system automatically switches OFF the light after the passing of the vehicle. The snap shot is Fig.7,

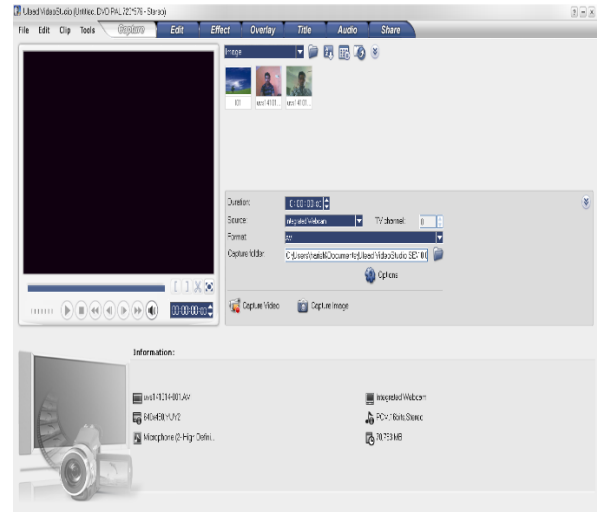


**Fig 6: Prototype of the Disabled Street Light section.**



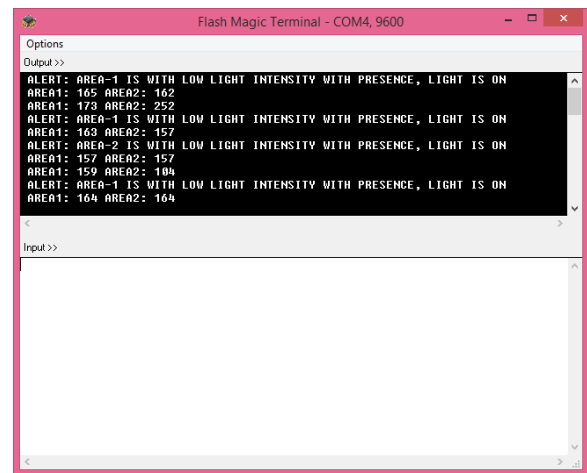
**Fig 7: GSM**

Is the monitoring section, where the GSM technology is used to transfer the area information using SIM slot, when there is vehicle entry the message is sent and Vice Versa.



**Fig 8: Surveillance Display Screen shot**

The Wireless Camera WS-309AS is used for surveillance of the area. This camera automatically activated when the vehicle is identified in the respective secured area and it captures the image and then transmits the same to the remote monitoring unit. This surveillance is needed in high security zones. In the earlier street light systems, there they have not concentrated on the surveillance [1-5] and the present idea increases the efficiency, through put with same supply it also provides security to the respective area, through the proposed surveillance system.



**Fig9: Flash magic terminal with GSM output of TX.**

Fig.9 show the flash magic terminal which provides the information status of the message regarding the activity of the remote user and is transmitted using the GSM module.

## 6. CONCLUSION:

The proposed intelligent system based on ARM7, is designed with two sections which automatically controls the process and provides the respective information about the intruder/vehicle being passed through the sensors and this also controls the power supply of the street light, surveillance camera and provide the efficiency of power management. The surveillance system provides the images being captured through the camera and they are also being transferred to PC. Switching information of street light is also send using GSM to the remote location. This novel intelligent system provide enhance security and efficient management of power in comparison with the existing systems [1-5].

## 7. REFERENCE

- [1] Instituto para la Diversificación y Ahorro de la Energía (IDAE) [(accessed on 14 May 2013)]. Available online: <http://www.idae.es/index.php/id.644/reImenu.355/lang.uk/mod.pags/mem.detalle>.
- [2] Lighting of Streets and Buildings in Cities. [(Accessed on 13 May 2013)]. Available online: <http://energythic.com/view.php?node=406>.
- [3] R. Caponetto, G. Dongola, L. Fortuna, N. Riscica, and D. Zufacchi, "Power consumption reduction in a remote controlled street lighting system," in *Proc. Int. Symp. Power Electron., Elect. Drives, Autom. Motion*, Jun. 11–13, 2008, pp. 428–433.
- [4] Cho, S. and Dhingra, V. (2008), "Street lighting control based on Lon Works power line Communication", IEEE International Symposium on Power Line Communications and Its Applications (ISPLC 2008), Jeju City, 2-4 April, pp. 396-8.
- [5] Chaitanya Amin, AshutoshNerkar, Paridhi Holani, Rahul Kaul, "GSM Based Autonomous Street illumination System for Efficient Power Management"(Int.Journal of Engg.Trends and Tech- Vol 4 Issue1- Aug-2013).
- [6] D.Liu, S.Qi, T. Liu, S.-Z. Yu, and F. Sun, "The design and realization of communication technology for street lamps control system," in *Proc.4th Int. Conf. Computer.Sci. Educ.*, Jul. 25–28, 2009, pp. 259–262.
- [7] Y. Wei, "Design of the new bright lane low organize system," in *Proc. 8th IEEE Int. Conf. Manage.*
- [8] R. Capone to, "control utilization drop in isolated striated road light organism," in *Proc. Int. Sump.ControlElectron.Elect.Drive,Austin*.<http://www.qualetariffa.it>.
- [9] Manuel Arias, Diego G. Lamar, Javier Sebastian, Didier Balocco, and Almadidi Aguisa Diallo, "High-Efficiency LED Driver Without Electrolytic Capacitor for Street Lighting"IEEE Tran. on ind. appli. vol. 49, no. 1, JAN/FEB 2013.

## 8. AUTHOR'S PROFILES

**First Author –Dr. J.L. MAZHER IQBAL**, Ph.D., Professor in the Department of Electronics and Communication Engineering, MITS Engineering College. Areas of interests are VLSI, Digital and embedded systems.

Email address: mazheriq@gmail.com

Contact: 91- 9966904552.

**Second Author-Mr. T.HAREESH** received his Master of Technology in Electronics and Communication Engineering in MITS Engineering College, Madanapalle, A.P., and India in 2014. He attended 03 workshops and also 01 conference. His area of interest Embedded systems, Image processing, signal processing. This work uses ARM 7 and GSM Intelligent system.

Email address: thummaluruhareesh@gmail.com

Contact: 91- 9000080321.