

Bacteriophage control of Shiga toxin 1 production and release by *Escherichia coli*

Patrick L. Wagner,^{1,2§} Jonathan Livny,^{3§}
Melody N. Neely,^{4†} David W. K. Acheson,^{2‡}
David I. Friedman⁴ and Matthew K. Waldor^{1,2*}

¹Howard Hughes Medical Institute, USA.

²Division of Geographic Medicine and Infectious Diseases, New England Medical Center and Tufts University School of Medicine, 750 Washington Street, Boston, MA 02111, USA.

³Program in Cellular and Molecular Biology, and

⁴Department of Microbiology and Immunology, The University of Michigan Medical School, Ann Arbor, MI 48109-0619, USA.

Summary

The *stx* genes of many Shiga toxin-encoding *Escherichia coli* (STEC) strains are encoded by prophages of the λ bacteriophage family. In the genome of the Stx1-encoding phage H-19B, the *stx*₁*AB* genes are found \approx 1 kb downstream of the late phage promoter, p_R' , but are known to be regulated by the associated iron-regulated promoter, p_{Stx1} . Growth of H-19B lysogens in low iron concentrations or in conditions that induce the prophage results in increased Stx1 production. Although the mechanism by which low iron concentration induces Stx1 production is well understood, the mechanisms by which phage induction enhances toxin production have not been extensively characterized. The studies reported here identify the factors that contribute to Stx1 production after induction of the H-19B prophage. We found that replication of the phage genome, with the associated increase in *stx*₁*AB* copy number, is the most quantitatively important mechanism by which H-19B induction increases Stx1 production. Three promoters are shown to be involved in *stx*₁*AB* transcription after phage induction, the iron-regulated p_{Stx1} and the phage-regulated p_R and p_R' promoters, the relative importance of which varies with environmental conditions. Late phage transcription initiating

at the p_R' promoter, contrary to previous findings in the related Stx2-encoding phage ϕ 361, was found to be unnecessary for high-level Stx1 production after phage induction. Finally, we present evidence that phage-mediated lysis regulates the quantity of Stx1 produced by determining the duration of Stx1 accumulation and provides a mechanism for Stx1 release. By amplifying *stx*₁*AB* copy number, regulating *stx*₁*AB* transcription and allowing for Stx1 release, the biology of the Stx-encoding phages contributes greatly to the production of Stx, the principal virulence factor of STEC.

Introduction

Shiga toxin-producing *Escherichia coli* (STEC) are pathogens responsible for outbreaks and sporadic cases of diarrhoea (Head *et al.*, 1988; Al-Jumaili *et al.*, 1992; Muhldorfer *et al.*, 1996). STEC are distinguished from other types of diarrhoeagenic *E. coli* by their production of Shiga toxins, which account for the severe clinical manifestations of STEC infection, including haemorrhagic colitis and the haemolytic uraemic syndrome (Griffin, 1995). Two principal types of Stx, Stx1 and Stx2, have been described, each of which is composed of eukaryotic glycolipid-binding B subunits and an enzymatic A subunit that inhibits protein synthesis by cleaving ribosomal RNA (Acheson and Keusch, 1996). In nearly all cases examined, the *stx* genes in STEC are closely associated with bacteriophage sequences (Newland and Neill, 1988; Datz *et al.*, 1996; Unkmeir and Schmidt, 2000) and, in many cases, the *stx* genes reside within functional prophages of the λ family (Karch *et al.*, 1999; Mizutani *et al.*, 1999).

H-19B is an Stx1-encoding bacteriophage isolated from the O26:H11 STEC strain H19, obtained in 1967 from an infant with diarrhoea (Smith and Linggood, 1971). After the cloning of the *stx*₁ genes from purified H-19B DNA (Huang *et al.*, 1986), several groups identified a functional promoter, p_{Stx1} , directly upstream from the *stx*₁ coding sequence (Calderwood *et al.*, 1987; De Grandis *et al.*, 1987; Jackson *et al.*, 1987). The activity of this promoter is regulated by environmental iron concentration by a mechanism involving the iron-dependent Fur transcriptional repressor, which is thought to bind to a site near p_{Stx1} (Calderwood and Mekalanos, 1987; Calderwood *et al.*, 1987; De Grandis, 1987). H-19B is a

Accepted 20 February, 2002. *For correspondence. E-mail mwaldor@lifespan.org; Tel. (+1) 617 636 7618; Fax (+1) 617 636 5292. Present addresses: [†]Department of Immunology and Microbiology, Wayne State University, Detroit, MI 48201, USA. [‡]Department of Epidemiology and Preventive Medicine, University of Maryland, Baltimore, MD 21201, USA. [§]These authors contributed equally to this work.

λ -like phage, sharing with λ a similar genome organization and many genes and sites that are identical or functionally related (Fig. 1) (Huang *et al.*, 1986; 1987). Agents that induce the λ -like Stx-encoding prophages, such as mitomycin C, have been shown to increase toxin production by STEC strains (Head *et al.*, 1988; Acheson *et al.*, 1989; Hull *et al.*, 1991; 1993). Thus, Stx1 production by STEC strains can be induced in two ways: through low-iron induction of p_{Stx1} and through prophage induction.

Induction of λ -like prophages occurs when phage repressor levels fall below the minimal concentration necessary to block transcription initiating at the two promoters for early transcription, p_L and p_R . Induction occurs at a low level spontaneously or at a high level in the presence of agents such as mitomycin C that damage DNA and activate RecA, which in turn facilitates auto-cleavage of phage repressor (Roberts and Devoret, 1983; Little, 1995). Removal of repression allows for transcription initiation at p_L and p_R . p_L -initiated transcription results in expression of the *N* antiterminator gene, whereas p_R -initiated transcription results in expression of the replication genes, *O* and *P*, which is inefficient because of the terminator, t_{R1} , directly downstream of p_R (Friedman and Gottesman, 1983) (Fig. 1). Subsequently, transcription from p_R is modified by the *N* antiterminator, which acts with a group of host factors to modify RNA polymerase to a form that over-rides termination barriers (Das, 1992; Richardson and Greenblatt, 1996; Friedman and Court, 2001). *N*-modified transcription from p_R proceeds efficiently through *O* and *P* and into the region encoding a second antiterminator gene, *Q*, near the late phage promoter $p_{R'}$. Transcription from $p_{R'}$ is constitutive but, in the absence of *Q*, terminates at an immediately downstream terminator, $t_{R'}$ (Roberts *et al.*, 1998). *Q* modifies transcription from $p_{R'}$ such that it proceeds through $t_{R'}$, allowing efficient transcription of the late phage genes, which include lysis and morphogenesis genes.

The *stx* genes are located between $p_{R'}$ -like sequences and putative lysis genes in the Stx-encoding phages H-19B (Neely and Friedman, 1998a) and 933 W (Neely and Friedman, 1998b; Plunkett *et al.*, 1999). Thus, they could be expressed as late phage genes, dependent upon the *Q* antiterminator and the $p_{R'}$ promoter for efficient transcription. Consistent with this hypothesis, overexpression of the *Q* gene of H-19B resulted in marked induction of toxin expression and phage-mediated lysis in lysogens of H-19B and the Stx2-encoding phage 933W, which share a nearly identical *Q* gene sequence (Neely and Friedman, 1998b). Moreover, mutants lacking the Q - $p_{R'}$ sequence in an Stx2-encoding STEC isolate were found to be drastically impaired in Stx2 production *in vitro* and in a mouse intestinal model (Wagner *et al.*, 2001a), indicating the

critical importance of phage late transcription for Stx2 production. The importance of the Q - $p_{R'}$ sequence for Stx1 production has not been tested directly, and was uncertain given the presence of the adjacent, iron-regulated p_{Stx1} promoter.

Besides influencing production of Stx, phage induction could also lead to Stx release, via phage-mediated lysis, given the tight genetic linkage between the $p_{R'}$, *stx* and lysis gene sequences (Neely and Friedman, 1998a; Plunkett *et al.*, 1999). If transcription of *stx*₁ is initiated from $p_{R'}$, it would be coupled with transcription of the downstream phage lysis genes, whereas if it is initiated from p_{Stx1} , it would not. This is because *Q*-modified transcription from $p_{R'}$ would over-ride a terminator, t_{Stx1} , found between *stx*₁*AB* and the downstream lysis genes (De Grandis, 1987) and would consequently proceed into the lysis genes, whereas transcription initiating at p_{Stx1} would not be modified by an antiterminator and therefore would terminate at t_{Stx1} (Fig. 1). The contribution of phage-mediated lysis to Stx release has not been tested directly. We set out to determine whether phage-mediated lysis is important in Stx release and to determine what mechanisms account for increased Stx1 production and release by *E. coli* lysogens of the H-19B prophage.

Results

Induction of Stx1 production and release by low iron and mitomycin C

In this study, we used prophage induction with mitomycin C to assess the contribution of phage induction to toxin production, and the low-iron syncase broth to assess the contribution of the iron-regulated p_{Stx1} promoter to toxin production and release. These artificial conditions allowed us to distinguish these stimuli to facilitate the study of the mechanisms involved in their effects. In order to establish a baseline for comparison in our mutational analyses (see below), we confirmed the previously described effects of iron concentration and phage induction on Stx1 production. Low media iron concentration resulted in a fivefold increase in Stx1 production by a K-12 lysogen of H-19B, named MC1000(H-19B) (Wagner *et al.*, 1999) relative to growth in iron-rich conditions (Fig. 2), probably reflecting diminished Fur repressor activity at p_{Stx1} (Calderwood, 1987). We next assessed Stx1 production after H-19B prophage induction with mitomycin C, finding an \approx 70-fold increase in Stx1 production under these conditions. Because this was done in iron-replete media, this increase probably primarily reflects the contribution of phage gene products to Stx1 production, with little contribution from the iron-repressed p_{Stx1} promoter. We also assessed toxin production during growth in conditions in which both stimuli for toxin production were present.

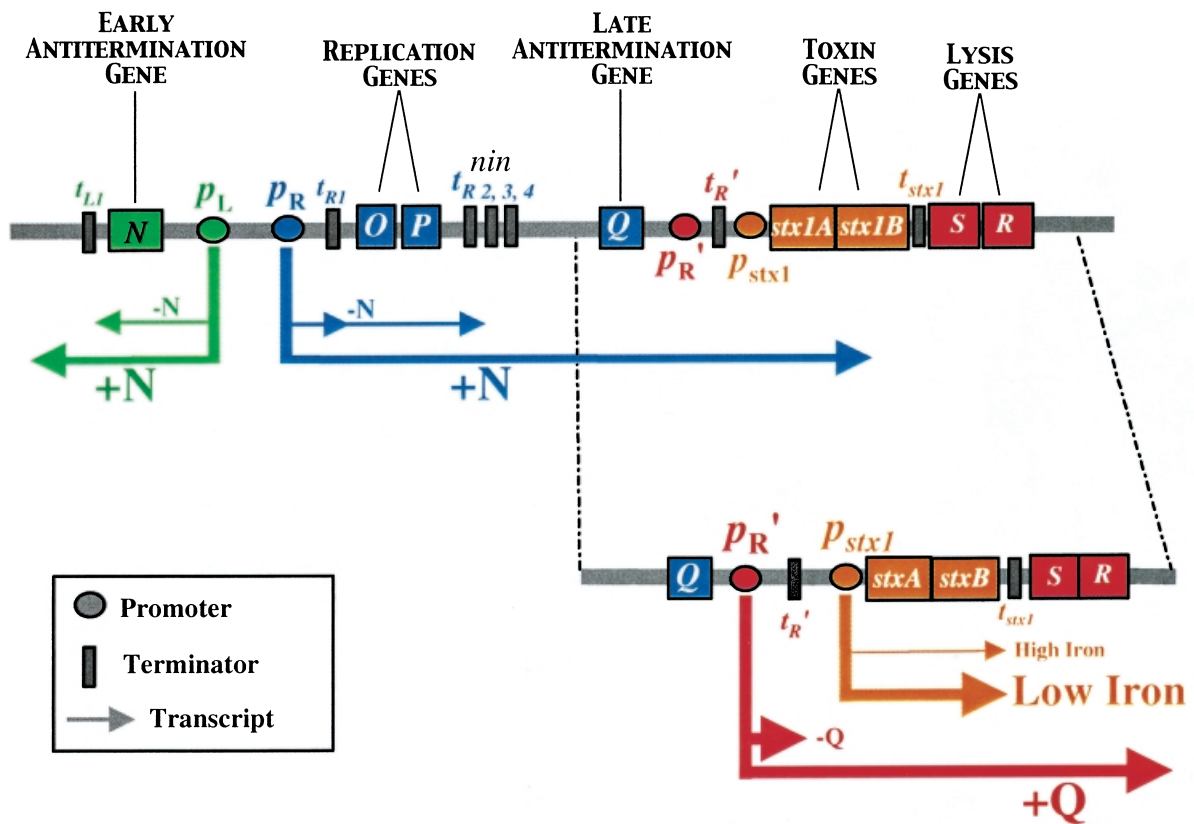

Fig. 1. Map and transcription patterns of the segment of the H-19B genome involved in *Stx1* regulation (Neely and Friedman, 1998a). Like phage λ , the H-19B prophage is repressed by the activity of phage repressor at the early control region, containing early promoters p_L and p_R . Induction results from a loss of repressor activity, allowing transcription to initiate at p_L and p_R . The N antiterminator, transcribed from p_L , acts to render transcription complexes initiating at p_L and p_R resistant to termination signals, allowing transcripts from p_R to efficiently readthrough t_{R1} , the O and P replication genes, the *nin* region terminators (t_{R2} , t_{R3} and t_{R4}), and subsequently transcribe the Q late antitermination gene.

Inset. Transcription of the *stx1* genes from p_{Stx1} or $p_{R'}$. Transcription initiating at p_{Stx1} is inducible in low-iron conditions and terminates at t_{Stx1} , located just downstream of *stxB* and upstream of the lysis genes. Transcription initiating at $p_{R'}$ is constitutive, but terminates immediately downstream at $t_{R'}$ in the absence of the late antiterminator Q. After phage induction, Q acts through $p_{R'}$ to render transcription complexes initiating at $p_{R'}$ unsusceptible to termination, and Q-modified transcription proceeds through $t_{R'}$, the toxin genes, t_{Stx1} and into the phage lysis genes. As N-modified transcription initiating at p_R is also resistant to termination signals, transcription from p_R can also proceed through $t_{R'}$ and into the toxin genes, allowing this promoter to contribute to toxin production after prophage induction.

Under these conditions, MC1000(H-19B) made ≈ 100 -fold more toxin than during growth in non-inducing conditions (Fig. 2). As it is unlikely that these optimized *in vitro*-inducing conditions resemble those encountered *in situ* by STEC, we cannot assess the relative importance of low iron concentration versus prophage induction as clinically relevant stimuli for *Stx* production.

Although both stimuli, low iron and mitomycin C, were known to induce toxin production, it was not known whether they lead to toxin release. We studied release of *Stx1* from the clinical isolate, H19, from which phage H-19B was isolated. We chose H19 as there could be mechanisms for *Stx1* release operative in the clinical isolate H19 but not operative in MC1000(H-19B). Cultures of H19 were grown under low-iron conditions or phage-

inducing conditions, and intracellular and extracellular *Stx1* concentrations were measured in these cultures at defined intervals. Both conditions strongly induced *Stx1* production (Fig. 3). However, we observed a dramatic difference in the localization of *Stx1* in these two cultures. Less than 1% of the *Stx1* was found in the supernatant of cultures grown in low-iron media, even after overnight growth (Fig. 3A; data not shown). In contrast, after 3 h growth in the presence of mitomycin C, there was an increase in the *Stx1* concentration in supernatants of H-19 cultures, and more than 99% of *Stx1* was extracellular after overnight growth (Fig. 3B; data not shown). Thus, although both low iron and mitomycin C induced *Stx1* production, substantial *Stx1* release into the supernatant occurred only under phage-inducing conditions.

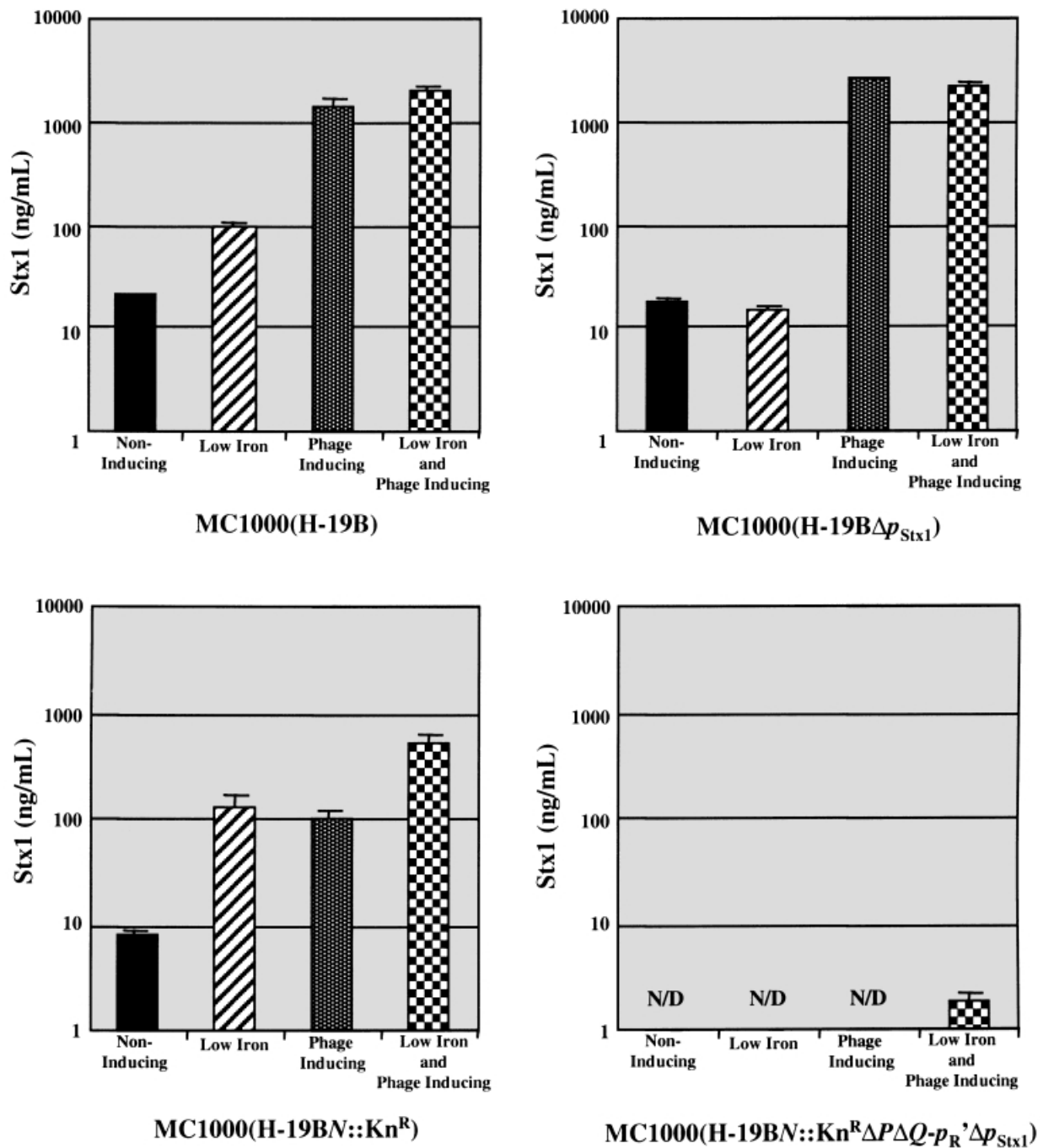

Fig. 2. Stx1 production under various growth conditions by MC1000(H-19B) and isogenic derivatives containing mutations in the H-19B prophage. Mean values derived from three independent cultures are shown along with the standard deviations. ND, not detected (<0.075 ng Stx1 ml⁻¹). Stx1 concentrations were measured after 3 h growth in the indicated media.

Contribution of the N antiterminator to Stx1 production

The N antiterminator, by facilitating efficient transcription from the early promoter p_R , plays an early role in the cascade of regulatory events that results in expression of all phage functions required for lytic growth (Fig. 1). Therefore, deletion of the N gene was predicted to result

in a defect in phage replication as well as to limit phage transcription, both from the early p_R promoter and from the late phage promoter p_R' , which ultimately relies on N-facilitated Q transcription. A deletion–substitution of N was introduced into the H-19B prophage to assess the importance of N in Stx1 production. The resulting lysogen, MC1000(H-19B $\Delta N::Kn^R$), made \approx 14-fold less Stx1 than

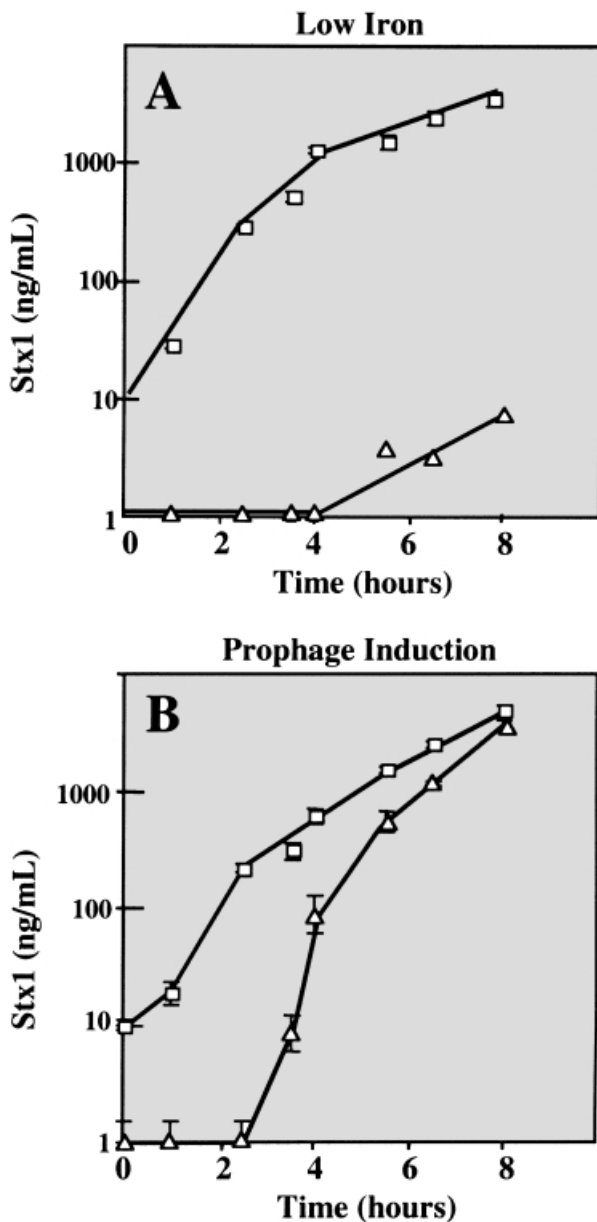

Fig. 3. Kinetics of *Stx1* production and release by clinical isolate H19. A. Total *Stx1* (squares) and supernatant *Stx1* (triangles) in cultures of H-19 grown in low-iron conditions (syncase broth). B. Total *Stx1* (squares) and supernatant *Stx1* (triangles) in cultures of H19 grown in phage-inducing conditions (syncase broth plus iron and mitomycin C).

wild type during growth in mitomycin C, indicating that *Stx1* production after phage induction is largely dependent upon the N antiterminator. The residual *Stx1* production by MC1000(H-19B Δ N::K n^R) after pro-phage induction probably reflects (i) the likelihood that some amount of transcription initiating at p_R proceeds through the downstream $tR1$ terminator even in the absence of N (Court *et al.*, 1980), resulting in some

prophage replication (Signer, 1969); (ii) the presence of a functional p_{Stx1} allowing phage induction-independent toxin production; and (iii) the fact that MC1000(H-19B Δ N::K n^R) is defective in lysis and therefore survives to accumulate toxin under conditions in which wild-type cells would lyse (see below).

Contribution of H-19B replication to *Stx1* production

Because the *stx₁* genes are located within the phage genome, replication of the H-19B prophage will result in an increase in *stx₁* gene dosage. We assessed the effect of prophage induction on *stx₁A* copy number in strains H-19 and MC1000(H-19B) using Southern hybridization. We found markedly increased hybridization of an *stx₁A* probe to DNA prepared from cultures of H-19 and MC1000(H-19B) after growth in mitomycin C (Fig. 4). Confirming that this increase in *stx₁AB* copy number specifically reflects replication of the phage genome, we observed no increase in hybridization with a probe for the *prfC* gene, located elsewhere on the bacterial chromosome (Fig. 4). As expected, induction of p_{Stx1} activity by growth in low-iron media did not affect *stx₁A* copy number in H-19 (Fig. 4) or MC1000(H-19B) (data not shown).

To assess the role of phage replication in *Stx* production, we constructed an H-19B prophage derivative defective for replication by deleting the prophage *P* gene, which belongs to the H-19B replication cassette that is nearly identical to that of λ (Neely and Friedman, 1998a). As the *P* gene is necessary for λ replication (Furth and Wickner, 1983), we predicted that, in the absence of *P*, there should be a failure in H-19B replication and therefore no increase in *stx₁A* copy number after mitomycin C induction. Southern analysis proved this to be the case; there was no detectable amplification of the *stx₁A* gene in mitomycin C-treated cultures of MC1000(H-19B Δ P) (Fig. 4, lanes 5–8). In terms of *Stx1* production, induction of the mutant prophage H-19B Δ P with mitomycin C resulted in significantly less *Stx1* production relative to the wild-type H-19B prophage, \approx 13-fold less in low-iron media with mitomycin C (Fig. 5). Thus, the *P* gene product, necessary for *stx₁A* amplification after phage induction, contributes significantly to high-level, phage-related *Stx1* production. In contrast, eliminating phage replication had little effect on *Stx1* production under conditions in which the prophage is not induced or p_{Stx1} is induced by a low environmental iron concentration (data not shown).

stx₁ transcription: the p_{Stx1} promoter

To assess the importance of p_{Stx1} for *Stx1* production, we constructed and characterized a deletion mutant, designated MC1000(H-19B Δ p_{Stx1}), that lacks p_{Stx1} . A Northern blot was used to assess *stx₁* transcription in this mutant by comparing hybridization of an *stx₁A* probe with RNA

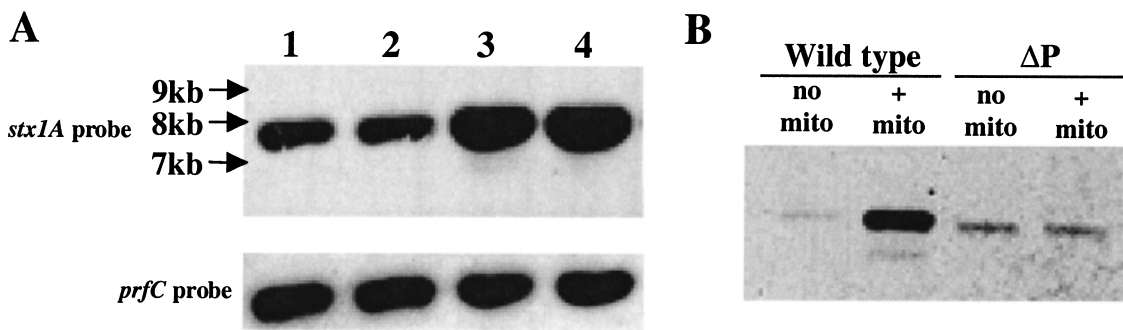

Fig. 4. A. Southern hybridization with probes *stx1A* (top) and *prfC* (bottom) to DNA purified from cultures: 1, clinical isolate H19 grown in syncase + iron; 2, H19 in syncase (low-iron); 3, H19 in syncase + iron + mitomycin C (phage-inducing); 4, H19 in syncase + mitomycin C (low-iron and phage-inducing). B. Southern hybridization with *stx1A* probe in cultures of MC1000(H-19B) or MC1000(H-19BΔ*P*) grown in the presence or absence of mitomycin C as indicated.

purified from cultures of MC1000(H-19B) and MC1000(H-19BΔ*p*_{Stx1}). As a prominent band, labelled B in Fig. 6, was present in RNA from MC1000(H-19B) (lane I) but not in RNA from MC1000(H-19BΔ*p*_{Stx1}) (lane III), band B probably represents transcription from *p*_{Stx1} that was eliminated by the Δ*p*_{Stx1} mutation. Another prominent band, labelled A in Fig. 3, was replaced by a shorter band, labelled A', in RNA from MC1000(H-19BΔ*p*_{Stx1}) (lane III). Band A probably represents transcription from an upstream promoter that is shortened to a smaller band, A', because of the

150 bp Δ*p*_{Stx1} deletion in strain MC1000(H-19BΔ*p*_{Stx1}) (lane III). Using an enzyme-linked immunosorbent assay (ELISA), we found that this mutation affected Stx1 production by MC1000(H-19BΔ*p*_{Stx1}), which was not enhanced during growth in low-iron media, but was increased during growth in phage-inducing conditions (Fig. 2). Taken together, these results indicate that the *p*_{Stx1} sequence is critical for induction of Stx1 production during growth in low iron, but that this promoter is not essential for phage-related induction of Stx1 production.

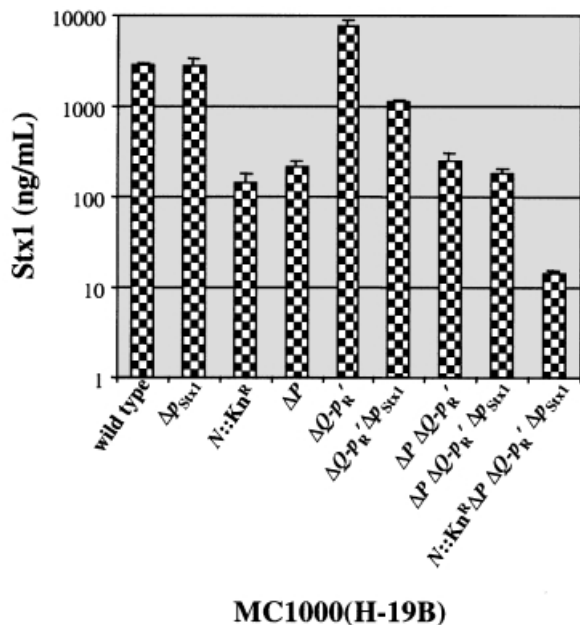

Fig. 5. Stx1 production by MC1000(H-19B) and isogenic derivatives containing the indicated mutations in the H-19B prophage during growth in syncase + mitomycin C (low-iron and phage-inducing) media. Mean values derived from three independent cultures are shown along with standard deviations. Stx1 concentrations were measured after 3 h growth.

stx1 transcription: the *p*_{R'} promoter

As the mutant lacking *p*_{Stx1} remained inducible by mitomycin C, we hypothesized that a phage-regulated promoter(s) located upstream of *p*_{Stx1} might also contribute to

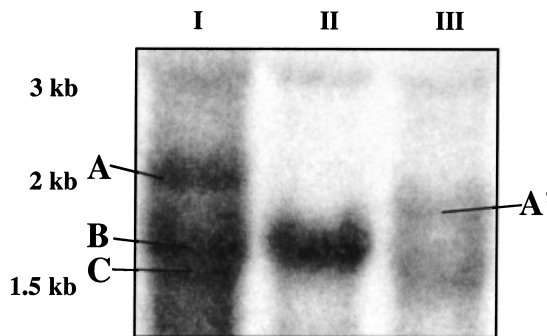

Fig. 6. Northern hybridization of *stx1A* probe to total RNA prepared from (I) MC1000(H-19B); (II) MC1000(H-19BΔ*Q-p*_{R'}); (III) MC1000(H-19BΔ*p*_{Stx1}). A, band present in wild-type (I) and in the Δ*p*_{Stx1} (III) lanes, but shorter in lane III (A') by the length of the deletion. B, band present in wild-type (I) and Δ*Q-p*_{R'} (II) lanes but not present in the Δ*p*_{Stx1} lane (III). C, band present in the wild-type (I) and Δ*p*_{Stx1} (III) lanes, but not in the Δ*Q-p*_{R'} lane (II).

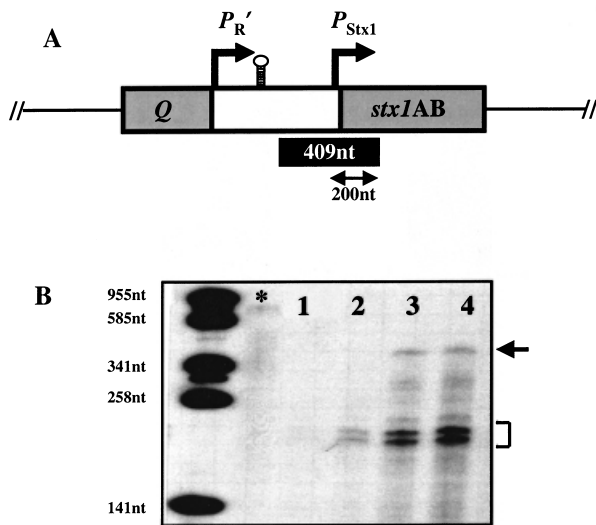

Fig. 7. Detection of *stx1* transcription initiating 5' of p_{Stx1} by ribonuclease protection assay.

A. Map (not to scale) of Q - $stx1AB$ region of phage H-19B showing promoters $p_{R'}$ and p_{Stx1} , the region used to construct the 409 nt probe (dark rectangle) and the region of 200 nt expected to be protected by messages initiating at p_{Stx1} .

B. Polyacrylamide gel of RPA products with RNA ladder and probe (*) unexposed to ribonuclease. RNA was prepared from MC1000(H-19) grown in: 1, syncase + iron; 2, syncase (low-iron); 3, syncase + iron + mitomycin C (phage-inducing); or 4, syncase + mitomycin C (low-iron and phage-inducing.) The arrow indicates a protected band consistent in size with a transcript initiating at $p_{R'}$, and the bracket indicates protected bands consistent in size with transcripts initiating near p_{Stx1} . Size markers are shown on the left.

stx1 expression. To assess directly whether such initiation sites for *stx1* transcription exist, we used a ribonuclease protection assay to detect *stx1A* transcripts initiating 5' of p_{Stx1} . The labelled RNA probe in this assay contained a 409 nucleotide (nt) region complementary to sequences surrounding p_{Stx1} , including 209 nt 5' to the previously mapped *stx1A* transcription initiation site (Fig. 7). Transcripts initiating at the p_{Stx1} promoter would be expected to protect a 200 nt segment of the labelled probe, whereas longer protected species, up to 409 nt, would be expected if upstream promoters are involved in *stx1AB* transcription. For these assays (Fig. 7), total RNA was prepared from cultures of H-19 grown under non-inducing conditions for the prophage or p_{Stx1} (lane 1), low-iron conditions (lane 2), phage-inducing conditions (lane 3) or low-iron and phage-inducing conditions (lane 4). An ≈ 200 nt doublet, consistent in length with a p_{Stx1} -initiated transcript, was observed in all lanes (Fig. 7, brackets). The presence of a doublet is consistent with a previous report that two transcription initiation sites exist for *stx1A* in the vicinity of p_{Stx1} (Kozlov *et al.*, 1988). These two bands were more intense in low-iron cultures, probably reflecting reduced Fur repressor activity. They were also more intense in mitomycin C-treated cultures,

presumably reflecting an increased *stx1* template copy number.

In mitomycin C-treated cultures, a larger protected species also became apparent (lanes 3 and 4, arrow). The presence of this mitomycin C-inducible band, consistent in size with the length of the homologous region in the probe (409 nt), indicates that an *stx1AB* transcriptional start site(s) located 5' of p_{Stx1} becomes active after phage induction. Based on the results of previous studies with H-19B (Neely and Friedman, 1998b), $\phi 361$ (Wagner *et al.*, 2001a) and other lambdoid phages (Roberts *et al.*, 1998), we predicted that $p_{R'}$ would be the primary phage promoter involved in *stx* expression. To assess the role of $p_{R'}$ in *Stx1* synthesis, we constructed a derivative of an H-19B prophage lacking $p_{R'}$ and a portion of the Q gene, a mutation identical to the ΔQ - $p_{R'}$ deletion we studied previously in $\phi 361$ (Wagner *et al.*, 2001a). Northern hybridization was used to assess *stx1* transcription in this mutant, which was found to lack bands detected in RNA prepared from the wild-type lysogen (Fig. 6). Specifically, the RNA from MC1000(H-19B ΔQ - $p_{R'}$) (lane II) lacked the bands designated A and C, which are present in RNA derived from wild-type cultures (lane I). Band C probably represents a processing product of the $p_{R'}$ -initiated transcript (Daniels *et al.*, 1988). Moreover, the bands absent in MC1000(H-19B ΔQ - $p_{R'}$) were different from those bands eliminated in the MC1000(H-19B Δp_{Stx1}) mutant (lane III), suggesting that these two mutations interfere with different sites of transcription initiation.

Deletion of the Q - $p_{R'}$ sequence of the H-19B prophage, in marked contrast to our previous results with a similarly deleted $\phi 361$ prophage, did not result in reduced toxin production during growth in mitomycin C. In contrast, MC1000(H-19B ΔQ - $p_{R'}$), produced 1.5-fold as much *Stx1* relative to an isogenic lysogen with a wild-type H-19B prophage after 3 h growth in mitomycin C (data not shown). As expected, toxin production by MC1000(H-19B ΔQ - $p_{R'}$) was induced by growth in low-iron media (data not shown), confirming the activity of p_{Stx1} in this mutant. Thus, the $p_{R'}$ promoter is not essential for *stx1* transcription after phage induction.

The increased *Stx1* production by a mutant lacking Q - $p_{R'}$ could be explained by the role of Q and $p_{R'}$ in transcription of the phage lysis genes. By eliminating transcription of lysis genes and thus cell lysis, the ΔQ - $p_{R'}$ mutation could result in the induced lysogen accumulating *Stx1*-encoding phage genomes that could serve as templates for toxin transcription. Accumulation of *Stx* under these conditions would require the action of a promoter such as p_{Stx1} to initiate *stx1* transcription. Consistent with this explanation, the majority of *Stx1* produced by MC1000(H-19B ΔQ - $p_{R'}$) remained intracellular (data not shown). If delayed lysis accounts for the increase in *Stx1* production by MC1000(H-19B ΔQ - $p_{R'}$), an increase in the

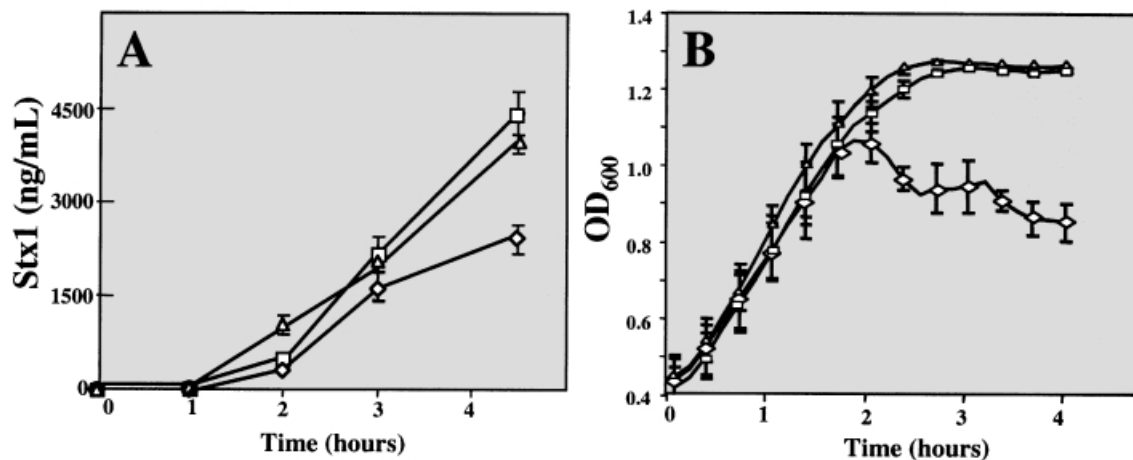

Fig. 8. Kinetics of Stx1 production (A) and culture turbidity (B) of MC1000(H-19B) (diamonds), MC1000(H-19BΔQ-p_R') (squares) and MC1000(H-19BΔS) (triangles) during growth in syncase + iron + mitomycin C.

duration but not in the rate of toxin production by this mutant might be expected. We confirmed this prediction by comparing Stx1 production by MC1000(H-19B) and MC1000(H-19BΔQ-p_R') during growth in phage-inducing conditions (Fig. 8A). These cultures produced comparable amounts of toxin until ≈ 3 h after induction (Fig. 8A), after which time only MC1000(H-19BΔQ-p_R') continued to accumulate Stx1. Optical density readings of these cultures showed that the strain containing the wild-type H-19B prophage began to lyse, whereas the strain with the H-19BΔQ-p_R' prophage did not. This failure in lysis was associated with prolonged accumulation of Stx1 to a level eightfold greater than wild type after overnight growth (not shown). Hence, Stx1 production by H-19B lysogens does not require the Q-p_R' sequence, and removal of this sequence allows for prolonged Stx1 accumulation.

stx₁ transcription: the p_R promoter

As neither the Δp_{S_{Stx1}} mutation nor the ΔQ-p_R' mutation prevented Stx1 production after phage induction, we hypothesized that each promoter could initiate *stx₁* transcription and could therefore compensate for the other's absence in the single deletion mutants described above. We therefore produced a double mutant lacking both promoters, yielding a strain designated MC1000(H-19BΔQ-p_R'Δp_{S_{Stx1}}). Under phage-inducing conditions, strain MC1000(H-19BΔQ-p_R'Δp_{S_{Stx1}}) made significantly less Stx1 than wild type (Fig. 5). As neither single promoter deletion mutant was impaired for Stx1 production but the double mutant was impaired, these data provide evidence for the activity of both promoters, p_{S_{Stx1}} and p_R', in toxin production after phage induction.

Despite the absence of two promoters presumed to be involved in toxin transcription, MC1000(H-19BΔQ-p_R'Δp_{S_{Stx1}}) produced a substantial amount of toxin during

growth in low-iron, phage-inducing conditions. Based on the λ paradigm (Court *et al.*, 1980), we hypothesized that mitomycin C-inducible, N-modified transcription from the early phage promoter p_R (located 5' of and in the same orientation as *stx₁*) could contribute directly to *stx* transcription. To assess this possibility, we constructed two additional mutants, a triple mutant, MC1000(H-19BΔPΔQ-p_R'Δp_{S_{Stx1}}), lacking the p_R' and p_{S_{Stx1}} promoters and the P replication gene, and a quadruple mutant lysogen, MC1000(H-19BΔN::Kⁿ^RΔPΔQ-p_R'Δp_{S_{Stx1}}) that additionally has a deletion–substitution of the N gene. As the N antiterminator is required for efficient p_R-initiated transcription, any contribution of p_R to *stx₁AB* transcription should be intact in the triple mutant but diminished in the quadruple mutant. In fact, the quadruple mutant made ≈ 10-fold less Stx1 than the triple mutant during growth in mitomycin C and >200-fold less Stx1 than wild-type MC1000(H-19B) (Fig. 5). The results of this comparison show that, when transcription from p_R' and p_{S_{Stx1}} is eliminated, essentially all the remaining production of Stx results from N-modified transcription, which most probably initiates at p_R.

If this interpretation is correct, it should be possible to detect N-dependent *stx₁AB* transcripts encoding sequences upstream of p_R'. We used reverse transcriptase–polymerase chain reaction (RT–PCR) to detect such transcripts (Fig. 9). cDNA was synthesized from cultures of MC1000(H-19B) grown in low-iron, phage-inducing conditions using an antisense *stx₁A* primer. Subsequent PCR with primers designed to anneal within the Q gene (5' relative to p_R') and the *stx₁A* gene yielded a band consistent with the expected size of 989 bp (not shown), indicating that some fraction of *stx₁A* transcripts in wild-type strains contains sequences upstream of p_R'. These *stx₁A* transcripts were found to depend on the N antiterminator in experiments comparing RT–PCR products obtained from lysogens of the triple and quadruple mutant H-19B

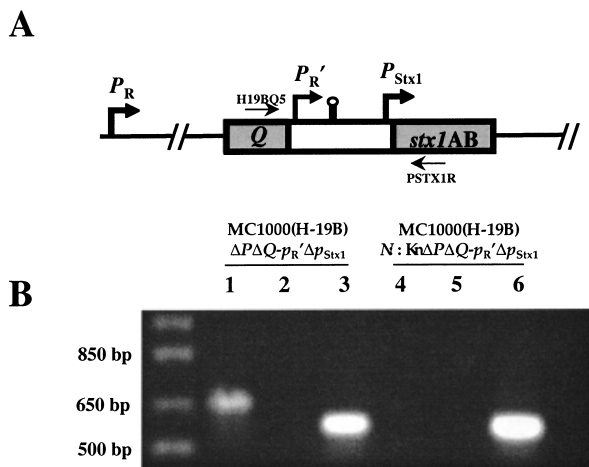

Fig. 9. *N*-dependent *stx₁A* transcription initiating 5' of $p_{R'}$ detected using reverse transcriptase (RT)–polymerase chain reaction.

A. Map of H-19B (not to scale) showing p_R , $p_{R'}$ and p_{Stx1} , as well as the *stx₁A* antisense primer (PSTX1R) used for cDNA synthesis and the *Q* primer (H19BQ5) used with the *stx₁A* primer for PCR.

B. Agarose gel of PCR products with *Q* and *stx₁A* primers using, as template cDNA derived from MC1000(H-19B $\Delta P_{\Delta Q} \Delta p_{R'} \Delta p_{Stx1}$) RNA (lanes 1–3) or MC1000(H-19B $\Delta N::K_n \Delta P_{\Delta Q} \Delta p_{R'} \Delta p_{Stx1}$) RNA (lanes 4–6). Lanes 2 and 5 are negative controls to which no RT was added. Lanes 3 and 6 are *rpoB* control RT–PCRs using cDNA derived from MC1000(H-19B $\Delta N::K_n \Delta P_{\Delta Q} \Delta p_{R'} \Delta p_{Stx1}$) and MC1000(H-19B $\Delta N::K_n \Delta P_{\Delta Q} \Delta p_{R'} \Delta p_{Stx1}$) respectively.

prophages. This comparison revealed a prominent band for the triple mutant, MC1000(H-19B $\Delta P_{\Delta Q} \Delta p_{R'} \Delta p_{Stx1}$) and only a very weak band for the quadruple mutant MC1000(H-19B $\Delta N::K_n \Delta P_{\Delta Q} \Delta p_{R'} \Delta p_{Stx1}$) (Fig. 9, lane 1 versus lane 4). This contrasts with the comparable levels of PCR product obtained from control reactions amplifying the *rpoB* housekeeping gene (Fig. 9, lane 3 versus lane 6), and indicates that *stx₁* transcription initiating 5' of $p_{R'}$ is heavily dependent on *N*.

Role of H-19B-mediated lysis in *Stx1* production and release

Deletion of the late phage transcriptional control element, Q - $p_{R'}$, enhanced *Stx1* production (see above), most probably as a result of defects in phage-mediated lysis, which requires *Q*-modified transcription initiating at the $p_{R'}$ promoter and extending through the *S* and *R* lysis genes. The timing of cell lysis by lambdoid phages is determined by the *S* gene product, which acts to permeabilize the bacterial cell inner membrane at a genetically programmed interval after induction. This allows the *R* endolysin gene product to enter the periplasm and degrade the cell wall. The *S* gene product also regulates the number of phage particles released, as phage titre depends upon the amount of time available for intracellular particle assembly before lysis (Young *et al.*, 2000). To assess the effect

of host cell lysis on toxin production, we constructed a lysogen carrying an H-19B prophage with an in frame deletion of the *S* gene, MC1000(H-19B ΔS). We compared the growth of this strain with the growth of wild-type MC1000(H-19B) after phage induction with mitomycin C (Fig. 8B). MC1000(H-19B ΔS) cultures continued to grow after wild-type cultures began to decrease in optical density, and we found that, although MC1000(H-19B ΔS) initially produced toxin at a rate comparable with that of the wild-type strain, MC1000(H-19B ΔS) continued to accumulate toxin at this rate longer than the wild-type strain (Fig. 8A). After overnight growth, the strain defective in phage-mediated lysis contained sixfold more toxin than the wild-type strain (data not shown). These results provide evidence that the timing of phage-mediated lysis, encoded by the *S* gene, is a determinant of the quantity of *Stx1* produced by lysogens of H-19B.

Discussion

Virulence genes are frequently encoded in mobile genetic elements, including bacteriophages, and are acquired by pathogenic bacteria via lateral transfer of these elements (Ochman *et al.*, 2000; Davis and Waldor, 2002). Expression of these acquired genes may be regulated by factors encoded within the mobile element itself, by factors encoded by the ancestral bacterial chromosome, or both. *Stx1* provides an example of a virulence factor whose production is regulated both by the life cycle of the encoding phage, H-19B, and by the iron-sensing Fur regulator encoded by the *E. coli* ancestral chromosome. That prophage induction may play a critical role in the pathogenesis of STEC is suggested by the observations that phage-inducing antibiotics have been associated with increased severity of STEC infection (Butler *et al.*, 1987; Carter *et al.*, 1987; Pavia *et al.*, 1990; Wong *et al.*, 2000), and that endogenous agents such as H₂O₂ and neutrophils are capable of inducing *Stx2* production in a manner dependent upon prophage induction (Wagner *et al.*, 2001b). Although the mechanism by which Fur regulates *Stx1* production has been well characterized, the mechanisms by which prophage induction regulates *Stx1* production are not and, in this study, we used lysogens containing mutant H-19B prophages to define the mechanisms by which prophage induction enhances *Stx1* production and release.

The *N* antiterminator, by facilitating readthrough of terminators downstream of the early promoter p_R , plays an essential early role in the expression of all phage functions required for lytic growth (Friedman, 1983). An *E. coli* lysogen of the H-19B prophage lacking the *N* gene was severely impaired in *Stx1* production, indicating that *N* plays a central role in phage-regulated *Stx1* production. The residual inducibility of toxin production by a strain

lacking N most probably reflects the fact that, even in the absence of N, there is some transcription of replication genes that should lead to an increase in *stx* copy number. Replication of the phage genome is a significant contributor to Stx1 production, as a deletion of the *P* gene diminished toxin production almost as much as disruption of *N*. Thus, by virtue of being phage encoded, the *stx* genes can be regulated by an increase in their copy number in response to specific environmental stimuli encountered by host bacteria. Whether regulated gene amplification contributes to the expression of other phage-encoded virulence factors remains to be explored; however, this mechanism may account for a similar phenomenon described for the genes encoding cholera toxin (*ctxAB*) (Mekalanos, 1983) before the realization that *ctxAB* are phage encoded.

Our experiments demonstrated that three promoters contribute to *stx₁AB* expression and that, under some conditions, these contributions are redundant. The contribution of p_{Stx1} , as well as a role for phage promoters upstream of p_{Stx1} , was suggested by toxin assays from mutant lysogens, RPAs, Northern analyses and RT-PCR assays. When lysogens were grown under low-iron, phage-inducing conditions, deletion of any single promoter did not impair toxin production, although a deletion mutant lacking both p_{R} and p_{Stx1} was greatly impaired under these conditions. The residual amount of toxin produced by this double mutant was essentially eliminated in strain MC1000(H-19BΔN::Kn^RΔPΔQ- p_{R} 'Δ p_{Stx1}), which, in addition to lacking p_{R} ' and p_{Stx1} , lacked effective p_{R} -initiated *stx₁* transcription on account of the *N* deletion. In summary, we were able to account for all *stx₁* transcription initiation through three promoters – p_{R} , p_{R} ' and p_{Stx1} – the relative importance of which varies with environmental conditions.

Our studies of Stx1 production and release by cultures of H19 are consistent with a requirement for phage-mediated lysis in Stx1 release. Growth in low-iron media, which stimulates toxin expression but not lysis, primarily resulted in the accumulation of intracellular, and not extracellular, Stx1, whereas growth in phage-inducing media resulted in toxin release into the supernatant. Furthermore, mutations that interfered with phage-mediated lysis resulted in a prolonged accumulation of Stx1 relative to wild type, indicating that the timing of lysis is one determinant of the quantity of Stx1 produced. This idea was suggested more than 40 years ago in studies on the regulation of the phage-encoded diphtheria toxin (DT) by Barksdale *et al.* (1960), who noted that a delay in lysis of *Corynebacterium diphtheriae* by the DT-encoding phage resulted in a concomitant increase in toxin production. Although our results strongly suggest that phage-mediated lysis and toxin release may represent the same event, at this point we cannot exclude the possibility that

unknown phage-independent mechanisms contribute to Stx1 release *in vivo*. For example, genes with homology to a type II secretion system are present on a plasmid found in many enterohaemorrhagic *E. coli* (EHEC) strains (Makino *et al.*, 1998), and it is possible that such a system contributes to the release of Stx. Another possibility is that destruction of bacterial cells by the human immune system leads to release of Stx in the absence of phage-mediated lysis.

The apparent redundancy of promoters able to direct *stx₁AB* transcription highlights interesting differences in the regulation of expression of phage-encoded toxins. Stx1, Stx2 and DT are all phage-encoded toxins produced at higher levels under phage-inducing conditions. Although Stx1 and DT production is influenced by iron concentration, no environmental condition other than phage induction is known to regulate Stx2 production (Muhldorfer *et al.*, 1996). A distinction may be drawn between Stx1 and DT in that phage induction of DT production only occurs in low-iron conditions (Barksdale *et al.*, 1960), whereas we have shown that phage induction of Stx1 production can occur in high-iron concentrations or in mutants lacking the iron-repressible p_{Stx1} promoter altogether. These differences can be explained based on prevailing notions of phage genome evolution, in which genetic modules are acquired as intact, self-regulated elements that eventually lose autonomy and become integrated into the regulatory scheme of the encoding phage (Campbell and Botstein, 1983; Hendrix *et al.*, 2000). Accordingly, the DT genes have remained an intact, iron-repressible operon, largely unaffected by phage transcriptional control elements, whereas the *stx₂AB* genes have been fully assimilated into the late regulatory scheme of φ361, being expressed solely during the late portion of that phage's life cycle. This would imply that the p_{Stx2} promoter (Sung *et al.*, 1990) of φ361 is a vestigial promoter-like sequence that was acquired with *stx₂AB* but no longer contributes significantly to *stx₂* expression. *stx₁AB* could represent an intermediate form between the DT and *stx₂AB* genes, retaining its iron-repressible promoter while at the same time being incorporated into the transcriptional control scheme of the phage.

Whether the assimilation of *stx* expression into the phage life cycle holds an advantage for these phages or their host strains remains unknown. On the other hand, p_{Stx1} -initiated *stx₁AB* transcription avoids obligate lysis and may represent a capacity for non-lethal Stx production by lysogens of H-19B, which seems to be lacking in lysogens of φ361. However, it remains unclear how Stx1 produced under these circumstances would be released from the cell in the absence of phage-mediated lysis. It is possible that the redundant transcriptional control over *stx₁AB* reflects adaptation to multiple stimuli in which both the

iron-related and the phage-related mechanisms serve to optimize *Stx1* production, perhaps at different times or in different environmental locations. We are limited by our lack of knowledge regarding the free iron concentration or the presence and identity of agents – endogenous (e.g. H_2O_2 , neutrophils) or exogenous (e.g. antibiotics) – responsible for phage induction in the intestine. However, our work defining the mechanisms of *Stx1* induction should help to identify intestinal parameters that contribute to toxin production and, thereby, to design reagents to prevent the severe consequences of STEC infection.

Experimental procedures

Bacterial strains and strain construction

H-19 is an O26 STEC isolate (Smith and Linggood, 1971) kindly provided by A. O'Brien. MC1000(H-19B) is a previously described *E. coli* K-12 lysogen with a single plaque-purified H-19B prophage (Wagner *et al.*, 1999). Strain MC1000(H-19B Δ P) is a derivative of MC1000(H-19B) produced using a λ Red-based recombination system (Datsenko and Wanner, 2000). Briefly, PCR primers PKOKN1 (5'-CCTGACAAACA CAGACTGGATTACGGGGTGGATCTGTGTAGGCTGGAG CTGCTTCG-3') and PKOKN2 (5'-GCGTCCCCAGGTAATG AATAATTGCCTCTTTGCCCGCATATGAATATCCTCCTTA-3'), containing 36 bp immediately upstream and downstream, respectively, of the *P* gene of H-19B were used to amplify the FRT (FLP recognition target)-flanked kanamycin resistance (Kn^R) gene found in plasmid pKD4. The resulting linear PCR product (designated *P*:: Kn^R) was electroporated into MC1000(H-19B) previously transformed with the λ Red-encoding plasmid pKD46. Recombinants containing Kn^R in place of the *P* locus were selected on *Kn* plates and confirmed by PCR. Deletion of the Kn^R element was accomplished by transformation with the FLP recombinase-encoding plasmid pCP20, resulting in kanamycin-sensitive MC1000(H-19B Δ P) mutants that were verified by PCR. Plasmids pKD46 and pCP20 (Datsenko and Wanner, 2000) are temperature sensitive and were cured by overnight growth at 42°C.

Strain MC1000(H-19B Δ Q- p_R') was derived from MC1000(H-19B) using the allele exchange vector, p Δ Q- p_R' , as described previously (Wagner *et al.*, 2001a). PCR with primers annealing outside the 900 bp region of homology in p Δ Q- p_R' was used to confirm that MC1000(H-19B Δ Q- p_R') contained the intended deletion. Strains MC1000(H-19B Δ p $_{Stx1}$) and MC1000(H-19B Δ Q- p_R' Δ p $_{Stx1}$) were derived from MC1000(H-19B) and MC1000(H-19B Δ Q- p_R'), respectively, using an allele exchange vector, pPW101. pPW101 is a derivative of pCVD442 (Donnenberg and Kaper, 1991) containing a 920 bp DNA fragment from the p_{Stx1} region of H-19B with a 154 bp deletion of non-coding DNA that includes p_{Stx1} and the associated Fur-binding operator. This deletion was constructed by ligating PCR products that flank the 154 bp region. pPW101 was introduced into MC1000(H-19B) and MC1000(H-19B Δ Q- p_R') by conjugation from *E. coli* SM10 λ pir, and deletion candidates were selected as Sm^R and Ap^R colonies and subsequently screened for resistance to

sucrose as described previously (Donnenberg and Kaper, 1991). The presence of the Δp_{Stx1} mutation in sucrose-resistant colonies was confirmed with PCR primers that anneal outside the 920 bp region used to construct pPW101.

MC1000(H-19B Δ N:: Kn^R) was constructed by replacing the *N* gene in H-19B with the Kn^R gene using the λ Red-based system described by Yu *et al.* (2000). Briefly, the Kn^R gene and its promoter were amplified by PCR with primers carrying 40 bp of homology to regions flanking the *N* gene. This PCR product was purified and electroporated into strain DY329 (from D. Court) carrying a wild-type H-19B prophage. Strain DY329 has a defective λ lysogen that expresses the lambda recombination functions at high temperature. N:: Kn^R recombinants were selected as Kn^R colonies, and the construction was verified by PCR. The recombinant prophage was transferred to MC1000 by P1 transduction. Transductants were selected as Kn^R colonies and verified by PCR.

Strains MC1000(H-19B Δ P Δ Q- p_R'), MC1000(H-19B Δ P Δ p $_{Stx1}$) and MC1000(H-19B Δ P Δ Q- p_R' Δ p $_{Stx1}$) were derived from strains MC1000(H-19B Δ Q- p_R'), MC1000(H-19B Δ p $_{Stx1}$) and MC1000(H-19B Δ Q- p_R' Δ p $_{Stx1}$) respectively. Each parent strain was transformed with plasmid pKD46 and subsequently with the PCR product *P*:: Kn^R , with selection and manipulation of recombinants as described above for the production of MC1000(H-19B Δ P). Strain MC1000(H-19B Δ N:: Kn^R Δ P Δ Q- p_R' Δ p $_{Stx1}$) was constructed by P1 transduction of Kn^R from MC1000(H-19B Δ N:: Kn^R) to MC1000(H-19B Δ P Δ Q- p_R' Δ p $_{Stx1}$). Kanamycin-resistant transductants were checked by PCR to confirm the presence of the desired mutations.

Strain MC1000(H-19B Δ S) was derived from MC1000(H-19B) using an allele exchange vector, pPW70. pPW70 is a derivative of pCVD442 containing an 828 bp DNA fragment from the *S* region of H-19B with a 150 bp deletion of the coding sequence of the putative H-19B *S* gene, constructed by ligating PCR products that flank the 150 bp region. pPW70 was introduced into MC1000(H-19B) by conjugation from *E. coli* SM10 λ pir, and deletion candidates were selected as described above. The presence of the ΔS mutation in sucrose-resistant colonies was confirmed with PCR primers that anneal outside the 828 bp region used to construct pPW70.

Growth media and *Stx1* measurement

Cultures were grown in syncase broth (Donohue-Rolfe *et al.*, 1984) supplemented with $FeCl_3$ (Sigma) to $10 \mu g ml^{-1}$, mitomycin C (Sigma) to $0.5 \mu g ml^{-1}$, both $FeCl_3$ and mitomycin C or neither. Fresh overnight cultures were washed several times with fresh media, then diluted to an OD₅₅₀ of 0.1 into 5 ml of the appropriate media before growth at 37°C on a shaker at 250 r.p.m. Determination of *Stx1* concentrations was carried out using a previously described *Stx1* ELISA (Donohue-Rolfe *et al.*, 1989). To liberate intracellular toxin, cultures were diluted into polymixin B (final concentration $2 mg ml^{-1}$). *Stx1* concentrations thus obtained were reported as the total *Stx1* concentration in the culture, i.e. incorporating both intracellular and extracellular *Stx1* fractions. In the experiments depicted in Fig. 3, supernatant toxin concentration was determined independently by removing bacterial cells via centrifugation.

Lysis experiments

Cultures were grown in syncase broth and, when required, supplemented with FeCl₃ and/or mitomycin C (Sigma). Overnight cultures grown in syncase broth ±FeCl₃ were diluted 1:40 in 2 ml of syncase broth ±FeCl₃, grown for 2.5 h at 37°C, then diluted 1:1 in 100 µl of syncase ±FeCl₃ ± mitomycin C in a 96-well plate. Then, the optical density at 420 nm was determined every 10 min in a SpectraMax 250 plate reader (Molecular Devices). Cultures were grown in duplicate, and experiments were repeated to give four sets of readings. These sets were averaged, and the standard error was determined as ±the standard deviation of each time point divided by 3. High- or low-iron conditions were maintained throughout the experiment including growth of the overnight culture.

Molecular biology techniques

For Southern blots, chromosomal DNA was prepared from cultures of H-19, MC1000(H-19B) or MC1000(H-19BΔP) grown in various conditions, using the Gnome DNA kit (BIO 101). DNA (1 µg) isolated from each culture was digested with *Clal* (NEB), then separated by electrophoresis in a 1% agarose gel. A 369 bp *stx₁A*-specific probe was constructed using PCR with primers DA22 (5'-AAATCGCCATTCG TTGACTACTTCT-3') and DA23 (5'-TGCCATTCTGGCAACT CGCGATGCA-3'), with chromosomal DNA of MC1000(H-19B) serving as the template. The probe was labelled and hybridization detected with the ECL system (Amersham) according to the manufacturer's protocol, using X-Omat Blue XB-1 film (Kodak). The 366 bp *prfC* control probe was prepared using PCR with primers kindly provided by Dr B. Hochhut (Hochhut and Waldor, 1999).

For ribonuclease protection assays, total RNA was prepared from cultures of H-19 grown for 3 h in various conditions with the RNeasy kit (Qiagen). To construct a riboprobe, PCR was initially used to amplify a 409 bp fragment that began 209 bp 5' of the previously mapped *stx₁A* transcription initiation site. Primers for this reaction were PSTX1F (5'-AGGATGACCTGTAAACGAAGTTTG-3') and PSTX1R (5'-CGTCTTTGCAGTCGAGAAGTCTAAG-3'), with MC1000(H-19B) chromosomal DNA serving as template. The 409 bp product was cloned into pCRII-TOPO (Invitrogen), yielding the plasmid pPW158. A single-stranded, antisense RNA probe was prepared by an *in vitro* transcription reaction using SP6 polymerase (Amersham) and ³²P-labelled UTP (Amersham), with linearized pPW158 serving as template. Labelled probe was purified on a 5% denaturing polyacrylamide gel, then added to 5 µg of each total RNA preparation and allowed to hybridize overnight at 42°C. Each sample, except for a single control reaction containing only labelled probe, was treated with RNase A/T1 (Amersham) and subsequently electrophoresed on a 5% denaturing polyacrylamide gel.

Northern blotting was performed using standard procedures (Ausubel *et al.*, 1999), with total RNA prepared as above. A ³²P-labelled *stx₁A* probe was synthesized using SP6 polymerase (Amersham), with plasmid pPW158 serving as template.

For RT-PCR, RNA was purified from mid-log cultures as

above and treated twice with RNase-free DNase I (Qiagen and Ambion). cDNA synthesis was carried out using heat-stable reverse transcriptase (Life Technologies) and either primer PSTX1R (Fig. 9) or a control primer complementary to the coding sequence of the *rpoB* gene of *E. coli*. For both *stx₁A* and *rpoB* RT-PCR assays, control reactions were carried out without reverse transcriptase. PCR was performed with primers H19BQ5 and PSTX1R (Fig. 9) or with *rpoB* primers.

Acknowledgements

We are grateful to Dr H. Kimsey and J. Beaber for invaluable technical advice, to Drs B. Davis, B. Hochhut, A. Kane, J. Ritchie and C. Thorpe for critical reading of this manuscript, and to Dr A. Kane and the NEMC GRASP Digestive Disease Center for preparing the microbiological media for our studies. This work was supported by grants from the National Institutes of Health (M.K.W. and D.I.F.), the Pew Foundation (M.K.W.), the Howard Hughes Medical Institute (M.K.W. and P.L.W.) and the NEMC GRASP Digestive Center (M.K.W. and D.W.K.A.). P.L.W. was a Howard Hughes Medical Institute Medical Student Research Training Fellow, and J.L. was supported in part by NIH training grants T32-GM07315 and T32-AI07528. M. N. Neely was supported in part by NIH training grant T32-GM08353.

References

- Acheson, D.W.K., and Keusch, G.T. (1996) Which Shiga-toxin producing types of *E. coli* are important? *Am Soc Microbiol News* **62**: 302–306.
- Acheson, D.W.K., Kane, A.V., Keusch, G.T., and Donohue-Rolfe, A. (1989) High yield purification and subunit characterization of Shiga-like toxin II. In *29th Interscience Conference on Antimicrobial Agents and Chemotherapy*, Abstract 901.
- Al-Jumaili, I., Burke, D.A., Scotland, S.M., Al-Mardini, H.M., and Record, C.O. (1992) A method of enhancing verocytotoxin production by *Escherichia coli*. *FEMS Microbiol Lett* **93**: 121–126.
- Ausubel, F.M., Brent, R., Kingston, R.E., Moore, D.D., Seidman, J.G., Smith, J.A., and Struhl, K. (1999) *Current Protocols in Molecular Biology*. New York: John Wiley & Sons.
- Barksdale, L., Garmise, L., and Horibata, K. (1960) Virulence, toxinogeny and lysogeny in *Corynebacterium diphtheriae*. *Ann NY Acad Sci* **88**: 1093–1098.
- Butler, T., Islam, M.R., Azad, M.A.K., and Jones, P.K. (1987) Risk factors for development of hemolytic uremic syndrome during shigellosis. *J Pediatrics* **110**: 894–897.
- Calderwood, S.B., and Mekalanos, J.J. (1987) Iron regulation of Shiga-like toxin expression in *Escherichia coli* is mediated by the *fur* locus. *J Bacteriol* **169**: 4759–4764.
- Calderwood, S.B., Auclair, F., Donohue-Rolfe, A., Keusch, G.T., and Mekalanos, J.J. (1987) Nucleotide sequence of the Shiga-like toxin genes of *Escherichia coli*. *Proc Natl Acad Sci USA* **84**: 4364–4368.
- Campbell, A., and Botstein, D. (1983) Evolution of lambdoid phages. In *Lambda II*. Hendrix, R.W., *et al.* (eds).

- Cold Spring Harbor, NY: Cold Spring Harbor Laboratory Press.
- Carter, A.O., Borczyk, A.A., Carlson, J.A.K., Harvey, B., Hochin, J.C., Karmali, M.A., *et al.* (1987) A severe outbreak of *Escherichia coli* O157:H7-associated hemorrhagic colitis in a nursing home. *N Engl J Med* **317**: 1496–1500.
- Court, D., Brady, C., Rosenberg, M., Wulff, D.L., Behr, M., Mahoney, M., and Izumi, S.U. (1980) Control of transcription termination: a rho-dependent termination site in bacteriophage lambda. *J Mol Biol* **138**: 231–254.
- Daniels, D.L., Subbarao, M.N., Blattner, F.R., and Lozeron, H.A. (1988) Q-mediated late gene transcription of bacteriophage lambda: RNA start point and RNase III processing sites *in vivo*. *Virology* **167**: 568–577.
- Das, A. (1992) How the phage lambda N gene product suppresses transcription termination: communication of RNA polymerase with regulatory proteins mediated by signals in nascent RNA. *J Bacteriol* **174**: 6711–6716.
- Datsenko, K.A., and Wanner, B.L. (2000) One-step inactivation of chromosomal genes in *Escherichia coli* using PCR products. *Proc Natl Acad Sci USA* **97**: 6640–6645.
- Datz, M., Janetzki-Mittman, C., Franke, S., Gunzer, F., Schmidt, H., and Karch, H. (1996) Analysis of the enterohemorrhagic *Escherichia coli* O157 DNA region containing lambda-doid phage gene p Shiga-like toxin structural genes. *Appl Environ Microbiol* **62**: 791–797.
- Davis, B.M., and Waldor, M.K. (2002) Mobile genetic elements and bacterial pathogenesis. In *Mobile DNA II*. Craig, N.L., *et al.* (eds). Washington, DC: American Society for Microbiology Press pp. 1040–1059.
- De Grandis, S., Ginsberg, J., Toone, M., Climie, S., Friesen, J., and Brunton, J. (1987) Nucleotide sequence and promoter mapping of the *Escherichia coli* Shiga-like toxin operon of bacteriophage H-19B. *J Bacteriol* **169**: 4313–4319.
- Donnenberg, M.S., and Kaper, J.B. (1991) Construction of an *eae* deletion mutant of enteropathogenic *Escherichia coli* by using a positive selection suicide vector. *Infect Immun* **59**: 4310–4317.
- Donohue-Rolfe, A., Keusch, G.T., Edson, C., Thorley-Lawson, D., and Jacewicz, M. (1984) Pathogenesis of *Shigella* diarrhea. IX. Simplified high yield purification of *Shigella* toxin and characterization of subunit composition and function by the use of subunit-specific monoclonal and polyclonal antibodies. *J Exp Med* **160**: 1767–1781.
- Donohue-Rolfe, A., Acheson, D.W.K., Kane, A.V., and Keusch, G.T. (1989) Purification of Shiga toxin and Shiga-like toxins I and II by receptor analog affinity chromatography with immobilized P1 glycoprotein and production of cross-reactive monoclonal antibodies. *Infect Immun* **57**: 3888–3893.
- Friedman, D.I., and Court, D.L. (2001) Bacteriophage lambda: alive and well and still doing its thing. *Curr Opin Microbiol* **4**: 201–207.
- Friedman, D.I., and Gottesman, M. (1983) Lytic mode of lambda development. In *Lambda II*. Hendrix, R.W., *et al.* (eds). Cold Spring Harbor, NY: Cold Spring Harbor Laboratory Press, pp. 21–51.
- Furth, M.E., and Wickner, S.H. (1983) Lambda DNA replication. In *Lambda II*. Hendrix, R.W., *et al.* (eds). Cold Spring Harbor, NY: Cold Spring Harbor Laboratory Press, pp. 145–173.
- Griffin, P.M. (1995) *Escherichia coli* O157:H7 and other enterohemorrhagic *Escherichia coli*. In *Infections of the Gastrointestinal Tract*. Blaser, M.J., Smith, P.D., Ravdin, J.I., Greenberg, H.B., and Guerrant, R.L. (eds). New York: Raven Press, pp. 739–762.
- Head, S.C., Petric, M., Richardson, S., Roscoe, M., and Karmali, M.A. (1988) Purification and characterization of verocytotoxin 2. *FEMS Microbiol Lett* **51**: 211–216.
- Hendrix, R.W., Lawrence, J.G., Hatfull, G.F., and Casjens, S. (2000) The origins and ongoing evolution of viruses. *Trends Microbiol* **8**: 504–508.
- Hochhut, B., and Waldor, M.K. (1999) Site-specific integration of the conjugal *Vibrio cholerae* SXT element into *prfC*. *Mol Microbiol* **32**: 99–110.
- Huang, A., de Grandis, S., Friesen, J., Karmali, M., Petric, M., Congi, R., and Brunton, J.L. (1986) Cloning and expression of the genes specifying Shiga-like toxin production in *Escherichia coli* H19. *J Bacteriol* **166**: 375–379.
- Huang, A., Friesen, J., and Brunton, J.L. (1987) Characterization of a bacteriophage that carries the genes for production of Shiga-like toxin 1 in *Escherichia coli*. *J Bacteriol* **169**: 4308–4312.
- Hull, A.E., Acheson, D.W.K., Donohue-Rolfe, A., Keusch, G.T., and Echeverria, P. (1991) Comparison of DNA probe and mitomycin C-enhanced immunoblot assay for the detection of Shiga-like toxin producing *E. coli* in stool specimens. In *Proceedings of the ASM 91st General Meeting*. Washington, DC: American Society for Microbiology Press, p. 390.
- Hull, A.E., Acheson, D.W.K., Echeverria, P., Donohue-Rolfe, A., and Keusch, G.T. (1993) Mitomycin immunoblot colony assay for detection of Shiga like toxin-producing *Escherichia coli* in fecal samples: comparison with DNA probes. *J Clin Microbiol* **31**: 1167–1172.
- Jackson, M.P., Newland, J.W., Holmes, R.K., and O'Brien, A.D. (1987) Nucleotide sequence analysis of the structural genes for Shiga-like toxin I encoded by bacteriophage 933J from *Escherichia coli*. *Microb Pathog* **2**: 147–153.
- Karch, H., Schmidt, H., Janetzki-Mittmann, C., Scheef, J., and Kroger, M. (1999) Shiga toxins even when different are encoded at identical positions in the genomes of related temperate bacteriophages. *Mol Gen Genet* **262**: 600–607.
- Kozlov, Y.V., Kabishev, A.A., Lukyanov, E.V., and Bayev, A.A. (1988) The primary structure of the operons coding for *Shigella dysenteriae* toxin and temperate phage H30 Shiga-like toxin. *Gene* **67**: 213–221.
- Little, J.W. (1995) The SOS regulatory system. In *Regulation of Gene Expression in Escherichia coli*. Lynn, E.C.C., and Lynch, A.S. (eds). Georgetown, TX: R.G. Landis, pp. 453–479.
- Makino, K., Ishii, K., Yasunaga, T., Hattori, M., Yokoyama, K., Yutsudo, C.H., *et al.* (1998) Complete nucleotide sequences of 93-kb and 3.3-kb plasmids of an enterohemorrhagic *Escherichia coli* O157: H7 derived from Sakai outbreak. *DNA Res* **5**: 1–9.
- Mekalanos, J.J. (1983) Duplication and amplification of toxin genes in *Vibrio cholerae*. *Cell* **35**: 253–263.
- Mizutani, S., Nakazono, N., and Sugino, Y. (1999) The so-

- called chromosomal verotoxin genes are actually carried by defective prophages. *DNA Res* **6**: 141–143.
- Muhldorfer, I., Hacker, J., Keusch, G.T., Acheson, D.W., Tschape, H., Kane, A.V., *et al.* (1996) Regulation of the Shiga-like toxin II operon in *Escherichia coli*. *Infect Immun* **64**: 495–502.
- Neely, M.N., and Friedman, D.I. (1998a) Arrangement and functional identification of genes in the regulatory region of lambdaoid phage H-19B, a carrier of a Shiga-like toxin. *Gene* **223**: 105–113.
- Neely, M.N., and Friedman, D.I. (1998b) Functional and genetic analysis of regulatory regions of coliphage H-19B: location of Shiga-like toxin and lysis genes suggest a role for phage functions in toxin release. *Mol Microbiol* **28**: 1255–1267.
- Newland, J.W., and Neill, R.J. (1988) DNA probes for Shiga-like toxins I and II and for toxin-converting bacteriophages. *J Clin Microbiol* **26**: 1292–1297.
- Ochman, H., Lawrence, J.G., and Groisman, E.A. (2000) Lateral gene transfer and the nature of bacterial innovation. *Nature* **405**: 299–304.
- Pavia, A.T., Nichols, C.R., Green, D.P., Tauxe, R.V., Mottice, S., Greene, K.D., *et al.* (1990) Hemolytic–uremic syndrome during an outbreak of *Escherichia coli* O157:H7 infections in institutions for mentally retarded persons: clinical and epidemiologic observations. *J Pediatrics* **116**: 544–551.
- Plunkett, G., III, Rose, D.J., Durfee, T.J., and Blattner, F.R. (1999) Sequence of Shiga toxin 2 phage 933W from *Escherichia coli* O157:H7: Shiga toxin as a phage late-gene product. *J Bacteriol* **181**: 1767–1778.
- Richardson, J.P., and Greenblatt, J. (1996) Control of RNA chain elongation and termination. In *Escherichia coli and Salmonella enterica*. Neidhardt, F.C., *et al.* (eds). Washington, DC: American Society for Microbiology Press, pp. 822–848.
- Roberts, J.W., and Devoret, R. (1983) Lysogenic induction. In *Lambda II*. Hendrix, R.W., *et al.* (eds). Cold Spring Harbor, NY: Cold Spring Harbor Laboratory Press, pp. 123–144.
- Roberts, J.W., Yarnell, W., Bartlett, E., Guo, J., Marr, M., Ko, D.C., *et al.* (1998) Antitermination by bacteriophage lambda Q protein. *Cold Spring Harbor Symp Quant Biol* **LXIII**: 319–325.
- Signer, E.R. (1969) Plasmid formation: a new mode of lysogeny by phage lambda. *Nature* **223**: 158–160.
- Smith, H.W., and Linggood, M.A. (1971) The transmissible nature of enterotoxin production in a human enteropathogenic strain of *Escherichia coli*. *J Med Microbiol* **4**: 301–305.
- Sung, L.M., Jackson, M.P., O'Brien, A.D., and Holmes, R.K. (1990) Transcription of the Shiga-like toxin type II and Shiga-like toxin type II variant operons of *Escherichia coli*. *J Bacteriol* **172**: 6386–6395.
- Unkmeir, A., and Schmidt, H. (2000) Structural analysis of phage-borne *stx* genes and their flanking sequences in Shiga toxin-producing *Escherichia coli* and *Shigella dysenteriae* type 1 strains. *Infect Immun* **68**: 4856–4864.
- Wagner, P.L., Acheson, D.W.K., and Waldor, M.K. (1999) Isogenic lysogens of diverse Shiga toxin 2-encoding bacteriophages produce markedly different amounts of Shiga toxin. *Infect Immun* **67**: 6710–6714.
- Wagner, P.L., Neely, M.N., Zhang, X., Acheson, D.W.K., Waldor, M.K., and Friedman, D.I. (2001a) Role for a phage promoter in Shiga toxin 2 expression from a pathogenic *Escherichia coli* strain. *J Bacteriol* **183**: 2081–2085.
- Wagner, P.L., Acheson, D.W.K., and Waldor, M.K. (2001b) Human neutrophils and their products induce Shiga toxin production by enterohemorrhagic *Escherichia coli*. *Infect Immun* **69**: 1934–1937.
- Wong, C.S., Jelacic, S., Habeeb, R.L., Watkins, S.L., and Tarr, P.I. (2000) The risk of the hemolytic–uremic syndrome after antibiotic treatment of *Escherichia coli* O157:H7 infections. *N Engl J Med* **342**: 1930–1936.
- Young, R., Wang, I.-N., and Roof, W.D. (2000) Phages will out: strategies of host cell lysis. *Trends Microbiol* **8**: 120–128.
- Yu, D., Ellis, H.M., Lee, E.C., Jenkins, N.A., Copeland, N.G., and Court, D.L. (2000) An efficient recombination system for chromosome engineering in *Escherichia coli*. *Proc Natl Acad Sci USA* **97**: 5978–5983.