

## Balance responses to lateral perturbations in human treadmill walking

A. L. Hof<sup>1,2,\*</sup>, S. M. Vermerris<sup>1</sup> and W. A. Gjaltema<sup>1</sup>

<sup>1</sup>Centre for Human Movement Sciences, University of Groningen, PO Box 196, Groningen, 9700 AD, The Netherlands and <sup>2</sup>Centre for Rehabilitation, University Medical Centre Groningen, Groningen, 9700 RB, The Netherlands

\*Author for correspondence (a.l.hof@med.umcg.nl)

Accepted 20 April 2010

### SUMMARY

During walking on a treadmill 10 human subjects (mean age 20 years) were perturbed by 100 ms pushes or pulls to the left or the right, of various magnitudes and in various phases of the gait cycle. Balance was maintained by (1) a stepping strategy (synergy), in which the foot at the next step is positioned a fixed distance outward of the 'extrapolated centre of mass', and (2) a lateral ankle strategy, which comprises a medial or lateral movement of the centre of pressure under the foot sole. The extrapolated centre of mass is defined as the centre of mass position plus the centre of mass velocity multiplied by a parameter related to the subject's leg length. The ankle strategy is the fastest, with a mechanical delay of about 200 ms (20% of a stride), but it can displace the centre of pressure no more than 2 cm. The stepping strategy needs at least 300 ms (30% of a stride) before foot placement, but has a range of 20 cm. When reaction time is sufficient, the magnitude of the total response is in good agreement with our hypothesis: mean centre of pressure (foot) position is a constant distance outward of the extrapolated centre of mass. If the reaction time falls short, a further correction is applied in the next step. In the healthy subjects studied here, no further corrections were necessary, so balance was recovered within two steps (one stride).

Supplementary material available online at <http://jeb.biologists.org/cgi/content/full/213/15/2655/DC1>

Key words: balance, locomotion, perturbation, inverted pendulum model.

### INTRODUCTION

Maintaining balance is a subordinate but necessary requirement for most human and animal actions. In standing (Winter, 1995) the aim of balance can be formulated as follows: the whole-body centre of mass (CoM) should on average be above the centre of pressure (CoP). The CoP is the point on the floor where the resultant ground reaction force vector is located; under the foot in one-legged standing and between the two feet in two-legged standing.

In walking or other gross motor activities the CoM has a velocity which cannot be neglected in the analysis (Pai and Patton, 1997; Karcnik, 2004). It has been shown that this dependency can conveniently be described by introducing a new point, the 'extrapolated centre of mass', XcoM, defined as (Hof et al., 2005):

$$\zeta = z + \frac{v_z}{\omega_0} \quad (1)$$

The XcoM can be seen as a point on the ground, a distance  $v_z/\omega_0$  removed from the vertical projection of the CoM  $z$ , in the direction of the CoM velocity  $\vec{v}_z$ . The parameter  $\omega_0$  equals the pendulum angular frequency from the inverted pendulum model. It can be shown that the XcoM always moves away from the CoP, and that the CoM ultimately follows the XcoM (Hof, 2008).

In walking the left and right feet are alternately put at a certain stride width from each other and the CoM is to be moved to the right when the left foot is on the ground, and to the left when the right foot is on the ground. This demand can be met when in left stance the lateral component of the CoP position  $u_{z\text{left}}$  is put to the left of the XcoM, and *vice versa*:

$$u_{z\text{left}} < \zeta(t) < u_{z\text{right}} \quad (2)$$

This implies that it is not sufficient that the CoM remains within the width of left and right foot placement; this should hold for the XcoM as well, which is a stricter condition, as the amplitude of the lateral XcoM movement is greater than that of the CoM.

In a model of walking (Hof, 2008) it turns out that walking with a constant stride width fulfils the criteria for balance if the CoP at each step is positioned a fixed distance  $b$  outside the actual XcoM position. More importantly, it can be shown that lateral perturbations can be handled by just sticking to this rule. In a study on unperturbed walking (Hof et al., 2007) it was confirmed that the minimum distance  $b = |u_z - \zeta_{\text{max}}|$  is indeed remarkably constant, and that it is larger on the prosthetic side of above-knee amputees. To be clear: this 'constant margin' hypothesis is suggested by experiments on unperturbed walking, the inverted pendulum model shows that it is a simple and sufficient control strategy, but it is in no way predicted by theory. CoP positioning was mainly done by foot placement ('stepping strategy'), but a contribution of the 'lateral ankle strategy' (Hoogvliet et al., 1996) could also be shown by investigating the differences in the shift of the CoP under the foot between the normal and the prosthetic leg in the amputee group. In the present study we put the 'constant  $b$ ' hypothesis further to the test by applying perturbations of known magnitude and timing. (In recordings of free walking the perturbations, either external or self-produced, are unknown.) The time needed for the execution of both the stepping and ankle strategies can also be studied in this way, as the perturbations can be made quite brief.

In walking balance studies to date, most balance perturbations were in the sagittal plane, usually by platform motion (Nashner, 1980; Woollacott and Tang, 1997; Tang et al., 1998). More severe challenges to balance were induced slipping (Marigold et al., 2005) and tripping (Schillings et al., 2000; Pijnappels et al., 2006). The

subject of the present paper, walking with lateral perturbations, has been studied much less (Hill et al., 2001; Oddsson et al., 2004). This is remarkable, as it is known from modelling studies that, in contrast to forward stability, lateral balance requires active control (Kuo, 1999; O'Connor and Kuo, 2009), which can be effected by foot placement (Townsend, 1985). Experimentally it has been shown that when lateral movements in walking on a treadmill are stabilized by a hip belt fixed to the treadmill frame, both stride width (Dean et al., 2007) and energy consumption (Donelan et al., 2004) are markedly reduced.

In this study lateral balance was studied in healthy human subjects walking on a treadmill. Lateral perturbations were brief (100 ms) pushes to the left or pulls to the right, programmed at various intensities and timing in the gait cycle. Our working hypothesis was that the foot's CoP is always positioned a constant distance outside of the XcoM, even after a perturbation.

## MATERIALS AND METHODS

### Instrumentation

CoP recordings during walking were made by means of an instrumented treadmill (Fig. 1). The treadmill walking surface B was provided with four transducers at the four corners for measuring the vertical ground reaction force. From the distribution of the forces the forward ( $x$ ) and lateral ( $z$ ) position of the CoP can be calculated. The definition of axes is according to the standard of the International Society of Biomechanics (Wu and Cavanagh, 1995). It was verified that the CoP assessment procedure is accurate to within 0.6 cm (Verkerke et al., 2005). Data acquisition was done by a 16-bit A/D card at 100 Hz under the control of a LabView (National Instruments, Austin, TX, USA) program, with off-line data processing by customized programs written in Matlab (The MathWorks, Natick, MA, USA).

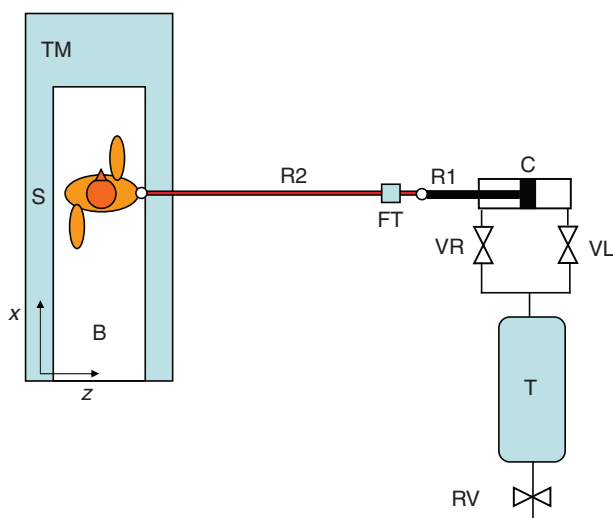

Fig. 1. Experimental set-up. The subject S walks on the belt B of treadmill TM. The subject is provided with a broad belt around the waist to which a fibreglass rod R2 is connected by a ball joint. The force in R2 is measured by a force transducer FT. R2 is connected with a second ball joint to the piston rod R1 of a pneumatic cylinder C. The cylinder has a stroke of 50 cm and low friction. A push to the right (left) is given by a computer-controlled opening of electric valve VR (VL). When actuated, the valve is connected to the pressure tank T, otherwise it is open to the ambient air. In the present experiments opening time was always 100 ms. The pressure in tank T is regulated by an electric pressure regulator valve RV.

The perturbation apparatus consists of a double-acting pneumatic cylinder C with a bore of 25 mm and a stroke of 500 mm. The piston rod R1 is connected *via* a 1.5 m long fibreglass rod R2 to a stiff belt around the waist of the subject S. The connections between the rods and between R2 and the belt are made by ball joints. Together with the long stroke of the cylinder this ensures sufficient freedom of movement for the subject. When a push is given to the left (or a pull to the right, hereafter 'push'), valve VL (VR) is connected for 100 ms to a 2.51 tank T with pressurized air, while the other valve remains open to the outside air. This results in a pulse-like force, with a magnitude practically independent of piston position or movement. Between pushes force is low; only some friction remains. The pressure in the tank is regulated by an electric pressure regulator valve RV, which acts sufficiently fast to change pressure between pushes. A force transducer FT is built into the connecting rod R2.

The magnitude and timing of the pushes is controlled by the same LabView computer program as for the A/D acquisition. The times of right heel contact are assessed on-line during walking and the mean stride time is computed over the previous 10 strides. Pushes are given at a set interval after right heel contact, calculated as a percentage of this mean stride time. The magnitude of the pushes is expressed as the immediate change in XcoM they induce:

$$\Delta\zeta = \Delta z + \frac{\Delta v_z}{\omega_0} \quad (3)$$

The quantity  $\Delta v_z$  is obtained by integrating the lateral acceleration once:

$$a_z = \frac{h}{l_c} \times \frac{F_z(t)}{m}$$

and  $\Delta z$  is obtained by integrating twice. Here  $F_z(t)$  is the lateral pushing force,  $m$  is body mass,  $h$  is the height at which the push is applied and  $l_c$  is the height of the CoM.

Trunk angular velocity in the frontal plane was recorded by a gyroscope sensor (Murata Gyrostar ENC-03J, Murata Manufacturing Co. Ltd, Kyoto, Japan) fastened to the back at about T2 level. EMG recordings were also made, but these will be reported elsewhere.

### Data processing

Temporal gait data are presented as a percentage of the stride cycle. By convention, a stride begins with right heel contact, comprises one right and one left step, and is subdivided from 0% to 100%. These temporal data were calculated from the CoP data (Verkerke et al., 2005).

The projection of the CoM at ground level was computed from the CoP data by low-pass filtering (Hof, 2005). This method is based on the inverted pendulum model of human balance and assumes that angular accelerations of the limbs and trunk can be neglected (Hof, 2007). It was used in an adapted form, in which the effect on the XcoM of a lateral push with force  $F_z$  at height  $h$  was included (see Eqn3). The validity of this procedure was tested in an experiment where the calculated CoM and XcoM positions were compared with positions obtained by an optokinematic method using 21 markers in a 14-segment model (Winter et al., 2003). The s.d. in reported values of the XcoM was 2 mm.

Mean values for CoP position  $u_z(t)$  over a stride were calculated as means over the period of single stance, for the left and right step separately. In addition to this, the initial CoP position (at contralateral toe-off) was also calculated. The difference between mean and initial CoP position has been called 'CoP shift', as it reflects the movement

of the CoP during stance. CoP shift is partly related to the toe-in or toe-out positioning of the foot, and partly to the left–right motion of the CoP under the foot, termed lateral roll-over. A toe-out position gives a negative value for the left and a positive value for the right foot roll-over. For the XcoM  $\zeta(t)$  the maximum (right) or minimum (left) value over the stance interval is the relevant quantity according to theory (Hof, 2008).

### Protocol

There were 10 subjects, of mean ( $\pm$ s.d.) age  $20.6 \pm 1.1$  years, stature  $1.82 \pm 0.10$  m and body mass  $71.6 \pm 9.65$  kg, with no known problems of balance or locomotor apparatus. Subjects gave informed consent, in agreement with the guidelines of the local Medical Ethical Committee and in accordance with the Declaration of Helsinki.

Subjects walked on the treadmill at a speed of  $1.25 \text{ m s}^{-1}$  multiplied by the square root of leg length in metres. In this way walking speed is scaled according to leg length (Hof, 1996). Each single measurement lasted about 5 min, during which 20 pushes were given. There were two protocols; in the first, push magnitude was constant at  $8.9 \pm 1.0 \text{ kg m s}^{-1}$  (left) and  $7.1 \text{ kg m s}^{-1}$  (right) and pushes were given at 10%, 20%, ... 100% of the gait cycle, both to the left and to the right. In the second protocol, pushes were given at either 40% or 90% of the gait cycle with magnitudes of about 2.7, 3.5, 6.0, 10.0 and  $12.4 \text{ kg m s}^{-1}$ . The order of the pushes was randomized and the interval between pushes was varied at random between 8 and 12 strides. Both protocols, with different randomizations, were used 10 times. Therefore from each subject 400 pushes and about 5000 strides were recorded in 2 h. The subjects were allowed to rest between measurements if they wanted to.

Significant differences between responses after perturbation and non-perturbed strides were detected by the signed rank test (Wilcoxon). Because of the great number of strides, the level for significance was set at  $P=0.01$ .

### RESULTS

Temporal and kinematic data for the unperturbed strides and for all subjects are shown in Table 1. Stride time was in all subjects close to the mean of 1.13 s and stance duration to 64% of stride. Stride width ranged within subjects from 4.6 to 14.3 cm, without relation to leg length or stature.

Fig. 2A gives an example recording for a push to the left starting at 95% of the walking cycle, i.e. just at right heel contact. We may call such a push, directed towards the free leg, an ‘inward’ push.

As a direct result of the push the XcoM is moved a distance  $\Delta\zeta$  of about 3.5 cm to the left. There is no time to correct this by displacing the right foot, and therefore the XcoM deviates about 7 cm more than usual to the left during the rest of right stance. At the instant of left foot contact, the left foot is also put about 7 cm more to the left than usual, remaining 2 cm left of the XcoM. This seems to be an adequate action, because the next right and left steps are more or less at their normal position again. Only a gradual drift can be seen, returning the CoM to the middle of the treadmill.

Fig. 2C gives the course of the CoP after the push in more detail and compares it to the normal course. The stepping strategy, as described above, is shown whereby the left foot is positioned from the beginning at a more leftward position (1). After this the CoP follows more or less the normal roll-over pattern (2). On the right side this is different. For about 200 ms after the push the time course of the CoP is exactly normal but after this it turns sharply leftward (3), which indicates a medial roll-over. Finally, it can be seen in Fig. 2C (4) that the duration of right stance is shortened, from 0.70 to 0.63 s. This is in fact due to a shortening of left swing time, from 0.40 to 0.33 s, while the right-to-left double contact duration is unchanged.

Fig. 2E shows the trunk angle in the frontal plane. The normal movement cycle has an amplitude of about 3 deg and is in phase with the stride cycle. In this case the perturbation causes only a slight deviation of the normal movement. Expressed as the root-mean-square (r.m.s.) error it amounted to 0.81 deg here, not different from the deviations of non-perturbed strides.

Fig. 2B,D,F shows the events after a left push at 48% of stance, just at left heel contact, an ‘outward’ push. Again, the initial left foot placement is unaltered, so that the XcoM is considerably offset to the left. In the next right step, the right foot is placed to the left of the current XcoM, which means more than 15 cm left of the usual right foot position. It is even to the left of the previous left foot position, which means that the right leg crosses the left one. The next steps are more or less at their normal position. The lateral ankle strategy is also apparent in the left step (3 in Fig. 2D), which shows a pronounced lateral roll-over. The effect of a shortened stance (in this case left) is not observed in outward pushes.

In an outward perturbation, trunk rotation (Fig. 2F) shows a substantially greater deviation, 4.6 deg r.m.s., from normal compared with the inward perturbation (Fig. 2E). The normal motion to the right is skipped and delayed to the next stride, the second after the perturbation. The latter is normal again, with a r.m.s. error of 0.4 deg.

Table 1. Subject data, temporal and kinematic data

Subject	Sex	Body mass (kg)	Stature (m)	Leg length (m)	Stride time (s)		Stance (% stride)	Stride length (m)		Stride width (cm)		$b_L$ (cm)		$b_R$ (cm)	
					Mean	s.d.		Mean	s.d.	Mean	s.d.	Mean	s.d.	Mean	s.d.
1	m	85.5	1.94	1.10	1.12	0.04	63.3	1.46	0.05	9.6	2.8	2.3	1.5	2.3	0.8
2	f	62.5	1.80	0.92	1.12	0.02	63.8	1.35	0.03	10.8	2.7	2.3	0.7	2.4	0.7
3	f	80.0	1.78	0.92	1.13	0.02	66.1	1.36	0.03	8.5	2.1	1.9	0.6	1.8	0.5
4	f	74.5	1.78	0.97	1.15	0.02	63.8	1.41	0.02	11.3	1.9	2.4	0.6	2.4	0.5
5	f	51.0	1.61	0.79	1.06	0.02	62.5	1.18	0.02	13.1	2.3	2.7	0.6	2.9	0.6
6	f	72.0	1.85	1.01	1.15	0.02	64.4	1.44	0.02	10.7	2.4	2.4	0.7	2.4	0.6
7	m	72.5	1.94	1.00	1.18	0.03	64.0	1.48	0.03	8.2	1.8	1.7	0.4	1.8	0.5
8	f	67.5	1.74	0.91	1.10	0.01	63.2	1.31	0.02	4.6	1.6	0.9	0.4	1.1	0.4
9	m	72.5	1.94	1.03	1.19	0.01	63.0	1.51	0.02	7.3	1.8	1.6	0.5	1.5	0.4
10	m	78.0	1.85	0.95	1.12	0.03	63.7	1.36	0.03	14.3	2.0	3.1	0.6	3.1	0.5
Mean		71.6	1.823	0.96	1.13	0.02	63.8	1.39	0.03	9.8	2.1	2.1	0.6	2.2	0.5
s.d.		9.65	0.10	0.08	0.04		0.97	0.10		2.8		0.6		0.6	

Leg length is measured from trochanter major to ground. Stance duration is given as a percentage of stride time.  $b_L$  and  $b_R$ , margin between the centre of pressure (CoP) and the extrapolated centre of mass (XcoM) for the left and right foot, respectively.

### Effects as a function of stride phase

Mean CoP and maximum XcoM position for all subjects are shown in Fig. 3 for pushes to the left at the same intensity, but at different phases of the gait cycle. In the right third of the figure the reactions in stride  $n$  are given as a function of the timing of the push, expressed as the phase of the stride. The middle third gives the reactions in stride  $n$  to a push in stride  $n-1$ , i.e. in the previous stride, and the left third gives the reactions to a push two strides before, at  $n-2$ . In this presentation, time from stimulus to response goes from left to right, as usual, but the response is always at the right (in 'stride 0') and an earlier stimulus (push) time is plotted more to the left. In this way, both the time delay between stimulus and response and the phase of the gait cycle in which the stimulus is given are represented.

Right stance is from 0 to 64%. It is therefore logical that right CoP (green triangles in Fig. 3) and XcoM (blue circles) are not changed from their usual (unperturbed) values when the push is given after right toe-off (64%). Left foot is in stance from 50%, so left XcoM (pink squares) does change as soon as the push is given, and increasingly deviates from its normal value for earlier pushes. This shift to the left is a mechanical consequence of the push. As long as the push is given during left stance, after 50%, there is no possibility of making a new left step, i.e. left CoP (red triangles) cannot change. Pushes at 30% or earlier can be countered by placing the left foot (L CoP) to the left of the XcoM, as in Fig. 2A,C.

The XcoM for the right foot (blue circles) is displaced to the left for pushes within right stance (0–50% of stride 0), but the CoP (green triangles) cannot react. For earlier pushes (down to 30% of stride

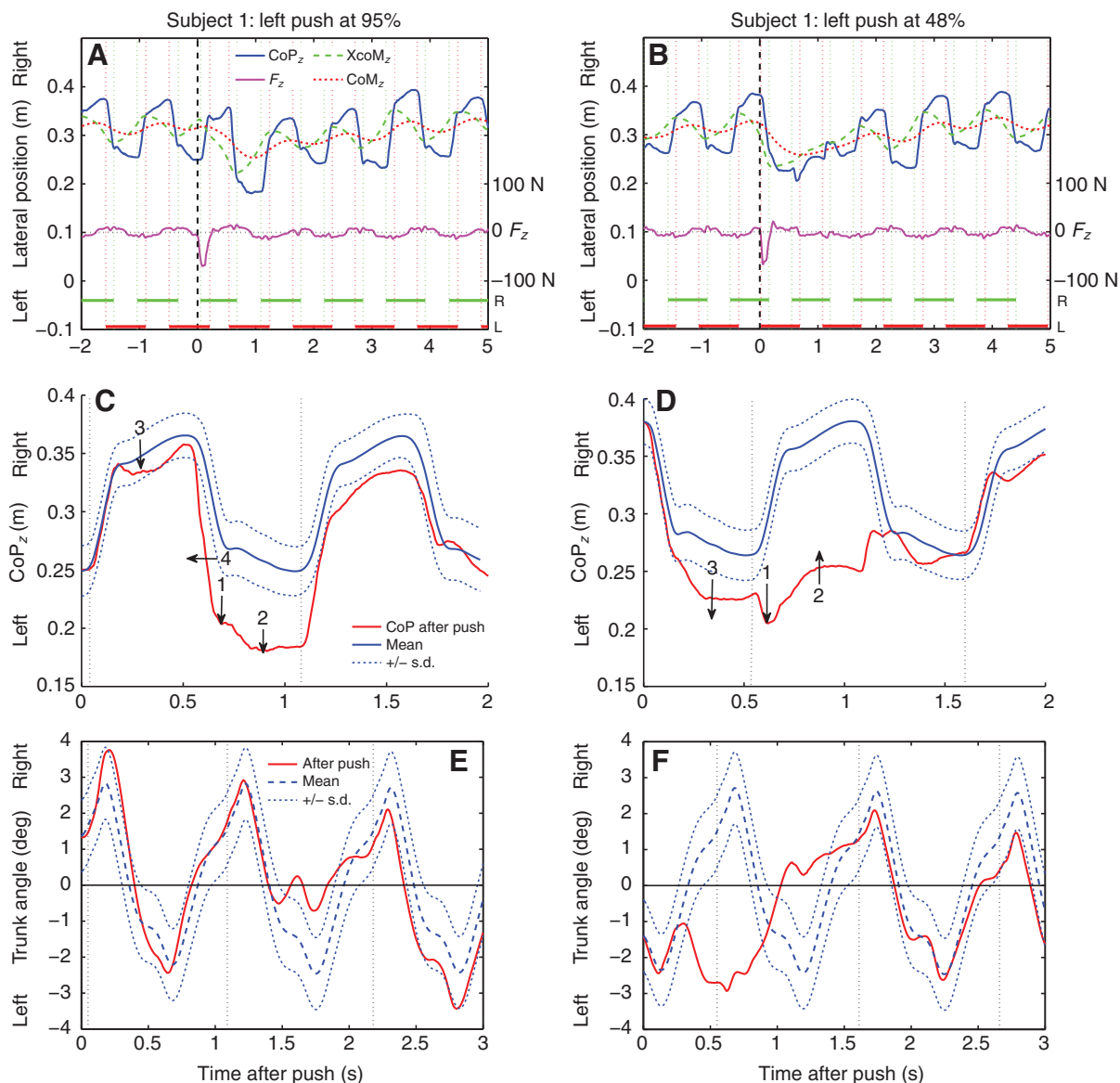

Fig. 2. Example recordings of an inward (A,C,E) and an outward left push (B,D,F) for subject 1. (A,B) Lateral position of centre of pressure (CoP<sub>z</sub>, blue line), centre of mass (CoM<sub>z</sub>, red dotted line) and extrapolated centre of mass (XcoM<sub>z</sub>, green dashed line) as a function of time, from 2 s before to 5 s after a push to the left. Also shown are the pushing force  $F_z$  (pink line, scale on the right) and the right (R) and left (L) stance phases (green and red bars and vertical dotted lines). (C,D) CoP on a reduced time scale, from 0 to 2 s after the push (red line). Blue line shows the mean of 179 unperturbed strides  $\pm$ s.d. (dotted lines). For meaning of arrows see text. (E,F) Trunk angle in the frontal plane (red line), obtained by integrating angular velocity measured by a gyroscope at the T2 level. Blue dashed line shows the mean of unperturbed strides  $\pm$ s.d. (dotted lines). Note that time scale is different from that of C and D. Movie clips showing the events in A,C,E and B,D,F can be found in supplementary material Movies 1 and 2.



-1) the right foot has to be placed to the extreme left, left of the left foot XcoM, as in Fig. 2B,D. Pushes earlier than this have already been corrected by action of the left foot, and need no special action of the right foot. The subjects' trajectories are not yet fully normal at this point as they need some additional corrections in stride -2 to return to the middle of the treadmill.

Fig. 4 shows the difference ('margin') between XcoM and CoP. It can be seen that the 'constant margin hypothesis' is fulfilled for the left foot (and left pushes) from 25% of stride 0 and below, i.e. after allowing 25%=0.28 s for a correct positioning of the left foot. For the right foot the situation is more complicated, as in the phase around 50% of stride -1, it crosses over to the left side. Either way, the main correction to the imbalance is made within a single stride.

In Fig. 5 the effect of the lateral ankle strategy is illustrated by plotting the CoP shift, the difference between the mean and initial value of the CoP position, for left and right steps. For most subjects the feet point slightly outward; this gives on average a positive value of the CoP shift for the right foot, and a negative value for the left foot. Individual values are given in Table 2. It can be seen that there are several exceptions to the average rule and some marked asymmetries.

For left inward pushes between 20% and 60% of stride 0 the left foot (red diamonds in Fig. 5) reacts with a leftward lateral CoP shift. This shift is not large in magnitude, about 1 cm, but is considerably earlier in time than the stepping response (cf. Fig. 2D). The right foot (green circles) has a similar pattern, but of course shifted to 50% earlier pushes. Table 2 also gives individual values for the maximum shift, which varies from 1 to 2 cm between subjects, in both leftward and rightward pushes.

For earlier pushes, 30-80% of stride -1, the left foot shows a second CoP shift, now in the medial direction. Inspection of the video data provided the explanation: after the cross-over step of the right leg the left foot has to be placed at its usual position again, but now the left leg has to make a wide swing around the crossed-over right leg. As a result the left foot is placed with an unusually large toe-in. This also explains why, for left pushes, the right foot shows a similar effect to a lesser degree.

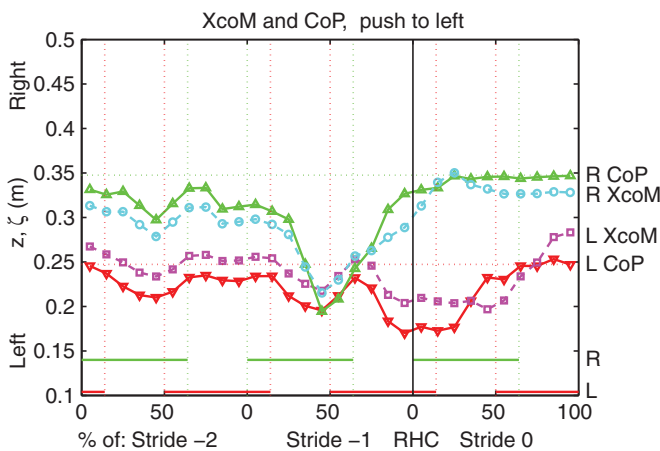

Fig. 3. Mean CoP and maximum XcoM during stance for pushes to the left as a function of the timing of the push, averaged for all subjects. Horizontal scale: timing of the push as a percentage of stride. Right, 'stride 0' indicates push within the measured stride itself; middle, 'stride -1' indicates push occurs one stride previous; left 'stride -2' indicates push occurs two strides previous. RHC, right heel strike. Foot contacts left L and right R are shown at the bottom of the figure. A corresponding figure for pushes to the right is given in the supplementary material (Fig. S1).

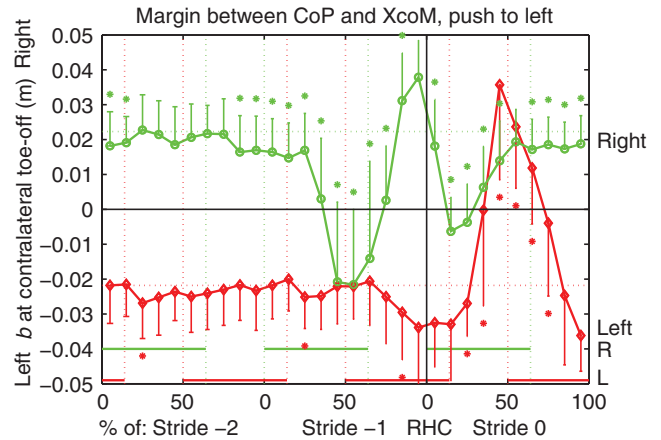

Fig. 4. Lateral margin between CoP and XcoM ( $b$ ) as a function of the timing of the push, averaged for all subjects: left foot, red diamonds; right foot, green circles, means  $\pm$  s.d. Horizontal scale as in Fig. 3. Asterisks indicate a significant difference from the unperturbed values, shown by horizontal dotted lines (Wilcoxon,  $P=0.01$ ). Note that for the left foot  $b$  is about equal to the mean unperturbed value of  $-2.2$  cm (horizontal dotted line) for pushes up to 25% of stride 0. For the right foot this holds only up to 15% of stride -1, due to the right cross-over step for pushes between 25% and 80% of stride -1. A corresponding figure for pushes to the right is given in the supplementary material (Fig. S2).

Fig. 6 gives the mean temporal variables and confirms the slightly shorter left swing time, as in Fig. 2C, for inward pushes, i.e. left pushes around right heel contact, from 85% to 25% of the stride.

In unperturbed strides the stride-to-stride variability of trunk rotation was 1-1.5 deg. After a perturbation the variability increased to about double in stride 0 (0-70%) and the stride immediately following (30-100%).

When viewed for the separate subjects, the course of CoP and XcoM as in Figs 3 and 4 was similar in all subjects. The main differences were the individual differences in stride width (Table 1). These are also reflected in the values for the margins  $b$  between

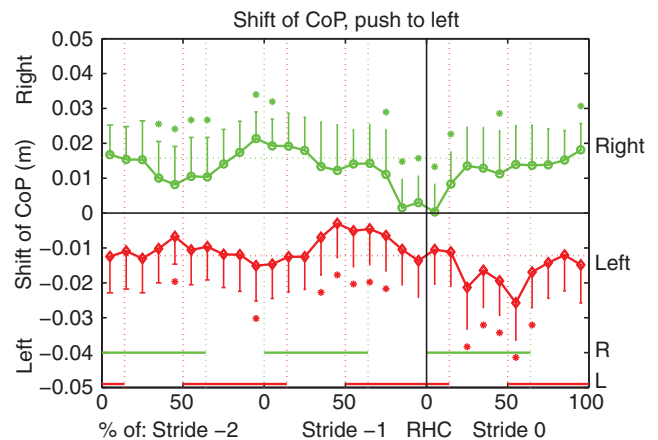

Fig. 5. Lateral foot roll-over, expressed as the difference between mean and initial CoP, as a function of the timing of the push, averaged for all subjects. Horizontal dotted lines are mean values for unperturbed strides; asterisks indicate a significant difference from the mean unperturbed values (Wilcoxon,  $P=0.01$ ). Evident deviations from this mean are seen for both the right and left foot, indicating a contribution of the ankle strategy to lateral balance. Horizontal scale as in Fig. 3. A corresponding figure for pushes to the right is given in the supplementary material (Fig. S3).

Table 2. Foot roll-over, presented as the difference between average and initial position of CoP during single stance

Subject	Mean CoP shift unperturbed (cm)		Additional CoP shift after push to left (cm)		Additional CoP shift after push to right (cm)	
	Left foot	Right foot	Left foot	Right foot	Left foot	Right foot
1	-1.1	1.8	-1.2	-1.5	1.5	1.0
2	-0.8	1.8	-1.1	-1.6	1.2	1.5
3	-0.2	-0.4	-1.0	-1.0	0.8	1.1
4	-2.7	2.2	-1.4	-2.1	2.0	0.9
5	-2.3	2.9	-1.5	-1.6	1.2	1.4
6	-1.0	0.8	-1.0	-1.1	1.3	0.9
7	-1.0	1.7	-1.5	-1.6	1.2	0.3
8	0.2	0.9	-1.5	-1.3	2.0	1.4
9	-1.1	0.7	-2.0	-1.5	1.4	1.9
10	-2.2	1.9	-1.6	-1.7	1.7	2.0
Mean	-1.2	1.4	-1.4	-1.5	1.4	1.2

Positive shift means to the right, negative to the left.

maximum XcoM and mean CoP position,  $b_L$  and  $b_R$  for the left and right foot, respectively. In general, they were equal to each other and equal to 0.22 times the stride width ( $R^2=0.97$ ).

For pushes to the right essentially the same effects were found as those described above for left pushes (see supplementary data Figs S1–S4). The two main differences are (1) that now, of course, the perturbations are to the right, and (2) that the most critical phase, where an outward push is given, is now around 0%, i.e. at or shortly before right stance. Pushes in this phase need to be corrected by placing the left foot to the extreme right. When the push is before 75% in stride -1, the right foot can be placed to the right in time, which is sufficient for the main correction.

#### Relationship to push magnitude

The effect of the magnitude (momentum) of the push on XcoM and CoP is shown in Fig. 7. In Fig. 7A the stride phase was 90% for the left and 40% for the right pushes and reactions in the stride following the perturbation ('+1') are given. These phases correspond to an inward push, so that the ipsilateral leg can be positioned in time to the left and right, respectively (cf. Fig. 2A,C,E). Push magnitude was expressed as the immediate change in XcoM due to the push,  $\Delta\zeta$ .

For left pushes it can be seen that the left CoP is positioned at a constant distance outside the XcoM (Fig. 7B, red curve). This margin  $b$  is not exactly constant; it shows some tendency to the left for leftward pushes and to the right for rightward pushes. For leftward pushes at 90%, the right foot is too late to step, and the right CoP moves leftward no more than about 3 cm (Fig. 7A). In part, this movement results from eversion of the right foot (cf. Fig. 2C). Fig. 8 shows foot roll-over for inward pushes. It can be seen that right foot eversion increases with push amplitude, but is limited to about 1.5 cm. For pushes to the right at 40% the effect on the right foot is similar (but opposite) to the effect of pushes at 90% on the left foot: the CoP is put at the correct position outside the XcoM, with a minor tendency to increase at larger pushes (Fig. 7B, green curve, right). For a 40% rightward push the left foot shows an eversion in the stance immediately following (Fig. 8, stride 0). In the stride that follows (+1) the imbalance has already been corrected by the right foot, the XcoM is at approximately the unperturbed value, and no action is necessary (Fig. 7A). Outward pushes give similar effects: the stepping action increases with the perturbation, the roll-over correction is restricted to  $\pm 1.5$  cm. With small perturbations no cross-over is observed.

#### Other effects

Changes in stride timing for inward pushes, for 90% leftward/40% rightward pushes, are given in Fig. 9. It can be seen that the effect of a shortened swing time (Fig. 6) is only present with stronger pushes. For  $\Delta\zeta$  of less than  $\pm 3$  cm timing is virtually unaffected. The effect is symmetric for leftward and rightward pushes. The deviation from mean trunk rotation increases on average with push magnitude, from 1 deg without to 4 deg r.m.s. at the greatest perturbations, comparable to Fig. 2F.

Fig. 10 shows that the CoP shift is negatively correlated with the initial CoP margin, in all strides, perturbed and non-perturbed.

#### DISCUSSION

In general it can be stated that foot placement strongly reacts to variations in lateral CoM velocity (Jeka et al., 2004). Thanks to the short duration of the pushes in our experiment, CoM position is

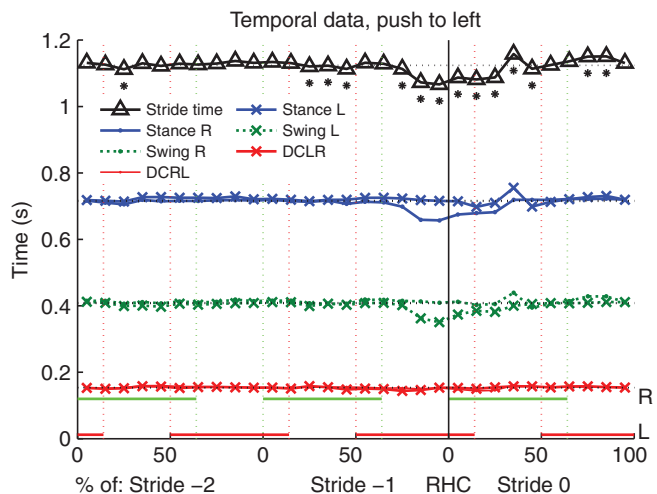

Fig. 6. Temporal variables as a function of the timing of the push, averaged for all subjects. From top to bottom: total stride time (black line and triangles), duration of stance [blue line; left (L), crosses; right (R), dots], duration of swing (dotted green line; left, crosses; right, dots) and duration of double stance (red line; left-to-right, crosses; right-to-left, dots). Horizontal scale as in Fig. 3. Asterisks at stride times indicate a significant difference from the mean unperturbed value, shown by horizontal dotted lines (Wilcoxon,  $P=0.01$ ). A corresponding figure for pushes to the right is given in the supplementary material (Fig. S4).

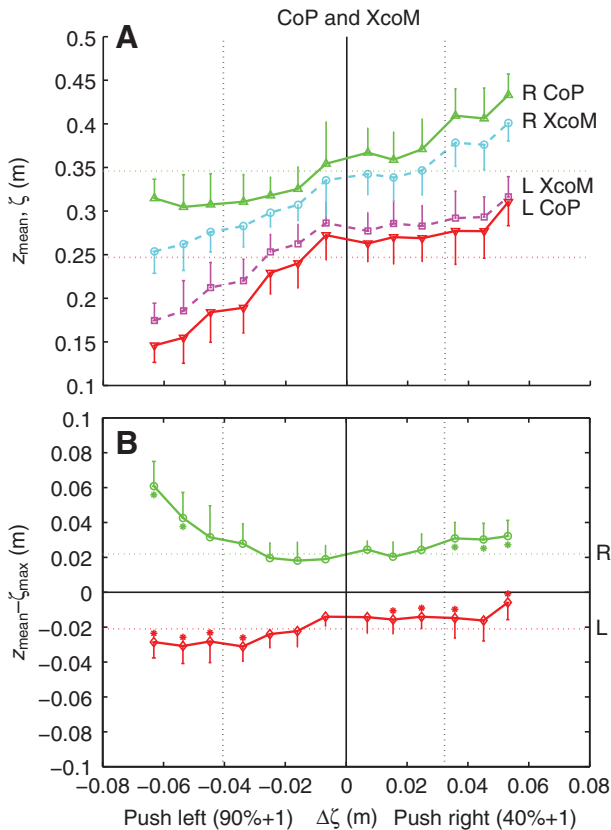

Fig. 7. (A) Mean CoP and maximum XcoM during the stride as a function of push magnitude. Inward pushes were given to the left at 90% of the previous stride or to the right at 40% of the previous stride. Push magnitude, horizontal scale, is expressed as the change in XcoM immediately after the push ( $\Delta\zeta$ ). This initial change in XcoM is amplified during stance, so the recorded changes in XcoM can be larger than  $\Delta\zeta$  (see text). The value of  $\Delta\zeta$  in measurements with variable gait phase (Figs 3–6) was  $-0.04$  m for left and  $0.03$  m for right pushes (vertical dotted lines). (B) Lateral margin between CoP and XcoM. In all cases, the foot repositioning, CoP placement in reaction to XcoM shift, occurs one step after the push. Asterisks indicate a significant difference from the unperturbed values, shown by horizontal dotted lines (Wilcoxon,  $P=0.01$ ).

only a little changed immediately after a push, but CoM velocity is altered. For a  $100$  ms push of  $8 \text{ kg m s}^{-1}$  on a subject of  $80$  kg, the velocity change equals  $0.1 \text{ m s}^{-1}$  and the displacement  $1$  cm, to give an example. Nevertheless, the reactions in terms of foot placement are considerable, almost  $20$  cm for a ‘cross-over’ step (Fig. 2B,D and Fig. 3). As to the magnitude of this stepping response, our hypothesis (Hof, 2008) is supported: the foot’s CoP is positioned a small fixed distance – the ‘margin’  $b$  – outside the calculated XcoM, even after an external perturbation (Fig. 4 and Fig. 7B).

### Stepping strategy

One reservation should be stated: the execution of foot placement (‘stepping strategy’) takes time. In Fig. 3 it can be seen that a correct outward foot positioning is only reached when the push comes at 25% of the stride or earlier. This means that the swing leg needs about 50% minus 25% of the stride time of  $1.2 \text{ s} = 0.28 \text{ s}$  for a full correction of foot placement. When the foot is already placed, however, no more correction by the stepping strategy is possible. In these cases the correction has to be made in the second step. If

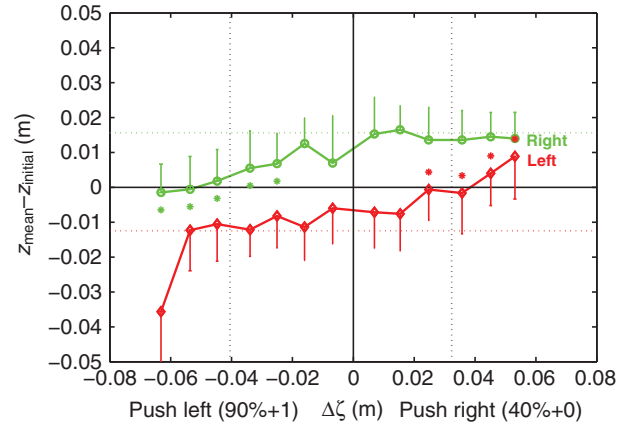

Fig. 8. Lateral foot roll-over, expressed as the difference between mean and initial CoP as a function of push magnitude. Horizontal scale as in Fig. 7. Inward pushes, to the left at 90% of the previous stride, to the right at 40% of the measured stride. Note that the data for left stance are now given for the stride itself. The roll-over effect occurs in the step in which the push is given. Asterisks indicate a significant difference from the mean unperturbed values, shown by horizontal dotted lines (Wilcoxon,  $P=0.01$ ).

the perturbation was directed outward (to the left in left stance or to the right in right stance) and the push sufficiently forceful, this would involve a cross-over step of the contralateral leg. After these one or two correction steps balance seems to be recovered. Only some gradual movement to the middle of the treadmill remains plus the usual random fluctuations. The subjects all felt that these stepping actions were done automatically and needed no attention. It should be remembered that the subjects of this study were young and healthy individuals. For older subjects our hypothesis is that they will correct perturbations less accurately, with a higher variability and requiring more steps to regain balance, and that demands on attention will be higher.

Theory suggests that the margin between XcoM and CoP at foot placement is constant, as this is in agreement with the experimentally

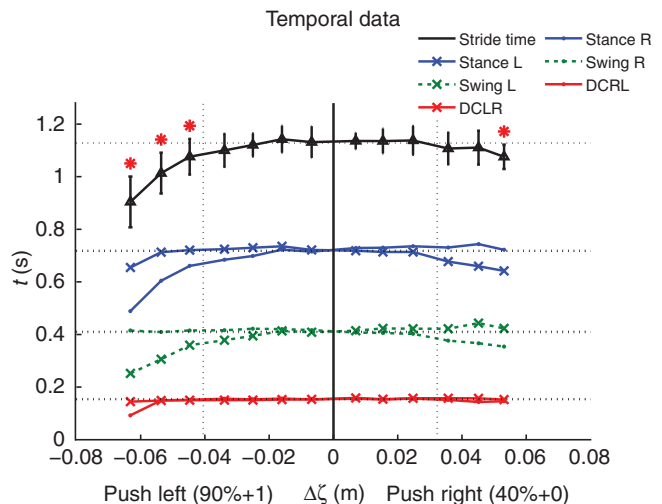

Fig. 9. Temporal data as a function of push magnitude for inward pushes, left pushes at 90% and right pushes at 40% of stride, the phase where the changes in timing are maximal (see Fig. 8). Horizontal scale as in Fig. 7. Asterisks indicate a significant difference from the unperturbed value of stride duration, shown by horizontal dotted lines (Wilcoxon,  $P=0.01$ ).

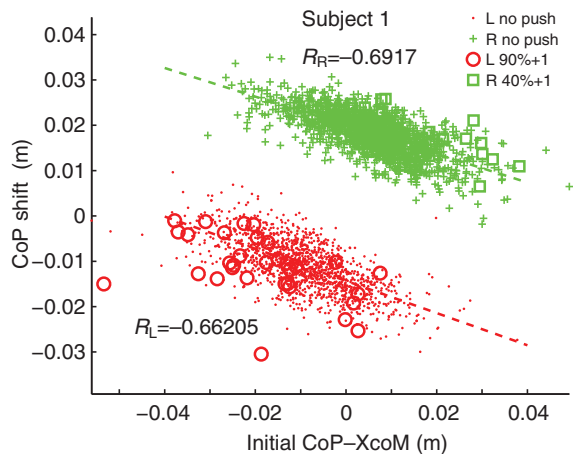

Fig. 10. CoP shift against initial CoP–XcoM distance, for all unperturbed strides of subject 1 (red dots and green crosses), for strides with a left push at 90% (red circles) and for strides with a right push at 40% (green squares). The negative slope of the points indicates that CoP shift by the ankle strategy partly compensates for inaccurate foot placement by the stepping strategy (see Discussion).

observed constant stride width (Hof, 2008). This is confirmed by the present experiments. When the push is given a sufficient time before stance, the margin is on average independent of gait cycle (Fig. 4) and only slightly dependent on the magnitude of the perturbation (Fig. 7B). This last effect, a greater margin after greater perturbation, may help the subjects to redirect their paths to the middle of the treadmill.

In a related experiment in cats pushed while walking on a treadmill (Karayannidou et al., 2009), very similar results were found: inward or outward stepping responses, dependent on the phase of the perturbation. In agreement with the present study, a single correction step was sufficient to restore balance. In a walkway experiment (Oddsson et al., 2004) in which the force platform was moved under the stance leg, a two-step response was found: one probably due to the platform translation itself, and a stepping response of the contralateral leg, similar to our present findings. No stepping responses were seen in running cockroaches, even after major perturbation by a miniature cannon (Jindrich and Full, 2002). This can be explained by their six legs and sprawled posture, which give a large base of support and a low position of the CoM.

#### Lateral ankle strategy

Modulation of foot roll-over, the lateral ankle strategy, was identified as a second strategy in lateral walking balance. In an average step of unperturbed walking the foot CoP starts on the heel at heel contact, runs approximately over the midline, and finally turns medially towards the big toe (D'Aout and Aerts, 2008). In standing on one foot the lateral ankle strategy is one of the main balance strategies (Hoogvliet et al., 1996; King and Zatsiorsky, 2002; Hof et al., 2005). By comparing CoP trajectories of normal and prosthetic feet in a previous paper on unperturbed walking (Hof et al., 2007) we found indications that in normal walking the lateral ankle strategy also serves as a balancing mechanism additional to the stepping strategy. This is confirmed by the present experiments. In Fig. 2C,D it can be seen that 200 ms after the push the CoP is displaced some 2 cm in the correct direction.

#### Interactions between stepping and ankle strategies

The main balance strategies in walking with small perturbations are the step and the lateral ankle strategy. How do they interact? As far as can be seen, both strategies are already present at the smallest perturbations applied (Fig. 7). The ankle strategy is the fastest because it can be used during stance, while the stepping strategy can only be applied in the next step. This is useful when the perturbation is given after or shortly before foot placement, when it is too late to apply a step strategy (Fig. 5). In such cases the lateral ankle strategy reduces the imbalance, even if it cannot give all the correction needed.

This does not mean that the lateral ankle strategy has a role only in balance control in emergencies. In Fig. 10 we saw a negative correlation between CoP shift (ankle strategy) and initial CoP–XcoM margin (stepping strategy). This suggests that the lateral ankle strategy compensates in part for the inaccuracy of foot placement (cf. Hof et al., 2007): a foot placement that is too inward (or too outward) is followed by a more outward (or inward) foot roll-over.

#### Shortening stride time

As a strategy additional to the stepping strategy, a shortening of stride time was found for left pushes around right heel contact, between 85% and 25% (Fig. 6). For small pushes, up to  $\Delta\zeta=3$  cm, this effect is insignificant, but for larger magnitudes the shortening can be considerable (Fig. 9). This effect is brought about by a shortening of contralateral swing time, as double stance time is not shortened. A shortening of stride time of a similar magnitude was reported in cats (Karayannidou et al., 2009), but to our knowledge it has not been reported before for human walking.

It can be understood as follows. When a perturbation is given and not completely corrected, the imbalance (i.e. the difference between CoP and XcoM) grows with time (Hof, 2008). To prevent excessive imbalance after a large push it can then be useful to make the corrective step earlier. It should be noted that this shorter stride time occurs only in inward pushes. The more complicated cross-over steps after an outward push probably cannot be shortened.

#### Other balance strategies

Next to the reported stepping and ankle strategies several other strategies have been reported for lateral balance. External support (Maki et al., 2003) on the treadmill handrail was not allowed. The load–unload strategy (Winter, 1995) is the main lateral strategy in two-legged standing. It does not seem important in walking. The double-stance periods in walking are only short, and do not shorten further, so an accelerated left loading/right unloading is not observed except possibly in the very largest (leftward) pushes (Fig. 9).

Other strategies are based on the mechanism that a leftward rotation of arms or trunk results in a rightward acceleration of the CoM and *vice versa* (Hof, 2007; Otten, 1999), the arm swing and hip strategy, respectively. We have inspected the video recordings, 20 representative pushes of all 10 subjects, and could find only a few pushes which led to discernible arm movements. Trunk motion was monitored by the gyroscope (Fig. 2E,F). There is certainly a change of trunk lateral rotation after a push, but in our estimate this is the direct mechanical consequence of the push itself and the stepping strategy that follows. We have calculated the angular acceleration from the gyroscope data and converted it to equivalent CoP displacement (Hof, 2007). This displacement fluctuated rapidly and had an amplitude less than 3 cm (1.0 cm r.m.s.) in the example recording of Fig. 2E. Comparing this with the actual CoP amplitudes of 10–15 cm, it seems that the hip strategy does not play a significant role in walking with perturbations of the size we applied. This is



very different when walking on a line or on a narrow beam, for example, in which case arm and trunk motions are very apparent.

### Sensory input

Having ascertained that the human body reacts strongly to changes in sideward velocity, the problem remains of how these velocity changes are perceived. Perception of absolute velocity is impossible, of course. The mean left–right velocity may be assumed to be zero, however, and only velocity changes need to be observed. One possibility is that these are sensed by proprioception in the muscles around the ankle, similar to the control of sagittal movements in standing (Jeka et al., 2004; DiGiulio et al., 2009). Another possibility is that they are perceived by integrating lateral CoM acceleration. A possible sensor is the vestibular system, but it should be noted that there is a considerable attenuation of the acceleration between pelvis (CoM) and head (Mazza et al., 2009), between 30% and 60%. A sensing organ closer to the CoM may be the intestinal sensors proposed by Mittelstaedt (Mittelstaedt, 1998). In our set-up the perturbation is applied close to the CoM. This means that the perturbation is not reflected in the horizontal ground reaction force, so this sensing modality (Meyer et al., 2004; Ting and Macpherson, 2004; Duysens et al., 2008) can at best play an indirect role here. In any case, research on balance in standing suggests that CoM velocities as low as  $1 \text{ deg s}^{-1} = 0.02 \text{ m s}^{-1}$  can be perceived (Jeka et al., 2004). This sensitivity is amply sufficient to detect the perturbations ( $0.03\text{--}0.16 \text{ m s}^{-1}$ ) applied in this study.

It should be borne in mind that the perturbations in the present study were relatively small, up to 6 cm (Figs 7–9), compared with a stride width of  $10 \pm 3 \text{ cm}$ . In real life this may correspond to unevenness in the terrain or interactions with fellow pedestrians. It is also important to consider that, as we saw above, foot placement is not very precise:  $b$  has a standard deviation of 0.6 cm. The imperfections are magnified with time and should be corrected in the steps that follow. A consequence is that even in unperturbed walking stride width fluctuates considerably (Table 1). When the perturbations are bigger, as in slipping (Marigold and Misiaszek, 2009; Marigold et al., 2005) or stumbling (Schillings et al., 2005; Pijnappels et al., 2005; Forner Cordero et al., 2003) reactions are more drastic and complicated, involving arm and trunk movements, very short steps, etc.

### LIST OF SYMBOLS AND ABBREVIATIONS

$a_z$	lateral acceleration of the CoM ( $\text{m s}^{-2}$ )
$b$	minimum distance, ‘margin’, between XcoM and CoP in a step (m or cm)
CoM	whole-body centre of mass
CoP	centre of pressure
$F_z$	lateral pushing force (N)
$g$	acceleration of gravity ( $9.81 \text{ m s}^{-2}$ )
$h$	height of pushing rod above treadmill surface (m)
Inward push	push directed from the stance leg towards the swing leg; leftward push in right stance or rightward push in left stance
$l$	equivalent pendulum length of human body (m): $l \approx 1.34l_t$ for the lateral direction
$l_c$	height of the CoM (m): $l_c \approx 1.10l_t$
$l_t$	leg length, height of trochanter major above the ground (m)
$m$	body mass (kg)
Outward push	push directed away from the stance leg; leftward push in left stance or rightward push in right stance
$t$	time
$u_z$	lateral component of CoP position (m)
$v_z$	lateral component of CoM velocity: $v_z = dz/dt$ ( $\text{m s}^{-1}$ )
XcoM	extrapolated centre of mass, see Introduction

$z$	lateral component of centre of mass position (m) rightward positive
$\Delta\zeta$	change in $\zeta$ directly caused by the push (m): for calculation see Eqn 3
$\zeta$	lateral component of XcoM position (m): $\zeta = z + (v_z/\omega_0)$
$\omega$	pendulum angular frequency in the lateral direction, parameter of the inverted pendulum model and the XcoM ( $\text{s}^{-1}$ ): $\omega_0 = \sqrt{g/l}$

### ACKNOWLEDGEMENTS

We thank Mrs J. T. Thole and K. Vaartjes for the construction of the pushing apparatus, and Mrs K. S. Veldman, R. Mulder and W. A. Kaan for development of the software.

### REFERENCES

- D’Aout, K. and Aerts, P. (2008). The evolutionary history of the human foot. In *Advances in Plantar Pressure Measurement in Clinical and Scientific Research* (ed. K. D’Aout, K. Lescrenier, B. van Gheluwe and D. de Clercq), pp. 44–68. Maastricht: Shaker.
- Dean, J. C., Alexander, N. B. and Kuo, A. D. (2007). The effect of lateral stabilization on walking in young and old adults. *IEEE Trans. Biomed. Eng.* **54**, 1919–1926.
- DiGiulio, I. D., Maganaris, C. N., Baltzopoulos, V. and Loram, I. D. (2009). The proprioceptive and agonist roles of gastrocnemius, soleus and tibialis anterior muscles in maintaining human upright posture. *J. Physiol.* **587**, 2399–2416.
- Donelan, J. M., Shipman, D., Kram, R. and Kuo, A. (2004). Mechanical and metabolic requirements for active lateral stabilization in human walking. *J. Biomech.* **37**, 827–835.
- Duysens, J., Beerepoort, V. P., Veltink, P. H., Weerdesteyn, V. and Smits-Engelsman, B. C. M. (2008). Proprioceptive perturbations of stability during gait. *Clin. Neurophysiol.* **38**, 399–410.
- Forner Cordero, A., Koopman, H. F. J. M. and Van der Helm, F. C. T. (2003). Multiple-step strategies to recover from stumbling perturbations. *Gait Posture* **18**, 47–59.
- Hill, S. W., Patla, A. E., Perry, S. D., Ishac, M. G. and Marigold, D. S. (2001). Base of support changes ensure a constant stability margin following unexpected lateral trunk perturbations during overground walking. In *Control of Posture and Gait* (ed. J. Duysens, B. Smits-Engelsman and H. Kingma), pp. 436–439. Maastricht: International Society for Postural and Gait Research, 2001.
- Hof, A. L. (1996). Scaling gait data to body size. *Gait Posture* **4**, 222–223.
- Hof, A. L. (2005). Comparison of three methods to estimate the center of mass during balance assessment. *J. Biomech.* **38**, 2134–2135.
- Hof, A. L. (2007). The equations of motion for a standing human reveal three mechanisms for balance. *J. Biomech.* **40**, 451–457.
- Hof, A. L. (2008). The ‘extrapolated center of mass’ concept suggests a simple control of balance in walking. *Hum. Mov. Sci.* **27**, 112–125.
- Hof, A. L., Gazendam, M. and Sinke, W. E. (2005). The condition for dynamic stability. *J. Biomech.* **38**, 1–8.
- Hof, A. L., van Bockel, R., Schoppen, T. and Postema, K. (2007). Control of lateral balance in walking: experimental findings in normal subjects and above-knee amputees. *Gait Posture* **25**, 250–258.
- Hoogvliet, P., Duyl, W. A., van Bakker, J., van de Mulder, P. G. H. and Stam, H. J. (1996). A model for the relation between the displacement of the ankle and the center of pressure in frontal plane during one-leg stance. *Gait Posture* **6**, 39–49.
- Jeka, J. J., Kiemel, T., Creath, R., Horak, F. B. and Peterka, R. J. (2004). Controlling human upright posture: velocity information is more accurate than position or acceleration. *J. Neurophysiol.* **92**, 2368–2379.
- Jindrich, D. L. and Full, R. J. (2002). Dynamic stabilization of rapid hexapedal locomotion. *J. Exp. Biol.* **205**, 2803–2823.
- Karayannidou, A., Zelenin, P. V., Orlovsky, G. N., Sirota, M. G., Beloozerova, I. N. and Deliagina, T. G. (2009). Maintenance of lateral stability during standing and walking in the cat. *J. Neurophysiol.* **101**, 8–19.
- Karcnik, T. (2004). Stability in legged locomotion. *Biol. Cybern.* **90**, 51–58.
- King, D. L. and Zatsiorsky, V. M. (2002). Periods of extreme ankle displacement during one-legged standing. *Gait Posture* **15**, 172–179.
- Kuo, A. (1999). Stabilization of lateral motion in passive dynamic walking. *Int. J. Rob. Res.* **18**, 917–930.
- Maki, B. E., McIlroy, W. E. and Fernie, G. R. (2003). Change-in-support reactions for balance recovery. *IEEE Eng. Med. Biol. Mag.* **22**, 20–26.
- Marigold, D. S. and Misiaszek, J. E. (2009). Whole-body responses: neural control and implications for rehabilitation and fall prevention. *Neuroscientist* **15**, 36–46.
- Marigold, D. S., Bethune, A. J. and Patla, A. E. (2005). The role of the swing limb and arms in the reactive recovery response to an unexpected slip during locomotion. *J. Neurophysiol.* **89**, 1727–1737.
- Mazza, C., Iosa, M., Picerno, P. and Cappozzo, A. (2009). Gender differences in the control of the upper body accelerations during level walking. *Gait Posture* **29**, 300–303.
- Meyer, P. F., Oddsson, L. I. E. and De Luca, C. J. (2004). Reduced plantar sensitivity alters postural responses to lateral perturbations of balance. *Exp. Brain Res.* **157**, 526–536.
- Mittelstaedt, H. (1998). Origin and processing of postural information. *Neurosci. Biobehav. Rev.* **22**, 473–478.
- Nashner, L. M. (1980). Balance adjustments of humans perturbed while walking. *J. Neurophysiol.* **44**, 650–664.

- O'Connor, S. M. and Kuo, A. D.** (2009). Direction-dependent control of balance during walking and standing. *J. Neurophysiol.* **102**, 1411-1419.
- Oddsson, L. I. E., Wall, C., McPartland, M., Krebs, D. E. and Tucker, C. A.** (2004). Recovery from perturbations during paced walking. *Gait Posture* **19**, 24-34.
- Otten, E.** (1999). Balancing on a narrow ridge: biomechanics and control. *Philos. Trans. R. Soc. Lond. B. Biol. Sci.* **354**, 869-875.
- Pai, Y.-C. and Patton, J.** (1997). Center of mass velocity-position predictions for balance control. *J. Biomech.* **30**, 347-354.
- Pijnappels, M., Bobbert, M. and Van Dieen, J.** (2005). How early reactions in the support limb contribute to balance recovery after tripping. *J. Biomech.* **38**, 627-634.
- Pijnappels, M., Bobbert, M. and Van Dieen, J.** (2006). EMG modulation in anticipation of a possible trip during walking in young and older adults. *J. Electromyogr. Kinesiol.* **16**, 137-143.
- Schillings, A. M., Wezel, B. M. H., van Mulder, T. and Duysens, J.** (2000). Muscular responses and movement strategies during stumbling over obstacles. *J. Neurophysiol.* **83**, 2093-2102.
- Schillings, A. M., Mulder, T. and Duysens, J.** (2005). Stumbling over obstacles in older adults compared to young adults. *J. Neurophysiol.* **94**, 1158-1168.
- Tang, P. F., Woolacott, M. H. and Chong, R. K. Y.** (1998). Control of reactive balance adjustments in perturbed human walking: roles of proximal and distal muscle activity. *Exp. Brain Res.* **119**, 141-152.
- Ting, L. and Macpherson, J.** (2004). Ratio of shear to load ground-reaction force may underlie the directional tuning of the automatic postural response to rotation and translation. *J. Neurophysiol.* **92**, 808-823.
- Townsend, M.** (1985). Biped gait stabilization via foot placement. *J. Biomech.* **18**, 21-38.
- Verkerke, G. J., Hof, A. L., Zijlstra, W., Ament, W. and Rakhorst, G.** (2005). Determining the centre of pressure during walking and running using an instrumented treadmill. *J. Biomech.* **38**, 1881-1885.
- Winter, D. A.** (1995). Human balance and posture control during standing and walking. *Gait Posture* **3**, 193-214.
- Winter, D. A., Patla, A. E., Ishac, M. G. and Gage, W. H.** (2003). Motor mechanisms of balance during quiet standing. *J. Electromyogr. Kinesiol.* **13**, 49-56.
- Woollacott, M. H. and Tang, P. F.** (1997). Balance control during walking in the older adult: research and its implications. *Phys. Ther.* **77**, 646-660.
- Wu, G. and Cavanagh, P. R.** (1995). ISB recommendations for standardization in the reporting of kinematic data. *J. Biomech.* **28**, 1257-1260.