

Ball Sensing in a Leg Like Robotic Kicker

Jonas Logghe, André Dias, José Almeida, Alfredo Martins, and Eduardo Silva

INESC TEC - INESC Technology and Science
(formerly INESC Porto) and ISEP/IPP - School
of Engineering, Polytechnic Institute of Porto
Rua Dr Antonio Bernardino de Almeida, 431, Porto, Portugal
{jonaslogghe, adias, jma, aom, eaps}@lsa.issep.ipp.pt
<http://www.lsa.issep.ipp.pt>

Abstract. The trend to have more cooperative play and the increase of game dynamics in Robocup MSL League motivates the improvement of skills for ball passing and reception. Currently the majority of the MSL teams uses ball handling devices with rollers to have more precise kicks but limiting the capability to kick a moving ball without stopping it and grabbing it. This paper addresses the problem to receive and kick a fast moving ball without having to grab it with a roller based ball handling device. Here, the main difficulty is the high latency and low rate of the measurements of the ball sensing systems, based in vision or laser scanner sensors. Our robots use a geared leg coupled to a motor that acts simultaneously as the kicking device and low level ball sensor. This paper proposes a new method to improve the capability for ball sensing in the kicker, by combining high rate measurements from the torque and energy in the motor and angular position of the kicker leg. The developed method endows the kicker device with an effective ball detection ability, validated in several game situations like in an interception to a fast pass or when chasing the ball where the relative speed from robot to ball is low. This can be used to optimize the kick instant or by the embedded kicker control system to absorb the ball energy.

Keywords: Middle Size League, Ball sensing, Leg like Kicker.

1 Introduction

Robocup is an international project that aims to promote robotics by providing a standard problem (soccer game) as a central topic of research, with the intention of producing innovations (hardware and software) to be applied to society and industry. The ultimate goal of the RoboCup project is "By 2050, to develop a team of fully autonomous humanoid robots that can win against the human world champion team in soccer." [3]. To achieve this, much research has yet to be done in several areas, such as mechatronics, perception in highly dynamic and noisy environments, intelligent control, cooperative work, players coordination, strategies adaptation and learning, only to name a few.

To play football, some required fundamental skills are ball control and manipulation, passing and receiving the ball, intercepting and kicking a ball.

In MSL, a lot of work has been done in this area. The kicker and ball handling mechanisms suffered several improvements at all levels, (mechanic and electronic), in

Robocup's past years. By 1997, the MSL robots had no kicker devices[13]. The robots only pushed the ball around, some using a passive finger like ball handler mechanisms. In the following years teams started to develop kicker mechanisms. Those could be based in spring[13], pneumatic[14] and solenoid[15][9] devices. By 2002/2003 some teams started using stronger spring[4][7] and solenoid kicker[8] devices in competitions. Due to the advantage of having, in competition, a strong shot many teams started to use similar systems. Ball handling mechanisms evolved from passive fingers to active fingers and roller mechanisms. There was always some controversy about the usage of active rollers. Although there were some attempts in the rules to restrict roller based devices, namely around 2003/2004, those rules' spirit was later on a bit distorted, leading to different rules were those devices are allowed if the ball "rotates in its natural direction of rotation".

Only few research efforts were done in different types of ball handling devices. In 2003, Mu-Wallabies team presented a robot with an arm like kicker[5], and Philips team had demonstrated some prototypes for ball stopping devices[7]. Later, some research was done concerning ball stopping devices [11][15]. But, approaches to control the ball without continuous robot-ball contact are more rare. In Robocup's 2010 technical challenge the Tech United team presented a control behavior to dribble forward the ball with small taps[15]. And in 2011 ISePorto's team started using only small kicks to move forward in the field and to intercept the ball[12].

Currently several MSL teams use sophisticated mechanic roller based ball handling devices to have more precise kicks[6], but that type of ball handling limits the capability to kick a moving ball without stopping it and "sucking/grabbing it". Additionally it is not adequate to dribble the ball in a noncontinuous contact. Having in mind the classic definition ball dribbling: "dribbling refers to the maneuvering of a ball around a defender through short skillful taps or kicks"[10]. And the desire to have games similar to human football games, associated to the increase of game dynamics in Robocup MSL League, motivates a radical change in the ball manipulation skills.

For development of skills like short skillful taps or kicks, first-touch control or one-touch play, one key problem is latency and low rate of the measurements provided by the ball sensing systems typically used, based in vision or laser scanner sensors.

Focus on the Robocup Middle Size League, the goal of this paper is to present the development and results of a novel ball sensing approach for a leg like kicker, developed to enable the robot to receive, intercept and kick a fast moving ball, and pass and dribble it forward with a similar behavior to that of a human soccer player.

The robots from ISePorto Team use a leg coupled through gears to a DC motor with an optical encoder, that acts simultaneously as the kicking device and as a low level ball sensor. The 2011 version of the system uses only the movement and velocity of the kicker to detect the ball. To receive a ball the kicker is moved to a receiving position in front of the robot, this way an incoming ball can move the kicker a certain distance. When kicker leg is pushed back by some threshold value (A on Fig.3) and the kicker reaches a certain velocity a kick is performed (B on Fig.3). This system suffers from a sensitivity problem. When the robot was driving and expecting a ball, the sensing mechanism sometimes reacted on the movement of the robot. Also it was not possible to intercept a moving ball by chasing after it and let it hit the kicker.



Fig. 1. Middle Size League Robot

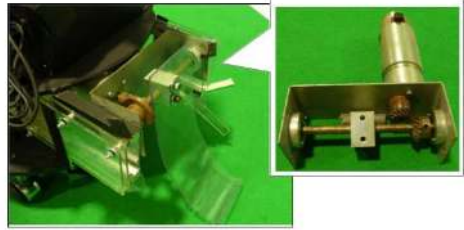

Fig. 2. Kicker Device

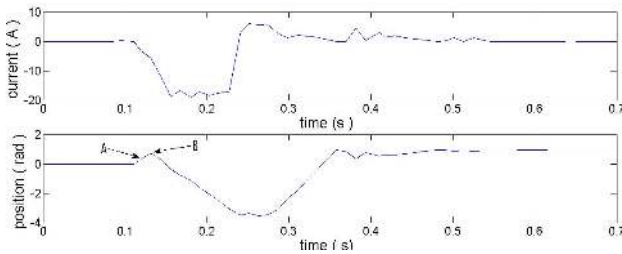

Fig. 3. kick with current detection system

The new ball sensing method presented in this paper, runs in the embedded kicker control system and improves the capability of ball sensing in the kicker, by combining higher rate measurements from the torque and energy in motor and angular position of kicker leg. It provides detection events within a few milliseconds, that can be used both in the kicker control, for ball reception or kick instant optimization, or by the robot control applications running in the main robot computer. The information provided by this new sensor is complementary to other available in the robot perception system, and is used in the low level feedback and in state transitions in the embedded kicker control system.

The outline of this paper is as follows. In section 2, the problem of low level ball sensing is analysed in order to identify a set of game situations that must be distinguished by the system. Then a model of the kicker is presented. In section 4, alternative detection methods, like: thresholds in motor current (proportional to the motor torque), derivative of the current, and integration of current (proportional to the energy) are proposed, tested and compared in simulation. Issues of the implementation of the detection methods in the embedded kicker control system are addressed in section 5, and results of the its application in the robots are presented in section 6. Finally, some conclusion are drawn about the implemented method and some future improvements are proposed.

2 Requirement Analysis

In this section, we will discuss the behavior of the kicker during a Middle Size League in order to typify game situations that could influence the low level ball detection.

- **Receiving a ball:** In a human soccer game, the player receives the ball by using the foot against the ball. During a game, this behavior (see Figure 4) occurs with high frequency, specially if the team is performing cooperative actions by passing and receiving the ball. The ability to sense the ball in this situation is harder when the ball comes with lower speed.
- **Robot acceleration:** When accelerating, the inertia of the kicker causes it to move in the opposite direction of the acceleration (see Figure 5). With the former detecting mechanism the kicker sometimes performed a kick in this situation.
- **Robot collision:** Sometimes during a game the robot collides with another robot. If this happens when the robot is in the receiving position the kicker will move as a result of the collision (see Figure 6). This situation was analysed but is not the priority of the new sensing mechanism.
- **Chasing a ball:** This situation is the hardest one to detect. When a ball is moving with a certain velocity and the robot wants to intercept it for kicking or receiving the ball while moving, he needs to chase the ball (see Figure 7). When the ball hits the kicker the relative velocity of the ball to the kicker is very small, becoming hard to detect.

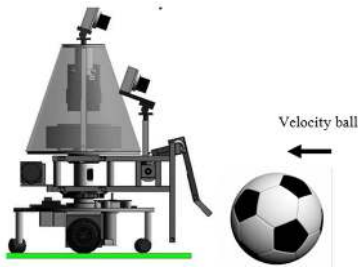

Fig. 4. Receiving a ball

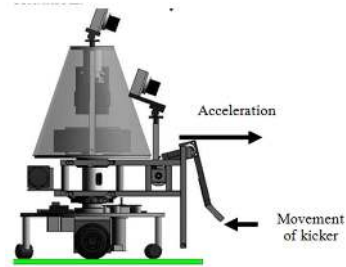

Fig. 5. Robot acceleration

3 Kicker Model

To be able to do quick testing and understanding how the dynamics of the robot and kicker work a model was built in Matlab/Simulink [1]. The model is based on some equations that were derived from the schematic in Fig.8.

The first equation is the one from the electrical circuit.

$$V = E + R \times i + \frac{di}{dt}L \quad (1)$$

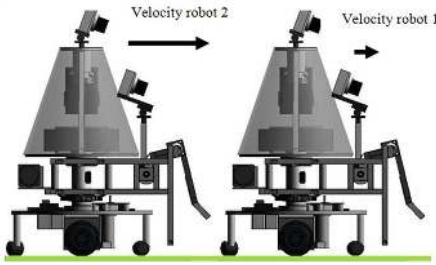

Fig. 6. Robot collision

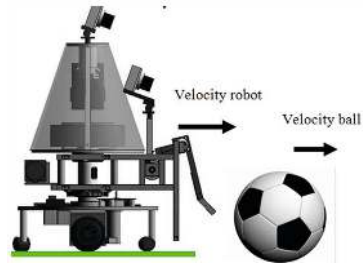

Fig. 7. Robot chasing a ball

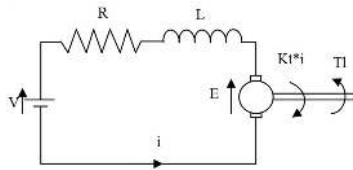

Fig. 8. schematic of the model

Here in R is the resistance, and L the inductance of the coil in the motor. E is the back electromotive force that is produced by the rotating motor and i the motor current. Equation 2 gives the relation of the back electromotive force to the velocity. K_{EMF} is the electromotive force constant.

$$E = \frac{d\theta}{dt} k_{EMF} \tag{2}$$

The torque produced by the motor T is related to the current in the armature by the torque constant k_t as shown in equation 3 .

$$T = k_t \times i \tag{3}$$

The torque produced by the motor is equal to the sum of all the torques that work in the opposite direction. In this sum the first term is the inertia of the rotor J that generates torque during a acceleration or deceleration. The second term is a torque by the damping of the system , here in b is the damping ratio of the motor. The third term is the sum of all the torques that are generated by the kicker system.

$$T = \frac{d^2\theta}{dt^2} J + \frac{d\theta}{dt} b + T_i(\theta) \tag{4}$$

In equation 5 the sum of the torques generated by the system is presented. The first term is the torque generated by the inertia of the kicker, gears and connecting axles. The second term stands for the torque due to the friction and all the other influences

that were not possible to calculate, so the c term was found by experiments. The last term is the torque created by the gravity of the kicker when it is not in vertical position.

$$T_l(\theta) = \frac{d^2\theta}{dt^2} J_{kicker} + \frac{d\theta}{dt} c + T_{gravity}(\theta) + T_{load} \quad (5)$$

These equations resulted in a model that was tested and compared with the logs perform in the robot. The dynamic response of the model is comparable to real values. The developed model was aggregate into a subsystem where a position PID control is applied to. The model was originally designed to test PID settings of the kicker and not to test detection methods, although it can be used if taken in account that the results must be compared to reality. In this system different loads can be added in the T_{load} allowing to simulate different levels of charges (different types of kicker material).

4 Ball Sensing Methods

Having in mind the identified game situations and the requirements for the ball detection method, four detection methods were tested and compared in simulation using the developed kicker:

Peak current - The maximum current that occurs during a game situation;

Maximum derivative of the current - The current is differentiated and the maximum value used as a sensing measurement;

Average derivative - The derivative of the current between the moment that the current starts to rise until reaches its maximum;

Integrated current - The current is integrated from the moment it starts to rise until reaches its maximum.

Those four methods were applied to the model for three of the 4 situations. The situation where the robot collides with another robot is not simulated because there are many different ways this can happen and there is not much data available to compare results with.

Table 1. Overview of detecting methods on the model

		Game situations		
		incoming ball	acceleration	chasing a ball
Detecting method	Peak current [A]	1.42	0.29	0.9
	Max derivative [A/s]	131	4	82
	Average derivative [A/s]	10.14	0.454	6.42
	Integrated current [A.s]	0.145	0.050	0.092

On a first observation all of the applied methods could be used to detect the ball and distinguish the different situations. But when applying the detecting methods to the robots there are some technical limitations and problems that require a modification of the detection methods that are detailed in next section.

5 Embedded Implementation of the Sensing Methods

The kicker sensing control architecture presented in figure 9 is characterized by two hierarchical levels of action. The lower level is implemented in a dedicated embedded hardware responsible for acting in the following tasks:

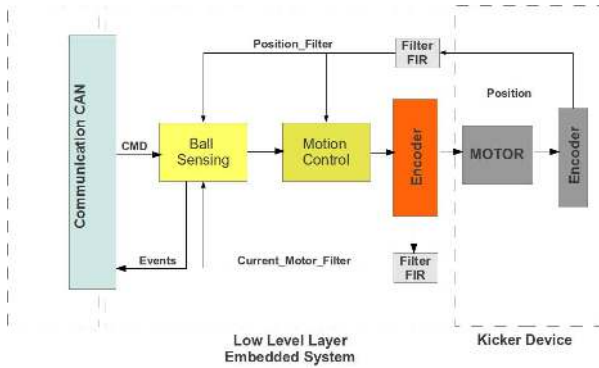

Fig. 9. Kicker Sensing implemented Architecture

- **Motion Control:** this task will perform control in position of the kicker through a proportional-integral-derivative controller based on command messages (KICK, RCV_BALL, KEEP_BALL, PREPARE_RCV_BALL) received by the CAN protocol or by the ball sensing task at low level.
- **Ball Sensing:** based on the information received from the motor current after being filtered and the position of the kicker this task processes the ball sensing methods by sending to the higher level (via CAN) all relevant information (continuous values and discrete events) and defining actions to the motion control task.

5.1 Current Filtering

When starting to monitor the current in the different situations one of the first things that came clear was the poor quality of the current signal. Therefore it was necessary to do some filtering on the incoming current signal.

Since the sampling frequency of the motor current can be much higher than the frequency of the current variations by the movement of the kicker, and the frequency of some noise sources is also higher, therefore a low-pass filter can reduce considerable the noise amplitude. A FIR (Finite Impulse Response) filter was chosen, since it does not require to calculate the filter output for every input like in an IIR filter (Infinite Impulse Filter). The output of this kind of filter is the sum of the current and previous inputs multiplied by filter coefficients. The filter structure:

$$[h]y(n) = \sum_{i=0}^M y_i x_{(n-i)} \quad (6)$$

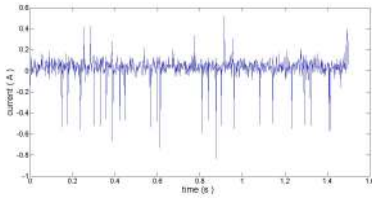

Fig. 10. Unfiltered signal

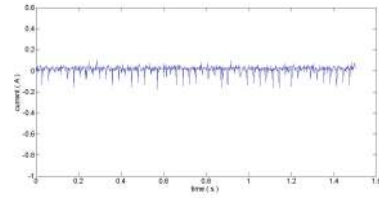

Fig. 11. Filtered signal

A downside for filtering is the delay on the filtered signal. This delay is a result of working with previous values. The delay depends on the sampling frequency F_s and filter order M :

$$delay = \frac{M - 1}{2 \times F_s} \quad (7)$$

To design the filter the Matlab Signal Processing Tool (sptool)[2] was used. With this tool the filter coefficients for a determined filter specification were calculated.

Initially the current sampling and ball sensing happened in the same interrupt that was called every 1.4 ms. Considering the slope of a soft ball hitting the kicker has a typical duration of approximately 30ms and the detection had to happen as fast as possible, there was not much room for delay. Originally the sampling of the current happened at the same interrupt as the algorithm for the kick detecting. This interrupt is called every 1.4ms. So the sampling frequency is 714Hz. The first filters developed sampled and calculated at this speed. To make a filter with the required attenuation of the noise, the order was too high and so was the delay. To obtain a high order filter without much delay in the filtered signal the sampling of the current was put in another interrupt that is called every 0.14ms so the sampling frequency is 7.14KHz. The calculating of the filter still happens at the original speed (714Hz). It is not necessary to calculate it more frequently than it is used and it would consume too much time from the cpu. In this way a 10 order filter is obtained without the cost of lots of cpu time and delay. In Fig. 11 is depicted the result of the 10th order filter that is used. The amplitude of the noise is reduced more than 5 times, and this makes the signal much more suitable for processing.

5.2 Applying the Detection Methods in the Embedded Control System

When applying the detection methods in the embedded control system to the robot some issues popped up immediately that led to some changes in the methods.

In the maximum derivative method, the numeric differentiation of the current signal is not adequate to the noise level in the current measurements. Although it work well with the developed kicker model in simulation, it does not behave well in the noisy measurements in the robot. This method caused a lot of false detection, even after the current filtering, and was not used in the tests with the robot.

The integrated current method had some problems as well. When the kicker was at its receiving position, the noise in the current signal made the integrated value reach fairly

high values. To prevent this, reset conditions for the integrated value were programmed. A first reset condition applied when the current signal is lower than a threshold value (0.2A), is when the sign of the derivative changes. So it may be the start of a new slope which means that a new measurement should be started, so the integrated value is reset to zero. A second reset condition is used when the current has a value bigger or equal to 0.2A . In this case the derivative of the kicker angle is calculated and compared to the previous calculated value. If the sign of the derivative changes the integrated value is reset to zero. These two reset conditions make it certain that the integrated value is only from the last slope of the current.

6 Results

The methods previous presented were implemented in the embedded controller and applied to the different game situations and the table 2 was obtained. When comparing the values in table 2 there should be taken in consideration that these values are typical values for a qualitative analysis.

Table 2. Overview of detecting with real data P=4

		Game situations			
		incoming ball	acceleration	collision	chasing a ball
Detecting method	Peak current[A]	1.9	1.5	1.5	1.4
	Differentiation[A/s]	50	40	60	50
	Integrated current[A.s]	0.058	0.058	0.046	0.115

Based on this table we can draw some conclusions about the detection methods. The differentiation method prove to be useless in reality: all the values are in the same range of magnitude. With the peak current method only an incoming ball can be detected. The integrated current method is sensitive enough to sense a ball even in the chased scenario. This is a major improvement with regards to previous implementations, so this method is the preferred one to be further refined and explored.

To improve the detection, the PID settings of the controller that keeps the kicker in place had to be adjusted. To better distinguish the incoming ball situation from the acceleration situation the P setting of the controller was adjusted from P=4 to P=15. The idea behind this is that the torque generated by the inertia of the kicker is not influenced by the PID settings , it only depends on the acceleration. When the P action of the controller is set firmer it will bring the kicker faster in a balanced position when accelerating so the integrated value is reset quicker. The current will be the same as the torque generated by the acceleration is constant. For the incoming ball scenario a higher P-action of the controller means it will be decelerated faster when it hits the kicker so there will be a bigger torque generated. In theory, the integrated value should stay the same because it resembles the energy that the motor has to put into the kicker to stop the ball. In both cases the ball has the same speed and therefore the value should be the same. The detection methods applied to current logs of the robot with the P=15 are given in table 3.

Table 3. Overview of detection with real data P=4

Detecting method	Peak current [A]	Game situations			
		incoming ball	acceleration	collision	chasing a ball
	Differentiation [A/s]	4	1.4	2.5	1.8
	Integrated current [A.s]	140	20	110	40
		0.092	0.035	0.058	0.069

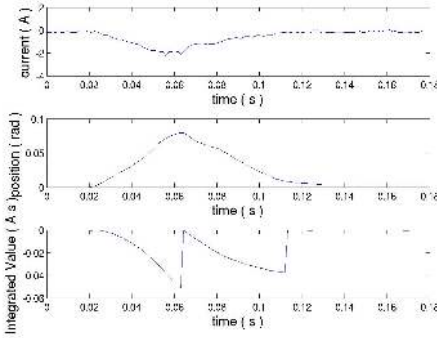

Fig. 12. Receiving soft ball

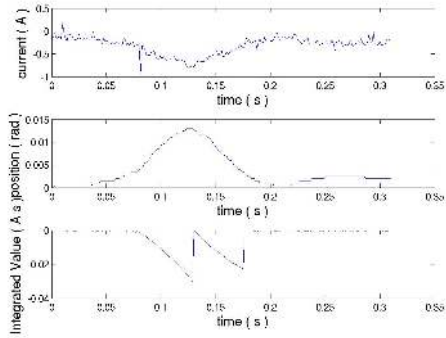

Fig. 13. Acceleration

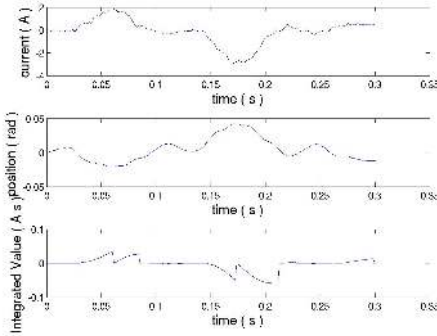

Fig. 14. collision with an opponent

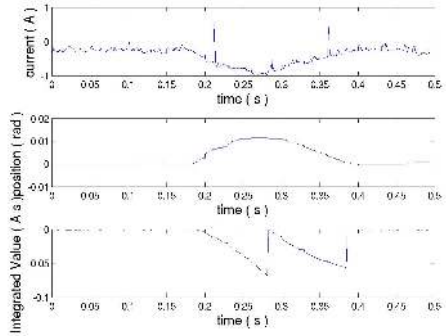

Fig. 15. Chasing a ball

Here you can see that the integrated value of the ball hitting the kicker increase when the P component of a PID control is higher. If we analyze the values in this table it's clear that the same conclusions can be drawn for the peak current and for the differentiation method as the former previous PID configuration. The big difference is the integration method. For the new P both incoming ball and chasing-a-ball game situations are well distinguished from the other two non-ball situations. Only a hard collision could be misleading and therefore confused with a chasing of a ball situation. Some logs of the different situations with the hard PID-settings are given in Fig.12 to Fig.15. In these figures you can see the effective action of the two current integration reset conditions in the different game situations.

7 Conclusions and Future Work

The paper has presented the development and validation of ball sensing and detection method that uses high rate and low latency measurements of the torque and energy in motor as well as the angular position of the kicker leg. This is integrated in the embedded motor control of the kicker device allowing it to detect the ball before it starts to move away from the kicker, so that the kick instant can be optimized. A set of game situations that must be distinguished by the system were hereby identified. Several detection methods were proposed and tested both in simulation, with a kicker model built for that propose, and with the robot. The current integration method, that provides an energy like measurement, shown to be superior to the other tested methods, is the only method that has the ability to detect an incoming ball when the robot is standing still and when the robot chases a ball. With the higher P-value in PID the detection value for chasing a ball is close to the one of a collision, and that could lead to some wrong detection of the ball. For that we propose some solutions. The first one is to use different PID settings for different situations. In the receiving ball we can use a more hard settings and for chasing a ball use a more soft setting. Another orthogonal solution would be to integrate information from the accelerometer of the robot in the detection. When the robot has a collision with something this would result in a big acceleration or deceleration. The accelerometer module is connected to the same CAN bus where the embedded kicker control system is also connected to. When a big deceleration or acceleration is detected the kick sensing mechanism could be temporally shutoff and reactivated when the robot is stable again. To achieve optimal settings more testing should be done with data collected during a game. There is still some room for improvement with the kick itself. Presently, when the ball is detected a kick is immediately performed. It would be better that the kicker keeps moving back after detection and performs the kick when its position is at its maximum without losing contact with the ball. This way the kicker would have an increased contact with the ball during a kick, resulting in a harder kick. Another application is to develop a reception control mode that once the ball is detected it decelerates it.

Acknowledgment. The authors acknowledge the major support given by the ISEP-IPP Institution, by the INESC TEC, to this project. This work is financed by the ERDF - European Regional Development Fund through the COMPETE Programme and by National Funds through the FCT - Portuguese Foundation for Science and Technology within project FCOMP-01-0124-FEDER-022701 and under Perception-Driven Coordinated Multi-Robot Motion Control Project with reference PTDC/EEA-CRO/100692/2008.

References

1. Mathworks - simulink,
<http://www.mathworks.com/products/simulink/>
2. Mathworks - sptool,
<http://www.mathworks.com/help/toolbox/signal/ug/f0-320.html>

3. Robocup homepage, <http://www.robocup.org/>
4. Warmerdam, T.P.H., Peijnenburg, A.T.A.: Philips cft robocup team description. In: RoboCup 2002: Robot Soccer World Cup VI (2002)
5. Cameron, D., Jahshan, D., George, D.: Mu-wallabies 2003 team description. In: Polani, D., Browning, B., Bonarini, A., Yoshida, K. (eds.) RoboCup 2003: Robot Soccer World Cup VII on CD, vol. 3020, XVI 767 p. Springer, Berlin (2003, 2004) ISBN: 3-540-22443-2
6. de Best, J., van de Molengraft, R., Steinbuch, M.: A novel ball handling mechanism for the robocup middle size league. *Mechatronics* 21(2), 469–478 (2011)
7. Dirkx, B.: Philips cft robocup team description. In: Nardi., et al. (eds.) RoboCup 2004: Robot Soccer World Cup VIII. LNCS (LNAI), vol. 3276. Springer, Berlin (2004)
8. Monteiro, J., Moutinho, I., Silva, P., Silva, V., Ribeiro, F., Braga, P.: Minho robot football team for 2003. In: Polani, D., Browning, B., Bonarini, A., Yoshida, K. (eds.) RoboCup 2003: Robot Soccer World Cup VII on CD, vol. 3020, XVI 767 p. Springer, Berlin (2003, 2004) ISBN: 3-540-22443-2
9. Janssen, R.J.M., Meessen, K.J., de Best, J.J.T.H., Bruijnen, D.J.H., Naus, G.J.L., Aangenent, W.H.T.M., van den Berg, R.B.M., van de Loo, H.C.T., Heldens, G.M., Vugts, R.P.A., Harkema, G.A., van Brakel, P.E.J., Bukkums, B.H.M., Soetens, R.P.T., Merry, R.J.E., van de Molengraft, M.J.G., Kanters, F.M.W., Hoogendijk, R.: Tech united eindhoven team description 2011 (2011), www.techunited.nl/media/files/teamdescriptionpaper2011.pdf
10. John, M., Miller, F.P., Vandome, A.F.: Dribbling. VDM Verlag Dr. Mueller e.K. (2011)
11. Hoogendijk, R.: Design of a ball handling mechanism for robocup. Master's thesis, Technische Universiteit Eindhoven (2007)
12. Dias, A., Silva, H., Almeida, C., Dias, N., Lima, L., Santos, T., Costa, I., Almeida, J., Martins, A., Silva, E.: Iseporto robotic soccer team for robocup 2010: Improving defence and dynamic passing. In: RoboCup, Istanbul (2011)
13. Nassiraei, A.A.F., Takemura, Y., Sanada, A., Kitazumi, Y., Ogawa, Y., Godler, I., Ishii, K., Miyamoto, H., Ghaderi, A.: Concept of mechatronics modular design for an autonomous mobile soccer robot. In: Proc. Int. Symp. Computational Intelligence in Robotics and Automation, CIRA 2007, pp. 178–183 (2007)
14. Pinheiro, P., Costelha, H., Neto, G., Pires, V., Arroz, M., Vecht, B., Lima, P., Custodio, L.: Isocrob 2004: Team description paper. In: Robocup (2004)
15. Bukkems, B.H.M., Kanters, F.M.W., Meessen, K.J., Willems, J.J.P.A., Merry, R.J.E., van de Molengraft, M.J.G., Aangenent, W.H.T.M., de Best, J.J.T.H.: Tech united eindhoven team description 2009 (2009), <http://www.techunited.nl/media/files/teamdescriptionpaper2009.pdf>