

Biologically inspired adaptive walking of a quadruped robot

BY HIROSHI KIMURA^{1,*}, YASUHIRO FUKUOKA¹ AND AVIS H. COHEN²

¹*Graduate School of Information Systems, University of Electro-Communications, 1-5-1, Chofugaoka, Chofu-shi, Tokyo 182-8585, Japan*

²*Department of Biology, and Institute for Systems Research, University of Maryland, College Park, MD 20742, USA*

We describe here the efforts to induce a quadruped robot to walk with medium-walking speed on irregular terrain based on biological concepts. We propose the necessary conditions for stable dynamic walking on irregular terrain in general, and we design the mechanical and the neural systems by comparing biological concepts with those necessary conditions described in physical terms. PD-controller at joints constructs the virtual spring–damper system as the viscoelasticity model of a muscle. The neural system model consists of a central pattern generator (CPG), reflexes and responses. We validate the effectiveness of the proposed neural system model control using the quadruped robots called ‘Tekken1&2’. MPEG footage of experiments can be seen at <http://www.kimura.is.uec.ac.jp>.

Keywords: adaptive walking; quadruped robot; neural system model; central pattern generator; reflexes and responses; irregular terrain

1. Introduction

Many previous studies of legged robots have been performed, including studies on running and dynamic walking on irregular terrain. However, most of those studies assumed that the structure of the terrain was known, even though the height of the step or the inclination of the slope was unknown. The purpose of this study is to realize high-speed mobility on irregular terrain with less knowledge using a mammal-like quadruped robot, the dynamic walking of which is less stable than that of hexapod robots, by referring to the well-known abilities of animals to autonomously adapt to their environment.

As many biological studies of motion control progressed, it has become generally accepted that animals’ walking is mainly generated at the spinal cord by a combination of a central pattern generator (CPG) and reflexes receiving adjustment signals from a cerebrum, cerebellum and brain stem (Orlovsky *et al.* 1999). A great deal of the previous research on this attempted to generate

* Author for correspondence (hiroshi@kimura.is.uec.ac.jp).

One contribution of 15 to a Theme Issue ‘Walking machines’.

Table 1. Legged locomotion control schemes and methods.

		limit cycle based	
ZMP based		by neural system (CPG and reflexes)	by mechanism (spring and damper)
good for control of	posture and low speed walking	medium speed walking	high speed running
main controller	upper neural system acquired by learning	lower neural system (at spinal cord, brain stem, etc.)	musculoskeletal system through self-stabilization
methods	(i), (ii)	(i), (ii), (iii)	(ii), (iii)

walking using a neural system model, including studies on dynamic walking in simulation (Taga *et al.* 1991; Ijspeert 2001; Tomita & Yano 2003) and real robots (Ilg *et al.* 1999; Kimura *et al.* 1999; Tsujita *et al.* 2001; Lewis *et al.* 2003). But autonomously adaptive dynamic walking on irregular terrain was rarely realized in those earlier studies except for our studies using quadruped robots called ‘Patrush’ (Kimura *et al.* 1999, 2001) and ‘Tekken1’ (Fukuoka *et al.* 2003). This paper reports on our progress using a self-contained (power autonomous) quadruped robot called ‘Tekken2’, which was newly developed for adaptive walking on irregular terrain in outdoor environment.

2. Design concepts for adaptive walking

(a) Legged locomotion control schemes

The schemes for legged locomotion control are classified into ZMP-based control and limit-cycle-based control (table 1). Zero moment point (ZMP) is the extension of the centre of gravity considering inertia force and so on. It was shown that ZMP-based control is effective for controlling posture and low-speed walking of a biped and a quadruped. However, ZMP-based control is not good for medium- or high-speed walking from the standpoint of energy consumption, since a body with a large mass needs to be accelerated and decelerated by actuators in every step cycle.

In contrast, motion generated by the limit-cycle-based control has superior energy efficiency; but there exists the upper bound of the period of the walking cycle, in which stable dynamic walking can be realized (Kimura *et al.* 1990). It should be noted that control by a neural system consisting of CPGs and reflexes is dominant for various kinds of adjustments in medium-speed walking of animals (Orlovsky *et al.* 1999). Full & Koditschek (1999) also pointed out that, in high-speed running, kinetic energy is dominant, and self-stabilization by a mechanism with a spring and a damper is more important than adjustments by the neural system. Our study is aimed at medium-speed walking controlled by neural system consisting of CPGs and reflexes (table 1).

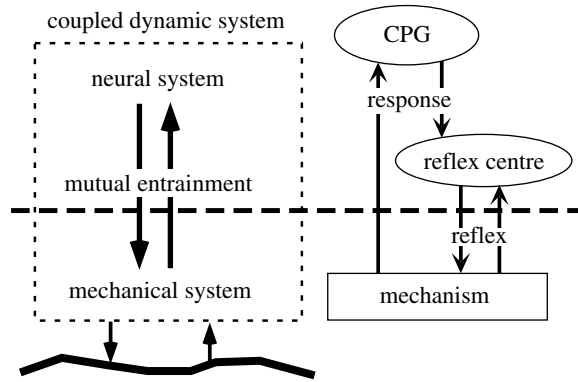

Figure 1. Motion generation in a biological system.

(b) *Legged locomotion control methods*

Jindrich & Full (2002) mentioned that two general methods are available to maintain stability during legged locomotion. Those are:

- (i) adjustment of joint torques within a single step cycle and
- (ii) adjustment of initial conditions of the legs at the transition from swing to stance.

We would like to add a third method:

- (iii) adjustment of phases (stance or swing) of the legs.

The method (ii) involves the adjustment of touchdown angle (stepping reflex) of a swinging leg (Miura & Shimoyama 1984; Townsend 1985; Raibert 1986; Bauby & Kuo 2000) and the switching of leg stiffness between stance and swing phases (Raibert 1986; Kimura *et al.* 1990; Taga *et al.* 1991; Fukuoka *et al.* 2003). Since the running speed can be stabilized using the constant touchdown angle, self-stabilization (Blickhan 1989; Full & Koditschek 1999; Cham *et al.* 2004; Poulakakis *et al.* 2005) at musculoskeleton is also involved in (ii). As the examples of the method (iii), we employed a ‘response’ as modulation of the CPG phase as described in §2e. Cham *et al.* (2004) also used the method (iii) for stabilizing the running speed of a hexapod on irregular terrain.

Of course, those three methods are not completely independent. For example, the method (iii) becomes much effective when the switching of leg stiffness between stance and swing phases is employed. The control methods mostly used in each scheme described in §2a are shown in table 1.

(c) *Mutual entrainment between neural system and mechanical system*

Motion generation based on the neural system model is shown in figure 1, where a neural system and a mechanical system have their own nonlinear dynamics. The characteristic of this method is that there is no adaptation through motion planning. These two dynamic systems are coupled to each other, generating motion by interacting with the environment emergingly and adaptively (Taga *et al.* 1991). We call this method ‘coupled dynamics-based motion generation’.

The coupled dynamic system can induce autonomous adaptation according to its own dynamics, under changes in the environment (e.g. adaptive walking on irregular terrain) and adjustment of the neural system parameters by an upper level controller (e.g. gait transition in change of walking speed). Therefore, we can avoid such serious problems in robotics as modelling of mechanical system and environment, autonomous planning, conflict between planned motion and actual motion and so on.

(d) *Necessary conditions for stable dynamic walking on irregular terrain*

We propose the necessary conditions to keep the limit cycle for stable dynamic walking on irregular terrain¹, which can be itemized in physical terms:

- (i) the period of the walking cycle should be shorter enough than the upper bound of it, in which stable dynamic walking can be realized,
- (ii) the swinging legs should be free to move forward during the first period of the swing phase,
- (iii) the swinging legs should land reliably on the ground during the second period of the swing phase,
- (iv) the angular momentum of the robot during its pitching motion or rolling motion around the contact points should be kept constant at the moment of landing or leaving of legs,
- (v) the phase difference between rolling motion of the body and pitching motion of legs should be maintained regardless of a disturbance from irregular terrain, and
- (vi) the phase differences between the legs should be maintained regardless of delay in the pitching motion of a leg receiving a disturbance from irregular terrain.

We design the neural system for these necessary conditions to be satisfied in order to realize adaptive walking.

(e) *Design of neural system*

We construct the neural system centring a neural oscillator as a model of a CPG, since the exchange between the swing and stance phases in the short-term and the quick adjustment of these phases on irregular terrain are essential in the dynamic walking of a quadruped, where the unstable two-legged stance phase appears. On the other hand, the gait pattern generator proposed by [Cruse \(1990\)](#) referring to a stick insect is more sensor-dependent and more decentralized by using a non-oscillator type CPG. The characteristics of our neural system in comparison with the one proposed by [Cruse \(1990\)](#) are as follows.

- (i) The cyclic period is mainly determined by the time constant of CPGs. This makes it easy for the necessary condition (i) described in §2d to be satisfied.
- (ii) The gait is mainly determined by the connecting weights of the CPGs network.

¹ When one of those conditions is not satisfied, walking motion is much away from the limit cycle and the robot may fall down at its worst.

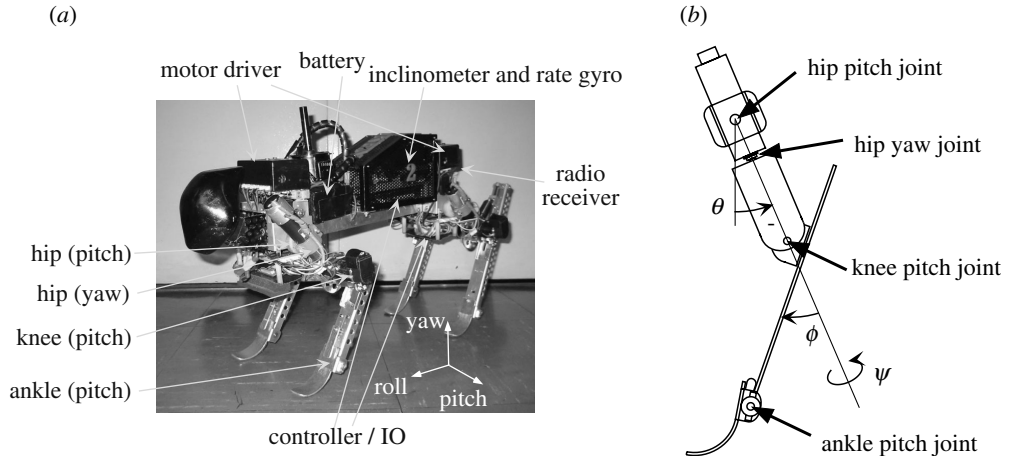

Figure 2. Self-contained quadruped robot: (a) Tekken2 and (b) joints of a leg. Tekken2 has the same configuration as Tekken1. The length of the body and a leg in standing are 30 and 25 cm. The weight including batteries is 4.3 kg. The hip pitch joint, knee pitch joint and hip yaw joint are activated by DC motors of 23, 23 and 8 W through gear ratio of 20, 28 and 18, respectively. The ankle joint is passive with spring-lock mechanism (Fukuoka *et al.* 2003). The walking direction can be changed by using the hip yaw joints. Two rate gyros and two inclinometers are mounted on the body in order to measure the body pitch and roll angles.

- (iii) As sensor feedback for adaptation on irregular terrain, a ‘response’ directly and quickly modulating the CPG phase is employed in parallel with a ‘reflex’ directly generating joint torque (figure 1).

About the characteristic (iii), it is well known in physiology that ‘some sensory stimuli modify CPG activity and reflexive responses to sensory stimuli are phase dependent under CPG activity’ (Cohen & Boothe 1999). Such interaction between CPG activity and a sensory stimulus is very important for adaptation, and corresponds to the necessary conditions described in physical terms in §2*d*.

(f) Design of mechanical system

In order to obtain appropriate mutual entrainment between neural and mechanical systems, mechanical systems should be well designed to have good dynamic properties. In addition, the performance of dynamic walking such as adaptability on irregular terrain, energy efficiency, maximum speed and so on, greatly depends on the mechanical design. The design concepts of Tekken1&2 (figure 2) are:

- high-power actuators and small inertia moment of legs for quick motion and response;
- small gear reduction ratio for high backdrivability to increase passive compliance of joints;
- small mass of the lowest link of legs to decrease impact force at collision; and
- small contacting area at toes to increase adaptability on irregular terrain.

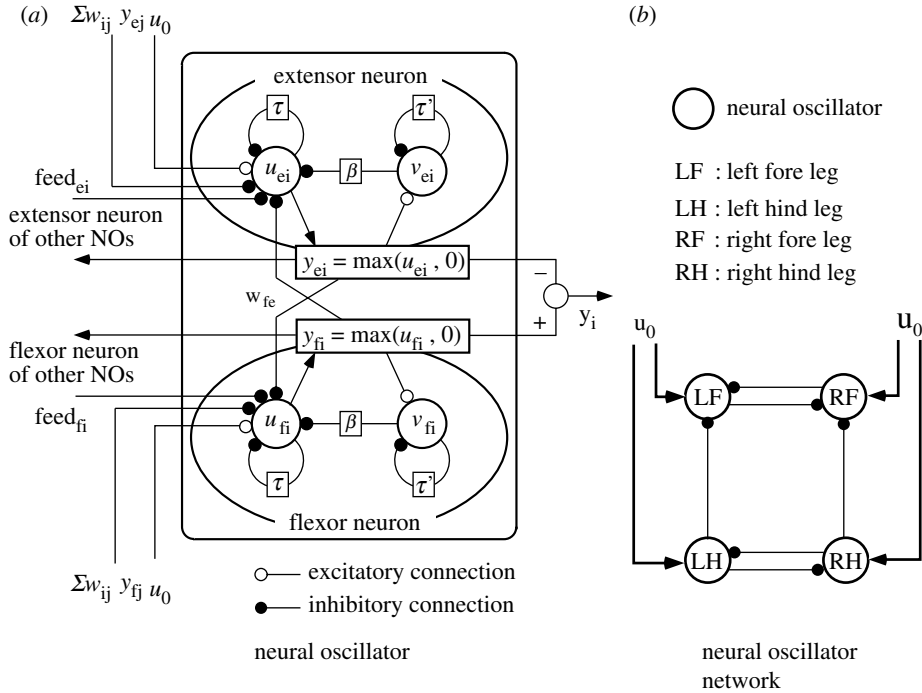

Figure 3. Neural oscillator (NO) as a model of a CPG. The suffix $i, j=1, 2, 3, 4$ corresponds to LF, LH, RF, RH. L, R, F or H means the left, right, fore or hind leg, respectively.

3. Implementation of neural system for adaptive walking

(a) Rhythmic motion by CPG

Although actual neurons as a CPG in higher animals have not yet become well known, features of a CPG have been actively studied in biology, physiology and so on. Several mathematical models were also proposed, and it was pointed out that a CPG has the capability to generate and modulate walking patterns and to be mutually entrained with a rhythmic joint motion (Taga *et al.* 1991; Cohen & Boothe 1999; Orlovsky *et al.* 1999). As a model of a CPG, we used a neural oscillator proposed by Matsuoka (1987), and applied to the biped simulation by Taga *et al.* (1991). A single neural oscillator consists of two mutually inhibiting neurons (figure 3a). Each neuron in this model is represented by the following nonlinear differential equations:

$$\begin{aligned} \tau \dot{u}_{\{e,f\}i} &= -u_{\{e,f\}i} + w_{fe} y_{\{f,e\}i} - \beta v_{\{e,f\}i} + u_0 + \text{Feed}_{\{e,f\}i} + \sum_{j=1}^n w_{ij} y_{\{e,f\}j}, \\ y_{\{e,f\}i} &= \max(u_{\{e,f\}i}, 0), \\ \tau' \dot{v}_{\{e,f\}i} &= -v_{\{e,f\}i} + y_{\{e,f\}i}, \end{aligned} \quad (3.1)$$

where the suffixes e, f and i mean an extensor neuron, a flexor neuron and the i th neural oscillator, respectively. $u_{\{e,f\}i}$ is u_{ei} or u_{fi} , i.e. the inner state of an extensor neuron or a flexor neuron of the i th neural oscillator; $v_{\{e,f\}i}$ is a variable representing the degree of the self-inhibition effect of the neuron; y_{ei} and y_{fi} are the output of

extensor and flexor neurons; u_0 is an external input with a constant rate; $\text{Feed}_{\{e,f\}i}$ is a feedback signal from the robot, i.e. a joint angle, angular velocity and so on; and β is a constant representing the degree of the self-inhibition influence on the inner state. The quantities τ and τ' are the time constants of $u_{\{e,f\}i}$ and $v_{\{e,f\}i}$; w_{fe} is a connecting weight between flexor and extensor neurons; w_{ij} is a connecting weight between neurons of the i th and j th neural oscillator.

In figure 3a, the output of a CPG is a phase signal, y_i :

$$y_i = -y_{ei} + y_{fi}. \quad (3.2)$$

The positive or negative value of y_i corresponds to the activity of a flexor or extensor neuron, respectively. The output of a CPG: y_i while walking on flat floor is shown in figure 12.

We use the following hip-joint angle feedback as a basic sensory input to a CPG called a ‘tonic stretch response’ in all the experiments of this study. This negative feedback makes a CPG be entrained with a rhythmic hip joint motion.

$$\text{Feed}_{e\cdot\text{tsr}} = k_{\text{tsr}}(\theta - \theta_0), \quad \text{Feed}_{f\cdot\text{tsr}} = -\text{Feed}_{e\cdot\text{tsr}}, \quad (3.3)$$

$$\text{Feed}_{\{e,f\}} = \text{Feed}_{\{e,f\}\cdot\text{tsr}}, \quad (3.4)$$

where θ is the measured hip joint angle, θ_0 the origin of the hip joint angle in standing and k_{tsr} the feedback gain. We eliminate the suffix i when we consider a single neural oscillator.

By connecting the CPG of each leg (figure 3b), CPGs are mutually entrained and oscillate in the same period and with a fixed phase difference. This mutual entrainment between the CPGs of the legs results in a gait. The gait is a walking pattern, and can be defined by phase differences between the legs during their pitching motion. The typical symmetric gaits are a trot and a pace. The diagonal and lateral legs are paired and move together in a trot and a pace gaits, respectively. A walk gait is the transversal gait between the trot and pace gaits. We used a trot gait for most of the experiments. But the autonomous gait transition in changing walking speed was discussed in our former study (Fukuoka *et al.* 2003).

(b) Virtual spring-damper system

We employ the model of the muscle stiffness, which is generated by the stretch reflex and variable according to the stance/swing phases, adjusted by the neural system. The muscle stiffness is high in a stance phase for supporting a body against the gravity and low in a swing phase for compliance against the disturbance (Akazawa *et al.* 1982). All the joints of Tekken are proportional and derivative (PD) controlled to move to their desired angles in each of the three states (A, B, C) in figure 4 in order to generate each motion, such as swinging up (A), swinging forward (B) and pulling down/back of a supporting leg (C). The timing for all joints of a leg to switch to the next state are:

- A \rightarrow B: when the hip joint of the leg reaches the desired angle of the state (A);
- B \rightarrow C: when the CPG extensor neuron of the leg becomes active ($y_i \leq 0$); and
- C \rightarrow A: when the CPG flexor neuron of the leg becomes active ($y_i > 0$).

The desired angles and P-gain of each joint in each state are shown in table 2, where constant values of the desired joint angles and constant P-gains were determined through experiments. Since Tekken has high backdrivability with small

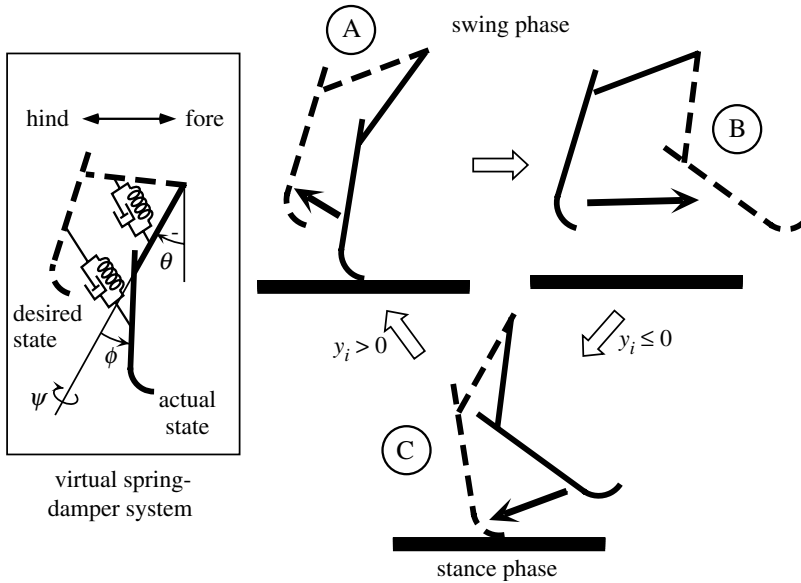

Figure 4. State transition in the virtual spring–damper system. The desired joint angles in each state are shown by the broken lines.

Table 2. Desired value of the joint angles and P-gains at the joints used in the PD-controller for the virtual spring–damper system in each state shown in figure 4. θ , ϕ and ψ are the hip pitch joint angle, the knee pitch joint angle and the hip yaw joint angle, respectively. $\theta_{C \rightarrow A}$: the hip joint angle measured at the instance when the state changes from (C) to (A). θ_{stance} : variable to change the walking speed. Body pitch angle: the measured pitching angle of the body used for the vestibulospinal reflex. * means that the desired angle is calculated on-line for the height from the toe to the hip joint to be constant. v (m s^{-1}): the measured walking speed of Tekken.

angle in state	P control	
	desired value (rad)	P-gain
θ in A	$1.2\theta_{C \rightarrow A}$	G_1
θ in B	-0.17	$G_2v + G_3$
θ in C	$\theta_{stance} + \text{body pitch angle}$	$-G_4v + G_5$
ϕ in A and B	*	G_6
ϕ in C	0.61	G_7
ψ in all states	0	G_8

gear ratio in each joint, PD-controller can construct the virtual spring–damper system with relatively low stiffness coupled with the mechanical system. Such compliant joints of legs can improve the passive adaptability on irregular terrain.

(c) CPGs and pitching motion of legs

The diagram of the pitching motion control consisting of CPGs and the virtual spring–damper system is shown in the middle part of figure 10. Joint torque of all the joints is determined by the PD controller, corresponding to a stretch reflex at

the α motor neuron in animals. The desired angle and P-gain of each joint is switched based on the phase of the CPG output: y_i in equation (3.2) as described in §3b. As a result of the switching of the virtual spring–damper system and the joint angle feedback signal to the CPG in equation (3.4), the CPG and the pitching motion of the leg are mutually entrained.

(d) *Reflexes and responses*

As described in §2e, we use responses for direct and quick modulation of the CPG phase and reflexes for direct and quick adjustment of joint torque. Referring to biological knowledge, we employed the several reflexes and responses (table 4, figure 10) to satisfy the necessary conditions (ii)–(v) described in physical terms in §2d in addition to the stretch reflex and response described in §3a,b. The necessary condition (vi) can be satisfied by the mutual entrainment between CPGs and the pitching motion of legs, and the mutual entrainment among CPGs (Kimura *et al.* 2001).

(i) *Flexor reflex*

The flexor reflex contributes to satisfy the necessary conditions (ii). In our former studies (Kimura *et al.* 1999, 2001), the stumble of a swinging leg on an obstacle was detected by force sensor, and the flexor reflex was activated afterwards. In Tekken, we substitute the flexor reflex for the passive ankle joint mechanism (Fukuoka *et al.* 2003) utilizing the fact that the collision with a forward obstacle occurs in the first half of a swing phase.

(ii) *Vestibulospinal reflex and response for pitching*

About posture control, it is known in physiology (Ogawa *et al.* 1998) that when the vestibule in a head detects an inclination in pitch or roll plane, a downward-inclined leg is extended while an upward-inclined leg is flexed (figure 5). We call this a ‘vestibulospinal reflex.’

We call the reflex/response for an inclination in the pitch plane a ‘vestibulospinal reflex/response for pitching’, the role of which corresponds to the necessary conditions (iv) and (vi). In Tekken, hip joint torque in the stance phase is adjusted by the vestibulospinal reflex (figure 5a), since the body pitch angle is added to θ_{stance} in table 2. For the vestibulospinal response, the following equations are used rather than equations (3.3) and (3.4):

$$\theta_{\text{vsr}} = \theta - (\text{body pitch angle}) \quad \text{Feed}_{\{e,f\} \cdot \text{tsr} \cdot \text{vsr}} = \pm k_{\text{tsr}} (\theta_{\text{vsr}} - \theta_0), \quad (3.5)$$

$$\text{Feed}_{\{e,f\}} = \text{Feed}_{\{e,f\} \cdot \text{tsr} \cdot \text{vsr}}. \quad (3.6)$$

(iii) *Vestibulospinal response for rolling*

We call the response for an inclination in the roll plane a ‘tonic labyrinthine response’². The tonic labyrinthine response (TLRS) is employed as rolling motion feedback to CPGs (upper left part of figure 10). In Tekken, we made the body roll angle be given as input to the CPGs as a feedback signal expressed by

²The ‘tonic labyrinthine reflex’ is defined in Ogawa *et al.* (1998). The same reflex is called ‘vestibular reflex’ in Ghez (1991).

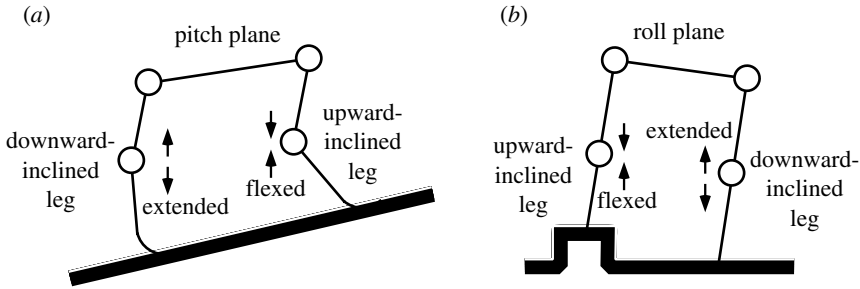

Figure 5. Downward-inclined and upward-inclined legs.

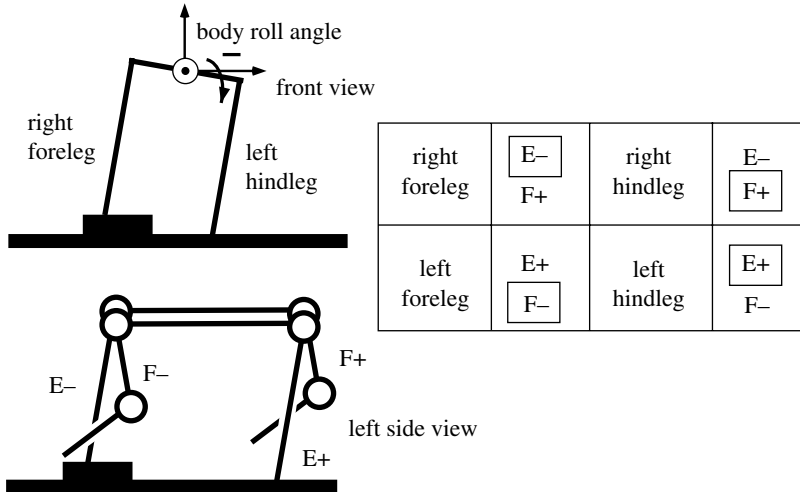

Figure 6. A tonic labyrinthine response for rolling when the right foreleg lands on a bump in a trot gait. E or F means the extensor or flexor neuron of a CPG, respectively. ‘+’ or ‘-’ means the activity of the neuron is increased or decreased by $\text{Feed}_{\{e, f\}\cdot\text{tlrs}}$, respectively.

equations (3.7) and (3.8)

$$\begin{aligned} \text{Feed}_{e\cdot\text{tlrs}} &= \delta(\text{leg})k_{\text{tlrs}} \times (\text{body roll angle}), \\ \text{Feed}_{f\cdot\text{tlrs}} &= -\text{Feed}_{e\cdot\text{tlrs}}, \end{aligned} \tag{3.7}$$

$$\delta(\text{leg}) = \begin{cases} 1, & \text{if leg is a right leg,} \\ -1, & \text{otherwise,} \end{cases}$$

$$\begin{aligned} \text{Feed}_e &= \text{Feed}_{e\cdot\text{tsr}\cdot\text{vsr}} + \text{Feed}_{e\cdot\text{tlrs}} \\ \text{Feed}_f &= \text{Feed}_{f\cdot\text{tsr}\cdot\text{vsr}} + \text{Feed}_{f\cdot\text{tlrs}}. \end{aligned} \tag{3.8}$$

The rolling motion feedback to CPGs, equations (3.7) and (3.8), contributes to an appropriate adjustment of the periods of the stance and swing phases while walking on irregular terrain (figure 6; Fukuoka *et al.* 2003). It helps the necessary conditions (iii) and (iv) be satisfied.

The rolling motion feedback to CPGs is important also in order to satisfy the necessary condition (v). CPGs, the pitching motions of the legs and the rolling motion of the body are mutually entrained through the rolling motion

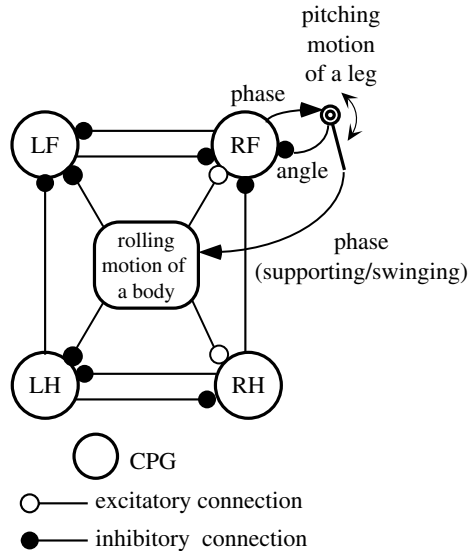

Figure 7. Relation among CPGs, pitching motion of a leg and rolling motion of a body.

feedback to CPGs (figure 7). This means that the rolling motion can be the standard oscillation for whole oscillations, in order to compensate for the weak connection between the fore and hind legs in the CPG network (figure 3b). As a result, the phase difference between the fore and hind legs is fixed and the gait becomes stable.

(iv) *Sideway stepping reflex to stabilize rolling motion*

It is known that the adjustment of the sideway touchdown angle of a swinging leg is effective in stabilizing rolling motion against disturbances (Miura & Shimoyama 1984; Bauby & Kuo 2000). We call this a ‘sideway stepping reflex’, which helps to satisfy the necessary condition (iv) during rolling motion. The sideway stepping reflex is effective also in walking on a sideway inclined slope.

For example, when Tekken walks on a right-inclined slope (figure 8) it can continue to walk while keeping the phase differences between left and right legs with the help of the tonic labyrinthine response. But Tekken cannot walk straight and shifts its walking direction to the right owing to the difference of the gravity load between left and right legs. In addition, Tekken typically falls down to the right for the perturbation from the left in the case of figure 8a, since the wide stability margin: WSM^3 is small. The sideway stepping reflex helps to stabilize the walking direction and prevent the robot from falling down while keeping WSM large on such sideway inclined slope (figure 8b).

Since Tekken has no joint round the roll axis, the sideway stepping reflex is implemented as changing the desired angle of the hip yaw joint from 0 (table 2)

³The shortest distance from the projected point of the centre of gravity to the edges of the polygon constructed by the projected points of legs independent of their stance or swing phases (Fukuoka *et al.* 2003).

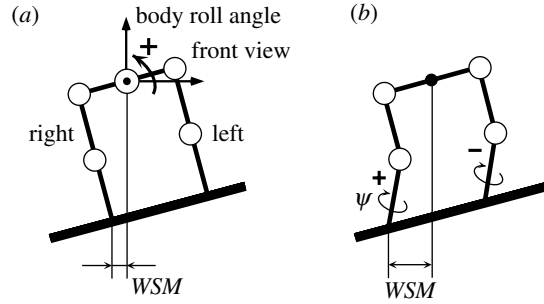

Figure 8. Walking on a sideway inclined slope. (a) Without a sideways stepping reflex and (b) with it.

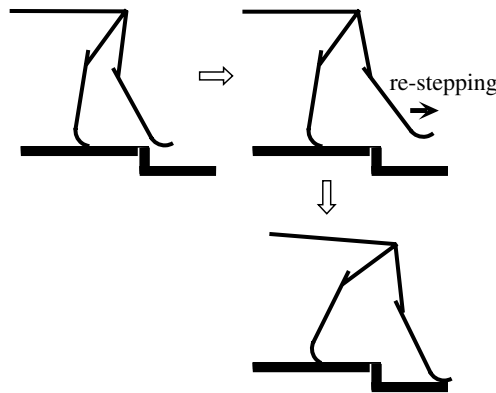

Figure 9. Re-stepping reflex and response.

to ψ^* according to equation (3.9),

$$\psi^* = \delta(\text{leg}) k_{\text{stpr}} \times (\text{body roll angle}). \tag{3.9}$$

(v) *Re-stepping reflex and response for walking down a step*

When loss of ground contact is detected in a swing phase while walking over a ditch, a cat activates re-stepping to extend the swing phase and make the leg land on the more forward position (Hiebert et al. 1994). We call this ‘re-stepping reflex/response’, which is effective for the necessary conditions (iii) and (iv) to be satisfied also in walking down a large step (figure 9).

(e) *Active landing control on the soft ground*

While walking on the soft ground, the rolling motion is much disturbed since it takes longer to establish the reliable landing of the swinging legs. Tekken changes the state of the virtual spring–damper system from the swinging to the stance before the actual contact of a leg on the ground, when the output phase of a CPG changes from the flexor neuron active phase to the extensor neuron active phase ($y_i \leq 0$) as described in §3b. This control

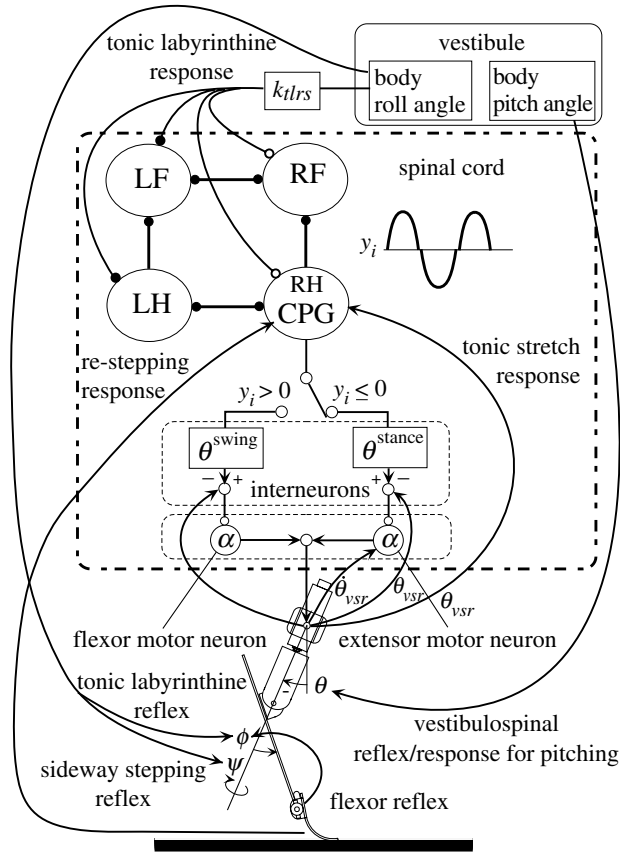

Figure 10. Control diagram for Tekken1&2. PD-control at the hip yaw and knee pitch joints are eliminated in this figure.

contributes to obtain the reliable landing of the swinging legs as soon as possible, and helps the necessary condition (iii) be satisfied.

4. Experiments

The control diagram for Tekken1&2 is shown in figure 10. Values of all parameters in the neural system including the virtual spring–damper system except for θ_{stance} were determined experimentally. But it should be noted that values of all parameters for Tekken1 (Fukuoka *et al.* 2003) or 2 (table 3) were constant in the following experiments independent of terrain. The sensitivity and robustness of those parameters were discussed in our former study (Fukuoka *et al.* 2003).

(a) Indoor experiments

We made Tekken1 walk on flat floor while changing the walking speed in relating to §3d(iii). In figure 12, when θ_{stance} was changed at 3.5 s, Tekken1 increased its walking speed from 0.3 to 0.5 m s⁻¹. We can see that the cyclic period of walking was decreased from 0.64 to 0.48 s while τ is constant, and the

Table 3. Values of the parameters used in experiments using Tekken2.

parameters	value
u_0	1.0
τ	0.04
τ'	0.6
β	3.0
w_{fe}	-2.0
$W_{\{13,31,24,42\}}$	-2.0
$W_{\{12,34\}}$	0
$W_{\{21,43\}}$	-0.57
$k_{tsr}(\text{rad}^{-1})$	3.0
$k_{tlrs}(\text{rad}^{-1})$	2.25
k_{stpr}	0.5
$\theta_0(\text{rad})$	-1.06
$G_1(\text{Nm rad}^{-1})$	7.0
$G_2(\text{Nm rad}^{-1})$	0.6
$G_3(\text{Nm rad}^{-1})$	0.6
$G_4(\text{Nm rad}^{-1})$	1.0
$G_5(\text{Nm rad}^{-1})$	2.0
$G_6(\text{Nm rad}^{-1})$	7.0
$G_7(\text{Nm rad}^{-1})$	2.6
$G_8(\text{Nm rad}^{-1})$	2.0

amplitude of the rolling motion became much smaller after 3.5 s. In addition, we can see especially in the first half that CPG output and rolling motion of the body were mutually entrained.

We made Tekken1 walk over several types of irregular terrain in indoor environment (Fukuoka *et al.* 2003). Tekken1 walked over an obstacle 4 cm in height while stumbling and landing on the obstacle (figure 11*a*). Tekken1 walked up and down a slope of 10° in the forward direction (figure 11*b*), walked over sideways inclined slopes of 3° and 5° (figure 11*c*), and walked over pebbles (figure 11*d*).

Tekken1 successfully walked down a large step with *ca* 0.5 m s^{-1} speed using the re-stepping reflex/response. In figure 13, a re-stepping response was activated when the contact of the right fore leg had not been detected for 0.14 s after the activity of the flexor neuron became 0. Without the re-stepping reflex/response, Tekken1 typically fell down forward because fore legs landed on the more backward position excessively and could not depress the increased forward speed.

(b) Outdoor experiments

Even on a paved road in outdoor environment, there exist a slope of 3° at most, bumps of 1 cm in height and small pebbles everywhere. With all responses and reflexes (table 4) described in §3*d*, Tekken2 successfully maintained a stable gait on the paved road for 4 min with *ca* 0.5 m s^{-1} speed while changing its walking speed and direction by receiving the operation commands from the radio controller (figure 14*a*). In addition, the effectiveness

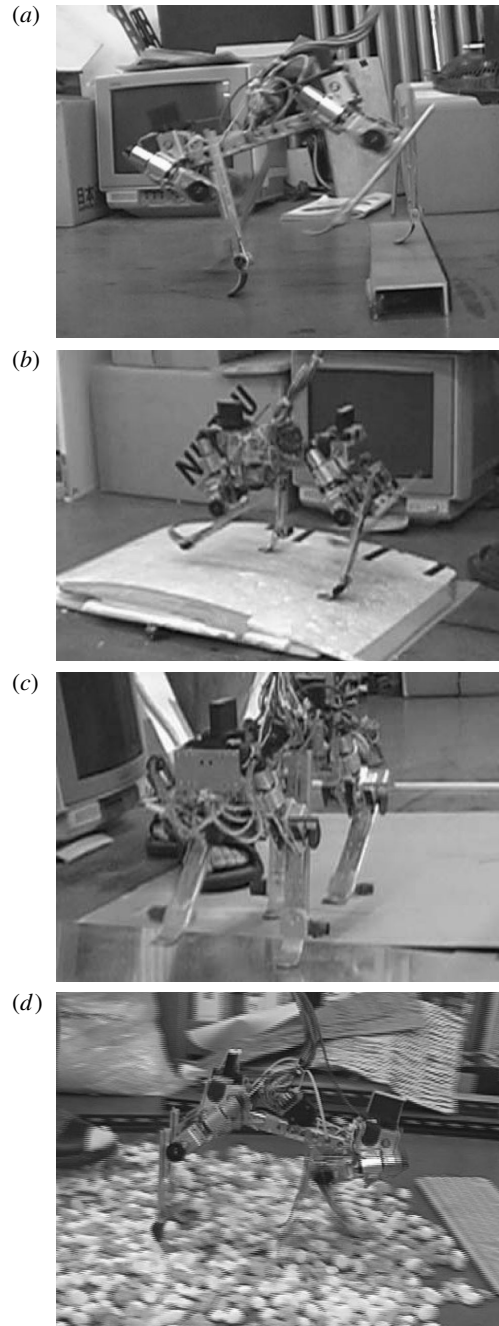

Figure 11. Tekken1 is walking over irregular terrain.

of the active landing control on the soft ground was confirmed by the successful experiment of walking on the natural ground with scattered pebbles and grasses (figure 14b).

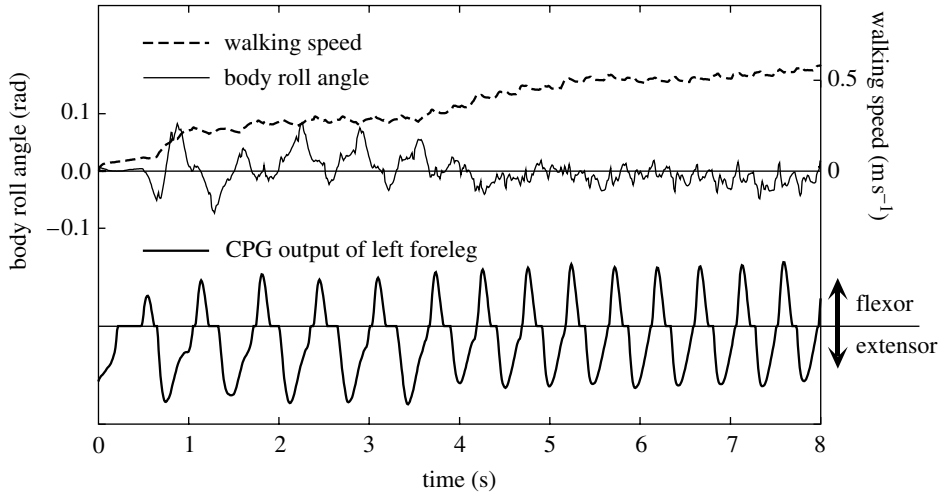

Figure 12. The result of the experiment of changing walking speed. θ_{stance} was changed from -0.7 to -0.8 rad at $t=3.5$ s.

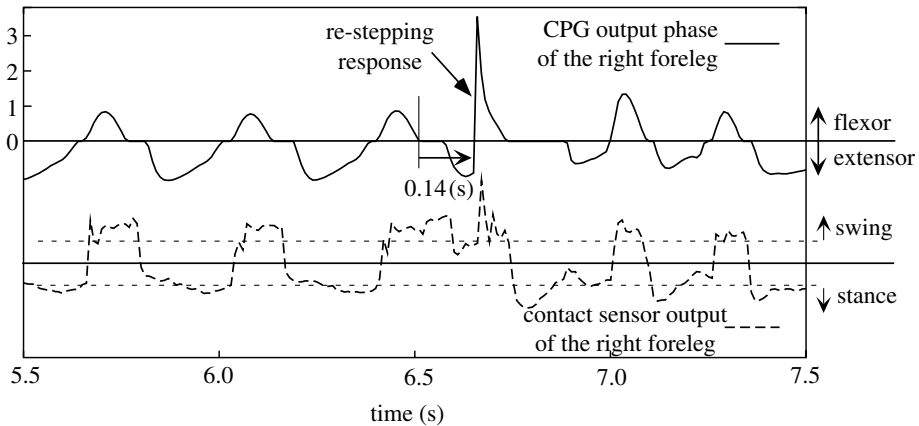

Figure 13. Walking down a step of 7 cm in height with a re-stepping reflex/response.

5. Conclusion

In this study, we designed the neural system consisting of CPGs, responses and reflexes referring to biological concepts while taking the necessary conditions for adaptive walking into account. In this neural system model, the relationships among CPGs, sensory input, reflexes and the mechanical system were simply defined, and motion generation and adaptation were emergingly induced by the coupled dynamics of a neural system and a mechanical system by interacting with the environment.

In order to make the self-contained quadruped robot walk in outdoor natural environment, we newly employed a sideways stepping reflex, a re-stepping reflex/response and the active landing control of the swinging legs. We should

Table 4. Reflexes and responses employed on Tekken. All responses are categorized into the control method (iii) described in §2*b*. Flexor and vestibulospinal reflexes are categorized into the control method (i). Stepping, sideways stepping and re-stepping reflexes are categorized into the control method (ii). The sp and sw mean the supporting leg and swinging leg, respectively. The corresponding necessary conditions are described in §2*d*.

	sensed value or event	activated on	necessary conditions
flexor reflex	collision with obstacle	sw	(ii)
stepping reflex	forward speed	sw	(iv)
vestibulospinal reflex/response	body pitch angle	sp	(iv)
tonic labyrinthine response	body roll angle	sp&sw	(iii), (iv), (v)
sideways stepping reflex	body roll angle	sw	(iv)
re-stepping reflex/response	loss of ground contact	sw	(iv)

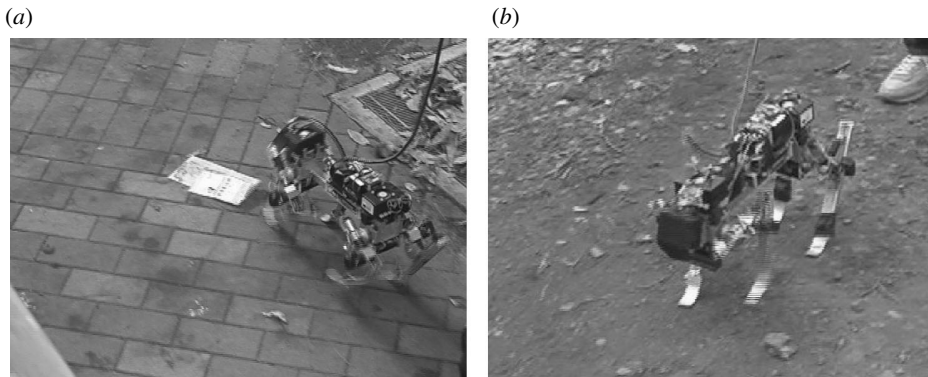

Figure 14. Photos of walking of Tekken2 on (a) paved road and (b) natural ground. The cable is just to prevent Tekken2 from damage in case of emergency and is usually slack.

employ additional reflexes and responses to increase the degrees of terrain irregularity which Tekken can cope with, and also navigation ability using vision.

References

- Akazawa, K., Aldridge, J. W., Steeves, J. D. & Stein, R. B. 1982 Modulation of stretch reflexes during locomotion in the mesencephalic cat. *J. Physiol.* **329**, 553–567.
- Bauby, C. E. & Kuo, A. D. 2000 Active control of lateral balance in human walking. *J. Biomech.* **33**, 1433–1440. (doi:10.1016/S0021-9290(00)00101-9)
- Blickhan, R. 1989 The spring-mass model for running and hopping. *J. Biomech.* **22**, 1217–1227. (doi:10.1016/0021-9290(89)90224-8)
- Cham, J. G., Karpick, K. J. & Cutkosky, M. R. 2004 Stride period adaptation of a biomimetic running hexapod. *Int. J. Robot. Res.* **23**, 141–153. (doi:10.1177/0278364904041323)
- Cohen, A. H. & Boothe, D. L. 1999 Sensorimotor interactions during locomotion: principles derived from biological systems. *Auton. Robots* **7**, 239–245. (doi:10.1023/A:1008920420634)

- Cruse, H. 1990 What mechanism coordinate leg movement in walking arthropods? *Trends Neurosci.* **12**, 15–21. (doi:10.1016/0166-2236(90)90057-H)
- Fukuoka, Y., Kimura, H. & Cohen, A. H. 2003 Adaptive dynamic walking of a quadruped robot on irregular terrain based on biological concepts. *Int. J. Robot. Res.* **22**, 187–202. (doi:10.1177/0278364903022003004)
- Full, R. J. & Koditschek, D. E. 1999 Templates and anchors: neuromechanical hypotheses of legged locomotion on land. *J. Exp. Biol.* **202**, 3325–3332.
- Ghez, C. 1991 Posture. In *Principles of neural science* (ed. E. R. Kandel, J. H. Schwartz & T. M. Jessell), pp. 596–607, 3rd edn. Norwalk, CT: Appleton & Lange
- Hiebert, G., Gorassini, M., Jiang, W., Prochazka, A. & Pearson, K. 1994 Corrective responses to loss of ground support during walking II, comparison of intact and chronic spinal cats. *J. Neurophys.* **71**, 611–622.
- Ijspeert, A. J. 2001 A connectionist central pattern generator for the aquatic and terrestrial gaits of a simulated salamander. *Biol. Cybern.* **84**, 331–348. (doi:10.1007/s004220000211)
- Ilg, W., Albiez, J., Jeede, H., Berns, K. & Dillmann, R. 1999 Adaptive periodic movement control for the four legged walking machine BISAM. In *Proc. ICRA, Detroit, MI, May 1999*, pp. 2354–2359.
- Jindrich, D. L. & Full, R. J. 2002 Dynamic stabilization of rapid hexapedal locomotion. *J. Exp. Biol.* **205**, 2803–2823.
- Kimura, H., Shimoyama, I. & Miura, H. 1990 Dynamics in the dynamic walk of a quadruped robot. *Adv. Robot.* **4**, 283–301.
- Kimura, H., Akiyama, S. & Sakurama, K. 1999 Realization of dynamic walking and running of the quadruped using neural oscillator. *Auton. Robots* **7**, 247–258. (doi:10.1023/A:1008924521542)
- Kimura, H., Fukuoka, Y. & Konaga, K. 2001 Adaptive dynamic walking of a quadruped robot using neural system model. *Adv. Robot.* **15**, 859–876. (doi:10.1163/156855301317198179)
- Lewis, M. A., Etienne-Cummings, R., Hartmann, M. J., Xu, Z. R. & Cohen, A. H. 2003 An *in silico* central pattern generator: silicon oscillator, coupling, entrainment, and physical computation. *Biol. Cybern.* **88**, 137–151. (doi:10.1007/s00422-002-0365-7)
- Matsuoka, K. 1987 Mechanisms of frequency and pattern control in the neural rhythm generators. *Biol. Cybern.* **56**, 345–353. (doi:10.1007/BF00319514)
- Miura, H. & Shimoyama, I. 1984 Dynamical walk of biped locomotion. *Int. J. Robot. Res.* **3**, 60–74.
- Ogawa, T., Keta, K., Hiki, Y., Motokawa, K. & Yoshida, T. (eds) 1998 *Nanzando's medical dictionary*. p. 1211, 18th edn. Tokyo, Japan: Nanzando.
- Orlovsky, G. N., Deliagina, T. G. & Grillner, S. 1999 Neural control of locomotion, part 3, pp. 155–246. New York, NY: Oxford University Press.
- Poulakakis, I., Smith, J. A. & Buehler, M. 2005 On the dynamics of bounding and extensions towards the half-bound and the gallop gaits. In *Adaptive motion of animals and machines* (ed. H. Kimura, K. Tsuchiya, A. Ishiguro & H. Witte), pp. 77–86. Tokyo, Japan: Springer.
- Raibert, M. H. 1986 *Legged robots that balance*. Cambridge, UK: MIT Press.
- Taga, G., Yamaguchi, Y. & Shimizu, H. 1991 Self-organized control of bipedal locomotion by neural oscillators. *Biol. Cybern.* **65**, 147–159. (doi:10.1007/BF00198086)
- Tomita, N. & Yano, M. 2003 A model of learning free bipedal walking in indefinite environment—constraints self-emergence/self-satisfaction paradigm-. In *Prof. SICE Annual Conf. Fukui, Japan, Aug. 2003*, pp. 3176–3181.
- Townsend, M. A. 1985 Biped gait stabilization via foot placement. *J. Biomech.* **18**, 21–38. (doi:10.1016/0021-9290(85)90042-9)
- Tsujita, K., Tsuchiya, K. & Onat, A. 2001 Adaptive gait pattern control of a quadruped locomotion robot. In *Proc. IROS, Hawaii, USA, Oct. 2001*, pp. 2318–2325.