

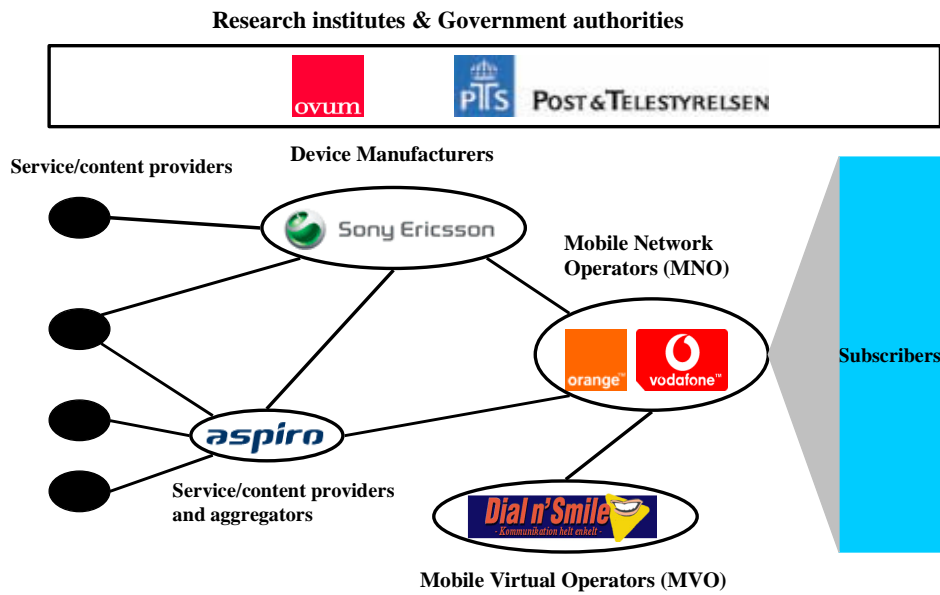

Business Models for Mobile Internet



Authors:

Tobias Andersson
Henric Talborn
Magnus Weikert

Directors:

Professor Allan T. Malm
Ph D Candidate Magnus Wide

Preface

The hours spent working with this thesis has been many and the research has been tremendously stimulating as well as it has increased our competence within the area. To get the opportunity to investigate a dynamic and unpredictable industry of great importance has been enormously interesting.

We would like to thank the respondents for their valuable contributions to this thesis. We would also like to thank Professor Allan T. Malm, for his professional and straightforward way of tutoring us.

Tobias Andersson

Henric Talborn

Magnus Weikert

Executive Summary

Title	Business Models for Mobile Internet
Authors	Andersson Tobias, Talborn Henric, Weikert Magnus
Directors	Professor Allan T. Malm Ph D Candidate Magnus Wide
Purpose	How should mobile operators design their business models for mobile Internet in order to be successful?
Method	<p>The method used in order to reach the purpose is structured in, theory, empirical and analysis around the concepts business landscape, business model and revenue model. Theories have been collected within these areas in order to create analytical tools. The empirical data was collected through semi structured interviews with actors involved in the mobile Internet industry. The analytical process was structured around these concepts followed by a correlated analysis and conclusions.</p>
Conclusions	<p>Regardless of the mobile operators choice of business models four key resources impacts the potential to succeed with mobile Internet. The brand will be important in order to attract customers. The level of skills in managing relationships with third party providers will be important in order to create incentives that facilitate the business models value creating potential. The customer base will be important for operators impacting the revenue potential, bargain power and the potential to generate valuable information. Information will be required for the operators in order to facilitate service development and to price services accurately.</p> <p>To sum up, the authors conclude that the free content business model is not the one to choose due to its weak economic logic. A good choice for global players, on markets with characteristics such as in Sweden, is the paid for content model with complementary advertising services. The intelligent facilitator business model is suitable for local network operators. The future success of the enabling platform business model depends on the degree of integration between the network operators and the platform providers. The WLAN model will be a complement to the operators' business models and make their offers more complete. And finally, the MVOs' business model will in general terms experience the same conditions as the global network operators' business models. The important issue is nonetheless the strength of their brands and the size of their customer bases.</p>
Key Words	Business Model, Business Landscape, Revenue Model, Mobile Internet, Mobile operator

PREFACE	2
1 INTRODUCTION	7
1.1 DEFINITIONS	7
1.1.1 <i>Business landscape</i>	7
1.1.2 <i>Business model</i>	8
1.1.3 <i>Revenue model</i>	8
1.2 BACKGROUND.....	9
1.2.1 <i>The evolution of the mobile Internet business landscape</i>	9
1.2.2 <i>Various definitions of the mobile Internet</i>	9
1.2.2 <i>Technological development enabling mobile Internet</i>	10
1.2.3 <i>The services on mobile Internet</i>	11
1.2.4 <i>Mobile Internet in Japan one-step ahead</i>	11
1.3 PROBLEM DISCUSSION.....	12
1.4 PROBLEM FORMULATION	14
1.5 PURPOSE	14
1.7 DISPOSITION	15
2 METHOD	16
2.1 AREA OF RESEARCH	16
2.2 RESEARCH STRATEGY	16
2.3 SELECTION OF EMPIRICAL DATA.....	17
2.3.1 <i>Industry actors</i>	18
2.3.2 <i>Experts</i>	19
2.3.3 <i>Secondary material</i>	19
2.4 CHOICE OF THEORY	19
2.5 DATA COLLECTION.....	20
2.5.1 <i>Explorative research</i>	20
2.5.2 <i>Primary data</i>	21
2.5.3 <i>Secondary data</i>	21
2.6 SOURCE CRITICISM.....	21
2.6.1 <i>Validity</i>	21
3 THEORETICAL FRAMEWORK	23
3.1 BUSINESS LANDSCAPE.....	23
3.1.1 <i>Development of the business landscape</i>	23
3. 1. 2 <i>Forces in the Business landscape</i>	25
3. 1. 3 <i>New organizational constellations</i>	27
3.2 BUSINESS MODELS AND STRATEGY	28
3.2.1 <i>Business models</i>	28
3.2.2 <i>Strategy and strategic options</i>	29
3.2.3 <i>Strategic issues within the mobile Internet industry</i>	31
3.2.4 <i>Strategy and strategic options from a network perspective</i>	31
3.2.5 <i>The Delta model</i>	32
3.3 REVENUE MODEL	34
3.3.1 <i>Valuation</i>	34
3.3.1.1 <i>Determining the basic price</i>	34
3.3.1.2 <i>Pricing products with short life cycle</i>	35
3.3.1.3 <i>Price strategies for initial price setting</i>	35
3.3.2 <i>Appropriation</i>	36
3.3.2.1 <i>Definitions and price sensitivity</i>	36
3.3.2.2 <i>Price Discrimination</i>	36
3.3.2.3 <i>Dynamic Pricing</i>	37
3.3.2.4 <i>Bundling</i>	38
3.3.2.5 <i>Two-part tariffs</i>	38
3.3.2.6 <i>Characteristics of subscriptions</i>	39
3.3.3 <i>Allocation</i>	40
3.3.3.1 <i>Oligopoly pricing</i>	40

3.3.3.2 Alliances and networks	41
3.3.3.3 Understanding the complementors.....	42
3.4 SUMMARY OF THE THEORY CHAPTER	44
3.4.1 Business landscape from player and business conditional perspective.....	44
3.4.2 Business models from a strategy and network perspective	44
3.4.3 Revenue models - Valuation, Appropriation and Allocation.....	44
4 THE MOBILE INTERNET INDUSTRY	46
4.1 BUSINESS LANDSCAPE.....	46
4.1.1 Market characteristics.....	46
4.1.2 Different environmental aspects.....	46
4.1.3 Change of mindset.....	47
4.1.4 Forces.....	47
4.1.5 New organisational constellations and the industry actors	49
4.1.5.1 Network access provider.....	49
4.1.5.2 Device manufacturer	50
4.1.5.3 Merchants	50
4.1.5.4 Platform and application providers	50
4.1.5.5 Content providers.....	50
4.1.5.6 Portal provider	50
4.2 BUSINESS MODELS	51
4.2.1 The paid for content business model	51
4.2.2 The free content business model.....	52
4.2.3 The intelligent facilitator business model.....	54
4.2.4 The MVO business model.....	55
4.2.5 The enabling platform business model	56
4.2.6 The WLAN business model	57
4.2.7 Content.....	58
4.2.7.1 Customer information	58
4.2.7.2 Services and value migration	58
4.2.8 Structure.....	59
4.2.9 Governance	60
4.2.10 Strategy and economic logic	60
4.2.10.1 Strategic issues.....	60
4.3 REVENUE MODELS	61
4.3.1 Valuation.....	61
4.3.2 Appropriation.....	62
4.3.2.1 Models for charging.....	62
4.3.2.2 Services and the corresponding value carriers	63
4.3.2.3 Technological value carriers	63
4.3.2.4 How to bill?	64
4.3.3 Allocation.....	65
4.3.4 Technological development - Billing & Data Service Systems.....	66
5 ANALYSIS	68
5.1 BUSINESS LANDSCAPE.....	69
5.1.1 Conditions within the mobile Internet business landscape.....	69
5.1.1.1 The mobile operator as prime mover	69
5.1.1.2 The business landscape influencing the choice of business model.....	70
5.1.2 Forces impacting the actors in the business landscape.....	70
5.1.3 Specialisation within the business landscape.....	72
5.2 BUSINESS MODELS FOR MOBILE INTERNET	73
5.2.1 The paid for content business model	73
5.2.2 The free content business model.....	75
5.2.3 The intelligent facilitator business model.....	77
5.2.4 The MVO business model.....	78
5.2.5 The enabling platform business model	79
5.2.6 The Wireless Local Area Network (WLAN) Business model.....	80
5.2.7 Competitive advantage and strategic options for mobile operators.....	81
5.2.8 Drivers for internationalisation	82
5.2.9 Managing relationships and strategic options with in the network.....	83
5.2.9.1 Identifying and managing relationships	83

5.2.10 <i>The Strategic logic from best product towards system lock-in</i>	85
5.3 REVENUE MODELS	86
5.3.1 <i>Valuation</i>	86
5.3.1.1 Determining the price of mobile Internet services	86
5.3.1.2 Initial price strategies for mobile Internet services	87
5.3.2 <i>Appropriation</i>	88
5.3.2.1 Price discrimination	88
5.3.2.2 Dynamic pricing a new charging opportunity	89
5.3.2.3 Bundling increases the appropriation potential	90
5.3.2.4 Two- part tariffs and subscriptions.....	90
5.3.2.5 Future appropriation issues for mobile Internet services.....	91
5.3.3 <i>Allocation</i>	92
5.3.3.1 Oligopoly situation between mobile network operators.....	92
5.3.3.2 Alliances and networks from an allocation perspective	92
5.2 CORRELATED ANALYSIS.....	94
5.2.1 <i>How does the business landscape influence the possible business models for mobile Internet?</i>	94
5.4.2 <i>How do the revenue models influence the possible business models for mobile Internet?</i>	95
5.4.3 <i>What will be important for operators in order to create value within the possible business models for mobile Internet?</i>	96
6 CONCLUSIONS	98
7 BIBLIOGRAPHY	101
7.1 PUBLISHED SOURCES.....	101
7.3 ELECTRONIC SOURCES	103
7.4 ORAL SOURCES.....	104
7.4.1 <i>Personal Interviews</i>	104
7.4.2 <i>Telephone Interviews</i>	104
7.5 <i>Other</i>	104
APPENDIX – A	105
INTERVIEW TEMPLATE	105
<i>Introduction</i>	105
<i>Start up</i>	105
<i>Business Landscape</i>	105
<i>Business Models & Strategy</i>	105
<i>Revenue Models</i>	106
<i>Future Development and Concerns</i>	106

1 Introduction

First we present a brief background to the current problems within the mobile Internet industry from a layman's point of view. In order to provide an understanding of the research area, the introduction presents definitions of three central concepts. Then environmental development and the related forces are presented. These forces have contributed in the creation of mobile Internet. In the problem discussion the issues that need to be solved are highlighted and the following subsection contains the purpose of this thesis. Finally the disposition is described.

Many European citizens have probably heard about 3G and the future services that will be made possible using a mobile telephone. Watching TV and e-mailing are just only two of the many services that are predicted to be enabled in the future. When asking the greatest optimists, the possibilities for mobile Internet seem to be almost unlimited. The major change and development is caused by the technological development in the area of digital communication.

However, at present there are also negative issues concerning the mobile Internet. The launch of the 3G systems is far behind schedule just like the industry as a whole. The issue of how the industry will make the consumers willing to at least double their bills for mobile telecommunication is often highlighted. The question is raised since the heavy investments in new technology need to be covered. Stressed by their pressing debt situations, the mobile network operators seem to be hesitant in their marketing development efforts. There seem to be a lack of knowledge about how to make the consumers pay. There also seem to be hesitations concerning the business models. The operators have not yet decided whether to accept support from other actors or whether to try to do everything by themselves. One thing we do know is that something must happen within the near future to enable the mobile operators to survive in the long term.

1.1 Definitions

In this section we provide definitions of the three concepts *business landscape*, *business model* and *revenue model*. The three concepts are presented as early as in the introduction, because of their central role in this thesis. The definitions of the concepts are needed in order for the reader to understand the problem formulation and the purpose of this thesis. Furthermore, these concepts create the foundation of the theoretical and empirical chapters as well as the framework for the analysis.

1.1.1 Business landscape

Business landscape refers to the environment in which the business model is supposed to create value. There are no distinct boundaries to the business landscape. Its scope is to a large extent determined by the spreading of the business model. The business landscape is a metaphor referring to nature. In similarity to the landscape, the business landscape is shaped and characterised by uncontrollable forces in the surrounding environment and may also be influenced by actors within the landscape.

1.1.2 Business model

“A business model depicts the content, structure and governance of transactions designed so as to create value through the exploitation of business opportunities. (Amit & Zott 2001: 511)”

“A business model describes, as a system, how the pieces of a business fit together. (Magretta 2002: 91)”

According to Magretta (2002) a business model should be able to answer the question:

“What is the underlying economic logic that explains how we can deliver value to customers at an appropriate cost? (Magretta 2002: 87)”

These two definitions are considered to complement each other well. The pieces referred to by Magretta (2002), based on Amit & Zotts’ (2001) definition, form the content, structure and governance. The general definitions above are in this thesis related to the mobile network operators’ view. Content, referred to in the definition means value in a general context, which in turn is any sort of flow that may influence revenues for a company, as for example services. The structure describes the relationships between actors that exchange content within the mobile operators’ business models. Governance concerns the ability to control the structure and the distribution of content. If these activities are implemented successfully, a solid foundation to capture business opportunities and to create customer value is built.

1.1.3 Revenue model

“A revenue model refers to the specific modes in which a business model enables revenue generation. (Amit & Zott 2001: 515)”

The revenue model is a part of the business model and exists in relationships between actors that conduct transactions. A carefully designed revenue model captures the created value and turns it into revenue. The mode is determined by the three activities, *valuation*, *appropriation* and *allocation*. These activities need to be conducted by the mobile operators in order to generate revenue from the creation of value.

- First *valuation* should be conducted in order to determine the value of the different flows that are being transacted. This is demonstrated by the value of the flows, which in turn can be used as a logical base for setting a price.
- Secondly the value needs to be *appropriated*, which means that the created value within the business model should be captured through transformation into revenue.
- The third activity concerns the *allocation* of revenue to different actors within the business model.

The mode that enables generation of revenue may vary between different relationships for instance a revenue sharing agreement can be designed differently in respect to valuation, appropriation and allocation.

1.2 Background

1.2.1 The evolution of the mobile Internet business landscape

Chan-Olmsted & Jamison (2001) and Wirtz (2001) conclude that the telecommunication industry has developed from being geographically limited, providing mainly fixed voice transmission, to become a truly global business. The telecommunication industry today enables services like voice, data and video to be transmitted over fixed as well as wireless networks. The increased communication opportunities have resulted in a convergence between four previously separate industries; telephone, mass media, consumer electronics and computing. (Chan-Olmsted & Jamison 2001: 318, Wirtz 2001: 490ff.) For the consumer this convergence opens up a world of possibilities. It will be possible to watch a movie or read the newspaper or even watch TV on the mobile phone. There will only be a need for one phone both at home and on the move. The mobile phone will be able to communicate with other electronic devices relevant for every day life like for example your home security system or home computer system.

Chan-Olmsted & Jamison (2001) and Wirtz (2001) have identified three common drivers that have caused the globalisation and convergence of the communication and media industry. These are deregulation and privatisation, technological development and increased sophistication of customer demand. (Chan-Olmsted-Jamison 2001: 320f., Wirtz 2001: 491f.) The technological development, related to communication networks and consumer terminals, has increased the possibility to develop more advanced services which enables more sophisticated media services. The deregulation and privatisation have resulted in increased competition, which consequently leads to lower prices, but also more sophisticated and differentiated service solutions. The consequence will be an industry that offers more advanced and sophisticated services at lower prices in order to respond to the increased competition and sophistication of customer demand.

1.2.2 Various definitions of the mobile Internet

The drivers that have caused the convergence of the communication and the media industry have consequently also contributed to the development of mobile Internet. The reason for this is that a more advanced technology has enabled advanced media services to be accessed in a mobile environment. To provide an understanding about what mobile internet is and the current immaturity within the industry, Ovum's, SonyEricsson's and Orange's definitions of the concept are presented.

“Wireless Internet services provide interactive access to Internet- based applications and content across cellular wireless networks using mobile phones, PDAs and other types of wireless devices. Wireless Internet services can be offered by a range of different service providers – for example, cellular operators, fixed and wireless portals, wireless application service providers (WASPs), device vendors and mobile virtual operators (MVOs).” (Ovum 2001: 1)

“Services that you can and need to access in a mobile environment, this includes services that are designed for a mobile environment. Mobile Internet is not the opportunity to access everything, it will always be possible to do more at a stationary terminal” (Robert Vass, Senior Manager Application Product Management, SonyEricsson, Sweden, 2002-04-13)

“Mobile Internet is nothing but an opportunity. Mobile Internet is a technological sphere in some kind of way that enables to offer services that give you increased living standard. Mobile Internet is an enabler, an open interface and that’s exactly what we are working for.” (Rune Myrthue, Manager Commercial Planning & Business Intelligence & Pricing, Orange, Sweden, 2002-05-08)

It is evident that there is no clear and precise definition of mobile Internet. The definitions of the concept differ depending on what perspective the actor has. It is interesting that the actors within mobile Internet industry do not have a common definition. It seems like no one really knows what the concept includes in terms of business opportunities. Due to this we will use an implicit definition based on the actors’ varying definitions in order to avoid limitations in our research.

1.2.2 Technological development enabling mobile Internet

An understanding of the technology is important in order to understand the increased service opportunities and the billing complexity related to the new more advanced services. Therefore, a description of the technological development will follow. The development of mobile communication technology can be divided into three steps, the first is the Analogue technique (NMT), the second is Personal Communication Service (2G, GSM) and the third step is 3G. Digital communication technology was introduced through the Global System for Mobile Communications (GSM) in 1991 and is today one of the leading digital communication systems. GSM enables digital services such as SMS, GSM positioning and transferring voice calls digitally. General Packet Radio Service (GPRS) is a step between GSM and 3G. Through GPRS transmission of data can be done, faster than through GSM, at a capacity of 9.6 Kbit/s to 115 Kbit/s. (www.sonyericsson.com, 2002-05-12)

GPRS is the first technology in mobile telecommunication that is based on packet switched data. Packet switched data can be sent in pieces and reassembled at the end destination. This means that the information does not need a separate connection in order to be transmitted, but can make use of any available space within the network. (Telecommunications 2001 June: 43) 3G enable packet switched transmission of 384 Kbit/s when the user is stationary or moving at walking speed, 128 Kbit/s if used in a car and 2 Mbps in fixed applications. (www.sonyericsson.com, 2002-05-12)

Wireless Local Area Networks (WLAN) are a short-range communication technology. WLAN enables PDAs and laptops to access Internet at a transmission capacity of 11Mbit/s. This access technology is today offered mainly at airports, hotels and in restaurants. WLAN is enabling a short-range connection to Internet and have no handover capability, which makes it a more static mobile technology. There have been concerns that WLAN through its high transmission capacity will compete with 3G. Dr Bernd Eylert, chairman of UMTS- Forum concludes:

“The two technologies (WLAN and 3G) are likely to be complementary rather than competitive. WLAN can give a great experience today to the demand of 3G services in the future” (www.umts-forum.org, WLAN: A threat to 3G, 2002-05-04)

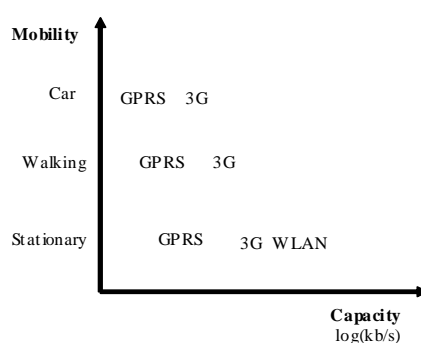

Fig 1.2 Two central dimensions of the mobile Internet

There are two dimensions, capacity and mobility, that are important to the definition of mobile Internet. The 3G technology suites services based on the mobile opportunities and add mobile value. On the contrary WLAN is a more static mobile technology which lacks these mobile opportunities but through the high capacity it enables high quality services. This description supports the view of WLAN as a complement to 3G.

1.2.3 The services on mobile Internet

Due to the technological opportunities enabled by GPRS, 3G and WLAN and the converging communication and media industries, there are today different opinions concerning how the operators' service offerings should and will be designed. For instance Hi3G is going to offer content from Premier League soccer through their British 3G network. (Telecommunications 2002 January: 20) Our research of mobile Internet has identified several different service concepts ranging from pure entertainment, such as various games, to services designed in order to facilitate companies operations. It is evident that packet switched technology and an improved transmission capacity as well as more advanced terminals will enable a rich range of value-adding services.

Katsumi Ihara, MD for the device manufacturer SonyEricsson, states:

"You can not sell a phone with technical arguments. People do not buy MMS or 3G they buy a function". (Dagens Industri 2002-03-15: 10)

1.2.4 Mobile Internet in Japan one-step ahead

For the mobile industry to be successful and capture the increased amount of business opportunities, to a large extent depends on the choice of business model. The Japanese operator NTT DoCoMo was the first operator to launch a successful business model for mobile Internet, under the brand name i-mode, based on packet switched data. The services offered are, amongst others, e-mail, guides for restaurants and mobile bank services. NTT DoCoMo enables content and service providers to use their network in order to reach the end users. NTT DoCoMo is gaining revenue from fees for services. The operator manages the content provider's invoicing process and takes 9% in provision for this service. Since NTT DoCoMo manages the invoicing process, individual content providers do not have to charge the users themselves. (Derefeldt et al 2001)

Hopper points out in the article *"Billing the 3G extravaganza"* that the success with i-mode to a large extent relies on the operator's ability to successfully design a platform that gives incentives for many players to innovate and provide services. The operator has acted with the

view that partnerships are critical to create new market opportunities. (Telecommunications 2001 September: 77-80) Since the first of October 2001 NTT DoCoMo, as the first operator in the world, enabled customers to get access to 3G services offered under the brand name Foma (Freedom Of Mobile Multimedia Access). (Industry Standard 2001 November: 39f.)

1.3 Problem discussion

Ovum concludes that the mobile Internet industry is a young industry that is characterized by new players, partnerships, services and technologies. This results in players having to try out new ways to structure their businesses. Today there is no existing blueprint for how the business models will be designed. Differences in user demand, relationships, competitive structures and technological capacity will lead to various business models depending on the specific region's conditions. (Ovum 2001: 1) The uncertainty regarding the above-mentioned factors results in two fundamental difficulties for operators. First the operators have to decide how they should design their businesses in order to fit the business landscape and the customers' preferences. Secondly, to do this successfully they have to understand what the customers consider valuable and how they value different service offerings, since this will have a significant impact on the business and revenue models. These two fundamental questions are correlated and have to be solved simultaneously by the operators in order to survive and become successful.

According to Törnwall in the Swedish business magazine *Dagens Industri* the delay of 3G services around the world are leading to an unstable situation in the telecom industry. This situation also has a significant impact on the infrastructure providers such as Swedish Ericsson and Finnish Nokia. (Dagens Industri 2002-03-05: 6) Kurt Hellström, CEO of Ericsson, has the following view of the west European telecom market

“Unfortunately we have a situation here where the operators are limiting both their investment in 3G expansion and upgrading of GSM networks. This is of course related to the debt situation emerged as a result of investments in expensive 3G licenses.” (Dagens Industri 2002-03-05: 7)

The debt situation and relating problems are further highlighted by Reinhardt in the article *“Telcos in hell”*, he states that the European operators owe \$285 billion to their creditors. In mid 2001, operators in 13 European countries had spent \$116 billion on 3G licenses, of which Germany and Great Britain counted for \$80 billion. The author also points out that relying on 3G services, as a rescuer for the operators, might be uncertain. Services will not be launched in most of Europe before 2004 and even so there is no guarantee for success. But in the end the only lasting way for operators to solve their debt situations are through cost savings and new data services. (Business Week April 2002: 66)

The development of new business models are restrained by the delay of 3G expansions and by the debt situation faced by most operators. This puts more pressure on the operators' revenue models, to work efficiently in order to appropriate created value and secure mobile Internet to be profitable at an early stage.

UMTS Forum estimates the revenue potential from 3G networks to be \$320 billion in 2010, of which \$233 billion is estimated to constitute mobile data services. (www.umts-forum.org, 3G Market Forecast, 2002-04-25) In the telecom industry there is an unwritten rule stating, *“if you cannot bill for it do not launch it”*. The billing process for packet switched data is much

more complex than the billing for circuit switched data. (Telecommunication 2000 July: 32-36)

Pricing for 2G phones meant that the operators' income consisted of a monthly subscription and price per minute. This combination could be designed to match different user characteristics. The pricing plans for 2.5G, 3G and WLAN based on packet switched data are based on a subscription and/or a price per kilobyte, which can be offered in various combinations. (Wolf 2001: 14f.) Billing customers based on the amount of time is to some extent not different from billing customers on volume of data. Different volume drivers determine the price of use; however it is far from certain that these drivers are the optimal drivers in order to capture the value that the customers experience.

The analysts Ovum conclude that next generation mobile services are creating challenges for the operators. To develop attractive services will not be enough. The successful operators will be the ones that implement successful billing solutions. (Telecommunication 2001 June: 1)

Eva Helen Lundgren, Pricing Unit, at Vodafone in Sweden concludes that the mobile Internet industry is going through a change concerning pricing questions. In the past, pricing has been based on minutes on-line. Operators will have a key position because they own the existing charging relation with the end user. Other players will have an interest in co-operating with the operators because they have knowledge and experience concerning billing issues. (Lundgren, E-H. 2002-04-24) The difficulty with developing revenue models for complex mobile services refers to the high level of personalization, characteristic for the services and completely new variables to base the pricing on. The new technology leads to a lack of historical data. The operators cannot rely on previous revenue models to work properly for mobile Internet, which is a result of the new conditions and opportunities.

Services offered over the mobile Internet are and will be supplied by several different actors cooperating in business networks. These constellations complicate the billing issue further. DeZoysa highlights this in the article "A 3G billing maze" that instead of billing the consumer, the operator might prefer to bill the third party provider for the access that they use in order to reach their customer. If this access is really valuable for the third party service provider they want to pay the operator for the customer's usage and the service will consequently be free for the consumer. This situation could emerge if for instance a customer reserves a hotel through their phone. The result will be value for the hotel that might want to pay for the customer's use of the service. Another alternative is that the third party provider bills the customer directly for the use of the service and the operator then receives a commission from the third party provider. Mobile Internet also enables more personalized advertising. The operator might want to bill the advertiser based on the number of subscribers that view the advertisements. (Telecommunication 2001 March: 38-42) This collection of complex factors results in significant challenges for operators when designing their revenue models.

As previously mentioned NTT DoCoMo launched 3G services under the brand name Foma (Freedom of Mobile multimedia Access) in October 2001. (Industry Standard 2001 November: 39). It might be tempting for operators being in the launch stage of 3G services to benchmark and imitate the design of the business model used by NTT DoCoMo. However this raises the question to what extent a business model suitable for a specific environment can be implemented frictionless in business landscapes characterized by different user preferences and other historical patterns of conducting business.

1.4 Problem formulation

Based on the problem discussion in the previous section the following problems have been the base for the research. The research point of reference will be the mobile operator's.

1. How does the business landscape influence the possible business models for mobile Internet?
2. How do the revenue models influence the possible business models for mobile Internet?
3. What will be important for operators in order to create value within the possible business models for mobile Internet?

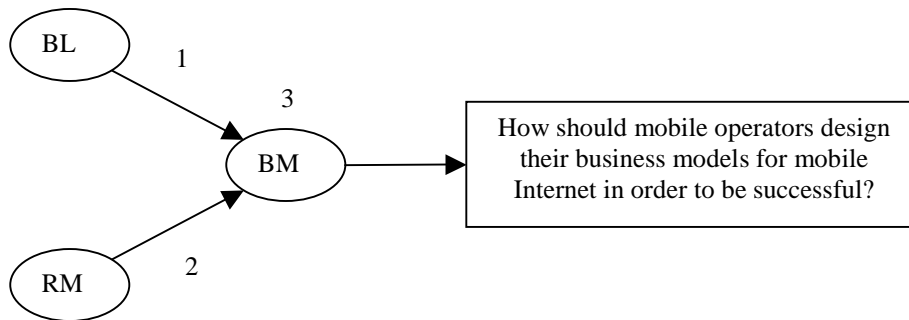

Fig 1.4 – Sequential visualization of the purpose

As is shown in the model, the purpose is being fulfilled with guidance of the formulated problems.

1.5 Purpose

How should mobile operators design their business models for mobile Internet in order to be successful?

1.7 Disposition

- **Chapter 2 – Method**

This chapter describes the method that has been used to reach the objectives of the thesis and to fulfil the purpose. It defends and explains the chosen area of research and presents our research strategy. Furthermore the selections of theory and empirical data are presented and explained. Thereafter the data collection is described and finally the issue of validity is being highlighted.

- **Chapter 3 – Theoretical Framework**

This chapter contains the theoretical framework used for analysing the empirical findings. It is divided into three parts. First, theories relevant to understand the business landscape are discussed. The second part presents theories relevant to understand a business model and its link to strategy and strategic tools. In the last section theories used in order to describe the activities within the revenue model are presented. These theories constitute the working definition of a revenue model. At the end of the theory chapter a comprehensive model based on the three parts mentioned illustrates the analytical tool.

- **Chapter 4 – Empirical**

This chapter aims to create a picture of the mobile Internet industry. It contains the empirical information subject to analysis and is structured similar to the theoretical framework. It starts with the business landscape, describing the market conditions and introducing the different actors. Thereafter business models and strategic issues are presented. Six different alternative business models from the mobile Internet industry are presented and described, mainly in terms of how value is being created. Finally the empirical information related to the revenue models is presented, based on the determinant activities valuation, appropriation and allocation. The chapter presents views of the interviewed actors from the mobile Internet industry as well as secondary material.

- **Chapter 5 – Analysis**

The analysis is structured in line with the theoretical framework and the empirical chapter. It starts with the analysis of the business landscape, identifying trends, driving forces and new organisational constellations. The chapter continues with an analysis and assessment of the business models and the strategic issues of importance for the mobile operators and the industry. Thereafter the revenue models are analysed, containing valuation, appropriation and allocation. Finally a correlated analysis is presented. Below is a more detailed and illustrative presentation of how the analysis chapter is structured and what it contains.

- **Chapter 6 – Conclusions**

In this chapter we present our conclusions in order to answer the purpose of this thesis. The conclusions regarding the six business models' potential to be successful for mobile Internet are based on the insight provided from the analysis.

2 Method

This chapter describes the method that has been used to reach the objectives of the thesis and to fulfil the purpose. It defends and explains the chosen area of research and presents our research strategy. Furthermore the selections of theory and empirical data are presented and explained. Thereafter the data collection is described and finally the issue of validity is being highlighted.

2.1 Area of research

There were many strong reasons to study business models for mobile Internet, when work commenced on this thesis. Mobile Internet has been a topic of current interest for a while and has grown both in terms of number of users and quality. It will most probably grow and develop much more over the coming years. There are still plenty of issues to sort out before mobile Internet has been exploited and there are also many questions that need to be answered. For us this made the area of mobile Internet very interesting and also highly relevant, since we could spot a possibility of helping the future development.

Following the extensive and strong influence that information and communication technology (ICT) has already made in today's society, we all have the belief that it is an area where we perhaps would like to work in the future, disregarding in what role or position. To undertake sophisticated research in such an area as mobile Internet was therefore also seen as a major opportunity to learn about what might be a very influential topic in the future.

Apart from the above-mentioned reasons, the fact that our tutor had a significant interest and knowledge regarding mobile Internet further influenced our choice of research topic.

The formulation of the purpose was caused by the existence of more than one possible business model for mobile Internet and since the issue of pricing and revenue sharing is a major potential influencing factor in deciding what structure the business models will take.

2.2 Research Strategy

In order to investigate how mobile operators should design their business models to succeed with mobile Internet, we needed to understand the mobile operators' business models from different perspectives. We also had to understand the environment in which the business models are supposed to create value within. Furthermore we required an understanding of how revenue models between actors were designed. We began by investigating the revenue models. Revenue models exist between actors in the business models. We interviewed mobile network operators as well as the actors contained within their business models; content aggregators, MVOs and terminal providers, to understand how the relationships between the actors influence the revenue models. Through interviewing actors having relationships with the mobile operators in addition to interviewing the mobile operators, a profound understanding of the revenue models was established.

Furthermore we required an understanding and overview of the operators' business models.

This understanding was created through information collected from the operators and the other actors within the operators' business models. Discussions with actors within the industry were also held in order to develop an understanding of their views of the business landscape and important issues for the industry.

Our research strategy has been based on three entities; *business landscape*, *business models* and *revenue models*. These concepts are defined in the previous chapter and below are a map aimed to further visualize how the concepts are related to each other.

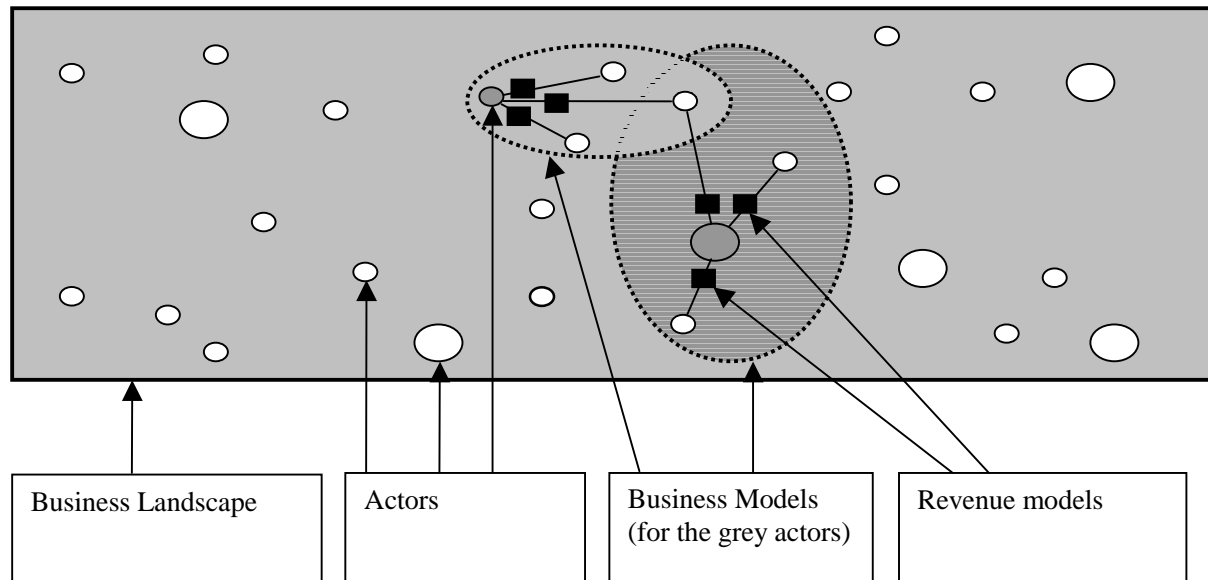

Fig 2.1 – The research view of the mobile Internet industry

Our research has to a high degree been structured following the areas of business landscape, business models and revenue models. The figure shows how the concepts relate to each other. The business landscape constitutes the environment in which the business models exist. The revenue model form a part of the business model.

The purpose with separating the entities; business landscape, business models and revenue models, visualized in figure 2.1, was to create a conceptual framework that uncovered the relations and dynamics between the entities. An analogy to this separation and conceptual framework is the conceptual framework regarding chemical compound, molecule and atom occurring in physics. To understand the interdependencies and dynamics in nature one has to develop concepts that uncover the relations. Otherwise no knowledge can be developed.

Through the separation of the entities illustrated in figure 2.1, we were able to recognize and understand the factors and problems that characterize their interdependencies. This conceptual separation was essential to structure our thoughts and influenced our selection of theory and empirical data. Since this separation highlights the relations and dynamics between the entities we were able to succeed with the correlated analysis and consequently also with fulfilling the purpose of this thesis.

2.3 Selection of empirical data

The empirical data has been used to create a picture of the mobile Internet industry and the including business dynamics. The picture created through the empirical research constituted

the object to be analysed. The empirical data needed to cover the three areas of business landscape, business models and revenue models.

The empirical sources can be subdivided into three different types. First we required interviews with different actors in the industry to understand their different perspectives and strategies. We also needed to make interviews with experts in the area of mobile Internet to be able to get both a deeper understanding of certain topics and a comprehensive picture of the industry as a whole. Secondary material such as articles and reports were required to create the basic knowledge and to complement the interviews.

2.3.1 Industry actors

The first source mentioned above is the industry actors. As shown earlier, the business landscape contains different actors, for example Operators, MVOs, Terminal providers, Service/Content providers, Consumers and Infrastructure providers. Except for the consumers and the infrastructure providers, interviews have been made with each party. The consumers' perspective has been reproduced via articles, reports and our own view. The interviews have been made with actors on the Swedish market, which can be deemed as a market that in terms of the economic environment very much represents other European markets, since factors such as technological development, regulations and access to both human and financial capital are more or less equivalent. Most of the actors that we have interviewed are also international companies and present in other European countries, this further enables the possibility of generalization.

When deciding what mobile network operators to interview, we needed actors who intended to commit themselves to the mobile Internet. Consequently, we considered operators who have been appointed licences for 3G on the Swedish market to be suitable to interview. The Operators have been represented by Vodafone and Orange. Orange is not running any network in Sweden yet, but is presently investing in 3G networks in Sweden. Orange is one of the largest global players with more than 40 million subscribers (www.orange.com, 2002-05-10). Vodafone is the world's largest mobile operator in terms of the number of customers and has over 100 million subscribers (www.vodafone.com, 2002-05-10).

Since the operators are playing a key role in developing mobile Internet, we wanted the operator's view to be represented by two different actors. This would enable a variety of opinions to be expressed and reduce the risk of bias. The persons interviewed have all been involved in strategies for mobile Internet. This was important for us in order to obtain relevant answers to our questions. Interviews or brief discussions via telephone have also been made with persons within the organisations who deal with more specific areas such as pricing or technology.

The MVOs have been represented by Dial n' Smile, a small actor differentiated to offer customised telecommunication solutions. Most MVOs are differentiated to suit a certain segment and are small players. Another common characteristic for the MVOs is their relation to the Operator that is selling network capacity. For our research the relation to the Operator and their small size made Dial n' Smile an acceptable representative for the MVOs and the information provided was consequently market by the specific characteristics.

SonyEricsson has been representing the Terminal providers. Their size and experience make them good representatives for the Terminal providers. Even though SonyEricsson might

represent a certain strategy, it is not affecting our research in a strong manner, since their view of the market should be similar to that of other large players. They are also strongly involved in relationships with the mobile network operators, which is the most important aspect.

The Service/Content providers are represented by Aspiro, which is a company acting on the international arena as well as in Sweden. Aspiro is both a provider and an aggregator of services and content and is one of the most developed and established actors on the market. Aspiro is one of few Service/Content providers that have experience from relationships with the mobile network operators and most of their competitors are young and small companies, which makes Aspiro a suitable representative for our research.

2.3.2 Experts

The expert interviews have been made with PTS, the Swedish authority in telecommunication matters, and Ovum, a world leading consultant and research company in telecommunication matters. PTS has been used to find answers on questions about standards and existing businesses. PTS also helped us in recommending other sources of information. Ovum has been interviewed regarding certain complex areas such as billing systems and information generation. We have also tested the validity of our thesis through the discussions with Ovum.

2.3.3 Secondary material

The secondary material in our empirical research consists of articles in specialist magazines in the area of telecommunication and the Internet, research reports from involved organisations and web pages or forums on the Internet. The secondary material was used to gain approval of certain thoughts, to obtain new perspectives and to find listings and statements. The secondary sources consisted for example of articles in the magazine Telecommunications, research reports from UMTS-Forum and reports from Ovum. Ovum has had a large contribution to this thesis in terms of secondary material due to their high developed knowledge concerning business models.

2.4 Choice of theory

To be able to analyse and answer the questions stated in the problem formulation and to fulfil the purpose of this thesis, theory within the three areas business landscape, business models and revenue models were required.

Within the business landscape, the first part of the theoretical chapter, we needed theories that could describe the development towards and conditions within a digitalised and mobile economy. This aids understanding of the factors and forces present in a digitalised economy. Normann (2001) provided a valuable introduction to this subject, introducing a new strategic paradigm and the prime mover as an important actor. We also needed theory in order to understand conditions that impacted the business models suitability in different business landscapes, which Porter & Stein (2001) provide. The characteristics of the business landscape had to be examined in order to understand the terms of competition and value creation. Arthur (1994) Shilling (1999) and Pitt (2001) gave this insight. Theories describing organic roles within this kind of environment were needed in order to understand different opportunities for specialization. Hougaard & Johanssen-Duus (1999) provided one of three articles that created a wide perspective on organisational roles within an Internet based economy.

In order to use the concept business model, literature regarding the concept was required. Amit & Zott (2001) and Magretta (2002) complemented other authors' views of the concept and enabled a working definition of the concept. We also had to have theories explaining how companies succeed within their industry. Porter's (1980) Competitive Strategy made the base for this area. An understanding for how relationships influence the creation of competitive advantages within the business landscape was also needed. Ensign (2001) provided valuable tools for understanding how to create value in relationships between companies in his articles concerning strategy and strategic options from a network perspective. An analytical tool was also needed in order to understand how the business models capture business opportunities. Hax & Wilde's (2001) "*Delta Model*" provided a suitable model for this need, linked to strategic thinking within a network perspective.

Literature describing revenue models and their characteristics was needed to thoroughly understand how value that is created within a business model on the bottom line is turned into revenue. The insight that there was no comprehensive model specifically designed for our purpose, resulted in the development of our own theoretical framework for a revenue model. Explorative research determined a revenue model to consist of the three parts; *valuation, appropriation and allocation*. These parts are reflecting the activities that our explorative research showed were important within the revenue models for mobile operators to enable transforming value into revenue. This categorisation made the reference for our theoretical inventory regarding revenue models.

In the valuation section we needed literature covering concerns when initial prices are being set. Dean (1961) and Lynn (1967) were used to provide theories covering methods of determining prices. For the appropriation section, available options to charge customers had to be covered. Varian (1999) was used in order to provide us with an introductory understanding of the issue, from a microeconomic perspective. The strength and appropriateness with Varian (1999) was his qualitative approach to microeconomics. The book was written with the purpose of enabling an analytical approach to microeconomic issues, without the use of advanced mathematical methods. Based on Varian's (1999) approach, we extended our theoretical framework concerning areas dealing with dynamic pricing, bundling and two-part tariffs. These are all various options of price discriminating. For the allocation section, theory was needed in order to understand how incentives are created and the importance of factors to success within networks and alliances. Among others Chan-Olmsted & Jamison (2001) covered this area with a focus on the global telecom industry.

2.5 Data collection

To describe the data collection that we have made, a categorisation into Explorative research, Primary data and Secondary data is made. The explorative research was aimed to create the basic knowledge of mobile Internet. With primary data we refer to data that is new and unpublished. As secondary data we consider already published and accessible data

2.5.1 Explorative research

To be able to build high buildings you need to make sure the ground is stable and thus the first phase in our research consisted of explorative research to build the ground on which we could develop. This phase consisted mainly of searching through secondary material such as

articles in ‘Telecommunication’ and other magazines within the profession, and research reports from organizations with competence regarding Mobile Internet such as McKinsey & Co and UMTS-Forum. It also consisted of primary data from an explorative interview with Magnus Wide, a consultant and doctoral student within the area of mobile telecommunication. Since we did not have a clear view and the objective was to obtain a broad picture, the questions in this interview were held open, to minimize the risk of influencing the respondent. Questions for example concerning definitions of mobile Internet, for example and conceptualizations of key issues were asked.

2.5.2 Primary data

The primary data in this thesis consists of interviews with carefully chosen representatives for companies that act within the market for mobile Internet. It also consists of interviews with other persons with great competence or knowledge within the area.

The questions in the interviews have been held open to minimise the risk of influencing the respondent and to get their true views, perspectives and reflections. This method also enabled a dialogue to develop and allowed questions to be added and, if necessary, an extension of the discussions regarding certain topics. The outlines of the interviews have been sent to the respondents beforehand, to enable preparations and thus increase the quality of the interviews. Before the interviews we have also explicitly presented the purpose of our study and declared that we have no principal or assigner with certain interests or commercial aims, but ourselves. With the permission of the respondents the interviews were recorded to enable a more qualitative understanding and interpretation of what has been discussed and described.

2.5.3 Secondary data

The secondary data consists of many different types and comes from many different sources to reduce the risk of bias and to develop a more comprehensive and correct view of the situation.

The data has been found with help from recommendations from our tutor, via search engines on the Internet, search engines at the Lund School of Management and by recommendations from interviewed persons. The secondary data consists of theories from acknowledged authors presented in established journals. It also consists of empirical data that has been found in articles in magazines within the profession, research reports and reports from actors within the industry. Continuously we have taken into account the source, which enables a more suitable and critical approach to the data.

2.6 Source criticism

2.6.1 Validity

The concept of validity refers to whether research measures what it is aimed to measure. In every context there are risks of getting false views or taking wrong information into account. All people are influenced by their surroundings and present circumstances, which makes the truth a relative concept. To minimise the risk of bias we have used many different and diversified sources of information, both regarding primary and secondary data. Sources that are accepted or acknowledged by the establishment have consistently and without exception been used. Furthermore discussions regarding interpretations have been made within the

research group to avoid misunderstandings and false interpretations. Continuously we have taken a critical approach to the information and data that has been collected and used.

3 Theoretical framework

This chapter contains the theoretical framework used for analysing the empirical findings. It is divided into three parts. First, theories relevant to understand the business landscape are discussed. The second part presents theories relevant to understand a business model and its link to strategy and strategic tools. In the last section theories used in order to describe the activities within the revenue model are presented. These theories constitute the working definition of a revenue model. At the end of the theory chapter a comprehensive model based on the three parts mentioned illustrates the analytical tool.

3.1 Business landscape

The first part of this section provides a description of the impact that the technological development has made on the business landscape. It also discusses factors important in order for a country to develop technological innovations. The second part describes forces that have emerged as a result of the technological development. The third and concluding part of this section highlights the opportunity for new organizational constellations due to the technological progress.

3.1.1 Development of the business landscape

This section describes the development of the business landscape as a consequence of technological progress and also the development of more sophisticated customer preferences. In addition it describes conditions that should exist in order to stimulate technological innovation capacity.

Normann (2001) concludes that the development of technology has made almost anything possible. Normann describes the “*new economy*” as a result of a major change of strategic paradigms. (Normann 2001:11-24)

Normann (2001) explains that throughout the industrialization the strategic paradigm was focused on the product whereas the customer was conceptualized as a non-human static acceptor. During this era the business conditions were characterized by a demand for non-complex products that exceeded the supply possibilities. The result of these business conditions was for the producers to focus on productivity enhancement and supply increasing efforts. Concepts as “*fordism*” and “*taylorism*” represent the mechanical view of the worker. The next strategic paradigm strengthened the importance of customer preferences. It became clear that the customer behaviour was of huge importance. When the markets began to mature, the demand decreased and competition from Japan increased. The companies realized that customer relations and the customer stock were the main concerns. (Normann 2001:28-40)

Normann (2001) claims the current business landscape is characterized by a fast technological development as a result of long-time technological progress. The products and the industries have become extremely complex. Therefore many industries are now knowledge intensive and it is has become much more difficult for one single company to represent a major part of the value creating process in an industry. At the same time information technology has contributed to the decrease in transaction costs. These changes have resulted in an increased

amount of players, as parts of the value creating system, where each player is more specialized and focused. The new strategic paradigm emphasizes the importance of handling the value creating process and the skills of affecting the various players in the value creating system. Normann describes it as a reconfiguration of the value creating system. (Normann 2001:28-40)

Normann (2001) introduces the concept “*Prime Mover*” that is the player who organizes the value creating process. A Prime Mover regards the managing and organizing of dematerialized flows as its core competence and transforms information into knowledge. Dematerialized flows are, for example, information, risk and financial capital. Due to the possibilities of the information technology these flows do not need any tangible carrier. Dematerialized flows can potentially be distributed anywhere almost instantaneously. The Prime Mover conceptualizes its organization as much bigger than the legal boundaries. In addition to the competence that the Prime Movers contribute within the value creating system, they also contribute with a vision of a network and the competence of bringing different kinds of assets and skills together to create an efficient value net. (Normann 2001:41-87)

Normann (2001) furthermore claims that Porters (1985) *value chain* is a simplified model of the more general economic environment that has become a reality today. The main focus has been directed towards physical value creation and product manufacturing. Porter’s model has been relevant under these conditions, but in the current environmental context it is not. Normann means, which has been mentioned, that the focus has to be broader and include the whole value creating system. He introduces the concept *value star* that gives a better conceptual picture of the value creating process. The value star highlights value creation by various players as contributions to customer value. The value star approach also emphasizes that the customer should not only be considered as a consumer, but also as an important player in the value creating process. (Normann 2001:90-94)

The article “*Knowledge webs & generative relations*”, Eneroth & Malm (1999), introduces the metaphor *Knowledge landscape*. They suggest that the biological metaphor of a fitness landscape can be transferred to illustrate the business landscape. Eneroth and Malm point out that the struggle to fit the surrounding environment by creatures in nature, is similar to companies in the business landscape concerning knowledge fitness. They further mean that by a generative knowledge web, that is relations to other value creating players, the value creating system will achieve greater knowledge fitness. The knowledge web will lead to a more efficient navigation in the rough business landscape that is typical for fast developing markets. Eneroth & Malm (1999) also emphasize that not all relations in the knowledge web necessarily have to be generative. For generative relations three factors determine whether the relations are generative or not. These three factors are (1) a balance between novelty and confirmation in the knowledge exchanges, (2) complementarity of competences and (3) shared visions across organizational borders. The first factor concerns the fact that not only new knowledge is necessary and good knowledge. Completely new knowledge can be hard to absorb into the organization. The second factor means the web has to enable complementary competencies and the third that visions in some context have to be shared. (Eneroth & Malm 1999: 174-186)

Porter & Stern (2001) concludes in the article “*Innovation: Location Matters*” that companies must be able to create innovations on a global level. Successful companies must have capacity to create new products and processes that change the technological frontier. In the article Porter & Stern (2001) discuss the drivers that create innovation. Previously the drivers have been focused on the internal parts of the company without taking the external environment

into account. (Porter & Stern 2001: 29)

Porter & Stern (2001) emphasize that the national innovation capacity is important. National innovative capacity refers to a country's potential to create innovations that are commercially usable. In order to evaluate countries' innovative capacity the following three areas need to be examined; *common innovation infrastructure, cluster specific environment for innovation and quality of linkages*. The common innovation infrastructure refers to factors that support innovation throughout the entire economy. This includes, overall human resources, the amount of financial resources a company devotes to scientific purposes and technological advances. In this dimension it is also important with the public policies and the level of technological progress that exists within the country. (Porter & Stern 2001: 30)

The second parameter to be used is the cluster specific environment for innovations. A cluster is defined, referred to by Porter & Stern (2001), as "*geographic concentrations of interconnected companies and institutions in specific fields*". The *Diamond framework* captures the factors important for the innovation capacity within a cluster. This framework judges the cluster by the four criteria; *presence of high quality and specialized inputs, an environment that encourages investments and is characterized by local rivalry, pressure and insight derived from advanced local demand and local presence of related and supporting industries*. The quality of the diamond will determine the potential for innovation within a cluster. Clusters with a strong innovative capacity can strengthen the ability for a country to be globally competitive within different fields. The third factor important for a country's innovative capacity is the quality of the linkages between the national and cluster specific environment. Institutions such as universities can for instance develop such linkages. (Porter & Stern 2001: 29f.)

3. 1. 2 Forces in the Business landscape

This section describes forces, which have evolved as a result of the technological development and that are characteristic for the business landscape. It is important for actors in the business landscape to understand the conditions in their environment in order to understand how value creation can take place.

Arthur's article (1994), "*Increasing Returns and Path Dependence in the Economy*", strengthens the belief of a new economy where stabilizing forces do not seem to exist in the way that they did in the traditional economy. He compares the business landscape with a non-linear dynamic system. A system in the traditional economy has stabilizing forces that he labels negative feedback. These stabilizing forces affect the demand and the revenues negatively when the supply increases. The system is stable with one single equilibrium point. In the case of high operational risk and high fixed costs, the system can experience positive feedback and consequently increasing returns, depending on the market conditions. If the variable costs are low the marginal cost to increase the supply will decrease. If the demand at the same time decreases more slowly than the marginal cost, the system will be unstable with positive feedback and increasing return. If the systems, in addition, experience network externalities the system is always unstable. The conclusion of Arthur's (1994) discussion is that the development of the business landscape is path dependent. It means that the development of the economy includes many possible paths. Every path arises from the outcome of small events. It is possible and also likely that the most efficient path in a long-time perspective does not come up. The result of an unstable economy is that inefficiency is possible and dependent on small events. (Arthur 1994: 1-29)

Schilling (1999) highlights the importance of pre-market competition and small events in the article “Winning the Standards Race”. She means that in the new economy with path dependency, it is important for the companies to cooperate and create standards. Schilling also means that a company has to build a large, installed base to improve its strategic position within the value creating system. If a company manages to set the dominant standard the possibility for lock-in effects and success in the current small event increases. Further Schilling means that by creating dominant standards the customer stock will more quickly reach the critical mass. The value creating system will therefore experience learning curve effects, signal effects and perhaps network externality effects. The size of the installed base and the availability of complementary goods are critical factors to increase the returns of adoption. Schilling further means that by aggressive marketing, penetration pricing, bundling and diffusion of the technology the probability of increasing returns will grow. (Schilling 1999: 265-274)

Pitt (2001) introduced five forces that have a significant effect on strategic management in the digital age. The digital age is distinguished by rapid developments of “*killer applications*”, innovations that not only improve the way something is done. It fundamentally changes the way to conduct a specific task. Traditionally strategy has been concerned with understanding the business environment, but the rapid technological development has brought about new requirements on strategy. The five forces introduced should act as a tool for managers to understand and handle disruptive technologies. (Pitt 2001: 1f.)

“*Moore’s Law*” refers to the doubling of computer power that occurs every 18-24 month. This is done through the doubling of transistors on computer chips. For managers this demands a comprehension of the opportunities and threats of the rapid increase in computer power, which is built into electronic devices. (Pitt 2001: 4f.)

“*Metcalfe’s Law*” presents that the value of a network is dependent on the size of the network. The value of the network increases with the number of users. Internet can be seen as a prime example of this. The network provides value through enabling short cuts in physical communication. (Pitt 2001: 5ff.)

“*Coasian economics*” means that transactions become inefficient due to the cost of searching, contracting and controlling the relationship with the transaction partner. The development of information technology results in decreased transaction costs through more efficient and transparent communication and information sharing. Managers will have to decide what scope of the firm is optimal, due to the increased opportunities to outsource activities, and to design the firm in a virtual constellation. (Pitt 2001: 4-7)

The fourth force Pitt (2001) presents is the “*The flock of birds’ phenomenon*”, which argues that no player can be described as a leader. On the Internet all players have equal opportunities to access and disseminate information. Laws set up to regulate the physical world frequently do not apply on the Internet. This phenomenon has a significant effect on competition and creates opportunities not only for large players. (Pitt 2001: 7f.)

“*The fish tank phenomenon*” means that anyone can put information on the Internet. This creates opportunities for innovations that are not related to the size of the innovator. Competition based on applications suited to the Internet becomes multi dimensional in the sense that the origins of innovations are difficult to predict. (Pitt 2001: 7ff.)

Pitt (2001) concludes that the five new forces influencing the business landscape will result in

a less predictable and structured way of conducting business. Managers have to deal with a more rapid development, new organizational constellations and to be aware of social phenomenon that is difficult to govern and control. Strategic planning needs to be more frequently evaluated and to a larger extent based on short term objectives. (Pitt 2001: 12ff.)

3. 1. 3 New organizational constellations

This section presents three views of possible new organisational constellations caused by Internet, digitalization and decreased interaction costs. Finally factors that facilitate specialization within integrated networks are presented.

Werbach (2000) introduced a model for the roles of the market players in the article “*Syndication, The Emerging Model for Business in the Internet Era*”. He discusses three roles that a company can have; *originator, syndicator and distributor*. This model has its origin in the newspaper industry, but Werbach (2000) applies a modified version on the Internet industry. Originators create original content. Syndicators package that content for distribution. Distributors deliver the content to customers. A company can play one role in a syndication network, or it can play two or three roles simultaneously. It can also shift from one role to another over time. Werbach (2000) means that the syndicator is some form of an infomediary, collecting and packaging digital information in a way that adds value to it. (Werbach 2000:87ff.)

Hougaard & Johannsen-Duus (1999) describe in the article “*Competing in the Digital Age*” that digitalization will provide increased pressure on the virtual supply chain. Virtual value chains are aimed for the exchange of information and value is created through interaction and cooperation between four actors. *Configurators* manage the development, organization and bundling of information and delivers the information through the virtual network. The core competence of the configurator is to be able to operate a virtual market place efficiently. They also have to provide a physical delivery system with a minimum level of friction and at a maximum level of speed. *Providers* deliver content, components, user devices and services. They view the role of configurators as actors that provides a virtual market place aimed for commercialization. *Operators and forwarders* manage the delivery of information and operate the electronic and informational infrastructure. The *users* are seen as partners in the value creation through relationships based on mutual learning. (Hougaard & Johannsen-Duus: 1999:1-5)

Hougaard & Johannsen-Duus conclude that the traditional value chain is based on standardization, high volume and mass communication. The virtual value chain is characterized by customization, low volume and the use of one to one communication. This is combined with flexibility in both the communication system and the production process. For the configurator to be able to develop a relationship based on learning with the individual customers there has to be a primary focus on communication. Customization of the communication means that there is a creation of individual and dynamic interfaces for each individual user. This enables response functions to develop towards a higher degree of interactivity. Knowledge about the customer can thus be increased and the configurator can learn how to anticipate customers’ needs more quickly. Providers have to develop from modularization to mass customization. For the operator it is important to develop system innovations that stimulate and support mass customization. (Hougaard & Johannsen-Duus 1999: 5)

Hagel & Singer (1999) describe new organisational roles as an outcome of decreased

interaction costs. *Interaction costs* refer to the time and money involved when people and companies exchange products, services or ideas. Internet and the technological development work as a force that decreases interaction costs. Companies organise themselves in order to decrease transaction costs, which results in three new and distinct organisational roles within the business landscape. The companies are stimulated to split up their core process. The different core processes have different economic, cultural and competitive requirements. Because of the different objectives it is difficult to incorporate the different roles within the same organisational structure. This motivates a focus on specific activities. (Hagel & Singer 1999: 133ff.)

Product innovators conduct the development and commercialization of products and services. The economics for these players is speed. This is because gaining a large market share becomes important. In order for the product innovators to succeed with the development of competitive innovations, the culture within the company has to be creative. In order to develop a creative and innovative work force the competition will concern talented people. *Customer Relationship Management* focuses on identifying and attracting important customers in order to develop relations. Because of the high costs of acquiring customers, it is important to gain a large part of the customers' spending, which leads to a strong focus on scope. In order to attract customers, the culture has to be characterized by a strong service mind. The competition is characterized by a strong ambition to reach scope, which leads to a smaller number of large players who survive the consolidation phase. *Infrastructure Management* focuses on building and managing the infrastructure and on making volume possible in the network. It is important for these actors to reach economies of scale because of the heavy investments. Scale is achieved from making a high volume use the network. Because of the importance of scale the competition between these players will lead to consolidation resulting in the existence of only a few large players. (Hagel & Singer 1999: 134f)

3.2 Business models and Strategy

This section is divided in five parts. First the business model and the purpose of the model as an analytical tool are presented. The second part presents strategic options to be used in order to reach competitive advantage. The third part presents strategic issues specific for the mobile Internet industry. The fourth part develops the concept of the value chain to better fit the conditions within the relevant business landscape. Finally, the Delta Model, a tool for capturing business opportunities through value creation in technology intense business environments, is described.

3.2.1 Business models

A business model is a concept, which is subject to various definitions. In this section some of the definitions are presented in order to create an understanding of the concept and its purpose. Furthermore this section describes the distinction between the concepts business model and strategy.

Magretta (2002) concludes in the article "Why Business Models Matter" that the terms *business model* and *strategy* are being carelessly used. The broad and vague use results in that they end up meaning nothing as a consequence of the ambition to include everything in the concepts. Magretta points out that a business model is a concept that "explains how companies work". A good business model should answer the questions; Who are the

customers? What is customer value? How can a company deliver customer value at an acceptable cost? A business model is successful if it offers an advantageous way of executing activities. It can contribute with superior customer value and it might completely change the existing ways of conducting activities within an industry. (Magretta 2002: 86-92)

Magretta (2002) emphasizes that when business models do not work, it is because they fail either the narrative test or the numbers test. A business model fails the numbers test if the activities do not generate appropriate economic results; in other words the basic business mathematics is then insufficient. The business model fails the narrative test if the basic idea with the business model does not make sense. It can be a consequence of incorrect assumptions regarding customers' preferences or suppliers' behaviour. Magretta (2002) explains that if the business model is used appropriately it helps management to understand how different parts of the business fit together and makes it easier to plan and coordinate activities. A clear business model also brings clarity and works as a tool to communicate with and motivate employees. (Magretta 2002: 86-92)

Prahalad & Ramaswamy (2000) describe that strategy and the strategic purposes have been widened to include suppliers, manufacturers, partners, investors and customers. The perspective used to understand a company's business model is the enhanced network. (Prahalad & Ramaswamy 2000: 79-87) Amit & Zott (2001) use the definition of *Virtual Markets* as “*settings in which business transactions are conducted via open networks based on fixed and wireless Internet infrastructure*” (Amit & Zott 2001: 495). The purpose for using a business model perspective on value creation in virtual is to answer the question; *How do participants to a transaction, especially the firm, which is the reference point of a business model, enable transactions and how is value created in the process of enabling transactions* (Amit & Zott 2001: 514). Using the business model as a unit of analysis has the implications of a wider scope, than the firm, as a basis of analysis. The detailed framework of value creation in E- business does not suit the purpose with this thesis. Even so, the definition and conceptualization of a business model provides a valuable comprehension for this piece of research.

Magretta (2002) points out that the concepts *business model* and *strategy* are frequently used with the same meaning, but concludes that there is a clear distinction between a business model and a strategy. The business model describes and illustrates how the different parts of a business fit together in a system. One dimension that the business model does not deal with is how the company is supposed to deal with competitors. This is the purpose of a strategy, which explains how the company should outperform the competitors by being different. In an industry, companies can use the same kind of business model but execute different strategies. For instance different brands, prices and levels of efficiency can contribute with better opportunities to create value through the same business model. (Magretta 2002: 86-92)

3.2.2 Strategy and strategic options

Since the competitive dimension is not captured in the business model, this section highlights the importance and alternatives available for companies to create competitive advantages.

Othman (1983) explains that the most important purpose with strategy is the development of competitive advantages, which will help the firm, to gain a sustainable edge over its competitors (Othman 1983). Henderson (1989) concludes that the purpose of strategy is to continuously develop a plan of action that will provide the firm with a competitive advantage. The differences between a firm and its competitors are based on the competitive advantages.

Unless a firm has developed a competitive advantage it has no reason to exist. (Henderson 1989: 141)

Grant (1998) concludes that a company has a competitive advantage when it has significantly higher long-term profitability than its competitors. The emergence of a competitive advantage can result from either external or internal change. A competitive advantage that arises from external changes depends to a large extent on a company's ability to anticipate and respond quickly to changes. A competitive advantage based on internal changes is generated by innovation and is a result of imagination and creativity from within the company. (Grant 1998: 173-178)

Porter (1980) discusses the generic strategies; *overall cost leadership*, *differentiation* and *focus* to be used in order to outperform other companies in an industry. Some industries will have opportunities for all firms to reach satisfying profitability while others only provide modest returns even when companies succeed with its generic strategy. (Porter 1980: 35)

The *low cost* strategy requires aggressive commitments to cost reduction and construction of scale efficient facilities. Management is focused on cost control and to attain low cost relative to its competitors becomes the central theme of the strategy. A low cost position is often reached through a high market share or favourable access to input. Firms that gain a leadership based on a low cost strategy often redefine the conditions for competition in the industry.

The *differentiation strategy* aims at creating a product or service that is perceived as unique by industry standards. Differentiation advantages can be based on variables such as brand, design or technology. A strategy based on differentiation provides protection against competitive rivalry through brand loyalty, which makes the firm less sensitive to price competition. The ambition to reach a strategic position based on a differentiation advantage is often reached at the expense of a high market share. To offer a unique product or service is often combined with an exclusive concept, which prevents gaining a high market share. (Porter 1980: 35-38)

The *focus strategy* is built by offering a narrow segment a product or service based on low cost or differentiation or a combination of them. The focus strategy can be aimed at serving customers where competition is weak or where few substitutes exist. The market share available for a company who choose to follow a focused strategy is limited. The trade-off with the strategy is between profitability and sales volume. (Porter 1980: 38ff.)

Porter (1996) concludes that competitive advantage through operational superiority becomes rarer. In order to create economic value the firm has to gain a cost advantage or differentiate themselves to reach an opportunity for price premiums. In order for a firm to maintain a distinctive strategic position the strategy has to enable the firm to deliver a unique value to the customer. Strategy defines the way of competing and the value to be created and delivered to customers. The value chain has to reflect the strategy. In order to build a competitive advantage the firm must perform different activities in the value chain or perform similar activities in different ways. (Porter 1996)

3.2.3 Strategic issues within the mobile Internet industry

This section highlights strategies specific for Internet firms conducting internationalisation strategies.

Kotha et al (2002) investigate the influence of firm specific factors in order for US Internet firms to internationalize their presence. The research concludes that companies with firm specific competitive advantages are more likely to internationalize their business. Presence of intangible assets is a good indicator of a firms' propensity to internationalize their business. Intangible assets' usefulness in international growth strategies are based on their flexibility and the fact that they do not depreciate with increased utilization. The two intangible assets web traffic and reputation, which are also critical for domestic competition, are important for internationalization. Web traffic becomes more important with the amount of different user groups connected to the network. Internationalization acts as an incentive because of the opportunities to accumulate web traffic from differentiated sources that increase the value of the intangible asset. The more importance an intangible asset has in the local business model, the likelier it will be that the company uses the asset in order to develop their presence internationally. The value of intangible assets such as web traffic and reputation also increases with the size and exposure of the asset. Reputation can be viewed as a more sustainable asset. This asset contributes with value since, for instance, it influences the speed of adoption of new products. (Kotha et al 2002: 769-787)

3.2.4 Strategy and strategic options from a network perspective

The value chain concept is used in order to understand the activities within a company. It has initially been developed with the individual company as research area. In order for this analytical tool to be optimal for our cases a development of the concept has to be made.

The value chain is used in order to classify and examine a company's capabilities, through separating the activities of the firm into a chain of sequential activities (Grant 1998: 120). Porter (2001) presents the value chain as a tool for understanding the impact of information technology on the activities performed within a company. A company competes through separate interconnected activities. (Porter 2001: 74) The generic value chain introduced by Porter was initially intended to be used for strategic development in the manufacturing sector. Ensign (2001) also uses the "value chain" in the article "Value Chain Analysis and Competitive Advantage". The author questions the second word "chain" because it implies a linear sequence of activities. He emphasizes that value may be created through overlapping activities or through a spider web or three-dimensional network. (Ensign 2001: 21) The value chain becomes more useful in this context in consideration to different kinds of external relationships. The value chain concept contributes as a tool for conceptualizing the activities that are needed in order to provide a product or service to the customer. When using the word *chain* the concern raised by Ensign (2001) is agreed. The word *chain* is not explicitly viewed as a set of related activities conducted in a predetermined way. The use of the word refers to the activities conducted by a firm in order to create value. These activities can be done internally as well as externally in cooperation with other players within the company's network. (Ensign 2001: 18-22)

Ensign (2001) describes that competitive advantage is developed through the value creation process initiated through the competitive strategy. Value is added through the performance of functions and activities. Most activities conducted by companies are similar to each other. In

order to create a competitive advantage they have to be based on scarce resources such as intellectual capital, assets or distribution networks. (Ensign 2001: 18-22)

Ensign (2001) considers the value chain to contribute with three distinct characteristics for analyzing a strategy; understanding the sources of sustainable competitive advantage, identifying linkages and interrelationships between activities that create value, and a focus on developing competitive strategies. Linkages have an influence on competitive advantage through *optimization* and *coordination*. Optimization refers to the process of conducting an activity as perfect as possible. Coordination relates to the process of recognizing and managing linkages between external and internal units. In order to achieve a competitive advantage it is important for a firm to understand what linkages and interrelationships exist and can be developed. (Ensign 2001: 23-26)

Internal linkages are linkages that capture the relationship that occurs when value-creating activities are conducted within one unit or between units in the same firm. *External linkages* describe the relationship between a unit and an outside firm. Two types of external linkages can be developed. The *inter-firm interrelationship* occurs when an outside firm supplies an activity needed. An external link is then established between the two value chains. A *network interrelationship* is developed through resource sharing as a result of linkages between an indefinite number of firms. The interrelationships are designed in order to create a new value chain to be shared by all participants. Organizational forms such as alliances and network organizations are examples of network interrelationships. The purpose of the network linkage is to perform shared activities, through the creation of a new value chain. This is done in order to create a competitive advantage on the corporate level through the development of interrelationships between firms. (Ensign 2001: 28ff.)

Ensign (2001) concludes that on the corporate level competitive advantage is reached through either *internal or external resource sharing*. Internal resource sharing relates to the process of developing synergies through increased coordination. External resource sharing develops through resource sharing and creation of value in new organizational forms. This kind of resource sharing is characterized by a significant need for coordination as a result of its complexity. (Ensign 2001: 38ff.)

3.2.5 The Delta model

The development of the value chain, to better fit the new structure and conditions of the business landscape, has implications on the strategic framework used to analyze and understand business opportunities. In this section a presentation of such framework is presented.

Hax & Wilde (2001) offer in the *Delta Model* a strategic framework that captures the potential and the opportunities with integrating Internet into strategic management. The Delta Model is developed under the prerequisites that the purpose of strategy is to achieve superior long term financial performance, measured in long- term profitability. This should be attained by customer bonding and offering of unique customer value. In order to deliver unique propositions to the customers the firm has to create a positive net flow of talent. This becomes more important in knowledge intensive industries. (Hax & Wilde 2001:379f.) The ability to attract talented people is also an aspect Hamel (1999) describes as important when explaining why small start-ups in Silicon Valley are able to be more innovative than larger companies. Larger companies should have better conditions to innovate because of the access to more resources, but because of too much structure in the resource allocation system their innovation

capacity is restrained. (Hamel 1999: 83f.)

The Delta Model emphasizes the change of strategic focus through the description of the three strategic positions *best product*, *total customer solution* and the *system lock-in option*. The strategic position of a company refers to how it intends to attract, satisfy and retain customers. (Hax & Wilde 2001: 381) The definition of a strategic position is similar to value creation, which makes the business model useful as an analytical reference. Based on the choice of strategic positions different levels of scope become important in the value chain. In order for a company to successfully attract, satisfy and retain customers in the long term, a competitive advantage has to exist.

The best product position is a classical strategic position based on a low cost or a differentiated position. The competitive way of thinking is to beat the competitor through improvements in the company's own value chain. The aim is to reach product economies and the level of bonding with the customer is kept to a minimum. (Hax & Wilde 2001: 381f.)

The total customer solution is a position completely different in comparison to the best product position. The objective of a company is to develop a unique value proposal to each individual customer in order to be able to develop a close relationship with each individual customer. The proposals are created with the purpose of creating economic value for the customers as well as for themselves. This is done through joint solutions with customers. The focus is extrovert and the company tries to develop close relationships with players in the value chain in order to reach an integrated supply chain. (Hax & Wilde 2001: 382) The main difference between the strategic option of best product and total customer solution is the change of ambition, to satisfy the customers individually and to cooperate with external parties in the value delivering process.

The strategic option of System Lock-in has an even stronger extrovert focus. The *extended enterprise* consists of the company, the customers, the suppliers and the complementors. A firm is a complementor if it increases and improves the product or services offered by another company. In order to succeed in this strategic option the company has to develop capacity to identify, attract and take care of the relationships with complementors. Companies that succeed in collaborating important complementors have the opportunity to create a system *lock-in*. This is achieved when customers demand a company's product supported by the complementors' offerings and the product thus gets locked into the system and the potential for locking out competitors products increase. In order to create a solid foundation for system *lock-in* there has to be an agreement on what kind of technological standards should apply. (Hax & Wilde 2001: 382)

Hax & Wilde (2001) offer through the Delta Model a shift in strategic focus from an internal to an external strategic focus. A business proposal has to be developed with the understanding that the company's suppliers are natural partners. In order to create valuable and attractive solutions, a company has to reach or build a profound understanding of the end consumer in the integrated value chain. Competitors as a benchmark become less relevant as a source for building a profitable strategy. (Hax & Wilde 2001:390)

In order to develop a business model that better suits the challenges of a dynamic environment Hax & Wilde (2001) point out that there has to be a profound customer understanding combined with an understanding of the key players in the network. Internet is seen as the driving force that enables the development of new strategic positions. The product or services offered by a firm should be developed in order to be attractive to all the key

players in a company's network. (Hax & Wilde 2001: 391)

3.3 Revenue model

Amit & Zott (2001) offer the following definition "A revenue model refers to the specific modes in which a business model enables revenue generation" (Amit & Zott 2001: 515). This definition of explaining the purpose of a revenue model in an appropriate way is useful to this thesis. In the analysis the modes exist between the actors within the operator's business model. This section is divided in three subsections reflecting the activities important in order for the revenue model to generate value. The first part, valuation, describes the consideration that has to be taken in order to set the price. The second part, appropriation, offers insight in options and strategies available for operators in order to capture the value. The third part is aimed to create an understanding of the need to allocate revenue within the network relevant for the business model in order to create solid foundations for value creation.

3.3.1 Valuation

The valuation part presents theories used in order to set prices with a focus on products with short life cycles. It also presents the concept of reference prices and considerations that have to be made in order to evaluate customer profitability.

3.3.1.1 Determining the basic price

Here a presentation of considerations for price setting will be given.

Lynn (1967) explains that basic prices refer to the starting point price, from which prices are adjusted in order to match the competitive environment and demand shifts. The starting point when setting basic prices is a trade off between market shares and profit. *Profit based prices* are set according to a target return for the firm. When using profit based prices companies' view the fact that a decrease in price will lead to an increase in market share with scepticism. The force of price elasticity is not seen as a force that can have a significant change in demand and volume. Volume goals are seen as having a negative impact on profit. (Lynn 1967: 150-155)

In competitive environments cost often becomes the determinant for price setting. *Flexible cost-plus pricing* is set through a mark up, which takes *demand, profitability and competition* into consideration, in order to cover variable and overhead cost. The cost act as the determinant for price setting and various variables act as input for cost predictions. (Lynn 1967: 160-164)

The *volume based price strategy* has the main objective to reach a specific market share. Price is to large extent based on demand estimations. Cost as a base for price setting is seen as less relevant because when the specified volume is reached, costs will be covered. Short-term profit is not a major concern because the specified market share will contribute with satisfying long term profit. The variables, *price, unit cost and volume* are related to each other and have an impact on profitability. The volume influences the cost and cost has a significant impact on the price. Prices on the other hand impact the sales volume. In order to set an accurate price there has to be both adequate internal and external knowledge. (Lynn 1967:165-173)

3.3.1.2 Pricing products with short life cycle

Since technological development has the consequence that new services can be developed at a fast rate, price considerations have to take this into account.

Dean (1961) makes a distinction in price decisions between products with a long and short life cycle. The life cycle refers to a marketing concept, based on a product's movement; from introduction, growth and maturity to the decline stage (Grant 1998: 243). Products with a long life cycle are defined as products with a lifetime exceeding ten years. It means that no acceptable substitute will be present within this period. This kind of product characteristic is rare. Frequently products are following a cycle of competitive degeneration. (Dean 1961: 403-411) Since the mobile Internet services are in an introductory or potential growth stage, pricing strategies relevant for these stages in the life cycle are discussed.

Dean (1961) concludes that the pricing decisions, over the product life cycle, depend on the development of three types of maturity factors. Technological maturity refers to increased standardization. Market maturity refers to a more widespread acceptance of the product or service among customers. The differences between companies' proposals decrease over time. Competitive maturity occurs when prices and their structure reach a more stable behaviour. The factors that set the rate of degeneration and maturity of an industry life cycle are market acceptance, technological development and ease of competitive entries. Market acceptance refers to the rate at which consumers consider the product or service a serious alternative in fulfilling its purpose. Technological development refers to the rate of development in the environment. When the development is rapid, products and services tend to become out of date at a faster pace. The ease of competitive entry increases over the products or services life cycle. In the early stages the innovator can control the entry level by other means than pricing strategies, even though these are important at this stage. The importance of pricing strategies increases throughout the life cycle (Dean 1961: 411ff.)

3.3.1.3 Price strategies for initial price setting

This section presents the two initial price strategies skimming and penetration pricing. In the introduction of mobile Internet services initial offerings can be based on for instance market share objectives and brand concerns.

When choosing initial price policies the company can choose between the two extremes skimming and penetration pricing. Policies of using a skimming price policy mean a high initial price in order to skim the demand. The customers that choose to buy the product at this level are price insensitive and the price can act as a reference for building a price range. The risk of setting the price too low decreases with a skimming price policy. (Dean 1961: 419-424)

Lynn (1967) concludes that the price level should be set considering the expected responsiveness of competitors and should be based on the desired market share. Products or services that are protected from competitors can have a high initial price. (Lynn 1967: 134f.) Penetration pricing policies means setting a low initial price in order to create volume and get a large market share. Aggressive pricing suits conditions that are characterized by high price elasticity and where changes in the price level influence the sales volume significantly. An

increased sales volume should also have a substantial effect on the behaviour of the production costs. If competition is tough, penetration pricing can act as a tool for building barriers and obstruct the competitors from gaining market shares. (Dean 1961: 419-424)

3.3.2 Appropriation

In this second part of the theory related to revenue models, theories concerned with customers' buying propensity and how to capture the value are presented. The section introduces price objectives and prices sensitivity. It also introduces three types of price discrimination and tools to use in order to price discriminate; dynamic prices, bundling and two-part tariffs. The last part will present characteristics of subscriptions.

3.3.2.1 Definitions and price sensitivity

This section provides insights about price objectives and explains factors which impact on customers' price sensitivity.

Price theories refer to economic theory regarding practical pricing problems and include factors such as demand, competition and relevant cost relations. In order to conduct a useful framework for price analysis, definitions of concepts used in price theories have to be made. Price objectives are closely related to a company's comprehensive objectives. (Dean 1961: 399) Hax & Wilde (2001) explain that the overall purpose of a company's strategy is to create economic value defined as long-term profitability (Hax & Wilde 2001: 380). The ambition of pricing is thus to support the creation of economic value and to contribute to the profitability of the firm. (Dean 1961: 399)

Customers are to various degrees price-sensitive, which mean that the decision to buy to some degree is dependent on price changes. If the cost of a product is a large share of the customer's total cost, the more price-sensitive is the customer. Offerings that have a low level of differentiation are more vulnerable to price changes. Sellers are more motivated to offer price reductions if the number of buyers are high. Buyers tend to be less price-sensitive if the supplier's products are of great importance for the customers' ability to offer their customer value creation. (Grant 1998: 63)

3.3.2.2 Price Discrimination

Mobile operators will be able to use various charging options on packet switched data. Various methods of price discrimination can be used in order to maximize the gain from the customers' willingness to buy.

There are three sorts of discrimination, which are perfect price discrimination, non-linear pricing and third-degree price discrimination. Perfect discrimination means that the producer sells different units of output at different prices where these prices may differ from person to person. It means that the prices may be specific for a certain person, which consequently implies that the pricing can be based on personal perception of the product's value. It further means that the producer appropriates the entire surplus. All buyers have to pay just as much

as they appreciate the product. (Varian 1999: 434-436)

Non-linear price discrimination means that different units of output may be bought for different prices, but every individual who buys the same amount of the good pays the same price. It means that the price depends on how much you buy. The reason for this type of pricing is differences in demanding curves and the difficulty of separating customers. An example is the difference in willingness to pay between a student and a wealthy CEO. The CEO has a higher willingness to pay than the student, but will not pay more if he is not forced to. It is further difficult to separate the individuals if they are wearing civil clothes. The seller therefore has to rely on self-selection, which means that the prices have been set depending on the quantity or the quality of the product. The result for the producer is a higher Appropriation of the created value. (Varian 1999: 436-438)

Third-degree price discrimination means that the producer sells to different people at different prices, but every unit of the good sold to a given group is sold at the same price. This type of discrimination is the most common one and includes discounts for students and senior citizens. (Varian 1999: 440-441)

3.3.2.3 Dynamic Pricing

Opportunities to use dynamic pricing for mobile Internet services increases and can be seen as a way to price discriminate.

Ajit Kambil et al (2002) describes in the article “*Are you leaving Money on the table*” that Internet brings significant changes for the convenient pricing strategies. Internet enables companies to use dynamic prices, where prices often change depending on what channels are being used, what sort of products it concerns, customers’ preferences, time and so forth. There are two major benefits with dynamic pricing. First, companies increase their opportunity to maximize the return on the individual customer. Secondly, the use of dynamic prices is appropriate for companies that have large amounts invested in fixed asset as for instance in technology infrastructure. Dynamic pricing enable these kinds of companies to push demand during slow periods and dampen the demand level in periods when demand is high. Dynamic pricing contributes with a balance between buyers and sellers more suitable for the digital age. Both buyers and sellers get access to broader and more valuable pricing options with higher potential for value creation. Companies with high visibility in their system and low costs of changing their prices as well as the opportunity to communicate prices online are well suited for dynamic pricing. Those can use three strategies for dynamic pricing, which sometimes can be combined. The alternatives are time-based pricing, segmentation and dynamic merchandising. (Ajit Kambil et al 2002: 41f.)

Time-based pricing uses the opportunity to take advantage of the customers’ will to pay different prices at different times. In this category peak-load prices are appropriate to apply when the conditions permit the seller to increase prices systematically when there is an increase in demand. Another way of taking advantage of time based pricing is through the use of clearance pricing. This is to be used when products goes out of fashion quickly. Companies with short life cycle products then have to mark down the products in order to decrease the inventory. (Ajit-Kambil et al 2002: 41f.)

The second alternative *segmentation* explores the opportunity to make use of the customers’

will to pay different prices depending on what channels are used, time matters and their own effort. In order for companies to use this strategy they have to be able to provide specialized service bundles that are priced differently based on variables such as product configuration, channels, customer type and time. (Ajit-Kambil et al 2002: 41f.)

The third alternative to take advantage of dynamic pricing is through the use of *dynamic merchandizing*. This method is used when companies use Internet in order to provide customers with different products, promotions and dynamic pricing strategies as supply and inventory changes. (Ajit Kambil et al 2002: 42)

Ajit Kambil et al (2002) conclude that in order for companies to fully take advantage of dynamic pricing they have to develop capabilities in three areas. First they have to develop “*sense-and-respond capabilities*”. In order to know how to change prices companies have to be able to anticipate changes in demand patterns and customers buying propensity. Secondly companies need to create *internal visibility* in order to control inventory levels and be able to identify opportunities to use dynamic pricing strategies. Finally companies have to develop new kinds of pricing models and evaluate how different customer groups will respond to dynamic pricing in order to build dynamic pricing capabilities. (Ajit Kambil et al 2002: 43)

3.3.2.4 Bundling

Bundling is another method to be used in order to price discriminate.

Bundling means that complementary goods are sold together. When selling to several different people, the price is determined by the purchaser who has the lowest willingness to pay. If the offer is bundled the total divergence of the valuation is reduced. It means that the valuation differs more from person to person when considering one single product at the time than it does when considering the bundled offer. The result will be that if the producer bundles the offer, more customer value will be appropriated. (Varian 1999: 444f.)

In the article “*Reconfiguration of Value Chains in Converging Media and Communications market*” Wirtz (2001) views bundling as one of the major advantages with the integration of companies providing communication solutions and companies with its origin within the media industry. The integration enables multiple customer bonding such as reaching customers through different channels or in various relations. Electronic integration strengthens multiple customer bonding in two areas. First the opportunity to develop more sophisticated personalization services increases and thus the customer relationship becomes stronger. The opportunity to deliver more service packages that cover the customers’ need also increases. Bundling of different multimedia services can be complemented with price bundling of the services, which decrease traditional sector barriers. (Wirtz 2001: 499ff.)

3.3.2.5 Two-part tariffs

Two-part tariffs also offer a way for a producer to price discriminate. The method can be illustrated by a consumer paying a subscription fee for access to a telephone network and then being charged for each unit of usage.

In the literature the so-called “*Disneyland Dilemma*” exemplifies the problem of two-part

tariffs. It is possible to split the customer value into two parts represented by the entrance fee and the fee for each ride. The conclusion is that the price for each ride should be set related to the marginal cost. In such case the total surplus, consisting of producer and consumer surplus, will be optimized. If no entrance fee will be charged then the entire surplus will accrue the consumer. The producer's ability to discriminate is enabled through the use of an entrance fee. In most cases the amusement parks solves the problem with only an entrance fee. The reason is that the transaction costs for charging are higher than the marginal costs and hence the billing of rides is not profitable. (Varian 1999: 446-448)

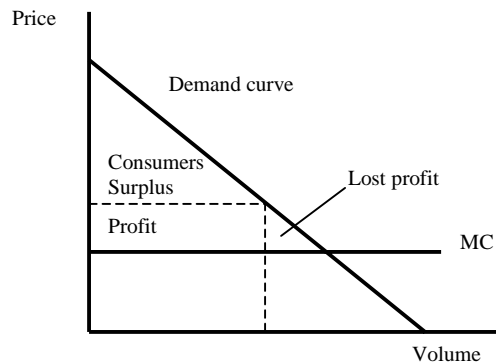

Figure 3.1 – Two part tariffs

Shows how a company experiences lost profit without two-part tariffs discrimination. The lost profit for the company can be regarded as the lost profit plus the consumers' surplus. These two areas are minimized through the use of two-part tariffs discrimination. The fee for each ride will be equal to the marginal cost (MC) and the fee for entrance will cover the consumers' surplus area.

3.3.2.6 Characteristics of subscriptions

This section highlights the subscription method from a price discriminating perspective. It highlights some of the advantages and disadvantages with this method of charging customers.

Glazer & Hassin (1982) describes in the article “*On the economics of subscriptions*” characteristics of subscriptions that motivate companies to use this form of contract. When a firm offers a subscription the customer is paying in advance for a product or service not yet delivered. The firm gets a loan from the consumer and undertakes the commitment to deliver according to the contract for a specific amount of time. The risk taken by the firm, for example variations in cost behaviour, becomes to some extent compensated by the accurate information on future demand. Through a subscription-based contract the customer can face a situation where he buys a product, of which he does not know the quality or price characteristic. The major disadvantage with a subscription is that the customer only knows the expected value of the product. A spot transaction, on the other hand, results in that the consumer knows the exact value of the purchase. A spot transaction enables for the consumer to make the purchase only when the value is higher than the price. (Glazer & Hassin 1982:343ff.)

3.3.3 Allocation

This third part of the theory relating to the revenue model introduces oligopoly theory and conditions that have had to exist in order for companies to create successful alliances and networks. At the end it highlights the need for a broader scope of understanding of cost implications.

3.3.3.1 Oligopoly pricing

This section introduces oligopoly pricing. This market condition has been characteristic for the telecom industry, containing few large companies in control of access and prices. Oligopoly pricing is important in order to understand the dynamics and the allocation of the total value created in the industry.

Dean (1961) points out that oligopoly occur when there are few sellers in the market and they are offering homogenous products. The players have to take into consideration cross elasticity, which means that each player, when making a price decision, has to take the actions of its rivals into consideration. Two kinds of oligopolies can be identified, *pure oligopoly* and *differentiated oligopoly*. The later refers to a situation where the sellers' products differ for the customers. This could be based on branding or perceived quality. Even so, a company watches price policies of its rivals as a result of a perceived similarity between their products. Pure oligopoly occurs when the similarity between competitors offerings are high. (Dean 1961: 427)

Dean (1961) furthermore concludes that competition on oligopoly markets is characterized by, in addition to similar offerings, similar cost behaviour. The number of competitors does not have to be definite, but can range from a few players to a large number of companies. A major force threatening an oligopoly is changes in demand. A decrease in demand generates over capacity, which leads to aggressive competition. This occurs more often in industries that are characterized by a high level of investments. The aversion of price competition in these types of industries is based on four factors. First, other players will respond to a price cut instantly in order to protect their relative market share. If price cuts have been conducted it will be difficult to raise the price level back to previous levels. Secondly only increased cost and demand levels can strongly motivate price increases. Thirdly sellers act with the belief that demand is inelastic and therefore decreases in price will not increase sales. The fourth aspect has to do with the certainty aspect. Certainty within an oligopoly system prevails if there is consensus concerning the effects of price changes and demand fluctuations. When actors on the other hand experience different implications and have different views of general demand conditions, future price conditions and have different notions about the industry elasticity of demand with respect to price, uncertainty can make the economic system unstable. Dean (1961) presents two tools that can be used in order to manage the potential disruptions. (Dean 1961: 427-431)

The first is based on Non-Price competition that occurs when beliefs are strong that the perceived uniformity is more important for pricing decisions than physical differences. Non-price competition can be applied through product developments, innovations and promotional campaigns. Competition based on variables that have no impact on prices are more difficult to retaliate by other players. A second method to create stability is Price leadership, which is

another way of managing and preventing uncertainty and price competition within an oligopoly. Price leadership occurs when one player initiates the price change and the other companies adjust their prices to the new price level set by the price leader. Price leadership can be seen as a silent agreement between significant actors concerning how prices should respond to changes in cost structure and demand. The price leader is often a firm with a significant market share and with an accepted price policy. The difficulties of implementing a price leader system increase when the differences between quality, service and reputation are significant. The firm holding the price leading function is often a firm operating in segments characterized by higher quality. (Dean 1961: 433-438)

3.3.3.2 *Alliances and networks*

Various types of alliances characterize the telecom industry. Below follows a presentation of aspects and conditions that can increase the potential of alliances to succeed.

Byrne et al (1993) describe in the article “*The Virtual Corporation*” the prerequisites a virtual organization has to fulfil in order to work in accordance with its purpose. A virtual corporation consists of a network containing independent companies, suppliers, customers and in some cases competitors. The actors are linked together by information technology and share costs, skills and markets, and have no appointed leader. Companies will conduct and provide only the activities they consider to be their core competence. Technology is seen as the major force driving the development of the virtual corporation. The benefit of belonging to a virtual corporation is the increased power and flexibility for individual corporations. The disadvantage with belonging to a virtual corporation is the decrease of control over some of the company’s operations and risk of losing property rights. (Byrne et al 1993:36-40)

Another significant challenge for companies that participate in a network is to develop trust on a high level to each other. The partners have to be chosen so that they can be trusted and offer a relevant product or service. The partnerships within the virtual corporation must be based on a win-win deal. This means that the partnerships must serve the interest of all parties, even if the result sometimes becomes unsatisfying. Companies choosing to participate in a partnership must be clear of what kind of results they want and what objective they have for involvement in the virtual corporation. (Byrne et al 1993: 40)

Hamel et al (1989) concludes that firms in alliances have to understand that collaboration is competition in another context. In order for parties in an alliance to be able to share benefits three factors has to be fulfilled. The *strategic intent* of the partnership has to be shared between the parties. Partnerships also have to be characterized by the opportunity for each actor to *capture and incorporate* relevant skills from others. The more skilled a firm is in the process of *identifying* what they want to gain from an alliance the higher the possibility doing so. (Hamel et al 1989: 133-139)

Chan-Olmsted & Jamison (2001) study in the article “*Rivalry Through Alliances: Competitive Strategy in the Global Telecommunications Market*” the strategies and strategic alliances in the global telecommunications market and the factors that have acted as drivers for these alliances. The authors of the article conclude that in order to achieve growth in the global telecom market, a telecom company has two choices. It can develop its own products and services, using its own resources or it can collaborate with other firms. Growth through the use of own resources have the advantage that the company can control and choose between markets and technology. The disadvantage with this strategy is the lack of brand

awareness and local industry knowledge. The costs associated with this growth strategy are also higher and the risk increases. The other alternative for entering a new market is through the use of alliances. The interest for participating in alliances can be based on the opportunity to gain specific knowledge, share risks, build strategic synergies and speed up joint ventures. (Chan-Olmsted 2002: 317-322)

Chan-Olmsted & Jamison (2001) describe three variants of alliances; *Concert*, *Global One and World Partners*, which are the three major alliances between mobile operators seen in the global telecom industry. Common for all these alliances is that they all have been restructured from their initial design. The redesign depends on two factors. The first is *Cultural, Strategic and Managerial Differences*. It is very difficult to succeed with the formation of a uniform strategy since the different telecom companies have different management styles. In order to integrate the companies successfully there has to be trust between the actors within the alliance. In order to achieve trust, the companies have to risk losing some of its core competences to competitors and alliances also decrease the autonomy of the individual company. The second cause is differences in *Objectives and Visions*. Various telecom operators formed partnerships with different motivations and visions regarding their future within the alliance. The result of this is inefficiency and conflicts, for instance concerning what kind of services different operators should offer. The creation of alliances within the telecom industry has had two stages. In the first stage the players joined alliances in order to experiment, defend themselves and keep their options open. This resulted in alliances and partnerships that were ill defined and did not reach their objectives. The second stage, where the industry is today, is characterized by a customer solution driven alliance strategy. Telecom companies are entering markets where their global customers are present and are developing solutions that enable them to improve their coverage and integrate new features. The market is characterized by a convergence between telecom infrastructure and media access, leading to a global industry integrating distribution multimedia, content and applications. Chan-Olmsted & Jamison conclude that the trend towards globalization will continue and joining alliances will continue to be a way of competing. This is because the industry rewards competition, scale economy and delivery of integrated content to demanding global customers. (Chan-Olmsted & Jamison 2002: 325-328)

3.3.3.3 Understanding the complementors

This section aims to create an understanding of a company's role as an actor in the value creating process and the effect internal activities have on other companies.

Shank & Govindarajan (1993) offer in the book "*Strategic cost management*" a value chain perspective for managing the cost structure. A value chain perspective recognizes the importance of looking outside the company in order to fully understand how the cost structure is driven. The company is seen as a player in a wider value delivery system. The authors conclude that in order for the firm to gain a competitive advantage an understanding of the entire value delivery system has to exist. This means that the company has to understand how the firm's value creating activities impact on the suppliers' and the customers' value chains. The value chain perspective focuses on four profit improvement areas. The external profit improvements areas are *linkages with suppliers* and *linkages with customers*. Areas possible for internal profit improvement are *linkages within the firm's value chain* and *linkages across value chains within the firm*. (Shank & Govindarajan 1993: 48-55)

Beneficial external linkages refer to linkages that all parties benefit from. Linkages with suppliers should be developed in order for the firm to help the supplier decrease costs. Linkages with customers should be developed and analyzed in order to create an understanding of how the products fit into the customers' value chains. (Shank & Govindarajan (1993: 57f.)

3.4 Summary of the theory chapter

The theory chapter creates the theoretical framework essential to analyze the problem. It consists of three parts, which are Business landscape, Business models and Strategy, and Revenue models.

3.4.1 Business landscape from player and business conditional perspective

The *Business landscape* part consists of three subsections; *Development of the business landscape*, *Forces in the business landscape* and *New organizational constellations*. All three are related to and mainly affected by technological progress and development. The first subsection illustrates the major change in strategic paradigms due to the change in environmental conditions. Normann (2001) introduces the concept Prime Mover that is a player that probably will be successful in what Normann (2001) defines being the new economy. Eneroth & Malm (1999) highlight the importance of fitness to the business landscape through the concepts knowledge webs and generative relations. Finally Porter & Stein (2001) introduce factors that make a business landscape innovative. In the section *Forces in the business landscape*, Arthur (1994), Schilling (1999) and Pitt (2001) illustrate the forces and the dynamic conditions that affect the value creation in the business landscape and how to generate revenues under these conditions. Concepts such as *dominant design*, *increasing returns*, *aggressive marketing*, *bundling* and *diffusion of the technology* are introduced. In *New organizational constellations*, the players in the business landscape are organized through a comprehensive activity classification. Different types of organisational constellations are described by Werbach (2000), Hougaard & Johannsen-Duus (1999) and Hagel & Singer (1999).

3.4.2 Business models from a strategy and network perspective

The second section in the theory chapter is the Business models and Strategy part, which consists of five subsections; Business models, Strategy and strategic options, Strategy and strategic options from a network perspective, The Delta model and Strategic issues within the mobile industry. The first subsection deals with the concept of business models and what it includes. Magretta (2002) and Amit & Zott (2001) contribute with their definitions and understandings concerning business models. The next subsection handles competitive advantages and how to create them, mainly within the company. Porter (1980) is one of the authors. The third subsection, Strategy and strategic options from a network perspective, deals with competitive advantages but from a network perspective. The network perspective highlights the importance of inter-organisational relations in order to create competitive advantages. The fourth subsection is about the Delta Model introduced by Hax & Wilde (2001) and introduces a framework for the opportunities in the new business landscape. The last subsection introduces opportunities and requirements specific for the mobile Internet industry.

3.4.3 Revenue models - Valuation, Appropriation and Allocation

The third and last section in the theory chapter concerns revenue models. There are three major subsections. The section *Revenue models* consists of *Valuation*, *Appropriation* and *Allocation*. *Valuation* includes how to determine basic prices. Lynn (1967) introduces

concepts as profit-based price, cost-based price and volume-based price. Dean (1961) introduces industry maturity as a concept that affects the characteristic of the pricing problem. The next major subsection is *Appropriation*, which deals with different techniques to appropriate the created value. Dean (1961) presents skimming and penetration pricing as ways of appropriating created value. Ajit Kambil (2002) discusses dynamic pricing that could be an important appropriating technique for digitalised services in the future. Dynamic pricing is a way to price discriminate and suggests that prices continuously are adjusted to the demand fluctuations. Wirtz (2001) emphasises the major advantage that bundling involves and that this possibility is a result of the convergence between the telecommunication and the media industry. *Allocation* is the last subsection. It deals with aspects important for allocation of the created value. The value must be allocated in a way that positively affects the value creation for the industry as a whole, the value creating network and the firm. These three levels of value-creating are correlated. Dean (1961) represents oligopoly theory, which is important in order to understand the allocation of the industry value. Chan-Olmstedt & Jamison (2001) highlight different kinds of alliances and what is important about them. Alliances are important in order to understand the value allocation between the players within the network.

4 The Mobile Internet Industry

This chapter aims to create a picture of the mobile Internet industry. It contains the empirical information subject to analysis and is structured similar to the theoretical framework. It starts with the business landscape, describing the market conditions and introducing the different actors. Thereafter business models and strategic issues are presented. Six different alternative business models from the mobile Internet industry are presented and described, mainly in terms of how value is created. Finally the empirical information related to the revenue models is presented, based on the determinant activities valuation, appropriation and allocation. The chapter presents views of the interviewed actors from the mobile Internet industry as well as secondary material.

4.1 Business landscape

The business landscape aims to describe and visualize the characteristics of the mobile Internet industry and the conditions present within the industry. It is also meant to introduce the various actors within the industry. First characteristics of the mobile Internet industry are introduced. The next subsection deals with different environmental aspects. Thereafter changes in the business mindset are described. The fourth subsection describes the forces present in the business landscape and the last part handles new organizational constellations in terms of the new players' roles and revenue flows.

4.1.1 Market characteristics

The mobile Internet industry is a young and undeveloped market. New industry actors try to specialize on certain parts of the value chain in order to develop profitable positions. This fundamental structuring causes competitive and crowded value chains. It also makes long-term partnerships important, since no one is able to satisfy the variety of demand on its own. Ovum expresses that the requirements, in terms of technology, experience and knowledge about the customer, are too high to be dealt with by a single firm (Ovum 2001: 1-3).

In the mobile Internet industry there are great costs and huge investments made regarding network infrastructure, licenses and R&D. Anders Jensen, Business Enabling Solutions Manager at Vodafone Sweden, goes as far as describing the investments in the mobile Internet industry as the greatest since the railway was built (Jensen, A. 2002-04-24). Ovum concludes that the cost of delivering wireless content is rising with the increased technological sophistication and the most obvious costs are the costs for network upgrades, enabling platforms, applications and content, plus the development of multi-functional and browser-equipped devices. (Ovum 2001: 1)

4.1.2 Different environmental aspects

All markets are different in some sense and macro factors such as financial resources, human capital, technology and legal restrictions are affecting the market development and the market behaviour. Regina Wong at Ovum claims that the most important factors for the mobile Internet industry may be culture and social behaviour (Wong, R. 2002-05-13). Rune Myrthue, Manager Business Intelligence at Orange Sweden, also states that cultural as well as emotional differences are strongly influencing the market conditions. He emphasizes that one

of the main reasons for the success of i-mode is related to the restrictive expressions of emotions in Japan and that the way of communicating feelings through an interface is well suited to the Japanese culture. (Myrthue, R. 2002-05-08) Per Bergman at Aspiro also comments on the success of i-mode and states that it is much a metropolis phenomenon. This is related to the dense population of the area which in turn influence the habits of the people. An example of that from the everyday life in Japan are the hours of travelling between the home and the workplace, during which mobile services are attractive. Per Bergman further exemplifies that the penetration of home computers in Japan is low and that the first interaction with the Internet often is through the use of the i-mode terminal. (Bergman, P. 2002-04-26) Rune Myrthue at Orange claims that there are also differences in customer preferences between the Japanese and the Swedish market. The Swedish market consists of high-end consumers in terms of media spending (commercial television, newspapers, Internet and advertisements), whereas the Japanese consumers to a higher degree tend to prefer games and entertainment. (Myrthue, R. 2002-05-08)

A huge future market for mobile Internet will be the Chinese. Regina Wong at Ovum states that this market is quite immature and the operators are still picking up voice-subscribers. Regina Wong also explains that content to a large extent is locally related which implies that any future content provider has to know the Chinese language and culture. These factors will affect the market approach for the Chinese mobile industry. (Wong, R. 2002-05-13)

4.1.3 Change of mindset

There has been a strong focus on technological issues within the mobile Internet industry and in some sense the customer has been forgotten. It now seems as if the industry has learned by their mistakes and realised that no technology is more important than the customer. Rune Myrthue, at Orange, emphasizes that there are still major technological problems within the industry, but that focus should not be kept on the technological aspects. He feels that the industry has to direct their minds towards the creation of customer value. Rune Myrthue does not think in terms of technology or data capacity, but rather in terms of willingness to pay and customer value. He states that the consumer should not be reminded of the technological complexity. The focus should instead be on making the services simple to use in order to increase adoption. (Myrthue, R. 2002-05-08) Per Bergman at Aspiro comments on the topic and emphasizes that the marketing of WAP was extremely misdirected. To conceptualize a customer solution around an application protocol seemingly was a big mistake since the customer does not care about the technology but rather the services. He concludes that the technological concept, WAP, does not communicate the customer value at all. (Bergman, P. 2002-04-26)

According to Anders Jensen at Vodafone, the reason for the failure of WAP was that the industry assumed that the technology was the driving force. Anders Jensen emphasizes that everything has to be on the customer's terms. It is not the technology that is the bottleneck, but rather the customer. The customer has to be able to absorb the technology and the services. Anders Jensen concludes that it is the customer's ability to appropriate different values and services that drives the industry forward. (Jensen, A. 2002-04-24)

4.1.4 Forces

The development of the mobile internet industry is driven by a number of different forces that are also influencing each other. The most basic and underlying force is the human need to communicate, but the development of the industry is also influenced by forces such as

bargaining power, competition and gold-rush mentality.

Anders Jensen, at Vodafone, believes that the environmental development is more evolution than revolution. Basically it is all about communication and this is the next step in the communicational evolution. Now people will be able to do business with each other in an even simpler way. After all it is the human need of communication that is the underlying force of this industry. Jensen feels that the human need to communicate is on the same essential level as getting food and reproduction. (Jensen, A. 2002-04-24)

According to Ovum, the new business landscape means new ways of doing business and new business models. But the conditions are leading to a wide variation of business models and development between different regions. (Ovum 2001: 1) Regina Wong, at Ovum, expressed that the key determining factor, when talking about revenue sharing and business models, is not so much the maturity but rather the bargaining power between operators and content providers. (Wong, R. 2002-05-13) Rune Myrthue, at Orange, claims that the operators are key players but absolutely not the only ones. They have to develop partner relations and enable revenue sharing for content providers as well as to solve the billing problem in order to succeed and create long-term revenue streams. Otherwise the huge industry investments will be lost. (Myrthue, R. 2002-05-08) Regina Wong, at Ovum, emphasizes that there are no actual wireless Internet market or potential Internet market before revenue sharing and applications provision appear. (Wong, R. 2002-05-13)

The mobile Internet industry has been characterized by a gold-rush mentality rather than by strategic choices. Many companies rushed into the market for fear of being left out and in many cases before there was any revenue potential within the market. This in addition to a growing competition has caused consolidation. (Ovum 2001: 3) Kenneth Sandevi, Business Developer at the content provider and aggregator Aspiro, feels that there are many different players that are trying to shorten the value chain and integrate a larger part of it in order to increase margins and broaden their own businesses and thus get a larger piece of the market. This is most usual during introductory stages, when revenue streams are small. (Sandevi, K. 2002-04-26)

4.1.5 New organisational constellations and the industry actors

The mobile Internet industry has not yet settled for a common and industry wide organizational constellation. There is in other words no consensus within the industry regarding how business should be conducted. Even in the classifications of the industry actors there are no common understanding. To be able to analyse the possible business models within the mobile Internet industry we needed a classification of the actors and their respective activities. Furthermore we needed a language to communicate and visualize how the industry is organized and what streams it contains. Ovum (2001) presents a useful and comprehensive model of this, which is illustrated below. Ovum's framework is clear and allows us to communicate possible business models and it harmonises with the purpose of this thesis.

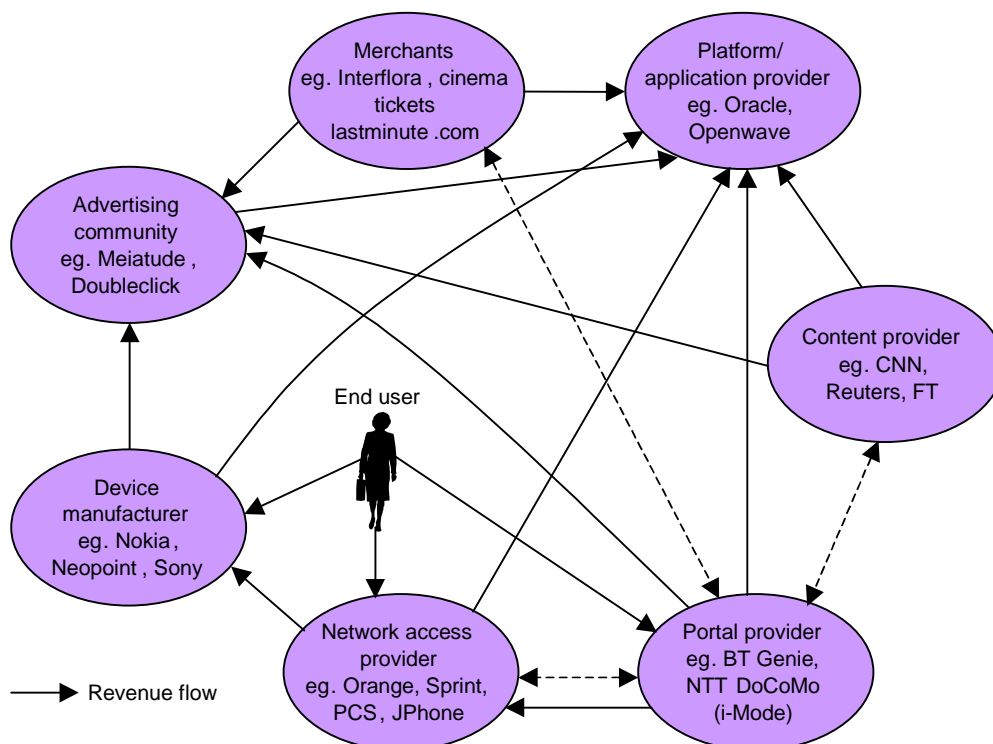

Figure 4.1 - The wireless Internet value web

This model illustrates the actors in the mobile Internet industry and their roles. The figure also shows the revenue flows and the nodes of revenue sharing. Actors can manage several roles and consequently operate a larger number of revenue flows. Brand power and one-to-one negotiations influence the revenue flows and imply that there is no set structure at present.

Source: Ovum 2001: 6

4.1.5.1 Network access provider

The network access providers (NAP) consist of mobile network operators (MNO) and mobile virtual operators (MVO). The MNO owns the network infrastructure and operates the traffic. The MNO is also able to supply network access services. The MVOs buy network capacity

from the MNOs and consequently they are able to manage their own customers. (Ovum 2001: 2) All respondents have emphasized their interest of access to the valuable customer information that may be generated from the usage of the networks. Other important concerns for the network access providers are the customer relation, which allows branding and billing. Since the investments in network infrastructure are huge, there is also a major difference between the MNO and the MVO concerning their structure of costs.

4.1.5.2 Device manufacturer

The device manufacturers include producers of access devices such as mobile phones, smartphones, PDAs, laptops, hybrids and other devices. The device manufacturers are mobile phone manufacturers, computer manufacturers and consumer electronic manufacturers.

4.1.5.3 Merchants

The merchants consist of companies with consumer brands such as banks, financial services companies, retailers and travel agencies. They may sell and market any type of products and services.

4.1.5.4 Platform and application providers

The platform and application providers are wireless application service providers (WASPs), network infrastructure vendors, middleware vendors and application developers. They develop and/or supply enabling platforms and applications, middleware solutions, manage services hosting and support functions. (Ovum 2001: 2) Platform and application providers are companies that develop technological solutions both in terms of hardware and software such as Ericsson and Microsoft.

4.1.5.5 Content providers

The content providers develop and/or aggregate content for the mobile Internet. They are among others represented by traditional publishers, media firms, online aggregators and mobile network operators. (Ovum 2001: 2)

4.1.5.6 Portal provider

The portal is a hot spot where users are concentrated to exchange content, to communicate, to conduct commerce and to use any type of services, belonging to a certain community. The portal providers are for example network operators, fixed Internet portals, independent portals and device vendors. The customer relation is the main concern and all major European operators have launched a branded portal strategy. This is the most competitive section of the value network in the mobile Internet industry. (Ovum 2001: 2, 13)

4.2 Business models

The first part presents six business models suited for the mobile Internet. The five business models first presented have been identified and described by the wireless analysts Ovum. The last business model presented deals with WLAN. Attached to the presentations of the business models are the respondents' views of the models. The business models that are presented are not mutually exclusive. They can be used in combination with each other or separately (Ovum, White paper, 2001: 7). From then on general areas relevant to the mobile Internet business models are discussed. These areas are primarily content, structure, governance, strategy and general economic logic. The purpose of these sections is to provide an understanding of the respondents' views on aspects and topics that were frequently discussed during our interviews.

4.2.1 The paid for content business model

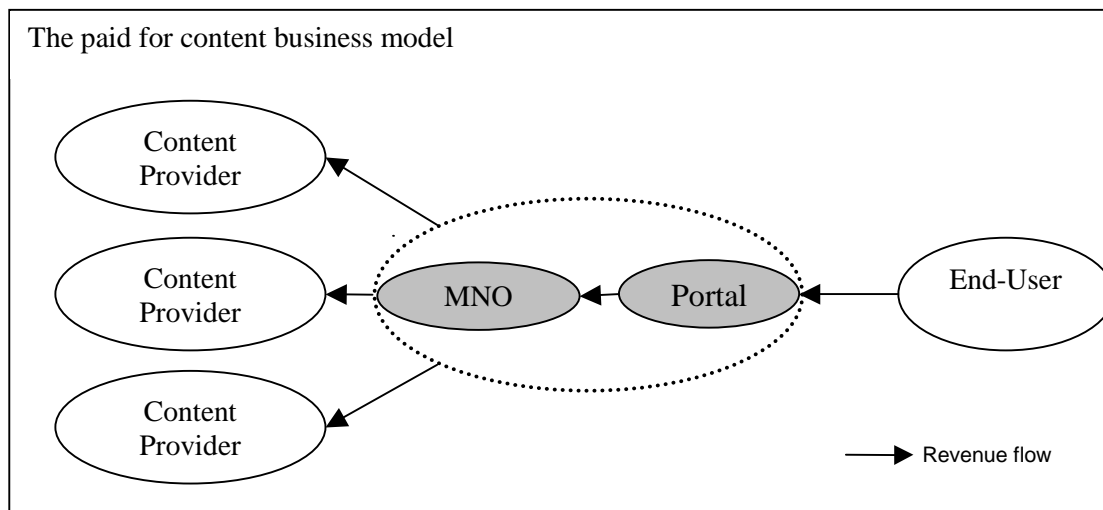

Figure 4.2 – The paid for content business model

In the paid for content model the end-user pays for both access, traffic and the content.

The most important actors within this business model are the network access providers, the wireless portal providers and the content providers. The MNO may take both the role as network access provider and as portal provider, or chose to use an independent portal provider. The business logic of this model is that customers should pay for content. The revenue derived from the content is divided between the portal provider, the MNO and the content provider. The network access providers benefit from increased traffic, which is accomplished by increased use of content. For the content providers, the benefit with this business model is the transparency. They get great knowledge concerning earnings, given a specific frequency of content usage. (Ovum 2001: 7)

According to Kenneth Sandevi, Business Developer at Aspiro, there is no common understanding regarding the levels of the revenue sharing agreements between the operator and content providers. Even so, he believes that the operators have realized that they need to open the structure and share the revenue with the content providers, if they want this business model to work properly. (Sandevi, K. 2002-04-26)

The Japanese operator NTT DoCoMo uses this business model to deliver its i-mode service. (Ovum 2001: 7) In the master thesis “*Can European operators learn from i-mode*”, by Derefeldt et al 2001, three important factors of how the i-mode model generates revenue are highlighted. First, NTT DoCoMo as the network access provider is responsible for charging the customers for the use of services and takes a provision of nine percent of the price for the content or service used. Secondly, the customers get charged for the amount of data that they receive or download. One package of data consists of 128 bits and costs 0.03 Yen. The third revenue stream comes from the monthly subscription fee that the customers have to pay in order to access and use i-mode. I-mode offers a rich range of services such as mobile banking services, e-mailing and entertainment such as games. (Derefeldt et al 2001: 25-34)

Derefeldt et al (2001) further explains that the MNO, NTT DoCoMo, governs this business model and is located in the centre of the value creating process. Value is created, for the end user, through the development of mobile services. NTT DoCoMo has strong relations with the device manufacturers, which can be seen in the design of the mobile phones. This collaboration ensured that there were phones available on the market early in the launch stage of i-mode. The terminals manufactured for i-mode can only be used for the i-mode services and not for any other mobile Internet services. NTT DoCoMo also has strong relations with the content providers. The operator has transferred the responsibility for content development to these partners to be able to focus more strongly on the core operator business and the marketing. Because of the high requirements that DoCoMo puts on its partners regarding the quality of the content, only larger firms with high capacity and quality are involved in the content development process. The DoCoMo business model for mobile Internet does not have any strong competitor in Japan, which depends on four factors. The strength of the I-mode brand is the number of collaborators that DoCoMo has partnered and thus enables a wide range of services to be offered to the users. According to Derefeldt et al (2001) much of the success of NTT DoCoMo’s i-mode is a result of the competence to manage both the customer and the “*service base*”. (Derefeldt et al 2001)

4.2.2 The free content business model

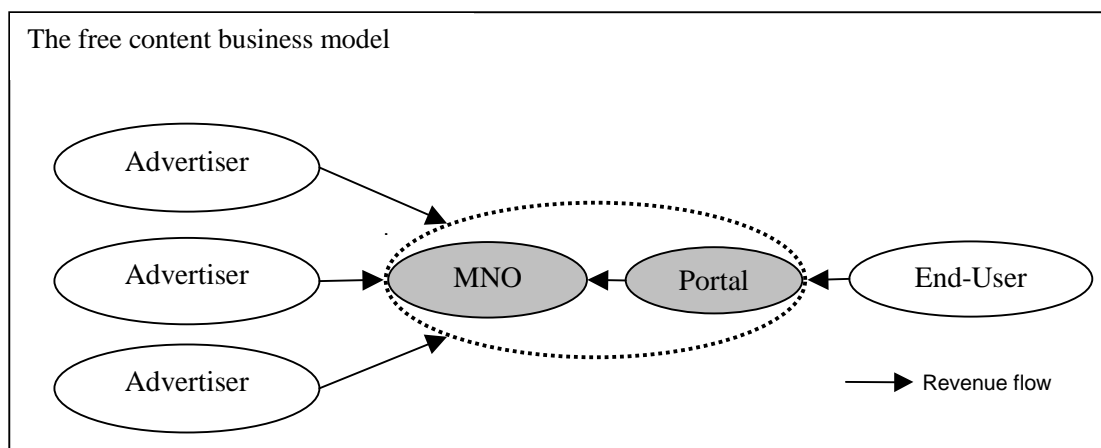

Figure 4.3 – The free content business model

In the free content model the end-user pays for the traffic in the mobile network, but the content is free and provided by advertisers.

Source: Ovum 2001

Operators or portal providers supporting the free content model do not think that customers are, nor will be, willing to pay for content. Today this view is much a result of the limited number of services available for mobile Internet. However, with a wider development and usage of services based on 3G technology most actors believe that it will be possible to charge for content. (Ovum 2001: 7f)

The portal provider offers content for free and gains revenue from selling advertising space on the portal. The advertisers are the main providers content and services on the portal. Portal providers have the opportunity to charge based on the revenue generated as a result of the advert. This is most likely to happen if the service provider is a merchant. Portal providers are in that case charging between 20-50% of the direct revenue that the transaction generates. The portal provider can also have the role as network access provider, which results in that no fee for the network access is paid. The users only pay traffic fees for the use of the network and do not pay for the specific content. (Ovum 2001: 7f)

The free content model has different revenue models with streams generated in different combinations. No standard revenue model is yet widely accepted and considered the best fit within the industry. Except for the transaction revenues, three significant revenue streams can be identified. First, mobile marketing is a revenue stream where the portal providers help the advertiser with campaign management services and thus collect revenue from this activity. Secondly the portal provider could collect revenue from portal site fees, paid by companies wanting to use the site for advertisements. In order to do this, the portal provider needs to have a strong brand and a strong customer base. A third alternative to collect revenue is to share the incremental revenue, between the portal provider and the advertiser, from increased traffic. According to Robert Vass at SonyEricsson, the only obvious source of cash flow for the operator is from the end consumer. Advertising might nonetheless have potential to become a substitute for this source of revenue. (Vass, R. 2002-04-16) A major benefit with advertising over the mobile Internet is the ability to be able to reach customers directly. Telecom Italia Mobile (TIM) has had an enormous success with the TIM Spot service. The TIM spot service is based on free SMSs sent to the customers, providing a combination of news and advertising messages. TIM is seen as an innovative player in the world of mobile advertising and was first to introduce an interactive TV commercial. (www.tim.it, *Enormous success of smart tim and timspot: An innovative form of advertising is born through the mobile phone*, 2002-05-15)

4.2.3 The intelligent facilitator business model

According to Ovum, the mobile network operators employing *the intelligent facilitator business model* are aiming at maximizing the leverage and the value of the mobile network and to provide a leading edge infrastructure. Different kinds of support services are offered to third parties, such as content providers and individual portals. The services offered by operators can range from wholesaling of airtime, billing support, tracking solutions and hosting of different kinds of services. Ovum believes that the role for an operator as an intelligent facilitator will become more attractive due to the development of 3G infrastructures. The operators will try to find ways to increase their revenue potential through offering different kinds of services to third parties. Facilitating for third parties can also increase the traffic within the network. This also stimulates the need for support services such as billing. (Ovum 2001: 9f)

According to the analyst Ovum the need for a strong and competent partner is significant for third party players trying to enter the mobile Internet industry. A specific design of the business model is difficult to describe since this to a large extent depends on what kind of services the operator offers or will offer to third party players. The arrangement with partners will most likely be negotiated on a one to one basis. There are three areas where the intelligent facilitator can earn significant revenue. First, the intelligent facilitators may profit from increased network usage as a result of their ability to attract content providers that appreciate the services highly. A second alternative for the intelligent facilitator is to charge the third party providers using license fees. Third party providers pay the intelligent facilitator based on the amount of transactions. The services they pay for include different kinds of service platforms and solutions. A third revenue generator is the billing services. Many small actors do not have the capacity or the resources to bill the customers on their own. (Ovum 2001: 9f)

Eva Helen Lundgren, at Vodafone, concludes that the operators become attractive for third parties since they have the billing competence and the billing relationship with the customer (Lundgren, E-H. 2002-04-24). According to Anders Jensen, at Vodafone, an important mission for Vodafone is to enable the communication between content providers and end-users. He explains that the bit pipe role does not have to be negative. The operators can succeed in this role if they are skilled at helping actors to deliver their message to the end-users. Jensen explains nevertheless that Vodafone owns more value in their relations than what would be characteristic for a bit pipe provider. (Jensen, A. 2002-04-24)

4.2.4 The MVO business model

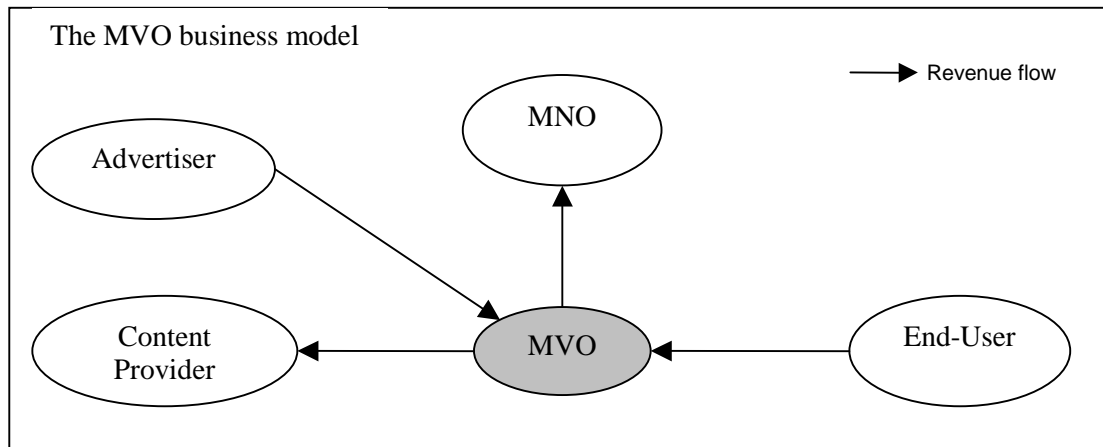

Figure 4.5 – The MVO business model

The MVO business model is based on the MVOs buying airtime from the MNOs and managing their own customers.

Source: Ovum, 2001

The mobile virtual operators (MVO) resell services of mobile network operator (MNO) and provide additional services on their own. MVOs are more flexible than MNOs since they do not own any infrastructure and are thus allowed to focus on branding and service development. MVOs normally have a wide range of services in their portfolio, which they use to develop solutions for the customers. According to Ovum a full MVO is in control of branding and in what kind of services to offer. (Ovum 2001: 10f)

The MVO business model consists of MVOs buying airtime and network services from the MNO. The structure of the commercial agreements concerning the wholesale deals of network capacity is somewhat insufficient, partly since the MNOs are in a very strong bargaining position and have not yet fully identified the benefits and risks of selling capacity to MVOs.

Frederick du Hane at Dial n' Smile explains his view of the mobile network operator as a partner, since they do not target the same customers. He explains that the advantages for mobile network operators, when they are running business with the MVOs, are that they only need to manage one customer relation. Even so, they often earn more from the MVOs' customers than on their own. (du Hane, F. 2002-05-07)

Anders Jensen at Vodafone admits that the MVOs are competitors to Vodafone, but explains further that if Vodafone are to compete with the MVOs, Vodafone might as well profit from them (Jensen, A. 2002-04-24).

Robert Vass at SonyEricsson believes that the MVOs are to be viewed as the dark horses within the mobile Internet industry. He believes that some of these players probably will have the potential to find a niche for themselves. (Vass, R. 2002-04-16)

4.2.5 The enabling platform business model

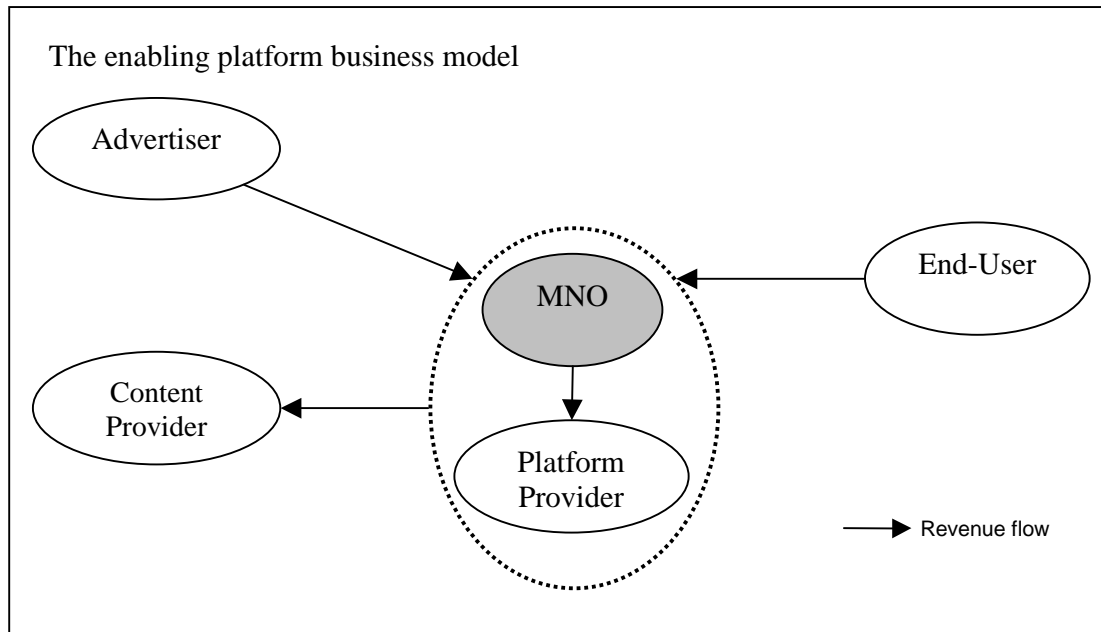

Figure 4.6 – The enabling platform business model

In the enabling platform business model the MNO pays the Platform provider for the technological support and the platforms, whereas they manage the relations with the customers and the content providers themselves.

Platforms (in Platform provider) refer to the technological infrastructure of the mobile networks that enables mobile devices to connect to applications and services. The platform technology is getting more and more standardized and in the future there may be actors specialising in providing the platform technology. These actors may be able to add new and valuable service solutions to the MNOs, so that the MNOs are allowed to focus on the relation with the end-user and the content providers. (Ovum, 2001: 11f.)

The basic platforms for mobile Internet consist of five fundamental parts. (1) The hardware components of the platform that consist of servers and gateways. (2) Basic platform services such as tools for security, customisation and content adaptation services. (3) Operational support services (OSS) consist of solutions for customer care, usage tracking and billing services. (4) Network services include streaming, network security and personal communication. (5) Application and content services are used in order to support different types of applications. (Ovum, 2001: 11f.)

According to Ovum a major issue with the enabling platform business model is the platform provider's choice of either charging a fee per user license or to use a revenue sharing model based on volume. Platform providers may also collect revenue from activities such as providing of wireless application services. These activities consist of for instance, application development and customisation, content management, strategic planning and managed or hosted services. The enabling platform business model offers various opportunities to deliver value to the customers. The value delivered depends on whether the platform provider chooses to offer a basic platform or to integrate more tightly in order to earn service provisions. (Ovum report 2001: 11f.)

4.2.6 The WLAN business model

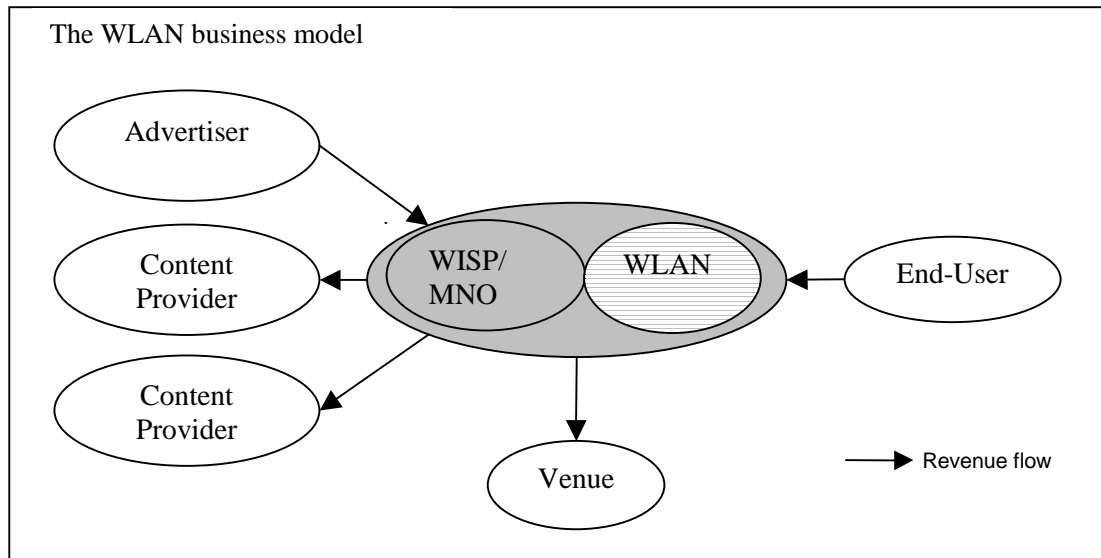

Figure 4.7 - The WLAN business model

WISPs may be MNOs and pay the venues for the right to build WLAN infrastructure at the venue and to be able to provide the visitors at the venues with wireless internet.

WLAN stands for Wireless Local Area Networks and is based on the technology IEEE 802.11b, which enables a wireless data transmission rate of 11Mbit/s. WLAN enables users to connect to the Internet and corporate intranets. Access to WLAN is today provided at hotels, lounges and airports. (www.umts-forum.org, *WLAN: A threat to 3G*, 2002-05-21) Myrthue, at Orange, views WLAN as a complement to 3G, which is a view that he shares with Wong at Ovum. (Myrthue, R. 2002-05-08, Wong, R. 2002-05-13)

Today the Swedish operator Telia is offering WLAN solutions through their subsidiary Telia HomeRun. The technology enables a wireless connection of up to 50 meters from the access point. A specific PC card suited for the WiFi technology has to be installed in the computer in order to enable a connection to the access point. Telia is currently offering WLAN at more than 450 locations in the Nordic region. The security within the systems is comparable to other access solutions for the Internet. Telia has signed a contract with SAS and has agreed to deliver HomeRun to the international lounges at airports. (www.homerun.telia.com, 2002-05-21)

According to Thorngren (2002), Telia HomeRun acts as a wireless Internet Service provider (WISP). The WISP owns the relationship with the end user. HomeRun pays a fee to the airports, for instance Arlanda and Bromma in Stockholm, in order to finance the infrastructure. This enables HomeRun to deliver WLAN services to the end-users, which for instance are visitors at an airport. The contracts generally last over a time frame of five years or more and most often there are no exclusive rights included. HomeRun only pays licensing fees for locations that are viewed as very attractive. According to Thorngren (2002), Venues, the actors that are located, as for instance at airports, do not understand the market value of WLANs. They are often happy only to be able to offer their services to customers. (Thorngren, 2002)

4.2.7 Content

This section contains the respondents' views of the information and the content concerning services available for customers.

4.2.7.1 Customer information

Customer information is needed in order to profile the customers. Profiling will become even more important in the future, since digitalized data services, unlike voice services, consist of a wider scope of solutions. The operators need to know what kind of services to offer in order to differentiate and offer attractive services to the customers.

The customer information refers to all types of user patterns such as when a certain customer is using a certain service, where the customer is located at a certain time and how the customer is normally moving geographically. The limitations of what type of customer information that may be useful is hard to identify.

Regina Wong, at Ovum, explains that there are two key points with customer information. First, customer information is needed in order to keep the customer and secondly to find out a way to make money on the customers. She further explains that operators need customer information in order to understand the opportunities of Internet content and to add more value through customised services. She believes that the customer information will act as a guiding tool for the operators and show what services are attractive and possibly profitable. She exemplifies the dilemma for the operators:

"Trying to add value, based on customer information, for example to any type of content that user A might be willing to pay for, will not be important to user B, which makes user B unwilling to pay for it". (Wong, R. 2002-05-13)

Kenneth Sandevi, at Aspiro, points out that customer information is of great importance in order to understand the end-user and to facilitate content development and aggregation. Customer information also plays an important role in creating the arguments needed to sell the content and the services, partly through making the offers more trustworthy. (Sandevi, K. 2002-04-26)

4.2.7.2 Services and value migration

Mobile Internet services are predicted to be the major revenue generator for mobile operators. Kenneth Sandevi, at Aspiro, explains that content and services are valuable for operators for two reasons. First the customers have to find the content attractive which can be evaluated through measuring the user frequency. Secondly the content has to be working efficiently, which is measured through the quality of the hosting support and variables such as down time. Kenneth Sandevi further points out that those operators that have the ability to solve the content issue in-house have the opportunities of gaining higher margins. The decision for an operator to develop its own content or to buy it from external actors does of course make a great difference to the operator's strategy. (Sandevi, K. 2002-04-26)

Rune Myrthue, at Orange, explains that Orange delivers value through offering services that are easy to use. He also explains that it is important that the solutions are adapted to the

customers needs. He points out that it is important that the operators do not make the same mistake, when it comes to the mobile Internet, as with the Internet. Otherwise they run the risk of ending up where many web-based companies did. (Myrthue, R 2002-05-08) The respondents also points out that the focus within service development has changed from a technological focus towards a will to understand how to deliver actual value for the users. Kenneth Sandevi, at Aspiro, explains that in the earliest stages of mobile Internet, the mobile operators were too focused on technology. Today more focus is directed towards content as a result of that the customers mainly cares about value and functionality.

Since services are critical for the success of mobile Internet and seen as the main revenue source it is not surprising that many actors will try to develop capabilities within this area.

Robert Vass, at SonyEricsson, explains that SonyEricsson will not just produce devices through mass production, but are aiming to increase the provided value within their products. He explains that this is to be done through adding different kinds of and services. He believes that content providers will capture a significant part of the value within the industry. The question is when this will happen and how much of the value they will capture. (Vass, R. 2002-04-16)

4.2.8 Structure

This section presents the respondents' views of relationships between actors within the business models.

The mobile Internet business models are characterized by differences in size between the actors that have to cooperate. Respondents explain that the mobile network operators do not have the resources to conduct all the necessary activities within the value chain. This results in that they need to partner up with content providers and concentrate on acting as the channel getting through to the customers. Regina Wong, at Ovum, highlights the importance of the relationships between operators and content providers, since this is the source of information needed to create innovative solutions. The bargaining power between the actors will to a large extent influence these relationships. She explains that the bargaining power is determined by the operator's position. Operators control the subscribers and the subscriber information. They are the actors with the natural access point to the customers. She exemplifies the impact of bargaining power. (Wong, R. 2002-05-13)

"...just compare the relation between Vodafone and a small start up with the relation between Vodafone and Disney. The bargaining power of course also makes an impact on the revenue sharing agreement". (Wong, R. 2002-05-13)

Since the content providers can be viewed as the operators' innovative source it is interesting to see how they view the relationship to content providers. Anders Jensen, at Vodafone, points out that the content providers' positions have been tremendously dependent on the operators, but in order to succeed with 3G he emphasises that the operators have to take a more humble attitude to the relationships with content providers. (Jensen, A. 2002-04-24) A more humble attitude could include promotion of individual services which Kenneth Sandevi, at Aspiro, strongly request. (Sandevi, K. 2002-04-26)

The mobile operators also have to secure that the co development of devices and technical standards are done in an efficient way within their business models. Rune Myrthue, at

Orange, highlights this issue and explains that to make sure that network suppliers synchronize infrastructure and phone development, players within the industry form alignments. The alignments lead to more open interfaces and synchronises the development of phones, infrastructure and content which improve the development within the mobile Internet industry. (Myrthue, R. 2002-05-08)

4.2.9 Governance

This section presents the respondents' views of issues relevant for the operators' ability to control the structure of the business model; this can be done through for instance revenue sharing and distribution of information.

The mobile network operators will have a strong influence on how the activities are conducted within their business models, as a result of their size and access to the end users. Anders Jensen, at Vodafone, believes that the operators need to have a common approach to the governance role in order for mobile Internet to succeed. He concludes that the industry has been unsuccessful regarding the ability to do the right things at the right time (Jensen, A. 2002-04-24)

Robert Vass, at SonyEricsson, request an agreement of a common lowest denominator within the industry and view this as an import aspect of governance. He points out that currently this denominator consists of voice and SMS- traffic. Robert Vass points out that on the Japanese market the governance problem has been solved by using distinct definitions of what each actor is supposed to do, while on the other hand on the European market the scope regarding what activities to conduct is too wide.

Revenue sharing agreements mainly between mobile operators and content providers is another important way for the mobile operators to govern the activities within their business models. Kenneth Sandevi, at Aspiro, explains that as a result of the operators keeping a large piece of the generated revenue, Aspiro tries to control service development, hosting and support as much as possible. (Sandevi, K. 2002-04-26)

4.2.10 Strategy and economic logic

This section presents the respondents' views of what factors are relevant in order for the mobile operators' business models to capture business opportunities and deliver customer value.

4.2.10.1 Strategic issues

The development within the mobile Internet industry is characterized by uncertainty concerning for instance what kind of actors will survive and succeed and what will become success factors enabling sustainable revenue generation.

Regina Wong, at Ovum, explains that there will be room for smaller players in the industry also in the future. This will lead to a market with more players and a higher level of competition. She believes that because of the operators' debt situation, they will invite players to join them leveraging their licenses. She also states that the disadvantage of being a big player is that you loose the ability to target all customers with attractive solutions. The

customers will have the luxury of choosing between different offers and comparing prices. She further claims that there will be room for a player like Telia, who is too large to be a niche player and too small to scale it. This is a result of that the lead-time to conduct differentiation in a digitalized world is short and will be a continuous challenge for all players. (Wong, R. 2002-05-13)

Robert Vass, at SonyEricsson, points out that the present debt situation will influence the future strategic alternatives for mobile operators. The operators have to decide on whether they are going to conduct just the bit pipe role or if they are going to change their business models and adapt them to the emerging business conditions. (Vass, R. 2002-04-16)

A new type of business condition is described by Anders Jensen, at Vodafone, who points out that a factor such as coverage will only be a hygiene factor and not a factor that operators will be able to compete with. (Jensen, A. 2002-04-24)

Another business condition will be the importance of the mobile operators' profile. Regina Wong, at Ovum, explains that the brand will influence strongly on what kind of customers and third party providers the operators will attract and the level of bargain power the operator will possess. Anders Jensen, at Vodafone, explains that the competition between operators will not be conducted through technological standards. Soft variables such as brand are going to be the base for competition. (Jensen, A. 2002-04-24)

4.3 Revenue models

This section includes empirical information regarding issues related to valuation, appropriation and allocation within the mobile Internet industry. The first subsection deals with valuation in terms of the underlying logic for price setting in the mobile Internet industry. The next subsection is appropriation and introduces the defined value carriers and discusses how to bill. Allocation is the third subsection where among others revenue sharing is discussed. The fifth and last section deals with future technological development in terms of billing and data service systems.

4.3.1 Valuation

Eva Helen Lundgren, at Vodafone, states that the price setting of a service can be based both on customer value and costs. The customer value is predicted by market research and trials and is aimed to reflect the market's willingness to pay. Even with this information it is extremely difficult to set prices for new services. She feels that the initial price set, often is the result of comparisons to similar services on the market. But if there are no similar services on the market, the prices lack reference. Therefore the price usually is set high in the introductory stages, in order to analyse the consumers' response and minimise the risk of setting prices too low. (Lundgren, E-H. 2002-04-24)

Eva Helen Lundgren further emphasise that there is very seldom a price increase over time and consequently the initial price is set high in order to reduce the risk of a too low initial price. The life cycle of a new service is relatively short and the competitive environment makes it impossible to keep the initial price up. The key determining factor for the price setting is nevertheless the predicted volume of the service. She emphasises that if the sale volume increases to a high level, the price of the service can be reduced. But in the launch stage of a service, the volume is usually low as a consequence of slow penetration.

Consequently the price can not be very low during the first years due to the time it takes to stimulate consumers and increase volume. (Lundgren, E-H. 2002-04-24)

Also Per Bergman, at Aspiro, points out that the number of potential customers is the most important factor to consider in price setting. He concludes that the combination of customer value, costs and volume determines the price for each service. Per Bergman further highlights that if a certain service is only suitable for the Swedish market, the price consequently will be higher, since a regional service most probably will generate a lower volume. (Bergman, P. 2002-04-26)

Eva Helen Lundgren, at Vodafone, emphasises that the price setting to a high degree is also related to costs. In the initial stage the price is set with respect to created customer value, but over time the competition forces the price to be cost-based. Consequently the costs have to be well known in order to decide the price range. (Lundgren, E-H. 2002-04-24)

According to Eva Helen Lundgren, at Vodafone, price will always be an important variable when competing and some segments will use price as the only relevant purchase criteria (Lundgren, E-H. 2002-04-24). Even so, Anders Jensen thinks that price competition also makes an impact on the margins and the perceived position of the company (Jensen, A. 2002-04-24). Lundgren explains that Vodafone will not use price as the base for their strategy (Lundgren, E-H. 2002-04-24).

In the launch of 3G, Eva Helen Lundgren does not think that subsidized phones can be avoided because the Swedish consumers have become used to that kind of offering. Pricing models are going to play an important role in persuading customers to change to the 3G standard. Marketing campaigns can be developed through offers giving the customer access to 3G at a low initial rate. When the customer acceptance has been evaluated prices can be adjusted to a rate reflecting the customers' perception of the value. (Lundgren, E-H. 2002-04-24)

One of the biggest challenges for the operators is to develop value based billing, to optimise the use of network resources. Value based billing means that the price is related to the customer preferences and the consumption patterns. The specific consumption pattern refers to when and how the customer prefers to use services and in which combinations. Customer preferences refer to how the customer experiences the value of the services. These two variables determine the maximum value perceived by the customer and should be the foundation of value based billing. The more data and specific information the operator has, the higher is the ability to set prices that reflect the willingness to pay and consequently the created value. (Telecommunications 2001: 77-80)

4.3.2 Appropriation

4.3.2.1 Models for charging

There are various options for charging and determining price. Eva Helen Lundgren explains that it will become important to give the customers the opportunity to choose a method of charging that suits them. Similar to the need for the range of products to be differentiated, the models for charging need to be customised. (Lundgren, E-H. 2002-04-24).

Subscriptions will probably, for many services, be the method of charging. The normal

subscription will be a prepaid fee charged monthly. *Duration* is a usable variable for determining the price. The advantage is that it is easily understood by the customers and has been frequently used for circuit-switched services. *Destination* can also be used as a parameter and works in the same way as on circuit-switched services, resulting in a higher fee for long distance calls. Fees based on *location* identifies from where access in the network is being made. This parameter can be used in order to separate fees through providing favourable rates for certain locations, for example a lower rate when the access is made close to the customers home. *Volume* is perceived to be a very important variable in setting prices. Services that use a high volume of data in the transmission can be charged by using volume as a parameter. The volume rate can be designed in many ways, for example based on the various sizes of data packets. (www.umts-forum.org , *3G How to exploit a trillion opportunities*, 200204-25: 69f.)

4.3.2.2 Services and the corresponding value carriers

The services that most probably will be offered and can be included in the customers' subscriptions are: *Voice calls* for which the payment still can be based on a minute rate. *Messaging* which contains services like SMS and e-mail will be developed more towards electronic post cards named *Multimedia Messaging Services*. These can be charged both by subscription and by the amount of data being transferred. The opportunity to conduct *videoconferencing* over the UMTS network will require high bandwidth. The base for charging these kinds of services are parameters such as peak or average bandwidth and duration which relates to the quality of the service. *Gaming* refers to services where customers interact with third party actors delivering content. The services can for instance include access to chat rooms. *E-commerce* can also be conducted over the network. In this transaction or service the amount of data will not be as significant as the perceived value of the transaction. The opportunities for different kinds of billing models can vary depending on the characteristics of the transactions. The opportunity to surf the internet, *information retrieval*, is likely to be charged through a model of subscription plus usage. *Push services* refer to information which is based on the user's location and are for instance marketing messages received when the customers enter a shopping mall. This service is closely related to *advertising services* where third parties send advertising messages based on the user's location. The difference is that the operator bills the third party for the advertising messages. *Streaming services* are for instance when the user is listening to MP3 music. For this kind of services the charging opportunities vary significantly. *Downloading services* are likely to be charged based on the amount of data that the user downloads. (www.umts-forum.org , *3G How to exploit a trillion opportunities*, 200204-25: 68f.)

4.3.2.3 Technological value carriers

The quality of a service can be determined by five parameters and differs in importance for different users. *Peak bandwidth* refers to the maximum bandwidth used and the *average bandwidth* is the average bandwidth used. *Delay* refers to how quickly the packets arrive after each other. The *reliability* or *error rate* measures the amount of data that has to be retransmitted. *Priority* or *precedence* refers to whether packets of data receive priority in the transmission over other users' information. (www.umts-forum.org , *3G How to exploit a trillion opportunities*, 200204-25: 70f.)

According to UMTS-forum different types of services will demand different levels of these quality parameters. These parameters do not have to be used only during the time of use and for instance a delivered service which has not kept the promised quality can be discounted later. A service terminator indicator can be used in order to track services that become abruptly terminated. The customer can be compensated and the operator has the opportunity to use the information in order to improve the service or correct the error. Furthermore the user can be charged by the number of events downloaded from a site. This model of charging customers for the content is to some extent a value based way of charging the customer. Through rating the service based on transaction type, the charging becomes more based on value than on cost. This way of charging takes into account and harmonises with different transactions being of different value for different customers. It also takes into account when the transaction is complete. (www.umts-forum.org , 3G How to exploit a trillion opportunities, 200204-25: 70f.)

4.3.2.4 How to bill?

A large advantage would be to use value-based billing. To do this a high degree of visibility in the data networks and the billing systems is necessary. Ideally, network operators seek software solutions that make it possible to generate device specific information. Visibility in the network system makes it possible to collect and analyse generated data. This information enables efficient rating and billing as well as knowledge about key usage and customer preferences. (Telecommunications 2001 September 77-80)

Regina Wong, at Ovum, emphasises that value-based billing is an extremely good idea, but that the billing infrastructure probably is not yet able to support it. Wong believes that the operators currently have a problem trying to “juggle” data services. She further claims that there is a large amount of information that the system has to manage in order to bill properly. Consequently the operators have to deal with issues and questions such as real time measuring, historical customer usage and pre and post-paid billing. (Wong, R. 2002-05-13)

Rune Myrthue, at Orange, emphasises that the biggest problem related to charging mechanisms is actually how to make measurements of different flows on their core mobile network. To get more specific information than just the data volume (Mb), flowing through the mobile network, it is essential to generate information from the service platforms. At present it is possible to see how much traffic that goes through the mobile network, but nobody knows what kind of traffic that is. Rune Myrthue points out that in terms of transparency, they have much left to do before value-based charging is possible. The charging will otherwise still be volume-based also in the future. (Myrthue, R. 2002-05-08)

To emphasise the importance of the billing engine and the content, Rune Myrthue, at Orange, compares the content to the brain and the billing engine to the heart of the mobile Internet business. Rune Myrthue further emphasises that billing currently is part of their core business, due to the fact that nobody else is able to manage it. Rune Myrthue feels that much progress has happened, but that the billing is still a bottleneck and will remain so for a few years. (Myrthue, R. 2002-05-08) Also Regina Wong, at Ovum, states that the technology will definitely be the critical factor in terms of the billing problem. (Wong, R. 2002-05-13)

Eva Helen Lundgren, at Vodafone, concludes that the current limitations within the billing systems imply reduced possibilities for pricing. Lundgren further means that bundling will be a practical and desired opportunity when the system is able to support it. (Lundgren, E-H.

2002-04-24)

4.3.3 Allocation

According to Rune Myrthue, at Orange, the relations between third parties and network operators are of great importance. Rune Myrthue believes that it is essential for players in the mobile industry to create partner relations in order to succeed. (Myrthue, R. 2002-05-08) Regina Wong, at Ovum, emphasises that the network operators can not do everything. The content and application providers are often small innovators that the network operators advantageously should partner. The relationships will still very much be determined by the relative bargaining power. (Wong, R. 2002-05-13)

Eva Helen Lundgren, at Vodafone, means that contracts to third parties are a result of individual negotiations. These are influenced by the margin the operator needs and the perceived value of being able to offer the content to the customers. The contracts regulate the revenue sharing between third parties and operators and are based on either variable or fixed rates. The allocation of the revenue flow depends on how much resources Vodafone have invested in a certain project. According to Eva Helen Lundgren, the amount of invested resources relates to in what degree Vodafone has been involved in the market research and the service development. In many cases the degree of involvement has been high due to the fact that the content provider needs great knowledge about the operator's internal functionality when developing the service or application. If the provider contributes with the complete market research and service development the revenue will be allocated in advantage for the provider. (Lundgren, E-H. 2002-04-24)

Per Bergman, at Aspiro, emphasises that they have pushed for revenue sharing in order to get a larger piece of the revenue, but due to the lack of service marketing by the operators, the volumes have been kept low. According to Per Bergman the lack of service specific promotion has lead to reduced customer interest and consequently lower volumes of sale. Bergman further states that revenue sharing is currently regarded as some kind of common law in advantage to no one. Per Bergman concludes that revenue sharing in this stage of development is a bad alternative to Aspiro. At present there are neither terminals nor network infrastructure to support Aspiro's service development. The consequence is that Aspiro does not generate any significant revenues from their front-edge services. (Bergman, P. 2002-04-26)

Eva Helen Lundgren, at Vodafone, thinks that the main benefit with contracts to third parties based on variable parameters, such as volume of use and amount of resources devoted by Vodafone, is that they contribute with incentives for the provider to perform better. Eva Helen Lundgren further believes that being able to allocate correctly in proportion to created value is difficult but important. (Lundgren, E-H. 2002-04-24)

Per Bergman, at Aspiro, believes that the contribution they do make to the operator in terms of value creation is content development and content aggregation. The value of aggregation is that the network operator only has to operate one relation instead of several. This means that the aggregation activity includes the searching and the collecting process. (Bergman, P. 2002-04-26) Kenneth Sandevi, at Aspiro, emphasises that it is not the identification of two hundred potential service providers that is the hard thing to do, but rather to have the ability to assess whether a certain provider is suitable for the market or not. (Sandevi, K. 2002-04-26)

According to Eva Helen Lundgren, at Vodafone, more standardised relations have to be

developed in order to operate an increased amount of third party providers. Currently it is difficult to standardise due to the variation in invested resources between different projects. (Lundgren, E-H. 2002-04-24) Also Anders Jensen, at Vodafone, emphasises the importance of enhanced and standardised relations to third parties. Jensen further states that currently network operators are negotiating agreements to third parties, even though there is not much to negotiate or agree about. Operators have to approach each other to create natural flows with the purpose of opening up a spectrum where more players are able to make their businesses profitable. (Jensen, A. 2002-04-24)

4.3.4 Technological development - Billing & Data Service Systems

The technological systems for billing and charging have to be developed in order to efficiently design different charging methods and bill customers based on the variables capturing the value. Below a brief presentation of this kind of mobile data support system is presented. WaterCove Network is one of several actors who claim to have a highly developed mobile data service system suitable for this need. The system is named Flow Core and consists of three parts.

Rune Myrthue, at Orange, and Eva Helen Lundgren, at Vodafone, pointed out the importance of technical support systems in order to be able to develop solutions for value based billing. The Flow Core Architecture exemplifies one of several support systems with potential to fulfil these requirements. However Regina Wong, at Ovum, points out that there are many solutions that work theoretically. All players state that they have solutions for everything and they probably have for small trial tests. The question is if the systems work when the amount of subscribers, content providers and application providers reach the real levels and that means millions of subscribers. (Wong, R. 2002-05-13)

In an article Fredrick Näslund, Head of European operations at WaterCove Networks, points out that Vodafone and Orange both do large-scale tests of the platform. Vodafone conducts the test in Holland and Orange in Great Britain. The platform expects to be commercial later this year. He further emphasises that competition is underway, but that WaterCove appears to be fastest out. Fredrick Näslund thinks that the technology like WaterCove's perhaps will be available on Swedish market within a year, but that the problem is not so much technological as one of new business thinking. Näslund states that the network operators have a deceptive dream of growing into the value chain. There are others which can create services better though, but no one can beat the operators when it comes to closeness to the customer. (<http://www.competencepress.com/kista/competence.php?ArtId=1367>, 2002-05-25) It is interesting to note that both Vodafone and Orange test this platform and that this support system is expected to be on the Swedish market within a year. Because this points out the operators interest in being able to develop their capabilities needed for value based billing

In order to provide an understanding of the technological capacity of a support system a description of the WaterCoves' flow core architecture is provided. The Flow Core Architecture consists of the three integrated parts, service core, support node and network management. The *service core* includes the intelligence and logic that makes it possible for operators to deploy new services containing operational costs. The Service Core also makes it possible to optimise the use of network resources. It enables separation of the underlying transport for wholesale services and processes the charging data. It delivers high levels of performance for transactions while collecting data on subscriber or session basis. (http://www.watercove.com/pr_021802.html, 2002-04-25)

The service core also provides open and flexible interfaces to third parties. This allows operators to simplify partnering with third parties and to deliver attractive mobile data services. The open interfaces make it technically possible for third parties to access metering and flow control features. (http://www.watercove.com/pr_021802.html, 2002-04-25)

Among other things the *support node* allows real-time metering essential for efficient network resource management and content-sensitive charging for data services. This information will help operators create adaptable billing models. The support node also provides flow control. These tools will allow operators to understand traffic flows over the network, which in turn enables them to feed this information into charging and billing systems. This allows for third parties to analyse the services in respect to their profitability. They are accordingly enabled to select services that are sufficiently profitable and provide high-value services and contents, while avoiding low margin services. Consequently the operators are able to optimise the use of network resources. The metering is able to regard many different types of variables such as time, volume or quality of service. Accordingly the operator will be able to allow content- and service-sensitive charging. (http://www.watercove.com/pr_021802.html, 2002-04-25)

The network management system allows operators to efficiently monitor and manage network resources. It can be done via a single point-of-control. Operators are able to optimise the revenue-generating capacity of the network capacity and deliver partitioned management services for third party partners. (www.watercove.com/pr_021802.html, 2002-04-25)

5 Analysis

The analysis is structured in line with the theoretical framework and the empirical chapter. It starts with the analysis of the business landscape, identifying trends, driving forces and new organisational constellations. The chapter continues with an analysis and assessment of the business models and the strategic issues of importance for the mobile operators and the industry. Thereafter the revenue models are analysed, containing valuation, appropriation and allocation. Finally a correlated analysis is presented. Below is a more detailed and illustrative presentation of how the analysis chapter is structured and what it contains.

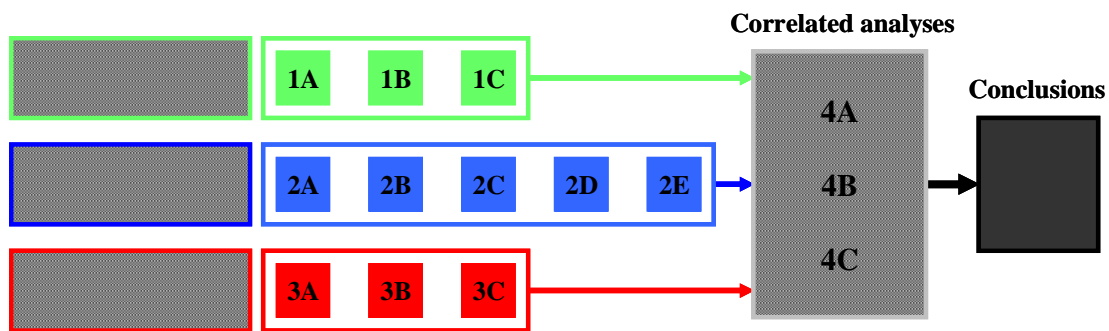

1 Business landscape

- A The Development of the business landscape
- B Forces in the business landscape
- C New organizational constellations

2 Business models and Strategy

- A Business models
- B Strategy and strategic options
- C Strategic issues regarding internationalization
- D Strategy and strategic options from a network perspective
- E The Delta Model

3 Revenue models

- A Valuation
- B Appropriation
- C Allocation

4 Correlated analyses

- A How does the business landscape influence the possible business models for mobile Internet?
- B How do the revenue models influence the possible business models for mobile Internet?
- C What will be important for operators in order to create value within the possible business models for mobile Internet?

Fig 5.1 – Analysis model

The model visualises how the analysis is structured and what theoretical sections is used in the different parts. It also shows how the parts are linked together sequentially.

5.1 Business landscape

5.1.1 Conditions within the mobile Internet business landscape

The first part analyses the mobile Internet business landscape. Normann (2001) concludes that a new strategic paradigm has emerged. Porter & Stern (2001) discuss innovation capacity mainly within clusters.

The technological development within information technology leads to decreased transaction costs. Decreased transaction costs enable specialisation. In the mobile Internet business landscape, this results in more players moving into the value chain. They specialise within specific areas of the value creating process such as developing or aggregating content for mobile Internet. Another area of specialisation is the providing of specific parts of the systems or networks. The mobile Internet industry is a part of the new economy including the new strategic paradigm focused on customer relations and customer stock (Normann 2001). This is highlighted by Rune Myrthue, at Orange, and Anders Jensen, at Vodafone, whom share the view that technology enables new ways to conduct value creation. However, the customers should not have to bother about the technological aspects.

5.1.1.1 The mobile operator as prime mover

In a knowledge intensive environment, characterised by rapid and complex technological development, Norrman (2001) points out the importance of having an actor that manages the value creating process within the network of actors. Normann (2001) name this actor prime mover.

The mobile network operators have taken most of the industry risk through their investments in licenses, infrastructure and software. Ovum, points out that in order to secure long term revenue streams in the mobile Internet industry, the billing issue has to be solved and revenue sharing between mobile operators and content providers has to be agreed upon and implemented. The operator is also the actor that generates most of the customer information, since they to a large extent control the customer relationships. Within the mobile Internet business landscape, the role as a prime mover seems obvious for the mobile operator, since the operator is the one who owns the possibility to control and manage the dematerialized flows in terms of risk, information and revenue. Accordingly the operator can affect the value creating process outside its own company bounders. To be a prime mover the operators have to manage the complexity of the network systems in order to support the operation of the dematerialized flows. The operators have to do this in addition to the transmission of services. Just the transmission will be regarded as a commodity and the operators who do not succeed to become prime movers face the risk of participating in an inefficient value creating system.

In addition to the above mentioned factors, an important task for the prime mover is to create shared visions among actors within the mobile Internet industry (Norrman 2001). Visions are an important aspect for the creation of generative relations (Eneroth & Malm). In the mobile Internet business landscape, visions can constitute the foundation for consensus in order to create a balance between new and proven technological solutions. The operators have to stimulate a dialogue between the actors within the business landscape, pointing out what activities are needed in order to satisfy the end-user. Various competences also have to be combined between the various actors in order to enable mobile Internet. This calls for shared

visions regarding the activities that need to be conducted. The operators, as the prime movers, have a significant influence on the shared visions and consequently also on the creation and operation of generative relations. This enables the operators to own the governance within the value creating system.

5.1.1.2 The business landscape influencing the choice of business model

Porter & Stern (2001) presents a framework for analysing the innovative capacity of nations and clusters. At the cluster level, the diamond framework is used. Cluster specific considerations for innovations relates to conditions unique for a specific region. The authors of this thesis think that within the mobile Internet industry a region can be a continent whereas a cluster can constitute a country. Consequently different parts of the region can have different innovative capacity. For instance, a country with a high innovative capacity, such as Sweden, has a higher potential to use an open business model which result in that the operator has a strong reliance on third parties providing services.

The European market can be characterised by factors that create a strong diamond with high innovation capacity. This is because content and service providers have proved to offer innovative solutions. The rivalry between operators is high. According to Rune Myrthue, at Orange, the demand in Europe is characterised by high-end consumers and the relating media industry offers a variety of contents. The business landscape within Europe has for that reason more favourable opportunities to rely on open business models that are dependent on innovative solutions.

In contradiction to the European market, Regina Wong, at Ovum, points out that the Chinese market is less sophisticated and relies on content, which is locally related. Rune Myrthue, at Orange, points out that since the Japanese consumer has less experience of Internet; the demand for sophisticated services is not as strong as for instance in Europe. Different consumer preferences derived from specific cultural characteristics impact on the type of business model suitable for a specific region. A region, such as China or Japan, where the customer demand is less sophisticated is less dependent on innovative content providers delivering highly sophisticated content.

5.1.2 Forces impacting the actors in the business landscape

Arthur (1994) describes the factors, which has to be present in an economy in order to experience increasing returns. The mobile Internet industry is characterised by significant initial investments before being able to deliver services. The investments in infrastructure, the customisation of services and the technological platforms such as billing system can be seen as a major developing cost enabling future service development. The service development and distribution costs are low compared to the initial investments in infrastructure, reflecting the low costs of transmitting information digitally. If the demand for a service is high in combination with decreased marginal costs, the operators may enjoy increasing returns.

Services such as chat-rooms or member sites increase in value with the number of users. For instance an entertainment-downloading site, where users exchange entertainment, increases in value for every individual user, since the amount of available entertainment increases. This kind of services has an initial development cost and thereafter a decreasing marginal cost, whereas the demand is growing due to the network externality effects. An economy

characterised by network externality effects and increasing returns is unstable. This results in path dependency and small unpredictable events that can have strong influence on the future development.

Schilling (1999) concludes that in order for companies to succeed under these conditions, they have to cooperate. The operators can influence the path through building a large *installed base*, which is enabled through attracting a large number of users. In order to build a large customer base the operators can use aggressive marketing activities such as bundling and penetration pricing. Through the use of bundling the operator can offer more personalized service mixes, which are more valuable than the individual services. This increases the attraction of new customers. Bundling combined with low initial prices creates a potential of creating a strong penetrating effect. Creation of a dominant design can also influence the path. For the operator this can be created through establishing the technological standard for mobile Internet and that is what Robert Vass, at SonyEricsson, refers to as the lowest common denominator. The operators can also use diffusion of technology, through open platforms, facilitating for third party providers to connect to their infrastructure. If the mobile Internet industry succeeds with this, there will be a potential of users learning and adapting to the services, which in turn acts with a signalling effect on potential customers and partners. Consequently the signalling effect and the increased adoption lead to an increased user volume and an increased amount of subscribers, which means increased revenues.

Pitt (2001) states that the digital age provides new challenges for managers and introduces forces that managers should take into consideration when they develop strategies. Due to Moore's law, the doubling of computer power, it is evident that we have only seen the beginning of the mobile Internet development. The doubling of computer power will influence content, mobile network support services and traffic transmission capacity.

Metcalf's law points out that the value of a network increases with the number of users. This emphasises the importance of building an installed base in order to reach a critical volume of users. A larger number of mobile Internet users increase the value for the consumer since it enables exchange of information with more people. This is the underlying force that enables what Schilling (1999) and Arthur (1994) mean with network externality effects.

The current business landscape is characterized by digitalisation and decreased transaction costs. Decreased transaction costs facilitate the searching of potential partners and customers. The digitalisation also results in that information can be exchanged to a lower cost at a higher pace. The increased opportunities to transmit information result in increased transparency in the relationship, which decreases the control costs. These factors enable specialisation which is significant for the mobile Internet industry and a Coasian economy.

The Fish tank phenomenon implies the opportunities for anyone to create innovations on the Internet due to the low distribution costs of information. This highlights the need for content aggregators within the mobile Internet industry. Mobile Internet services can be invented by private persons or small start ups and results in a need for a player who is able to identify and enable the commercialisation of innovations.

5.1.3 Specialisation within the business landscape

Werbach presents three roles that companies can take, enabled through the presence of Internet as a tool for information distribution. Originators' can be viewed as the actors developing content. This is done both by individuals, content developers, content aggregators and mobile operators. Aspiro acts as a syndicator, packaging the content and selling it to the mobile operators who as distributors provide it to the end consumers. The distributors and syndicators can take all three roles but as a result of the Internet, specialisation has been enabled and stimulated. Specialisation will result in more players being part of the value creating activities within the mobile Internet industry. The type of specialisation will be influenced by what activities are anticipated to provide the most value. As pointed out by one respondent, content is regarded to constitute a significant part of the value within the industry. This indicates a development of more players moving towards content creating activities taking some sort of originator role.

Hougaard & Johannsen-Duus (1999) make a somewhat different classification of actors within the digital value chain. Providers have a larger scope than originators, and also include actors such as SonyEricsson. They also view the customer to be part of the digital value chain as a co producer in the value creating process.

Hagel & Singer (1999) highlights the importance of product innovators competing with speed. This calls for small innovative players. Hamel (1989) points out small players' strong innovative capacity in Silicon Valley. However large operators might have somewhat limited innovation capacity as a result of resource allocation inefficiencies between different units of the company. Further Regina Wong, at Ovum, points out that the lead-time for differentiation is short. This further highlights the importance of competing through speed for content developers. Content developers have to be able to supply new services quickly because the mobile operators will need to renew their service portfolios with short intervals. Actors that manage the customer relationships and the infrastructure will have to compete through scope and scale, variables that calls for a consolidation within the mobile Internet markets.

5.2 Business models for mobile Internet

The analysis of the business models will be conducted through the use of the theories presented by Magretta (2002) and Amit & Zott (2001). The purpose is to analyse if the business models enable to answer the questions Magretta (2002) concludes that a good business model should provide answers to. The questions are presented below. An analysis of how transactions are enabled and value created according to Amit & Zott's (2001) definition will also be done with a focus on the mobile network operators.

Each of the business models presented will be analysed based on the following six areas:

1. The first area explains who the customer is, with a reference point taken from the actor in the centre of the business model.
2. The second area concerns how value is created for the customers, through the use of the business model.
3. The third area focuses on whether the business model creates superior customer value or completely changes the way activities are being performed.
4. The fourth area concerns assumptions made about customer preferences and the behaviour of suppliers.
5. The fifth area concerns how transactions are enabled and how value is created for the company in the centre of the business model.
6. The sixth issue regards what the business model communicates through the design and activities.

5.2.1 The paid for content business model

1. The paid for content model focuses on providing value for users willing to pay for content. Depending on what kind of services being offered users can be private persons as well as corporations.
2. Value is created through cooperation of service production for the end-users. This implies that the mobile operator offers services to the customers which has been developed and aggregated by third party providers. The Japanese network operator NTT DoCoMo, uses this business model, and is taking the role both as the network provider and the wireless portal provider. For i-mode customers, value is created through the simplicity of the business model according to Rune Myrthue, at Orange. The business model used by NTT DoCoMo also creates value through the use of a single charging point. NTT DoCoMo takes responsibility for the billing activities for all the content providers. The content providers' main benefit with this charging solution is that they do not have to devote resources to bill customers themselves. Instead they have the ability to specialise and focus on their core activities, namely developing and aggregating content. Since the provision rate for content providers in the i-mode case is fixed at 91 percent, they can through estimating the market

potential, evaluate if the service will be profitable. Further this kind of standardized negotiations saves resources for both NTT DoCoMo and the content providers avoiding negotiations about uncertain future revenue streams. The type of services developed for the end-users might be influenced by this model of revenue sharing, resulting in services that are easily charged for, based on for instance volume. Time killers, services such as gaming or entertainment are suitable for event or volume based charging. This can occur because services have to fit NTT DoCoMo's billing capacity.

For NTT DoCoMo this revenue model results in a high level of responsibility. The operator has to see to that the billing is managed correctly and allocation is done to the right content provider. It also increases the need of customer service facilities since customers experiencing errors with their invoices will turn to NTT DoCoMo. However the position for NTT DoCoMo becomes important since the value creating system depends on the operator in order to receive their part of the revenue streams from end users. This creates incentives for DoCoMo to facilitate for content providers.

3. Through the outsourcing of content development, NTT DoCoMo to some degree has changed the existing way of delivering services to customers. Traditionally the mobile operator has been responsible for the services offered within their networks. The economic logic of the model assumes that customers are willing to pay for content. This creates a focus on value creation, services that have high potential of succeeding commercially, as well as customer relationship management. The customers' has to be willing to pay for the value created within the business model.
4. NTT DoCoMo makes the assumption that content providers have the capacity to deliver high quality content. In order for other operators to use this business model, they have to be aware of the importance of creating an incentive for the content providers. This can be done through revenue sharing. Information sharing will also become important because it enables for the operator to provide content providers with information important in order to develop services that fit the operator's profile. It will also be important for the mobile network operator, using this business model, to identify skilled providers. Kenneth Sandevi, at Aspiro, explains that the operators have begun to understand the importance of revenue sharing. Currently NTT DoCoMo's assumption regarding the content providers developing capacity has been correct. The i-mode business model has been able to attract customers through offering content provided by third parties. This is much a result of the dominant position of the i-mode business model on the Japanese market. However, acting based on these assumptions, on markets where the level of competition is stronger between operators may be more risky. A high level of competition between operators will create more opportunities for the content providers to choose between operators, based on how attractive terms different operators will offer.

Content is anticipated to represent a larger part of the created value in the mobile Internet industry. Mobile operators who do not develop their own content have to buy it from content providers. Operators competing to win the most attractive content providers and aggregators can use generous revenue sharing agreements as a tool. Since the content providers are interested in cooperating with operators which offers large customer base, the large operators have the potential of influencing the development of content. The content providers' resources are limited and operators

offering a large customer base and favourable terms have the potential to influence the content providers to develop services designed in order to fit the specific operator's profile.

5. Transactions are enabled, in the business model, because operators take responsibility for the infrastructure management, and as in NTT DoCoMo's case the complete billing process.
6. The paid for content model communicates that content is valuable and should be paid for. The business model also clearly states that content development is not the core activity of the mobile network operator. Operators should focus on infrastructure management and operate the customer relationships.

5.2.2 The free content business model

1. In this business model the portal provider, who can be an independent actor or a network operator, has two customer types, the end user and the advertisers. The advertisers use the portal provider in order to reach the consumers with their messages. The advertisers usually also deliver the main part of the information and services accessible for end users. These services do not specifically regard services such as infotainment or events, but rather advertisements and marketing messages. Since the business model enables free access to mobile Internet, this will attract price sensitive customers with low willingness to pay for content. Content providers developing paid for services will have less incentive to deliver their services over a free content model since the demand for this kind of content is low.
2. The value for the consumers consists of the opportunity to get free content and be targeted with information and messages relevant for them. The advertisers value the ability to reach specific customers with specific messages at specific times and locations. The operator has the opportunity to increase the value for the advertisers through offering advanced solutions for targeting the customers. Through the use of consumer information the advertisers can be offered profiles determining when and how to target different consumers. However their might be ethical as well as legal restrictions limiting this kind of solutions. The business model is based on the economic logic that consumers will not have a willingness to pay for services on mobile Internet. The operator or portal then has the opportunity to collect revenue from actors who instead are willing to reach the consumers over mobile Internet. This enables the operator to generate revenue independently, without regarding the consumers' buying propensity.

Approaching mobile Internet, some customers will have the perception that Internet is free. The fact that advertisers finance a high level of the content provided over the fixed Internet indicates that this business model has the potential to succeed. Customers today are already used to view content combined with advertising messages. Since they have no experience of mobile Internet, the free content model can act as their first contact with mobile Internet.

3. The business model do to some extent changes the way activities are conducted. The operator using this model does not have to rely on revenue generation from the customers’.
4. One critical assumption that the portal provider and/or the network operator do, through the use of this business model, is that advertisers will provide the major part of the accessible services on the portal and that the consumers will find these attractive. Since the advertisers are responsible for the main part of the accessible and delivered information on the portal, they will to a large extent influence the scope of available information on the portal. This may impact on the operators’ potential to create revenue, since attractive services influences the ability to attract customers. The characteristic of the operator’s customer base will impact on the advertiser’s choice of operator. A portal having mainly teenagers as customers will attract advertisers targeting this specific segment.

The mobile operator using the free content model can be viewed as an aggregator of advertising messages, information which the consumer is not perceived to be willing to pay for. However this business model will be attractive for all kinds of operators in the initial launch of mobile Internet services. An operator, who intends to base the competitive strategy on brand and high valuable content, could use the free content model in order to demonstrate the potential of mobile Internet for the customers. This could be viewed as a marketing tool in the upgrading strategy of customers from 2,5G to 3G. The benefit for the operator in this case is that customers will not demand the same value because the use is free. Further the business model offer great potential for the operators to test their network systems and receive information concerning customers’ user characteristics. The risk for the operator to use this model in the initial stage is that customers might get used to low prices. Even so, this can be prevented by communicating that more value is possible to get via a paid for portal.

5. If the portal provider is a network access provider, they create value through enabling transactions between advertisers and end users. The more solutions they can offer to the advertisers, facilitating to reach customers, the greater will the potential to increase their revenue streams be. If advertisers are able to reach their specific segments, there will be increased traffic and more transactions conducted within the network.
6. The free content model communicates that contents do not offer such value for customers that they will pay for it. The operator in this business model also makes clear that content development is not within their core activity. Instead they should focus on aggregating customers in order to be attractive to advertisers. In this business model the operators becomes communication enablers or aggregators. They create value when they facilitate the connection between advertisers and customers. Operators create value for themselves when they facilitate for advertisers to reach the customers with attractive content that stimulates the traffic volume.

5.2.3 The intelligent facilitator business model

1. The mobile network operators' customers in this business model are the third party providers, such as MVOs. They get access to billing and support services from the operators.
2. For the customers it is valuable to be able to conduct business over mobile Internet without having to take on investments in infrastructure. For these players this results in less need of technological competence. The business model lowers the entry barriers into the mobile Internet industry, since it enables for actors without networks to reach the end consumers.
3. Mobile network operators, who do not succeed with or intend to attract consumers on their own, might use this business model. For instance may an operator that does not have marketing resources or a brand that enables competition for the consumers use this model. Another alternative is when an operator views the revenue potential of the end consumers as unsatisfying. This may be the result of tough competition within the market. The operator may in this case use the model in order to make money on the competition. The mobile network provider then has the option to focus on offering superior value to third party providers.
4. A mobile network operator, using this business model, makes the assumption that they will be attractive since they own infrastructure and have the related competence. This is in accordance with Eva Helen Lundgren's, at Vodafone, view that operators become attractive for other players as a result of their billing competence.
5. Anders Jensen, at Vodafone, explains that it is important for Vodafone to facilitate the communication between end-users and third party providers. It is reasonable to assume that Vodafone partly will use a type of intelligent facilitator business model in order to enable for MVOs to reach end-users. The mobile network operators have the ability to create value for themselves in two different ways, based on the same competence. The competence used in order to deliver services to their own customers can be used also to facilitate access for third party providers. The operators also generate value through increased use of their infrastructure. Rune Myrthue concludes that Orange's business model contains the parts needed in order to host services. Most mobile network operators will use this business model to some extent, since it offers an easy way for the operators to create value based on existing knowledge. The operator also devotes fewer resources to the customer relationships, since one person could be responsible for the contact with the third party provider.
6. The business model communicates that the mobile network operator should be the natural access point for the end users because they control the infrastructure.

5.2.4 The MVO business model

1. The consumers are the mobile virtual operators' (MVO) main customers. If the MVO uses the free content model, advertisers also to some degree become customers.
2. MVOs can create value because they have the ability to niche themselves and target customers who, for instance, do not get satisfied with the services offered by mobile network operators.
3. The economic logic is to avoid huge investment in infrastructure and to focus on building relationships to the end-users in order to create or develop a customer base. MVOs have to concentrate on delivering superior customer value. As for instance Dial n' Smile, who focuses on mature services that enables cost savings for the customers. MVOs also to some extent change the traditional way of reaching the customers, since they are able to compete with mobile network operators without owning any network.

Ovum explains that the MVOs will have higher potential to succeed if they minimise their dependence on the mobile network operators, and that will have less potential to be innovative since they do not own or control infrastructure. The limitations for innovating are for instance based on the inability to create innovative billing solutions. However, the point of being an MVO is to avoid significant fixed costs as a result of investments in infrastructure, and to develop competence outside the technological areas. Dial n' Smile's strategy to offer mature services is a way to avoid the need for innovations, and engage in head to head competition with the network operators' customers. The mobile network operators' investments in infrastructure and supporting software are made in order to offer advanced services. Anders Jensen, at Vodafone, does not believe that MVOs will afford organising the market by themselves. Dial n' Smile's strategy of offering mature and cost saving services seems thus very appropriate. The company does not need to commit marketing resources to launch innovative services on the market. Mobile operators with more resources have already conducted the initial promotion of the services; this results in that there already is a market for the services.

4. Frederick du Hane, at Dial n' Smile, and Anders Jensen, at Vodafone, view the relationship between network operators and MVOs differently. Frederick du Hane viewing the network providing operator as a partner and Anders Jensen considers the MVOs to be competitors that Vodafone has an earning potential in. This can be a threat to the business models ability to optimise the value creation, both for the MVOs and for the mobile network operators. Regina Wong, at Ovum, explains that large players will not have capacity to target the complete market they are operating on. Mobile network operators should welcome MVOs whose strategies do not target the same segments as the operator. If they are successful with this, the ability to sell airtime increases, without suffering from losing their own customers. The MVOs would in this case target customers that the network operators would not be able to satisfy anyway. Mobile network operators who succeed with the cooperation with MVOs gets higher volumes of traffic provides a stronger bargaining position in negotiations with other actors and can strengthen the network operator's position within the network.

For MVOs advertising income also works as a way to avoid dependency on the mobile network operator. Expressed by respondents, customers do not care about technology. They are looking for valuable services and functionality. The MVOs have picked up on this and have the potential of delivering customer value without conducting activities that the customers do not mainly care about.

5. MVOs enables transactions through buying network access from the network operators and sell content to end consumers. In some case transactions are also enabled through selling advertising space to the portals. Robert Vass, at Sony Ericsson, believes that some of the MVOs will have the ability to niche themselves successfully. To find the right niche will be extremely important for MVOs who enters the market without any customer base. These actors do not possess any fundamental resources which mobile network operators do not possess or have access to. This kind of MVO has to find a niche were mobile network operators have difficulties satisfying the customers preferences.

Actors possessing a strong brand and have an existing customer relationship can control portals. A portal can be used as a mean to get leverage on these existing resources. For instance a retailer can use the portal to promote offers and strengthen the tie to the existing customers. Mobile network operators can also use portals in order to target customer segments which they can not satisfy through existing channels.

6. The MVOs business model communicates that services and customer relation should be the core competence and that technical infrastructure and knowledge do not have to be owned in order to conduct business with the end user over the mobile Internet.

5.2.5 The enabling platform business model

1. The customers of the enabling platform actor in this business model are the mobile network operators. The mobile network operators buy platform devices from technologically specialised actors such as for instance the platform provider WaterCove Networks.
2. The platform provider creates value for the mobile network operators through offering platform devices that increases the opportunity for the operators to generate value from their infrastructure. The potential to create value is dependent on the platform provider's ability to integrate with the mobile network operator. The more skilled the platform provider is in the integration of activities with the mobile network operators the greater is the possibility for the operators to outsource responsibility for platform solutions, platform services and hosting. For instance it is possible that a skilled platform provider takes responsibility for the billing process which can occur if the customers conduct transactions concerning large amount of money. Perhaps the mobile network operators do not want to take responsibility for the risks associated with large transactions due to the fact that the billing performance to large extent depends on the skills of the enabling platform provider. On the other hand, the network operators may believe that billing is one of their core activities and essential for their business model and consequently want to manage it on their own.

3. This business model is based on a change in the traditional logic for the mobile network operators. The traditional logic for the mobile network operators has been to take a large responsibility for the development of support services connected to their infrastructure. Due to the fact that the mobile network operators might not have the resources to conduct all activities a change of logic is occurring. The operators will rely to higher extent on support from platform providers whom possess resources important for the enabling platforms.
4. Platform providers specialise in platform development and related services due to the assumption that the use of package switched data will create a need for more complex solutions. Platform providers see an opportunity to create value for the network operators due to the increased complexity and importance of for instance billing systems.

Rune Myrthue, at Orange, points out that it is not to be taken for granted that activities such as billing will be within the core business of Orange. Such view opens up for platform providers to integrate with the operators and increase their earning potential from services. Because of the increasing complexity and the rapid technological development this business model has the potential to succeed. A success of the enabling platform model results in other variables growing in importance for the mobile network operators to compete.

5. The platform providers facilitate the mobile network operators' ability to conduct transaction through the use of their networks.
6. The business model also communicates a distinct message, in agreement with the MVO business model, that an actor does not have to control the entire technological competence in order to deliver services over the mobile Internet.

5.2.6 The Wireless Local Area Network (WLAN) Business model

1. The users of WLAN are private and corporate customers. The WLAN providers (WISPs), such as HomeRun, cooperate with venues, e.g. airports, in order to deliver wireless Internet at a high transmission capacity for customers on the run.
2. The value for the customers in this business model is to be able to use disposable time out of office in order to receive or send information through the use of wireless devices.
3. Superior customer value is offered through the high transmission capacity compared to 3G. Rune Myrthue, at Orange, views WLAN as a complement to 3G. In order to fully benefit from WLAN you have to be able to use it while for instance approaching the location. The limited hand over capacity, the high price, and also the limited mobility within the location indicates WLAN to be a complement to 3G. As illustrated in the introduction chapter WLAN offers superior capacity compared with 3G, however the lack of mobility results in that the two technologies complement each other.

4. WISPs and venues make the assumption that users spend their disposable time out of office connecting to the Internet. The fact that venues do not seem to understand the market value of WLAN might be true today. However the core business of WISPs and venues are separated. The core businesses of WISPs are to provide mobile communication solutions, the venues mainly conduct activities unrelated from the WISPs activities. This results in that the venues might not see the market as a commercial opportunity for them. Venues also lack the technological competence to manage WLANs by themselves. This indicates that in an initial stage the venues view WLANs as an opportunity to evaluate the technology and how it adds value to their customers. When the contracts between WISP and venues are being renegotiated, their relative bargaining powers between WISPs and venues have changed. The venues will be able to evaluate the value of WLAN more accurately. At the time being the venues create value for the users through offering a supporting service, which might enable them to save on other service facilities within for instance an airport.
5. A mobile network operator providing WLAN will most likely do this in combination with other business models. Through WLAN the operator creates an opportunity to demonstrate the value of mobile Internet through an interface more familiar to the users. The users visiting hot spots, like airports, are probably more inclined to adopt new technology and spend more money on services. This can simulate the demand for 3G services.
6. Mobile network operators offering WLAN in combination with for instance 3G communicate that they are capable of offering the best form of mobile Internet, independent of the user's location.

5.2.7 Competitive advantage and strategic options for mobile operators

Since numerous mobile network operators can use the same business model, the choice of business model by itself does not guarantee success. Success is achieved if the operator is able to outperform its competitors. This section will analyse the operator's ability to create competitive advantages.

Long term profitability can determine if a company has a competitive advantage (Grant 1998). However mobile Internet is a young industry where this evaluation hardly can be applied. Grant (1998) also presents conditions from which competitive advantages can emerge. It therefore seems more fruitful to discuss what will have the potential of becoming factors that may create long term profitability for mobile operators.

The respondents agreed on the extreme importance of information in order to develop attractive content and to understand how to deliver it to the customers in accordance to the consumers' preferences. Information enables the operator to understand the environment, customer preferences and to succeed with innovations. Access to relevant information will be very important for mobile network operators in order to create competitive advantages. The information by itself does not generate competitive advantages, but how it is used in order to create customer value more efficiently than the competitors creates the potential for competitive advantages.

Porter's (1980) generic strategies are suitable in order to understand the emergence of

different kinds of competitive advantages. Regina Wong, at Ovum, concludes that brand is an important competitive factor, determining the operators bargaining power and attractiveness within the network. Brand becomes important because operators that intend to compete fully on the mobile Internet market will not have the ability to use a low cost strategy. This is a result of that the mobile network operators does not enjoy low input costs and they can not gain a large market share through offering standardised solutions. The costs related to infrastructure investments as well as the promotion and marketing costs results in high input costs.

Two factors create a need for the operators to differentiate themselves. First the large number of operators in the industry, network owners as well as MVOs. Secondly the wide scope of services available creates a need for the operators to differentiate themselves. Competing through brand enables the potential of creating customer loyalty. Porter (1980) points out that competing through differentiation limits the ability to reach high market shares. However this is of course depending on how the market is defined. For instance, Vodafone might have a small market share on a national market but holding a large share of the world market. A differentiation strategy can act as a catalyst for internationalization.

The choice of strategy will to a high degree depend on how the operator views the market. Wong explains that the industry will have room for local mobile network operators, such as Telia. Vass, at SonyEricsson, concludes that the mobile network operators have to make a choice between taking a bit pipe role, delivering traffic for other through their infrastructure, or changing their business models. The low cost strategy could be an alternative for the operators who become bit pipe operators. Global players, such as Vodafone and Orange, view the differentiation strategy as the best alternative. Rune Myrthue, at Orange, concludes that differentiation based on brand or services are the same if it is done correctly. A mobile operator can through the scope of its service portfolio communicate what kind of segments they are targeting which is the same communication purpose as the brand has. These variables as well as technology will be important for mobile operators executing a differentiation strategy. Regina Wong, at Ovum, points out that the large players will have difficulties in targeting all customers with customised and attractive service offerings. The focus strategy may be an alternative for players taking advantage of the global operators' inability to target the entire market scope. These players will most likely have to base their focused strategy on differentiation.

Porter (1996) concludes that competitive advantages emerge through performing similar activities better than competitors or performing different activities. Regina Wong, at Ovum, explains that the mobile network operators do not have the capacity to perform all activities needed to deliver customer value. In order to understand what activities should be conducted by the mobile operators and what should be performed by other players in the business model, an analysis of the strategy and the strategic options from a network perspective will have to be conducted. First an analysis of the drivers facilitating internationalisation will be conducted.

5.2.8 Drivers for internationalisation

The previous section made a distinction between local and global players. In order to analyse the drivers for internationalisation, theories from Kotha et al (2001) are used. Kotha et al (2001) studied the impact of intangible assets, such as web traffic and reputation, on internationalisation strategies for US Internet firms. The value of the intangible assets increases with exposure.

The importance of information and brand in order for the operators to create competitive advantages was pointed out in the previous section. Vodafone and Orange are mobile network operators conducting an internationalisation strategy based on their brands. Regina Wong, at Ovum, explains that Orange is perceived as an operator targeting intellectual people with services perceived as intellectual and of high value content. Orange has managed to communicate this successfully through their brand. This increases their opportunity to attract customers who adopt the services for instance on the Swedish market. The benefit for the operator in using the brand in order to communicate the service portfolio is that they reduce the need of promoting services from different content providers individually.

Anders Jensen, at Vodafone, explains that the customer base is very important for the operators. Internationalisation works as a way to increase the customer base. A larger customer base provides for instance Vodafone with increased network traffic and service usage. This provides the operator with important sources of information regarding customer preferences and trends on different markets. An operator can use a valuable brand in order to internationalise. Internationalisation creates increased user volume that generates more information. The increased amount of information transformed to knowledge and allocated to the relevant markets increases the opportunity for the operators to create customer value.

Regina Wong, at Ovum, points out two issues concerning the customer base during the upgrading process from 2,5G to 3G. These are succeeding with upgrading the existing customer base and attract new customers. The brand can be used in order to attract new customers suitable for the operator's service portfolio. Increased amount of information, from increased use of services can be used in order to succeed with the upgrading of the existing customer base.

5.2.9 Managing relationships and strategic options with in the network

This section analyses the mobile operators' potential to develop competitive advantages within their networks. Ensign (2001) is critical to the traditional value chain and points out that value can be created in alliances and different kinds of network constellations. The analysis first focuses on two kinds of external linkages; inter firm inter relationships and network inter relationships. Common for both of the linkages are that they have to be managed through coordination, which consists of identifying attractive partners and then managing the relationship with the identified partner.

5.2.9.1 Identifying and managing relationships

Regina Wong, at Ovum, points out the importance of content providers as an innovative source for the operator and the asymmetrical bargaining power between the two. For the operator the coordination of this external linkage is conducted through two steps.

First the operators have to find content providers with strong innovative capacity. This task will probably not be difficult for mobile operators. Regina Wong, at Ovum, points out that the operators are in an attractive position having the subscriber relationship and the subscriber information. The competition will be tough for content providers and aggregators, in trying to get their content to the end-user through the use of the mobile operators' attractive position.

Secondly the linkages have to be managed in a way that, regardless of the bargaining power, captures the full potential of the relationships. Rune Myrthue, at Orange, points out that the interfaces are open today, which means that content providers provide information on open portals. If the interfaces between operators and content providers were open, it would also be reasonable to have open relationships. Per Bergman, at Aspiro, strongly confirms the value of having access to the information, controlled by the operators, regarding the user profiles of the customers. He believes the reason that this kind of information sharing is non-existing is because the operators do not want to let go of this information. If the operators do not share the information important in order to understand the customers, they will carry the risk of suffocating their innovative source. The actor who has the payment relationship with the customer owns the customer and the consumer information. The fact that the operator often is the owner of the customer highlights the importance of relationships characterised by information sharing in business models based on open platforms.

The operators, having the subscriber relationship, also have a strong impact on the network inter relationships. Anders Jensen, at Vodafone, explains that the mobile Internet industry have not succeeded with performing the appropriate activities at the right time. On the other hand he believes that since the operators take on the risk in the industry, the suppliers have to meet up. It is a fact that the operators take on a significant risk, investing in technology, but as the development within the industry has shown, the risks also influence the suppliers. Anders Jensen explains that the operators have to take a common approach to the governance role within the industry. Naturally there has to be a common approach to governance, but not mainly between the operators. The coordination of network inter relationships has to focus on creating customer value. Mobile operators enable for the network to create customer value through creating competitive advantages supporting the chosen business model. The governance approach should foremost focus on activities within the operators business model. For instance information sharing, technical hosting support to content providers and innovative ways of revenue sharing may increase the mobile network operators potential to facilitate the distribution of content.

According to Robert Vass, Sony Ericsson will provide increased value within their devices. He concludes that the value within the industry will migrate towards the content providing activities. Because of the predicted value migration SonyEricsson will equip their mobile phones with content similar to the offers of independent content provider. This is an example of actors moving into the areas which is perceived to generate the most value within the business model. It also points out the need for a common approach to governance within the business models. If all actors develop capabilities in order to deliver what is perceived to be most valuable within the industry, the need for resource sharing will decrease. This weakens the benefits of being part of a network. Within an operators business model there has to exist a common understanding of what activities the different actors should execute. This is important because the value creation becomes more efficient if actors specialise in the part of the value creation process were they have the greatest competence.

Hougaard & Johanssen-Duus (1999) view the customers as co producers who should be offered a virtual match. Our respondents concluded that value and functionality are more important for the customers than technological aspects. This supports Robert Vass belief that the value within the industry will migrate towards content since value and functionality will be created mainly through the services offered to the end consumers. When the user volume increase the market for content will grow and more actors will try to capture shares of this market. This results in that the pace of the value migration towards content will be impacted

by the increase in the user level of content. The increase in user level will depend on the content provider ability to provide services containing value and functionality.

5.2.10 The Strategic logic from best product towards system lock-in

The Delta Model (Hax & Wilde 2001) points out the importance of different strategic focuses based on the strategic position chosen by a company. The strategic position refers to how the company intends to attract satisfy and retain customers. Since the mobile operator's business model has a wider scope than the firm itself, the strategic position becomes relevant for the relationships with partners as well.

Rune Myrthue, at Orange, describes alignments that have to be used in order to synchronise the development of phones, infrastructure and content. All the respondents express the importance of delivering customer value to the end users. This can be viewed as a type of total customer solution view of the industry since the actors acknowledge the importance of cooperation in order to succeed with mobile Internet. However Robert Vass, at SonyEricsson, explains that they communicate their development plans for the mobile phones and hope that the mobile operators will adapt their customer offers to SonyEricssons development plans. On the other hand Anders Jensen, at Vodafone, explains that the suppliers have to meet up with the operators since they experience the greatest risk. If these conflicting actions characterise the development within the business model it will be difficult to succeed with mobile Internet in accordance with a total customer solutions view.

In order for the mobile operator to attract customers the brand will be important because it communicates what kind of services and value the customers can expect. Customers that have chosen an operator can be satisfied through flexibility, enabling customers to choose between valuable services with high quality. Different terms of payment also enable for the operator to retain the customers. This can be done for example through different kinds of subscription alternatives. Partners, such as content providers, become interested in cooperation with an operator depending on the characteristics of the customer base and what user volume of services it is perceived to provide. In order for the operators to satisfy the content providers, they have to offer services such as shared support services, favourable revenue agreements and share information needed in order to develop attractive content. Depending on the terms of the contract the operators can influence the potential of retaining partners. It is important that the strategic position chosen in the relations with the partners decreases the potential damaging effects of the asymmetrical bargaining power. Both actors depend on each other in order to create revenue, so the relationship has to be designed in order to enable co creation of customer value.

Today, mobile network operators who is going to provide more than bit pipe services, seems to have a view of the industry which is characterized as something close to a total customer solution and moving towards a system lock in view. Regina Wong, at Ovum concludes that the main problem between operators and content providers is the bargaining power. The content providers have to be viewed as complementors since they increase the value of the operators' offerings to the consumers. In order for the operators to fully capture the opportunity of creating system lock in, these actors will have to find a way to cooperate despite the difference in bargaining power. For the mobile operators it will be important to create system lock-in. In the initial stage of the development of mobile Internet services, the market will be characterised by low switching costs for consumers, as a result of unfamiliarity of specific interfaces and service combinations. Creating system lock in also limits the risk of

migrating value to business models such as the MVO business model. The importance for the operators to create system lock-in suggests that mobile operators will increase their use of content providers. Using content providers will increase the opportunity to satisfy a wider customer base, limiting the risk of niche players capturing parts of the operator's customer base. Global operators may through the use of content providers get access to locally related content. This may in turn increase the speed of penetration when entering new markets where the operator lacks knowledge regarding the local demand situation.

5.3 Revenue models

The analysis of the revenue model will be done in accordance with the structure in the theoretical chapter and the overview analysis model. It will be divided in the three parts, valuation, appropriation and allocation.

5.3.1 Valuation

This section contains an analysis of issues important for mobile network operators in order to determine how to price mobile Internet services. Theories from Lynn (1967) and Dean (1961) are used as the foundation.

5.3.1.1 Determining the price of mobile Internet services

Eva Helen Lundgren, at Vodafone, points out that the lack of information about customer preferences and the absence of comparable services makes the pricing of mobile Internet services difficult. She explains that initially prices will be set high in order to monitor the response from customers. The intention to set high prices in the initial stage indicates that Vodafone might be sceptical to the price elasticity relationship (Lynn 1967). The level of price elasticity will differ depending on the characteristic of the operator's customer base. An operator having a customer base consisting of many private consumers will have to consider the price elasticity to a larger extent, than for instance an operator having customers that mainly base their purchase on criteria such as functionality and quality.

Lynn (1967) concludes that the competitive environment influences the initial price significantly. The competitive situation with several operators launching mobile Internet services more or less simultaneously, will result in that costs becomes an important factor for pricing. The reason for that are the low variable costs and the high fixed costs which enables price competition in order to attract customers. Two other factors indicate that a cost based approach will be used for pricing of mobile internet services and these are the lack of comparable services and information concerning customers' preferences. The cost structure is the only source of information that operators have sufficient access to. Information about costs enables fairly accurate arguments to base prices on. Using a cost based approach could be done through the use of flexible cost plus pricing (Lynn 1967). Prices may then take costs, competitive situation and profitability into consideration.

To begin with, the relevant costs derived from the service have to be determined. Secondly fixed costs, based on for instance the share of network resources used by the service, influence the margin. Allocation of fixed costs will be important in order to establish a positive margin. The margin can also be adjusted to the competitors' offers; this can be done in order to conduct a trade off between profitability and market share.

Dean (1961) presents three maturity factors impacting on the initial price and the price over the products life cycle. Many services offered through mobile Internet will mature rapidly and become standardised. The market maturity of the services will depend on the characteristics of each service. For instance services, that substitute services used over the fixed Internet, will mature quickly when users recognise the additional value these services gets from being accessed in a mobile environment. Competitive maturity will result in that the prices of the services become stable, as Dean (1961) suggests. For individual services prices decrease as they mature. As pointed out by Eva Helen Lundgren, at Vodafone, prices are generally set high with consideration to the value in the initial phase. When competition increases, the price level goes down. Dean (1961) points out that pricing strategy will become more important when the market matures. Despite the mobile Internet market being a young and immature market, maturity of services will occur rapidly. Pricing strategies will be important for all kind of services independent of whether they are recently launched or have been available on the market for some time. Through price strategies, the mobile operators are able to facilitate the use of innovative services as well as mature services.

5.3.1.2 Initial price strategies for mobile Internet services

Eva Helen Lundgren, at Vodafone, explains that subsidised devices and campaigns will be used in order to stimulate the use of mobile Internet services. Price strategies will be an important tool in order to create incentives for users to upgrade to 3G services. Accustom the users to a low initial price can be damaging for the operators since low prices has a tendency to stay low. This influences operators that do not intend to mainly compete through the price offerings. Low initial prices might also create misleading information regarding customers' user patterns, resulting in incorrect assumptions influencing future strategic choices. It can be difficult to predict the future for services. For instance services that initially have a low price and a high user frequency might be stamped as valuable for the wrong reason.

The respondents are positive to the thought of using customer value as a base for pricing. However in order to develop price strategies supported by value based billing the operators need more information. For the time being the operators lack sufficient information in order to use value based billing strategies. Information is required in order to understand customer preferences, user patterns and what services will have most potential on the market. The lack of information results in stimulating user volume will be one of the main issues in the launch stage of the mobile Internet services.

Lynn (1967) presents the two pricing policies; penetration and skimming, to be used when companies launch new products. Prices for mobile Internet services will be set at a low level in order to reach a satisfying volume of users and user traffic. Since the customers in the initial stage have difficulties to perceive what kind of value to expect, price elastic customer behaviour will exist to a larger extent. Using a penetration pricing policy would then increase the potential to capture a larger part of the market. A skimming price policy, if to be used in the launch stage, will probably work more satisfactory for operators having more price insensitive customers. For instance corporate customers', were the costs of mobile services only constitute a small part of a companies total expenses, would probably be one of the less sensitive groups.

In order for the operator to maximise the long-term value of services, value based billing is

necessary. Value based billing would use pricing strategies that to a larger extent take various opportunities to deliver services, customer preferences and user patterns into account. The mobile operators that create solutions, which take these factors into account, create a high appropriation potential.

5.3.2 Appropriation

This section contains the analysis of the methods that to some extent are and will be available in order to charge for mobile services. Emphasised by Rune Myrthue, at Orange and Eva Helen Lundgren, at Vodafone, billing systems currently have limitations in their transparency and are for instance preventing desired bundling solutions. The respondents are confident that the industry will see more advanced billing techniques within a short future. Since the development of value based billing techniques depends on advanced billing systems, it is important to analyse the options created by the new systems.

Such system is included in the next generation of mobile data service system, for instance from WaterCove Networks. The system will potentially be on the Swedish market within a year. Regina Wong, at Ovum, concludes that many players will claim to have, and probably have, solutions, which enable to solve the billing issues. However, she points out the distinction between having a system succeeding trial tests and a system that is fully integrated. Advanced systems might have difficulties gaining acceptance in the daily operations. For that reason it is important to bring out the opportunities that advanced mobile data service systems will create for the operators in terms of for instance value based billing.

5.3.2.1 Price discrimination

Price discrimination occurs when users are charged different prices based on variables such as time, quantity, and customer segment. Varian presents (1999) three levels of price discrimination.

Perfect price discrimination would enable for the mobile operator to capture the entire consumer surplus. Perfect price discrimination would occur if for instance a Multimedia Messaging Service was priced at a level corresponding to the maximum level that each user is prepared to pay, based on the expected value of the service. This method of price discrimination might have ethical and legal obstructions, as well as a negative influence on user frequency. Limitations of information regarding user preferences also limit the practical use of perfect price discrimination. It is difficult for the operator to collect information that reflects how the customer values individual services at different times.

Non linear price discrimination is conducted when customers are able to choose between different service offerings. The different offerings create different perceptions of quality and service value. The customers choose the package of services that suits their specific need. This self-selection process results in non-linear price discrimination. The benefit with this method is that specific information regarding customer preferences is not needed to the same extent as for perfect price discrimination.

Third degree price discrimination is frequently used by operators today. This method will also be used frequently for mobile Internet services in the future. Subscriptions containing specific service mixes are designed in order to suit specific groups. For instance teenagers have

service portfolios containing gaming, messaging, and streaming services. Corporate customers have service portfolios containing video conferencing and down loading services. The two groups pay different prices for the different packages, but users buying the same packages pay the same amount. For operators, price discrimination offers an opportunity to optimise the appropriation of customers buying propensity. In order for operators to succeed with price discrimination, extensive amounts of information concerning the customers and the market are needed. The technological system also has to enable different service combinations and flexible billing solutions.

5.3.2.2 Dynamic pricing a new charging opportunity

In order to increase the revenue potential of individual customers and further optimise the use of assets Ajit-Kambil (2002) points out that dynamic pricing is suitable, especially for companies conducting business over Internet.

There are two benefits with the use of dynamic pricing for mobile network operators. First dynamic pricing is useful as a tool to increase the average revenue per user (ARPU). Prices can vary depending on what types of services that are used, when they are used, and from what kind of device the customer accesses the service.

Secondly, the network used, in order to transmit the mobile services, is a result of heavy investments in technological infrastructure. Within the networks there will be a need to continuously stimulate traffic volume. At present it is difficult to predict whether there will be scarcity of capacity in the networks. Scarcity of capacity occurs when users access services that require a high average bandwidth with many peaks. Regardless of whether scarcity of capacity will become an issue or not, dynamic pricing offers a tool for the operator to stimulate demand when user frequency is low and restrict it during peak times. For instance hours that make use of less bandwidth could offer lower prices on high bandwidth services such as video streaming services. And when the network is heavily trafficked, services like voice or messaging, requiring less capacity could be stimulated.

Time based pricing can be seen as the most traditional way of using dynamic pricing. Customers are more inclined to use a service during certain hours resulting in higher prices. Mobile Internet services offers new ways for the operator to use time based pricing. A customer willing to wait for a downloading service could be charged less than a customer requesting priority of the transmission.

Many services will be characterised by a short life cycle. Through clearance pricing, the mobile network operator can increase the revenue from a specific service. Different kinds of gaming services will probably go out of fashion rapidly. Clearance prices enable the operator to offer these services at low prices without causing additional costs. This also enables for the operator to stimulate the user frequency. Combined with bundling, clearance pricing have the potential to facilitate the launch of new services. For instance a mature gaming service could be offered at a low price in combination with an updated version.

Segmentation offers an opportunity to price differently for instance depending on the service level requested by the customer. People willing to search for specific information by themselves might pay less than a person who receives the information through a push service concept. Positioning services could be charged according to this logic.

It is evident that the options for mobile operators to use dynamic pricing are far-reaching. Rune Myrthue, at Orange, emphasise the need of being able to collect traffic information directly from the service platforms in order to be able to charge on other variables than volume. Ajit Kambil (2002) explains that, *send and respond capabilities* as well as *internal visibility*, has to exist in order for a company to use dynamic pricing strategies successfully. For the mobile network operators this means that they need extensive information regarding customer preferences and user characteristics. The operators internal visibility refers to the transparency within the billing systems, referred to by Rune Myrthue.

5.3.2.3 Bundling increases the appropriation potential

Bundling enables for a seller to manage price sensitivity through selling complementary goods together (Varian 1999). Through, for instance combining simple gaming and messaging services with advanced streaming services, the offer has the potential of becoming more valuable for the customer. Different customers are price sensitive to different degrees. The distance between different buying propensities decreases through the use of bundling. This will enable for the mobile operator to appropriate more of the consumer surplus.

The operator has the opportunity to bundle products within different stages of the life cycle. Combining a mature service and a new service can be done in order to facilitate the launch of the new service. This combination creates a perception of a higher value for the offer. Wirtz (2001) explains that bundling offer opportunities to increase customer personalisation. This could be done by the operators through giving the customer opportunity to build their own service packages, choosing from the operators' service portfolio. The number of services from different service categories that the customers choose to bundle could influence the price on the transmission of data, and the degree of subvention of the terminal.

5.3.2.4 Two- part tariffs and subscriptions

A mobile operator that relies on revenue from advertising services can use the concept of two part tariffs (Varian, 1999). The end user could be charged a monthly subscription fee, which corresponds to an entrance fee. Then the users could be charged either by the number of events used or be allowed free access to the services. The use of free access results in that the operator can limit complex billing issues. Usage can also be stimulated through offering content for free. Monthly subscriptions and charging for additional volume of usage will be a common charging method. The customers are familiar with this charging method. Services such as stationary telephony and circuit switched data are charged according to this method.

Glazer & Hassin describe (1982) benefits and drawbacks with the subscription as contract form. The advantage with using subscriptions for mobile operators is that it provides information regarding future demand. Through the subscription the operator also establishes a customer relationship with the potential of creating switching costs for the customer. The use of subscriptions for new services results in that customers lack information in order to evaluate the value of the operator's services. On the other hand, using only spot transactions, this is most favourable for the customers, results in decreased opportunities for the operators to create long-term customer relationships. The operators have to use subscriptions in order to build a customer base, forecast future demand and facilitate the creation of switching costs for

the customers. It will in the initial stage be important that the customers receive sufficient information regarding terms and services, since it will be difficult for customers to evaluate the value that the contract offers.

5.3.2.5 Future appropriation issues for mobile Internet services

It is evident that there will exist numerous opportunities for the operator to bill for mobile Internet services, bundled in different combinations, using different carriers and varying methods to price discriminate. In the launch stage of mobile Internet services, the methods of billing and charging has to be manageable by the operators and understandable by the customers.

When the next generation of mobile data service system will be implemented, the billing options increase. The value based billing techniques should use the carrier that most suitably reflects the customers' buying propensity. The billing or charging technique used for the specific transaction should not concern the customer. Customers should only have to compare the price with the expected value from the service at the time of use.

The current billing debate concerning which carrier to be used, for instance duration, volume or events, is somewhat a misconception. In order for the operator to bill accurately, two factors has to be taken into consideration. First the customers and secondly the operators cost structure.

The customer should reflect the value. The choice of carriers for setting the price is strongly dependent on the certain service's characteristics. Duration suites a voice call due to the consumer acceptance of time as an appropriate carrier of customer value. A voice call lasting twenty minutes is approximately valued twice as much than another call just lasting ten minutes. The customer value of downloading a movie will probably be measured by events, because this carrier best reflects the consumer's willingness to pay for that kind of service. When downloading a file of information, the value most probably will be reflected by the amount of Mb that the file includes. These estimates are rather rough but they are more suitable than measurements based on volume only.

For the mobile network operator the costs related to the activities of enabling for the customer to enjoy the service should be the base that the value carrier is related to. If the operators' network capacity has to be extended, these costs should be allocated to the service type causing the need for the extension. For instance the use of a video conferencing service, which makes use of a much capacity, should have its part of the extension costs allocated directly to them and thus become the cost base when the customers use the service.

The operators should then analyse the value of a specific service through comparing the customer part, reflecting the customer value, with the operator part, reflecting the costs, in order to determine the profitability of the specific service. This will enable selection of high-value contents and services. It is important to understand that the carriers are only the measuring entities used in order to determine the customer value and the costs related to the specific service. There is no simple answer regarding which specific carrier that should be used for the services on the mobile Internet. The operators have to develop more sophisticated modules that combine different carriers in order to appropriate the created value and optimise the network resources.

5.3.3 Allocation

This section provides an analysis of the oligopoly situation among mobile network operators, in which Dean (1961) is used. The allocation section also covers the considerations that have to be made by the mobile network operators in order to create common incentives within the business model.

5.3.3.1 Oligopoly situation between mobile network operators

The competitive situation between mobile network operators can be characterised by a differentiated oligopoly. The services provided by the operators differ due to brand and perceived quality. The mobile Internet industry is in an immature phase and there will be a tougher competition between the operators' offers in the future.

The mobile network operators experience similar cost behaviour as a result of equivalent investments in 3G licenses and network infrastructure. A decrease in the customer demand is a major threat to the mobile network operators' profitability. Excess capacity becomes expensive caused by the high level of fixed costs from investments. The mobile network operator will also have aversion towards price competition. Within the business landscape there will be players better suited for competition based on price, since they have avoided massive investments in infrastructure and licenses. Secondly, prices that once have decreased rarely rise to previous levels.

In order to decrease the risk of price competition, the mobile network operators can use non-price competition (Dean, 1961). Disruptions such as decreased forecast of the future market value can act as a trigger causing price competition. If competition is based on variables not associated with price, the risk of exposure for the operators decrease. It will be difficult for competitors to retaliate against an operator competing with a strong brand or superior technological competence.

The competition between actors behind the operator in the value delivery network is stronger. Here competition takes place between specialised players such as content providers and focused MVOs. It will be important for the mobile network operators to minimise the consumer surplus. The competition between the actors behind the operators, such as the MVOs, will lead to decreased prices. A threat to, and a possible consequence for the mobile Internet industry will be value outflow to the consumers in terms of customer surplus. This because the third party players have to differentiate with lower prices or innovative services due to the highly competitive environment behind the operators.

5.3.3.2 Alliances and networks from an allocation perspective

Byrne et al (1993) emphasises the importance of creating win-win deals in order for partnerships to work sufficiently. Revenue sharing is critical between mobile network operators and the content providers/aggregators. Eva Helen Lundgren, at Vodafone, agrees to the importance, but points out that this is difficult in reality. Vodafone invests significant amounts of resources in the co-creation of services with content providers. This strongly influences on the revenue sharing agreement, which in turn highlights the need for revenue sharing agreements that do not totally depend on the amount of resources committed to the

service development. The resources possessed by the operator will always be more extensive. Building the revenue agreements on amounts of resources invested only, will not take the differences in bargaining power between the actors into consideration in a sufficient way.

The user volume of the services also influences the win-win deals, supposed to be created. Per Bergman, at Aspiro, does not believe that Aspiro benefits from revenue sharing as a result of the operators' poor marketing efforts for the services. For the operators it is expensive to conduct marketing activities for each individual service offer. When mobile Internet has developed it would be almost impossible, since the short product life cycle and the wide scope of services that will exist. The operator would have to market services frequently, resulting in potential confusion for the end users. If an operator promotes services through their brand, revenue agreements could be based on the services ability to strengthen the brand. Variables such as amount of new customers could be used to determine how the revenue should be allocated.

Common for Byrne (1993) Hamel (1989) and Chan-Olmsted & Jamison (2001) are that they conclude that the objectives or intents with joining alliances significantly influence the potential of succeeding with the alliance. The purpose of content is to generate customer value in order to generate revenue for the actors within the business model. This vision should guide the revenue sharing activities. Per Bergman and Kenneth Sandevi, at Aspiro, explain that Aspiro creates value for the operators through identification, aggregation and development of content.

Probably all content providers have somewhat the same arguments. The operator dealing with many content providers and aggregators could benchmark them against each other and use it as a tool to allocate revenue. Allocation variables could be the services potential to attract new customers, exemplified above. Also the extent to which the service satisfies the customer could be used, related to customers' user frequency. The services' ability to retain customers could be evaluated based on the duration of the subscription for the specific service. Using these variables would indicate for the mobile network operators what content providers that actually provide value. A comprehensive evaluation of the different content providers could also be made based on their innovative capabilities. This could be evaluated based on the content providers' time to market for new services.

Independent of how the revenue sharing agreements between content providers and operators are designed, the main point is that an actor delivering value should be paid in accordance to the created value. The present debate concerning revenue agreements may to a large extent be explained by the lack of information and sophisticated tools that measures the actual value created by a service. The need for software that enables this information and techniques for measuring the created value has to be developed.

Both the operators' and the content providers have to benefit of being part of a wider value delivery system (Shank & Govindarajan, 1993). The operators have to be aware of the costs emerging from the activities conducted by the content provider/aggregator. Providers also have to understand the costs associated with managing the customer relationship and the enabling for services to be delivered. This information has to be shared in order for the actors to develop beneficial external linkages (Shank & Govindarajan, 1993).

5.2 Correlated analysis

The correlated analysis is combining and further developing the three previous sections of analysis with the purpose of answering the questions stated in the problem formulation.

5.2.1 How does the business landscape influence the possible business models for mobile Internet?

The business landscape for mobile Internet is doubtless a result of what Normann (2001) means with the new economy. It is a knowledge intensive network economy characterised by a new strategic paradigm based on specialisation, relations and co-operation. The mobile Internet industry views the consumers as co-producers and has to create value on the consumers' conditions. The mobile Internet industry is complex both regarding technology and business environment. Nonetheless, the complexity has to be an enabler for simplicity and increased opportunities for the consumer, rather than a technological difficulty. The consumers must not bother how the services they use are created or distributed. They should only be exposed to the value the services generate.

In this business environment, the design of the business models has to enforce efficient value creation through co-operation by a large amount of players, specialised on their core activities. A good business model enables shared visions and unity about what activities is value creating and what approach the system should have to the market. The business model has to allocate risk related to investments, information concerning customer preferences and revenue, in order to create incentives in accordance with the visions. A stable business model has a leader who manages and controls the allocation of the dematerialised flows mentioned above. This governance role suites the mobile network operator perfectly. The MVOs also have the potential to embrace this role.

The business landscape for mobile Internet also includes the underlying forces of Metcalfe's law and increasing returns. Metcalfe's law implies network externality effects and contributes to the increasing returns. Increasing returns is also a consequence of the low distribution costs and the high investments that characterise the mobile Internet industry. Different geographical markets are also affected of varieties in population density and socio-cultural aspects. The variety in cultural and social behaviours somehow limits the increasing returns, since all markets are local and specific in terms of the mentioned aspects. It means that global players are unable to duplicate already developed services to all their markets without considering the specific conditions.

This means that the business models have to consider the cultural and social aspects in the value creating process for every specific market. The consequence is locally related content. The overall result is that the mobile Internet is best suited and most profitable for markets where the population is large, dense and has similar cultural and social conditions. Regions like Japan and China are from this point of view optimal.

The business landscape for mobile Internet also differs in terms of innovative capacity. Most areas in Europe can be regarded as strongly innovative. This depends on factors such as access to financial and human capital as well as technological progress. Sweden and Finland can be regarded as high-developed telecommunication areas.

Geographical areas with high innovative capacity enable business models which to a larger extent rely on innovative third party players such as content-, service- and terminal providers. Open business models with an increased number of specialised players will fit these circumstances well.

5.4.2 How do the revenue models influence the possible business models for mobile Internet?

The revenue model constitutes the modes determining the business models potential to generate revenue. The quality of the mode in a relationship is determined by the three activities, valuation, appropriation and allocation. The mobile operators have to succeed with these activities in all relationships containing transactions of value.

At present the valuation of the services is a volume driven cost-based pricing. The volume drives the revenues and the price is set in order to cover the costs plus a profit margin. The reasons to this approach are three. First the competition quickly forces the price down to a cost-based level, which is normally lower. Secondly there is a lack of comparable substitutes to base the price on and thirdly there is a lack of information regarding consumer preferences and behaviour. It means that the only certain information about the value of a service is determined by the costs. This is a rather bad estimation that results in disturbances of the supply-demand relation. Currently a cost based approach to value services limits the potential to price services accurately with consideration to the created value.

The future valuation is going to be value-based in order to appropriate an optimised amount of the created value within the business model. For the players within the business models this is an essential issue since the valuation and the appropriation are the activities that determine how much the activities and efforts are rewarded. The revenue model is the tool to manage the incentives for the included players in the business model and the owner of this tool is the player who owns the billing relation to the consumer. These players are at present the network operators and the MVOs. Technological development will enable a more accurate valuation of the services that considers the created value. The value created within the business model will then have the potential to be more accurately priced.

To optimise the appropriation, discrimination pricing through bundling and dynamic pricing has to be enabled. Dynamic pricing also, in addition to discrimination, makes it possible to optimise the use of network resources and consequently makes the business model more effective in terms of leveraging the investments. At the time being it is not possible to do this due to lack of visibility in the billing systems. For instance WaterCove Networks claims that their data service system gives the network operators these opportunities. It is evident that the future will have a solution to the current technological restraints. Nevertheless the uncertainty is related to who the provider of these opportunities will be. Currently Vodafone and Orange do large scale testing of WaterCove's system and if this system is a success, these two major players most probably are going to buy it. This concern is of great importance for the future of all mentioned business models and especially the enabling platform business model. In order for the business model to fully capture the value created, further technological progress is needed.

Since the services mature rapidly, it is essential to have relations to innovative service and content providers that are able to quickly supply new contents and services. This will contribute for the certain operator's business model to be first to market and appropriate an

increased amount of revenue. Information about consumer preferences and behaviour, generated from the future data service systems, will enforce this innovative capacity and enable efficient service development that harmonises with the brand of the operator. The mobile Internet industry has a rare opportunity to generate continuous consumer information from the distribution channel. For the business models, this information is very valuable in order to create knowledge and generative relations resulting in an efficient value creating system.

5.4.3 What will be important for operators in order to create value within the possible business models for mobile Internet?

A large customer base in combination with a strong brand is the key success factor and specifically important in an economy with increasing returns. A strong brand minimises the promotion costs and a large customer base generates synergies of scope and scale. To link a strong brand and a large customer base together, information about the consumers' preferences and behaviour is needed. The information makes it possible for the originators to more rapidly develop and provide contents and services in accordance with the brand. This creates a value creating system where the consumers get what they expect from the certain brand.

In addition to the information generated by the billing system, the other important tool is the revenue. The revenue has to be shared between the players in a way that reflects the value creation and the importance of the different activities. All activities are dependent on each other and the players are complementors which the value creating system has to co-ordinate in order to create customer lock-in effects. The suffocation of innovative capacity due to variation in bargaining power has to be reduced. Further the revenue sharing has to occur in a way that generates incentives to develop competence within respective player's core activities.

Information and revenue sharing can be used as a tool for managing the creation of common incentives and visions. These tools, if used properly, enable strong relations and constitute the base for competitive advantages due to the tacit characteristics. At present the mobile Internet market seems to lack this understanding. This depends to a large extent on the variety of opinions regarding where the value is created. It seems as a common problem for immature network economies. The players do not know exactly what role they are supposed to have and it is difficult to estimate the value creation of other players when there still is no large-scale market. The relations will mature though, and it is important for the operators to stimulate this.

Another issue that is of great importance for the operators' value creation is the conversion from GSM and GPRS to 3G. As mentioned the size of the customer base implies competitive advantage in combination of a strong brand. The competition of the customers can be a threat to the mobile Internet industry. The network operators have to create unity about a non-price competition. They have to compete with brand and personalised services rather than price. Otherwise the created value within the business models will be allocated to the consumers in terms of consumer surplus and that would be a problem considering the huge investments. The MVOs are armed to compete with price though. They have not invested in licences or infrastructure, which means that they are suited to attract new customers in order to enlarge their small customer bases with lower prices. The relief for the network operators is that they due to their large customer bases also can afford to have low prices without risking the future.

But in a large geographical area such as Sweden, where the population is small, this is not much of a relief. However the problem still remains. There will be lost revenue due to the competition for the customers. This competition also creates forces that stimulate consolidation for the MVOs as well as for the network operators. All together, it is important for the operators and the mobile Internet industry to have a common approach to the conversion from GSM and GPRS to 3G in order to appropriate a satisfactory amount of the created value within the business models.

6 Conclusions

In this chapter we present our conclusions in order to answer the purpose of this thesis. The conclusions regarding the six business models' potential to be successful for mobile Internet are based on the insight provided from the analysis.

The *paid for content business model* is a very attractive model for global players with a strong brand. They are able to attract the segments on the local market that suits their brands and through strong customisation the consumers are prepared to pay for it. These global operators do not have to serve all segments, but only the ones which fit the profiles of their brands. Global players will have a large customer base globally, despite smaller regional market shares. The important thing for the global players is to communicate their brands properly. In Sweden this kind of business model is appropriate due to the high-end consumers that are used to high quality public service. The cultural and social behaviour is in Sweden more suited for high quality services and consequently also for the paid for business model.

In the *free content business model* the mobile operators' revenue comes from the advertisers. It means that the key determining factor for how successful the model will be is the amount of value created for the advertisers and consequently their willingness to pay. Value for the advertisers is created if and when they reach the aimed segments of customers with their messages. The more precise and specific the advertising is allowed to be, the more value will be created. The problem is however that free content attracts price sensitive customers. This kind of customers can be regarded as representing a specific segment. The consequence will be that the potential value for the advertisers is reduced, since they can not reach all kind of segments. Free content will to a large extent attract teenagers and young people. Accordingly the advertisers will be actors aiming to reach this segment with their messages. Even if this segment today has a higher disposable income than before, this kind of segment does not attract most of the advertisers. It means that the free content business model lacks sufficient economic logic. Besides, Swedish laws and restrictions do not allow advertisements targeting children.

The optimal business model in regions with characteristics such as in Sweden, would be a combination of the free content and the paid for content model. The global players with strong brands should not allow all kind of advertising, but rather such that generates additional value to the customers. Such advertising should be considered as a complementary service and enforce lock-in effects. The limitations of the advertising should be customised based on the individual subscribers' requirements. The subscriber should be able to decide when to be reached and what kind of advertising to receive. Possibly the consumers would only like to be reached by the advertisements when there is a demand for it. This kind of advertising enables further revenue streams from advertisers as well as an increased customer value.

The *intelligent facilitator business model* will suit non global players, such as Telia. These players will have to reach a larger number of consumers than they will be able to attract by themselves in order to finance their heavy investments in infrastructure. Telia proved to have competence regarding the technological system that operates the traffic and might develop this competence further and become the first choice network operator for global players that want to enter the Swedish market. If Telia choose this way of doing business their brand will be irrelevant for the consumers, but important to attract global operators. To generate value

within the intelligent facilitator business model, the network operators need complete control of the billing and data service systems. This further depends on the relationships with the players that adapt the enabling platform business model.

The *MVO business model* is not by itself an unsuitable business model. The model is a direct answer to the new economy that is based on relationships. The MVOs have minimised their investments and their core competence is focused on managing relationships. The mobile network operators' investments in infrastructure and licenses imply both huge risks and costs, which they have to be compensated for. At the time being, MVOs are invited to buy network capacity since the mobile network operators want to increase the traffic in their networks. Currently the price level for network capacity does not result in high margins for the MVOs when all their costs have been considered. However in the long term prices for network capacity will decrease since it will be regarded as a commodity. Furthermore the government authorities must consider the interests of both the consumers, the MNOs and the MVOs. The government authorities will have to improve the industry conditions and reduce the uncertainty through efforts that increase competition without preventing the MNOs to get proper returns on their risky investments. The regulation of the authorities will most probably also result in decreased prices for network capacity. MVOs will moreover have the ability to buy network capacity from intelligent facilitators who do not have any incentives to exclude MVOs from the market. The intelligent facilitators will collect their revenue streams mainly from supply of infrastructure and services. This will enable for the MVOs to be less dependent on the infrastructure controlled by the mobile network operators.

This long term industry development result in that there will be no crucial differences between a MVO and a global MNO if their brands are equally strong. We believe that the government authorities will succeed with the price regulation, and that MVOs will be able to buy network capacity from intelligent facilitators. MVOs that succeed with building strong brands and create a competitive size of their customer bases will have potential to succeed. However, currently most of the MVOs are small and do not have a strong brand and that is what makes these MVOs weak, not their business model.

The *enabling platform business model* seems to be a successful business model considering the current billing problems. The mobile Internet industry is awaiting the solution of these problems and most probably it will come from players others than the network operators. The reason for that is the network operators' lack of competence within the area. There are extensive technological problems within the immature mobile Internet industry and the network operators have not managed to develop this additional competence. Therefore other actors, such as the enabler WaterCove Networks, are suitable to solve the problems with their enabling platforms. When these initial problems are solved, the actors in the enabling platform business model have to create value through services enabling the network operators' activities. Consequently the players in the model have to enforce close relationships with network operators. The more integrated they will be, the more value will be created. It is possible that the enabling platform provider will be the actor who manages the billing relation to the consumers. The reason is that the performance of the billing system is to high extent dependent of the platform provider's skills and competence. Therefore perhaps certain operators will outsource the billing activities and the responsibility for monetary transactions to platform providers. The result will be increased value creation by the enabling platform provider and a successful future business model.

The *WLAN business model* will be a complement to other business models. The combination

of 2.5G or 3G and WLAN will enable more complete offerings to the consumers. When the handover capacity increases, the consumers will be able to use the system that provides the highest quality, no matter where they are. The consumers do not care about what technology is enabling the services. The consumers only care about the value that the services contribute with which is in accordance with the new strategic paradigm.

To sum up, the authors conclude that the free content business model is not the one to choose due to its weak economic logic. A good choice for global players, on markets with characteristics such as in Sweden, is the paid for content model with complementary advertising services. The intelligent facilitator business model is suitable for local network operators. The future success of the enabling platform business model depends on the degree of integration between the network operators and the platform providers. The WLAN model will be a complement to the operators' business models and make their offers more complete. And finally, the MVOs' business model will in general terms experience the same conditions as the global network operators' business models. The important issue is nonetheless the strength of their brands and the size of their customer bases.

Four resources will be important for mobile operators regardless of what business model they choose to adopt in order to succeed with mobile Internet. First the ability to *manage relationships* will be important in order to create incentives for third party providers. This is important for the mobile operator in order to secure development of attractive services which improves the value creation potential within the business model. Secondly the *brand* will be important for the operators in order to attract customers and build a customer base. The services offered by the mobile operator will impact strongly on the customers' perception of the mobile operators' brand.

The third important resource is the *customer base* which influences the level of bargaining power the operator will have. An attractive customer base will facilitate for the operators to attract third party providers such as content providers and advertisers. A considerable customer base generates customer information through their characteristic and use of services. *Customer information*, the fourth important resource, can be used in order to develop attractive and customised services which enable the operator to satisfy and retain the customers. Customer information will also be important for the operator in order to price services properly and to appropriate the value created within the business model.

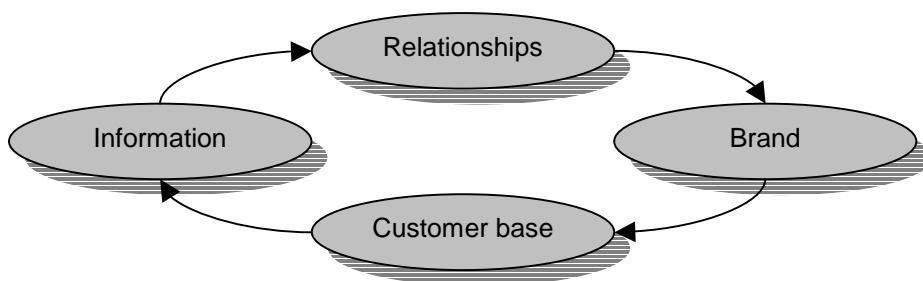

Figure 6.1- Four key resources for mobile Internet business models

A doubtless truth concerning the mobile Internet industry is that the future is risky and unpredictable. This calls for flexibility, which implies new options and abilities to continuously make new decisions. The choice of business model has to be influenced by its ability to transform and create new possible directions and strategic options.

7 Bibliography

7.1 Published sources

- Amit, R. & Zott, C. 2001 “*Value Creation in E- Business*” *Strategic Management Journal* 2001, Vol. 22, 493-520
- Arthur, W. B., 1994 “*Increasing Returns and Path Dependence in the Economy*” The University of Michigan Press, Ch 1-2
- Byrne, J. & Brandt, R., & Prot, O. 1993 “*The Virtual Corporation*” *Business Week*, February 1993, 36-40
- Chan-Olmsted, S. & Jamison, M. 2001 “*Rivalry Through Alliances: Competitive Strategy in the Global Telecoms Market*” *European Management Journal* Vol. 19 No. 3, 317-331
- Dean, J. 1961 “*Managerial Economics*” Prentice Hall, Inc. Englewood Cliffs
- Demetrius, T. 2001 “*Is there a problem with your bill?*” *Telecommunications*, June 43-46
- Derefeldt, P. & Waldö, T. & Djerf, K. 2002 “*Affärsmodeller for mobilt Internet*” Master Thesis
- DeZoysa, S. 2001 “*A 3G billing maze*” *Telecommunications*, March, 38-42
- Dunås, E. 2001-11-15 “*WAP-Floppen går i repris med GPRS*” *Industry Standard*, 9
- Edlund, P-O. & Högberg, O. 199 ”*Beslutsmodeller*“ Lund: Studentlitteratur
- Eneroth, K. & Malm, A. T. 1999 “*Knowledge webs & Generative relations – A network approach to Developing Generative Competencies*” *European Management Journal* Vol 9. nr 2, April 2001. 174-181
- Ensign, C-P. 2001 “*Value Chain Analysis and Competitive Advantage*” *Journal of general Management* Vol. 27 No 1 Autumn 2001 18-40
- Glazer, A. & Hassin, R. 1982 “*On the Economics of Subscriptions*” *European economic review* vol 19. 1982 343-356
- Grant, R. 1998 ”*Contemporary Strategy Analysis*” Blackwell Publishers inc.: Malden
- Hagel III, J. & Singer, M. 1999 ”*Unbundling the Corporation*”, *Harvard Business Review*, March-April 1999, 133-141
- Hamel, G. & Doz, Y. & Prahalad, C-K. 1989 ”*Collaborate With Your Competitors - and Win*” *Harvard Business Review*, January-February, 1989. 133-139
- Hamel, G. 1999 “*Bringing Silicon Valley inside*” *Harvard Business Review* Vol. 77 No. 5, 70-84

Hax, A. & Wilde, D. 2001 “*The Delta Model – Discovering New Sources of Profitability in a Networked Economy*” European Management Journal Vol. 19, no 4 August 2001

Henderson, B-D. 1989 “*The Origin of Strategy*” Harvard Business Review, November-December 1989, 139-143

Hopper, M. 2001 “*Billing the 3G extravaganza*” Telecommunications, September, 77-80

Hougaard, S. & Johannsen-Duus, H. 1999 “*Competing in the Digital Age*” Journal of general Management vol. 24 No. 3 Spring 1999, 1-9

Howell-Jones, J. 2000 “*Billing the datawave*” Telecommunications, July, 32-36

Kambil-Ajit, H. & Wilson III, J. & Vipul, A. 2002 “*Are you leaving money on the table*” Business Strategy Volume 23 No. 1 Jan-Feb, 40-43

Kotha, S., Rindova, V-P., Rothaermel, F-T. 2001. “*Assets and Actions: Firm-Specific Factors in the Internationalization of U.S. Internet Firms*” Journal of international business studies, Vol 32 No. 4, 796-791

Lynn, R. 1967 “*Price Policies and Marketing Management*” Richard D. Irwin, Inc., Illinois

Magretta, J. 2002 “*Why Business Models Matter*” Harvard Business Review, May 2002, 86-92

Normann, R. 2001 “*När Kartan Förändrar Affärslandskapet*” Liber Ekonomi, Malmö

O'hame, K. 1983 “*The Mind of the Strategist*” Penguin Books, Harmondsworth

Pitt, L. 2001 “*Total E - clipse: Five New Forces for Strategy in the Digital Age*” Journal of General Management Vol. 26 no. 4 summer 2001, 1-14

Porter, M. & Stern, S. 2001 “*Innovation-Location Matters*” MIT Sloan Management review, Summer 2001. 28-36

Porter, M. 1996 “*What is strategy*” Harvard Business Review, November – December

Porter, M. 2001 “*Strategy and the Internet*” Harvard Business Review, March 2001. 63-78

Porter, M-E. 1980 “*Competitive Strategy*” Free Press, New York

Porter, M-E. 1985 “*Competitive Advantage*” Free Press, New York

Prahalad, C-K. Ramaswamy, V. 2000 “*Co-opting customer competence*” Harvard Business Review Vol 78, 79-87

Reinhardt, A. 2002 “*Telcos in Hell*” Business Week, April 1, 66

- Schneiderman, C. 2001 “*Are you billing in real time?*” *Telecommunications*, July, 41-45
- Secker, M. 2001 “*It’s a whole new ball game*” *Telecommunications*, September, 30-32
- Shank, K. & Govindarajan, V. 1993”*Strategic Cost Management*” The Free Press, New York
- Shilling, M. 1999”*Winning the Standards Race: Building Installed Base and the Availability of Complementary Goods*” *European Management Journal*, Vol 17. No 3. 365-274
- Thorngren, B. 2002 “*Public W-LAN The interaction between venues and WISPs*” Master Thesis, Lund School of Economics and Management
- Törnwall, M. & Båge, J.2002-03-15 ”*Sonys innehåll ska sälja våra telefoner*” *Dagens Industri*, 10
- Törnwall, M. 2002-03-05 “*Det är inte natt svart*” *Dagens Industri*, 9
- Varian, H-R. 1999 ”*Intermediate Microeconomics, A Modern Approach*” W. W. Norton & Company, Inc. United States of America
- Weiland, K. 2002 “*ARPU levels under scrutiny*” *Telecommunications*, January, 18-20
- Werbach, K. 2000 “*Syndication The Emerging Model for Business in the Internet Era*” *Harvard Business Review*, May-June 2000, 85-93
- Williams, M. 2001-11-15 “*Smekmånaden är över för DoCoMo*” *Industry Standard*, 39-40
- Wirtz, B-W. 2001 “*Reconfiguration of Value Chains in Converging Media and Communications Market*” *Long Range Planning* Vol 34 No. 4 August, 489-506
- Wolf, G. 2001 “Mobile Internet Business Strategies“

7.3 Electronic Sources

(<http://www.teliacomobile.se/dsparticle.cgi?artid=12428>)

”Förstå olika nät” SonyEricsson, www.sonyericsson.com/se/spg/.jp?page=C4.7&B=ie, 2002-05-12

“WLAN: A Threat to 3G”, UMTS Forum, http://www.umts-forum.org/mobilennium_online/2002.02/story3.htm, 2002-05-04

“3G – How to exploit a trillion opportunities”, UMTS Forum, http://www.umts-forum.org/ppapers/UMTSF_PPAPER1_final.pdf, 2002-04-04

“Exploiting the opportunities for Personalized Mobile Data Services” http://www.watercove.com/pr_021802.html, 2002-04-25, WaterCove I

“UMTS 3G Markets Forecast”, UMTS Forum, <http://www.umts-forum.org/reports/report18.pdf>, 2002-04-25

“*Purpose-Built Architecture Required for Mass-Market Deployment of Personalized Data Services*” 2001, <http://www.watercove.com/pdf/Purpose.pdf>, 2002-04-25, WaterCove I

“*Enormous success of smart tim and timsport: An innovative form of advertising is born through the mobile phone*” www.tim.it , 2002-05-15

www.homerun.telia.com , 2002-05-21

<http://www.competencekista.com/competence.php?ArtId=1367> (26/5)

7.4 Oral Sources

7.4.1 Personal Interviews

Bergman, Per. Market Director, Aspiro, Sweden, 2002-04-26 Malmö

du Hane, Frederick. MD, Dial n’ Smile, Sweden 2002-05-07, Malmö

Jensen, Anders. Business Enabling Solutions, Sweden, 2002-04-24, Karlskrona

Lundgren, Eva Helen. Pricing Unit, Vodafone Sweden, 2002-04-24, Karlskrona

Myrthue, Rune. Manager Commercial Planning & Business Intelligence & Pricing, Orange, Sweden, 2002-05-08, Malmö

Sandevi, Kenneth. Business Development, Aspiro, Sweden. 2002-04-26 Malmö

Wass, Robert. Senior Manager Application Product Management, SonyEricsson, 2002-04-16, Lund

Wong, Regina. Analysts Wireless Communication, Ovum, 2002-05-13, London

7.4.2 Telephone Interviews

Engström, Johan. PTS, 2002-04-19, Stockholm

7.5 Other

Ovum, 2001 “*Wireless Internet Business Models: Global Perspective, Regional Focus*”

Appendix – A

Interview template

This Interview template is aimed at visualising what kind of questions was asked when making the interviews and what topics were being highlighted. The interviews were held open, which made it impossible to exactly follow the outlines of the template. This template should rather be regarded as an overview summary of what was being discussed during the interviews.

Introduction

- Introducing ourselves and the purpose of the thesis.
- Emphasising that we do not have any principals or assigners and thus are not getting paid by anyone for the information collected.
- Asking whether it is ok to record the interview.

Start up

- What is Mobile Internet? How do you conceptualise mobile Internet?
- How is your company approaching mobile internet?
- What is your role in your company's mobile Internet business?

Business Landscape

- Who are the different actors within the mobile Internet industry?
- How would you describe the business environment?
- What characterises the mobile Internet industry?
- How would you describe the existing conditions within the mobile Internet industry?

Business Models & Strategy

- How do you conceptualise a business model?
- Would you like to graphically illustrate how you are viewing your business model for mobile Internet?
- Explain the roles of the different actors within the illustrated business model.
- Explain the different flows between the actors.
- What do the flows consist of and why do they exist?
- How do you view the enormous flows of information?
- How can this information be used?
- What role do you think that the operator is taking and/or should be taking?
- What are the strengths and the weaknesses with “your” business model?

- What possible business models can you identify within the mobile Internet industry?
- Can you explain the advantages/disadvantages with the alternatives?

- What is your strategy within the mobile Internet industry?
- How do you compete within the mobile Internet industry?
- Is WLAN a competitor or a partner?
- Which are the possibilities for the different actors to compete and create competitive advantages?

Revenue Models

- What value flows do you identify and/or anticipate within the business models?
- How do you value or price these flows?
- How is the value defined and prices being set?
- What alternatives are present to arrange the payments between actors?
- How do you approach revenue sharing issues?
- What possible cost carriers are or may be useful?
- How has the move from circuit-switched to packet-switched data influenced pricing?
- What are the critical factors for charging optimally? (Technology, Software, Legal Constraints)

Future Development and Concerns

- How will mobile Internet develop?
- What will be the main sources to creation of value?
- How will the characteristics of and the conditions within the mobile Internet industry develop in the future?
- What new actors may appear within the industry and what roles will they take?
- What are the major trends in how to compete in the future?
- How will competitive advantages for the different actors be created in the future?