

Calcium Influx in Internally Dialyzed Squid Giant Axons

REINALDO DIPOLO

From the Centro de Biofísica y Bioquímica, Instituto Venezolano de Investigaciones Científicas, Caracas 101, Venezuela

ABSTRACT A method has been developed to measure Ca influx in internally dialyzed squid axons. This was achieved by controlling the dialyzed segment of the axon exposed to the external radioactive medium. The capacity of EGTA to buffer all the Ca entering the fiber was explored by changing the free EGTA at constant $[Ca^{++}]_i$. At a free $[EGTA]_i > 200 \mu M$, the measured resting Ca influx and the expected increment in Ca entry during electrical stimulation were independent of the axoplasmic free $[EGTA]$. To avoid Ca uptake by the mitochondrial system, cyanide, oligomycin, and FCCP were included in the perfusate. Axons dialyzed with a standard medium containing: $[ATP] = 2 \text{ mM}$, $[Ca^{++}]_i = 0.06 \mu M$, $[Ca^{++}]_o = 10 \text{ mM}$, $[Na^+]_i = 70 \text{ mM}$, and $[Na^+]_o = 465 \text{ mM}$, gave a mean Ca influx of $0.14 \pm 0.012 \text{ pmol}\cdot\text{cm}^{-2}\cdot\text{s}^{-1}$ ($n = 12$). Removal of ATP drops the Ca influx to $0.085 \pm 0.007 \text{ pmol}\cdot\text{cm}^{-2}\cdot\text{s}^{-1}$ ($n = 12$). Ca influx increased to $0.35 \text{ pmol}\cdot\text{cm}^{-2}\cdot\text{s}^{-1}$ when Na_o was removed. This increment was completely abolished by removing Na^+_i and (or) ATP from the dialysis medium. At nominal zero $[Ca^{++}]_i$, no Na_r -dependent Ca influx was observed. In the presence of ATP and Na_i , $[Ca^{++}]_i$ activates the Ca influx along a sigmoid curve without saturation up to $1 \mu M [Ca^{++}]_i$. Removal of Na^+_i always reduced the Ca influx to a value similar to that observed in the absence of $[Ca^{++}]_i$ ($0.087 \pm 0.008 \text{ pmol}\cdot\text{cm}^{-2}\cdot\text{s}^{-1}$; $n = 11$). Under the above standard conditions, 50–60% of the total Ca influx was found to be insensitive to Na^+_i , Ca^{++}_i , and ATP, sensitive to membrane potential, and partially inhibited by external Co^{++} .

INTRODUCTION

Since the finding that a fraction of the Ca efflux in squid axons might be involved in a Na-coupled exchange mechanism (Blaustein and Hodgkin, 1969) a great deal of work has been devoted to analyze this particular unidirectional Ca flux. Although not all the features of the Ca efflux have been firmly established, most of the quantitative dependencies on Na_o , Na_i , Ca_o , Ca_i , E_m , and ATP_i are well documented in the literature (Baker et al., 1967, Baker, 1972; Baker and McNaughton, 1976; DiPolo, 1973, 1974, 1977; Mullins and Brinley, 1975; Blaustein and Russell, 1975; Blaustein, 1977). This picture is in contrast with our knowledge concerning Ca entry through the Na/Ca exchange mechanism. Although it is known that Ca influx depends on variables such as Na_o and Na_i , (Baker et al., 1969), at present very little is known about the quantitative relationship between Na_i , Ca_i , ATP_i , and Ca influx. The main purpose of this paper is to examine the detailed properties of the Ca influx into squid axons

under conditions of internal solute control. The experiments reported in this paper fall into two groups. Those of the first group were designed to investigate whether the magnitude of the Ca influx in dialyzed axons resembles those of intact axons. The purpose of the second group of experiments was to analyze the activation of the Ca influx by Na_i^+ and Ca_i^{++} in axons with high and low ATP content. The results indicate that the Ca influx measured in dialyzed axons agrees in magnitude with those measured in intact axons, and shows the same qualitative dependence on Na_i , Na_o , and E_m . Cation activation of the Ca influx indicates that a finite $[\text{Ca}^{++}]_i$ is necessary for the existence of a Na_i -dependent Ca influx. The influx of calcium in exchange for sodium was found to be membrane potential-sensitive and completely dependent on the presence of ATP_i . The absence of a Ca_i -activated Ca influx in axons dialyzed without internal sodium suggests that, under normal conditions (i.e., with $[\text{Na}]_i > 0$), $[\text{Ca}^{++}]_i$ activates the influx of Ca rather than exchanges with Ca_o . The component of the Ca influx that is insensitive to Na_i^+ , Ca_i^{++} , and ATP was found to be sensitive to membrane potential and partially blocked by external Co^{++} ions.

METHODS

The experiments were performed using live specimens of the tropical squid *Dorytheutis plei*, which were kept in large tanks of artificial seawater (instant ocean). Immediately after decapitation, the giant axons were dissected from the mantle in seawater. The mean axon diameter was 425 μm ($n = 50$).

Influx Chamber

The dialysis technique has been used to measure influx of ions in squid axons (Brinley and Mullins, 1967). One of the basic limitations to the technique is that the isotope collected by the porous capillary includes not only the radioactive isotope coming from the dialyzed segment of the axon, but also that which enters the fiber beyond the porous region and diffuses longitudinally into the porous capillary. This tends to give relatively high and unstable influx values. A solution to this problem has been worked out recently by Brinley et al. (1975) using two porous dialysis capillaries, one for collecting the isotope from the dialyzed portion of the fiber and the other for keeping the end regions of the axon free of isotope. Although this technique has been used successfully in large axons ($> 600 \mu\text{m}$) from *Loligo forbesi* (Brinley et al., 1975), the large cross section of the double dialysis capillary makes it difficult to use in small axons (400–500 μm) from *D. plei*. Therefore, we have designed a method for measuring Ca influx using a single dialysis capillary. The procedure consists in confining the isotope strictly to the dialyzed portion of the fiber. This was achieved by a guard system (see Fig. 1 and legend to Fig. 1) which restrains diffusion of the isotope from the center compartment to the lateral ones, thus keeping the segments of the axon beyond the porous region free of isotope. Furthermore, the lateral compartments were kept at infinite dilution by an inflow-outflow system which constantly removed the fluid bathing the axon in the end regions. The procedure used for inserting and positioning the dialysis porous capillary into the axon as well as for opening the plastic dialysis capillary has been described previously (DiPolo, 1977). After the porous region was properly positioned, the axon was lowered into the central slot. A glass plate which covers the axons converted the center compartment into a watertight channel (see Fig. 1). Pressure differences between the two lateral regions will tend to dilute the central compartment. This was avoided by keeping the level of the external medium well above the lateral compartments.

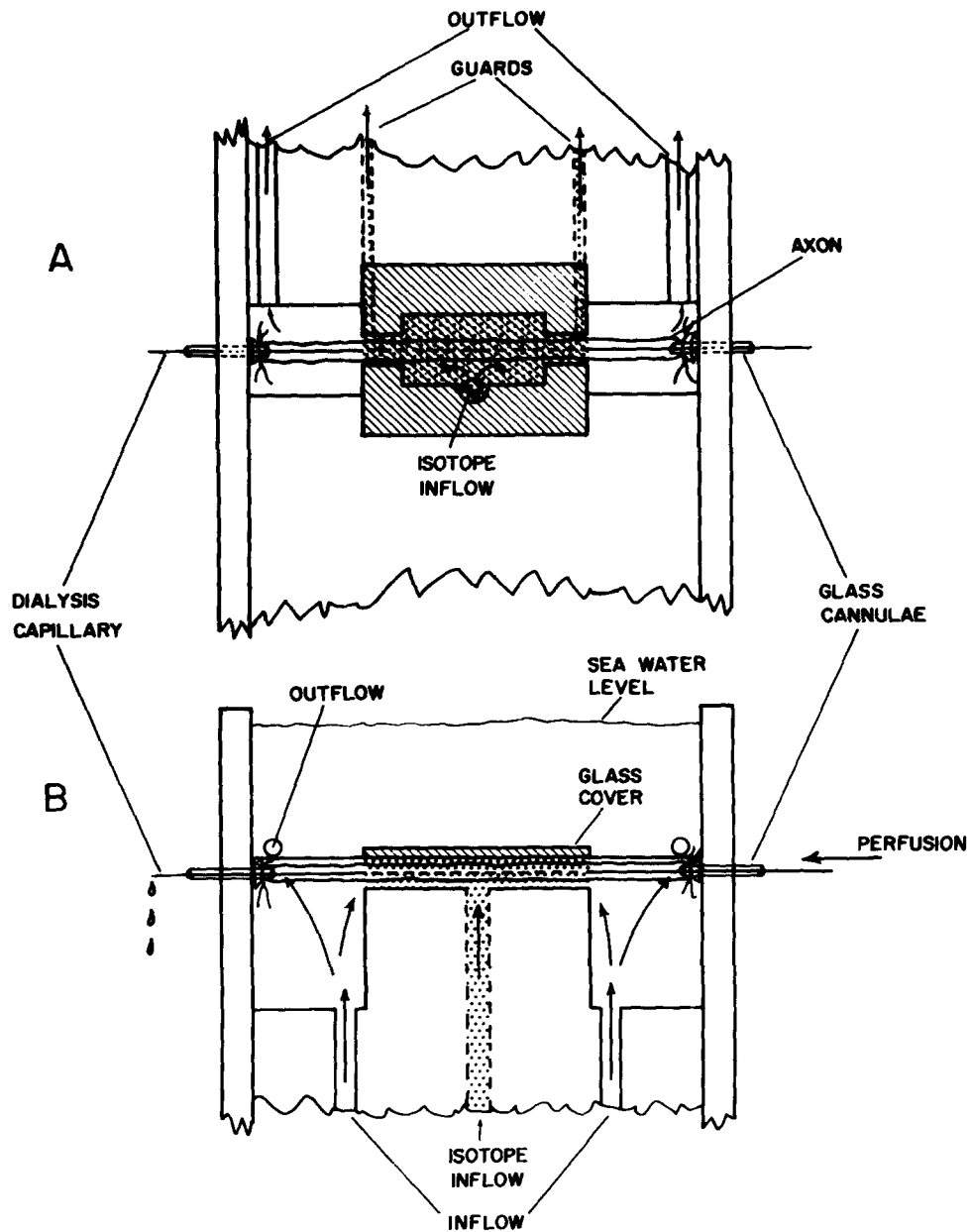

FIGURE 1. Diagrammatic view of the experimental apparatus. (A) Top view; (B) cross section through the middle of the central slot. The chamber is not drawn to scale and is meant primarily to illustrate the positions of the axon, porous capillary, and chamber compartments. The narrow regions of the chamber in the top view are the "guards" regions. The isotope entering the central compartment (black dots) exited through the guards outflows. The lateral compartments were kept at infinite dilution by the inflow-outflow system (see Methods).

The fluid bathing the axon in the center compartment was replaced by one containing radioactive isotope using a variable syringe pump. The rate of external isotope perfusion was adjusted first rapidly (1.2 ml/min) to obtain a good mixing, and then slowly (2.3 ml/h) throughout the experiment. The guard systems were adjusted so as to remove all of the isotope entering the center compartment. The existence of a boundary between the center compartment and the lateral ones could be easily visualized by the addition of phenol red (0.5 mM) to the radioactive medium. The solution bathing the end regions of the axon was constantly removed by the inflow-outflow system at rate of about 0.750 ml/min. In order to check that no isotope was leaking to the end regions of the axon, samples of the lateral compartments were taken during the course of an experiment. No significant amounts of radioactivity were detected after many hours of dialysis. Ca influx was measured by collecting samples of the dialysis fluid at regular intervals of time. A sample was usually taken every 7 min and its radioactive content was measured in a liquid scintillation counter (Packard Instrument Co., Inc., Downers Grove, Ill.).

TABLE I
COMPOSITION OF SOLUTIONS

Substance	Medium				
	External		Internal		
	ASW	0 Na-SW	Standard*	Standard-0 Na	Standard-110 Na
			<i>mM</i>		
Potassium	10	10	320	320	320
Sodium	442	0	70	0	110
Choline	-	442	-	70	0
Magnesium	53	53	5	5	5
Calcium	10	10	‡	‡	‡
Chloride	583	583	90	90	130
Aspartate	-	-	320	320	320
Tris	10	10	10	10	10
Glycine	-	-	160	160	80
pH	7.6	7.6	7.2	7.2	7.2

* KCN (1 mM), iodoacetamide (1 mM), and oligomycin (10 μ g/ml) were always added to the artificial sea water (ASW).

‡ Tris-EGTA (0.5-1 mM) was used to buffer the internal calcium.

The effectiveness of this method in preventing the build-up of isotope in regions not being dialyzed can be clearly observed in Fig. 3. At the end of the experiment the external radioactive medium was changed to an isotope-free artificial seawater (ASW). It can be observed that the counts collected by the dialysis capillary fall to very low levels in ~30-40 min. A different finding is obtained if significant amounts of ^{45}Ca are present in the end regions of the axon; in this case, withdrawal of the external isotope solution produces a very slow drop in the radioactivity collected by the dialysis capillary (Brinley et al., 1975). During the course of the influx experiments the excitability of the axon was checked with an extracellular recording system. All axons were excitable at the end of the experiment.

Solutions

The solutions are given in Table I. The osmolarity of all solutions used was determined using a commercial psychrometer (Wescor Inc., Logan, Utah). External solutions were adjusted to 1,000 mosM/kg and the internal solutions to 980 mosM/kg. The calcium

contamination in the dialysis medium was checked by atomic absorption spectrophotometry. The ionized Ca concentration in the dialysis medium was adjusted by the use of a Ca-EGTA/EGTA buffer system. The apparent dissociation constant for the CaEGTA complex was chosen as $0.15 \mu\text{M}$ (DiPoLo et al., 1976). Radioactive solutions were made by adding solid $^{45}\text{Ca Cl}_2$ (10–20 mCi/mg, New England Nuclear, Boston, Mass.) directly to the external medium. The biochemical reagents used in this work were purchased from Sigma Chemical Co. (St. Louis, Mo.). The FCCP used was a generous gift of Dr. A. Scarpa.

Calculations

Influx was calculated according to the following formula:

$$M_i (\text{pmol} \cdot \text{cm}^{-2} \cdot \text{s}^{-1}) = \frac{\text{Counts per minute collected in the perfusate}}{(\text{Specific activity of soak solution}) (\text{surface area}) (\text{time})} \quad (1)$$

The equation for the kinetic model (Eq. 5, see Discussion) was fitted to the data by means of a simplex search procedure as suggested by Nelder and Mead (1965). The listing of the algorithm in Fortran IV was kindly provided by M. Johnston (Duke Univ.) and was modified to minimize the deviations between the theoretical (V_{theor}) and experimental (V_{exp}) values:

$$S_i = \sum | \text{exp} - \text{theor} | \quad (2)$$

Calculation was carried on by changing the set of parameters until the error:

$$E = \left| \frac{S_{i+1} - S_i}{S_i} \right| \leq 10^{-5} \quad (3)$$

RESULTS

In evaluating the Ca influx data obtained with internal dialysis, the following criteria for a satisfactory experiment were considered important: (a) All the calcium entering the fiber in the dialyzed segment of the axon must be collected by the dialysis fluid. As will be shown later, in order to satisfy this condition, it was necessary to neutralize the Ca buffering system normally existing in the axoplasm. This can be accomplished experimentally by adding an exogenous Ca buffer system (CaEGTA/EGTA) to the dialysis medium. (b) The Ca influx should be stable over long periods of time. (c) Under physiological conditions, the magnitude of the Ca influx should be within the values obtained in intact axons. (d) There should be evidence that the Ca influx is sensitive to changes in Na_i and (or) Na_o , inasmuch as this has been shown to occur in intact axons (Baker et al., 1969).

Stability and Magnitude of the Ca Influx in Dialyzed Axons

Some idea of the stability of the Ca influx experiments may be obtained by inspection of Fig. 2. The steady-state Ca influx obtained during the first hour of internal dialysis is not significantly different from that measured after the fiber has been subjected to several experimental modifications. The absence of a significant rise in the Ca influx level during many hours of dialysis is indicative that the radioactive calcium collected by the perfusate enters the axon through the central dialyzed region and not as a consequence of longitudinal diffusion

from the deteriorated end regions of the axon. Another strong argument in favor of this interpretation is the fact that, when the external radioactive medium bathing the axon is replaced by a non-radioactive one, the counts collected in the perfusate drop promptly to very low values (see Fig. 3).

The collected results of Ca influx under different experimental conditions are shown in Table II. The mean resting calcium influx from 12 squid axons, bathed in radioactive ASW containing 10 mM Ca_o at 19°C and dialyzed with 0.066 μ M free ionized calcium, 1 mM ATP, and 70 mM Na_i , was 0.14 ± 0.012 $\text{pmol}\cdot\text{cm}^{-2}\cdot\text{s}^{-1}$.

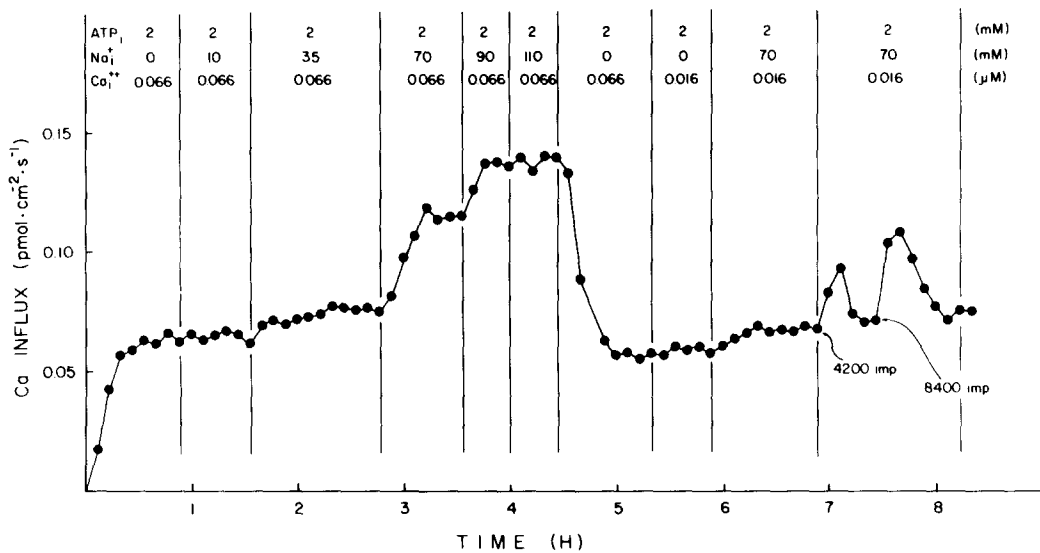

FIGURE 2. The effect of Na_i on the Ca influx at two different $[Ca^{++}]_i$. Ordinate: calcium influx in $\text{pmol}\cdot\text{cm}^{-2}\cdot\text{s}^{-1}$. Abscissa: time in hours. The axon was dialyzed from the beginning with a solution containing 0 Na_i and 1 mM ATP. Notice that removal of Na_i from the dialysis medium drops the Ca influx to the same base line obtained at the beginning of the experiment. The activating effect of Na_i at low $[Ca^{++}]_i$ (0.016 μ M) is substantially reduced. At the end of the experiment the axon was stimulated at 10 and 20 impulses/s, for 7 min. $[Ca]_o = 10$ mM; Total [EGTA] = 1 mM. Imp, impulses.

In order to compare the magnitude of the Ca influx observed in dialyzed axons with those measured in intact axons, few Ca uptake experiments were carried out by soaking fresh intact axons in radioactive 10 mM Ca ASW. Ca influx from four intact axons averages $0.1 \text{ pmol}\cdot\text{cm}^{-2}\cdot\text{s}^{-1}$ in agreement with our value obtained in dialyzed axons and with those reported by Hodgkin and Keynes (1957) and Baker et al. (1969) in intact axons. An even better agreement between the Ca influx measured in dialyzed and intact axons can be obtained if the Ca influx is referred to an internal $[Na]_i$ closer to the physiological value ($[Na]_i = 30\text{--}40$ mM; Caldwell and Requena, 1977). In this range of $[Na]_i$, the Ca

TABLE II
THE EFFECT OF ATP, Na⁺ AND CA²⁺ ON Ca INFLUX

Exp. No.	[Ca ²⁺] _i , μM	0 ATP				ATP			
		Na _i , Ca _i	Na _o , 0 Ca _i	0 Na _o , Ca _i	0 Na _o , 0 Ca _i	Na _i , Ca _i	Na _o , 0 Ca _i	0 Na _o , Ca _i	0 Na _o , 0 Ca _i
5477	0.066	0.070	—	0.066	—	0.12	—	—	—
4373	—	—	—	—	0.11	0.086	—	—	—
4277	—	—	—	0.075	0.18	—	—	—	—
4177	—	0.090	—	0.092	—	—	—	—	0.089
41A77	—	0.091	—	—	0.15	—	—	—	—
4077	—	—	—	—	0.14	—	—	0.080	0.071
3977	—	—	—	—	0.17	—	—	0.087	0.086
3877	—	0.090	—	—	0.16	—	—	0.098	—
3777	—	0.082	—	0.084	—	—	—	—	—
37A77	—	—	0.075	—	0.12	0.075	—	—	—
3677	—	0.078	—	—	0.10	—	—	—	—
3577	—	—	—	—	0.12	—	0.077	—	—
35A77	—	—	—	0.069	0.14	0.069	—	—	—
3477	—	0.090	—	0.092	—	—	—	0.089	—
3077	—	0.087	—	—	—	—	—	0.095	—
3177	—	—	—	0.094	0.092	0.094	—	—	—
43A77	0.6	0.076	—	—	0.28	—	—	—	—
43B77	0.6	0.093	—	—	0.32	—	—	—	—
40A77	0.6	—	—	0.075	—	—	0.076	—	—
40B77	0.6	—	—	0.078	—	—	0.078	—	—
4677	0.3	0.075	—	—	0.22	—	—	—	—
4777	0.3	0.073	—	—	0.19	—	—	0.069	—
46A77	0.8	—	—	—	0.34	—	—	—	—
4877	0.8	—	—	—	0.36	—	—	0.070	—
48A77	0.8	—	—	—	0.35	—	—	0.098	—
		0.085±0.077	0.084±0.008	0.080±0.013	0.082 ± 0.01	0.14±0.012*	0.079±0.01	0.087±0.008	0.082±0.096

In all the experiments the internal ionized calcium was buffered with [EDTA] (0.5-1 mM). All Ca influx measurements were made at [Ca]_o = 10 mM. The values at the bottom of the table represent the mean ± SEM. The [Na]_i was set at 70 mM.

* Value obtained at [Ca²⁺]_i = 0.066 μM.

influx measured in dialyzed axons amounts to $\sim 0.095 \text{ pmol}\cdot\text{cm}^{-2}\cdot\text{s}^{-1}$ (see Fig. 4 and Table II).

Although a systematic study of the Ca influx dependency on external calcium was not explored in this work, some measurements were made at different external Ca concentrations. In good agreement with previous work (Hodgkin and Keynes, 1957), it was found that in the range from 3 to 15 mM Ca_o , Ca influx was linear with external Ca concentration.

Effect of Na_i^+ on Ca Influx

Previous studies (Baker et al., 1969) have shown that Ca influx is directly dependent on Na_i^+ . The dialysis technique provides a convenient way of adjusting the Na_i to any desired value and thus allows one to study the dependence of Ca influx on Na_i . The sodium concentration in the dialysis medium was adjusted by substituting sodium for choline or Tris in the perfusion medium. The usual experiment consisted in obtaining a base line of Ca influx in the absence of internal sodium. A change to a sodium containing fluid was then made and another base line obtained. Experiments of this sort are shown in Figs. 2 and 3. The axon of Fig. 2 was dialyzed from the beginning with a solution containing 1 mM ATP, $0.066 \mu\text{M}$ ionized calcium (total EGTA = 1 mM) in which sodium ions were substituted by choline. After the Ca influx had reached a steady-state value (in this case $0.072 \text{ pmol}\cdot\text{cm}^{-2}\cdot\text{s}^{-1}$), addition of increasing amounts of sodium to the dialysis fluid caused sequential increases in the Ca influx to stable values. At 90 mM Na_i , Ca influx was close to saturation. The reversibility of this effect is clearly observed in this figure, because removal of sodium from the dialysis solutions brought the Ca influx to a value similar to that obtained at the beginning of the experiment. Fig. 2 also shows that under conditions of low internal ionized calcium ($0.016 \mu\text{M}$, total EGTA = 1 mM) the calcium influx is much less sensitive to changes in the internal sodium concentration. Raising the Na_i from 0 to 70 mM causes only a small increment in the Ca influx.

It has been suggested from Ca efflux experiments that the stoichiometry of the Na/Ca exchange might not be fixed at a particular value but instead might change with the internal $[\text{Ca}^{++}]_i$ (Mullins and Brinley, 1975). Fig. 3 shows an experiment in which the effect of internal sodium on the Ca influx was explored in an axon dialyzed with a much higher $[\text{Ca}^{++}]_i$ ($0.8 \mu\text{M}$, total EGTA = 1 mM). In contrast with the finding at low $[\text{Ca}^{++}]_i$ (Fig. 2), the sensitivity of the Ca influx to changes in the internal sodium is considerably greater. Fig. 4 summarizes the results obtained with four different axons in which the Ca influx dependency on internal sodium was explored at two different internal ionized calcium concentrations (0.06 and $0.8 \mu\text{M}$, total EGTA = 1 mM). It is evident that the activation of the Ca influx by internal sodium is markedly affected by changes in the ionized calcium concentration. At low internal calcium ($0.06 \mu\text{M}$) the relationship between Ca influx and internal sodium is a sigmoid, with a very flat foot near the origin and a steeply sloping region. At a higher internal calcium concentration ($0.8 \mu\text{M}$), the activation curve occurs along a section of a Michaelis-Menten equation ($n = 2$).

The broken lines through the points represents the best theoretical curves, using the independent site model outlined in the discussion section. The curve at the right of Fig. 4 was drawn using a modified Michaelis-Menten equation (Eadie-Haldane) assuming a square relationship between $[Na]_i$ and Ca influx at high $[Ca^{++}]_i$ ($0.8 \mu M$).

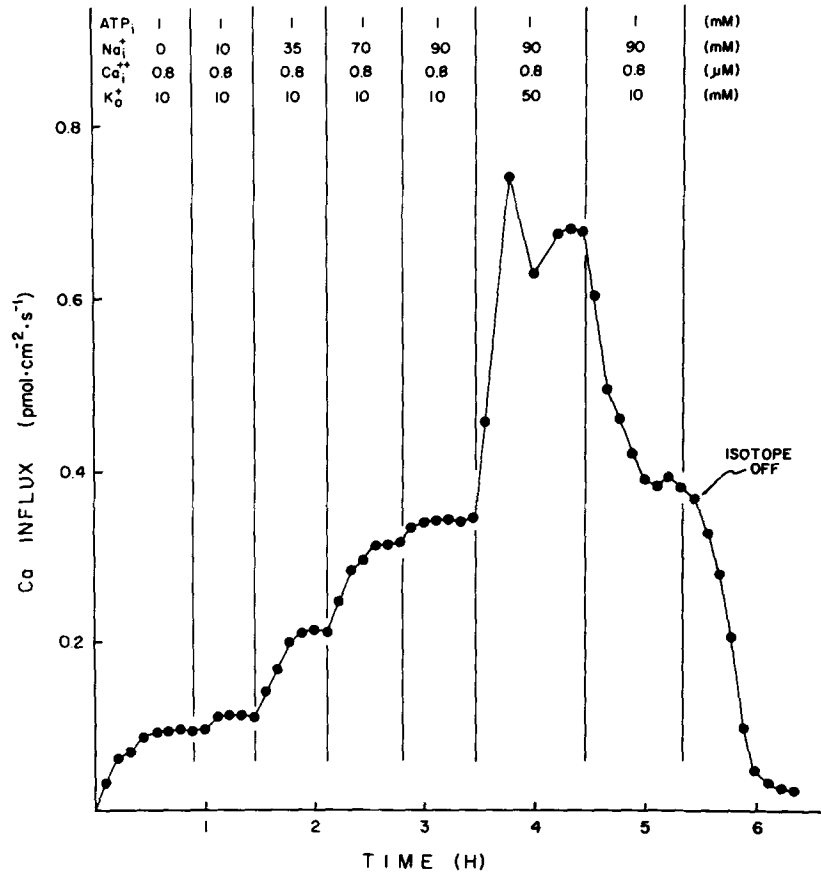

FIGURE 3. The effect of Na_i^+ on the Ca influx at high $[Ca^{++}]_i$ ($0.8 \mu M$). Ordinate: calcium influx in $pmol \cdot cm^{-2} \cdot s^{-1}$. Abscissa: time in hours. After the Ca influx has reached a saturating value at 90 mM Na_i , the axon was exposed to artificial seawater containing 50 mM K_o . At the end of the experiment the external isotope solution was removed from the axon. Total $[EGTA]_i = 1 mM$; $[Ca]_o = 10 mM$. $T = 19^\circ C$, axon diameter: $440 \mu m$.

Dependence of the Ca Influx on Internal Calcium

In the experiments described above, it has been shown that $[Ca^{++}]_i$ modulates the sensitivity of the inward Ca transporting system to Na_i . In order to further characterize the influence of $[Ca^{++}]_i$ on the Ca influx, we have explored the

effect of different concentrations of internal ionized calcium on the Ca influx. The fiber used in the experiment depicted in Fig. 5 was treated from the beginning with a solution containing nominally 0 $[Ca^{++}]_i$ obtained by addition of 1 mM total EGTA to the internal medium. After the Ca influx had reached a stable level in the presence of internal sodium and ATP ($0.075 \text{ pmol}\cdot\text{cm}^{-2}\cdot\text{s}^{-1}$),

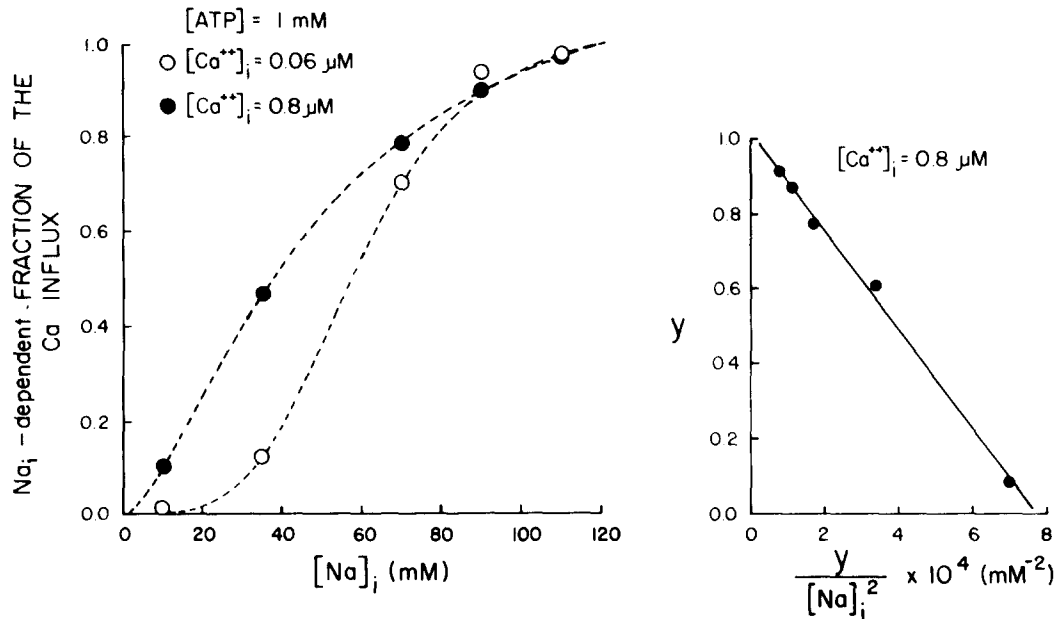

FIGURE 4. The activation of Ca influx by Na_i at two different $[Ca^{++}]_i$. The data represents the mean values from four axons, including those of Figs. 2 and 3. The axons were internally dialyzed with a solution containing 1 mM ATP. Ordinate: Ca influx in $\text{pmol}\cdot\text{cm}^{-2}\cdot\text{s}^{-1}$. Abscissa: internal sodium concentration in millimolar (○) Na_i -dependent Ca influx in the presence of $0.06 \mu\text{M } Ca^{++}$, (●), Na_i -dependent Ca influx at $0.8 \mu\text{M } Ca^{++}$. The curves through the points were drawn to fit Eq. 5 (see Discussion). Using a $K_{Ca} = 0.6 \mu\text{M}$ (see Fig. 7), the optimization procedure (see Methods) gives values of $K_{Na} = 60 \text{ mM}$, $K_{ATP} = 0.17 \text{ mM}$, and $n=4$ at $0.06 \mu\text{M } Ca^{++}$. At $0.8 \mu\text{M } Ca^{++}$ the values were: $K_{Na} = 50 \text{ mM}$, $K_{ATP} = 0.14 \text{ mM}$, and $n = 2$. On the right of the figure the Na_i -dependent Ca influx at high $[Ca^{++}]_i$ ($0.8 \mu\text{M}$) is plotted using the Eadie-Haldane transformation with $n = 2$. $Y = V/V_{max}$, where V is the Na_i -dependent Ca influx at any $[Na]_i$, and V_{max} the maximal Na_i -dependent Ca influx. All the experiments were performed with $[Ca]_o = 10 \text{ mM}$ and $[EGTA]_{total} = 1 \text{ mM}$.

the dialysis medium was changed sequentially to solutions containing 0.066 and $0.6 \mu\text{M}$ ionized calcium. This caused respective increases in the Ca influx to new steady-state values of ~ 0.12 and $0.28 \text{ pmol}\cdot\text{cm}^{-2}\cdot\text{s}^{-1}$. An interesting observation shown in Fig. 5 is that after removing the internal sodium from the dialysis fluid, the Ca influx dropped to approximately the same base line observed in

the absence of $[Ca^{++}]_i$. Fig. 6 summarizes the results of several experiments similar to that of Fig. 5 in which the Na_i -dependent Ca influx is plotted vs. the internal ionized calcium. The curve shows that, at $[Ca^{++}]_i < 0.04 \mu M$, there is not appreciable Na_i -dependent Ca influx. Increasing the internal ionized calcium induces an important activation of the Na_i -dependent Ca influx showing no conclusive signs of saturation up to $0.8 \mu M$ ionized calcium. An interesting observation shown in Fig. 7 and Table II is the absence of any significant stimulating effect of internal calcium on Ca influx in the absence of internal sodium. This figure shows that increasing the ionized calcium concentration from 0 to $0.6 \mu M$ $[Ca^{++}]_i$ fails to induce any increment in Ca influx in the absence of internal sodium. The foregoing observations support the idea that

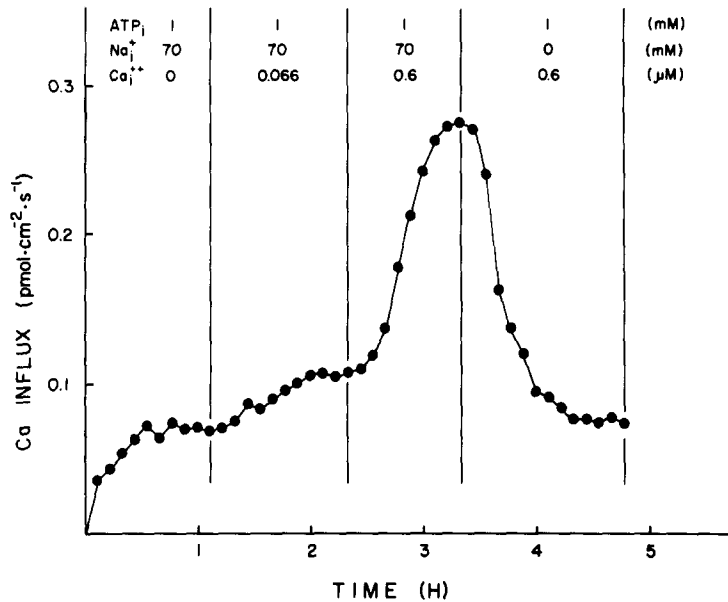

FIGURE 5. The effect of $[Ca^{++}]_i$ on the Ca influx. Ordinate: Ca influx in $pmol \cdot cm^{-2} \cdot s^{-1}$. Abscissa: time in hours. Notice that the activation of the Ca influx by $[Ca^{++}]_i$ is completely abolished by the removal of internal sodium ions from the dialysis medium. $[Ca]_o = 10 \text{ mM}$, $T = 18.5^\circ C$.

some critical internal ionized calcium is needed for the Na_i -dependent Ca influx to occur. The possibility that the activating effect of $[Ca^{++}]_i$ on Ca influx could be due to Ca ions exchanging with ^{45}Ca presumably bound in the axoplasm can be ruled out on the following grounds: the activating effect of $[Ca^{++}]_i$ on Ca influx is only observed in the presence of both Na_i and ATP. This is shown in Table II, in which raising the $[Ca^{++}]_i$ in the absence of ATP and Na_i fails to increase the Ca influx, indicating that the Ca_i -dependent Ca influx occurs through the Na - Ca exchange mechanism. Moreover, raising the buffer capacity of the (CaEGTA-EGTA) system by increases in the total (CaEGTA) at a constant ionized Ca_i fails to induce any further increase in Ca influx (see Fig. 11).

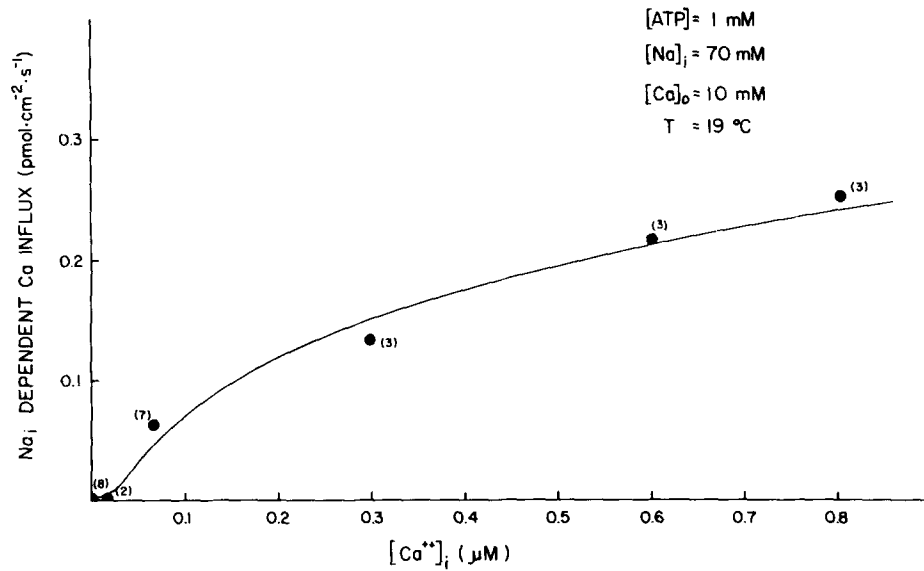

FIGURE 6. The activating effect of internal calcium on the Na_i -dependent Ca influx. Ordinate: mean Na_i -dependent Ca influx in $\text{pmol}\cdot\text{cm}^{-2}\cdot\text{s}^{-1}$. Abscissa: internal ionized calcium in micromolar. The numbers against the points represent different experiments. All the axons were dialyzed with an internal medium containing 1 mM ATP and 70 mM Na_i . $[\text{Ca}]_o = 10$ mM, total $[\text{EGTA}] = 0.5\text{--}1$ mM.

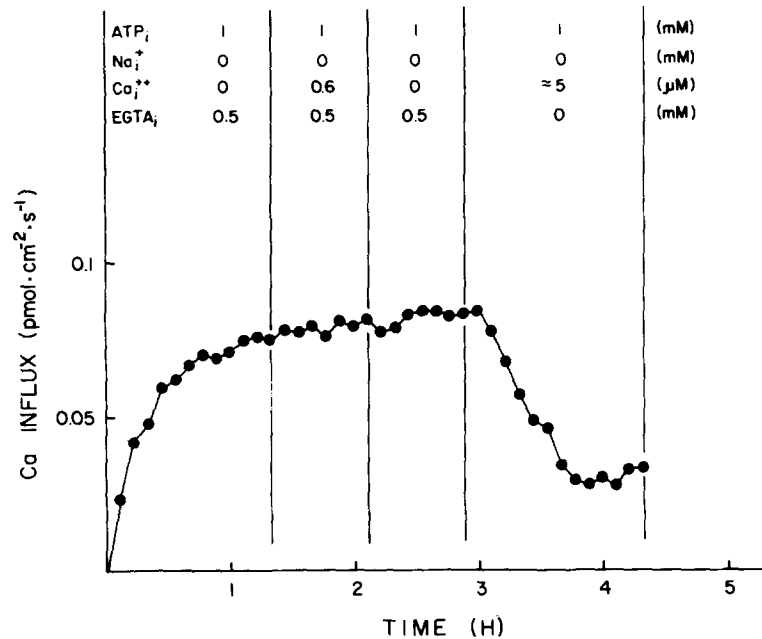

FIGURE 7. The effect of internal $[\text{Ca}^{2+}]_i$ in the absence of internal sodium. The axon was dialyzed throughout the experiment with a solution containing 1 mM ATP. Ordinate: Ca influx in $\text{pmol}\cdot\text{cm}^{-2}\cdot\text{s}^{-1}$. Abscissa: time in hours. Removal of the Ca buffer system (EGTA) from the dialysis medium drops the Ca influx substantially. The external radioactive medium contained 10 mM Ca. Axon diameter: $495\ \mu\text{m}$.

The Effect of Na_o on Ca Influx

Previous work with intact axons has shown that reducing the Na in the seawater increases the Ca influx (Baker et al., 1969). Experiments were performed to test whether under dialysis conditions Ca influx is influenced by changes in the external sodium concentration. Fig. 8 shows the results of a representative experiment of this sort. The axon was first dialyzed with a solution containing no ATP, $[Ca^{++}]_i$ 0.066 μ M, and $[Na]_i$ 70 mM. After the Ca influx had reached a steady-state value (0.087 $\text{pmol}\cdot\text{cm}^{-2}\cdot\text{s}^{-1}$), substitution of all the external sodium for choline causes no significant increment in the Ca influx. However, subsequent addition of 1 mM ATP to the dialysis medium increased the Ca influx to

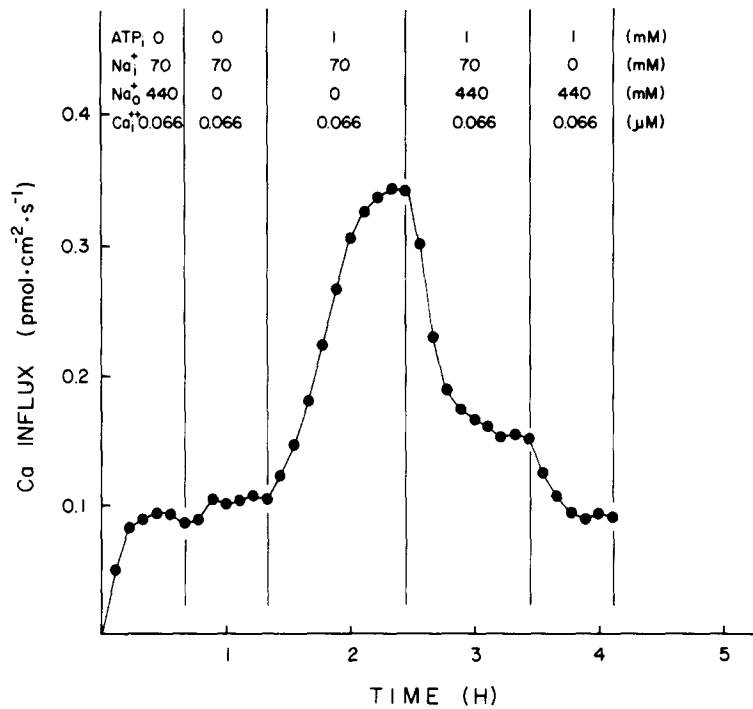

FIGURE 8. The effect of removing Na_o on the Ca influx from axons dialyzed without and with ATP. Ordinate: Ca influx in $\text{pmol}\cdot\text{cm}^{-2}\cdot\text{s}^{-1}$. Abscissa: time in hours. Notice that the removal of Na_o does not increase significantly the Ca influx in the absence of internal ATP.

$\sim 0.35 \text{ pmol}\cdot\text{cm}^{-2}\cdot\text{s}^{-1}$. Restoration to normal external sodium causes the Ca influx to fall to a new steady value of $0.14 \text{ pmol}\cdot\text{cm}^{-2}\cdot\text{s}^{-1}$, and finally, removal of the internal sodium from the dialysis medium brings the Ca influx to the same value observed initially in the absence of ATP. Experiments similar to the one already described indicate that in the range of internal ionized calcium concentrations between 0.06 and 0.1, the average increase in Ca influx for axons bathed in Na-free seawater was 3.5-fold ($n = 3$). This value is significantly lower than that found in intact axons (Baker et al., 1969). A possible explanation for this discrepancy is that the large increase in internal Ca observed in Na-free

solutions (2,400 $\mu\text{M}/\text{h}$, e.g., Requena et al., 1977) cannot be buffered by the amount of EGTA used in the present experiments. This situation would lead to an accumulation of calcium by the nonmitochondrial Ca buffering systems normally present in the axoplasm (Brinley et al., 1977).

The Effect of Membrane Potential on the Ca Influx

Ca influx in squid axons is known to be sensitive to membrane potential (Hodgkin and Keynes, 1957). Because the Na/Ca exchange is affected by changes in the membrane potential (Mullins and Brinley, 1975), we have explored the effect of membrane depolarization on the component of the Ca influx that depends on internal Na^+ , Ca^{++} and ATP. Fig. 3 shows that in the presence of internal ATP, $[\text{Ca}^{++}]_i$ equal to 0.8 μM , and $[\text{Na}]_i$ equal to 90 mM, depolarization of the membrane by external potassium causes an increase in the Ca influx from 0.35 to ~ 0.7 $\text{pmol}\cdot\text{cm}^{-2}\cdot\text{s}^{-1}$. In this and other similar experiments the effect was always found to be reversible upon removal of K^+ from the external medium. Fig. 9 illustrates an experiment in which the effect of raising the external potassium concentration was explored on the component of the Ca influx which is independent of ATP, Ca_i^{++} and Na_i^+ . It can be observed that

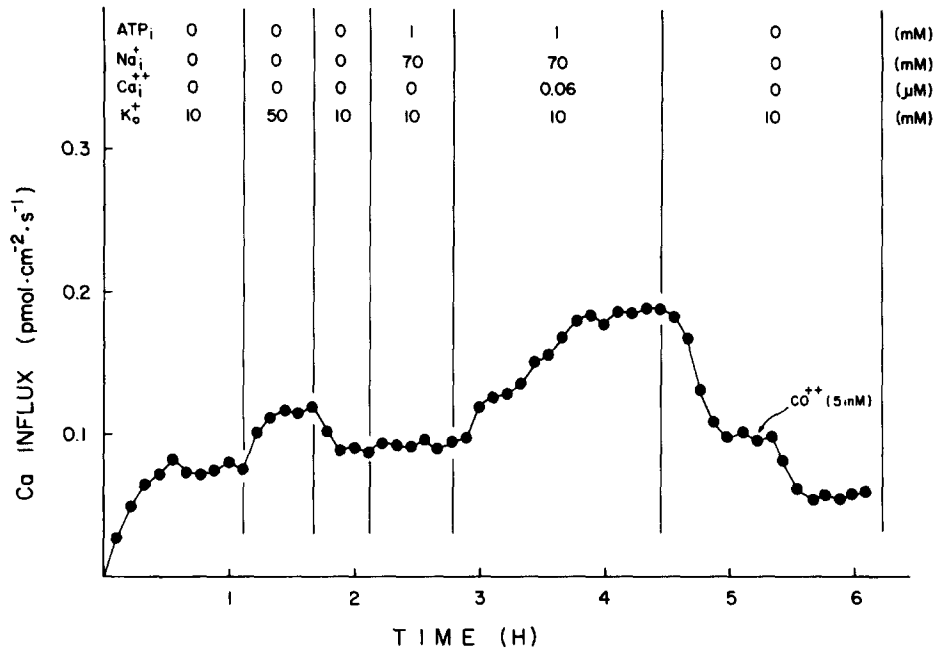

FIGURE 9. The effect of high $[\text{K}]_o$ and external cobalt ions on the Na_i , Ca_i , and ATP-independent Ca influx. Ordinate: Ca influx in $\text{pmol}\cdot\text{cm}^{-2}\cdot\text{s}^{-1}$. Abscissa: time in hours. The Na_i , Ca_i , and ATP-independent fraction of the Ca influx (Ca influx "leak") is sensitive to membrane potential and partially blocked by Co^{++} . The experiment also shows the loss of the activating effect of $[\text{Ca}^{++}]_i$ in the nominal absence of Na_i and ATP. Total $[\text{EGTA}]_i = 1$ mM, $[\text{Ca}]_o = 10$ mM. Axon diameter: 450 μm .

raising the K_o^+ from 10 mM to 50 mM causes an increase in the Ca influx from 0.07 to $\sim 0.12 \text{ pmol}\cdot\text{cm}^{-2}\cdot\text{s}^{-1}$ which can be reversed by decreasing the K_o^+ to the original value. Interestingly, addition of 5 mM CoCl_2 to the external medium dropped the $\text{Na}_i\text{-Ca}_i\text{-ATP}$ -independent component of the Ca influx to about half of its original value.

The Effect of ATP on Ca Influx

The inhibition of the calcium-dependent sodium efflux observed in injected-poisoned nerve fibers (Baker et al., 1969) and in axons in which all the ATP had been removed by dialysis (Brinley et al., 1975) suggests that the Na_i -dependent Ca entrance into squid axons might depend on ATP.

In order to examine whether Ca influx is affected by the intracellular levels of ATP, nerve fibers were first incubated for 1 h in ASW containing CN^- and later dialyzed with a medium free of ATP. This procedure is sufficient to remove most of the ATP present in the fiber (Brinley and Mullins, 1967). Data from a representative experiment are illustrated in Fig. 10. It is clear that addition of 1 mM ATP to an ATP-depleted fiber increases the Ca influx from a base line of $0.09 \text{ pmol}\cdot\text{cm}^{-2}\cdot\text{s}^{-1}$ to a new steady-state value of $\sim 0.18 \text{ pmol}\cdot\text{cm}^{-2}\cdot\text{s}^{-1}$. Under

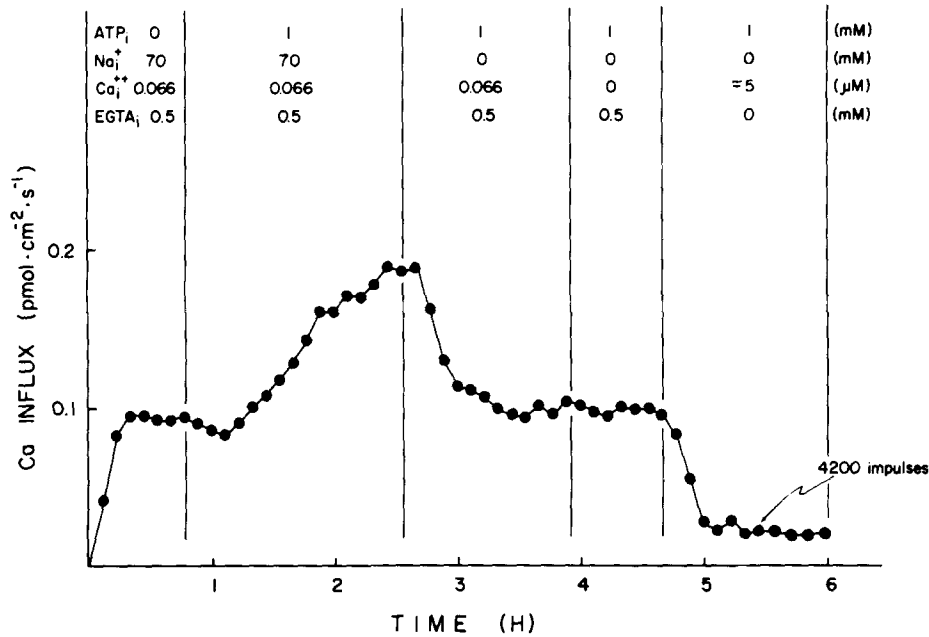

FIGURE 10. The effect of ATP on the Ca influx from a dialyzed squid axon. Ordinate: Ca influx in $\text{pmol}\cdot\text{cm}^{-2}\cdot\text{s}^{-1}$. Abscissa: time in hours. In order to lower the ATP content before the beginning of the dialysis, the axon was incubated for 1 h in ASW containing 1 mM KCN. The activating effect of ATP depends on the presence of Na_i because the removal of Na_i gives the same Ca influx value as that observed in the absence of ATP. Notice that in the absence of Na_i , removal of Ca_i^{2+} does not change the Ca influx. $[\text{Ca}]_o = 10 \text{ mM}$, $T = 19^\circ\text{C}$.

this condition, removal of the internal sodium caused a drop of the Ca influx to the same value observed in the absence of ATP. Subsequent removal of internal ionized calcium from the perfused medium causes no further alteration in the Ca influx level. Data from several other experiments on the effect of ATP on Ca influx are summarized in Table II. Axons dialyzed with $0.066 \mu\text{M}$ ionized calcium, 70 mM Na_i , and no ATP gave a mean calcium influx of $0.085 \pm 0.007 \text{ pmol}\cdot\text{cm}^{-2}\cdot\text{s}^{-1}$ ($n = 8$). Under these conditions ATP increases the calcium influx to a mean value of $0.14 \pm 0.012 \text{ pmol}\cdot\text{cm}^{-2}\cdot\text{s}^{-1}$ ($n = 12$). In an attempt to further characterize the effect of ATP on the Ca influx, the activation of the Ca influx by ATP was explored in axons dialyzed with and without $[\text{Ca}^{++}]_i$. Fig. 9 shows that the addition of ATP and Na_i in the nominal absence of $[\text{Ca}^{++}]_i$ failed to increase the Ca influx. However, subsequent addition of $0.066 \mu\text{M Ca}_i^{++}$ to the dialysis medium induces the usual activation of the Ca influx. Finally, Fig. 9 also shows that the removal of Na_i , Ca_i , and ATP from the dialysis medium dropped the Ca influx to the same base line obtained at the beginning of the experiment. Another noteworthy observation from Table II is that the Ca influx measured in the presence of ATP and in the absence of internal sodium ($0.087 \pm 0.008 \text{ pmol}\cdot\text{cm}^{-2}\cdot\text{s}^{-1}$, $n = 6$) is similar in magnitude to that measured in the absence of ATP and in the presence of internal sodium ($0.085 \pm 0.007 \text{ pmol}\cdot\text{cm}^{-2}\cdot\text{s}^{-1}$). The conclusion from these experiments is that the activation of the Ca influx by internal ATP has an absolute requirement for both internal sodium and calcium.

The Effect of Exogenous Buffers on Ca Influx Measurements

Calcium ions that enter the fiber must diffuse from the surface to the center of the axon before they can be removed by the porous dialysis capillary. The existence of intracellular Ca buffers in the axoplasm can be an important source of error in measuring Ca influx in dialyzed axons. If sequestration takes place along the diffusion path to the capillary, the measured Ca influx will be less than that actually occurring at the surface of the fiber.

Although in all the experiments, FCCP, cyanide, and oligomycin were added to the dialysis medium to inhibit mitochondrial Ca uptake, it is known that axoplasmic Ca binding persists. These nonmetabolic Ca-binding systems are probably related to specific Ca-binding proteins in the axoplasm (Brinley et al., 1977).

We have used two methods to explore whether the presence of nonmitochondrial Ca buffer systems might influence the magnitude of the Ca influx measured in dialyzed axons. The first method consisted in determining the known increment in Ca influx that occurs during electrical stimulation in axons dialyzed with and without a Ca-chelating agent (EGTA). Fig. 2 shows that, in an axon dialyzed with a medium containing a total EGTA of 1 mM and an ionized calcium concentration of $0.016 \mu\text{M}$, repetitive stimulation, first at 10 impulses/s and then at 20 impulses/s for 7 min , induced transient rises in the Ca influx above the base line. This increase in Ca influx can be integrated to obtain the amount of calcium entering the fiber per impulse. In the above experiment and two other similar ones, it was found that if sufficient amounts of free EGTA ($>200 \mu\text{M}$) were included in the dialysis medium, the measured increment in

calcium influx during electrical stimulation was found to be in the range of 0.004–0.01 pmol·cm⁻²·impulse. This value is not significantly different from that obtained in intact axons by Hodgkin and Keynes (1957). These results suggest that all the ⁴⁵Ca entering the fiber is complexed by the chelating agent, diffusing eventually to the dialysis capillary. A different situation occurs in axons in which EGTA has been removed from the dialysis medium. This is best illustrated in Fig. 10 in which repetitive stimulation of the axon at 10 impulses/s for 7 min failed to cause any significant increase in the Ca influx. This implies that the nonmitochondrial Ca buffer systems of the axoplasm must have adsorbed essentially all the calcium entering the fiber. Another observation in favor of this hypothesis is that removal of the EGTA from the perfusion medium caused a fall in the Ca influx to very low values (see Figs. 7 and 10). Moreover, the low levels of calcium influx measured in the absence of internal EGTA remain unchanged even for periods greater than 2 h, suggesting that whatever the Ca buffering capacity of the axoplasm may be, it is far from being saturated under the present experimental conditions.

The second method of exploring whether the presence of intracellular Ca buffer systems might interfere with Ca influx measurement consisted in studying the capacity of the EGTA to buffer all of the ⁴⁵Ca entering the fiber. This can be done, first by altering the ratio [Ca-EGTA] / [free-EGTA] at a constant total [EGTA] of 0.5 mM, and secondly, by changing the total [EGTA] at a constant [CaEGTA] / [free EGTA] ratio. One such experiment is shown in Fig. 11. In the first part of the experiment the axon was dialyzed with a solution containing [Ca⁺⁺]_i = 0.1 μM and a ratio [CaEGTA] / [free EGTA] = 0.66. Under this condition a steady-state Ca influx of ~ 0.095 pmol·cm⁻²·s⁻¹ was obtained. Increasing the [Ca⁺⁺]_i to 0.3 μM at a ratio [CaEGTA] / [free EGTA] = 2, led to a new steady-state Ca influx value of 0.18 pmol·cm⁻²·s⁻¹. Interestingly, raising further the [Ca⁺⁺]_i to 0.8 μM at a ratio [CaEGTA] / [free EGTA] = 5.3, instead of causing the expected increase in the Ca influx, produced a progressive fall to values even lower than those obtained at [Ca⁺⁺]_i = 0.3 μM. When the total [EGTA] was changed from 0.5 to 1 mM at the same [CaEGTA] / [free EGTA] ratio, it was observed that, although the ionized calcium had been kept constant at 0.8 μM, the Ca influx rises to a higher steady value of ~ 0.35 pmol·cm⁻²·s⁻¹. Finally, raising the total [EGTA] to 2 mM, at the same ionized calcium, does not increase the Ca influx further.

These observations suggest that as the exogenous buffering capacity of the dialysis medium to calcium ions is progressively decreased by reducing the free EGTA concentration, the endogenous Ca buffering systems present in the axoplasm sequester part of the ⁴⁵Ca entering the fiber. Our general experience from these experiments is that in the range of ionized calcium concentration from 0.04–0.8 μM, a free [EGTA] >200 μM is sufficient to buffer all of the calcium entering the fiber from sodium sea water.

DISCUSSION

The measurements reported in this paper were made to examine Ca entry in axons subjected to internal solute control. A comparison of the Ca influx values obtained in this work with those reported in intact fibers leads to the conclusion

that the Ca influx from dialyzed axons agrees well with those obtained in intact axons. Hodgkin and Keynes (1957) reported an average Ca influx of $0.16 \text{ pmol}\cdot\text{cm}^{-2}\cdot\text{s}^{-1}$ from 10 Ca ASW in intact axons from *Loligo forbesi*, and Baker et al. (1969) found a value of $0.15 \text{ pmol}\cdot\text{cm}^{-2}\cdot\text{s}^{-1}$ for the Ca influx in the same preparation. In the present work an average Ca influx value of $0.10 \text{ pmol}\cdot\text{cm}^{-2}\cdot\text{s}^{-1}$ has been obtained using intact axons from *Dorytheutis plei* in good agreement with the value of $0.14 \text{ pmol}\cdot\text{cm}^{-2}\cdot\text{s}^{-1}$ obtained in dialyzed axons.

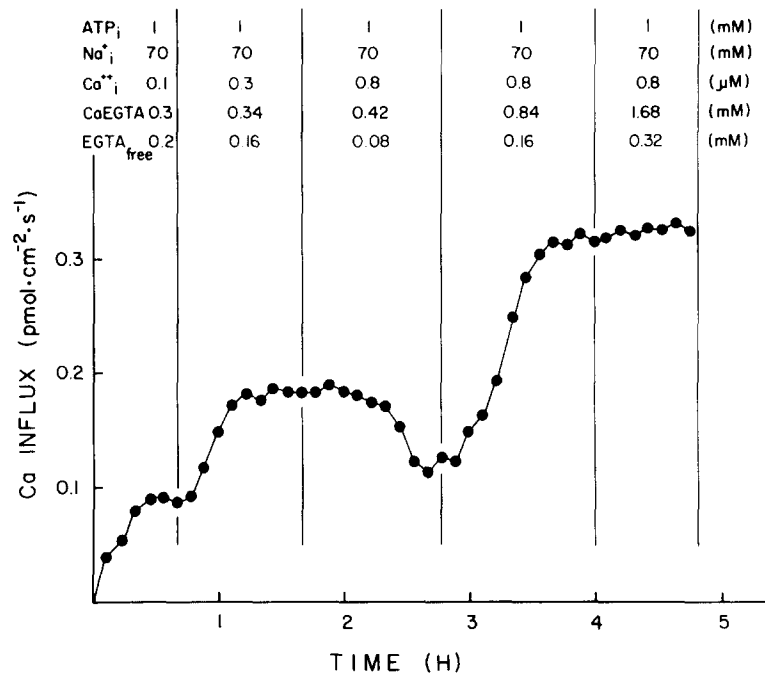

FIGURE 11. The effect of raising the $[\text{Ca}^{++}]_i$ at different CaEGTA/free EGTA ratios. Ordinate: Ca influx in $\text{pmol}\cdot\text{cm}^{-2}\cdot\text{s}^{-1}$. Abscissa: time in hours. The axon was dialyzed initially with a solution containing 1 mM ATP, 70 mM Na⁺, and $0.1 \mu\text{M} [\text{Ca}^{++}]_i$. Notice that as the free [EGTA] in the dialysis medium is reduced from 0.2 mM to 0.08 mM, the level of the Ca influx decreases. Raising the free EGTA to 0.16 mM at a constant ionized $[\text{Ca}]_i$ increases the Ca influx. Observe that an increase in the free [EGTA] to 0.32 mM at a constant $[\text{Ca}^{++}]_i$ does not cause any further rise in the Ca influx. $[\text{Ca}]_o = 10 \text{ mM}$, $T = 18.5^\circ\text{C}$, axon diameter: $475 \mu\text{m}$.

The Components of the Ca Influx

All the observations reported in this paper indicate that the Ca influx from dialyzed squid axons can be separated into two main components: one which is dependent on the presence of both internal sodium and ATP and is activated by internal calcium and the other which persists in the absence of Na⁺, Ca²⁺ and ATP_i, being partially inhibited by $[\text{Co}^{++}]_o$. The striking parallels between the effects of ATP_i and Na_i on the Ca influx (this paper) and on the Ca-dependent

Na efflux observed in injected axons (Baker et al., 1969) suggest that the ATP_r-dependent component of the Ca influx occurs through the Na-Ca exchange mechanism. Two further arguments favor a link between the Na-Ca exchange and the ATP_r-dependent Ca influx: first, the increase in the Ca influx found in the absence of external sodium can only be observed in the presence of ATP_i; and secondly internal ionized calcium in the presence of ATP_i activates both the Na_r-dependent Ca influx and the Ca_o-dependent Na efflux.¹ The detailed analysis of the Ca influx presented in this paper (Table II) indicates that the magnitude of the ATP-dependent Ca influx is affected by the levels of Ca_i⁺⁺ and Na_i⁺. At low ionized calcium (0.066 μM) and with 70 mM Na_i, the ATP_r-dependent Ca influx from 10 Ca_o ASW amounts to about half of the Ca influx; this component increases with increasing Ca_i⁺⁺ and Na_i⁺ (see Table II).

The component of the Ca influx which persists in the absence of ATP_i, [Ca⁺⁺]_i, and [Na]_i (ATP_r-independent component) amounts to about 0.085 pmol·cm⁻²·s⁻¹ from artificial sea water containing 10 mM Ca, and most probably reflects Ca entering the fiber through pathways different from the Na-Ca transport system. In favor of this view is the fact that no Na_r-dependent or Ca_r-dependent Ca influx can be observed in the absence of ATP_i. Moreover, it has been reported (Baker, 1972) that depolarization of crab nerve fiber by K-rich solutions increases the uptake of Ca. This effect is largely independent of the Na content of the nerve. A similar finding is observed in dialyzed axons (Fig. 9) in which depolarization of the membrane with a K-rich solution increases the Ca influx in the absence of ATP_i, [Na]_i, and [Ca⁺⁺]_i.

At present it is not possible to decide whether this ATP-independent component reflects Ca entering through the sodium channels, the late Ca channels, or through some other unknown pathways. However, the voltage sensitivity of this component and its inhibition by [Co⁺⁺]_o ions (see Fig. 9) could indicate that at least some of the Ca influx leaks through the late Ca channels postulated by Baker et al. (1971). It is interesting to point out that under conditions resembling a normal axon ([Ca⁺⁺]_i = 0.06 μM [Na]_i = 30 mM) most of the Ca influx occurs via a passive Ca influx and not through the Na/Ca exchange mechanism (see Fig. 4 and Table II). A previous study on the effect of Ca_o on the [Ca⁺⁺]_i (DiPolo et al., 1976) indicates that an external Ca of 10 mM is unphysiologically high, because it increases the [Ca⁺⁺]_i in resting fibers. Blaustein (1974) has shown that the [Ca] in the squid hemolymph is 7 mM, of which 3 mM is complexed to sulphate, leaving an effective [Ca⁺⁺] of ~4 mM. If we take this value as the physiological [Ca]_o, then Ca influx in a normal fiber should be ~0.038 pmol·cm⁻²·s⁻¹. This argument implies that at physiological [Ca⁺⁺]_i (20–60 nM; DiPolo et al., 1976), flux balance at the plasma membrane must be attained by an outward movement of calcium of ~0.04 pmol·cm⁻²·s⁻¹.

Na_i-Dependent Ca Influx

The simplest explanation for the Na_r-dependent Ca entry observed in squid axons is that it occurs in exchange for internal sodium through the Na-Ca exchange mechanism. An interesting feature of this component is that it requires [ATP] and [Ca⁺⁺]_i. A similar requirement has been found for the Ca_o-

dependent Na efflux in dialyzed squid axons.¹ This suggests that both unidirectional Ca and Na fluxes are manifestations of the same system.

An exchange of more than one Na_i for one Ca_o is expected to lead to a sigmoidal relation between Na_i and Ca influx. Fig. 4 shows that, in the presence of ATP, internal sodium activates the Ca influx along a sigmoidal curve, suggesting that more than one sodium ion is exchanged for each Ca ion that enters the fiber. One of the particular features of the Na_i-dependent Ca influx reported in this paper (see Fig. 4) is the marked change in the shape of the Na_i-activated calcium influx observed at different internal ionized calcium concentrations.

If [Ca⁺⁺]_i changes the kinetics of the Na_i-dependent Ca influx, then it should be possible to show a similar dependency in the curve relating [Ca⁺⁺]_o to Na efflux. Although no such quantitative study exists in the literature, Baker et al. (1969) have shown that Ca_o activates the sodium efflux in lithium sea-water with a half-maximal concentration of ~ 2 mM. With full external sodium the half-maximal concentration in the activation curve increases to 50–100 mM. This change in the kinetics of the Ca_o activation curve could be due to a rise in the [Ca⁺⁺]_i, which is known to occur in Na-deficient solutions (Baker et al., 1967; DiPolo et al., 1976). Other evidence in favor of this hypothesis comes from the observation of Mullins and Brinley (1975) in dialyzed squid axons of a change in the voltage dependency of the Ca efflux at different [Ca⁺⁺]_i, suggesting that the Na/Ca exchange at high [Ca⁺⁺]_i is close to an electroneutral one whereas at low [Ca⁺⁺]_i it is not.

If the kinetics of the Ca_i-activated Na_i-dependent Ca influx observed in the presence of ATP are manifestations of the same system, then it should be possible to build a model which will be compatible with the observed changes in the Na_i-activation curve induced by Ca⁺⁺. Inasmuch as the present data shows that the carrier-mediated Ca influx occurs only in the presence of ATP, Na_i, and Ca_i, any realistic model must contain the binding of these variables to the transporting system. We have explored two possible models, which can describe the experimental data. In the first one, the binding of the substrates to the carrier is sequential, ATP binding first, then Ca_i, and Na_i. In the second one, the binding of the substrates to the carrier is independent of each other, with transport only occurring when the appropriate sites are occupied simultaneously by ATP, Ca_i, and Na_i. For the sequential model, the fractional activation of Ca influx becomes:

$$\frac{V}{V_{\max}} = \frac{1}{\left(\frac{K_{\text{Na}_i}}{[\text{Na}_i]_i}\right)^n \left[\frac{K_{\text{Ca}_i}}{[\text{Ca}_i]} \left(\frac{K_{\text{ATP}}}{[\text{ATP}] + 1} + 1 \right) + 1 \right] + 1} = \frac{1}{\left(\frac{K_{\text{Na}_i}^{\text{app}}}{[\text{Na}_i]_i} + 1\right)}, \quad (4)$$

where K_{Na_i} , K_{Ca_i} , and K_{ATP} are the dissociation constants of the reactions between the carrier and the substrates and n is the molecularity of the sodium-carrier reaction. The sequential model predicts that the apparent dissociation constant for the Na-carrier reaction ($K_{\text{Na}_i}^{\text{app}}$, Eq. 4) is dependent on both [Ca⁺⁺]_i

¹ Beaujé, L., and DiPolo, R. Unpublished results.

and $[ATP]_i$. However, the experimental data shown in Fig. 4 clearly demonstrate that this is not the case because changing the $[Ca^{++}]_i$ more than 10 times does not significantly modify the $K_{Na_i}^{app}$. The variations in $K_{Na_i}^{app}$ observed experimentally (from 50 mM at $0.8 \mu M [Ca^{++}]_i$ to 59 mM at $0.06 \mu M [Ca^{++}]_i$) are well within the error of the measurements. Moreover, attempts to fit the experimental data to the sequential model fail to produce consistent values for the apparent dissociation constant for Na, Ca, and ATP. The calculated values of K_{Na} , K_{Ca} , and K_{ATP} (Eq. 4) when $[Na]_i$ was changed at constant $[Ca^{++}]_i$ were in great variance with the values calculated when $[Ca^{++}]_i$ was varied at constant $[Na]_i$. Because the preceding considerations do not favor this particular sequential model we have considered a nonsequential mechanism to explain the experimental data. In order to build such a model the following assumptions were made:

- (a) The binding of Na_i , Ca_i , and ATP to the carrier are independent random events; the dissociation constants of the reactions between the carrier and the substrates are not dependent on which of the substrates binds first.
- (b) The probability that any of the substrates binds to the carrier (P_{Na} , P_{Ca} , P_{ATP}) is given by the Michaelis-Menten equation.
- (c) Transport occurs only when the carrier is loaded with ATP, Ca_i , and Na_i (active carrier).
- (d) The probability of finding an active carrier complex (P_{ac}) is equal to the combined probability of binding of the substrates to the carrier,

$$P_{ac} = P_{Na} \times P_{Ca} \times P_{ATP}.$$

- (e) Ca influx is linearly proportional to P_{ac} .

$$\text{Influx} \propto P_{ac} = \frac{1}{\left[\left(\frac{K_{Na_i}}{[Na]_i} \right)^n + 1 \right] \left(\frac{K_{Ca_i}}{[Ca]_i} + 1 \right) \left(\frac{K_{ATP}}{[ATP]} + 1 \right)}, \quad (5)$$

where n is the molecularity of the reaction between Na and the carrier. Eq. 2 was used to fit the data following the optimization procedure described in Methods.

The equation predicts:

- (a) Ca influx increases with increasing Na_i , Ca_i , and ATP in agreement with the experimental results.
- (b) At high $[Ca^{++}]_i$ and ATP the fractional activation of the Ca influx is described by a Michaelis-Menten expression for sodium. This is clearly observed in the right panel of Fig. 4 which is an Eadie-Haldane plot of the fractional Na_i -dependent Ca influx as a function of $[Na]_i$. This transformation has the advantage of being linear if the data is described by a Michaelis-Menten equation that deviates markedly from linearity in other cases (Hoffman and Tosteson, 1971).
- (c) The affinity constants are independent of the concentration of the substrates. The left panel of Fig. 4 shows that the $[Na]_i$ which produces half of the maximum flux observed does not change significantly when

$[Ca^{++}]_i$ is changed between 0.06 and 0.8 μM . The broken lines in Fig. 4 were fitted to the data using Eq. 2. Using $K_{Ca} = 0.6 \mu\text{M}$ (Fig. 6) and $K_{ATP} = 0.2 \text{ mM}$ (DiPolo, 1977), the computed values for K_{Na_i} are 50 and 59 mM at 0.06 and 0.8 μM $[Ca^{++}]_i$, respectively. It is interesting to notice that in order to fit the model to the data, the molecularity of the carrier-sodium reaction must be changed from $n = 2$ at low calcium to $n = 4$ at high calcium. This perhaps could be related to changes in the stoichiometry of the Na/Ca exchange at different $[Ca^{++}]_i$.

Ca_i-Dependent Ca influx

Several authors (Blaustein and Hodgkin, 1969; DiPolo, 1973, 1974; Baker and McNaughton, 1976; Blaustein, 1977) have shown that in the presence or in the absence of Na_o , removal of Ca_o , reduces the Ca efflux. This finding has been referred to as Ca-Ca exchange. But, however attractive this hypothesis may be, it is not clear yet whether Ca_o actually exchanges with internal calcium (Ca-Ca exchange) or Ca_o activates the Ca efflux without a real exchange of ions actually taking place.

If the Na/Ca exchange mechanism can work in a conventional Ca-Ca exchange mode, then it should be feasible to show a clear correlation between the inward and outward movements of Ca ions. Although the measurements of Ca influx described in this paper clearly indicates that $[Ca^{++}]_i$ activates the Ca influx thus suggesting a Ca-Ca exchange process, two points remain difficult to explain. First, in the absence or in the presence of ATP_i , no Ca_i -dependent Ca influx is observed in the absence of internal sodium (see Figs. 5 and 7 and Table II) suggesting that $[Ca^{++}]_i$ activates an exchange between Na_i and Ca_o rather than an exchange of Ca_i for Ca_o , and secondly, in axons dialyzed without Na_i in which no Ca influx through the Na/Ca exchange occurs (see Figs. 5 and 7), it is possible to show a Ca_o dependent-Ca efflux (Requena, 1978; DiPolo²).

Perhaps the simplest unifying mechanism for the Ca_o -dependent Ca efflux observed under certain experimental conditions is that Ca_o activates the Ca efflux at an external site rather than exchange with internal calcium.

I am greatly indebted to Dr. C. Sevcik for the development of the kinetic model as well as for many trial computations. I wish to thank C. Caputo and L. Beaugé for fruitful discussions, L. J. Mullins and G. Whitembury for comments on the manuscript, and H. Rojas and P. Bolaños for very helpful technical assistance. The expertise of J. Mora in constructing the influx chamber and of Isabel Otaegui and Margarita Kondracki in preparing the manuscript is acknowledged. Supported by the Consejo Venezolano de Investigaciones Científicas y Tecnológicas (CONICIT), grant 31.26.S1-0602.

Received for publication 18 April 1978.

REFERENCES

1. BAKER, P. F. 1972. Transport and metabolism of calcium ions in nerve. *Prog. Biophys. Mol. Biol.* **24**:177-223.
2. BAKER, P. F., M. P. BLAUSTEIN, A. L. HODGKIN, and R. A. STEINHARDT. 1967. The effect of sodium concentration on calcium movements in giant axons of *Loligo forbesi*. *J. Physiol. (Lond.)*. **192**:43P.

² DiPolo, R. Unpublished results.

3. BAKER, P. F., M. P. BLAUSTEIN, A. L. HODGKIN, and R. A. STEINHARDT. 1969. The influence of calcium on sodium efflux in squid axons. *J. Physiol. (Lond.)*. **200**:431-458.
4. BAKER, P. F., A. L. HODGKIN, and E. B. RIDGWAY. 1971. Depolarization and calcium entry in squid giant axons. *J. Physiol. (Lond.)*. **218**:709-755.
5. BAKER, P. F., and P. A. MCNAUGHTON. 1976. Kinetics and energetics of calcium efflux from intact squid giant axons. *J. Physiol. (Lond.)*. **259**:103-144.
6. BLAUSTEIN, M. P. 1974. The interrelationship between sodium and calcium fluxes across cell membranes. *Rev. Physiol. Biochem. Exp. Pharmacol.* **70**:33-82.
7. BLAUSTEIN, M. P. 1977. Effects of internal and external cations and of ATP on sodium-calcium and calcium-calcium exchange in squid axons. *Biophys. J.* **20**:79-111.
8. BLAUSTEIN, M. P., and A. L. HODGKIN. 1969. The effect of cyanide on the efflux of calcium from squid axons. *J. Physiol. (Lond.)*. **400**:497-527.
9. BLAUSTEIN, M. P., and J. M. RUSSELL. 1975. Sodium-calcium exchange and calcium-calcium exchange in internally dialyzed squid giant axons. *J. Membr. Biol.* **22**:285-312.
10. BRINLEY, F. J., JR., and L. J. MULLINS. 1967. Sodium extrusion by internally dialyzed squid axons. *J. Gen. Physiol.* **50**:2303-2331.
11. BRINLEY, F. J., JR., S. G. SPANGLER, and L. J. MULLINS. 1975. Calcium and EDTA fluxes in dialyzed squid axons. *J. Gen. Physiol.* **66**:223-250.
12. BRINLEY, F. J., JR., T. TIFFERT, A. SCARPA, and L. J. MULLINS. 1977. Intracellular calcium buffering capacity in isolated squid axons. *J. Gen. Physiol.* **70**:355-384.
13. CALDWELL, M., and J. REQUENA. 1977. Regulación iónica en axones del calamar tropical *Dorytheutis plei*. *Acta Cient. Venez.* **28**:72. (Abstr.)
14. DiPOLO, R. 1973. Calcium efflux from internally dialyzed squid axons. *J. Gen. Physiol.* **62**:575-589.
15. DiPOLO, R. 1974. Effect of ATP on the calcium efflux in dialyzed squid axons. *J. Gen. Physiol.* **64**:503-517.
16. DiPOLO, R. 1977. Characterization of the ATP-dependent calcium efflux in dialyzed squid giant axons. *J. Gen. Physiol.* **69**:795-813.
17. DiPOLO, R., J. REQUENA, F. J., BRINLEY, JR., L. J. MULLINS, A. SCARPA, and T. TIFFERT. 1976. Ionized calcium concentrations in squid axons. *J. Gen. Physiol.* **67**:433-467.
18. HODGKIN, A. L., and R. D. KEYNES. 1957. Movements of labelled calcium in squid giant axons. *J. Physiol. (Lond.)*. **138**:253-281.
19. HOFFMAN, P. G., and D. C. TOSTESON. 1971. Active sodium and potassium transport in high potassium and low potassium sheep red cells. *J. Gen. Physiol.* **58**:438-466.
20. MULLINS, L. J., and F. J. BRINLEY, JR. 1975. Sensitivity of calcium efflux from squid axons to changes in membrane potential. *J. Gen. Physiol.* **65**:135-152.
21. NELDER, J. A., and R. MEAD. 1965. A simple method for function minimization. *Comput. J.* **7**:308-313.
22. REQUENA, J. 1978. Calcium efflux from squid axons under constant sodium electrochemical gradient. *J. Gen. Physiol.* **72**:443-470.
23. REQUENA, J., R. DiPOLO, F. J. BRINLEY, JR., and L. J. MULLINS. 1977. The control of ionized calcium in squid axons. *J. Gen. Physiol.* **70**:329-353.