



ERNEST ORLANDO LAWRENCE BERKELEY NATIONAL LABORATORY

Catalog of DC Appliances and Power Systems

Karina Garbesi, Vagelis Vossos, and Hongxia Shen

Contributions: Jonathon Taylor and Gabriel Burch

Energy Analysis Department
Environmental Energy Technologies Division
Lawrence Berkeley National Laboratory
Berkeley, CA 94720

Additional Contributions: Erik Frye

Real Goods Solar

October 2011

This work was supported by the Assistant Secretary for Energy Efficiency and Renewable Energy, Office of Building Technology, State, and Community Programs, of the U.S. Department of Energy under Contract No. DE-AC02-05CH11231.

DISCLAIMER

This document was prepared as an account of work sponsored by the United States Government. While this document is believed to contain correct information, neither the United States Government nor any agency thereof, nor The Regents of the University of California, nor any of their employees, makes any warranty, express or implied, or assumes any legal responsibility for the accuracy, completeness, or usefulness of any information, apparatus, product, or process disclosed, or represents that its use would not infringe privately owned rights. Reference herein to any specific commercial product, process, or service by its trade name, trademark, manufacturer, or otherwise, does not necessarily constitute or imply its endorsement, recommendation, or favoring by the United States Government or any agency thereof, or The Regents of the University of California. The views and opinions of authors expressed herein do not necessarily state or reflect those of the United States Government or any agency thereof or The Regents of the University of California.

Acknowledgements

The authors thank the following people for their significant contributions to this project: Robert Van Buskirk for initiating the Direct-DC Power Systems project and providing vision and encouragement along the way, Tony Lai for input on power conversion technology, and Mary James and Stacy Pratt for editing.

Table of Contents

LIST OF FIGURES	VI
LIST OF TABLES.....	VII
GLOSSARY OF TERMS, ACRONYMS, AND ABBREVIATIONS	VIII
EXECUTIVE SUMMARY	X
1. INTRODUCTION	1
1.1. DC POWER SYSTEMS FOR RESIDENTIAL AND COMMERCIAL BUILDINGS: OVERVIEW	3
2. DC APPLIANCES AND END USES.....	8
2.1. EXISTING DC PRODUCTS FOR OFF-GRID NICHE MARKETS	8
2.1.1 DC Air Conditioners	9
2.1.2 DC Lighting.....	10
2.1.3 DC Refrigeration.....	14
2.1.4 Miscellaneous DC Appliances.....	16
2.2. EMERGING PRODUCTS FOR GRID-CONNECTED HOMES AND BUSINESSES	16
2.2.1 DC Products for Hybrid AC-DC Power Systems.....	17
2.2.2 Electric Vehicles.....	17
2.3. POTENTIAL FUTURE DC PRODUCTS.....	19
2.3.1 DC-Internal Products	19
2.3.2 AC-to-DC Conversion Loss Savings of Appliances Running on Direct DC.....	24
2.3.3 Summary of AC versus DC Product Energy Use.....	29
3. DC POWER SYSTEMS.....	31
3.1. DC ENERGY SUPPLY AND FUEL CELLS	31
3.1.1 PV Modules	31
3.1.2 Wind Turbines	35
3.1.3 Microhydro.....	37
3.1.4 Fuel Cells.....	37
3.2. POWER SYSTEM COMPONENTS.....	38

3.2.1	<i>Grid-Interactive Inverter (AC Building)</i>	38
3.2.2	<i>DC-DC Converter (DC Building)</i>	42
3.2.3	<i>Bi-Directional Inverter (DC Building)</i>	44
3.2.4	<i>MPPT (DC Building)</i>	44
3.2.5	<i>Charge Controller (AC & DC Building)</i>	46
3.2.6	<i>Batteries (AC & DC Building)</i>	47
3.3.	POWER DELIVERY AND INTEGRATION	50
3.3.1	<i>DC Power Distribution Systems</i>	50
3.3.2	<i>Power over Ethernet</i>	51
3.3.3	<i>Universal Serial Bus Wall Outlets</i>	52
3.4.	HOME ENERGY MANAGEMENT SYSTEMS.....	52
4.	CONCLUSIONS	55
	REFERENCES	56
	APPENDIX	61

List of Figures

Figure 1. U.S. annual capacity additions of residential and commercial grid-connected PV in megawatts.	2
Figure 2. Typical AC Power System.	4
Figure 3. Direct-DC Power System.	5
Figure 4. AC Power System with Storage.	6
Figure 5. DC Power System with Storage.	7
Figure 6. Energy efficiency comparison for DC and AC air conditioners.	10
Figure 7. Efficacy comparison for DC and AC CFLs.	11
Figure 8. Efficacy comparison for DC and AC LEDs.	12
Figure 9. Efficacy of DC and AC fluorescent lighting products.	13
Figure 10. Efficacy of AC incandescent lamps.	13
Figure 11. Efficacy of AC incandescent reflector lamps.	14
Figure 12. Energy use for DC and AC Refrigerator/Freezers.	16
Figure 13. Projection of world PHEV and EV sales.	18
Figure 14. External power supply efficiencies.	24
Figure 15. Rated power output (a) and voltages (b) of PV modules satisfying the Guidelines for California's Solar Electric Incentive Programs.	32
Figure 16. Efficiencies of PV modules satisfying the <i>Guidelines for California's Solar Electric Incentive Programs</i> .	33
Figure 17. PV module wholesale price decreases with power.	34
Figure 18. Historical decline in PV module prices.	35
Figure 19. Building-sited wind turbines.	36
Figure 20. Retail price curve for grid-tie inverters without battery backup (2010 data).	39
Figure 21. Efficiency curve for the SMA Sunny Boy 7000US string inverter (with MPPT).	40
Figure 22. DC data center power supply efficiency curve.	44
Figure 23. Efficiency curve of the MorningStar SunSaver charge controller with MPPT.	47
Figure 24. Technical maturity of storage technologies.	49
Figure 25. Storage technologies comparison.	50
Figure 26. A typical ceiling-based EMerge system schematic	51
Figure 27. U-Socket, marketed by fastmac.com provides 5V _{DC} USB power from wall sockets.	52

List of Tables

Table 1. Dominant AC electricity end-uses in the U.S. residential and commercial sectors showing energy use (quads) in 2010 and electricity usage rankings.	8
Table 2. DC air-conditioners, manufacturers and DC voltages.	9
Table 3. DC Lighting Product Manufacturers.	11
Table 4. DC refrigerator product manufacturers.	14
Table 5. Price Comparison of Energy Star-Rated AC Refrigerators and DC Refrigerators.	16
Table 6. 2010 U.S. Residential electricity consumption by end use and appliance type.	21
Table 7. Functions embodied in appliances and DC technologies that can serve those functions.	22
Table 8. Energy savings possible from switching from standard technologies to the most efficient DC-internal technologies, assuming that both the standard appliance and the DC-internal appliance are running on AC.	23
Table 9. Typical power consumption of appliances and the corresponding AC-DC conversion efficiencies	25
Table 10. AC-DC conversion loss savings of the most efficient DC-compatible option, by end-use.	26
Table 11. AC-DC Conversion Efficiency for Home Audio with Standby/Low Power Mode	27
Table 12. AC-DC Conversion Efficiency for DVDs/VCRs with Standby/Low Power Mode	28
Table 13. AC-DC conversion efficiency for computers with standby/low power mode.	29
Table 14. Estimated percent energy savings from switching from the standard appliance to the most efficient DC-compatible appliance run on AC, and from avoided AC-DC conversion losses in the DC-appliance.	30
Table 15. Market share of PV modules used in California PV systems (grid-connected residential and commercial) installed under the California Solar Initiative that are up to 30kW (nameplate).	32
Table 16. Manufacturers and prices of small wind turbines designed for grid connected applications. Most provide for integrated battery storage.	37
Table 17. Market share of grid-interactive inverters used in California PV systems (residential and commercial) installed under the California Solar Initiative that are up to 30kWDC.	40
Table 18. Pricing information for Outback Power and Schneider Electric inverters with battery backup.	41
Table 19. High power DC-DC converter models built for harsh environments.	43
Table 20. DC-DC optimizer models, their power characteristics and reported peak efficiencies.	45
Table 21. Pricing information on charge controllers with MPPT.	46
Table 22. Lead-acid battery models used in residential PV systems.	48
Table 23. Characteristics of home energy management systems currently on the market.	54
Table 24. Refrigerator design options considered by DOE in its current energy efficiency standard rulemaking for refrigerators	63

Glossary of Terms, Acronyms, and Abbreviations

AC	alternating current
BDCPM	Brushless DC permanent magnet motor
EV	electric vehicle
Btu	British thermal unit
CEC	California Energy Commission
CFL	compact fluorescent lamp
DC	direct current
DC-based	technology that relies fundamentally on the use of DC power
DC-compatible	technology that can be operated on DC, though DC is not required
DC-internal	refers to appliances and equipment in which main power throughputs are converted from AC to DC internally (examples include brushless DC motors, electronic lights, and televisions)
direct-DC	the direct use of DC power from DC-generating power sources by appliances and equipment without converting to AC first
DOE	United States Department of Energy
EER	Energy Efficiency Ratio: An instantaneous measure of air conditioning cooling efficiency at fixed outside temperature of 95° F.
EIA	United States Energy Information Administration
grid	The AC power grid consisting of the transmission and distribution lines that deliver power generated at centralized power plants to distributed loads and that accept excess power generated by net-metered distributed loads.
IEEE	Institute of Electrical and Electronics Engineers
inverter	a device that converts DC to AC
kW	kilowatt
lamp	The component of a lighting system that contains the light source (also known as a light bulb or tube, a compact fluorescent lamp typically includes an integral ballast, as do HID lamps, and an LED lamp includes electronic driver and optics)
LED	light-emitting diode

lumen	a measure of the power of light perceived by the human eye
microgrid	A group of interconnected loads and distributed energy resources within clearly defined electrical boundaries that acts as a single controllable entity with respect to the grid. A microgrid can connect and disconnect from the grid to enable it to operate in both grid-connected or island mode.
MPPT	maximum power point tracker: a high efficiency DC to DC converter
PHEV	plug-in hybrid electric vehicle
PoE	power over ethernet
PV	photovoltaic
rectifier	a device that converts AC to DC
SEER	Seasonal Energy Efficiency Ratio. A measure of average cooling energy efficiency (Btu / W-hr) during a typical cooling season.
V_{ac}	AC voltage
V_{dc}	DC voltage
W	Watt (SI unit of power equal to one joule per second)
Wh	Watt hour

Executive Summary

This document catalogs the characteristics of current and potential future direct current (DC) products and power systems. It is part of a larger U.S. Department of Energy (DOE)-funded project, “Direct-DC Power Systems for Energy Efficiency and Renewable Energy Integration with a Residential and Small Commercial Focus”. That project is investigating the energy-savings potential, benefits, and barriers of using DC generated by on-site renewable energy systems directly in its DC form, rather than converting it first to alternating current (AC) for distribution to loads. Two related reports resulted from this work: this Catalog and a companion report that addresses direct-DC energy savings in U.S. residential buildings [1].

Interest in ‘direct-DC’ is motivated by a combination of factors: the very rapid increase in residential and commercial photovoltaic (PV) power systems in the United States; the rapid expansion in the current and expected future use of energy efficient products that utilize DC power internally; the demonstrated energy savings of direct-DC in commercial data centers; and the current emergence of direct-DC power standards and products designed for grid-connected residential and commercial products. Based on an in-depth study of DC appliances and power systems, we reached the following main conclusions about off-grid markets for DC appliances, the DC compatibility of mainstream electricity end-uses, and the emerging mainstream market for direct-DC appliances and power systems.

Mature Off-Grid Markets for DC Appliances

DC appliances have served niche markets for decades, offering proof of their capacity to deliver energy services for all major electricity end-uses. Markets for stationary applications include off-grid residential, telecom, remote scientific monitoring stations, and emergency shelters. The products are designed to be energy efficient, because of the high cost of supplying electricity to these generally remote locations. Mobile applications include rail, marine, and road transportation (trucks, recreational vehicles, and automobiles) and are designed to be rugged (vibration-resistant) as well as efficient. These DC appliances tend to be higher priced (per unit of service) and smaller (in the case of large appliances) than their mainstream counterparts, but their fundamental designs are applicable to mainstream use, and prices would come down with mass production.

DC-Compatible Electricity End-Uses

Large energy savings are possible from switching from AC appliances to DC-compatible appliances, even if they are running on AC. All of the 32 electricity end-uses investigated in this report were found to be DC-compatible; indeed DC-based design increases the efficiency of all major residential and small commercial end-uses, including cooling, lighting, space and water heating, clothes washing, and dishwashing. DC is essential for all electronics. Key DC-based technologies include electronic lighting (fluorescent and solid state) and DC motors (driving fans, pumps, compressors and other devices, in particular in variable-speed operation where appropriate).

An increasing fraction of the residential and commercial load is DC-internal, increasing the logic of DC power use in buildings. The primary focus of the analysis of DC potential end-used reported in this Catalog and the companion report [1] is the residential sector, but it has strong overlap with small commercial applications. We estimate that 33% of residential electricity use could be saved by

converting all appliances to high-efficiency, DC-internal technology running on AC. Direct-DC power systems could offer additional savings by eliminating the AC-to-DC conversions losses, which constitute on average 14% of the AC load. Note however that, if grid backup power is used to supply DC loads, AC-to-DC conversion losses will reduce the net savings to less than 14%. Savings should be higher for the commercial sector because of the greater coincidence with insolation and load, particularly for space cooling.

An Emerging Market in DC Appliances for Mainstream Applications

Electric vehicles (EVs)—in particular plug-in hybrid electric vehicles (PHEVs)—are expected to constitute a rapidly growing pure DC load that direct-DC might facilitate if charging can occur during the day. DC distribution systems, which provide a DC bus into which a building's electrical system can be connected and preclude the need for a large capacity rectifier, accommodate DC loads more easily than today's AC-distribution buildings, implying lower incremental costs for EV/PHEV adoption. SAE International is currently developing a DC vehicle-charging standard. While residential EV/PHEV loads offer limited opportunity for direct-DC, because most residential vehicle charging is likely to occur at night, if EV/PHEV commuters' charging needs can be accommodated at work, there would be a perfect match between load timing and PV system output, implying a significant direct-DC advantage. Moreover, given that solar electricity is already approximately cost competitive with gasoline on a dollars-per-mile fueling basis, the direct-DC advantage could offer a tipping point advantage, making this use of solar energy immediately cost competitive.

While EVs and PHEVs are creating new DC demand, other products are entering the market to distribute DC power directly to appliances, which in turn is stimulating a new market in DC appliances. The EMerge Alliance, an industry alliance promoting the use of direct-DC, is registering products that are designed to meet its new 24V_{DC} Occupied Space Standard. Notable is the Armstrong Ceiling, which integrates the 24V_{DC} bus into the metal framework that traditionally holds the tiles in a commercial drop ceiling. With this product, 24V_{DC} appliances and controls can be easily installed and relocated without the need of an electrician. Nextek Power Systems has produced DC lighting and fans, while Lunera, Focal Point, and Cooper have all produced 24V luminaires, to couple to the EMerge ceiling.

Power over Ethernet (PoE) is another existing low voltage DC distribution system. PoE standards are evolving to accommodate higher power devices. The Institute of Electrical and Electronics Engineers has revised the PoE standard (IEEE802.3) rapidly upward from 15.4W in 2003, to 25W in 2009 (both at 48V_{DC}). The Institute is currently developing a new standard that is expected to extend that limit to 65W at 51-54V_{DC}, offering the opportunity to power an expanding universe of consumer electronics. While the current EMerge system and PoE cannot power large appliances, EMerge is now developing a 380V_{DC} standard to meet large loads in data centers and telecom central offices. Together, the two standards provide a foundation for serving all residential and commercial loads.

While EMerge is clearly the most visible actor influencing the evolution of direct-DC in the United States, there is international interest as well. The two main international actors both have strong industry partners. Japan's New Energy and Industrial Technology Organization (NEDO) has worked closely with Panasonic in direct-DC research and development. In Korea, Samsung, working with the Seoul National

University, appears to be farthest along in residential direct-DC, having completed a residential DC demonstration project in 2009. While there is clear interest in international and intra-national cooperation in the development of DC standards for building and vehicle charging, success in this endeavor is essential for the direct-DC market to develop and for potential energy savings to be realized.

1. Introduction

This document catalogs the characteristics of current and potential future DC products and power systems. As such it is as much a research report as a catalog. The work emanates from a larger project conducted by the Lawrence Berkeley National Laboratory for the US Department of Energy's Building Technologies Program: *Direct-DC Power Systems for Energy Efficiency and Renewable Energy Integration with a Residential and Small Commercial Focus* (referred to henceforth as the direct-DC Power Systems Project). The primary purpose of that project is to investigate the viability and energy-savings potential of using direct current (DC) generated by on-site renewable energy systems in its DC form, rather than converting it first to alternating current (AC) for distribution to the loads. Interest in direct-DC is motivated by a combination of factors: the very rapid increase in residential and commercial photovoltaic (PV) power systems in the United States, the rapid expansion in the current and expected future use of energy efficient products that utilize DC power internally, the demonstrated energy savings of direct-DC power use in commercial data centers, and the current emergence of direct-DC power standards and products designed for grid-connected residential and commercial products.

While residential PV use began with direct-DC in off-grid systems running DC appliances, AC-based grid-connected systems now dominate the PV market, with installed commercial capacity now exceeding residential capacity. Figure 1 shows the annual additions to installed capacity of residential and commercial grid-connected PV in the United States. State net-metering laws, which began to proliferate in the late 1990s, initiated an explosive expansion of grid-connected PV, dominated by residential and commercial installations. From 2000 to 2009, domestic shipments of PV cells and modules grew by 35% per year (EIA, 2010, Table 3.2) while at the same time the unsubsidized installed system cost fell by 43% between 1998 and 2010 [2]. By 2009, grid-connected PV commanded more than 97% of total PV shipments, remote (off-grid applications) constituted only 1.3%, with the rest going to communication, consumer goods, transportation, water pumping, and other miscellaneous applications (EIA, 2010, Table 3.7).

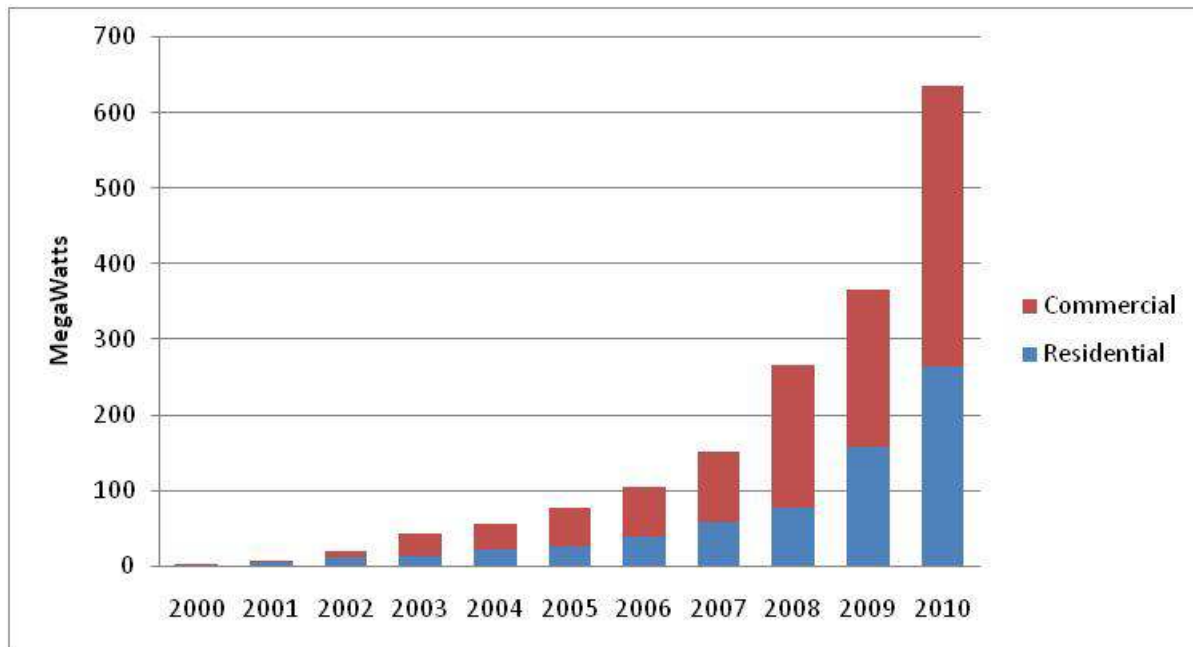

Figure 1. U.S. annual capacity additions of residential and commercial grid-connected PV in megawatts.

Data sources: [3, 4].

In a net-metered system, the PV system's power output is connected on the house side of the utility meter. The load consumes whatever power it needs, drawing first from the PV system if available and from the AC system to make up any deficit. At any instant, if there is an excess of PV power, it is sent to the grid driving the meter backwards. The rapid growth in PV is due in large part to the advantageous economics of annual net-metering. Currently 43 U.S. states, the District of Columbia and Puerto Rico have adopted net-metering laws, which require utilities to accept such grid-connections for specified renewable energy sources [5].

If direct-DC has a future in residential and commercial power supply, for the foreseeable future it will be in net-metered grid-connected buildings, both because of the very slow turn-over of the building stock and because the grid provides backup power for PV-powered buildings at a far lower cost than any off-grid technology, with batteries currently being the only on-site storage technology available for that purpose. Moreover, even if the use of on-site storage expands considerably, as it must to allow higher levels of PV penetration on the grid, the cost of battery storage per unit of load served goes up sharply as one tries to reach 100% of backup load requirements [1]. Thus we do not foresee that economically viable storage technologies will entirely displace the grid in this service.

For these reasons, this work assumes that future DC products and power systems will be operating in net-metered grid-connected buildings. This assumption imposes the need for power system components that would not be necessary if the direct-DC system were off-grid. In the following section we compare the configurations of current grid-connected PV systems with a hypothetical future direct-DC system, as currently envisioned by most researchers in the field.

1.1. DC Power Systems for Residential and Commercial Buildings: Overview

Figure 2 is a highly simplified schematic of a grid-connected, net-metered PV system, showing how PV power systems are configured in U.S. residential and small commercial buildings today. The load is separated into cooling, non-cooling, and an optional electric vehicle load for conceptual clarity, because of the different nature of these loads with respect to the potential utilization of direct-DC. Specifically, the timing of these loads with respect to PV system output suggests different utilities:

- Cooling loads have the greatest temporal overlap with PV system output and therefore offer the best potential for energy savings from direct-DC.
- The timing of EV charging relative to PV output is likely to be generally poor, as most driving is done during daylight hours. However, commuters charging their EVs at work would make an excellent load-to-output match.
- Non-cooling loads will generally be synchronous with PV output for the commercial sector and not so for the residential sector.

Direct current from the PV system is converted to alternating current by the *inverter*. That power is then distributed to the AC loads in the conventional manner (using the existing building wiring in retrofit systems), supplying 240Vac to certain high power loads, such as electric HVAC or electric ovens and stoves, and 120Vac to low power loads.

In the hypothetical future direct-DC building, power from DC power systems or storage devices would be sent directly to DC appliances, rather than first converting it to AC. That is, power distribution within the house is in DC form. While such systems do not yet exist at the whole building scale, we note that some products are emerging on the commercial market that begin to approach this goal—namely, the Armstrong Flexzone ceiling system operating with Nextek Power Systems components and products.

This approach eliminates the usual DC-AC-DC conversion losses incurred in powering DC-internal products (when adequate PV power is available to supply them), but it incurs other losses because AC grid backup power must now be converted to DC when PV power is not sufficient to power products and any excess DC power must now be inverted to AC for net metering. The PV array still needs a maximum power point tracker, which provides the necessary constant voltage to the load and adjusts the apparent load characteristics seen by the PV array to force it to operate at maximum power output. Maximum power point tracking is typically built into today's PV-system inverters and is therefore omitted from Figure 2. In addition, a DC-DC converter, or possibly multiple ones, would be needed to convert the high voltage DC coming from the array and going to high power loads to lower power loads that operate at lower voltage.

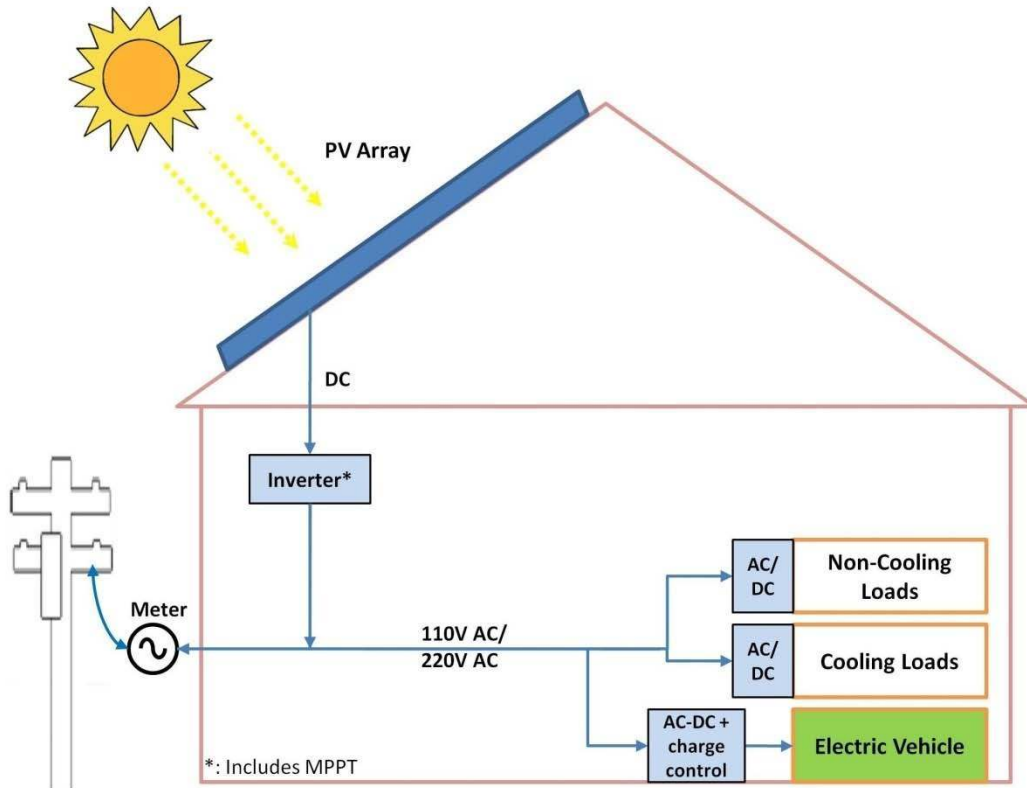

Figure 2. Typical AC Power System.

Simple schematic of building with a net-metered PV system showing only those system components that generate, convert, and consume power.

Figure 3, a simple schematic of the direct-DC house, shows how these issues complicate the power system configuration for net-metered direct-DC. In the figure, the system is shown without storage, to make it analogous with the typical configuration of today's residential and commercial PV systems. The DC voltage shown in the figure reflects the existing ($24V_{DC}$) and pending ($380V_{DC}$) EMerge Alliance standards for direct-DC.¹ EMerge, an alliance of about 80 industry and research institute members, is guiding the development of DC technologies and standards in the United States.[6] While the existing and pending standards were developed for commercial buildings, the Alliance anticipates the application of these standards in the residential sector as well. EMerge has dominated the dialog on direct-DC in the United States and has hosted international dialogs on the subject as part of Green Building Power Forum and Smart Grid meetings held annually for the past three years in the United

¹ Based on interviews with members of the Board of Directors of the EMerge Alliance, 24-V was selected for the low voltage standard, because it is the highest voltage among the logical candidate voltages that is uniformly considered safe in local building codes. According to the Electric Power Research Institute representative, Dennis Symanski, who is leading the EMerge Alliance 380-V standard committee, 380-V was selected for the higher voltage standard in the context of powering DC data centers and other high-wattage AC devices with power supplies, most of which rectify to $380V_{DC}$. That is, the devices they are running are $380V_{DC}$ internal.

States and Japan. These meetings have been the major U.S. forums for the evolving discussion of direct-DC power systems for buildings.

Based on international participation in those meetings, there appears to be growing international interest in adopting the EMerge standards as well. The two main international actors in direct-DC have been Japan and Korea. Japan’s New Energy and Industrial Technology Organization (NEDO) has modeled the potential energy savings of direct-DC and engaged Panasonic in the assessment and development of DC appliance prototypes. (Arthur D. Little is the consultant on the modeling work.) Korea appears to be farthest along in direct-DC research and development, having completed a large residential DC demonstration project in 2009 (a 30KW project by Samsung C&T Corp.) with DC distribution and appliances that integrates 22 kW of PV, 3 kW of wind power, and 200W of fuel cell capacity, along with 22 kWh of battery storage. This study claims only a modest 1.5% – 3% efficiency gain resulting from direct-DC.[7] All of these groups have been participating in meetings addressing the voltage choice issues and desire a unified approach.

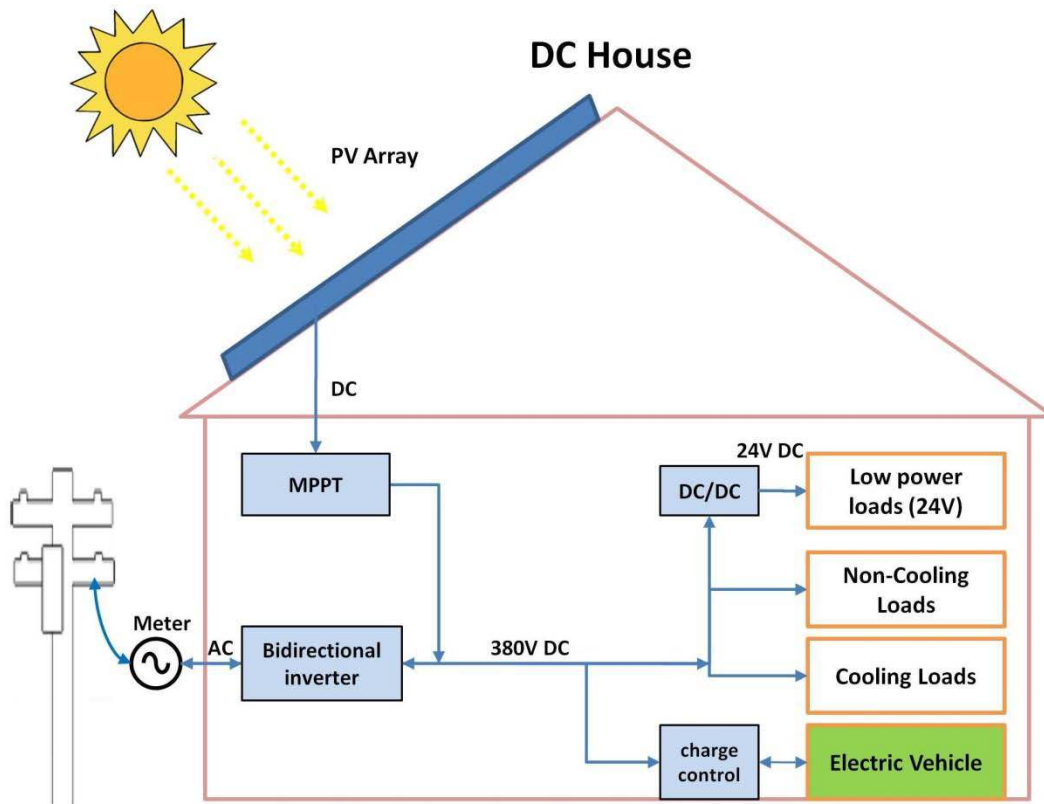

Figure 3. Direct-DC Power System.

A simple schematic of a building with load powered by direct current. The figure shows only the main system components that generate, convert, and consume power.

Figure 4 and Figure 5 show the equivalent AC-distribution and DC-distribution buildings as in the previous figures, but also include electricity storage. Storage will be essential to reaching high levels of on-site PV capacity in the future, because of the need to buffer large simultaneous peaks in local

generation. In addition, for completeness we have added a hypothetical EV charging load. The EV load could be added whether or not the building power system includes battery storage, and the EV battery might even be used as an integral part of building energy storage in the future. (This issue is not addressed in this report). Now, and for the foreseeable future, that storage is likely to be supplied by batteries, with deep-cycle lead-acid batteries being virtually the only technology that is widely used today.

The purpose of this catalog is to examine the likely differences between AC and future DC power system components and electricity-using products. Very extensive literature already exists on today’s PV power systems. Therefore, we avoid an in-depth discussion of technologies that would be common to the two systems—power generation, for example—and we focus instead on those components that would differ between system types, and, specifically, on how those differences would affect energy use. Section 2 of the catalog describes current and future DC appliances and how they differ from today’s AC appliances. Section 3 compares AC and DC power system components.

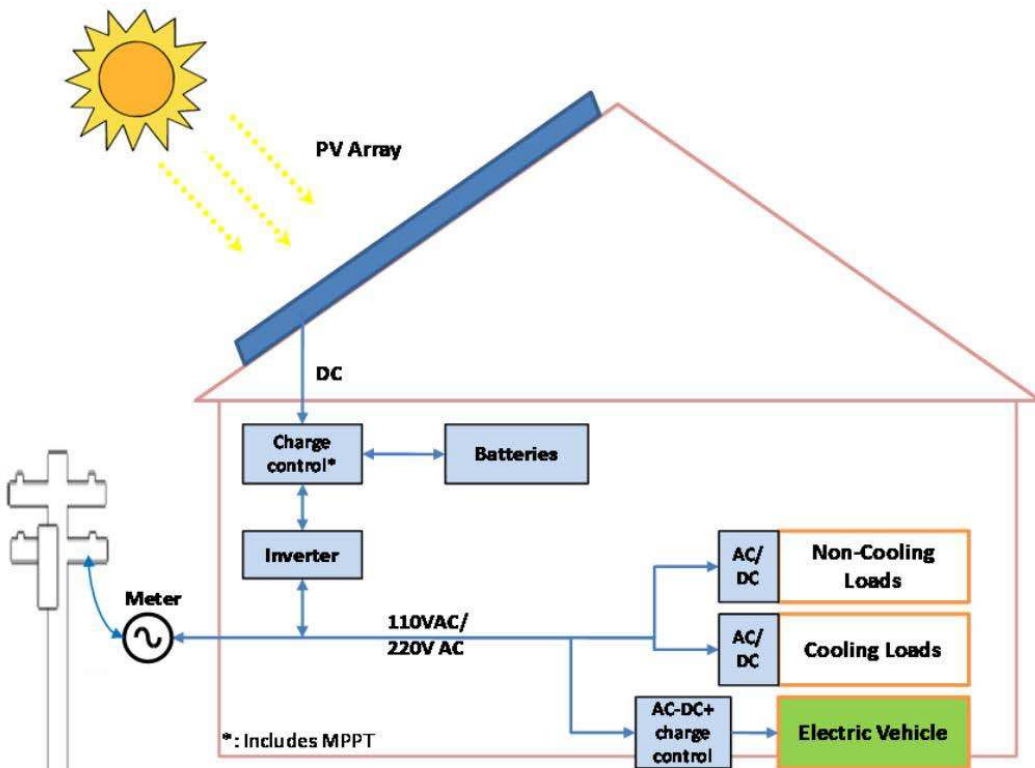

Figure 4. AC Power System with Storage.

Simple schematic of building with a net-metered PV system, electricity storage and an optional electric vehicle load. The inverter is bi-directional, allowing battery charging from the solar system during the day and from the grid at night.

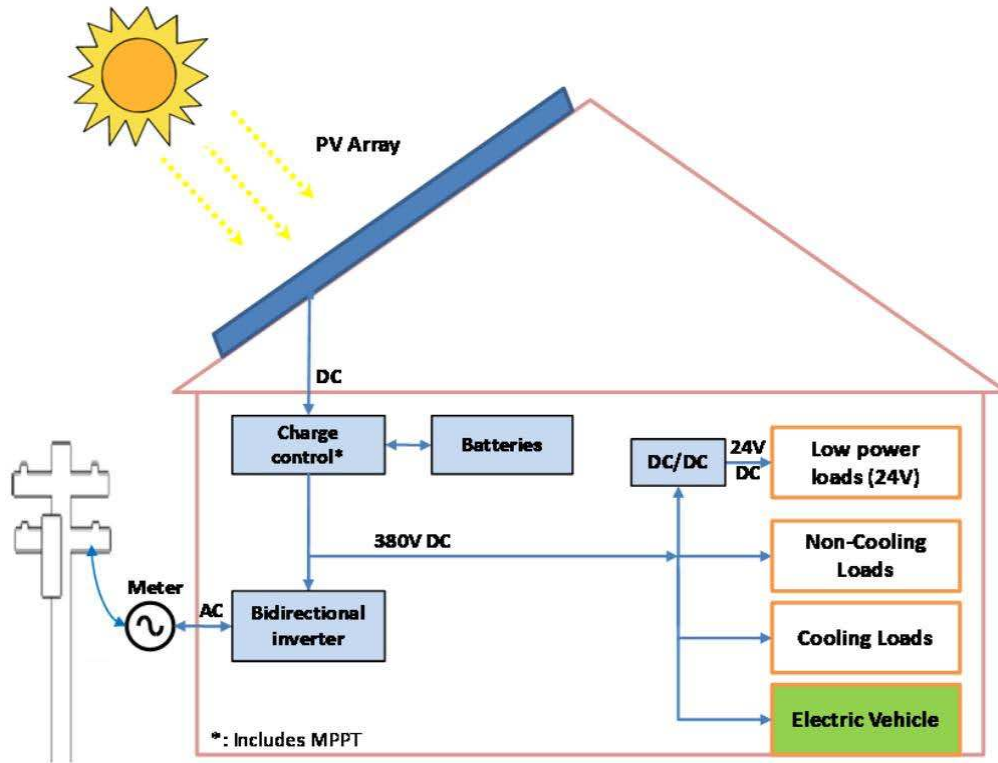

Figure 5. DC Power System with Storage.

The loads in the building are the same as in Figure 4 above, except for the AC/DC power supplies. Power is distributed at 380V_{DC} for high power loads and at 24V_{DC} for low power loads.

2. DC Appliances and End Uses

The following sections examine existing, emerging, and potential future DC products. In this catalog ‘DC products’ refers to products marketed in a form that take DC input. This excludes products that are sold with external power supplies intended to convert AC to DC, which are really designed for AC markets. Clearly, such products could be easily used in a direct-DC context if their DC power input requirements were standardized.

2.1. Existing DC Products for Off-Grid Niche Markets

There is a relatively small existing market for DC products that includes both mobile and stationary applications. Mobile applications include road transportation (trucking and recreational vehicles), rail, and marine. Stationary applications include primarily remote commercial applications (e.g., shelters for telecom equipment, meteorological monitoring, and emergency rescue operations) and off-grid residential. While many products are marketed into multiple markets, the main distinction is mobile versus stationary, because of the need of the former to withstand vibrations. All of these products are designed to be integrated with lead-acid battery storage, which determines the three voltages (12V, 24V, 48V); they are frequently marketed for PV integration.

The following sections document DC appliances for three dominant electricity end-uses—cooling, lighting, and refrigeration, which together consume about 40% of total electricity in residential and commercial markets (see Table 1). For each of these products we provide market information, power characteristics, and a comparison of their energy efficiencies with their AC counterparts. This is followed by a brief summary of DC products for other miscellaneous end-uses.

Table 1. Dominant AC electricity end-uses in the U.S. residential and commercial sectors showing energy use (quads) in 2010 and electricity usage rankings.

End Use	Residential (quads)	Ranking	% of sectoral total	Commercial (quads)	Ranking	% of sectoral total
Cooling	0.79	1	16%	0.5	3	11%
Lighting	0.72	2	15%	1.12	1	24%
Refrigeration	0.45	3	9%	0.23	5	5%
Sub-total	1.96		40%	1.85		39%
US Total	4.95			4.73		
Subtotal as percent of total	40%			39%		

Data source: [8].

2.1.1 DC Air Conditioners

2.1.1.1. Market Analysis:

Based on Internet research, we found four companies that produce DC air conditioners marketed for mobile and stationary applications (see Table 2). DC Airco and DC Breeze produce small, rugged products for mobile applications, with capacities of 5,000 Btu/hr or less. SplitCool and Securus market products suitable for residential or small commercial use that include heat-pump heating, both of which have 1.5 ton (18,000 Btu/hr) cooling capacities and are marketed for PV power integration (using four or more 200W solar panels)[9].

Table 2. DC air-conditioners, manufacturers and DC voltages.

Manufacturer	Applications	Voltage	Source
DC Airco	Mobile (auto/RV)	12V/24V	http://www.outdoorgb.com/p/12v_air_conditioners/
DC Airco	Mobile (telecom and other)	24V/48V	http://www.dairco.com
DC Breeze	Marine	12V/24V	http://www.dcbreeze.com/specifications.htm
SplitCool	Stationary	12V/48V	http://www.solarpanelsplus.com/dc-air-conditioning
Securus	Stationary	48V	http://www.austinsales.net/products/solcool/index.html

2.1.1.2. Energy Efficiency Analysis

Figure 6 compares the energy efficiencies of DC air conditioners with their AC counterparts. Although there are far fewer DC products, their efficiencies are consistently higher than their AC counterparts. There are a number of reasons for this. In general, off-grid electricity is expensive, and therefore there is an incentive to produce efficient products. In addition, DC air conditioners offer inherent efficiency advantages.

Modern air conditioners use vapor-compression refrigeration technology, which requires motor-driven pumps to operate. Variable-speed compressors use far less energy than their typical single-speed counterparts (with documented savings of 30% and more) and offer higher performance, because, rather than switching between full-on and full-off to maintain thermal comfort, they match output to need, avoiding energy intensive on-off cycling of the motor and overcooling during on-cycles. Variable-speed compressors are generally powered by variable frequency drives. The typical variable frequency drive first rectifies the AC input (converts it to DC), then uses pulse width modulation to create the desired output frequency.[10] Because the power passes through a DC phase, it is amenable to operation by direct-DC. The most efficient variable-speed drives use brushless DC permanent magnet motors [11]. We note that the DC solar-powered DC air-conditioning heat pump produced by SplitCool does indeed use a variable-speed brushless DC compressor.

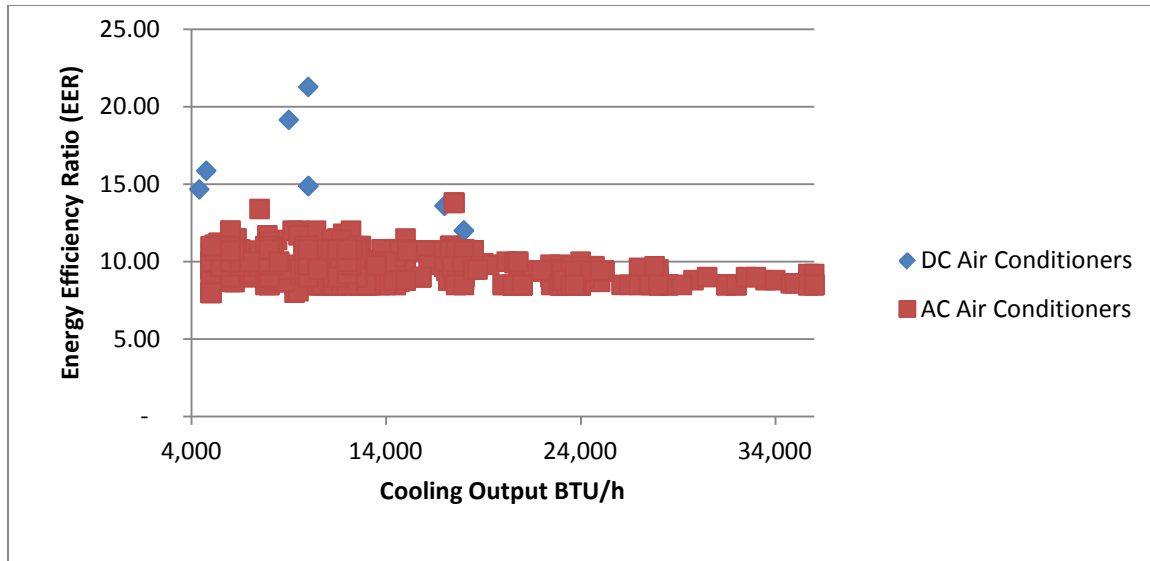

Figure 6. Energy efficiency comparison for DC and AC air conditioners.

Data sources: For DC products, sources indicated in Table 2. For AC products, data from the California Energy Commission Appliance Efficiency Database[12]

2.1.2 DC Lighting

2.1.2.1. Market Analysis

The DC lighting market includes more companies and a larger diversity of products than the DC air-conditioning market, but, like DC air-conditioning, DC lighting represents an insignificant share of the mainstream market, except in such niche markets as outside emergency lighting. This section documents DC lighting products marketed on the Internet. Based on Internet research, there are six companies that produce DC light sources for the DC niche markets: Ablamp, Nextek Power Systems, Phocos, Steca, Thin-Light, and SunWize. Summarized in Table 3, these products include DC lamps (fluorescent, compact fluorescent (CFL), and light-emitting diode (LED) for various fixture types and applications), DC ballasts, fixtures designed for DC lamps (or all kinds), and ballasts for 12V, 24V, and 48V operation.

2.1.2.2. Energy Savings Analysis

Figure 7, Figure 8, and Figure 9 compare the efficacies of CFL, LED and fluorescent DC lamps with their AC counterparts. For CFLs and LEDs, as with air conditioners, the DC technologies have higher efficiencies on average than their AC counterparts. In the case of CFLs, the DC product efficacy is almost 10% higher than AC counterparts with the same power consumption. For LEDs, the improvement in DC product efficacy is even larger and depends on lamp power. For other fluorescent lighting (non-compacts) it is difficult to make a reliable comparison because there is very little overlap in the DC and AC technologies in terms of power consumption.

Table 3. DC Lighting Product Manufacturers.

Manufacturer	Applications	Product	Voltage	Source
Ablamp Ltd	Home, street, boat, outdoor	CFL Edison Socket lamps	12V	http://www.ablamp.com
Ablamp Ltd	Home, office, hotel, shop, landscape, security	LED Edison socket and pin lamps	12V/24V	http://www.ablamp.com
Ablamp Ltd	Caravan, boat, landscape	LED floodlamp	12V/24V	http://www.ablamp.com
Ablamp Ltd	Residential, commercial, vehicle	T8-LED fixture, tube, source	12V	http://www.ablamp.com
Nextek Power Systems	Residential, commercial	Ballasts for T5, T8, and CFL lamps	24V/48V	http://www.nextekpower.com/power-shop/direct-current-ballasts.html
Phocos	Home, street	CFL lamps	12V/24V	http://www.phocos.com
Phocos	Home	LED lamp	12V	http://www.phocos.com
Steca	Home	CFL floodlight	12V	http://www.altestore.com
SunWize	Public building, restroom, garage, park, sign, wall washing, driveway, security	Lighting systems: Fluorescent, CFL	12V/24V	http://www.sunwize.com
SunWize	Bus stop, porch, outbuilding	Lighting systems: LED	12V/24V	http://www.sunwize.com
Thin-Lite	Home, industrial, commercial sites, area, security	Fluorescent and CFL fixtures and ballasts	12V	http://www.thinlite.com
Thin-Lite	Indoor, outdoor	Incandescent, halogen fixtures	12V	http://www.thinlite.com

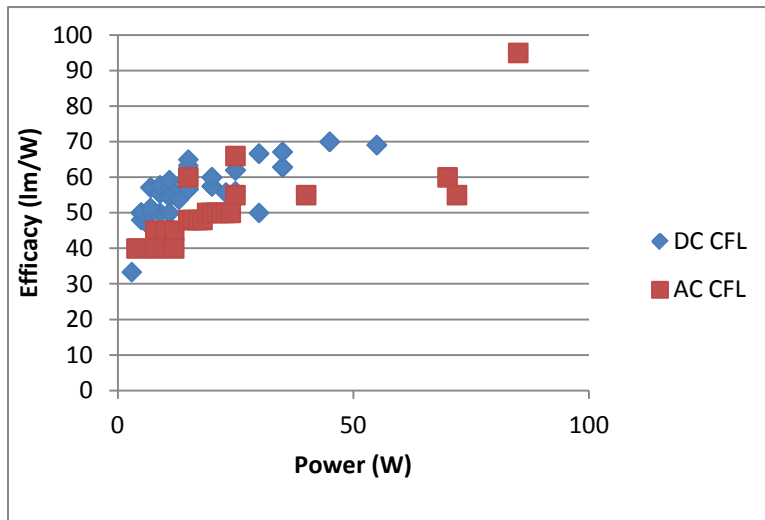

Figure 7. Efficacy comparison for DC and AC CFLs.

Data source: Internet sources indicated in Table 3 for DC products. The California Energy Commission Appliance Efficiency Database for AC lighting products [12].

Figure 8 compares the efficacy of DC and AC LEDs, based on data compiled by the California Energy Commission. DC LEDs in general have significantly higher efficacy than AC LEDs, particularly for lower luminosity bulbs.

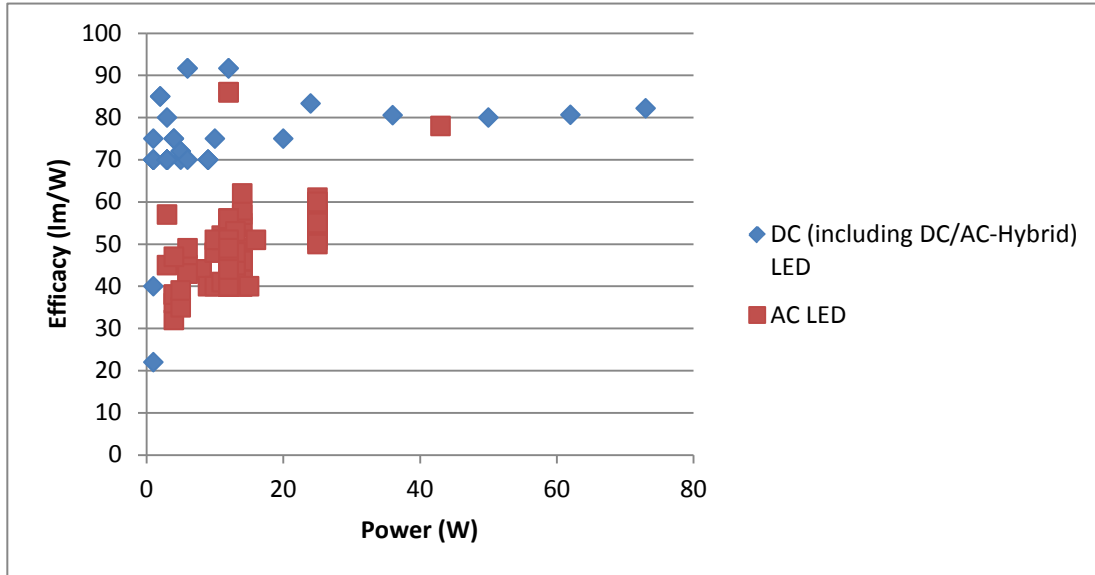

Figure 8. Efficacy comparison for DC and AC LEDs.

Data source: Internet sources indicated in Table 3 for DC products. The California Energy Commission Appliance Efficiency Database for AC products [12].

As for fluorescent lighting, the collected data concentrate mostly on low power for DC fluorescent, but on high power for AC fluorescent, and thus cannot be compared directly. However, the efficacy shows a consistent trend for both DC and AC fluorescent lighting products.

Finally, incandescent lighting sources should have essentially the same efficiencies for AC or DC operation, because the technology is indifferent to current form. What is notable is that incandescent light sources have considerably lower efficacies in general than fluorescent and LED sources (compare Figure 10 and Figure 11 to Figure 7, Figure 8, and Figure 9), and so should generally be avoided in DC power systems unless absolutely necessary. It is worth noting however, that reflector and halogen lamps, which are incandescent, have considerably higher efficacies (25% - 35% higher) than standard vacuum-bulb incandescents, which are slated to be phased out under the lighting provisions of the 2007 Energy Independence and Security Act.

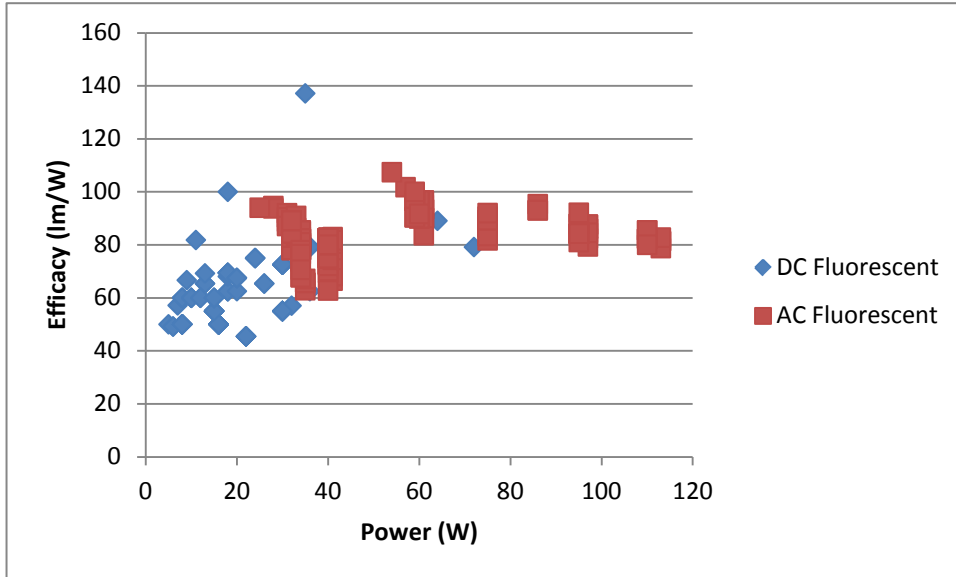

Figure 9. Efficacy of DC and AC fluorescent lighting products.

Data source: Internet sources indicated in Table 3 for DC products. The California Energy Commission Appliance Efficiency Database for AC products [12].

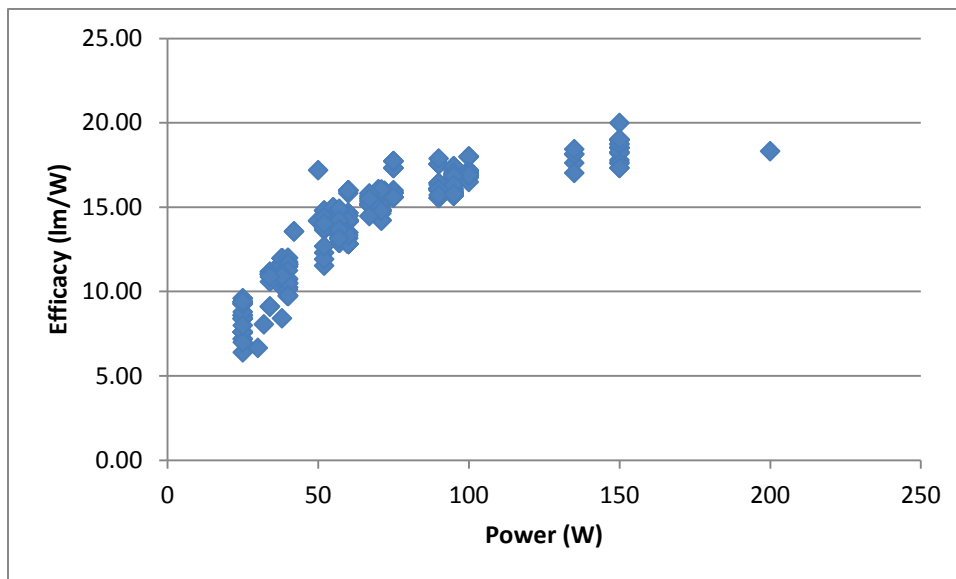

Figure 10. Efficacy of AC incandescent lamps.

Data source: California Energy Commission Appliance Efficiency Database [12].

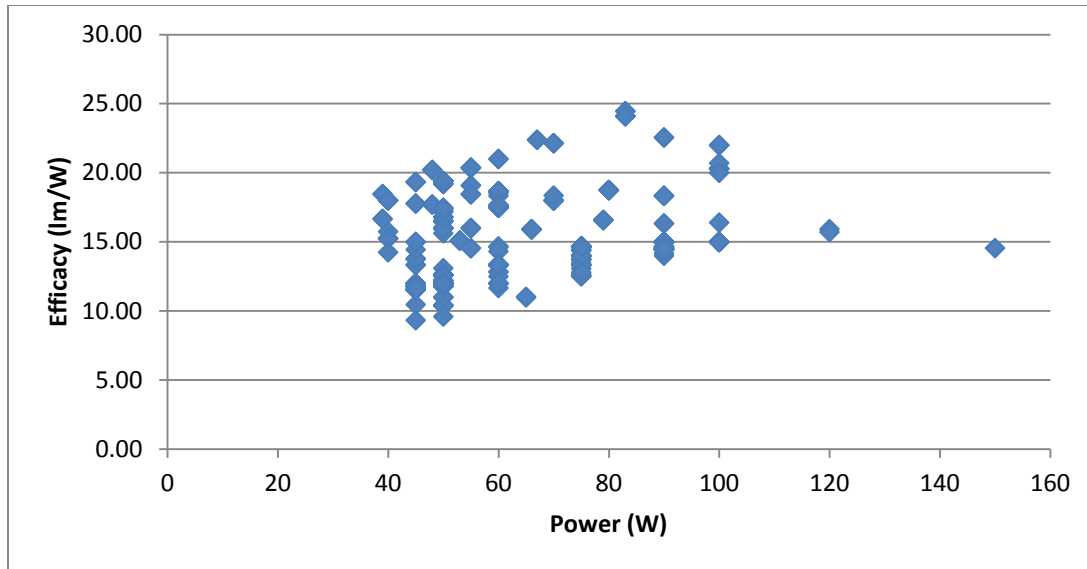

Figure 11. Efficacy of AC incandescent reflector lamps.
 Data source: The California Energy Commission Appliance Efficiency Database [12].

2.1.3 DC Refrigeration

2.1.3.1. Market Analysis

Table 4 lists the main manufacturers of DC refrigeration products and their targeted markets including marine, RV, and off-grid homes. There are five main manufacturers offering a relatively limited selection of 12V and 24V models. In RV applications propane-powered refrigerators are often preferred because of limited battery capacity and the high current requirements of the 12 V_{DC} and 24 V_{DC} refrigerators [13].

Table 4. DC refrigerator product manufacturers.

Manufacturer	Applications	Voltage	Source
Phocos	Solar-powered applications	12V/24V	http://www.phocos.com
Norcold	Marine, RV, trucking, camping/hunting/fishing, vans	12V/24V	http://www.thetford.com
Sun Frost	Home	12V/24V	http://www.sunfrost.com
SunDanzer	Home, remote location	12V/24V	http://www.eco-distributing.com
Dometic	Hotel, RV, truck, marine	12V/24V	http://www.dometic.com/enus/Americas/USA/Start

2.1.3.2. Energy Efficiency Analysis

Refrigerator efficiency is dominated by two factors: compressor efficiency and insulation. As with air conditioners, costly off-grid power provides an incentive for energy efficiency, especially with large power users like air conditioning and refrigeration. Again, variable-speed compressors offer large energy savings, with brushless DC motors being the logical choice of driver. While limited information is available about the underlying technologies used in these products, the Sun Frost models use the Danfoss model BD35 and BD50 variable-speed compressor, depending on capacity [14]. The combination refrigerator/freezer models use two compressors (one for the refrigeration compartment and one for the freezer), allowing each to operate at optimal efficiency.

To compare the efficiencies of AC- versus DC-powered refrigerators, data were collected from manufacturers [15, 16], the U.S. Environmental Protection Agency's (EPA's) Energy Star program [17], and the California Energy Commission (CEC) [12]. For DC products the manufacturers' energy efficiency data were used. For one manufacturer (Sun Frost), data from the EPA Energy Star program were used to corroborate manufacturer claims. In general, currently marketed DC refrigerators are smaller than standard AC residential refrigerators; Figure 12 compares the efficiency of DC models only with AC models in the same capacity range, using the typical refrigerator efficiency metric of kilowatt-hours per year of operation.² Only combination refrigerator/freezers, powered by either AC or DC, were selected for comparison. Based on the available data, the DC products use considerably less energy—on average less than half of the energy of their AC counterparts.

While DC refrigerators are more efficient, they are also far more costly than AC Energy Star products with similar capacities, as shown in Table 5. This is probably only in part due to the advanced technologies used to reduce their energy use. It is well known that appliances prices tend to fall with cumulative production. Given the far larger market in AC refrigerators, and hence far larger cumulative production, it is not fair to compare niche market prices with mainstream market prices. In the United States, the inflation-adjusted wholesale price of standard AC refrigerators fell by almost a factor of three in the last three decades.

² The CEC's energy efficiency data are for AC refrigerators used in homes. DC refrigerator efficiency data are given by manufacturers for operation at 70°F and 90°F. We used the data for operation at 70°F for consistency with refrigerators operated in houses, which are assumed to be maintained within the thermal comfort zone of 68 – 72°F.

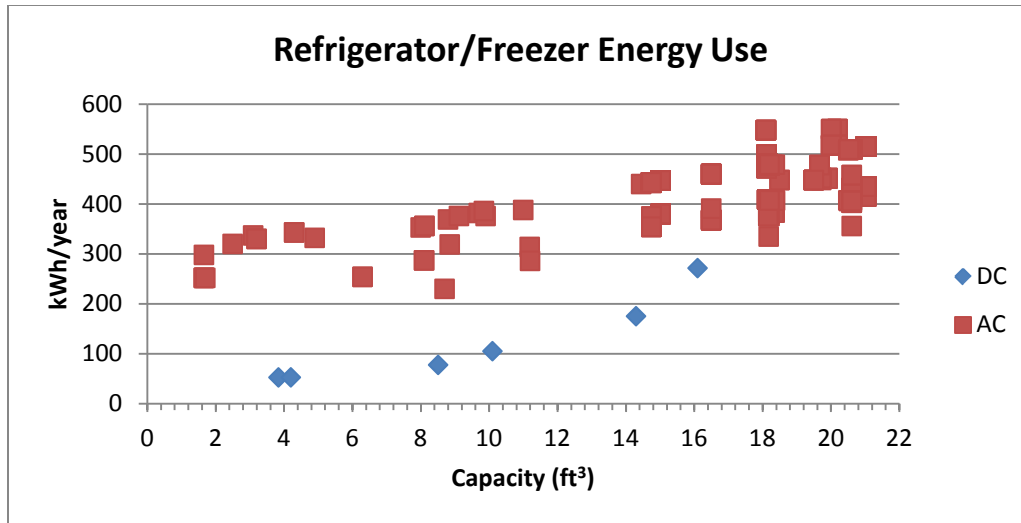

Figure 12. Energy use for DC and AC Refrigerator/Freezers.

Data sources: Manufacturers websites for DC products, the California Energy Commission Appliance Efficiency Database [12] for AC products.

Table 5. Price Comparison of Energy Star-Rated AC Refrigerators and DC Refrigerators.

Manufacturer	AC/DC	Model	Capacity (ft ³)	kWh/Year	Price (\$)
Sun Frost	DC	RF19	16	272	3,295
GE	AC	GTH16BBX***	15.5	363	859
Sun Frost	DC	RF16	14	175	3,210
Whirlpool	AC	W5TXEWFV*0*	14.6	354	649

2.1.4 Miscellaneous DC Appliances

An assortment of other DC appliances are offered for sale on the Internet. These are dominated by 12V fans, griddles, and microwaves advertised to the automobile and RV markets. Other miscellaneous appliances include 12V blenders, heaters, and hair dryers. Most are designed to operate on car batteries.

2.2. Emerging Products for Grid-Connected Homes and Businesses

There are two major new classes of DC products emerging onto the market for residential and commercial applications: (1) DC electric appliances designed for operation with hybrid AC-DC power systems, and (2) EVs, hybrid EVs, and charging stations. As is evident from the data presented in the preceding section, the current generation of DC appliances is not designed to a standard voltage. In addition, DC products tend to be on the smaller side of the capacity range of mainstream AC appliances. This section considers emerging DC appliances specifically designed for mainstream use, to be operated at a standardized voltage in an AC-DC hybrid building, with a DC distribution system.

2.2.1 DC Products for Hybrid AC-DC Power Systems

At Greenbuild 2010 (Chicago, November 16 – 18, 2010), the EMerge Alliance announced the first set of 26 registered products compatible with its 24-V_{DC} standard. Cooper Lighting, Nextek Power Systems, Northwire, OSRAM SYLVANIA, and ROAL Electronics were among the companies that had submitted products for evaluation [18]. A full list of registered products can be found at [19], which is summarized in the following. EMerge registered products fall into four broad classes: infrastructure (cables and connectors), power (power supply modules), peripherals (appliances and devices), and controls (sensors, controls, and interfaces). The first set of 26 products includes those falling into the first three classes; we focus here on those in the peripherals (appliances and devices) class. For peripherals, the registered products are mainly fluorescent and LED lighting and DC ceiling fans. The main manufacturers are Cooper Lighting [20], Finelite [21], Lunera Lighting [22] and the rest are from Nextek Power Systems [23].

2.2.2 Electric Vehicles

Pure EVs and plug-in hybrid electric vehicles (PHEVs) are poised for large-scale entry into the U.S. market. Currently available EV models include the Tesla Roadster and Nissan LEAF, and many more models are anticipated [24]. While a small number of EVs have been on U.S. roads for years, PHEVs are new to U.S. markets. The vast majority of PHEVs on the roads today are custom conversions of the Toyota Prius hybrid vehicle. The Chevrolet Volt PHEV-35, the first mass marketed PHEV in the United States, was released for sale November 2010. Many other car companies plan PHEV releases in 2011 or 2012.

PHEV sales are likely to grow far more rapidly than EV sales because of the current lack of battery charging infrastructure. PHEV owners have the security of being able to fuel with gasoline, if charging is unavailable, making PHEVs a perfect transition technology from the current gasoline fleet to a future electric fleet, a transition that is likely to take decades. Pike Research [25] projects rapid growth in world PHEV and EV sales (see Figure 13), with the United States leading global sales in 2015 with more than one-third of the market.

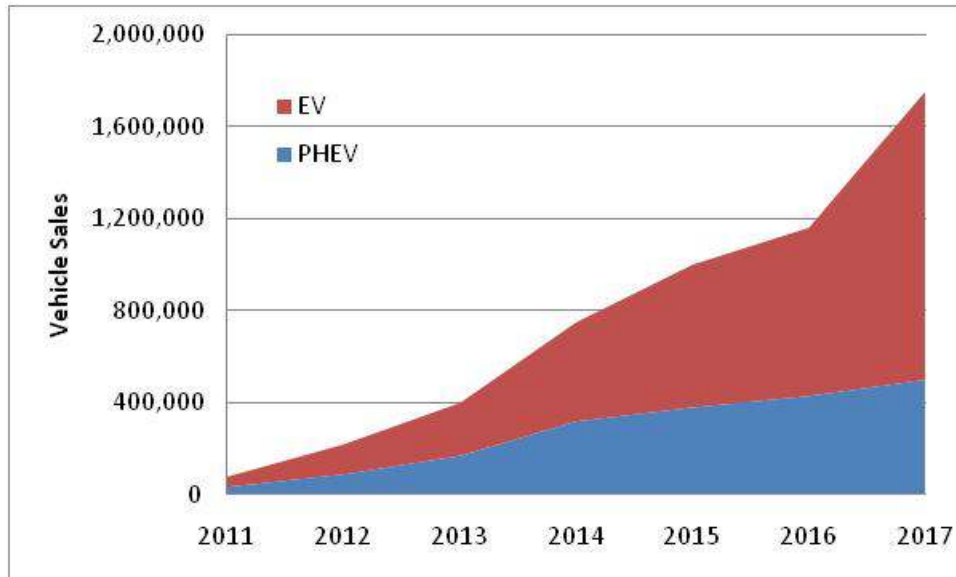

Figure 13. Projection of world PHEV and EV sales.

Data source: Pike Research [25]

EV and PHEV batteries are therefore likely to become a large future DC load, and perhaps even serve as storage for building electricity. While the current vision is to charge vehicles from rectified AC, electric vehicle charging would be more simply integrated into the high-voltage DC bus of the future DC house (Figure 3 and Figure 5).

Whether charging vehicles by direct-DC has the potential to save energy depends on the time of day that vehicles are charged. In residential applications charging would typically be expected to take place in the evening, when most people are home from work. If all vehicle charging took place at night, all charging current would be drawn from the grid, providing no opportunity for charging with direct-DC. In commercial applications, however, the load timing might be more advantageous for direct-DC, with commuters charging their cars during the day while at work—implying a perfect match between PV system output and EV load. Given that electric vehicle ‘fueling’ is cost competitive with gasoline (even with the relatively high cost of solar electricity), because of the far greater efficiency of electric motors compared to gasoline engines, efficient direct-DC vehicle charging in commercial settings is likely to be the most cost-effective use of solar electricity associated with building loads.

EV charging standards [26, 27] currently being developed by SAE International (SAE) [28] as SAE J1772 for North America will facilitate the growth in PHEV and EV markets. AC Level 1 operates on 120 VAC for regular US household outlets and AC Level 2 operates on 208 VAC to 240 VAC for the Electric Vehicle Supply Equipment (EVSE). They are both single phase. A DC EV charging standard, to be incorporated into SAEJ1772, is currently under development, with 300 - 600 V_{DC}, 140 – 400A, and 3-phase charging under consideration [26].

2.3. Potential Future DC Products

This section explores which end-uses are DC compatible and the energy implications, at the product level, of adopting such technologies. As the primary goal of the Direct-DC Power System Project is to determine the potential energy savings of direct-DC, we account separately for the savings due to avoided power conversion losses and the savings from adopting DC-compatible technologies that run on AC (such as today's electronic lighting, electronics, and DC motors). We assume that these technologies would be adopted anyway, because of their large efficiency advantages, although the advantage of direct-DC could be an additional stimulus. Nonetheless it is constructive to quantify the savings obtainable by switching to DC-compatible technologies, because this calculation makes it very clear that there is no energy penalty in doing so; indeed, there is a large advantage.

Because the energy impacts of using DC versus AC appliances lie not only in the differences between the appliances—but also in the difference between the AC versus DC power systems connecting the appliances, PV system, and grid—appliance-level savings tell only a part of the story. To determine the net energy savings, the product-level characteristics documented here were input to an AC- versus DC-house energy use model [1]. More specifically, to distinguish the impact of DC- versus AC-distribution, we defined two sets of appliances for the modeling work. These appliances were identical in every way other than their front-end power interface. The DC-appliance constitutes the basis set. The AC appliance is just the DC-appliance with an AC-DC converter on the power input.

Accordingly, in section 2.3.1 we first determine what DC-based technologies are available to serve 32 residential end-uses and estimate the energy implications of switching from standard technologies to the most efficient DC-based technologies, assuming that both the standard appliance and its DC-internal counterpart is running on AC. Then, in section 2.3.2, we estimate energy savings at the appliance level resulting from the avoided AC-DC conversion losses in the DC appliances.

2.3.1 DC-Internal Products

2.3.1.1. Conceptual Framework

This section identifies electricity end-uses that can be powered by direct-DC without an energy penalty. Specifically, we consider existing and feasible DC-based technologies, where *feasible* means those products constructed of market-proven components. In cases where more than one DC-based or DC-compatible technology exists, we consider the most efficient technology. While any appliance, even such an inherently AC device as an AC motor, can be made to run on DC by installing an inverter at the power input, the constraint of the no-energy-penalty requirement eliminates that possibility, because of the power losses of the rectifier. Therefore, the exercise became one of identifying products or components of products in which AC input power is already rectified to DC to achieve particular performance goals. We refer to products in which the main input is rectified as 'DC-internal'. DC-compatible products include both those that are DC-internal and those that could be constructed of existing components that operate on DC.

To support the modeling work presented in the companion report [1], we based the analysis on residential end-uses. To determine the end-uses and their shares of residential energy consumption, we ran the National Energy Modeling System model (reference case), which is used to generate the U.S. energy consumption forecasts documented in the Annual Energy Outlook (see [29] and [30]). This resulted in the 32 end-use subcategories reported in Table 6.

To enable an analysis of the DC compatibility of numerous appliance types and their potential energy impacts, we first considered the limited number of functions that are embodied in appliances—lighting, heating, cooling, mechanical work, and computing—and the energy impacts that would result from serving those functions with DC-based technology. As shown in Table 7, all of these functions can, or already are, served by DC-compatible technologies with neutral or positive energy impact over conventional technologies. Specifically, all major lighting technologies used in buildings are either AC/DC indifferent (incandescent) or can be run with DC internal technology (electronic fluorescent and LED). Similarly, heating can be achieved by DC-indifferent electric resistance heating or by DC-favoring heat pump technology (i.e., DC motors driving heat pump compressors in a reverse refrigeration cycle, operating at variable speeds where appropriate). Cooling can be achieved with DC fans and air conditioners operating variable-speed DC compressors (see the section on DC air conditioners). All mechanical work could be performed by DC motors, and digital computing is all DC-internal.

Table 6. 2010 U.S. Residential electricity consumption by end use and appliance type.

End-Use	End-use subcategories	Consumption by appliance (TWh)	Consumption by end-Use (TWh)
Space Cooling	Electric Heat Pumps	40.89	222.18
	Central Air Conditioners	153.07	
	Room Air Conditioners	27.09	
	Geothermal Heat Pumps	1.13	
Lighting	Lighting-Incandescent	157.88	210.20
	Lighting-Fluorescent	17.06	
	Lighting-Reflector	24.95	
	Lighting-Torchiere	10.31	
Electric Other	Electric Other	169.26	169.26
Water Heating	Electric Water Heaters	130.02	130.36
	Solar Water Heaters	0.34	
Televisions	Color Televisions and Set-Top Boxes	108.13	108.13
Refrigeration	Refrigerators	107.23	107.23
Space Heating	Electric Heat Pumps	21.32	75.42
	Electric Space Heaters other than Heat Pumps	53.35	
	Geothermal Heat Pumps	0.75	
Clothes Dryers	Electric Clothes Dryers	78.02	78.02
Personal Computers	Personal Computers and Related Equipment	54.56	54.56
Furnace Fans	Furnace Fans and Boiler Circulation Pumps	42.21	42.21
Cooking	Electric Cooking Equipments	31.52	31.52
Dishwashers	Dishwashers	26.71	26.71
DVDs/VCRs	DVDs/VCRs	24.99	24.99
Freezers	Freezers	22.98	22.98
Ceiling Fans	Ceiling Fans	18.19	18.19
Microwave Ovens	Microwave Ovens	13.15	13.15
Home Audio	Home Audio	11.57	11.57
Clothes Washers	Clothes Washers	9.56	9.56
Rechargeable Electronics	Rechargeable Electronics	8.98	8.98
Spas	Spas	8.27	8.27
Secondary Space Heating	Electric Secondary Space Heaters	7.80	7.80
Coffee Makers	Coffee Makers	4.10	4.10
Security Systems	Security Systems	1.91	1.91
Grand Total (rounded)		1390	1390

Table 7. Functions embodied in appliances and DC technologies that can serve those functions

Functions within appliances	Appliance components	Standard technology	DC-Internal best technology
Lighting	Incandescent, fluorescent, and LED lamps	Incandescent	Electronic (fluorescent or LED)
Heating	Electric resistance heater	Electric resistance	Heat pump for space and water heating applications using VSDs ¹ driven by BDCPM motors ² , resistance heating for small applications
Cooling	Motors driving compressors, pumps, and fans	Induction motor, single speed compressor, pump, and fan where applicable	VSDs ¹ driven by BDCPM motors ²
Mechanical work	Motors	Induction motor	BDCPM motor ²
Computing	Electronics	Digital circuits	Same

¹VSD = variable speed drive

²BDCPM = brushless DC permanent magnet

While we conclude that all of the major appliance types in Table 6 are DC compatible with no adverse energy impacts, Table 8 lists 16 appliance types that could yield significant energy savings if the conventional models were replaced by the most efficient DC-compatible alternatives. Note that in some cases, such as resistance heating and incandescent lighting, the technology is already DC compatible, but Table 8 indicates the savings potential of switching to a more efficient DC product.

Note that while all of the replacement technologies indicated in the table are DC friendly, the savings are based on demonstrated or engineered design options that may include other energy saving components as well. For example, refrigerator savings include the addition of vacuum-insulated panels and other options, depending on class. The appendix documents the sources of the estimated energy savings.

Table 8. Energy savings possible from switching from standard technologies to the most efficient DC-internal technologies, assuming that both the standard appliance and the DC-internal appliance are running on AC.

Appliance	Efficient DC compatible replacement technology	Estimated energy savings
Central Air Conditioners	variable-speed compressor and fans run by brushless DC motor in place of single-speed compressors run by AC induction motors.	47%
Room Air Conditioners	variable-speed compressor	35%
Lighting-Incandescent	14LPW incandescent goes to CFL (electronic ballast) @52LPW	73%
Lighting-Reflector	15LPW goes to CFL (electronic ballast) @52LPW	71%
Lighting-Torchiere	assuming 80% incandescent @14LPW goes to CFL @52LPW and 20% CFL stays the same	69%
Electric Water Heaters	heat pump	50%
Refrigerators	assuming 85% standard-size @587kWh AEU with savings of 51% and 15% compact @331kWh AEU with savings of 75%	53%
Electric Space Heaters other than Heat Pumps	heat pump	50%
Electric Clothes Dryers	heat pump	45%
Furnace Fans and Boiler Circulation Pumps	BDCPM variable speed	30%
Electric Cooking Equipments	induction cooktop	12%
Dishwashers	controls and DC compatible motor	51%
Freezers	assuming 80% standard-size @565kWh AEU with savings of 53% and 20% compact @246kWh AEU with savings of 52%	53%
Clothes Washers	BDCPM variable speed	30%
Ceiling Fans	BDCPM variable speed	30%
Spas	Heat pump	50%
Average of total residential load (weighted by consumption, see Table 6)		33%

2.3.2 AC-to-DC Conversion Loss Savings of Appliances Running on Direct DC

2.3.2.1. AC-DC Conversion Efficiencies

In buildings with DC distribution systems, there would be no need to rectify AC power within the appliance, although AC grid power would need to be rectified before being passed to the DC-distribution system at times when solar power was inadequate or unavailable to meet the full needs of the load. The avoided appliance-level conversion losses are estimated based on the conversion efficiencies reported by Energy Star®[31] and 80plus.org[32] for external power supplies, as shown in Figure 14. In general, conversion efficiencies are lower for lower power devices, with efficiencies around 20% at the low end of the figure, and higher for high power devices, with efficiencies around 90% at the high end.

Figure 14. External power supply efficiencies.

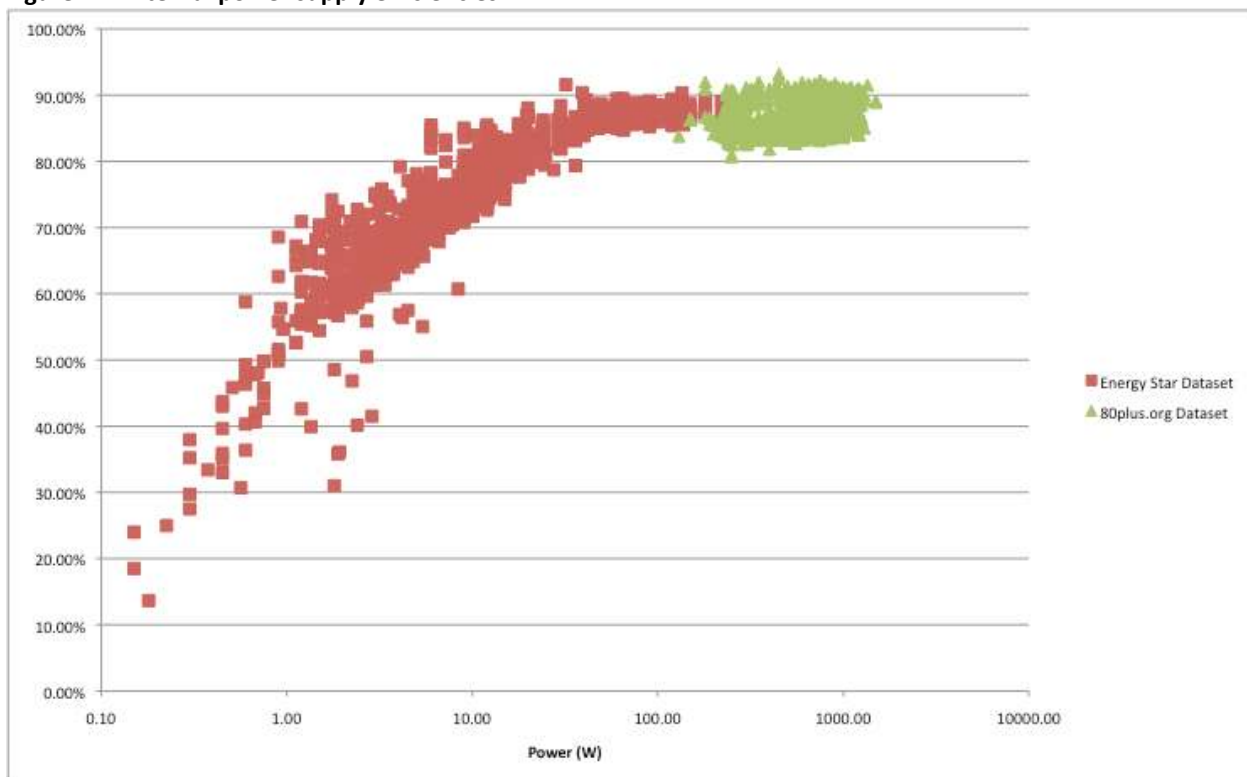

Sources: Energy Star [31] and 80Plus [32] databases.

Table 9 provides a brief summary of the typical power needs for appliances and the corresponding AC-to-DC conversion efficiencies estimated from the external power supply efficiencies at these power ratings.

Table 9. Typical power consumption of appliances and the corresponding AC-DC conversion efficiencies

Appliance	Typical Power (W)	AC-DC Efficiency*
Lighting	11/16/20/30	0.79/0.81/0.82/0.84
TV	3/7 (standby), 45+ (full)	0.85
DVDs/VCRs, home audio, computers	Standby considered	0.69, 0.79, 0.8
Rechargeable electronics	10-20	0.8
Security systems	20-30	0.83
Other	100-2000+	0.87-0.89

*From Figure 14.

2.3.2.2. Quantification of AC-DC Conversion Loss Savings in a Higher Resolution

Using the information from the previous section, we quantify AC-to-DC conversion loss savings in greater detail at the appliance level. For each appliance, a typical product power can be found in [33-35]. The conversion efficiencies at the given wattages are estimated from Figure 14. The results are shown in Table 10. Note that the AC-DC conversion loss savings are for the most efficient DC-compatible replacement technology, as defined in Table 8, not for the standard technology. Therefore, the AC-DC conversion loss savings for incandescent lighting is the avoided AC-DC conversion loss for the compact fluorescent bulb replacement. For most products the conversion loss calculations are straightforward, except for a few products with standby or low power modes, including televisions (TVs), set-top boxes, computers, digital video disc (DVD) players, videocassette recorders (VCRs), and home audio. Calculations for those products are described in the following text.

Table 10. AC-DC conversion loss savings of the most efficient DC-compatible option, by end-use.

Appliance	DC-internal product power (Watts)	Average AC-DC conversion efficiency from Figure 14	AC-DC conversion loss savings
Ceiling Fans	88	0.87	13%
Central Air Conditioners	1900/6500/9200	0.89	11%
Clothes Washers	350-500	0.87	13%
Coffee Makers	900-1200	0.87	13%
Color Televisions and Set-Top Boxes	TV_box:23, TV: 45/100/147/175/286 (full power), 3/7 (standby power)	0.85	15%
Dishwashers	1200-2400	0.88	12%
DVDs/VCRs	See standby/low power	0.69	31%
Electric Clothes Dryers	2790	0.89	11%
Electric Cooking Equipment	Toaster:800-1400, ToasterOven:1225, range(w/oven):12200, others:200-1500	0.88	12%
Electric Heat Pumps	~1000-2000	0.88	12%
Electric Other	CD player: 85, clock: 2, electric blanket: 177, blow dryer: 1000, hand iron: 1100, heating pad: 65, humidifier: 177, vacuum cleaner: 630	0.87	13%
Electric Secondary Space Heaters	PortableHeater:1500	0.89	11%
Electric Space Heaters other than Heat Pumps	~1000-2000	0.88	12%
Electric Water Heaters	~1000-2000	0.88	12%
Freezers	540/700	0.87	13%
Furnace Fans and Boiler Circulation Pumps	750	0.87	13%
Geothermal Heat Pumps	~1000-2000	0.88	12%
Home Audio	See standby/low power	0.79	21%
Lighting-Fluorescent	11/16/20/30	0.79/0.81/0.82/0.84	18%
Lighting-Incandescent	11/16/20/30	0.79/0.81/0.82/0.84	18%
Lighting-Reflector	11/16/20/30	0.79/0.81/0.82/0.84	18%
Lighting-Torchiere	11/16/20/30	0.79/0.81/0.82/0.84	18%
Microwave Ovens	750-1100	0.87	13%

Appliance	DC-internal product power (Watts)	Average AC-DC conversion efficiency from Figure 14	AC-DC conversion loss savings
Personal Computers and Related Equipment	See standby/low power	0.8	20%
Rechargeable Electronics	10-20	0.8	20%
Refrigerators	380/420/600/800	0.87	13%
Room Air Conditioners	1900/6500/9200	0.89	11%
Security Systems	20-30	0.83	17%
Solar Water Heaters	~1000-2000	0.88	12%
Spas	~1000-2000	0.88	12%

2.3.2.3. AC-DC Conversion Efficiencies for Products with Standby and Low Power Mode

A characterization study for electronic loads with standby or low power modes can be found in [36]. In particular, energy use data, including power and energy consumption by mode (standby, low power, idle, active, and so on), are given in the appendices for various devices, including set-top boxes, video game consoles, DVD players, imaging equipment, home audio equipment, computers, and TVs. Another source listing the standby power of different devices is [37].

In the following section, AC-to-DC conversion efficiency by mode is analyzed for home audio, TVs, DVDs/VCRs, and computers. The analysis for other equipment, such as copiers, is omitted because of low energy consumption.

Home Audio: In Table 11, the energy use data for home audio equipment are taken from Appendix J of [36], and the energy efficiencies are as estimated in [31, 32]. Then, the average power supply efficiency is calculated as shown in the table.

Table 11. AC-DC Conversion Efficiency for Home Audio with Standby/Low Power Mode

Mode	Shelf System			Component System			HTIB		
	Active	Idle	Off	Active	Idle	Off	Active	Idle	Off
Power (W)	23	16	7	45	43	3	38	34	0.6
UEC%	23%	15%	62%	58%	25%	16%	67%	28%	4%
Efficiency	0.83	0.81	0.73	0.85	0.85	0.66	0.85	0.84	0.45
Average Efficiency	Sum(UEC% x efficiency)=0.765			0.8111			0.8227		
AEC (TWh/Year)	6.2			6.1			2.2		
AEC%	6.2/(6.2+6.1+2.2)=0.43			0.42			0.15		
Average Efficiency	Sum(AEC% x efficiency)=0.79								

Televisions and Set-Top Boxes: The total energy consumption for color TVs and set-top boxes is 108.13 TWh. From Table F.3 in [36], set-top boxes consume around 20 TWh annually, which is roughly 20% of the total annual energy consumption of TVs and set-top boxes. Also from Table F.3 of [36], power for

active and off mode are almost the same. Thus, for set-top boxes, the average power supply efficiency is 0.83 for an average power of 23W.

For TVs, the standby mode power is around 3W for cathode ray tube (CRT) TVs and almost 7W for rear projection [37], and the corresponding efficiencies are 0.66 and 0.73 respectively. For active mode, the typical power is between 100W and 300W, with an efficiency of 0.87. From Table K.1 in [36], a TV is not in use around 77.7% percent of the time. If we assume an average power of 5W for standby mode and 200W for active, then the energy consumption in standby mode can be estimated as $5 \times 77.7\% / (5 \times 77.7\% + 200 \times 22.3\%) = 8\%$ of a TV's total energy consumption. Therefore, the average power supply efficiency for a TV is roughly $(0.66 + 0.73) / 2 \times 8\% + 0.87 \times 92\% = 0.86$.

Overall, the average efficiency for TVs and set-top boxes is $0.83 \times 20\% + 0.86 \times 80\% = 0.85$.

DVDs/VCRs: We used the average standby mode power for DVDs players and combined DVD-VCRs given in [37], and the corresponding efficiencies are listed in Table 12. From Table K.3 in [36], these devices are used mostly with TVs. Given that a TV is in use 22.3% of the time, we estimated percentages of time for each mode for each device, also in Table 12. As a result, the average efficiency can be estimated as $(0.65 + 0.73) / 2 = 0.69$.

Computers: For computers, we used the power for each mode given in [37], and the efficiencies are listed in Table 13. From Table K.1 in [36], the percentage of time that computers are not in use is 85.6%. Thus, we roughly estimated the time for each mode and calculated the average power supply efficiency for each product, as shown in Table 13.

Table 12. AC-DC Conversion Efficiency for DVDs/VCRs with Standby/Low Power Mode

	DVD Player			DVD/VCR		
Mode	On, not playing	On, playing	Off	On, not playing	On, playing	Off
Power (W)	7.54	9.91	1.55	13.51	15.33	5.04
Efficiency	0.74	0.77	0.59	0.8	0.8	0.71
Time%	5%	5%	90%	5%	5%	90%
UEC%	Power x time% / sum(power x time%) =16.6%	21.9%	61.5%	11.3%	12.8%	75.9%
Average Efficiency	0.65			0.73		

Table 13. AC-DC conversion efficiency for computers with standby/low power mode.

	Mode	Power (W)	Efficiency	Time%	UEC%	Average Efficiency
CRT Display	Off	0.8	0.49	85%	8.7%	0.83
	On	65.1	0.87	10%	83.5%	
	Sleep	12.14	0.79	5%	7.8%	
LCD Display	Off	1.13	0.54	85%	25.3%	0.76
	On	27.61	0.84	10%	72.8%	
	Sleep	1.38	0.56	5%	1.8%	
Desktop	On, idle	73.97	0.87	10%	68.1%	0.82
	Off	2.84	0.66	85%	22.2%	
	Sleep	21.13	0.82	5%	9.7%	
Notebook	Fully on, charged	29.48	0.84	5%	12.5%	0.79
	Fully on, charging	44.28	0.85	5%	18.7%	
	Off	8.9	0.76	80%	60.2%	
	Power supply only	4.42	0.69	5%	1.9%	
	Sleep	15.77	0.8	5%	6.7%	

To estimate the overall average power supply efficiency of computers, we assumed that 50% of desktop monitors are CRTs and 50% are liquid crystal displays (LCDs) and a notebook generally has its own display. Then, for a system that includes a desktop computer with a CRT or LCD display, the fraction of energy consumption coming from the desktop is: 65.2%,

while the CRT displays consume 23.4%, and the LCD displays consume 11.4%. Thus, the average power supply efficiency for such a system is 0.82. Finally, we average between this and the efficiency of 0.79 for notebooks and estimate the overall average AC-DC conversion efficiency for computers as 0.8, indicating a direct-DC energy savings of 20%.

2.3.3 Summary of AC versus DC Product Energy Use

Table 14 summarizes, in column A, the percent energy savings anticipated from switching from standard appliances to the most efficient DC-compatible alternative that is running on AC and, in column B, the avoided AC-DC conversions losses in the DC-appliance. The bottom row of the table gives the average savings, weighted by 2010 residential energy consumption, as reported in Table 6. Large energy savings are possible (~33%, residential weighted average) just by switching to DC-compatible appliances, even if they are running on AC. But these efficiency improvements are likely to be adopted whether or not direct-DC is adopted. Therefore, while they enable direct-DC, we do not credit these energy savings. But, if supplied by direct-DC, the avoided AC-to-DC conversion losses will result in further savings. The average AC-to-DC conversion losses are about 14% for residential appliances and will be lower for commercial appliances to the extent that they are larger than residential appliances. Again, it is the combination of these avoided AC-to-DC conversion losses, along with the different losses in the AC versus DC PV power systems configurations that determines the net energy savings of direct-DC, as documented in the companion report [1].

Table 14. Estimated percent energy savings from switching from the standard appliance to the most efficient DC-compatible appliance run on AC, and from avoided AC-DC conversion losses in the DC-appliance.

Appliance	(A) Energy savings from switching to DC-compatible run on AC	(B) Energy Savings from avoided AC-DC power conversion losses
Lighting-Incandescent	73%	18%
Lighting-Reflector	71%	18%
Lighting-Torchiere	69%	18%
Refrigerators	53%	13%
Freezers	53%	13%
Dishwashers	51%	12%
Electric Water Heaters	50%	12%
Electric Space Heaters other than Heat Pumps	50%	12%
Spas	50%	12%
Central Air Conditioners	47%	11%
Electric Clothes Dryers	45%	11%
Room Air Conditioners	34%	11%
Furnace Fans and Boiler Circulation Pumps	30%	13%
Clothes Washers	30%	13%
Ceiling Fans	30%	13%
Electric Cooking Equipments	12%	12%
Lighting-Fluorescent	1%	18%
Home Audio	0%	21%
Personal Computers and Related	0%	20%
Rechargeable Electronics	0%	20%
DVDs/VCRs	0%	31%
Security Systems	0%	17%
Color TVs and Set-Top Boxes	0%	15%
Coffee Makers	0%	13%
Electric Other	0%	13%
Microwave Ovens	0%	13%
Electric Heat Pumps	0%	12%
Geothermal Heat Pumps	0%	12%
Solar Water Heaters	0%	12%
Electric Heat Pumps	0%	12%
Geothermal Heat Pumps	0%	12%
Electric Secondary Space Heaters	0%	11%
Average savings (consumption weighted)	33%	14%

3. DC Power Systems

To understand the energy and economics of DC-distribution power systems, this section first gives an overview of DC energy supply technologies and fuel cells, then addresses DC power system components and DC power delivery systems, and finishes with a brief overview on home energy managements systems.

3.1. DC Energy Supply and Fuel Cells

This section provides a brief introduction to renewable energy supply technologies that are used as DC sources for building-sited generation. While wind energy dominates centralized renewable energy generation, PVs dominate building-sited installations. According to representatives of Real Goods, one of the largest and oldest vendors and installers of building-sited renewable energy systems and components in the United States, Real Goods sales and installations break down approximately as follows:

- 95% solar (>95% grid-integrated),
- 3% micro-hydro, and
- 2% micro-wind.

In a net-metered context we consider these sources to be relatively indifferent to AC versus DC distribution—although adoption of DC power standards would likely influence voltage output design.

The following sections give a brief introduction to relevant aspects of the technologies and markets for residential and small commercial renewable energy supply, focusing primarily on PVs, which will continue to dominate the building-sited renewable energy market for the foreseeable future. In addition to solar, micro-hydro and wind, we also provide a brief introduction to fuel cells, which, while not a renewable energy source, act like a source.

3.1.1 PV Modules

3.1.1.1. The PV Market:

Electronic Appendix AE-X documents the characteristics of over 250 PV modules made by more than 30 domestic and international manufacturers that meet the *Guidelines for California's Solar Electric Incentive Programs*.^[38] Module power outputs, summarized in the histogram in Figure 15a, range from 20W to 380W, but generally cluster in the range of 150W to 250W. Rated module voltages, summarized in the histogram in Figure 15b, range from 11V to 93V, but almost all are in the range of 30V to 50V.

California dominates the U.S. solar energy market—having two-thirds of the total U.S. grid-tied PV capacity; it was the locale for a full half of the total U.S. capacity installed in 2009 [39]. While many producers sell PV modules into the California market, a small handful dominate. As shown in Table 15,

twelve companies constitute 90% of California’s sales, but two, SunPower and Sharp, together make up 41% of the total.

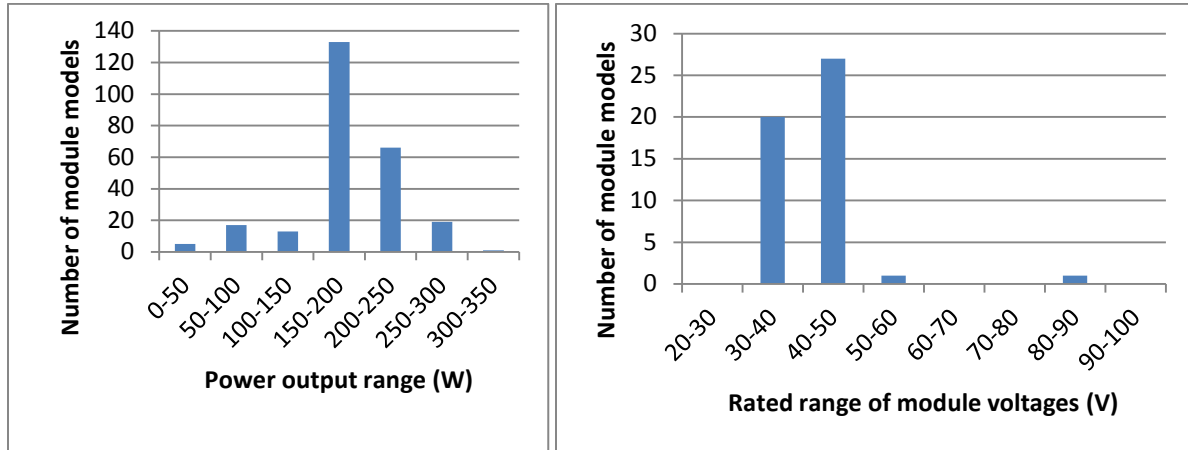

(a) (b)
Figure 15. Rated power output (a) and voltages (b) of PV modules satisfying the Guidelines for California’s Solar Electric Incentive Programs.
 Data source: [40].

Table 15. Market share of PV modules used in California PV systems (grid-connected residential and commercial) installed under the California Solar Initiative that are up to 30kW (nameplate).

#	PV Module Manufacturer	Market Share
1	SunPower	22%
2	Sharp	19%
3	BP Solar	8%
4	Kyocera Solar	8%
5	Evergreen Solar	7%
6	Sanyo Electric	6%
7	Suntech Power	5%
8	SolarWorld	3%
9	Andalay Solar	3%
10	Mitsubishi Electric	3%
11	REC Solar	3%
12	Canadian Solar	3%
	Total	90%

Data source: CPUC [40]. Data for all CSI program years were used in this analysis (>43,800 data points).

3.1.1.2. Module Efficiencies:

For the same dataset, module efficiencies are plotted in Figure 16a,b, which shows both a histogram of module efficiencies and the breakdown of module efficiency by cell technology type—amorphous silicon, cadmium telluride, monocrystalline, polycrystalline, and ribbon. Efficiencies have increased only

very slowly over the years, with most of the models and technologies in the 11 – 15% range and still being produced with polycrystalline and monocrystalline silicon cells.

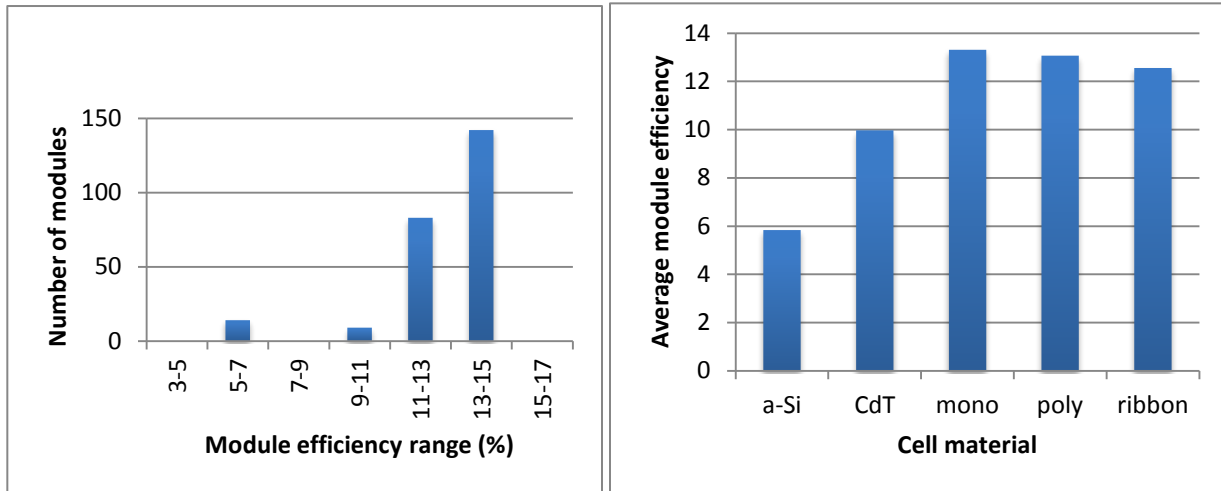

(a) (b)
Figure 16. Efficiencies of PV modules satisfying the *Guidelines for California’s Solar Electric Incentive Programs*. (a) Histogram of modules by efficiency, (b) Efficiency by cell type (amorphous silicon (a-Si, n=11), cadmium telluride (CdT, n=6), monocrystalline (mono, n=87), polycrystalline (poly, n=127), and ribbon (n=17). Source: [38]

3.1.1.3. Lifetime and Reliability:

Single crystalline and multiple crystalline silicon modules come with a 25-year standard guarantee and a 35-year useful life, as long as the voltage at maximum power is greater than the minimum voltage required of the load. PV modules are highly resistant to damage from infrared (IR) and ultraviolet (UV) radiation, though ultimately amperage is affected by opacity in the glass, scratching, and degradation of cell material. Old PV modules may still be useful for running pumps and fans and for low-voltage battery recharging. Most PV modules now come with Underground Service Entrance (USE-2) wire leads and Multiple Contact (MC) connectors for high voltage rating, UV protection, watertight connections, and abrasion resistance.

3.1.1.4. Mounting and Trackers:

While the vast majority of building-sited PV installations are rack roof-mounted systems, or secondarily fixed ground mounts, single and dual axis tracking mounts are available, both manual and automated. Field experience has shown that manual trackers are more reliable than automated ones, and fixed roof or ground mounts are more durable than tracking mounts. The higher the latitude (in the Northern hemisphere, and vice versa in the Southern Hemisphere) the more important tracking the sun becomes. Electronic maximum power point tracking (MPPT) devices—now incorporated in most inverters—results in greater average returns than does physically tracking in locations from the equator to 40 degrees either north or south of the equator. Integrating the mounting system into the building structure itself is a continuing trend. The expected lifespan of a well-designed tracking system is 35-50 years, which is

about the maximum lifespan of most roof systems. There are ballasted roof systems available for flat roofs that do not require roof penetrations, which might leak over time.

3.1.1.5. PV Prices

Figure 17 plots wholesale prices of PV modules, on a \$/W basis, as a function of the rated power output of the module, based on the dealer's wholesale price list for SunWize Technologies and DC Power Systems. The data demonstrate a fairly clear trend of declining normalized price with increasing module capacity. Based on these data, 150 – 250 W modules (the group into which the vast majority of the models certified by California's solar electric incentive programs fall) wholesale for \$2.7/W on average.

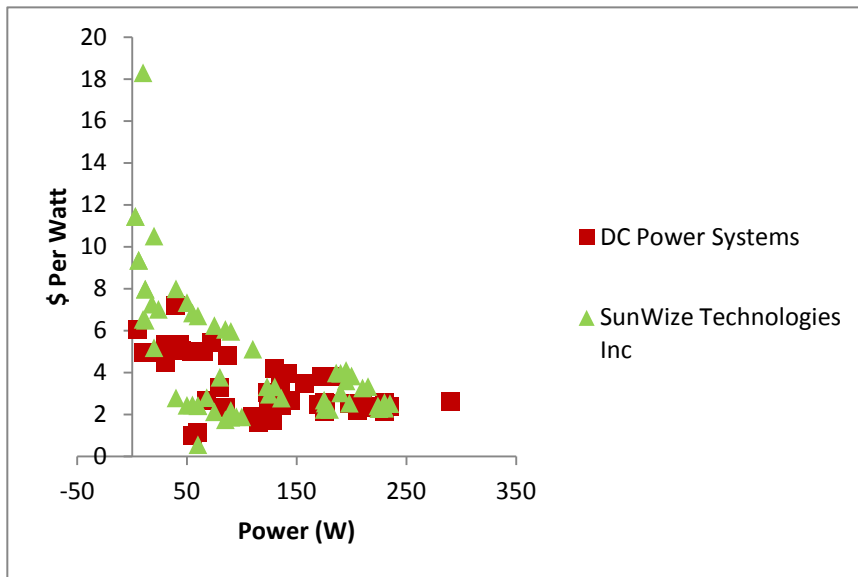

Figure 17. PV module wholesale price decreases with power.

Data source: DC Power Systems wholesale price list as of 5/3/2010 [41]. SunWize Technologies Inc wholesale price list as of 5/12/2010[42].

PV module prices have fallen relatively steadily since their introduction into the building energy market. According to Solarbuzz's price index, U.S. wholesale prices (\$/W) have fallen on average by about 5.7%/yr, with some interruption widely attributed to supply and demand dynamics (see Figure 18). Costs should continue to decline, because of economies of scale, production-learning effects, expansion of production in Asia, and because of continued research and development (R&D) focused on lowering the production cost of semiconductor materials (like amorphous silicon and ribbon production).

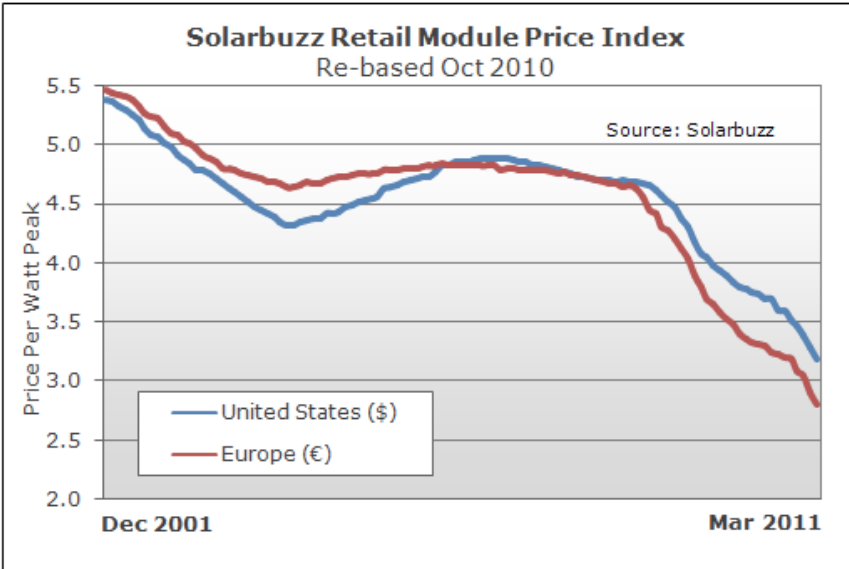

Figure 18. Historical decline in PV module prices.
Reproduced with permission from Solarbuzz [43].

3.1.2 Wind Turbines

3.1.2.1. The Wind Turbine Market

While the past decade has witnessed the adoption of building-sited wind turbines, the opportunity for building-sited wind turbine capacity is inherently more limited than for solar, and the technology is less friendly to building integration. Building surfaces slow and disrupt near-surface wind flow, making the building-sited resource difficult to predict without long-term measurements, and the vibrations and noise make the technology far more intrusive than PV, as evident from a recent UK study [44]. While incorporation of relatively large turbines on skyscrapers offers a dramatic architectural opportunity (see Figure 19a), the opportunities are limited. Significant growth in building-sited wind capacity is more likely to result from the use of micro-turbines, as shown in Figure 19b or in rural two-tower mounted applications, as has been the case to date. According to industry experts, current installations are approximately evenly split between on-grid and off-grid.



(a)

(b)

Figure 19. Building-sited wind turbines.

(a) Bahrain World Trade Center, built in 2008, incorporates three 225W turbines into its design, (b) urban microturbines designed by AeroVironment [45].

Home Power magazine's 2010 *Wind Generator Buyer's guide* compares the prices and specifications of small tower-mounted wind turbines [46]. While designed for tower mounting, these models are of a size range that might be used for residential and small commercial applications. Table 16 summarizes model and cost information on nine models; the tower and installation are not included in the cost. While smaller capacity models tend to cost more per unit capacity than larger models, the relationship is relatively weak in this size range. While typical generators produce AC output, that can be and frequently is rectified for off-grid use with battery backup. Of the 25 systems reported in [46], 15 were designed to include backup battery storage.

3.1.2.2. Wind Turbine Lifetime

Being dynamic mechanical devices, the lifetime of wind turbines is inherently and considerably shorter than that of PV modules, a fact that is reflected in their warranties. Whereas PV warranties are typically 25 years, wind turbine warranties are generally 5 years (see [46]). Their mechanical nature also means that maintenance requirements and costs are higher for wind generation.

Table 16. Manufacturers and prices of small wind turbines designed for grid connected applications. Most provide for integrated battery storage.

Manufacturer	Model	Capacity (kW)	Cost	\$/W	Manufacturer website
Kestrel	e300i	1.0	\$6,440	\$6.44	www.kestrelwind.co.za
Raum	Raum 1.3	1.3	\$3,650	\$2.81	www.raumenergy.com
Cascade Wind	ARE 110	2.5	\$12,650	\$5.06	www.cascadewindcorp.com
Kestrel	e400i	3.0	\$11,178	\$3.73	www.kestrelwind.co.za
Raum	Raum 3.5	3.5	\$7,000	\$2.00	www.raumenergy.com
Fortis	Montana	5.0	\$15,800	\$3.16	www.fortiswind.com
Cascade Wind	ARE 442	10.0	\$39,600	\$3.96	www.cascadewindcorp.com
Fortis	Alize	10.0	\$31,100	\$3.11	www.fortiswind.com
Bergey Windpower	Excel-S	24.0	\$29,500	\$1.23	www.bergey.com

Sources: [46] and manufacturers websites.

3.1.3 Microhydro

While microhydro is relatively low cost at good sites, the opportunity to use microhydro for building-sited renewable energy is limited by the need for a nearby water body with appropriate head (elevation differential between intake and turbine) and flow. As with wind turbines, the output of the generator is inherently AC. Output can be rectified DC, regulated AC, or uncontrolled (though the latter would be inappropriate for standard building energy uses). According to industry experts, the vast majority of microhydro gets installed off-grid, and may or may not be eligible for grid-interaction under state net met-metering laws (e.g. microhydro is not eligible in California). Because of its niche applicability, primarily for off-grid applications, the technology has limited potential to contribute significantly to the future of direct-DC [47].

3.1.4 Fuel Cells

Fuel cells convert the chemical energy of a fuel into electric energy, creating a DC output voltage and heat in the process. Though still rare, stationary fuel cells are used as a co-generation power plant in some hospitals, universities and large office buildings, providing a backup power supply. In that context, a methane reformer is used to convert natural gas to hydrogen, which fuels the actual cell. In the context of renewable energy supply, fuel cells are often envisioned as part of an energy storage scheme in which electricity from a renewable energy source splits hydrogen from water, which is stored and later used by a fuel cell to generate electricity. Though the viability of the concept has long been demonstrated –Humboldt State University’s Schatz PV Hydrogen Project has operated such a system for more than two decades [48]— cost is seen as a major barrier to commercialization, and there appears to be little activity in that area. Therefore, from the perspective of renewable-energy-based DC-power, fuel cell technology would have limited application for the foreseeable future, other than as a natural gas-supplied backup system.

3.2. Power System Components

This section introduces the main power system components that are used today in grid-connected AC power systems and those that could be used in the future in their direct-DC counterparts. These include inverters (uni- and bi-directional), DC-DC converters, MPPT, charge controllers, and batteries.

3.2.1 Grid-Interactive Inverter (AC Building)

Grid-interactive inverters convert DC coming from the PV array into AC synchronous with the grid. To maximize PV system efficiency, modern grid-interactive inverters include MPPT (described below). This section addresses only inverters designed for grid-connection and net-metering, including battery backup and non-battery back-up inverters. The latter dominate the market, a situation that is unlikely to change without incentives if electricity prices stay low. Grid-interactive (or grid-tie) models are further divided to central inverters and micro-inverters.

3.2.1.1. Grid-Interactive Inverter, no Battery Backup

Description

Typical Operation:

Residential PV systems generally have a single central inverter that converts the entire array's DC power to AC. To reduce transmission losses, current central grid-tie inverters are designed to accept high voltage DC inputs, thus allowing relatively large PV panels to connect in series or 'strings' (hence, the alternate term *string inverter* for central inverters). A relatively new alternative to central inverters are micro-inverters, which attach to each PV module with the purpose of optimizing power output at the module level by tracking each module's maximum power point.

Power Characteristics:

Central inverters have wide ranges of input voltages that can reach $600V_{DC}$ ³. This allows PV system designers to have a broad selection of PV modules and string configurations. Micro-inverters have relatively low input voltages but are compatible with most commercially available PV modules. Output voltages depend on the utility voltage that inverters synchronize with. Most inverters used in U.S. residential and small commercial applications have a 120V/240V_{AC} output voltage. A characteristic of grid-tie inverters is that they are programmed to shut down if they detect an *island*, that is, when the grid is not present. This provision protects utility personnel from PV power being transmitted to the grid during a power outage.

Lifetime:

An inverter is expected to be replaced at least once during the lifetime of a residential PV system (25-30 years). During the past few years, however, central inverter manufacturers have increased inverter

³ Input voltages in residential PV applications higher than $600V_{DC}$ are not permitted in the United States because they violate the National Electrical Code (NEC) requirements. Maximum inverter input voltage is determined by a string's total maximum open circuit voltage (V_{oc}).

warranties⁴ to 10 and up to 15 years for some models. Micro-inverter manufacturer Enphase Energy [49] offers a 15-year warranty and claims a usable lifetime of more than 20 years.

Price:

Grid-tie inverters for residential systems are responsible for about 9% of the total installed cost of a residential PV system [50] and cost about \$0.7-\$0.8/Watt [43] for systems as shown in Figure 20.

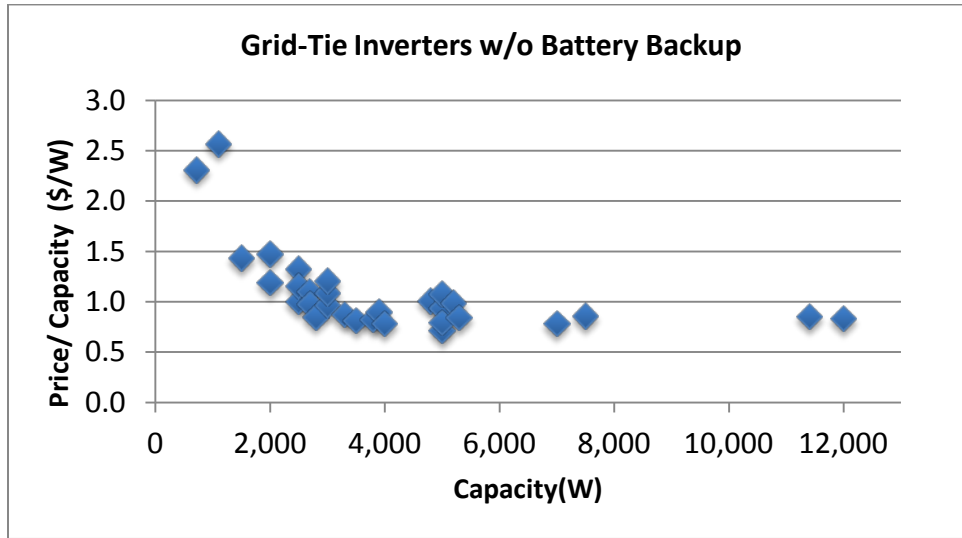

Figure 20. Retail price curve for grid-tie inverters without battery backup (2010 data).

For small inverter capacities, prices are relatively higher. As inverter capacity increases, prices tend to stabilize. Data Source: AEE Solar [51]

Market status: Mature

Increasing inverter life spans, extended factory warranties, reduced prices, and higher efficiencies are indicators of the rapidly expanding inverter market. Several inverter manufacturers exist but the market is currently controlled by only a small number of companies. As shown in Table 17, 6 companies claim 95% of the market share in California, one of which (Enphase Energy) is a micro-inverter manufacturer⁵.

⁴ An important driver for this development has been the California Solar Initiative requirement for a minimum 10 year warranty for eligible equipment.

⁵ Enphase Energy micro-inverters made their appearance in the California market halfway through the CSI program. Thus, their market share during the past two years is considerably higher than the reported 8%, which corresponds to the total duration of the program up to March 2011.

Table 17. Market share of grid-interactive inverters used in California PV systems (residential and commercial) installed under the California Solar Initiative that are up to 30kWDC.

#	Inverter Manufacturer	Market Share
1	SMA America	36%
2	SunPower	20%
3	Fronius USA	18%
4	Enphase Energy	8%
5	PV Powered	7%
6	Xantrex Technology	7%
	Total:	95%

Data source: CPUC [40]. Data for all CSI program years were used in this analysis (>43,800 data points).

Efficiency:

Manufacturers have reported grid-interactive peak efficiencies of more than 98%. Probably a better inverter efficiency metric is the *weighted* efficiency as established by the California Energy Commission’s (CEC’s) test protocol. Because inverter performance depends on load conditions, the CEC weighted efficiency corresponds to the weighted average efficiency for various inverter input power points. Weighted efficiencies are generally about 1-2% lower than manufacturer peak efficiencies. According to the CEC’s list of eligible inverters for the California Solar Initiative, grid-interactive inverter efficiencies with capacities up to 10kW range between 84.5% and 98% [52]. The efficiency curve of the SMA America SB7000US (7kW) inverter, shown in Figure 21, reveals how efficiencies plummet at very low loads.

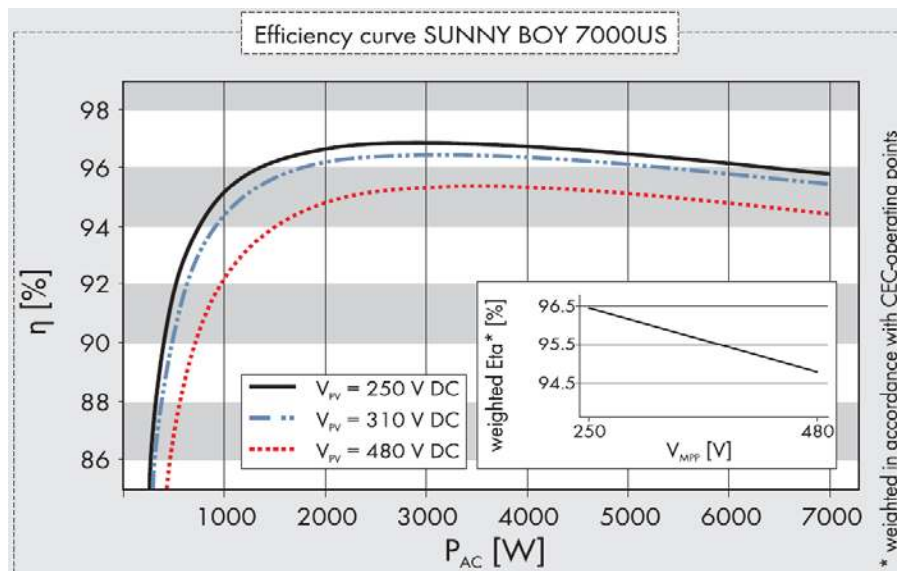

Figure 21. Efficiency curve for the SMA Sunny Boy 7000US string inverter (with MPPT).

The efficiency peaks after 30% load to 96-97%. Part-load efficiency (below 1000Watts power capacity) ranges between 88 and 94%. Data Source: SMA [53]. Reproduced with permission from SMA-America.

3.2.1.2. Grid-Interactive Inverter with Battery Backup

Description

Typical Operation:

Inverters with battery backup convert DC power coming from the battery, or directly from the PV array, to AC power sent to the loads or the grid via net-metering. These devices have two important differences to their non-storage counterparts: They have a built-in rectifier to convert AC grid-power to DC required for battery charging. On the other hand, unlike most inverters without battery backup, battery backup inverters do not include MPPT, as this function is performed by an upstream-located charge controller. Thus, these devices act as bi-directional inverters (discussed below).

Power Characteristics:

Battery back-up inverters have low voltage inputs that are usually 24 or 48V_{DC}⁶. They conform to anti-islanding requirements by disconnecting from the grid but do not shut down completely; they continue to invert power either from the PV array or the batteries to pre-assigned critical loads, similarly to an uninterruptible power supply.

Lifetime:

These inverters have more components than their non-battery counterparts and therefore have a higher probability of failing. Outback Power offers a 2-year standard warranty and an extended 5-year warranty on its models but also offers a 10-year warranty in California, as required by the California Solar Initiative (CSI) program.

Price:

Prices for battery back-up inverters are similar to inverters without battery backup. However, peripheral equipment, such as batteries, charge controllers, ground fault protectors, as well as additional wiring labor, can increase considerably the cost of renewable energy systems with storage. Table 24 shows pricing information for popular inverters with battery backup in the U.S. market.

Table 18. Pricing information for Outback Power and Schneider Electric inverters with battery backup.

Manufacturer	Model	Capacity (kW)	Retail Price (\$)	Price per capacity (\$/W)
Outback Power	GTFX2524	2.5	2,369	0.95
Outback Power	GTFX3048	3.0	2,369	0.79
Outback Power	GTFX3524	3.5	2,569	0.73
Outback Power	GTFX3648	3.6	2,569	0.71
Schneider Electric	XW4024	4.0	3,250	0.81
Schneider Electric	XW4548	4.5	3,600	0.80
Schneider Electric	XW6048	6.0	4,500	0.75

Source: AEE Solar [51]

⁶ Because PV systems with battery backup include charge controllers and batteries powered typically at 24 or 48V_{DC}, inverter voltages match the charge controller/battery voltage.

Market Status: Emerging

The market share of battery backup inverters is only about 2% of the total grid-interactive inverter market. Customer concerns over the reliability of the utility coupled with uninterruptible power requirements for medical equipment, refrigeration, and other critical loads are driving this demand despite the higher price per system. Outback Power and Schneider Electric are considered the two leading manufacturers in the U.S. market. Once advanced battery technology becomes widespread, this sector is expected to increase its market share.

Efficiency:

Efficiencies of inverters with battery backup are generally lower than their non-battery counterparts. Outback power offers models with weighted efficiencies of 91%. Princeton Power Systems recently developed a 100kW inverter with battery backup with a 98% peak efficiency and a 94.5% weighted efficiency [54].

3.2.2 DC-DC Converter (DC Building)

Description

Typical Operation:

DC-DC converters are solid-state devices that convert DC power from one voltage level to another and are found in appliances with electronic circuits. The function of the DC/DC converter, as shown in the DC-house of Figure 3 and Figure 5, is to step-down the main bus voltage from 380V_{DC} to 24V_{DC} to supply energy for low power loads. This DC-DC converter currently does not exist specifically for residential applications, but is in the research/design stage.

Power Characteristics:

DC-DC converters are generally produced for low power, low voltage applications. The DC-to-DC converter envisioned for the DC-building is a high power converter (1 - 5kW) that requires an input voltage of 380V_{DC} and output of 24V_{DC}. Because this converter ties directly to the loads, it is likely to need isolation from the ground, though the relevant standards have not yet been established.

Lifetime:

Manufacturers of high power DC-DC converters used for harsh applications, shown in Table 19 below, offer a two- to three-year warranty, while some claim a service life of 10 years. Evidently, a building-sited DC-to-DC converter installed under stable conditions should have a significantly longer lifetime, comparable to other building electrical distribution equipment.

Price:

It is assumed that the cost of the DC-DC converter will be comparable to the cost of switch-mode AC power supplies with similar capacities, which are used in data centers. On the one hand, the cost could be expected to be less, due to the simpler electronic circuitry of DC-DC converters—no rectification is needed—compared to AC power supplies. On the other hand, the cost could be expected to be greater, due to the more expensive DC receptacle and potential isolation requirements, which are expected to affect both capital and installation costs.

Market Status: R&D

As was mentioned, a DC-DC converter is not currently available for direct-DC building applications. However, high power DC-DC converters are available for marine, industrial, and military applications that involve stresses, vibrations, and humidity. Table 19 presents a few high power DC-DC converter models built for such harsh environments.

Table 19. High power DC-DC converter models built for harsh environments.

Manufacturer	Model	Power (kW)	Input Voltage Range (V)	Output Voltage Range	Peak Efficiency (%)	Web Site
Absopulse Electronics	BAP 5K	5.0	Min:24 Max:145	Min:12 Max:300	94	www.absopulse.com
Analytic Systems	VTC1000	1.0	Min:110 Max:360	Min:12 Max:48	85	www.analyticsystems.com
Mean Well	SD-1000	1.0	Min:19 Max:72	Min:12 Max:48	92	www.meanwell.com
Schaefer Power	Series C / B 5200	5.0	Min:80 Max:800	Min:5 Max:400	95	www.schaeferpower.com
TDI Power	Mercury Series	0.8-4.3	Min:90 Max:300+	Min:12 Max:390	<93	www.tdipower.com

In addition, high power DC-DC converters (DC power supplies) with similar characteristics to those needed for direct-DC are currently under development for data centers that utilize DC distribution. For example, Validus DC Systems [55] is developing a high power (30kW) DC-DC converter with 300-600V_{DC} input and 54V_{DC} output to be used in a DC data center power system.

Efficiency:

Step-down converters are highly efficient electronic devices with efficiencies that typically reach 95%. Figure 22 shows the efficiency curve of an existing 700Watt power supply for different power inputs. According to power supply manufacturers, it should be possible to manufacture more efficient DC-DC converters now. As shown in Figure 22, the power supply is about 2% more efficient with DC power input (400V_{DC} narrow range) than with AC power input (220V_{AC}). High-end AC power supplies can achieve efficiencies that exceed 92-93%. Thus, it is assumed that DC power supplies can reach efficiencies of 94-95% at the high end.

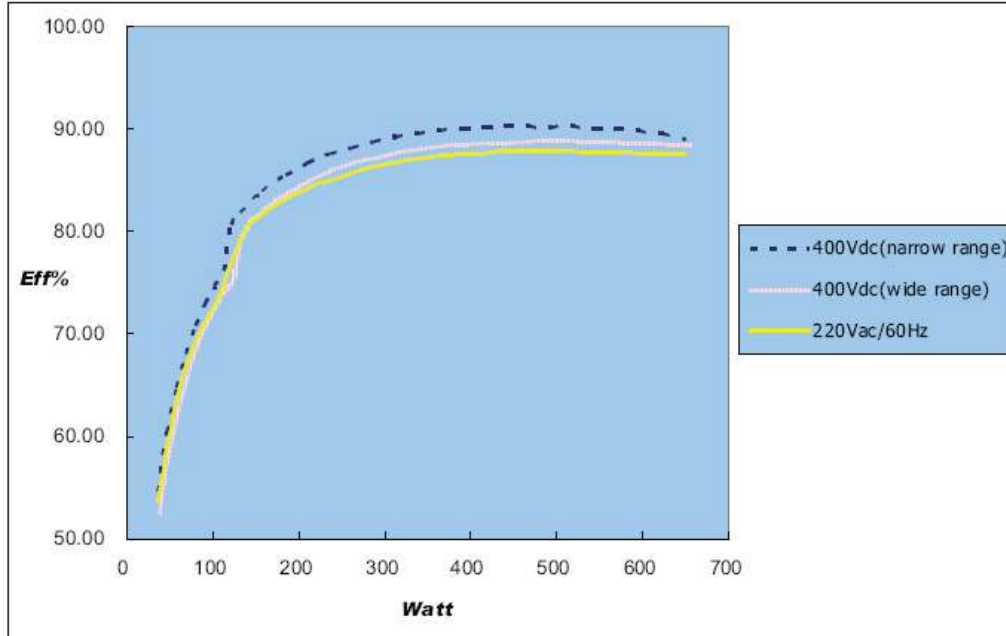

Figure 22. DC data center power supply efficiency curve.

The power supply's peak efficiency with DC power input (narrow range 400VDC) is 2% higher than with AC power input (220VAC). Reproduced with permission from the author [56].

3.2.3 Bi-Directional Inverter (DC Building)

As presented in Figure 3 and Figure 5, the bi-directional inverter serves to both rectify (AC-DC) power from the grid to the building distribution system and invert (DC-AC) excess power from the PV system or the battery to the grid. In this case, the inverter is assumed to not include MPPT since this has already been dealt with, either by the MPPT or the charge controller, as discussed below.

3.2.4 MPPT (DC Building)

Description

Typical Operation:

An MPPT is a high efficiency DC-to-DC converter that adjusts the apparent load characteristics seen by the PV array to force it to operate at maximum possible power output and produces the constant output voltage required by the load. Because the voltage and current supplied by the PV system depend on ambient conditions, the DC power coming from the array must be conditioned to provide appropriate power quality for the load. MPPTs achieve this while ensuring that the PV system operates at its maximum power output for the given solar conditions. From the PV system's perspective the MPPT adjusts the apparent resistance of the loads to push it to its maximum power point. From the load's perspective, the MPPT is supplying the appropriate voltage to operate optimally. The DC-building MPPT, as shown in Figure 3, is a central device that receives power directly from the PV array and converts it to 380V_{DC}. This device does not currently exist in the market but is in the R&D stage: The Center for Power Electronic Systems at Virginia Tech [57] is researching the development of a centralized or string-level

MPPT that interfaces directly with a residential PV system and provides 380V_{DC} power directly to the building loads.

Power Characteristics:

MPPTs are usually included in grid-tie inverters without battery backup (central and micro-inverters) and modern charge controllers. Recently, MPPTs have been developed that are separate devices that attach to individual PV panels. These devices are called DC-to-DC optimizers and have similar attributes to micro-inverters (simpler system design with MPPT and monitoring at the module level). Thus, a wide range of operating parameters for MPPTs exists, depending on the application. Input voltages range from 12V_{DC} in small charge controllers to 600V_{DC} in grid-tie inverters, and capacities range from a few watts in DC-DC optimizers to several kW in large grid-tie inverters. MPPT output voltages often range between 12V_{DC} and 48V_{DC}, depending on battery bank configuration.

Lifetime:

MPPT failure in grid-tie inverters is not a common occurrence. Thus, the lifespan of MPPTs is expected to be longer than that of grid-tie inverters. Most DC-DC optimizers are offered with 20-25 year warranties.

Price:

The cost of the DC-Building MPPT is expected to be lower than the cost of similarly sized charge controllers, because there are fewer components associated with the device.

Market Status: Emerging

Although MPPT technology is relatively mature, MPPTs have only recently emerged that take the form of DC-DC optimizers. Table 20 shows power characteristics and efficiencies of DC-DC optimizer models.

Table 20. DC-DC optimizer models, their power characteristics and reported peak efficiencies.

Manufacturer	Model	Input Power (W)	Max Input Voltage (V)	Nominal Output Voltage (V)	Peak Efficiency (%)
eIQ energy	Vboost 250	250	50	250-350	98.0
National Semiconductor	SM1230	230	100	89	98.5
Tigo Energy	MM-EP35	200	55	375	97.5
Tigo Energy	MM-ES170	300	170	variable	99.6
Xantrex	SunMizer	350	80	65	>99.0

Data Source: SolarPro magazine [58]

It should also be noted that Nextek Power Systems has produced an MPPT for DC power distribution in commercial lighting applications; their NPS-R1000 MPPT [59] has a 1kW capacity, 95V_{DC} maximum input voltage, and 57.5V_{DC} maximum output voltage.

Efficiency:

As seen in Table 20, MPPT efficiencies range between 97.5% and 99.5%. The Nextek MPPT has a 98% reported efficiency. (See Figure 23 for an efficiency curve of a charge controller with MPPT.)

3.2.5 Charge Controller (AC & DC Building)

Description

Typical Operation:

Charge controllers are used in battery back-up systems and regulate the current sent to or coming from the battery. Thus, a charge controller with MPPT performs the functions of an MPPT with the addition of current control. The AC-building charge controller shown in Figure 4 regulates current to and from the battery and supplies the inverter with DC power. The DC-building charge controller shown in Figure 5 interacts similarly with the battery but supplies power directly to the loads at 380V_{DC}.

Power Characteristics:

The range of operating parameters for the charge controller is similar to the MPPT described above. Battery current ranges between 4.5A and 80A for most commercially available charge controllers.

Lifetime:

Product lifetime for high-end charge controller models is 16 to 25 years, certainly in the same range as the warranted life of PV modules. However, according to field experience of industry experts, product lifetime can be significantly shorter for certain models. It should be noted that, in the case of a charge controller failure, the batteries are often destroyed, and thus system repair costs can increase significantly.

Price:

Table 21 shows prices and power characteristics for popular charge controllers with MPPT.

Table 21. Pricing information on charge controllers with MPPT.

Manufacturer	Model	Max Output Current (A)	Max Input Voc (V)	Retail Price (\$)
Apollo	T80	80	140	849
Apollo	T80HV	80	200	949
Morningstar	TriStar-MPPT-45	45	150	531
Morningstar	TriStar-MPPT-60	60	150	669
Morningstar	SunSaver	15	75	292
Outback	Flexmax-60	60	150	749
Outback	Flexmax-80	80	150	849
Xantrex	XW-MPPT60-150	60	150	650

Market status: Emerging

The charge controller market is currently controlled by a small number of companies and, reportedly, product quality varies. It is expected that as demand for battery back-up renewable energy systems increases in the future, charge controller market share and product reliability will increase as well.

Efficiency:

Typical efficiencies of high-end charge controllers with MPPT range from 97% to 99%. Figure 23 shows the efficiency curve of the Morningstar SunSaver charge controller, which has a peak efficiency of 97.5%.

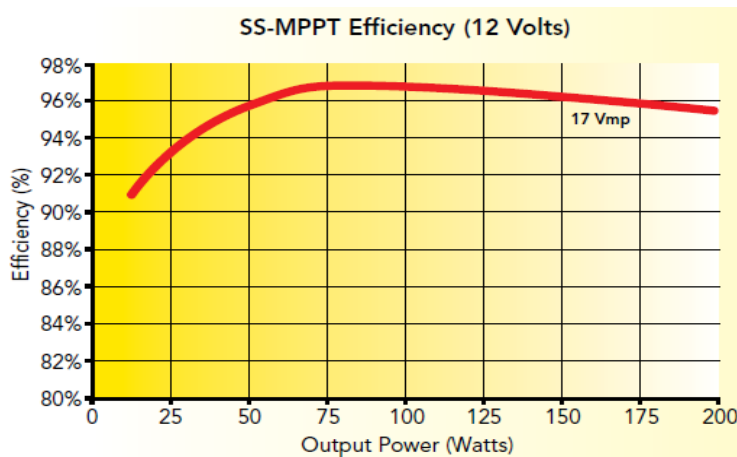

Figure 23. Efficiency curve of the MorningStar SunSaver charge controller with MPPT.

Part load efficiency (below 30W output power) is about 92-94%. Source: [60]. Reproduced with permission from MorningStar Corp.

3.2.6 Batteries (AC & DC Building)

Description

Typical Operation:

Electricity storage systems for grid-connected buildings are typically designed to provide power to critical loads in the event of a grid power outage. In the future, if high penetration of PV is to be attained, then batteries may be needed to buffer the grid from peak solar output. Batteries are the only viable choice for storage for residential and small commercial applications, given the cost of competing technologies, although flywheels have been used for short-term storage in data center applications. Batteries are powered via a charge controller from the PV system during periods of excess PV generation and are discharged to the building loads when the grid is not available or during periods of cloud cover. Many promising battery technologies are currently available including nickel-cadmium, metal-hydrate and lithium-ion. However, the industry norm remains lead-acid batteries, due to their low capital costs and maintenance requirements. For this reason, we focus this discussion on lead-acid batteries.

Power Characteristics:

Lead-acid battery banks are composed of individual battery cells, which operate at 2V nominal voltage. Other technologies, such as lithium-ion, have cells that operate at 3-4V nominal voltage. Battery cells are wired in series to produce the desired battery bank voltage. Typical battery voltages for solar applications are 12V, 24V, or 48V. The battery bank voltage is determined by the selection of the power system components that interact with it—the inverter, charge controller, and possibly the source—and the amount of storage required; the more storage energy that is needed, the higher the battery voltage is likely to be. The most appropriate batteries for residential systems are deep-cycle batteries that can discharge most of their storage capacity. The metric for storage capacity, is battery Amp-hours⁷.

Lifetime:

The lifetime of lead-acid batteries depends mainly on how the battery is used. Deep discharges, temperatures greater than 75°F, and poor maintenance can significantly reduce battery lifetimes. Different lead-acid battery types exist with different lifetimes. For example, flooded lead-acid batteries for small off-grid systems only last about 5 years even with optimal care. More expensive L-16 batteries that use thick lead plates, which were originally designed for floor refinishing machines, offer better Amp-hour capacity and longevity—about 390 Ah and 10 years respectively. Industrial forklift batteries might last 15-20 years with optimal care, but their cost will be significantly higher, about \$20,000 for a 1600 Ah, 48V system.

Price:

According to the SolarBuzz retail battery index [43], the average retail battery price in the United States in March 2011 was \$0.21/Watt-hour. Due to the maturity of the lead-acid battery market, battery prices do not fluctuate as much as prices of other PV system components. Table 22 shows retail prices for lead-acid batteries used in residential PV systems [61].

Table 22. Lead-acid battery models used in residential PV systems.

Manufacturer	Model #	Voltage (V)	Capacity (Ah)*	Weight (lbs)	Retail Price** (\$)	Retail Price per Watt-hour (\$)
Trojan	L16RE-A	6	325	115	445	0.23
Trojan	L16RE-B	6	370	118	505	0.23
Rolls	S-460	6	350	117	450	0.21
Rolls	S-530	6	400	125	497	0.21
East Penn	MK 8L-16	6	370	113	410	0.18

*For 20-hr discharge rate

** Retail prices are consistent with the Solarbuzz retail battery index average.

⁷ Battery Amp-hours, or AH, is the maximum constant current drawn from a battery in a fully charged state to the minimum charge possible during a certain time period. A typical industry time period referenced for solar batteries is 20 hours.

Market Status: Mature (Lead-Acid)

Lead-acid battery technology has been available for more than 150 years, and lead-acid batteries have been used in PV systems for some decades. Figure 24 shows a comparison of the technical maturity of different storage technologies.

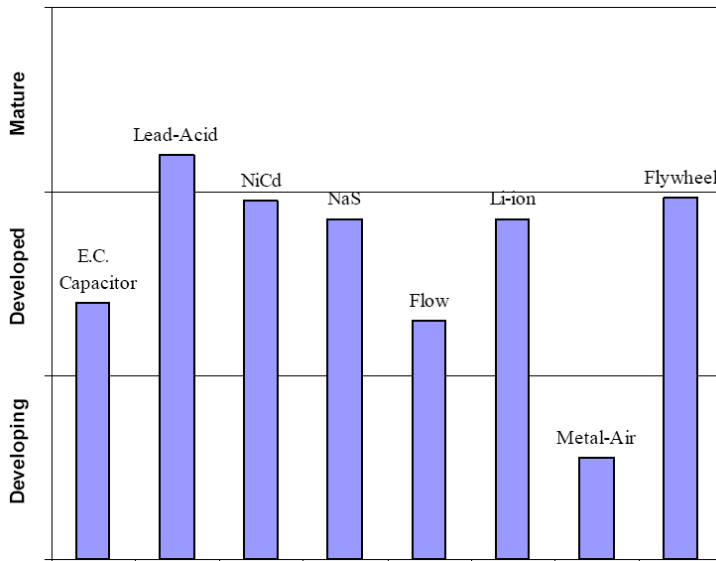

Figure 24. Technical maturity of storage technologies.

Lead-acid batteries are considered the most mature technology currently available. Source: [62]. Reproduced with permission from the publisher.

Emerging battery technologies with higher technical potential (increased energy density, higher voltage per battery cell, longer cycle-life, lower maintenance requirements, and smaller size and weight) than lead-acid batteries include lithium-iron-magnesium-phosphate (LiFeMgPO_4) batteries⁸, molten sulfur - sodium batteries, lithium with sulfur cathode (currently developed by Ceramatec), and others. It is too soon to predict the true world lifespan and applicability of these advanced batteries in renewable energy system configurations, but experience from the electric automotive industry will shed valuable light while also driving down costs.

Efficiency:

Battery efficiency, measured as round-trip efficiency, is not constant but is a function of the battery's state of charge [63]. Lead-acid battery round-trip efficiency ranges from 70-80% [62]. Figure 25 compares efficiencies for different battery technologies, versus their lifetime at 80% depth of discharge.

⁸ The battery backup inverter produced by Princeton Power Systems uses a LiFeMgPO_4 battery.

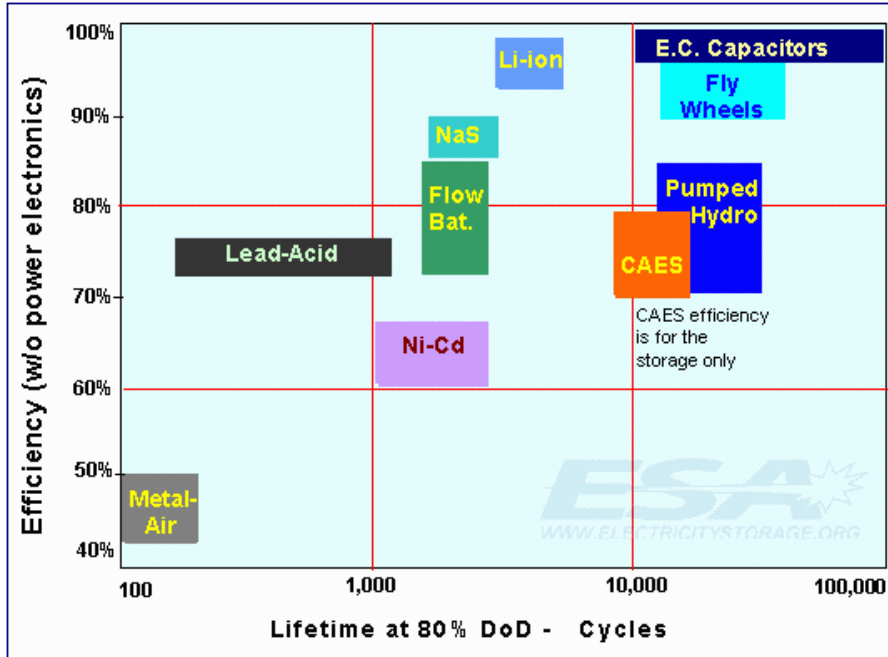

Figure 25. Storage technologies comparison.

Efficiency versus lifetime at 80% depth of discharge. Lead acid batteries' roundtrip efficiency is about 75%. Reproduced with permission from ESA [64].

3.3. Power Delivery and Integration

3.3.1 DC Power Distribution Systems

The EMerge Alliance has registered 'infrastructure' (power supply and DC-distribution) products that perform to its 24Vdc Occupied Space Standard. One such product is the DC FlexZone Grid from Armstrong Ceiling Systems [65]. A typical ceiling-based EMerge system schematic is shown in Figure 26. The elegant low-voltage grid architecture delivers DC power to lighting fixtures, sensors, and other electrical devices, allowing easy relocation of fixtures without the need to rewire. While this latter feature may be the product's greatest attraction, such systems may greatly facilitate the introduction and growth of DC lighting products and other appliances in residential and small commercial applications.

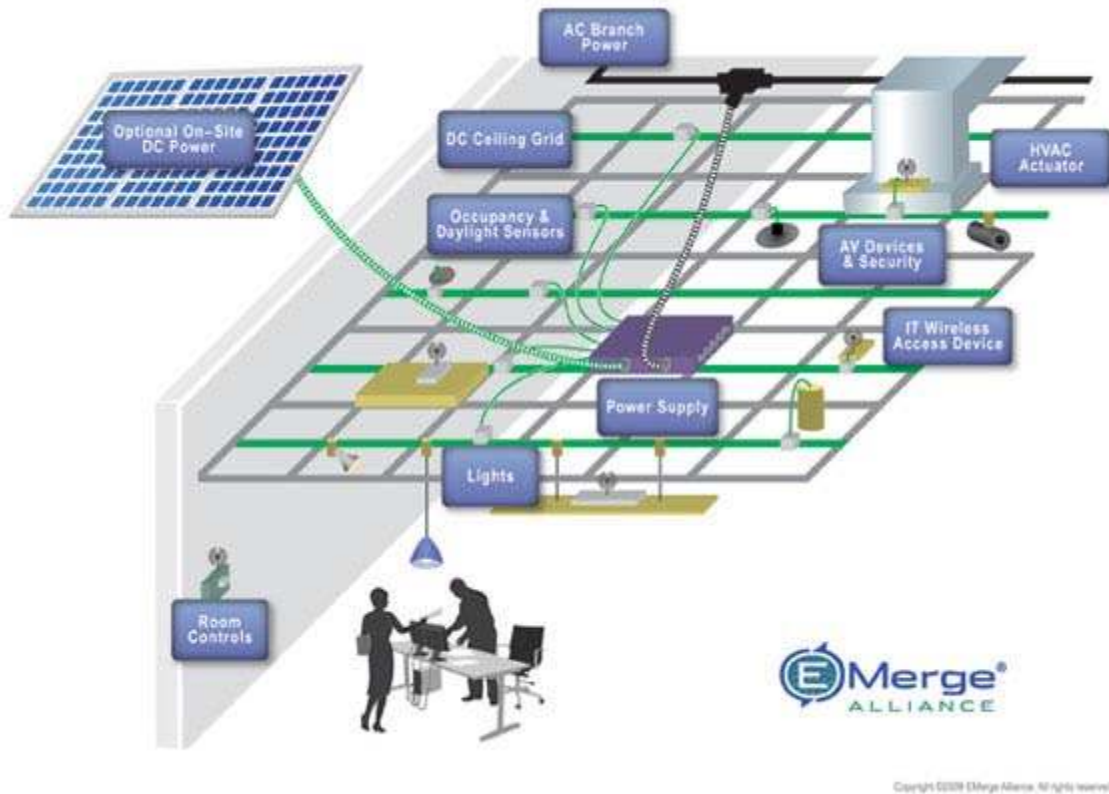

Figure 26. A typical ceiling-based EMerge system schematic
 Source: [65].

As mentioned above, the EMerge Alliance is also developing a 380V_{dc} standard designed for data centers and central telecom offices, which could also lay the foundation for higher-than-24V DC distribution in residential and commercial spaces. At the same time, the International Electrotechnical Commission (IEC) Technical Committee TC23, is developing common 380V_{dc} standards for the associated electro-mechanical devices (connectors, switches, and circuit breakers), including addressing issues of in-rush current, current breaking, and grounding.

3.3.2 Power over Ethernet

Power over Ethernet (PoE) is an existing DC power distribution technology, which already supplies low power applications in buildings. The technology has been evolving over time to deliver more power, as reflected in the series of IEEE standards governing PoE design: IEEE802.3af, adopted in 2003, limited PoE applications to 15.4W at 48Vdc. IEEE802.3at, adopted in 2009, increased that limit for its PoE+ standard to 25W. Currently under development is a new standard that is expected to extend that limit to 65W at 51-54Vdc.

PoE is used today to power electronic devices, including network routers, wireless access points, cameras, and voice over Internet protocol (VoIP) phones. As a new promising application, PoE computers and laptops have also become available recently (e.g. from SkinnyBytes [66], DSP Design [67],

and Boundary Devices [68]). With the increasing efficiency of electronics and lighting technologies, under the anticipated standard it is not inconceivable that PoE might provide a meaningful fraction of residential and small commercial loads over time.

3.3.3 Universal Serial Bus Wall Outlets

Besides being charged from PoE ports, electronic devices may get power from universal serial bus (USB) wall outlets that have recently come on the market. One such product is the U-Socket [69], as shown in Figure 27. U-Socket puts two USB wall outlets side-by-side with the standard AC power outlets. The USB outlets use AC power ranging from 100V to 125V as input and output 5V DC power. Thus, they can charge USB (1.0 to 3.0) powered devices requiring 5V input power directly without the need of a power adapter. It is claimed that the energy cost savings can be up to \$20 per year from the product's energy efficient design.



Figure 27. U-Socket, marketed by fastmac.com provides 5V_{DC} USB power from wall sockets.
Reproduced with permission from Fastmac.com

3.4. Home Energy Management Systems

Home energy management systems (HEMs) have the theoretical potential to increase the savings from direct-DC by shifting the load, where feasible, to solar peak hours. The potential to shift loads depends on the sector and on applications within sectors [1]. HEMS are just emerging on the residential market. Energy management in the large commercial sector is well developed because it is managed by dedicated energy managers as a means to maintain service and contain costs. Small commercial buildings may or may not come under professional energy management, depending on the nature of the space it occupies. HEMs, or derivatives thereof, might be used to serve significant parts of the small commercial market.

Table 23 summarizes information on HEMs currently available on the market. These include both wired and wireless communications. About half of the models are only available through utilities and are designed to interact with utility Smart Meters currently being installed in many parts of the country. Of the models available directly to consumers, only one (AlertMe) actually offers any load control, the rest offering only monitoring capabilities.

To test the potential of load shifting to improve direct-DC savings, we modeled the impact of shifting the residential cooling load two hours earlier in the day. We chose to model the residential cooling load because (1) cooling dominates residential electricity use in general, and particularly in high electricity use areas, and (2) the residential cooling load is skewed toward evening hours, because of the large fraction of the population that is not at home during normal working hours. Commercial cooling loads are more closely in phase with PV system output and would therefore benefit less from load shifting. Thus, the residential test provides a fractional bound on the potential improvement that load shifting could offer. We limited the load shift to two hours, because of the limited ability of the system to store 'coolth' (with typical home air exchange rates on the order of $\frac{1}{2}$ an air change per hour). While large shifts could be obtained using dedicated thermal storage technology (like chilled water storage), we felt they would be cost prohibitive, at least for most residential applications, in the foreseeable future.

The results of the modeling test were that the impact of pre-cooling with load shifting is negligible. Therefore, we conclude that HEMs offer little potential to increase direct-DC savings, and we investigate them no further here. That said, HEMs outfitted with sensors and controls do offer the potential to reduce overall loads by turning unneeded loads off or down, although currently available models offer little ability to do so.

Table 23. Characteristics of home energy management systems currently on the market.

Product	Currently On Market?	Networking Method	Features for Residents	Interaction with Utility
TED	Yes	ZigBee*/Internet	Monitoring	None
AlertMe	Yes	ZigBee/Internet	Monitoring/Remote Plug Load Control	None
Blue Line PowerCost	Yes	Wi-Fi	Monitoring	None
Google PowerMeter	Yes	Internet	Monitoring	Can receive data from smart meters
Microsoft Hohm	Yes	Internet	Monitoring	Can receive data from smart meters
EcoFactor	Only through utilities	Internet	Automated HVAC Control	Can be an HVAC demand response platform
Control4 EMS-100	Only through utilities	ZigBee/ Wi-Fi	Monitoring/Remote and Automated Appliance Control	Utilities receive load data, can send information/control appliances
Tendril	Only through utilities	ZigBee/Wi-Fi	Monitoring/Remote and Automated Appliance Control	Utilities receive load data, can send information/control appliances
Sequentric	Only through utilities	433 MHz protocol/ Wi-Fi	Monitoring/ Automated Appliance Control	Utilities receive load data, can send information/control appliances
Our Home Spaces	Only through HVAC installers and ESCOs	Wi-Fi	Monitoring/Remote and Automated Appliance Control	Utilities receive load data, can send information/control appliances
Intel	No	ZigBee/Wi-Fi	Monitoring/Remote and Automated Appliance Control	Utilities receive load data, can send information/control appliances

* ZigBee is a standards-based wireless protocol that uses small, low-power digital radios to allow communication within a wireless personal area network between devices that require low data rates and low power consumption.

4. Conclusions

Two major trends are facilitating an emergence of direct-DC power systems onto the mainstream residential and commercial markets: the rapid adoption of distributed DC power systems (specifically on-site PV) and of DC-based end-use applications such as electronic lighting, consumer electronics and TVs, and efficient DC-based motor technologies for myriad relevant applications. In addition, electric and hybrid electric vehicles (an inherently DC technology) are expected to represent a large future load. Therefore, the question naturally arises: Does it make sense to convert DC power from solar electric systems into AC for distribution within the building, just to have to convert it back to DC for use within appliances?

While DC distribution systems have long been incorporated in buildings for telephone communications and more recently for the Ethernet, those served exclusively discrete low-voltage, low-power applications. The market is currently experiencing the emergence of DC-distribution power systems designed for general service, and new standards are being developed that could accommodate all residential and commercial loads. Combining both the energy savings of possible DC-based appliances with the avoided AC-to-DC conversion losses within those appliances, the total energy savings could be large, at more than 30%.

Admittedly there are large barriers to the widespread adoption of direct-DC for general service power in buildings. If it is to become widely adopted, what is the likely scenario? First, it appears that there is enough need to reduce large DC loads serviced by DC uninterruptible power supplies in data centers and central telecom offices that the most aggressive near-term adoption of direct-DC is likely to start there. The convenience, flexibility, and added safety of the EMerge Alliance 24-V_{DC} power system are likely to be the next significant driver for market adoption of mainstream direct-DC products, in particular commercial lighting. That would in turn facilitate the adoption of other products designed to the EMerge Standard. At the same time PoE will continue to expand, but only for relatively low power consumption applications.

In the future, the largest energy savings from direct-DC instead of conventional AC will be for space cooling, EV charging (if that load materializes), and for the battery-integrated solar electric systems needed to achieve high penetration of distributed PV supply. Potential cooling-related savings are large both because cooling loads are large, especially in high energy use areas, and because cooling loads are the closest of all loads to being in phase with PV system output, which allows DC power to service the load directly without storage. If EV charging can be done during the day, for example by commuters charging vehicles at work, this would be the most cost-effective application of direct-DC, because solar EV charging is already cost competitive with gasoline fueling on a per mile basis at a good solar site. Any further savings from direct-DC result in true negative costs, as opposed to small offsets on large costs increments of using solar. Any time that battery storage is used to serve loads, direct-DC saves energy, because the stored power does not need to be converted to AC and back to DC to service loads. In conclusion, if trends continue as anticipated, including the need to reduce carbon emissions, the energy advantages of direct-DC will increase.

References

1. Garbesi, K., V. Vossos, and H. Shen, *Maximizing Energy Savings from Direct-DC in U.S. Residential Buildings*, In press, Lawrence Berkeley National Laboratory.
2. Barbose, G., et al., *Tracking the Sun IV: An Historical Summary of the Installed Cost of Photovoltaics in the United States from 1998 to 2010*, 2011, Lawrence Berkeley National Laboratory: Berkeley, CA.
3. Sherwood, L., *U.S. Solar Market Trends 2009*, 2010, Interstate Renewable Energy Council. Retrieved from http://irecusa.org/wp-content/uploads/2010/07/IREC-Solar-Market-Trends-Report-2010_7-27-10_web1.pdf
4. Solar Energy Industries Association, *U.S. Solar Market Insight(TM): 2010 Year in Review (Executive Summary)*, 2010, Solar Energy Industries Association. Retrieved from <http://www.energyportal.eu/latest-solar-energy-news/9344-us-solar-market-insight-report-strong-us-solar-industry-growth-for-first-half-of-2010.html>
5. U.S. Department of Energy. *Database of State Incentives for Renewables and Efficiency: Net Metering Policies Summary Map*. 2011 [cited 2011 March 9, 2011]; Available from: <http://www.dsireusa.org/solar/summarymaps/>.
6. EMerge Alliance. *An open industry association*. 2011 [cited 2010 Nov 06]; Available from: <http://emergealliance.org>.
7. Baek, J., Gab-Su, S., Kyusik, C., Cheol-Woo, P., Hyejin, K., Hyunsu, B., & Bo, H. C., *DC Distribution system design and implementation for Green Building*, in *Green Building Power Forum 2011*: San Jose, CA.
8. U.S. Department of Energy. *Buildings Energy Data Book 2009*. 2009 [cited 2011 Feb 10]; Available from: <http://buildingsdatabook.eren.doe.gov/>.
9. *Solar Panels Plus*. [cited 2010 June]; Available from: <http://www.solarpanelsplus.com/dc-air-conditioning>.
10. Anonymous. *Variable-frequency*. Wikipedia [cited 2011 March 28]; Available from: http://en.wikipedia.org/wiki/Variable-frequency_drive.
11. Garbesi, K., and L.B. Desroches, *Max Tech and Beyond: Maximizing Appliance and Equipment Efficiency by Design, 2011*, Lawrence Berkeley National Laboratory. Berkeley, CA.
12. CEC. *California Energy Commission Appliances Database*. [cited 2010 May]; Available from: <http://www.energy.ca.gov/appliances/database>.
13. *RV-Coach Online*. [cited 2010 June]; Available from: http://www.rv-coach.com/current_category.83/FAQ.189/faqs_detail.html.
14. *Brushless DC Compressors*. [cited 2010 June]; Available from: http://www.rparts.com/Catalog/Major_Components/compressors/Danfoss/danfoss.asp.
15. *Sun Frost*. [cited 2010 June]; Available from: http://www.sunfrost.com/refrigerator_specs.html.
16. *Comparison Chart*. [cited 2010 June]; Available from: <http://www.backwoodshome.com/articles2/images/yago102-3.gif>.

17. Energy Star Program. [cited 2010 June]; Available from: <http://www.energystar.gov>.
18. EMerge-Alliance. *EMerge Alliance introduces first registered products for DC power distribution in commercial buildings*. [cited 2010 Nov 17]; Available from: http://emergealliance.org/imwp/idms/popups/pop_download.asp?contentID=19309.
19. EMerge-Alliance. *Registered products*. [cited 2011 Oct 10]; Available from: <http://www.emergealliance.org/Products/RegisteredProducts.aspx>.
20. Cooper Lighting. [cited 2010 Dec]; Available from: <http://www.cooperlighting.com/>.
21. Finelite. [cited 2010 Dec]; Available from: <http://www.finelite.com/index.php>.
22. Lunera Lighting. [cited 2010 Dec]; Available from: <http://www.lunera.com/>.
23. Nextek Power Systems. [cited 2010 Dec]; Available from: <http://www.nextekpower.com/>.
24. DOE. *Fueleconomy.gov: New & upcoming electric vehicles*. 2010 [cited 2011 March 17]; Available from: <http://www.fueleconomy.gov/feg/evnews.shtml>.
25. Hurst, D. and J. Gartner. *Electric Vehicle Market Forecasts. Global Forecasts for Light-Duty Hybrid, Plug-in Hybrid, and Battery Electric Vehicles: 2011-2017. Executive Summary*. 2011 [cited 2011 Sep 09]; Available from: <https://www.pikeresearch.com/wordpress/wp-content/uploads/2011/08/EVMF-11-Executive-Summary.pdf>.
26. Ornelas, E. *Basics of electric vehicle charging*. 2009 [cited 2011 June 13]; Available from: <http://www.sfenvironment.org/downloads/library/SFCCC/ABC%27s%20of%20Battery%20Charging.pdf>.
27. Herron, D. *Electric vehicle charging standards*. 2010 [cited 2010 December 10]; Available from: <http://visforvoltage.org/book/9471>.
28. SAE International. Available from: <http://www.sae.org/>.
29. *Annual Energy Outlook (AEO)*. [cited 2010 Nov]; Available from: <http://www.eia.doe.gov/oiaf/aeo>.
30. EIA. *The National Energy Modeling System: An Overview*. 2009 [cited 2010 Nov 14]; Available from: <http://www.eia.doe.gov/oiaf/aeo/overview>.
31. Energy Star. *Energy Star EPS specifications (dataset used to determine Final Draft Version 2.0 Specification Levels)*. 2010 [cited 2010 May 15]; Available from: http://www.energystar.gov/index.cfm?c=revisions.eps_spec.
32. ECOS. *Power supplies efficiencies*. 2010 [cited 2010 July 10]; Available from: <http://www.80plus.org>.
33. DOE. *Estimating appliance and home electronic energy use*. [cited 2010 Aug]; Available from: http://www.energysavers.gov/your_home/appliances/index.cfm/mytopic=10040.
34. *Average power consumption of household appliances*. [cited 2010 Aug]; Available from: <http://www.absak.com/library/power-consumption-table>.
35. OkSolar.com. *Typical power consumption*. [cited 2010 Aug]; Available from: <http://www.oksolar.com/technical/consumption.html>.
36. Peters, J.S., et al., *Electronics and energy efficiency: a plug load characterization study*, SCE0284, 2010. [cited 2011 Sep]; Available from: http://www.calmac.org/publications/BCE_Final_Report_2010.04.26ES.pdf

37. LBNL. *Standby power summary table*. [cited 2010 Aug 20]; Available from: <http://standby.lbl.gov/summary-table.html>.
38. CEC and CPUC. *Go Solar California: List of Eligible SB1 Guidelines Compliant Photovoltaic Modules*. 2011 [cited 2011 March 28]; Available from: <http://www.gosolarcalifornia.org/about/index.php>.
39. SEIA, *US Solar Industry Year in Review 2009, 2010*, Solar Energy Industries Association.
40. CPUC. *California Solar Initiative Working Data Set* 2011 [cited 2011 March 10]; Available from: http://www.californiasolarstatistics.org/current_data_files/.
41. DC Power Systems. *Wholesale Price List*. [cited 2010 May 3]; Available from: <http://www.dcpower-systems.com/products.aspx>.
42. SunWize Technologies, I. *Wholesale Price List* [cited 2010 May 12]; Available from: <http://www.sunwize.com/catalog/pdf/SunWize-2010-solar-catalog.pdf>.
43. Solarbuzz. *Retail Price Environment*. 2011 [cited 2011 March 28]; Available from: <http://www.solarbuzz.com/facts-and-figures/retail-price-environment>.
44. LaMonica, M. *Study delivers blow to urban microwind turbines*. 2009 [cited 2011 March 29]; Available from: http://news.cnet.com/8301-11128_3-10157474-54.html#ixzz1I5y4wp8N.
45. Treehugger. *10 Small-Scale Wind Turbines Cut NYC Apartment Building's Electric Costs in Half*. [cited 2011 Sep. 08]; Available from: : <http://www.treehugger.com/files/2009/01/small-scale-wind-turbines-cut-apartment-building-electricity-bill-in-half.php>.
46. Woofenden, I., and M Sagrillo, *2010 Wind Generator buyer's guide*. Home Power Magazine, 2010(137): p. 44-54.
47. Cunningham, P.a.I.W. *Microhydro electricity basics*. Home Power Magazine [cited 2011 March 30]; Available from: <http://homepower.com/basics/hydro>
48. Perez, R., *The Schatz PV Hydrogen Project*, in *Home Power Magazine*, 1991(22): p. 26-30.
49. Enphase Energy. *Reliability of Enphase Micro-inverters*. 2009 [cited 2011 March 24]; Available from: http://www.enphaseenergy.com/downloads/Enphase_WhitePaper_Reliability_of_Enphase_Micro-inverters.pdf.
50. Barbose, G., N Darghouth, and R Wiser, *Tracking the Sun III: The Installed Cost of Photovoltaics in the U.S. from 1998-2009*, 2010, Lawrence Berkeley National Laboratory: Berkeley, CA.
51. AEE Solar. *AEE Solar Product Catalog*. 2010 [cited 2010 July]; Available from: <http://www.aeesolar.com/PDFs/aee-solar-2010-catalog.pdf>.
52. CEC and CPUC. *List of Eligible Inverters per SB1 Guidelines*. 2011 [cited 2011 March 25]; Available from: <http://www.gosolarcalifornia.org/equipment/inverters.php>.
53. SMA. *SUNNY BOY 5000-US / 6000-US / 7000-US / 8000-US*. 2010 [cited 2011 25 March]; Available from: <http://download.sma.de/smaprosa/dateien/4752/SUNNYBOY5678-DUS103927W.pdf>.
54. Princeton Power Systems. *GTIB-480-100 Grid-Tied Inverter System*. 2010 [cited 2011 March 25]; Available from: http://www.princetonpower.com/pdfs/spec_gtib-480-100.pdf.

55. Validus. *Data Center Improvements Through Direct Current*. 2011 [cited 2011 March 31]; Available from: http://www.validusdc.com/Validus_Home.html.
56. Lai, T., "DC Power Supply Efficiency Curve", *Personal Communication* 2010.
57. Lee, F.C., et al., *Proposal for a MiniConsortium on Sustainable Buildings and Nanogrids*, 2010, Center for Power Electronic Systems, Virginia Tech: Blacksburg, VA.
58. Brearly, D., *Distributed PV System Optimization: Microinverters, DC-to-DC and Two-Stage Inverters*. SolarPro, 2010(3.5): p. 32-58.
59. Nextek Power Systems. *Technical Document Library*. [cited 2011 March 30]; Available from: <http://www.nextekpower.com/technology/technical-document-library>.
60. Morningstar Corporation. *Sunsaver MPPT*. 2011 [cited 2011 March]; Available from: <http://www.morningstarcorp.com/en/sunsavermpt>.
61. AEE Solar. *2010 Renewable Energy Design Guide and Catalog*. 2010 [cited 2010 November 10]; Available from: <http://www.aeesolar.com/PDFs/ae-solar-2010-catalog.pdf>.
62. Chen, H., et al., *Progress in electrical energy storage system: A critical review*. *Progress in Natural Science*, 2009. 19(3): p. 291-312.
63. Stevens, J.W. and G.P. Corey. *A Study of Lead-Acid Battery Efficiency Near Top-of-Charge and the Impact on PV System Design*. in *Photovoltaic Specialists Conference*. 1996. Washington, DC: IEEE.
64. ESA. *Technologies Comparison*. 2009 [cited 2011 March 28]; Available from: http://www.electricitystorage.org/ESA/technologies/technology_comparisons/.
65. Ceilings, A. *DC FlexZone Grid from Armstrong Ceiling Systems*. [cited 2011 Jan]; Available from: <http://www.armstrong.com/commceilingsna/article55189.html>.
66. *SkinnyBytes Power-over-Ethernet Computing* [cited 2010 Dec]; Available from: <http://www.skinnybytes.com/>.
67. *DSP Design: Power over Ethernet*. [cited 2010 Dec]; Available from: http://www.dspdesign.com/products/index_html?category_id=52.
68. *Boundary Devices: 10.4" POE touch computer*. [cited 2010 Dec]; Available from: http://boundarydevices.com/poe_touch_comp.php.
69. *U-Socket*. [cited 2011 Jan 4]; Available from: <http://fastmac.com/usocket>.
70. Nordyne. *Technical Specifications: Frigidaire, iQ Drive FS4B1 Series*. [cited 2011 March 24]; Available from: <http://www.nordyne.com/literature/287c.pdf>.
71. Nordyne. *iQ Drive® Technology*. [cited 2011 March 24]; Available from: <http://www.nordynenewscenter.com/PDFs/iQ%20Drive%20Media%20Kit.pdf>.
72. Little, A., *Opportunities for Energy Savings in the Residential and Commercial Sectors with High-Efficiency Electric Motors, Final Report*, US DOE.
73. DOE. *Residential Heating Products Final Rule* 2010; Available from: http://www1.eere.energy.gov/buildings/appliance_standards/residential/heating_products_fr.html.
74. DOE, *Technical Support Document, Refrigerator, Refrigerator-Freezer, and Freezers Rulemaking*, 2011, US Department of Energy.

75. Bendt, P., C. Calwell, and L. Moorefield, *Residential clothes dryers: An investigation of energy efficiency test procedures and savings opportunities*, 2009, Ecos.
76. DOE, *Technical support document for residential cooking products, volume 2: Potential impact of alternative efficiency levels for residential cooking products, Table 1.7*, 1998.
77. Simpson, D., *Dishwashers: Everything, Including the Kitchen Sink* Appliance Magazine, 2005
78. Murray, A., *Appliance motors turn green*. Machine Design, 2006. Dec 14: p. 106-113.

Appendix

Energy Savings Obtainable by Switching from Standard AC Appliances to DC-Compatible Appliances run on AC

This section explains the rationale behind the energy savings estimates in Table 8. These estimates of energy savings assume that those appliances continue to be run on AC power, as are all major DC-internal appliances today including televisions, computers, fluorescent lighting, and appliances using advanced DC motor technologies. The conversion to such DC appliances, running on AC, would yield major energy savings in the US economy. It would also greatly enable further savings by direct-DC.

That is, the total savings that can be obtained by converting these appliances to actually run on DC would be larger because of avoided AC-DC conversion losses. Avoided conversion losses are addressed separately in the main body of the report. Of course, actual savings at the buildings level would also need to account for any differences in AC versus DC distribution power systems. For the residential sector, that issue is discussed in a separate paper, currently under development for the Direct-DC Project: *Potential Energy Savings from Direct-DC in US Residential Buildings*.

The potential savings are estimated differently for different products due to varying data constraints. Where energy efficiency data are available for standard (eff_{std}) and DC-internal (eff_{dc}) models, the percent energy savings is calculated in the following way:

$$\text{(Eq. A.1) percent savings} = \left(1 - \frac{eff_{std}}{eff_{dc}} \right) \times 100$$

In other cases, estimates are made based on savings obtained for similar appliance types and or based on functional savings, as indicated in Table 7.

Central Air Conditioners

For central air conditioners energy efficiency is rated using the seasonal energy efficiency rating (SEER). The efficiency of the standard technology is taken as the federal standard for residential air conditioners: SEER 13. Current ultra efficient central air conditioners using variable frequency drives operating on brushless DC motors achieve SEER ratings of 24.5, representing a 47% energy savings over the standard model. See, for example, both the FS4B1 series air conditioners, which incorporate Nordyne IQ Drives (variable frequency drives).[70] These drives are also included in 2 – 4 ton models (suitable for residential and very small commercial) offered by Maytag, NuTone, Tappan, and Westinghouse [71]. We take this as proof that direct-DC air conditioners can be produced that would approximately half the energy use of today's standard models.

Room Air Conditioners

Room air conditioner efficiencies are rated using EER (an instantaneous measure of efficiency at fixed indoor-outdoor temperature difference). The federal standard for room air conditioners is EER 9. Energy savings reported for variable speed compressors over standard single speed compressors in air conditioning units range from 35% reported for early models[72] to the 47% savings reported above (although the latter value include other efficiency improvements). Both of those estimates were made for central air conditioning systems. So, to be conservative, we assume a low-end estimate of 35% savings for room air conditioners. We further note that, EPA's Energy Star program reports an EER of 13.5 for the Turbo Air model #TAS-09EH, although we cannot verify the technology used to achieve these savings, we note that it is near the low end of what would be expected for variable speed drive technologies.

Lighting

Based on data contained in the California Energy Commission's Appliance Efficiency Database for Lighting Products[12], the average efficacy for the following technology lamps are:

- 14.0 LPW for incandescent lamps,
- 15.1 LPW for incandescent reflector lamps, and
- 51.87 LPW for compact fluorescent lamps (CFLs).

Using Eq. A.1, this implies an average 73% energy saving for switching standing incandescent lamps to compact fluorescent, and 71% for switching reflector to compact fluorescent. With LED efficiencies improving, these should constitute a lower bound on efficiency improvement potential that can be obtained by shirting within these DC-compatible lighting technology types.

Electric Water Heaters

DOE [73] estimates the energy efficiency of a standard electric resistance water heater is 0.9 and that the energy efficiency of an air source electric heat-pump water heater is 2.2⁹ or greater, implying an energy savings of 60%.

Refrigeration

The US DOE publishes Technical Support Documents (TSD) in support of its energy efficiency standards rulemakings, which analyzes the potential for energy efficiency improvements above the existing federal standard and the design features that could produce those improvements. In September 2010, it published the TSD for its current residential refrigerators and freezers rulemaking, which includes an analysis of the maximum technology level designs (that is, the most efficient refrigerators that could be

⁹ Efficiencies of greater than 100% are possible in heat pumps because the work energy of the motor-compressor system is being converted to heat while at the same time moving heat from a low temperature to a high temperature reservoir. This is the reverse process of a typical heat engine, which will always have thermal efficiency of well less than 100%.

built today with existing best-technology components) for the product classes considered.[74] As shown in Table 1, copied from that document, DC-optimal technologies (variable speed compressors and brushless DC fans play an important role in achieving large energy savings. DOE quotes savings of 15% to 25% for variable speed compressors alone. The report also articulates the significant efficiency advantage of DC motors:

Before the 1993 U.S. energy efficiency standards took effect, most evaporator and condenser fan motors were shaded pole induction designs, with efficiencies between 10 and 15 percent and power input of about 15 Watts (W). Higher-efficiency motor designs include permanent split capacitor motors (PSC) induction motors with 20 to 30 percent efficiency, and brushless DC motors, with near 65 percent efficiency.

Table 24 shows the savings expected (over federal standard baseline models) for the combination of technologies applied to refrigeration: from 22% to 60% depending on class.

Table 24. Refrigerator design options considered by DOE in its current energy efficiency standard rulemaking for refrigerators*

Product Class	% Lower Energy	Design Options Used									
		Brushless DC Fans	Forced Convection Condenser	Larger Evaporator	Larger Condenser	Thicker Insulation	VIPs	Variable Speed Compressor	Adaptive Defrost	Variable Anti-Sweat	Isobutane Refrigerant
3	36%	✓		✓	✓		✓	✓	✓		
5	36%	✓		✓	✓		✓	✓	✓	✓	
7	33%	✓		✓	✓		✓	✓	✓	✓	
9	44%	✓	✓	✓		✓	✓	✓	✓		
10	41%			✓	✓	✓	✓	✓			
11	59%			✓	✓	✓	✓	✓			✓
18	42%					✓	✓	✓			
3A-BI	29%	✓			✓		✓	✓			
5-BI	27%	✓			✓		✓	✓	✓		
7-BI	22%	✓			✓		✓	✓	✓	✓	
9-BI	27%	✓			✓		✓	✓	✓		

Source: U.S. DOE Technical Support Document [74], Table 5.4.21, Pg 5.34,

Electric Space Heaters Other than Heat Pumps

We assume that electric space heaters that do not use heat pumps will achieve double efficiency by switching to the use of a heat pump.

Electric Clothes Dryers

Based on [75] switching from electric resistance to heat pump driers is expected to give a 45% energy savings. While there are virtually no heat pump driers in the US market now, they are on the market in Europe, and Switzerland's recent energy efficiency standard for dryers effectively banned all but heat-pump dryers.

Furnace Fans and Boiler Circulation Pumps

Based on a conservative estimate of the savings obtainable from variable speed control in other applications, we assume a savings of 30% from switching to the use of variable speed brushless DC motors.

Electric Cooking Equipments

It is indicated in the DOE energy efficiency program 1998 TSD for cooking products [76] that induction cooktops have an 84% efficiency compared to an efficiency of 74% for the baseline electric cooktops (coil and solid disk). The 74% baseline is still used in the 2009 TSD. By replacing standard electric coil and solid disk cooktops with induction cooktops, an savings of 12% is expected.

Dishwashers

A number of dishwashers currently available on the market use only 180 kWh/year, compared to the federal standard of 355 kWh/year, representing a 51% energy savings. These include four models by Bosch (SHE68E####) and two by Gaggenear (DF260760 and DF261760). In dishwashers much of the savings come from reduced water, and therefore a reduced need to heat the water. While it is unclear if these models use BDCPM motors, if they do not, doing so would only increase their savings. Arcelik, a Turkish company does use BDCPM motors with a reported savings of 10%.[77] It is therefore evident that it would be possible to produce a DC-compatible dishwasher that uses 51% less energy than today's federal standard.

Clothes Washers and Ceiling Fans

For clothes washers and ceiling fans the replacement technology is assumed to be the use of variable speed drives with an energy savings of 30% [78].

Spas

We assumed that electrically heated spas would switch to electric heat pump water heating, which would lead to a doubling of efficiency.