

# Chaos and Order in Biomedical Rhythms

M. A. Savi

Universidade Federal do Rio de Janeiro  
COPPE – Department of Mechanical Engineering  
21945.970 Rio de Janeiro, RJ, Brazil  
Cx. Postal 68.503  
savi@ufrj.br

*Nature is full of nonlinearities, responsible for a great variety of responses in natural systems. Physiological rhythms constitute a central characteristic of life, which is motivating the analysis of dynamical aspects related to natural systems. Natural rhythms could be either periodic or irregular over time and space and, each kind of dynamical behavior may be related to both normal and pathological physiological functioning. This review article presents an overview of nonlinear dynamics and chaos concepts useful for the analysis of biomedical system. After that, it is presented an overview of dynamical aspects related to different biomedical systems. Cardiovascular rhythms, brain rhythms, cellular and molecular rhythms are discussed from a dynamical approach pointing some characteristics of normal and pathological responses.*

**Keywords:** *Chaos, nonlinear dynamics, control, biomedical systems, cardiovascular, brain, cellular, natural rhythms, arrhythmias*

## Introduction

Nature is full of nonlinearities, responsible for a great variety of responses in natural systems. Rhythmic phenomena represent one of the most striking manifestations of dynamical behavior in biological systems. Actually, physiological rhythms constitute a central characteristic of life, which is motivating the analysis of dynamical aspects related to natural systems. The understanding of the mechanisms responsible for biological rhythms is crucial for the comprehension of the dynamics of life (Glass, 2001; Goldbeter, 2002).

Natural rhythms could be either periodic or irregular over time and space. Each kind of dynamical behavior related to biomedical systems may be related to both normal and pathological physiological functioning. Extremely regular dynamics may be associated with diseases including periodic breathing, certain abnormally heart rhythms, cyclical blood diseases, epilepsy, neurological tics and tremors. On the other hand, there are phenomena where regular dynamics reflect healthy behavior as sleep-wake cycle and menstrual rhythms. Moreover, irregular rhythms can also reflect disease: cardiac arrhythmias, such as fibrillation, and different neurological disorders (Glass, 2001; Ferriere & Fox, 1995).

The term *dynamical diseases* captures the notion that abnormal rhythms arise from alterations related to physiological control systems. The richness of rhythms related to natural processes, together with nonlinear characteristics of nature, points to the chaotic behavior as a typical response of biological systems. Prigogine (Prigogine, 1980; Nicolis & Prigogine, 1989) said that “*our physical world is a world of instabilities and fluctuations which are ultimately responsible for the amazing variety and richness of forms and structures we see in nature around us*”. Therefore, the dynamical analysis of biomedical rhythms employing nonlinear system theory, including chaos, has gained recent interest.

Chaotic response has sensitive dependence on initial condition, which implies that the system's evolution may be altered by small perturbations. Moreover, chaotic structure is associated with a dense set of unstable periodic orbits, presenting an ergodic property which means that the system often visits the neighborhood of each one of them. Under these conditions, chaos control may become effective using tiny perturbations for the stabilization of an unstable periodic orbit embedded in a chaotic attractor, which makes this kind of

behavior to be very flexible (Ott *et al.*, 1990; Pereira-Pinto *et al.*, 2004).

Due to these properties, chaos has an intrinsically richness related to its structure and, because of that, there are benefits for biological systems of adopting chaotic regimes with their wide range of potential behaviors. Consequently, the system may quickly react to some new situation, changing conditions and their response (Faure & Korn, 2001). Therefore, chaos and many regulatory mechanisms control the dynamics of living systems. These mechanisms are associated with the regulation of voltage-dependent ion channels, regulation of enzyme activity, the control of receptor activity or transport processes, and also circadian rhythms (Goldbeter, 2002).

The dynamical analysis of biomedical phenomena may be done either by mathematical modeling or by time series analysis. The first imply some effort to construct a realistic model that can be used to obtain useful information associated with the biomedical phenomenon. On this basis, it should be pointed out the importance of the analysis of high-dimensional dynamical systems. Recently, the spatiotemporal chaos has attracted so much attention due to its theoretical and practical applications (Awrejcewicz, 1991; Umberger *et al.*, 1989; Lai & Grebogi, 1999; Shibata, 1998). In biomedical systems, spatiotemporal chaos has been analyzed to investigate the interaction between intelligence and electrical brain activity (Anokhin *et al.*, 1999).

On the other hand, time series analysis considers just a scalar time series, usually associated with an experimental acquisition, to understand the system dynamical behavior. The essential point of this analysis is that a time series contains information about unobserved variables of the system, which allows the system analysis performing state space reconstruction. Biomedical signals are generated by complex self-regulating systems that process inputs with a broad range of characteristics. Many physiologic time series are extremely inhomogeneous and non-stationary, fluctuating in an irregular and complex manner (Ivanov *et al.*, 1999).

This review article presents an overview of nonlinear dynamics concepts useful for the analysis of biomedical system. At first, it is presented a historical review related to chaos theory. Then, general background is introduced, discussing the main characteristics and tools related to chaos analysis. In brief, it is discussed the Smale horseshoe transformation, characteristics of the Cantor set, Poincaré maps, fractal dimension and Lyapunov exponents. Moreover, the main concepts associated with time series analysis and chaos control are discussed. After that, it is presented an overview of dynamical aspects related to different biomedical systems. Cardiovascular rhythms, brain rhythms, cellular and molecular rhythms are discussed from a dynamical point of view, presenting a general

overview of these fields, allowing a comprehension of characteristics related to normal and pathological responses.

### Historical Review of Chaos Study

Nature is essentially nonlinear and the idea that natural processes have regular behavior is a consequence of linear paradigms. The excessive use of linear analysis had limited the comprehension of natural processes for many years. One of these paradigms is the strict determinism, clearly illustrated by the Laplace thinking: “If we conceive of an intelligence which at a given instant comprehends of all the relations of the entities of this universe, it could state the respect positions, motions, and general effects of all these entities at any time in the past or future”. In the end of the XIX century, Poincaré studied the dynamical response of the three-body problem. Poincaré tries to analyze the stability of the universe, studying a complicated problem compared with the two-body problem, usually employed in that time. Figure 1 presents some orbits of the third body, showing complex responses (Stewart, 1991).

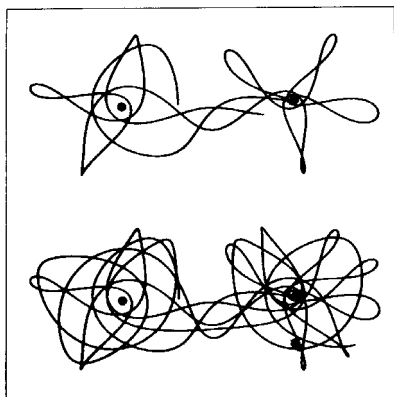

Figure 1. Orbits related to the three-body problem (Modified from Stewart, 1991).

The analysis of Poincaré includes the chance in contrast of the strict determinism of Laplace: “Even if the case that the natural laws had no longer secret for us, ... it may happen that small differences in initial conditions produce very great ones in the final phenomena”.

Although Poincaré has an absolutely clear vision with respect to chaos (as it is understood nowadays), only in 1963, when Lorenz developed studies about meteorology, the idea of chance related to dynamical systems is taken again. Lorenz studied the classical problem of Rayleigh-Benard for fluid convection, which contemplates two parallel plates, separated by a fluid, where the upper plate has a lower temperature when compared with the lower plate. The Lorenz’s analysis shows that small variations on initial conditions may cause great changes in the system response, being identified as the start of the modern study of chaos. This phenomenon represents sensitive dependence on initial conditions, being a characteristic feature of chaos. Colloquially, it became famous as the *butterfly effect*, which means that if a butterfly flaps its wings in China, then it may cause a hurricane in Brazil. Figure 2 shows different response patterns related to the Lorenz’s problem (Van Dyke, 1982).

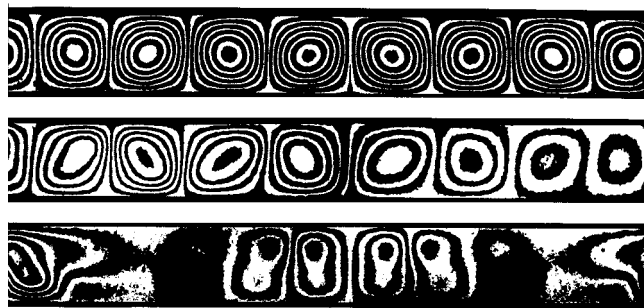

Figure 2. Natural convection (Modified from Van Dyke, 1982).

Since that, many researchers are dedicated to analyze chaos in different fields of sciences. May (1976), for example, treats a system related to the insects population dynamics. This work became known as *logistic map*, evaluating the insect population in one year,  $X_{i+1}$ , from the previous year,  $X_i$ :  $X_{i+1} = \alpha X_i(X_i - 1)$ . The parameter  $\alpha$  defines environmental characteristics. There is no doubt about the simplicity of this mathematical model, however, its dynamical response is very rich.

Together with these pioneer studies, many relevant contributions may be found in the chaos study. Just as a tribute to important authors, one could mention: Grebogi, Fegeibaum, Smale, Shaw, Duffing, van der Pol, Yorke, Ott, Guckenheimer, Holmes, Moon, Abarbanel, Thompson, Chua.

In the same time of the dynamical systems study, Mandelbrot (1982) establishes the existence of the *geometry of nature* in contrast with the classical geometry, which provides just a first approximation to the structures of physical objects. Therefore, fractal geometry may be considered as an extension of classical geometry. Fractals have been observed in nature in different situations varying from geometry to physical sciences. Basically, it is possible to categorize fractals into two different groups: solid objects and strange attractors. The first type includes physical objects that exist in ordinary physical space. On the other hand, the second type considers conceptual objects that exist in the state space of chaotic dynamical systems (Theiler, 1990). Figure 3 shows some fractal representations of natural systems.

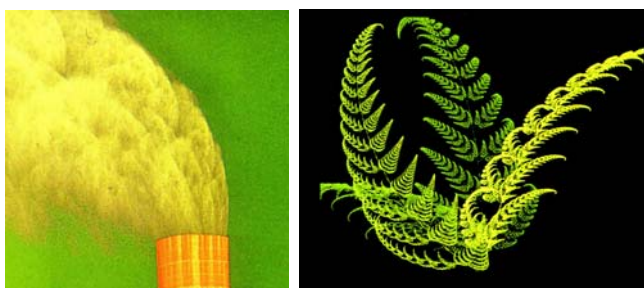

Figure 3. Fractal geometry (Modified from Barnsley, 1988).

In order to offer an understanding of the essential aspects of chaos, some interesting illustrations are now focused on. Lorenz (1996) says that pinball may represent the central ideas related to chaos. Small variations on initial conditions associated with ball launch, may cause great differences after some time, making impossible to predict the ball trajectory. This is similar to changes related to a skyman after his initial velocity (Figure 4).

Nowadays, the analysis of chaotic behavior is becoming common in many different fields of science as engineering, medicine, ecology, biology and economy. In this context, Briggs &

Peat (2000) say that “chaos reveals that, we need to use all uncertainties of life instead of resist to them”.

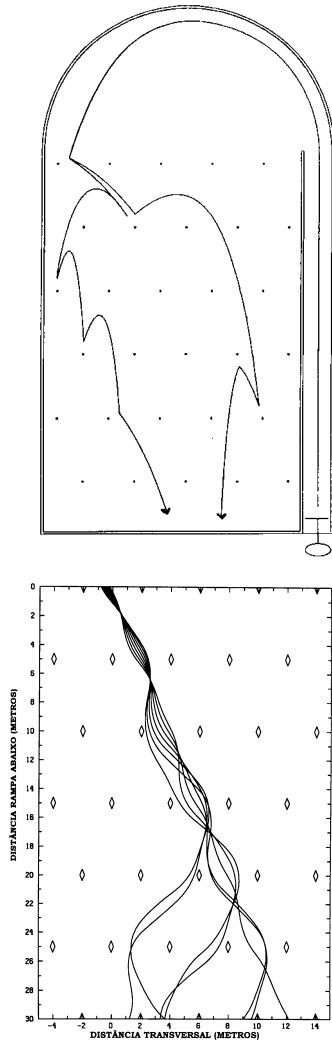

Figure 4. Sensitive dependence on initial conditions (Modified from Lorenz, 1996). (a) Pinball. (b) Sky.

**Chaotic Behavior: Background**

A dynamical system may be mathematically expressed either by continuous set of equations, or by discrete system, called map, as follows:

$$\dot{x} = f(x), x \in R^n. \tag{1a}$$

$$X_{i+1} = F(X_i), X \in R^n. \tag{1b}$$

Spatiotemporal aspects of the dynamical system may also be the objective of analysis. The complex patterns that appear in nature are vastly studied in different fields of sciences. The inclusion of these spatial aspects in the dynamical system is done considering partial differential equations as mathematical models (Cross & Hohenberg 1993; Gollub & Langer, 1999). For simplicity, ordinary differential equations are assumed here to represent a dynamical system.

On this basis, a dynamical system may be understood as a transformation  $f$  that is imposed to a vector field  $x$ . The space of dependent variables,  $x$ , called *state space* or *phase space*, may have

different topologies. In brief, *topology* is the science that studies continuous transformations and furnishes the tools to understand global aspects related to dynamical systems. Essentially, it is possible to define geometrical properties of objects under transformations (Singer & Thorpe, 1967).

An *equilibrium point* (or *fixed point*) is a special point of the state space where the system may stay stationary, which means that the solution does not vary with time. Therefore, if  $\bar{x} \in R^n$  is an equilibrium point of the system, hence  $f(\bar{x}) = 0$ . In the same way, for a map,  $\bar{X} \in R^n$  is an equilibrium point if  $\bar{X} = F(\bar{X})$  (Guckenheimer & Holmes, 1983).

Chaos may be geometrically understood considering some characteristics related to dynamical system transformations. On this basis, let a unitary square  $Q$ , subject to  $f$  such that one direction is contracted while the other is expanded (Figure 5). This transformation is considered to be the positive part of a more general transformation. Analogously, it is possible to think in the reverse transformation (the negative part of transformation), where contraction and expansion of  $Q$  is taken in a different way, shown in Figure 6.

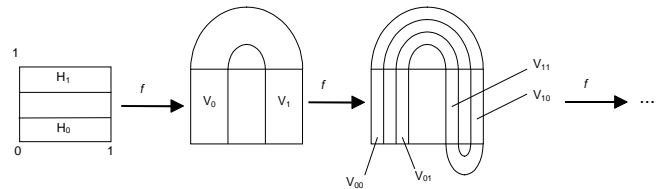

Figure 5. Sequence of transformations subjected to the square  $Q$  for the function  $f$ .

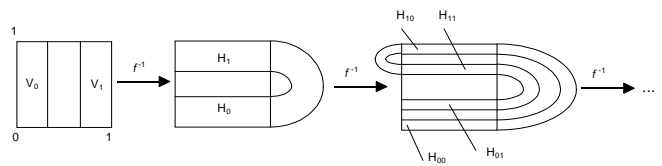

Figure 6. Sequence of transformations subjected to the square  $Q$  for the inverse of function  $f$ .

In the limit, the positive part of transformation,  $A^+ = \bigcap_{i=0}^{+\infty} f^i(Q)$ , tends to form a set of vertical lines, while the action of the inverse function,  $A^- = \bigcap_{i=0}^{-\infty} f^i(Q)$ , tends to form a set of horizontal lines.

Hence, the set of all transformations  $A = A^+ \cap A^-$  forms an invariant set of disconnected points that has the structure of a *Cantor set*. This set is closed, disconnected and has an uncountable infinity of points. An example of this set is shown in Figure 7, that is constructed from a repetition of a simple rule. This kind of structure has a *fractal* characteristic as a reference of the factious nature of its dimension.

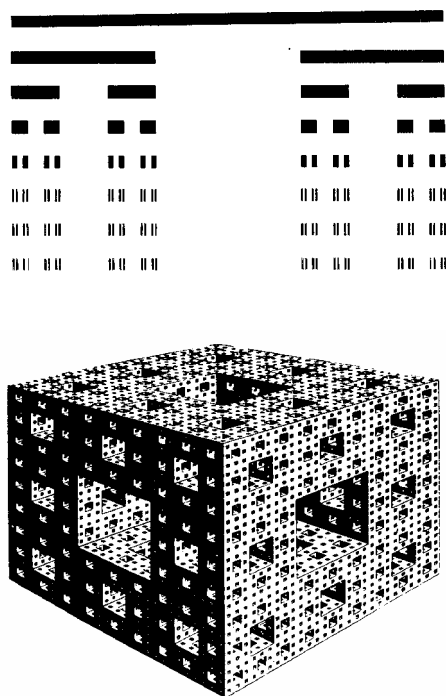

Figure 7. Cantor set (Modified from Gleick, 1987).

A generic point of this set may be identified by a sequence of 0's and 1's and, because of that, it is possible to construct a structure that represents orbits of dynamical systems from these sequences. This approach is called *symbolic dynamics* and since it is based on sequences of integer numbers, it is not associated with floating point errors, being useful in several situations.

Because of the form of the transformed square and also as a tribute to the mathematician Steve Smale, this kind of transformation became known as the *Smale horseshoe*. A dynamical system subjected to this kind of transformation has some special characteristics. This transformation implies that, to a general point of  $Q, p$ , it is possible to associate a neighbor,  $\varepsilon$ , which may be too small, where it can be chosen another point,  $\tilde{p}$ . It does not matter the size of the neighbor  $\varepsilon$ , there is a number of iterations imposed by  $f$  such as  $p$  and  $\tilde{p}$  are separated by a finite distance. Therefore, the system presents a sensitive dependence on initial condition, as shown in Figure 8 (Wiggins, 1990; Strogatz, 1994). This property characterizes the chaotic behavior of a dynamical system. This sensitive dependence represents the butterfly effect described in Lorenz's work.

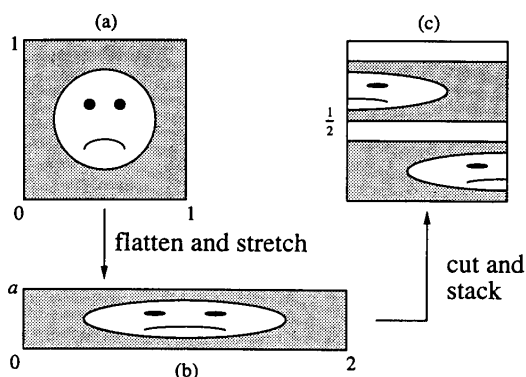

Figure 8. Smale horseshoe transformation (Modified from Strogatz, 1994).

Chaotic behavior is closed related to the existence of the Smale horseshoe. Consequently, chaos is associated with nonlinear systems with, at least, three distinct directions: one related to expansion, one related to contraction, and a neutral one, where folder occurs. This means that a dynamical system may have at least three dimensions in order to exhibit chaotic behavior (Wiggins, 1990; Guckenheimer & Holmes, 1983). Many authors refer to the horseshoe transformation as the baker transformation, as a reference of the process of bread paste. An original paste (related to square  $Q$ ), is prepared by a sequence of contraction-expansion-folder (Gleick, 1987; Stewart, 1991).

Nonlinear dynamics and chaos study involves a series of proper tools to diagnose and understand all related phenomena. Poincaré section and the estimation of dynamical invariants are some examples that are briefly discussed in the following sections.

### Poincaré Map

Poincaré map constitutes a procedure employed to eliminate a dimension of the system and, therefore, a continuous system is transformed into a discrete one (Thompson & Stewart, 1986). There are many forms to define a Poincaré map, but in general, it is considered as a surface that transversely intersects a given orbit. For systems subjected to periodic forcing, Poincaré section may be represented by a surface that corresponds to a specific phase of the driving force. On this basis, one has a stroboscopically sample of the system response (Figure 9).

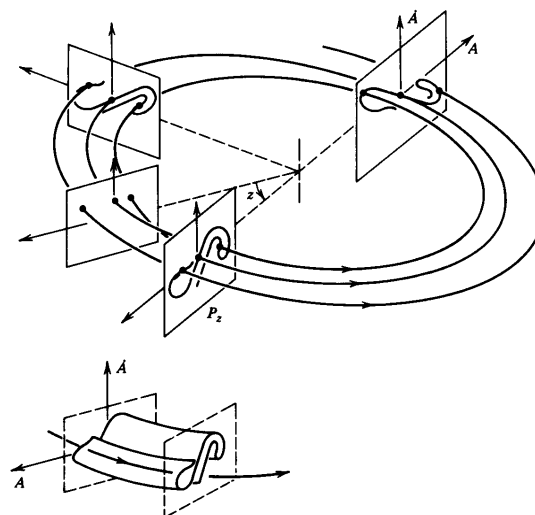

Figure 9. Poincaré section (Modified from Moon, 1992).

### Attractor and Fractal Dimension

The attractor dimension counts the effective number of degrees of freedom in a dynamical system. The term *chaotic* refers to the dynamics on the attractors while *strange* refers to its geometrical structure. There are different possible situations: chaotic attractors that are strange; chaotic attractors that are not strange; and also strange attractors that are not chaotic (Grebogi *et al.*, 1984). Usually, chaotic dynamical systems exhibit trajectories in their phase space that converges to a strange attractor. The strangeness of the chaotic attractor is associated with its dimension in which instance it is described by a noninteger dimension. Hausdorff (1919) gave a rigorous definition of dimension that is a basic property of an attractor.

There are a variety of forms to define or quantify the dimension of an attractor. Farmer *et al.* (1983) presents an overview of these definitions, considering two general types: those that depend only

on metric properties and those that depend on the frequency with which a typical trajectory visits different regions of the attractor. Furthermore, there is the Kaplan-Yorke conjecture that defines the Lyapunov dimension calculated from Lyapunov exponents (Kaplan & Yorke, 1983; Wolf *et al.*, 1985; Franca & Savi, 2001b).

A geometrically intuitive notion of dimension,  $D$ , is as an exponent that expresses the scaling of an object's bulk with its size:  $Bulk \sim Size^D$ . Here,  $Bulk$  may correspond to a volume, a mass, or even a measure of information content, while  $Size$  is a linear distance. Hence, the definition of dimension is usually cast as an equation of the form (Theiler, 1990),

$$D = \lim_{Size \rightarrow 0} \frac{\log(Bulk)}{\log(Size)}, \quad (2)$$

where the limit of small size is taken to ensure invariance over coordinate changes. This also implies that dimension is a local quantity and that any global definition of dimension require some kind of averaging.

Different definitions of these quantities imply different measures of dimensions. *Hausdorff* and *capacity* dimensions are some examples of fractal dimensions while *pointwise*, *information* and *correlation* dimensions are examples of dimension of the natural measure. Other definitions may be found in Farmer *et al.* (1983), Theiler (1990) and Franca & Savi (2001b).

### Lyapunov Exponents

Lyapunov exponent evaluates the sensitive dependence on initial conditions estimating the exponential divergence of nearby orbits. These exponents have been used as the most useful dynamical diagnostic tool for chaotic system analysis and can also be used for the calculation of other invariant quantities as the attractor dimension. The signs of these exponents provide a qualitative picture of the system's dynamics. The existence of positive Lyapunov exponents defines directions of local instabilities in the system dynamics and any system containing at least one positive exponent presents chaotic behavior. A response with more than one positive exponent is called as hyperchaos (Savi & Pacheco, 2002; Franca & Savi, 2003; Machado *et al.*, 2003).

The determination of Lyapunov exponents of dynamical system with an explicitly mathematical model, which can be linearized, is well-established from the algorithm proposed by Wolf *et al.* (1985). On the other hand, the determination of these exponents from time series is quite more complex. In essence, there are two different classes of algorithms: Trajectories, real space or direct method (Wolf *et al.*, 1985; Rosenstein *et al.*, 1993; Kantz, 1994); and perturbation, tangent space or Jacobian matrix method (Sano & Sawada, 1985; Eckmann *et al.*, 1986; Brown *et al.*, 1991; Briggs, 1990; Krueel *et al.*, 1993).

In order to understand the idea related to the determination of Lyapunov exponents consider a  $D$ -sphere of states that is transformed by the system dynamics in a  $D$ -ellipsoid. Lyapunov exponents are related to the expanding and contracting nature of different directions in phase space. The evaluation of the divergence of two nearby orbits is done considering the relation between the initial  $D$ -sphere and the  $D$ -ellipsoid (Figure 10). This variation may be expressed by:  $d(t) = d_0 b^{\lambda t}$ , where  $d$  is the diameter and  $b$  is a reference basis. The parameter  $\lambda$  is called as Lyapunov exponent and when it is negative or vanishes, trajectories do not diverge. On the other hand, when the exponent is positive, indicates that trajectories diverges, characterizing chaos.

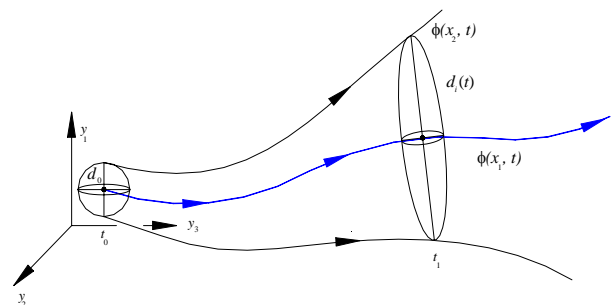

Figure 10. Estimation of Lyapunov exponents.

In chaotic situations, there is a local exponential divergence of nearby orbits and hence, it is necessary proper algorithms in order to evaluate Lyapunov exponents (Wolf *et al.*, 1985; Parker & Chua, 1989). These algorithms evaluate the average of this divergence considered in different points of the trajectory. Hence, when the distance  $d(t)$  becomes large, it is defined a new  $d_0(t)$  in order to evaluate the divergence, as follows:

$$\lambda = \frac{1}{t_n - t_0} \sum_{k=1}^n \log_b \left( \frac{d(t_k)}{d_0(t_{k-1})} \right). \quad (3)$$

The attractor dimension may be evaluated from the Lyapunov spectrum considering the Kaplan-Yorke conjecture (Kaplan & Yorke, 1983).

### Bifurcations

The term bifurcation was used for the first time by Poincaré in order to express a division of equilibrium solutions. In brief, bifurcation may be understood as a qualitative change in solution structure as a consequence of system parameters variations (Wiggins, 1990).

Bifurcation phenomenon is closed related to chaos and usually its analysis is developed considering local and global bifurcations. Local bifurcations are developed in a small region of phase space, usually, near to an equilibrium point. On the other hand, global bifurcation is non-local. There are many different forms of bifurcations depending on the dynamical systems characteristics. The formation of Smale horseshoe is a common type of global bifurcation. Local bifurcation of a dynamical system may be analyzed from its normal form,  $\dot{x} = f(x; \mu)$ ,  $x \in R^n$ ,  $\mu \in R^p$ , where  $\mu$  represents system parameters. The most common types of local bifurcation are presented in Figure 11: Saddle-node, transcritical, pitchfork and Hopf.

Bifurcation diagrams represent the stroboscopically sampled variable values under the slow quasi-static increase of some system parameter (Thompson & Stewart, 1986). These diagrams allow a global analysis of the parameter changes in the system response (Machado *et al.*, 2004). Figure 12 shows some typical bifurcation diagrams obtained from the logistic map. In this particular system, the route to chaos is represented by period doubling cascades. Enlargement of regions of bifurcation diagrams shows the process of bifurcation until the accumulation point is reached. After that, the system presents a chaotic response. Besides, it is important to notice that there are periodic windows inside chaotic regions.

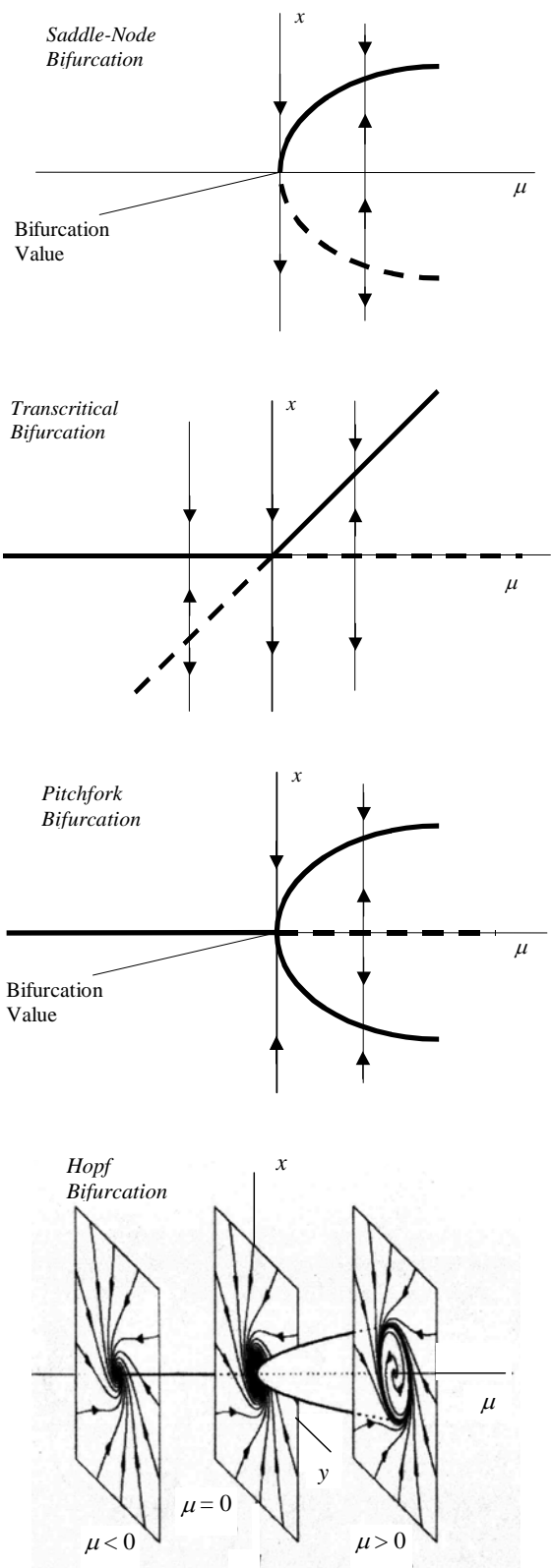

Figure 11. Types of local bifurcations.

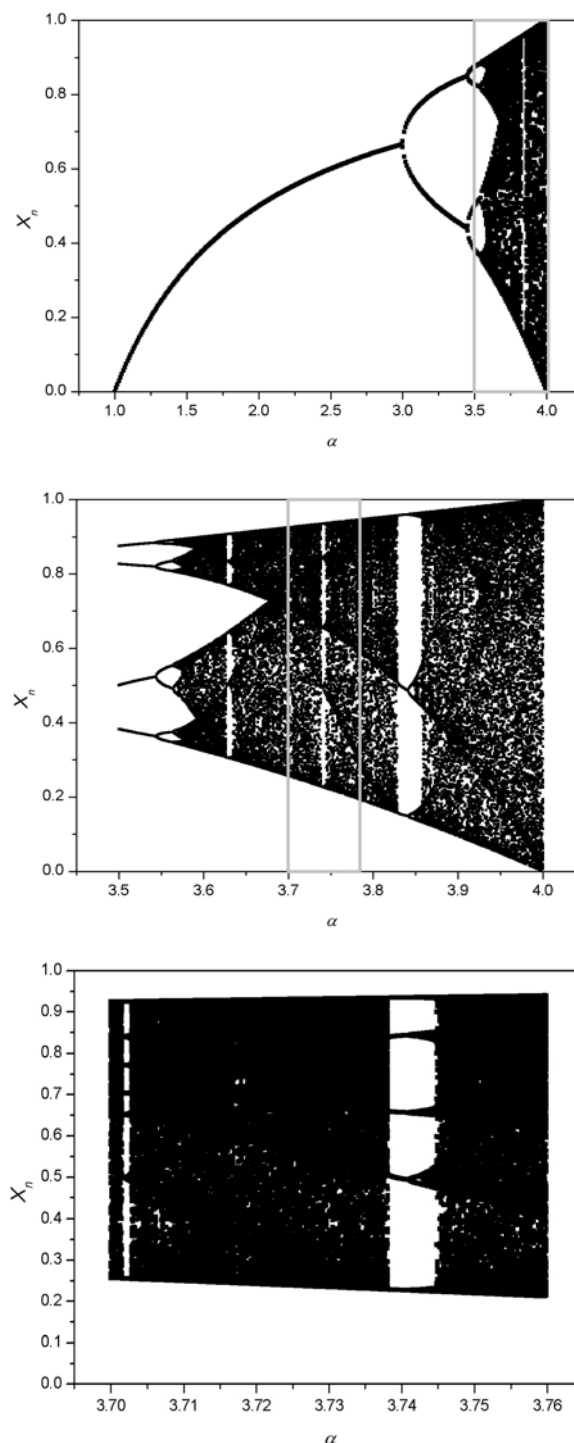

Figure 12. Bifurcation diagrams.

### Time Series Analysis

In general, a dynamical system is analyzed from its mathematical model. Alligood *et al.* (1997) say that “of course, the idea of a real experiment being governed by a set of equations is a fiction. A set of differential equations, or a map, may model the process closely enough to achieve useful goals”. An alternative approach to deal with the dynamical system response is based on the analysis of data derived from an experiment. Therefore, a dynamical system may be analyzed either by a mathematical model or by a measured time series. The basic idea of the time series analysis is



that a signal contains information about unobserved state variables, which can be used to predict the present state (Kantz & Schreiber, 1997, Franca & Savi, 2001a).

This approach is of particular interest in biomedical systems where different signals may be measured to monitor some physiological functioning. Representative physiological time series, extracted from Glass (2001) are shown in Figure 13. White blood cell count (neutropenia), heart rate (high altitude), stride time (Huntington’s disease), blood pressure (sleep apnoea) and Parkinsonian tremor of a finger are presented. Notice the complex characteristics of these signals.

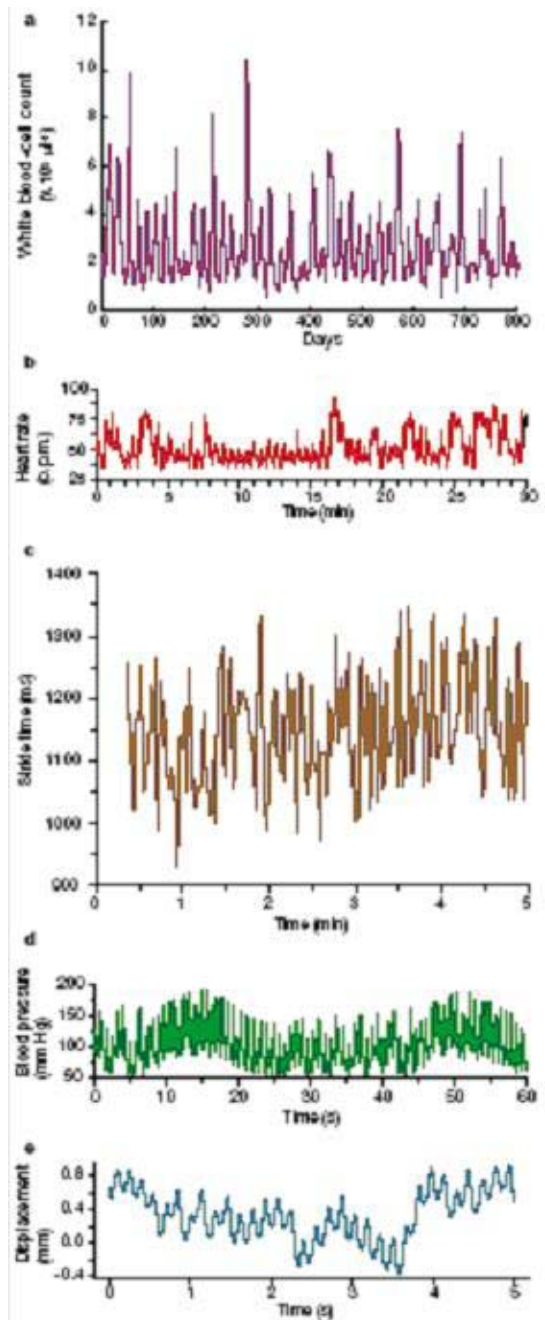

Figure 13. Representative physiological time series (Modified from Glass, 2001).

The first problem on the analysis of experimental signals is that data acquisition furnishes a time series of the observable measurements and it is necessary to convert observations into state vectors. On this basis, state space reconstruction needs to be employed. The other problem in the experimental data is the noise contamination, which is unavoidable in cases of data acquisition. Many studies are devoted to evaluate noise suppression and its effects in the chaos analysis, however, there are a small number of reports devoted to the effects of the system noise on chaos (Ogata *et al.*, 1997; Franca & Savi, 2001a).

**Power Spectrum**

A dynamical system may be analyzed either in time or in frequency domain. Spectrum techniques or Fourier transform establish a relationship between these two domains. The idea of a decomposition of a signal in trigonometric series is well-established in sciences and engineering. Fourier transform for a function  $s(t)$  is defined as:

$$\hat{s}(f) = \frac{1}{\sqrt{2\pi}} \int_{-\infty}^{\infty} s(t)e^{2\pi i f t} dt \tag{4a}$$

or, using a discrete version:

$$\hat{s}_k = \frac{1}{\sqrt{N}} \sum_{n=1}^N s_n e^{2\pi i k n / N} \tag{4b}$$

where  $f_k = k/N\Delta t$ ,  $k = -N/2, \dots, +N/2$  are frequencies while  $\Delta t$  is the sampling interval. The power spectrum of a process is defined to be the squared modulus of the continuous Fourier transform,  $S(f) = |\hat{s}(f)|^2$ , or in discrete version,  $S_k = |\hat{s}_k|^2$ .

A version of the discrete Fourier transform becomes popular because of its efficiency: FFT (*Fast Fourier Transform*). Press *et al.* (1992) show details of this technique available in many numerical packages, being very useful in the analysis of experimental signals. FFT is useful for the chaos characterization, being applied to system with low dimension (Moon, 1992). Frequently, the FFT of a chaotic signal presents continuous spectrum over a limited range. The energy is spread over a wider bandwidth. On the other hand, the FFT of a periodic signal presents discrete spectrum, where a finite number of frequencies contribute to the response (Moon, 1992; Mullin, 1993).

One of the clues to detecting chaos is the appearance of a broad spectrum of frequencies in the output when the input is a single-frequency harmonic motion. Therefore, even though these techniques are very useful, one must be cautioned on their application. In large degrees of freedom systems, for example, the use of the Fourier spectrum may not be of much help in detecting chaos. Hence, in many situations it may become difficult to distinguish noise and chaos. For these situations, there are other useful measures. Among linear tools, the autocorrelation function is an alternative (Mullin, 1993). Figure 14 shows the FFT of three different signals: periodic, chaotic and random.

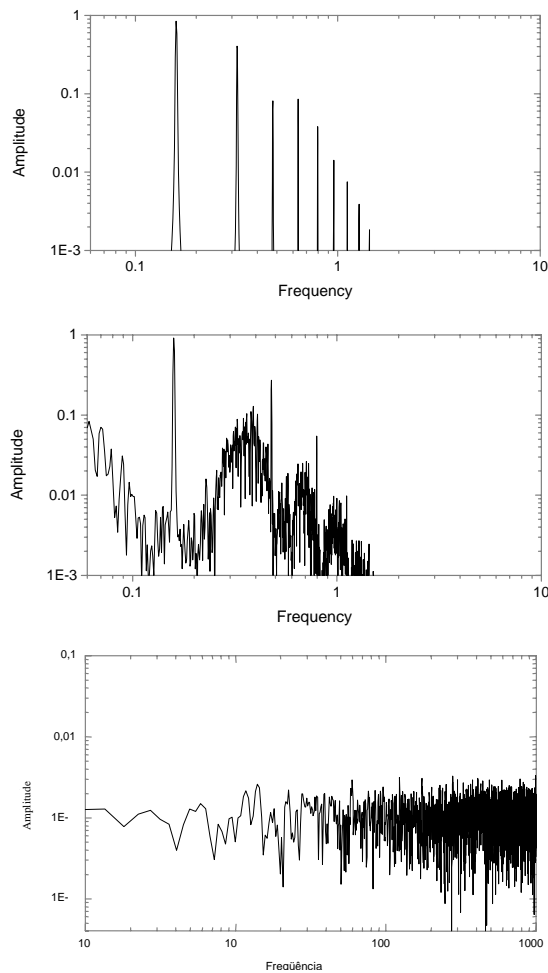

Figure 14. Comparison between FFT of three different signals: periodic, chaotic and random.

### State Space Reconstruction

The state space reconstruction establishes that a scalar time series,  $s(t)$ , may be used to construct a vector time series that is topological equivalent to the original dynamics. The state space reconstruction needs to form a coordinate system to capture the structure of orbits in state space. The method of delay coordinates can be done using lagged variables,  $s(t+\tau)$ , where  $\tau$  is the time delay. Then, considering an experimental signal,  $s(t)$ , where  $t = t_0 + (n-1)\Delta t$  with  $n = 1, 2, 3, \dots, N$ , it is possible to use a collection of time delays to create a vector in a  $D_e$ -dimensional space,  $u(t)$ , which represents the reconstructed dynamics of the system.

$$u(t) = \{s(t), s(t+\tau), \dots, s(t+(D_e-1)\tau)\}^T \quad (5)$$

The method of delays was first proposed by Ruelle (1979) and Packard (1980) and then by Takens (1981) and Sauer *et al.* (1991). Its use has become popular for dynamical reconstruction, and the choice of the delay parameters,  $\tau$  - time delay, and  $D_e$  - embedding dimension, is an important task related to this procedure. Among many possibilities to define the delay parameters (Franca & Savi, 2001a) one could mention the average mutual information method to determine time delay (Fraser, 1989) and the method of false nearest neighbors to estimate embedding dimension (Kennel *et al.*, 1992).

### Method of Mutual Information

Fraser & Swinney (1986) establishes that the time delay  $\tau$  corresponds to the first local minimum of the average mutual information function  $I(\tau)$ , which is defined as follows,

$$I(\tau) = \sum \Gamma_b(s(t), s(t+\tau)) \log_2 \left[ \frac{\Gamma_b(s(t), s(t+\tau))}{\Gamma_b(s(t))\Gamma_b(s(t+\tau))} \right] \quad (6)$$

where  $\Gamma_b(s(t))$  is the probability of the measure  $s(t)$ ,  $\Gamma_b(s(t+\tau))$  is the probability of the measure  $s(t+\tau)$ , and  $\Gamma_b(s(t), s(t+\tau))$  is the joint probability of the measure of  $s(t)$  and  $s(t+\tau)$ . The average mutual information is really a kind of generalization to the nonlinear phenomena from the correlation function in the linear phenomena. When the measures  $s(t)$  and  $s(t+\tau)$  are completely independent,  $I(\tau) = 0$ . On the other hand, when  $s(t)$  and  $s(t+\tau)$  are equal,  $I(\tau)$  is maximum. Therefore, plotting  $I(\tau)$  versus  $\tau$  it is possible to identify the best value for the time delay which is related to the first local minimum.

### Method of False Nearest Neighbors

The false nearest neighbors algorithm (FNN) was originally developed for determining the number of time delay coordinates needed to recreate autonomous dynamics, but it is extended to examine the problem of determining the proper embedding dimension.

In an embedding dimension that is too small to unfold the attractor, not all points that lie close to one another will be neighbors because of the dynamics. Some will actually be far from each other and simply appear as neighbors because the geometric structure of the attractor has been projected down onto a smaller space (Kennel *et al.*, 1992).

The method of false nearest neighbors, considers a  $D$ -dimensional space where the point  $u(t)$  has  $r$ th nearest neighbors,  $u^{(r)}(t)$ . The square of the Euclidean distance between these points is,

$$r_D^2(t, r) = \sum_{k=0}^{D-1} [s(t+k\tau) - s^{(r)}(t+k\tau)]^2 \quad (7)$$

Now, going from dimension  $D$  to  $D+1$  by time delay, there is a new coordinate system and, as a consequence, a new distance between  $u(t)$  and  $u^{(r)}(t)$ . When these distances alter from one dimension to another, there are false neighbors. A natural criterion for catching embedding errors is that the increase in distance between  $u(t)$  and  $u^{(r)}(t)$  is large when going from dimension  $D$  to  $D+1$ . The increase in distance can be stated with distance equations and some criteria must be established to designate the existence of false neighbors. Kennel *et al.* (1992) establishes proper criteria for this aim.

### Reconstruction from a Time Series

In order to illustrate the procedure presented for state space reconstruction, a general time series is shown as an example (Franca & Savi, 2001a; Pereira-Pinto *et al.*, 2004). Figure 15 shows the time series; the analysis of the embedding parameters employing the average mutual information method for the estimation of time delay and the method of false nearest neighbors to estimate embedding dimension; the state space reconstruction forming the phase space and also the Poincaré section showing a strange attractor.



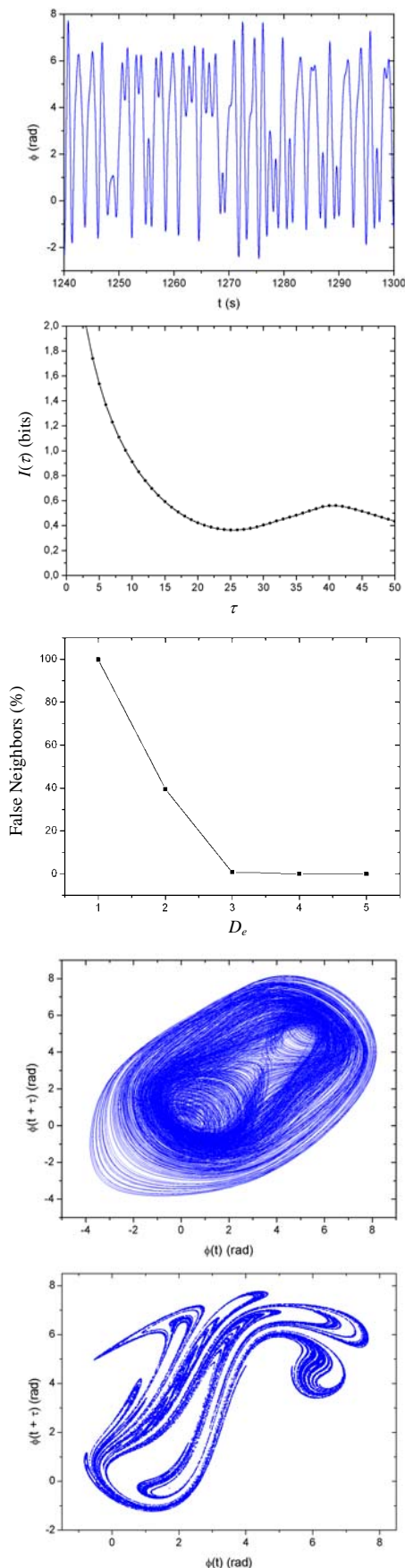

Figure 15. State space reconstruction from a time series.

### Chaos Control

Since biological systems usually adopt chaotic regimes with their wide range of potential behaviors in order to quickly react to some new situation, chaos control is an important task related to natural rhythms. This control is associated with many regulatory mechanisms that control the dynamics of living systems.

The mechanisms of chaos control were understood by the pioneer work of Ott *et al.* (1990) which propose the well-know OGY approach (a tribute to the authors Ott-Grebogi-Yorke). Essentially, chaos control is based on the richness of responses of chaotic behavior. A chaotic attractor has a dense set of unstable periodic orbits (UPOs) and the system often visits the neighborhood of each one of them. Besides, chaotic response has sensitive dependence on initial condition, which implies that the system’s evolution may be altered by small perturbations. Therefore, chaos control may be understood as the use of tiny perturbations for the stabilization of an UPO embedded in a chaotic attractor, which makes this kind of behavior to be desirable in a variety of applications, since one of these UPO can provide better performance than others in a particular situation.

The control of chaos can be thought as a two-stage process. The first stage is composed by the identification of UPOs and is named as “learning stage” (Gunaratne *et al.*, 1989). After the UPOs identification, one can proceed to the next stage of the control process that is the desired orbit stabilization, which can be done by different forms (Pereira-Pinto *et al.*, 2004). The OGY approach considers a discrete system with a map form,  $\xi_{i+1} = F(\xi_i, p)$ , where  $p \in \mathfrak{R}$  is a control accessible parameter. This is equivalent to a parameter dependent map associated with a general surface, usually a Poincaré section. Let  $\xi_F = F(\xi_F, p_0)$  denote the unstable fixed point on this section corresponding to an orbit in the chaotic attractor that one wants to stabilize. The control idea is to monitor the system dynamics until the neighborhood of this point is reached. After that, a proper small change in the parameter  $p$  causes the next state  $\xi_{i+1}$  to fall into the stable direction of the fixed point. This procedure may be understood as a stabilization of a sphere over a saddle, as it is schematically shown in Figure 16.

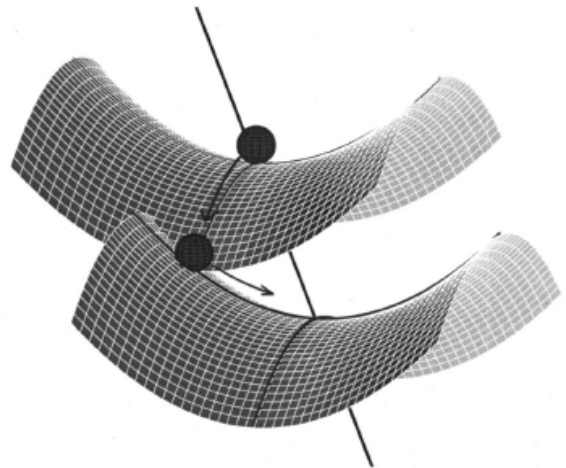

Figure 16. Schematically comprehension of the OGY control method (Modified from Ditto & Showalter, 1997).

In order to find the proper variation in the control parameter,  $\delta p$ , it is considered a linearized version of the dynamical system near the equilibrium point.

$$\delta \xi_{i+1} \cong A \delta \xi_i + w \delta p_i \tag{8}$$

where  $\delta\xi_i = \xi_i - \xi_F$ ,  $\delta p_i = p_i - p_0$ ,  $A = D_\xi F(\xi_F, p_0)$ , and  $w = \partial F / \partial p(\xi_F, p_0)$ .

The OGY method can be employed even in situations where a mathematical model is not available (Pereira-Pinto *et al.*, 2004, 2005). Under this situation, all parameters can be extracted from time series analysis. The Jacobian  $A$  and the sensitivity vector  $w$  can be estimated from time series using a least-square fit method as described in Auerbach *et al.* (1987) and Otani & Jones (1997).

## Cardiovascular Rhythms

Rhythmic changes of blood pressure, heart rate and other cardiovascular measures indicate the importance of dynamical aspects in the comprehension of cardiovascular rhythms. Several studies are pointing to the fact that certain cardiac arrhythmias are instances of chaos. This is important because it may suggest different therapeutic strategies, changing classical approaches. Among cardiac arrhythmia, one can cite premature beats, atrial fibrillation, bradycardia, tachycardia and ventricular arrhythmias.

Ventricular arrhythmias, as ventricular fibrillations and ventricular tachycardia, are the most severe and life-threatening arrhythmias being the cause of many deaths. Cardiac fibrillation may be understood as a spontaneous, asynchronous contraction of cardiac muscle fibers. Ventricular fibrillation is a frenzied and irregular disturbance of the heart rhythm that quickly renders the heart incapable of sustaining life. On the other hand, ventricular tachycardia is a rapid heartbeat arising in the ventricles.

Heart rate variability (HRV) is one of the best predictors of arrhythmic events or sudden death after myocardial infarction (Mansier *et al.*, 1996). HRV are partially modulated by the autonomic nervous system control of heart activity. Short-term variability is mediated by the parasympathetic system, while long-term variability by both the sympathetic and parasympathetic pathways. HRV may vary considerably even in the absence of physical or mental stress and several measures of HRV have been applied for clinical and research purposes.

There are different forms to evaluate the heart functioning by the measurement of some signal. A *tachogram* presents heart rate as a function of time. Basically, it shows a curve of registered time (or interval number) versus interval duration. An *electrocardiogram* (ECG) records the electrical activity of the heart being used to measure the rate and regularity of heartbeats as well as the size and position of the chambers. The electrical impulses related to heart functioning are recorded in the form of waves, which represents the electrical current in different areas of heart.

Several studies have established a relation between cardiac arrhythmias and chaos. This is related to the deterministic characteristics of some of these arrhythmias (Witkowski *et al.*, 1995; Radhakrishna *et al.*, 2000). Since chaotic responses may be controlled by an efficient way using OGY method or its variants, this may inspire some interesting approaches in order to stabilize unstable orbits associated with the normal heart rhythm.

The clinical arrhythmias that have the greatest potential for therapeutic applications of chaos theory are the aperiodic tachyarrhythmias, including atrial and ventricular fibrillation. Garfinkel *et al.* (1992) and Garfinkel *et al.* (1995) discuss the application of chaos control techniques in order to avoid heart arrhythmic responses. This approach may be incorporated into pacemakers, avoiding ventricular fibrillation, for example.

Voss *et al.* (1996) presents interesting comparisons between dynamics characteristics of healthy persons and patients with high risk of sudden cardiac death. The authors show evidences relating chaotic response of heart signals (tachograms and ECGs) with cardiac arrhythmias.

Therefore, based on the hypothesis that some arrhythmias are related to chaotic response of the heart, it is possible to employ some chaos control technique, making the heart response rhythmic. Moreover, it is possible to say that nonlinear dynamics are promising to be applied to clinical issue, being an important tool to diagnostic diseases and also to predict some pathological behaviors. On this basis, the application of different nonlinear tools has a growing importance.

## Brain Rhythms

The richness of chaos offers benefits for a biological system of adopting chaotic regimes with their wide range of potential behaviors. Under this condition, the system may quickly react to some new situation, changing conditions and their response. Korn & Faure (2003) say that “*there is a growing evidence that future research on neural systems and higher brain functions will be a combination of classical (sometimes called reductionist) neuroscience with more recent nonlinear science*”. The search for chaos in neurodynamics starts in the 1980s with the analysis of electroencephalogram (EEGs) oscillations in rabbits (Freeman, 2000; Korn & Faure, 2003).

In brief, it is possible to say that the brain together with the nervous system controls all the functioning of the live being. Sensory nerves carry messages from the sense organs to the brain for processing, and then, the brain sends instructions in response through other specialized nerves to the physical parts of the body, such as the muscles, that can carry out its commands.

An EEG reflects the electrical activity of the brain. The structure of EEG signal is non-stationary and results from a combination of nonlinearities and random perturbations (Diambra *et al.*, 2001). Nowadays, many authors point that normal EEG signal has higher complexity while pathological signals (related to epileptic seizures, for example) exhibit low dimensional chaos.

Neuronal cells possess a large repertoire of firing patterns. A single cell can behave in different modes and this richness is controlled by external inputs. Recent investigations on isolated cells have shown that dynamical information can be preserved when a chaotic input is converted into a spike train (Korn & Faure, 2003).

The study of neurodynamics varies from mathematical modeling to time series analysis. Faure & Korn (2001) and Korn & Faure (2003) present a complete review of the main topics related to the brain dynamics. It should be pointed out that deterministic chaos offers a striking explanation for apparently irregular behavior. In brief, it is possible to say that certain pathological patterns of the brain may be associated with some kind of synchronization in brain functioning. Sarbadhikari & Chakrabarty (2001) says that neuronal network may present essentially different kinds of dynamical responses and each one can be related to different brain activity as epilepsy, depression, exercise and lateralization.

Epileptic processes exhibit high frequency discharges scarcely modulated by physiological brain activity (Lehnertz & Elger, 1995). There is a growing agreement that epileptic seizure is related to a loss of the complexity of brain signals, reflected in EEG, for example. Despite the difficulties to apply the classical nonlinear tools in order to assure this conclusion, as Lyapunov exponents and fractal dimension (Theiler, 1995), many authors are presenting new arguments that emphasize this condition (Lehnertz, 1999). Sackellares *et al.* (1999) argue that epileptic brains repeatedly make the abrupt transitions into and out of the ictal state because the epileptogenic focus drives them into self-organizing phase transitions from chaos to order. Furthermore, the authors postulate that the seizure serves to reset the system.

Despite all evidences, it should be pointed out all difficulties to characterize chaos in brain. Lai *et al.* (2003) presents an article

arguing the inability of Lyapunov exponents in order to predict epileptic seizures. Noise contamination is one of the drawbacks associated with this evaluation (Franca & Savi, 2003). Spatiotemporal characteristic of the brain activity is probably other drawback for this estimation.

Parkinson's disease is another pathology related to brain rhythms. Basically, it is a serious neurological disorder with a broad spectrum of symptoms, including a large amplitude and low frequency tremor. The origin of the Parkinsonian tremor is not well understood. Titcombe *et al.* (2001) shows a study where high frequency, electrical deep brain stimulation can suppress tremor in Parkinson's disease. The authors agree that the mechanism related to this behavior is a supercritical Hopf bifurcation, showing the evidence of the dynamics characteristics of the phenomenon.

Another psychosomatic disorder that can be associated with brain dynamics is the depression. The alteration of biological rhythms causes a decrease of complexity in brain activity, which can be identified by EEG (Pezard *et al.*, 1996).

As a final remark concerning with brain rhythms, one can say that brain activity is clearly related to complex dynamics, and there are evidences that its electrical activity is chaotic. Changes in control systems can promote qualitative changes in brain rhythms, leading to abnormal dynamics. The loss of complexity may be related to some diseases as epilepsy and depression.

### Cellular and Molecular Rhythms

Cellular and molecular rhythms find their roots in many regulatory mechanisms that control the dynamics of life. There are many modes of cellular regulation that generates oscillations in genetic and metabolic networks (Goldbeter, 2002). Aspects of pattern formation in different biological phenomena constitute an area of increasing importance in different fields of science (Cross & Hohenberg 1993; Gollub & Langer, 1999).

Several studies have been developed proposing mathematical models for different cellular or molecular processes. Goldbeter (2002) presents a general overview of some important features related to cell rhythms, analyzing calcium oscillations and circadian rhythms. Perc & Marhl (2003b) presents different models to study different types of bursting  $Ca^{2+}$ . Aon *et al.* (2000) presents another review discussing coupling between the biochemical reactions dynamics and the geometry of cytoarchitecture observing its importance in the cells behavior.

Calcium oscillation is a fundamental mechanism related to cellular processes, which controls the complex behavior of biological systems. Intracellular  $Ca^{2+}$  oscillations are observed in a large variety of cell types including cardiac cells, oocytes and hepatocytes. The mechanisms of these oscillations have been intensely investigated both from experimental and theoretical point of view. Calcium has to play a multiplicity of roles in order to trigger different cellular functions. Therefore, flexible, yet precisely regulated, information encoding of  $Ca^{2+}$  oscillations in their frequency as well as in their amplitude is required (Perc & Marhl, 2003a). Although most of the experimental data show simple periodic oscillations, some others show more complex periodic behavior resembling bursting. Actually, chaos and bursting have been observed in Calcium dynamics. Borghans *et al.* (1997) presents some mathematical model that can capture the general behavior of Calcium oscillations for different kinds of response.

Besides this intracellular oscillation, some extracellular signals are produced in a pulsatile manner. As example of this intercellular communication, one can cite the episodic hormone secretion and pulsatile signals of cAMP in the slime mould *Dictyostelium discoideum* (Goldbeter, 2002).

Another important class of biological rhythms is called circadian rhythms which are related to a period close to 24 hours that allow organisms to adapt to periodic variations in the terrestrial environment. These rhythms originate from the negative autoregulation of gene expression. Important insights into the molecular mechanisms underlying circadian rhythm generation have been gained from the study of organisms such as *Drosophila*. Leloup & Goldbeter (1999) presents a discussion of circadian oscillations in the levels of two proteins (PER and TIM), presenting situations where there are chaotic oscillations. Moreover, Goldbeter (2002) presents results of mathematical model for the mammalian circadian clock providing cues for circadian rhythms sleep disorders in humans.

Glycolysis is another phenomenon where rhythms can vary from order to chaos. Basically, glycolysis is the major source of metabolic energy in almost all living cells. In this process, the sugar molecule is converted into the product via a series of enzyme-catalyzed reactions. Glycolysis constitutes a dynamical system that can present complex behaviors, varying from simple and sustained oscillations and also chaos. Kar & Ray (2003) analyzed collapse and revival of glycolytic oscillation using a model proposed by Goldbeter (1996). In this analysis, limit cycle is the central characteristics of the dynamics of this system. On the other hand, Nielsen *et al.* (1997) shows chaotic behavior related to glycolysis. The authors agree that chaos have been induced by time dependent forcing with periodic varying flow of glucose. Nielsen *et al.* (1998) also presents experimental results related to this behavior, proposing a mathematical model to analyze the phenomenon.

At this point, it should be pointed out that, once again, the analysis of biological rhythms related to cellular and molecular dynamics may be very rich, presenting either regular or irregular behaviors. Chaos occurs in different situations, showing the richness related to biomedical rhythms.

### Conclusions

This review article discusses chaos and order in biomedical rhythms. Initially, it is presented a historical review of the chaos study. Then, a brief overview concerning chaotic behavior presents the main tools related to the nonlinear systems analysis. Chaos presents sensitive dependence on initial conditions being associated with the existence of the Smale horseshoe. Therefore, a system needs to have nonlinear characteristics and at least three dimensions in order to present a chaotic response. In general, chaos is related to a fractal structure having a strange attractor. Lyapunov exponents is the most effective diagnostic tool of chaos, and a system with one positive exponent presents chaotic behavior while more than one exponent is related to hyperchaos. Besides, chaos has a richness associated with an infinity number of unstable periodic orbits, which may be very interesting in biomedical systems since they can quickly react to some perturbation. Some tools related to the analysis of nonlinear time series is presented, which is useful in situations where a mathematical model is not available. Chaos control, which may be understood as the use of tiny perturbations for the stabilization of an unstable periodic orbit embedded in a chaotic attractor, is also discussed. This procedure may be useful in many applications being an important mechanism of biological systems. Finally, this article discusses some applications of the nonlinear analysis in cardiovascular, brain and cellular rhythms, using a dynamical approach. It should be pointed out that some diseases may be understood as a change in physiological system that causes alteration on natural rhythms. On this basis, it is possible to say that physiological rhythms constitute a central characteristic of life, and natural rhythms could be either periodic or irregular over time and space. Each kind of these dynamical behaviors may be

related to both normal and pathological physiological functioning. Therefore, chaos plays an important role in natural rhythms, being responsible to the flexibility of biomedical systems. As a consequence, the applications of nonlinear tools are becoming noticeable in the biomedical field.

## Acknowledgements

The author would like to acknowledge the support of the Brazilian Research Council (CNPq).

## References

- Anokhin, A. P., Lutzenberger, W., Birbaumer, N. (1999), "Spatiotemporal Organization of Brain Dynamics and Intelligence: An EEG Study in Adolescents", *International Journal of Psychophysiology*, v.33 pp.259-273.
- Alligood, K. T., Sauer, T. D. & Yorke, J. A. (1997), "*Chaos: An Introduction to Dynamical Systems*", Springer-Verlag.
- Aon, M.A., Cortassa, S. & Lloyd, D. (2000), "Chaotic Dynamics and Fractal Space in Biochemistry: Simplicity Underlies Complexity", *Cell Biology International*, v.24, n.8, pp.581-587.
- Awrejcewicz, J. (1991), "*Bifurcation and Chaos in Coupled Oscillators*", World Scientific.
- Barnsley, M. (1988), "*Fractals Everywhere*", Academic Press.
- Barreto, E., Hunt, B. R., Grebogi, C. & Yorke, J. A. (1997), "From High Dimensional Chaos to Stable Periodic Orbits: The Structure of Parameter Space", *Physical Review Letters*, v.78, n.24, pp.4561-4564.
- Borghans, J.A.M., DuPont, G. & Goldbeter, A. (1997), "Complex Intracellular Calcium Oscillations - A Theoretical Exploration of Possible Mechanisms", *Biophysical Chemistry*, v.66, pp.25-41.
- Briggs, K. (1990), "An improved Method for Estimating Lyapunov Exponents of Chaotic Time Series", *Physics Letters A*, v.151, pp.27-32.
- Briggs, J. & Peat, F. D. (2000), "*A Sabedoria do Caos*", Campus.
- Brown, R., Bryant, P. & Abarbanel, H. D. I. (1991), "Computing the Lyapunov spectrum of a dynamical system from an observed time series", *Physical Review A*, v.43, pp.2787-2806.
- Cross, M.C. & Hohenberg, P.C. (1993), "Pattern Formation Outside of Equilibrium", *Reviews of Modern Physics*, v.65, n.3, pp.851-1122.
- Diambra, L., Malta, C. P., Capurro, A., Fernandez, J. (2001), "Nonlinear Structures in Electroencephalogram Signals", *Physica A*, v.300, p.505-520.
- Ditto, W.L. & Showalter, K. (1997), "Introduction: Control and Synchronization of Chaos", *Chaos*, v.7, n.4, pp.509-511.
- Eckmann, J. -P., Kamphorst, S. O., Ruelle, D. & Ciliberto, S. (1986), "Lyapunov Exponents From Time Series", *Physical Review A*, v.34, pp.4971-4979.
- Farmer, J. D., Ott, E. & Yorke, J. A. (1983), "The Dimension of Chaotic Attractors", *Physica 7D*, pp.153-180.
- Faure, P. & Korn, H. (2003) "Is There Chaos in the Brain? I. Concepts of Nonlinear Dynamics and Methods of Investigation", *C.R. Acad. Sci. Paris, Life Sciences*, v.324, pp.773-793.
- Ferriere, R. & Fox, G. A. (1995), "Chaos and Evolution", *Trends in Ecology and Evolution*, v.10, n.12, pp.480-485.
- Franca, L. F. P. & Savi, M. A. (2001a), "Distinguishing Periodic and Chaotic Time Series Obtained from an Experimental Nonlinear Pendulum", *Nonlinear Dynamics*, v.26, n.3, 2001, pp.253-271.
- Franca, L.F.P. & Savi, M.A. (2001b), "Estimating Attractor Dimension on the Nonlinear Pendulum Time Series", *Journal of the Brazilian Society of Mechanical Sciences and Engineering*, v. XXIII, n.4, 2001, pp.427-439.
- Franca, L. F. P. & Savi, M. A. (2002), "Evaluating Noise Sensitivity on the Time Series Determination of Lyapunov Exponents Applied to the Nonlinear Pendulum", *Shock and Vibration*, v.10, n.1, pp.37-50, 2003.
- Fraser, A. M. (1989), "Reconstructing Attractors from Scalar Time Series: A Comparison of Singular System and Redundancy Criteria", *Physica D*, v.34, pp.391-404.
- Fraser, A. M. & Swinney, H. L. (1986), "Independent Coordinates for Strange Attractors from Mutual Information", *Physical Review A*, v.33, pp.1134-1140.
- Freeman, W. J. (2000), "*Neurodynamics: An Exploration in Mesoscopic Brain Dynamics, Perspectives in Neural Coding*", Springer.
- Garfinkel, A., Spano, M. L., Ditto, W. L. & Weiss, J. N. (1992), "Controlling Cardiac Chaos", *Science*, v.257, pp.1230-1235.
- Garfinkel, A., Weiss, J. N., Ditto, W. L. & Spano, M. L. (1992), "Chaos Control of Cardiac Arrhythmias", *Trends in Cardiovascular Medicine*, v.5, n.2, pp.76-80.
- Gilbert, D.A., Visser, G., Ferreira, G.M.N. & Hammond, K.D. (2000), "Transient Chaos in Intracellular Dynamics?", *Cell Biology International*, v.24, n.8, pp.589-591.
- Glass, L. (2001), "Synchronization and Rhythmic Processes in Physiology", *Nature*, v.410, March, pp.277-284.
- Gleick, J. (1987), "*Chaos*", Campus.
- Goldbeter, A. (1996), "*Biochemical Oscillations and Cellular Rhythms*", Cambridge University Press.
- Goldbeter, A. (2002), "Computational Approaches to Cellular Rhythms", *Nature*, v.420, November, pp.238-245.
- Goldberger, A., Ringney, D. & West, B. (1990), "Chaos and Fractal in Human Physiology", *Scientific American*, v.262, n.2, pp.34-41.
- Gollub, J.P. & Langer, J.S. (1999), "Pattern Formation in Nonequilibrium Physics", *Reviews of Modern Physics*, v.71, n.2, pp.S396-S403.
- Grebogi, C., Ott, E. & Yorke, J.A. (1983), "Crises, Sudden Changes in Chaotic Attractors, and Transient Chaos", *Physica 7D*, pp.181-200.
- Grebogi, C., Ott, E., Pelikan, S. & Yorke, J. (1984), "Strange Attractors that are not Chaotic", *Physica 13D*, pp.261-268.
- Guckenheimer, J. & Holmes, P. (1983), "*Nonlinear Oscillations, Dynamical Systems, and Bifurcations of Vector Fields*", Springer-Verlag, New York.
- Hausdorff, F. (1919), "Dimension und Äusseres Mass", *Math. Annalen*, v.9, pp.157.
- Hegger, R., Kantz, H. & Schreiber, T. (1999), "Practical Implementation of Nonlinear Time Series Methods: The Tisean Package", *Chaos*, v.9, pp.413-435.
- Hu, G., Xiao, J., Yang, J., Xie, F., Qu, Z., 1997, "Synchronization of Spatiotemporal Chaos and Its Applications", *Physical Review E*, v. 56, n.3, pp.2738-2746.
- Huikuri, H. V., Makikallio, T. H. & Perkiomaki, J. (2003), "Measurement of Heart Rate Variability by Methods Based on Nonlinear Dynamics", *Journal of Electrocardiology*, v.36, pp.95-99.
- Ivanov, P. Ch., Amaral, L. A. N., Goldberger, A. L., Havlin, S., Rosenblum, M. G., Struzick, Z. R. & Stanley, H. E. (1999), "Multifractality in Human Heartbeat Dynamics", *Nature*, v.399, June, pp.461-465.
- Kantz, H. & Schreiber, T. (1997), "*Nonlinear Time Series Analysis*", Cambridge.
- Kaplan, J.L. & Yorke, J.A. (1983), "The Lyapunov Dimension of Strange Attractors", *Journal of Differential Equations*, v.49, pp.185.
- Kar, S. & Ray, D.S. (2003), "Collapse and Revival of Glycolytic Oscillation", *Physical Review Letters*, v.90, n.23, pp.238102-1/4.
- Kennel, M. B., Brown, R. & Abarbanel, H. D. I. (1992), "Determining Embedding Dimension from Phase-Space Reconstruction Using a Geometrical Construction", *Physical Review A*, v.25, pp.3403-3411.
- Korn, H. & Faure, P. (2003) "Is There Chaos in the Brain? II. Experimental Evidence", *Comptes Rendus Biologies*, v.326, pp.787-840.
- Kruegel, TH. M., Eiswirth, M. & Schneider, F. W. (1993), "Computation of Lyapunov Spectra: Effect of Interactive Noise and Application to a Chemical Oscillator", *Physica D*, v.63, pp.117-137.
- Lai, Y. C. & Grebogi, C. (1999), "Modeling of Coupled Chaotic Oscillators", *Physical Review Letters*, v.82, n.24, pp.4803-4806.
- Lehnertz, K. (1999), "Non-linear Time Series Analysis of Intracranial EEG Recordings in Patients with Epilepsy - An Overview", *International Journal of Psychophysiology*, v.34, pp.45-52.
- Lehnertz, K. & Elger, C.E. (1998), "Can Epileptic Seizures be Predicted? Evidence from Nonlinear Time Series Analysis of Brain Electrical Activity", *Physical Review Letters*, v.80, n.22, pp.5019-5022.
- Lehnertz, K. & Elger, C.E. (1995), "Spatio-temporal Dynamics of the Primary Epileptogenic Area in Temporal Lobe Epilepsy Characterized by Neuronal Complexity Loss", *Electroencephalography and Clinical Neurophysiology*, v.95, pp.108-117.
- Leloup, J.C. & Goldbeter, A. (1999), "Chaos and Bihybridity in a Model for Circadian Oscillations of the PER and TIM Proteins in *Drosophila*", *Journal of Theoretical Biology*, v.198, pp.334-348.
- Lorenz, E. N. (1996), "*A Essência do Caos*", Editora UnB.
- Lorenz, E. N. (1963), "Deterministic Nonperiodic Flow", *Journal of Atmospheric Science*, v.20, pp.130-141.
- Machado, L. G., Savi, M. A. & Pacheco, P. M. C. L. (2004), "Bifurcations and Crises in a Shape Memory Oscillator", *Shock and Vibration*, v.11, n.2, pp.67-80.
- Machado, L. G., Savi, M. A. & Pacheco, P. M. C. L. (2003), "Nonlinear Dynamics and Chaos in Coupled Shape Memory Oscillators", *International Journal of Solids and Structures*, v.40, n.19, pp.5139-5156.
- Mandelbrot, B. B. (1982), "*The Fractal Geometry of Nature*", Freeman.
- Mansier, P., Clairambault, J., Charlotte, N., Medigue, C. Vermeiren, C., LePape, G., Carre, F., Gounaropoulou, A., Swynghedauw, B. (1996),

- "Linear and Non-linear Analyses of Heart Rate Variability: A Minireview", *Cardiovascular Research*, v.31, pp.371-379
- May, R. M. (1976), "Simple Mathematical Models with Very Complicated Dynamics", *Nature*, v.261, pp.459-467.
- Mees, A. I. & Sparrow, C. (1987), "Some Tools for Analyzing Chaos", *Proceedings of the IEEE*, v.75, n.8, pp.1058-1070.
- Moon, F. C. (1992), "*Chaotic and Fractal Dynamics*", John Wiley & Sons, New York.
- Nicolis, G. & Prigogine, I. (1989), "*Exploring Complexity*", Freeman.
- Nielsen, K., Sørensen, P.G. & Hynne, F. (1997), "Chaos in Glycolysis", *Journal of Theoretical Biology*, v.186, pp.303-306.
- Nielsen, K., Sørensen, P. G., Hynne, F. & Busse, H.-G. (1998), "Sustained Oscillations in Glycolysis: An Experimental and Theoretical Study of Chaotic and Complex Periodic Behavior and of Quenching of Simple Oscillations", *Biophysical Chemistry*, v.72, n.1-2, pp.49-62.
- Ott, E., Grebogi, C., Yorke, J. A. (1990), "Controlling Chaos", *Physical Review Letters*, v.64, n.11, pp.1196-1199.
- Packard, N. J., Crutchfield, J. P., Fromer, J. D. & Shaw, R. S. (1980), "Geometry from a Time-Series", *Physical Review Letters*, v.45, n.9, pp.712-716.
- Paladin, G. & Vulpiani, A. (1987), "Anomalous Scaling Laws in Multi-Fractal Objects", *Physical Reports – Review Section of Physics Letters*, v.156, n.4, pp.147-225.
- Parker, T.S. & Chua, L.O. (1989), "*Practical Numerical Algorithms for Chaotic Systems*", Springer-Verlag.
- Peel, D. A. & Speight, A. E. H. (1994), "Hysteresis and Cyclical Variability in Real Wages, Output and Unemployment - Empirical-Evidence from Nonlinear Methods for the United-States", *International Journal Systems Science*, v.25, n.5, pp.943-965.
- Perc, M. & Marhl, M. (2003a), "Sensitivity and Flexibility of Regular and Chaotic Calcium Oscillations", *Biophysical Chemistry*, v.104, pp.509-522.
- Perc, M. & Marhl, M. (2003b), "Different Types of Bursting Calcium Oscillations in Non-Excitable Cells", *Chaos, Solitons & Fractals*, v.18, pp.759-773.
- Pereira-Pinto, F. H. I., Ferreira, A. M. & Savi, M. A. (2004), "Chaos Control in a Nonlinear Pendulum Using a Semi-Continuous Method", *Chaos, Solitons & Fractals*, v.22, n.3, pp.653-668.
- Pereira-Pinto, F. H. I., Ferreira, A. M. & Savi, M. A. (2005), "State Space Reconstruction Using Extended State Observers to Control Chaos in a Nonlinear Pendulum", *International Journal of Bifurcation and Chaos*, to appear.
- Pezard, L., Nandrino, J.L., Renault, B., Massiouri, F.E., Allolaire, F., Muller, J., Varela, F.J. & Martinerie, J. (1996), "Depression as a Dynamical Disease", *Biological Psychiatry*, v.39, n.12, pp.991-999.
- Press, W. H., Teukolsky, S. A., Vetterling, W. T. & Flannery, B. P. (1992), "*Numerical Recipes in C – The Art of Scientific Computing*", Cambridge University Press.
- Prigogine, I. (1980), "*From Being to Becoming*", W.H. Freeman and Company.
- Radhakrishna, R. K. A., Dutt, D. N., Yeragani, V. K. (2000), "Nonlinear Measures of Heart Rate Time Series: Influence of Posture and Controlled Breathing", *Autonomic Neuroscience: Basic and Clinical*, v.83, pp.148-158.
- Ruelle, D. (1979), "Ergodic Theory of Differentiable Dynamical Systems", *Mathématique de l'Institut des Hautes Études Scientifiques*, n.5, pp.27.
- Sackellares, J.C., Iasemidis, L.D., Shiau, D.S., Gilmore, R.L. & Roper, S.N. (1999), "Epilepsy – When Chaos Fails", in *Chaos in the Brain?*, Ed. K. Lehnertz & C.E. Elger, World Scientific.
- Sano, M. & Sawada, Y. (1985), "Measurement of the Lyapunov spectrum from a chaotic time series", *Physical Review Letters*, v.55, pp.1082-1085.
- Sarbadhikari, S.N. & Chakrabarty, K. (2001), "Chaos in the Brain: A Short Review Alluding to Epilepsy, Depression, Exercise and Lateralization", *Medical Engineering & Physics*, v.23, pp.445-455.
- Sauer, T., Yorke, J. A. & Casdagli, M. (1991), "Embedology", *Journal of Statistical Physics*, v.3/4, n.65, pp.579-616.
- Savi, M. A. & Pacheco, P. M. C. L. (2002), "Chaos and Hyperchaos in Shape Memory Systems", *International Journal of Bifurcation and Chaos*, v.12, n.3, 2002, pp.645-657.
- Schiff, S.J., Jerger, K., Duong, D.H., Chang, T., Spano, M.L. & Ditto, W.L. (1994), "Controlling Chaos in the Brain", *Nature*, v.370, August, pp.615-620.
- Schaffer, W.M. (1985), "Order and Chaos in Ecological Systems", *Ecology*, v.66, n.1, pp.93-106.
- Shibata, H. (1998), "Quantitative Characterization of Spatiotemporal Chaos", *Physica A*, v.252, pp.428-449.
- Singer, I. M. & Thorpe, J. A. (1967), "*Lecture Notes on Elementary Topology and Geometry*", Scott, Foresman & Company.
- Stewart, I. (1991), "*Será que Deus Joga Dados? A Nova Matemática do Caos*", Jorge Zahar Editor.
- Strogatz, S. H. (1994), "*Nonlinear Dynamics and Chaos*", Perseus.
- Takens, F. (1981), "Detecting Strange Attractors in Turbulence", *Warwick, Lecture notes in Mathematics*, v.898, Ed. D. Rand & L.-S Young, Springer, pp.366-381.
- Theiler, J. (1990), "Estimating fractal dimension", *Journal of Optical Society of America*, v.7, pp.1055-1073.
- Theiler, J. (1995), "On the Evidence for Low-dimensional Chaos in an Epileptic Electroencephalogram", *Physics Letters A*, v.196, pp.335-341.
- Titcombe, M.S., Glass, L., Guehl, D., Beulter, A. (2001), "Dynamics of Parkinsonian Tremor During Deep Brain Stimulation", *Chaos*, v.11, n.4, pp.766-773.
- Thompson, J. M. T & Stewart, H. B. (1986), "*Nonlinear Dynamics and Chaos*", John Wiley & Sons, Chichester.
- Umberger, D. K., Grebogi, C., Ott, E. & Afeyan, B. (1989), "Spatiotemporal Dynamics in a Dispersively Coupled Chain of Nonlinear Oscillators", *Physical Review A*, v.39, n.9, pp.4835-4842.
- Van Dyke, M. (1982), "*An Album of Fluid Motion*", Parabolic Press.
- Voss, A., Kurths, J., Kleiner, H.J., Witt, A., Wessel, N., Saparin, P., Osterziel, K.J., Schurath, R., Dietz, R. (1996), "The Application of Methods of Non-linear Dynamics for the Improved and Predictive Recognition of Patients Threatened by Sudden Cardiac Death", *Cardiovascular Research*, v.31, pp.419-433.
- Wagner, C.D. & Persson, P.B. (1998), "Chaos in the Cardiovascular System: An Update", *Cardiovascular Research*, v.40, pp.257-264.
- Wiggins, S. (1990), "*Introduction to Applied Nonlinear Dynamical Systems and Chaos*", Springer-Verlag, New York.
- Witkowski, F. X., Kavanagh, K. M., Penkoske, P. A., Plonsey, R., Spano, M. L., Ditto, W. L. & Kaplan, D. T. (1995), "Evidence for Determinism in Ventricular Fibrillation", *Physical Review Letters*, v.75, n.6, pp.1230-1233.
- Witkowski, F. X., Leon, L. J., Penkoske, P. A., Giles, W. R., Spano, M. L., Ditto, W. L. & Winfree, A. T. (1998), "Spatiotemporal Evolution of Ventricular Fibrillation", *Nature*, v.392, March, pp.78-82.
- Wolf, A., Swift, J. B., Swinney, H. L. & Vastano, J. A. (1985), "Determining Lyapunov Exponents from a Time Series", *Physica 16D*, pp.285-317.