

## Compact Meander Line Telemetry Antenna for Implantable Pacemaker Applications

N. H. Sulaiman<sup>1</sup>, N. A. Samsuri<sup>2</sup>, M. K. A. Rahim<sup>3</sup>, F. C. Seman<sup>4</sup>, M. Inam<sup>5</sup>

<sup>1,2,3,5</sup>Faculty of Electrical Engineering, Universiti Teknologi Malaysia (UTM),  
81301 Johor Bahru, Malaysia

<sup>4</sup>Faculty of Electrical and Electronic, Universiti Tun Hussein Onn Malaysia (UTHM),  
86400 Batu Pahat, Johor, Malaysia

---

### Article Info

#### Article history:

Received Jan 9, 2018

Revised Mar 2, 2018

Accepted Mar 18, 2018

---

#### Keywords:

Compact Meander Line  
Telemetry Antenna  
Electromagnetic Interferences  
Implanted Medical Devices

---

### ABSTRACT

The demand for health technology is increasing rapidly especially in telemetry applications. These applications generally use implanted antennas to be utilized for data transfer from patients to another reader device. This procedure can make the health care more efficient, since it provides fast diagnosis and treatment to the patient. This work presents a design of telemetry antenna to be used in Pacemaker application in Medical Implant Communication Services (MICS) (401 MHz-406 MHz). By introducing Compact Meander Line Telemetry Antenna (CMLTA), length ( $L_s$ ) and width ( $W_s$ ) of substrate have been reduced by 36.84% and 40% respectively. The proposed antenna offers advantages of easy fabrications, low cost and light weight with a 133 MHz bandwidth.

Copyright © 2018 Institute of Advanced Engineering and Science.  
All rights reserved.

---

### Corresponding Author:

N. H. Sulaiman,  
Faculty of Electrical Engineering,  
Universiti Teknologi Malaysia,  
81310 Skudai, Johor.

---

## 1. INTRODUCTION

An active medical implanted device offers a very effective and precise medical treatment for specific disease [1]. The most popular active implanted medical devices nowadays are cardiac pacemaker due to an increase in heart problems [2]. In order to provide very efficient treatment using pacemaker, telemetry antennas to be used in pacemaker have been developed. By using telemetry antenna, communication between pacemaker and other devices can be done to observe the level of patient conditions [3].

The capabilities of antenna performance for health care, radio communications and monitoring have become major concern for designing high performance antennas. The telemetry antenna offers number of advantages including flexibility and can directly communicate with other devices [4]-[5]. Various telemetry antenna designs have been proposed by several researchers. The requirements include compact size, wider bandwidth, radiation efficiency and the most importantly the patient safety [6]-[7]. Miniaturization is one of the important parameters to design a telemetry antenna especially for biomedical devices [2]. Moreover, low frequency is very crucial and need very specific technique to obtain small size for optimization of the antenna. A review of implantable antennas for health applications and biomedical telemetry has been provided in [4]. Hybrid patch/slot implantable antenna was designed for MICS. In [8], a hybrid patch antenna has been proposed by embedding the meander slot and six open slots in the ground which offers effective size reductions at a fixed operation. Previous researcher has proposed implantable antenna to be utilized in MICS band by using expensive dielectric substrate and superstrate such as Rogers R03210/RO3010 [9].

MICS band is the most commonly used frequency for implanted antenna, which is allocated by MICS for biotelemetry applications according to Recommendations of ITU-R SA.1346 and later superseded

by RS.1346 [9]. However, the band 401- 406 MHz is previously allocated to the Meteorologically Aids Service. Therefore, in order to reduce the harmful interference that might occur to the operations of Meteorologically Aids Service, a maximum limit of -16 dBm for the effective isotropically radiated power of MICS is specified [10]-[11].

Moreover, frequency ranges for wireless power transmission into human tissues have been investigated in order to observe the effect on the human body. In order to realize the CMLTA effect on human body, CMLTA is placed in the body model consisting of different tissues such as muscle, skin and fat (non-homogenous). The dielectric properties at 402.5 MHz for these tissues are shown in Table 1. In order to observe the effect of skin thickness, variations of thickness also have investigated. Based on previous work, for efficient modelling, one layer skin model (homogenous) can also be used for implantable antenna design [12].

Table 1. Dielectric properties of muscle, fat and skin at 402.5 MHz

Tissues	Relative permittivity ( $\epsilon_r$ )	Tangent loss ( $\sigma$ ) S/m
Muscle	58.79	0.84
Fat	5.57	0.04
Skin	46.72	0.69

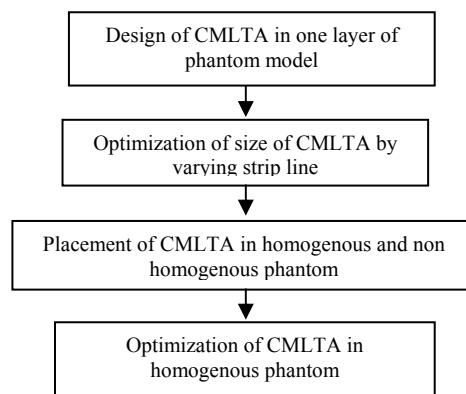

Figure 1. Design flow of the proposed CMLTA

In this paper, Compact Meander Line Telemetry Antenna (CMLTA) is proposed as shown in Figure 1. A CMLTA is designed based on modification and optimization of basic meander line antenna. By properly employing compact meander on the patch, the current path can be lengthened for the proposed antenna which lowering the antenna resonant frequency. Moreover, the proposed CMLTA can provide wide bandwidth and compact antenna size for pacemaker applications. Details of the antenna design are provided and discussed in the following section. In addition, comparison between CMLTA designs in homogenous and non-homogenous body models has been carried out to observe the effect on return loss performances. Moreover, the optimization of size of CMLTA has been done in homogenous phantom.

## 2. RESEARCH METHOD

The investigations have been carried out in order to obtain the optimum size of the telemetry antenna. The investigation begins by introducing Compact Meander Line Telemetry Antenna (CMLTA) to be resonated at 402.5 MHz. In this work, CMLTA has been designed using 3.2 mm thick FR-4 ( $\epsilon_r = 4.7$  and  $\tan \delta = 0.025$ ) as dielectric substrate and superstrate. For this design, commercially available CST computer model was used to model CMLTA.

In this work, the proposed antenna is examined with human body tissues in order to observe the effect of human body on the antenna proposed antenna performance. Therefore, the CMLTA has been designed with substrate and superstrate layers. The superstrate is capable of protecting neighboring tissues surrounding the proposed antenna. The superstrate layer acts as buffer between the metal radiator and human tissues by reducing Radio Frequency (RF) power at the locations of lossy human tissues. Moreover, by employing the superstrate layer, the antenna can be assuredly matched to  $50 \Omega$  through decreasing effects of

the high conductive biological tissues [15]. Transmission line and compact meander element have been used to achieve smaller dimension as compared to a conventional microstrip patch antenna [13]. The CMLTA design is shown in Figure 2.

Moreover, the variation of strip line,  $t_s$  has been carried out in order to get the optimum size of the CMLTA. The comparative results are provided in Results and Analysis sections. Based on the human body which consists of different layers of skin, fat and muscle tissues, as shown in Figure 3, the phantom box can also be created with single layer [2]. As shown in Figure 3, the gap between the compact loop antennas and outside is 4 mm which is considered in the design as estimated skin thickness.

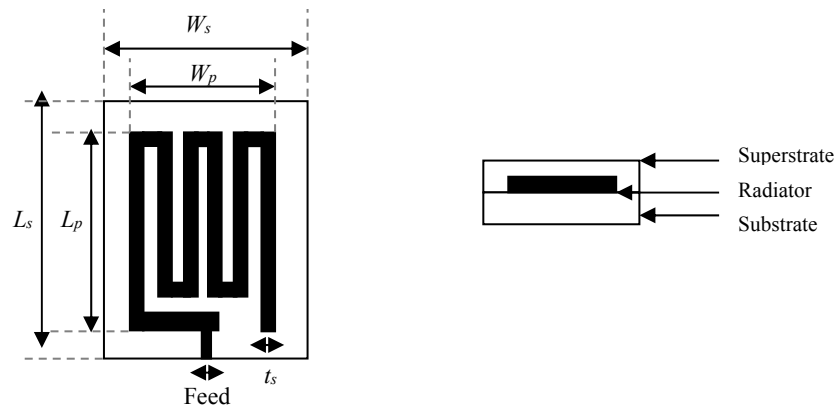

Figure 2. Detail design configuration of the CMLTA for telemetry applications  $L_s=21.02$  mm,  $W_s=3.05$  mm,  $L_p=15.01$  mm,  $W_p=26.5$  mm,  $t_s=3.63$ ,  $w_r=1$  mm)

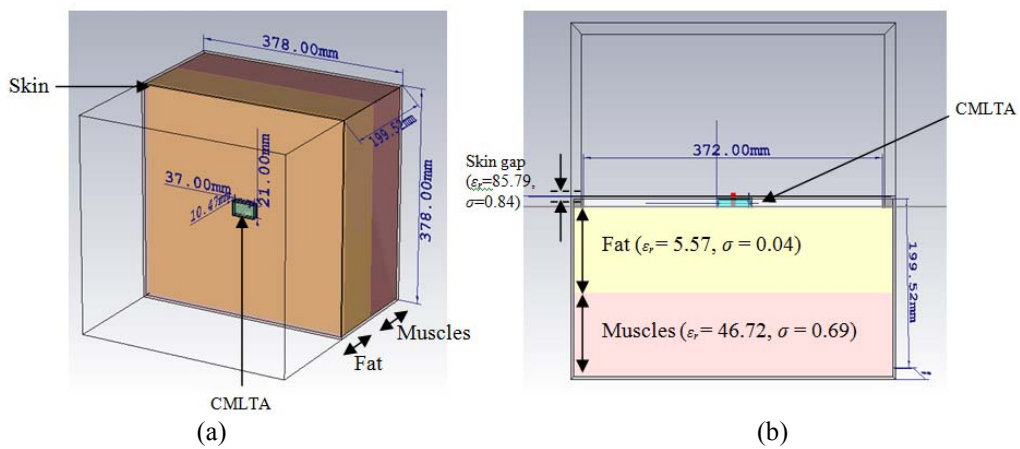

Figure 3. Multilayer human body phantom at 402.5 MHz. (a) Perspective view (b) Side view

### 3. RESULTS AND ANALYSIS

The variation of strip line,  $t_s$  has been carried out in order to obtain the desired resonant frequency with optimized CMLTA. The results are shown in Figure 4 and detailed summary is provided in Table 2.

Table 2. CMLTA performance due to strip line variations

Variation of Strip line (mm)	Dimension (mm)		Frequency Range (MHz)	% Bandwidth
	$W_p$	$L_p$		
2.5	40	43.8	322.8 - 449.7	31.5
3.0	40	43.0	320.7 - 453.7	33.0
3.6	40	42.0	326.2 - 453	33.5
4.0	41	42.5	326.2 - 453.7	31.5

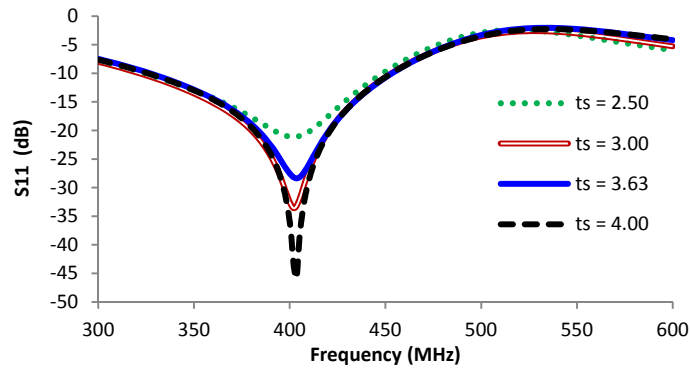

Figure 4. Variation of size strip size of Compact Meander Line Telemetry Antenna

As depicted in Figure 4, different size of strip line for CMLTA affects the return loss performances. From the results shown in Table 2, it can be observed that by using strip line of 3.6 mm higher bandwidth of 33.5% can be achieved as compared to strip line of 2.5, 3.0 and 4.0 mm. It is because for the proposed design configuration, the surface currents travel long distance inside the loop. Therefore the electrical dimension of the patch element elongates and provides an opportunity to design a patch at the same resonant frequency of 402.5 MHz with compact physical dimensions. In order to elaborate this phenomenon surface current distributions and electric field intensity have been generated using CST MWS simulations as shown in Figure 5. It is shown that the maximum surface current occurs in the center of the meander antenna when the electric field is excited in the Y-direction. By introducing compact meander line antenna, it is shown that the surface current density ( $J$ ) and electric field intensity ( $E$ ), the dimension of the antenna can be reduced. The increase in the surface current density ( $J$ ) on the conducting material causes an increase in the electric field intensity ( $E$ ) which is given by Maxwell Equation 1.

$$\nabla \times H = J + J\omega\epsilon E \quad (1)$$

Where ( $H$ ) is magnetic field intensity and ( $J$ ) is current density through the surface reflectarray element. The current density ( $J$ ) can be correlated to electric field intensity ( $E$ ) and conductivity, ( $\sigma$ ) of conductor material which is given in Equation 2.

$$J = \sigma E \quad (2)$$

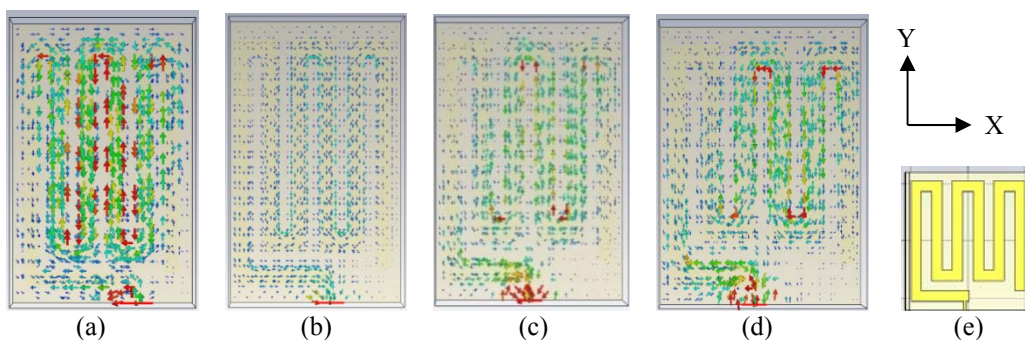

Figure 5. Surface current distribution on the proposed CMLTA. (a)  $t_s=2.5$ mm, (b)  $t_s=3.0$ mm, (c)  $t_s=3.63$ mm (d)  $t_s=4.0$ mm, (e) Antenna orientation

As mentioned earlier, the telemetry antenna has been examined by embedding it in fat, muscle and skin layer. In order to investigate the effect of the skin thickness, detailed analysis by variation of skin

thickness has been carried out. The skin thickness was varied from 1 mm to 5 mm and the effect of variation on the return loss and absorbed power were observed as shown in Figure 6 and Table 3 respectively.

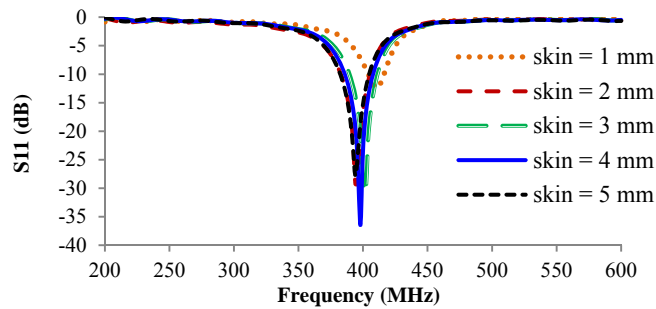

Figure 6. Return loss for different thickness skin

Table 3. Absorbed power by placing antennas under different skin thicknesses

Skin thickness (mm)	Power Absorbed (W)
1	0.916337
2	0.910852
3	0.999572
4	0.935055
5	0.836095

From Figure 6 it can be observed that the skin thickness has a significant effect on the antenna return loss and resonant frequency. The resonant frequency varies with a change in the skin thickness due to the coupling effect and the skin thickness of 1 mm offer high of return loss of -10.89 dB as compared to skin thickness of 5 mm which offers -25.12 dB of return loss. This is due to the coupling effect between antenna and thickness of skin layer. The absorbed power using different skin thickness has also been investigated in this work. The results are shown in Table 3. It can be observed that for skin thickness of 5 mm lesser power is absorbed as compared to skin thickness of 1 mm. From these results, it can be concluded that the thickness of skin can has a significant effect on the resonant frequency, return loss as well as the absorbed power. Therefore the placement of a telemetry antenna inside the human body is crucial and detailed analysis is needed to be carried out based on the requirements of the specific applications.

On the other hand, telemetry antenna has been located in a phantom with three different biological tissues (non homogenous model) as described earlier in Figure 3. The CMLTA in non-homogeneous human body model was compared with CMLTA placed in homogeneous body model in order to observe the effect of body tissues on the antenna performance. For homogenous body model, the properties used for phantom are ( $\epsilon_r = 5.67$ ,  $\sigma = 0.94$  S/M and  $\tan \delta = 0.74$ ). Figure 7 show the comparison of return loss between the two body models before and after optimization respectively. The tabulated data is provided in Table 4.

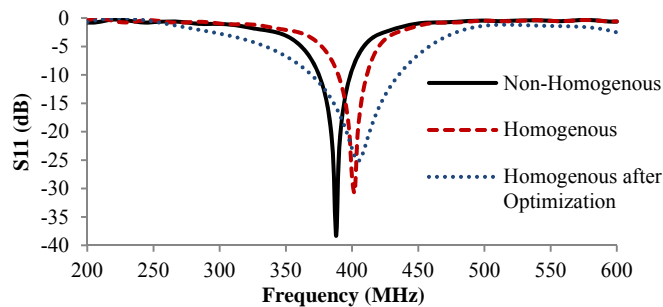

Figure 7. Comparison of return loss after optimization between homogenous and non-homogenous

It can be observed from Table 4 that both non-homogeneous and homogenous models provide a good agreement for the return loss performances while the bandwidth is slightly improved in the case of homogeneous model. This is due to the tissue properties used for the design. However the non-homogeneous phantom model is expected to provide comparatively closer results to the measurements because detailed tissue properties were used in this case.

Table 4. The performance of CMLTA after optimization

Model	$W_s$ (mm)	$I_s$ (mm)	Frequency Range (MHz)	Percentage of Bandwidth (%)
Homogenous	34	26.125	389.77- 414.39	6.17
Non-Homogenous	34	27	389.56- 411.19	5.37

#### 4. CONCLUSION

By introducing the proposed CMLTA design, the dimension of the antenna can be minimized by 36.84% and 40% for length ( $L_p$ ) and widths ( $W_p$ ) of substrate respectively. Variation of skin thickness can also affect the performance of the antenna while homogenous and non-homogenous human body models provide almost identical results. Therefore simplified homogeneous body model can be applied for reducing the complexity in the design. Moreover, the proposed CMLTA can be used for telemetry application especially in biomedical applications. The CMLTA can be further investigated for realization of pacemaker inside the human body model for Electromagnetic Interference (EMI) and Specific Absorption Rate (SAR).

#### ACKNOWLEDGEMENTS

The authors would like to thank the Ministry of Higher Education (MOHE) for supporting the research work under Mybrain15, UTM grant number 12H08 and 4F883. The author would like to thank the staff of Faculty of Electrical and Electronic engineering of University Teknologi Malaysia (UTM) and Universiti Tun Hussein Onn Malaysia (UTHM) for the technical support.

#### REFERENCES

- [1] N. A. Elias, N. A. Samsuri, M. K. A. Rahim, C. J. Panagamuwa, and W. Whittow, "SAR Levels for Irradiation by a Crumpled 900 MHz Flexible Diamond Dipole," *Int. J. Electr. Comput.*, vol. 7, no. 3, pp. 1546–1553, 2017.
- [2] C. J. Sánchez-Fernández, O. Quevedo-Teruel, J. Requena-Carrión, L. Inclán-Sánchez, and E. Rajo-Iglesias, "Dual-band microstrip patch antenna based on short-circuited ring and spiral resonators for implantable medical devices," *IET Microwaves, Antennas Propag.*, vol. 4, no. 8, p. 1048, 2010.
- [3] F. C. S. and M. I. N. H. Sulaiman, N. A. Samsuri, M. K. A. Rahim, "Design and Analysis of Optimum Performance Pacemaker Telemetry Antenna," *TELKOMNIKA (Telecommunication Computing Electronics and Control)*, 2017; 15(2): 877-882.
- [4] C. Liu, S. Member, Y. Guo, S. Member, and H. Sun, "Design and Safety Considerations of an Implantable Rectenna for Far-Field Wireless Power Transfer," vol. 62, no. 11, pp. 5798–5806, 2014.
- [5] S. Gollakota, H. Hassanieh, B. Ransford, D. Katabi, and K. Fu, "They can hear your heartbeats: non-invasive security for implantable medical devices," *Proc. ACM SIGCOMM 2011 Conf. SIGCOMM*, pp. 2–13, 2011.
- [6] W. El Hajj, C. Person, and J. Wiart, "A novel investigation of a broadband integrated inverted-F antenna design; Application for wearable antenna," *IEEE Trans. Antennas Propag.*, vol. 62, no. 7, pp. 3843–3846, 2014.
- [7] Z. Duan, Y. X. Guo, M. Je, and D. L. Kwong, "Design and in vitro test of a differentially fed dual-band implantable antenna operating at MICS and ISM Bands," *IEEE Trans. Antennas Propag.*, vol. 62, no. 5, pp. 2430–2439, 2014.
- [8] C. Liu, S. Member, Y. Guo, S. Member, and S. Xiao, "A Hybrid Patch / Slot Implantable Antenna for Biotelemetry Devices," vol. 11, pp. 1646–1649, 2013.
- [9] L. J. Xu, Y. X. Guo, and W. Wu, "Miniaturized dual-band antenna for implantable wireless communications," *IEEE Antennas Wirel. Propag. Lett.*, vol. 13, pp. 1160–1163, 2014.
- [10] B. Mandal and S. K. Parui, "Wearable tri-band SIW based antenna on leather substrate," *Electron. Lett.*, vol. 51, no. 20, pp. 1563–1564, 2015.
- [11] S. R. Devices, *ERC Recommendation 70-03*, no. May. 2016.
- [12] A. Pellegrini *et al.*, "Antennas and propagation for body-centric wireless communications at millimeter-wave frequencies: A review," *IEEE Antennas Propag. Mag.*, vol. 55, no. 4, pp. 262–287, 2013.
- [13] N. Ripin, A. A. Sulaiman, N. E. A. Rashid, M. F. Hussin, and N. N. Ismail, "A Miniaturized 878 MHz Slotted Meander Line Monopole Antenna," *Indones. J. Electr. Eng. Comput. Sci.*, vol. 7, no. 1, pp. 170–177, 2017.

**BIOGRAPHIES OF AUTHORS**

**Noor Hafizah Sulaiman** obtained her Bachelor's and Master's degree in Electrical Engineering from Universiti Tun Hussein Onn Malaysia (UTHM) in 2010 and 2014 respectively. From 2011 to 2014, she was with Wireless and Radio Science Centre (WARAS), UTHM working as a graduate research assistant. Currently she is working towards her Ph.D degree from Faculty of Electrical Engineering (FKE), Universiti Teknologi Malaysia (UTM). Her research interests are in design of planar and printed antennas and antenna arrays. She has published more than 10 research papers in various indexed journals and conference proceedings.



**Noor Asmawati Samsuri** received the B.Eng. (Hons) in Electrical-Telecommunication Engineering from Universiti Teknologi Malaysia in 2001, the MSc. in Digital Communications System from Loughborough University, UK in 2004 and the Ph.D. in Electronic and Electrical Engineering from Loughborough University, UK in 2009. She is presently a Senior Lecturer in the Faculty of Electrical Engineering, Universiti Teknologi Malaysia. Her research interests include wearable antennas including the interaction with human body and metallic items, implantable antenna for medical telemetry, and Specific Absorption Rate (SAR). During her carrier, she has been authored or co-authored several technical papers and book chapters related to her research interests. She has also been appointed as a reviewer for several journal papers at National and International level. Noor Asmawati Samsuri is a member of Board of Engineer Malaysia (BEM) and a member of IEEE (MIEEE), and is currently supervising a PhD, Master and Undergraduate students.



**Mohamad Kamal A Rahim** received the B Eng. degree in Electrical and Electronic Engineering from University of Strathclyde, UK, in 1987. From 1987 to 1989, he worked as a Management Trainee at Sime Tyres Mergong Alor Star Kedah and Production Supervisor at Sime Shoes in Kulim Kedah. In 1989, he joined the Department of Communication Engineering, Faculty of Electrical Engineering Universiti Teknologi Malaysia Kuala Lumpur as an Assistant Lecturer A. He obtained his M.Eng Science from University of New South Wales Australia in 1992 and PhD degrees in Electrical Engineering from University of Birmingham UK in 2003. After he received his Master he was appointed as a Lecturer at Faculty of Electrical Engineering. In 2005 he was appointed as a senior lecturer and in 2007 he was appointed as Assoc Professor at the faculty. Now he is the Professor in RF and Antenna at Faculty of Electrical Engineering Universiti Teknologi Malaysia. His research interest includes the areas of design of Dielectric resonator antennas, microstrip antennas, small antennas, microwave sensors, RFID antennas for readers and tags, Multi-function antennas, microwave circuits, EBG, artificial magnetic conductors, metamaterials, phased array antennas, computer aided design for antennas and design of millimeter frequency antennas. He has published over 200 articles in journals and conference papers.



**Fauziahanim Che Seman** is an associate professor of Research Center of Applied Electromagnetic. After obtaining her first degree from Universiti Teknologi Malaysia in Electrical Communication Engineering in year 2001, she continued her master degree at Kolej Universiti Tun Hussein Onn Malaysia and graduated in year 2003 and later she joined Faculty of Electrical Engineering, Universiti Tun Hussein Onn Malaysia as a lecturer. She obtained her PhD degree at Queens University of Belfast, United Kingdom in 2011. Her research interests include Radar Microwave Absorber, Frequency Selective Surface, Antenna Design and copper access networks. She has published number of index journals and conference proceeding and taken various patents. She is actively involved with volunteering IEEE activities and organizing committee for various international and local conferences, recently as the Technical Chair for IEEE APMC 2017. Currently, she served as the Secretary of the IEEE Malaysia AP/MTT/EMC Joint Chapter.



**Muhammad Inam Abbasi** completed his BSC in Electrical Engineering with major in Telecommunication in 2008 from Centre for Advanced Studies in Engineering (CASE Islamabad), University of Engineering and Technology (UET, Taxilla), Pakistan. He joined Wireless and Radio Science Centre (WARAS), Universiti Tun Hussein Onn Malaysia (UTHM) as a Graduate Research Assistant in 2009 where he completed his Master by Research and Ph.D. in Electrical Engineering in 2011 and 2016 respectively. Currently, He is working as a Post-Doctoral research fellow at Wireless Communication Centre (WCC), Universiti Teknologi Malaysia (UTM). His recent research interests lie in high performance planar and printed antenna design, passive and reconfigurable reflectarray and planar reflector antennas, novel materials for the design of enhanced performance antennas. Dr. Inam has published one book and more than 40 research papers in internationally indexed journals and conferences.