

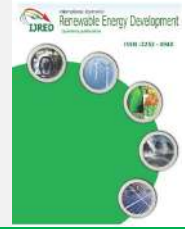

Contents list available at IJRED website

Int. Journal of Renewable Energy Development (IJRED)

Journal homepage: <https://ijred.undip.ac.id>



Research Article

Comparative Analysis of Hybrid Renewable Energy Systems for Off-Grid Applications in Chad

Abdelhamid Issa Hassane^{a,d*}, Djamal Hissein Didane^b, Abakar Mahamat Tahir^c,
Ruben Martin Mouangue^d, Jean Gaston Tamba^e, Jean-Marie Hauglustaine^f

^aDepartment of Petroleum Management and Economics, Higher National Institute of Petroleum of Mao,
Box: 4377, N'Djamena, Chad; abdelhamidissa@gmail.com

^bCenter for Energy and Industrial Environment Studies, Universiti Tun Hussein Onn Malaysia 86400 Parit Raja,
Batu Pahat, Johor, Malaysia; djamal@uthm.edu.my

^cFaculty of Exact and Applied Science, University of N'Djamena, Box: 1027, N'Djamena, Chad;
abakarmt@gmail.com

^dLaboratory of Energy, Materials, Modelling and Methods, National Higher Polytechnic School of Douala, University of
Douala, PO Box: 2701, Douala, Cameroon; r_mouangue@yahoo.fr

^eDepartment of Thermal and Energy Engineering, University Institute of Technology, University of Douala, PO Box:
8698, Douala, Cameroon; tambajea@gmail.com

^fEnergy Research Unit SuD (Energy and Sustainable Development), Department of Sciences and Management of
Environment, Faculty of Sciences, University of Liège, Avenue of Longwy 185, 6700 Arlon, Belgium;
jmhauglustaine@uliege.be

Abstract. In this study, a techno-economic feasibility analysis of hybrid renewable energy systems for four household categories in rural areas of Chad was studied based on the multi-criteria assessment technique. The problem of this study is to know the best optimal solution in the technical and economic feasibility study of the decentralized mini-grids for the rural electrification of isolated villages in Chad. The main objective of the work is to assess technically, economically and environmentally the feasibility of six scenarios of hybrid systems in five isolated sites in Chad. The performance analysis involved six scenarios of possible hybrid solutions while achieving a supply-demand balance for sustainable electrification of the remote villages, using the HOMER software. The results have shown that the optimum combination of the hybrid system was the photovoltaic/battery system with a Net Present Cost (NPC) of US \$ 328,146 and it was found at Etena village. The photovoltaic/Wind/Diesel/Battery hybrid configuration was the least optimum system and it has appeared in Mandelia village. In terms of energy cost, the lowest Levelized Cost of Energy (LCOE) was estimated at US \$ 0.236/kWh in a photovoltaic/Wind/Battery configuration at Koundoul site and the highest costs US \$ 0.363/kWh in the photovoltaic/Battery configuration at the Linia site. It is established that hybrid solutions can be developed to make electricity available and accessible to the population of the remote rural areas in Chad. However, it is imperative that the local government must subsidize the diesel price to promote the adaptation of the abundant renewable solutions.

Keywords: energy access; Chad; HOMER; hybrid renewable energy system; techno-economic assessment.

Article History: Received: 9th June 2021; Revised: 29th August 2021; Accepted: 1st Sept 2021; Available online: 15th Sept 2021

How to Cite This Article: Hassane, A.I., Didane, D.H., Tahir, A.M., Mouangue, R.M., Tamba, J.G., Hauglustaine, J.-M. (2022). Comparative Analysis of Hybrid Renewable Energy Systems for Off-Grid Applications in Chad. *Int. J. Renew. Energy Dev.* 11(1), 49-62. <https://doi.org/10.14710/ijred.2022.39012>

1. Introduction

Nowadays, access to electricity at an affordable price has become one of the most important human needs in our daily lives and has been perhaps for many decades, if not centuries. The quest for clean and sustainable energy is increasing globally at a rapid rate with the current advances in technology, increasing the world population and resurging needs to reduce CO₂ emissions (Aleem & Hussain, 2020). Renewable energy resources are

distributions across the globe and could play a vital role in ensuring sustainable energy development in the world. However, access to electrical energy is a major challenge to a large number of populations across the world. Recent data from the international renewable energy agency (IEA) shows that almost one billion people still lack access to electricity (Aleem & Hussain, 2020). Access to electricity at an affordable price for the populations is a key factor that contributes towards local development and

* Corresponding author: abdelhamidissa@gmail.com

thus reduces poverty rates in rural areas (Odou *et al.*, 2020). Adopting renewable energy systems to achieve such goals does not only ensure the sustainable economic development of a nation but also reduces the CO₂ emissions, which contribute directly to global warming effects. To meet these challenges, electrical energy production, consumption policies and mechanisms must be enforced in the process of renewable energy development.

In Chad, the heavy dependence on fossil fuels, notably oil, the need to reform the energy sector, the growth in demand and the low rate of rural electrification (only 0.6%) require long-term planning of electrical production systems (Nerini *et al.*, 2016). This article promotes rural electrification by utilizing renewable energy sources in Chad. It seeks to develop a method for evaluating decentralized electrical systems and present an electrification model for Chadian rural villages. This study aims to propose a model for rural electrification, which takes into consideration the context of Chad as a developing country and fits within the public and private energy regulation sectors. Although numerous studies have addressed the issue of rural electrification, however, the difference in this present work is that it uses the multi-criteria approach while considering the energy needs of the villages to be electrified (Yimen *et al.*, 2018; Reserve & Costa, 2020; Micangeli & Giglioli, 2019).

Most of the articles published on the technical-economic feasibility study of hybrid mini-grids and renewable energy have resorted to the evaluation of two criteria, the NPC or the LCOE, or both at the same time (Seutche *et al.*, 2021; Barry *et al.*, 2021; Guno *et al.*, 2021; Asuamah *et al.*, 2021). Given the importance of reducing CO₂ emissions in the energy balance during the production and consumption of energy, it seemed relevant to us to assess the amount of CO₂ to be avoided by using fossil fuels by renewable energy.

The research on the topic of hybrid systems and renewable energy is very limited in Chad. There is little scientific literature on this subject. Our work will already be a contribution. Therefore, we are interested in articles published in other countries (Algeria, South Africa, Ghana, Nigeria, etc.). Although the evaluation method of these studies is based on a simulation of the results with the HOMER software, we noted the research gap is the use of one or two criteria, namely: the NPC and the LCOE. The novelty of our study is to combine three criteria: the NPC, the LCOE and the CO₂ emissions (Adaramola *et al.*, 2017; Bentouba *et al.*, 2016; Bonah & Nutakor, 2020; (Salisu *et al.*, 2019).

Furthermore, analyzing the economic viability and socio-economic acceptability of any rural electrification project necessarily involves knowing the energy needs of households and their ability to pay for electricity. Thus, to achieve the specific objectives of the present study, the work will start by defining the energy needs of households in each village in the rural of Chad. Then, the estimation of the electricity demand needed to supply the villages is conducted. In the end, the best technical-economic solution for electrification architecture for each village is chosen.

Our problem is to ascertain which decision support methodology should be adopted to ensure the availability

and technical and economic feasibility of a decentralized rural electrification project in the context of Chad.

The choice of this theme is justified by the lack of access to energy services in rural areas despite the existence of significant potentials in solar energy in the country, while Chad aspires to an economic emergence by 2030 (Aleem & Hussain, 2020). By 2030, the Chadian government has set objectives to achieve an electricity access rate of 30% nationwide, a rural electricity access rate of 25%, and a share of renewable energies of 20% in national electricity production.

The overall goal of this work is to develop a methodological approach with a multi-criteria design for a decentralized rural electrification project by utilizing a mini-grid in its pre-feasibility phase which is risky in terms of technical and financial risks and costly, but essential for a successful and sustainable installation during the development of the project specifications.

2. Materials and Methods

Our approach consists of data collection from electrical energy users (households, businesses, municipalities, schools, etc.) across the different villages surveyed. This data is assessed in terms of electrical energy needs for different user groups. It is then computed to evaluate the demand load curve for each village (Fuso Nerini *et al.*, 2015). Subsequently, electricity demand projection until the year 2040 was estimated to determine the demand for the annual growth rate.

Moreover, a field survey was carried out across certain villages to be electrified (Gupta *et al.*, 2010). Then, the population's current energy needs and desired electrical devices when electricity is delivered were assessed. These surveys were carried out in non-electrified households as well in order to access the consumption rate and the penetration rate of additional devices desired by non-electrified households. To study the potential for the energy demand of each village, we assessed the electrical needs of different households based on consumption categories of five different villages.

To study the feasibility and economic performance of the hybrid systems, the HOMER (hybrid optimization of multiple energy resources) software is used. HOMER basically performs three operations, namely: simulation, optimization and sensitivity analysis. This software is chosen as makes it possible to assess the technical and economic feasibility of hybrid systems off-grid by calculating the production cost per kilowatt-hour. Moreover, in order to compare the different solutions obtained, the economic factors such as the net present cost (NPC), the levelized cost of energy (LCOE) as well as the rate of CO₂ emissions must be calculated to lead to a more robust solution. The three evaluation criteria used in this study are the net present cost (NPC), the discounted cost of energy (LCOE) and the rate of CO₂ emissions. The HOMER software is suitable for performing these simulations by ranking the solutions in ascending order (Haghighat Mamaghani *et al.*, 2016).

2.1. Study areas

Chad is a landlocked, semi-desert country with a 1,284,000 km² area, which makes it the fifth largest

country in Africa and twenty-first in the world. Located in Central Africa, bordered from the North by Libya, the Central African Republic from the South, Sudan from the East, Niger from the West and Cameroon and Nigeria from the South-West. The vast majority of the area is flat with some plateaus around the country. The county is largely divided into three main geographical zones, namely; the Sahara Desert in the north, the semi-arid zone in the center and the Sudanese tropical zone in the south. Chad is full of solar potential with the annual hours of sunshine varying from 2850 hours in the South to 3750 hours in the North and the intensity of the global radiation varies on average between 4.5 to 6.5 kWh/m²/day, as shown in Figure 1. The wind power is mainly found in the north of the country with speeds exceeding 5 m/s, as show in Figure 2 (Hassane *et al.*, 2018; Didane *et al.*, 2017; Mahamat Tahir *et al.*, 2020; Mouangue *et al.*, 2019).

The survey on the electricity needs of the villages carried out enabled us to select three categories of villages and two types of rural communities whose size was as follows:

- Medium village: 1,000 ≤ population < 3,000 inhabitants;

- Large village: 3,000 ≤ population < 5,000 inhabitants;
- Small town: 10,000 ≤ population < 15,000 inhabitants;
- Large municipality: 15,000 ≤ population < 20,000 inhabitants.

To estimate the electrical demand of non-electrified households, we studied the electrical services desired by the users of two medium villages, two large villages and one rural commune. Then, another survey of already electrified households in the Gozator district (10th arrondissement of the city of N'Djaména) was carried out. The characteristics of each surveyed village are presented in Table 1.

Considering the methodology of the study carried out which consisted of understanding the socio-economic context of each village by questioning the village chiefs and collecting data concerning the energy needs of households and according to their daily electrical needs, we could identify three types of households in these areas (Table 1).

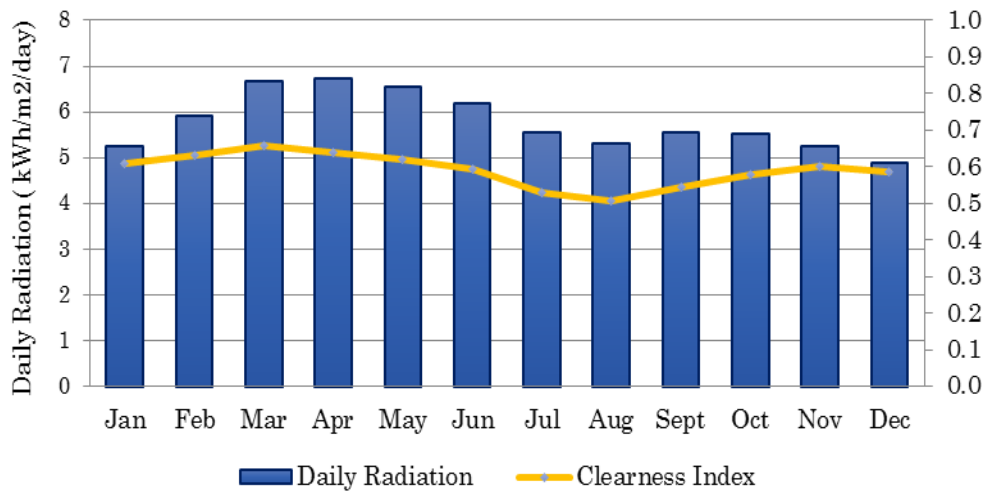

Fig.1 Solar irradiation and clearness index for the selected sites

Table 1
Characteristics and estimation of the current demand of the villages surveyed

Characteristics of the village	Medium village (1,000 to 3,000 inhabitants)		Large village (3,000 to 5,000 inhabitants)		Small rural town (10,000 to 15,000 inhabitants)
	Etena	Kournari	Linia	Koundoul	Mandelia
Geographical location relative to N'Djaména	30 km south of N'Djamena	35 km south of N'Djaména	20 km northwest of N'Djamena	25 km south of N'Djaména	50 km south of N'Djaména
Population	1,283	2,084	4,304	4,391	13,558
Average number of people/households	5	5	6	6	7
Total number of households per village	257	417	717	732	1,937
Number of households surveyed	20	30	50	30	50
Estimated energy for the households surveyed (kWh/day)	16	23	43	29	51
Estimated daily energy for all households (kWh / day)	212	317	618	705	1,968
Total annual energy required by village (MWh / year)	77,380	115,705	225,570	257,325	718,320

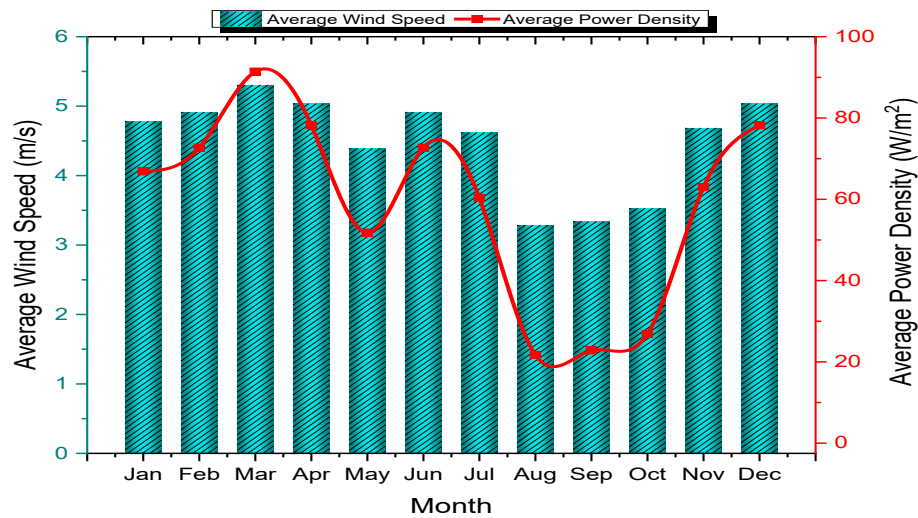

Fig.2 Annual mean wind velocity and mean wind power density at the site

Table 2
 Proposed systems for the electrification of the villages visited

N°	System proposed	Scenario
1.	Photovoltaic /battery	A
2.	Photovoltaic /diesel/battery	B
3.	Photovoltaic /wind / battery	C
4.	Wind/battery	D
5.	Wind/diesel/battery	E
6.	Photovoltaic /wind/diesel/battery	F

Table 3
 Definition of types of households by category of consumption

Equipment	Power rating (W)	Household Type 1		Household Type 2		Household Type 3		Household Type 4	
		Quantity	Duration of use (h/day)	Quantity	Duration of use (h/day)	Quantity	Duration of use (h/day)	Quantity	Duration of use (h/day)
Lamps	40	3	6 h	5	6 h	5	6 h	5	6 h
Phone charger	20	1	2 h	1	2 h	1	2 h	1	2 h
Television	200	0	0	1	4 h	1	4 h	2	4 h
Ventilator	40	0	0	0	0	2	8 h	2	4 h
Fridge	200	0	0	0	0	1	8h	1	8 h
Air conditioner	1,200							1	4 h
Energy daily (kWh/day)			1		2		3		8

2.2. Estimated electrical requirements

The solutions predicted are hybrid power plants for all sites with sufficient capacity to meet demand during the whole day, instead of the morning. The sizing of the electricity production components must be flexible in order to consider the renewable energy potentials of the sites studied.

Furthermore, the evolution of long-term demands also needs to be considered to ensure the balance between supply and demand (Bonah & Nutakor, 2020). Thus, six electrification solutions have been proposed to achieve a

supply-demand balance by the villages. These solutions are summarized in Table 2. The Table 3 summarizes the estimated daily energy needs for different types of households.

2.3. Renewable energy potential

Given that the areas studied do not have synoptic stations and thus the data do not exist on the NASA Surface Meteorology and Solar Energy databases used by HOMER, the data were collected from the nearest station; N'Djaména, which is located on latitude 12°8.1' N and 15°

3.3' E longitude. The average annual horizontal solar radiation is 6 kWh/m²/day (Figure 1). The solar radiation is calculated over a period of 22 years (July 1983-June 2005). The wind speed is measured at the airport level at a height of 80 m over a period of 10 years (July 1983-June 1993). The corresponding power density of the site is about 90 kW/m² with maximum frequency occurring in the range between 3 – 6 m/s average wind velocity, as shown in Figures 2 and 3.

2.4. Components of hybrid systems surveyed

The hybrid system considered consists of a solar panel, a wind turbine, a generator, an inverter and batteries. Figure 4 shows schematically the hybrid systems studied at the five sites. Table 4 presents the cost assumptions for different components of the hybrid systems studied.

2.5. Basic calculation formulas

• Solar energy

The solar energy produced is calculated by the following formula (Bonah & Nutakor, 2020):

$$P_{out} = Y_{pv} f_{pv} \left(\frac{\bar{G}_T}{G_{T,STC}} \right) \tag{1}$$

where Y_{pv} (kW) is the PV array's rated capacity or output power under standard test conditions, f_{pv} denotes the derating factor of the PV (%), \bar{G}_T is the incident solar radiation on the PV array (kW/m²), $G_{T,STC}$ represents the incident solar radiation under standard situations (1 kW/m²).

• Wind energy

Wind energy is usually extracted through a device called a wind turbine. The wind turbine harnesses power through the rotation of the rotor. The wind energy production of the system or the power output (P_W) can be calculated by the following relation in Equation 2 (Dufolópez & Bernal-Agustín, 2008).

$$P_W = \frac{1}{2} \times \rho \times C_e \times A \times V^3 \times 10^{-3} \tag{2}$$

where, ρ is the air density (1.225 kg / m³), V is the wind speed (m/s), A is the area and C_e is the maximum power extraction efficiency of the wind generator and other electrical components connected to the generator. The efficiency of a wind turbine is typically estimated through the ratio between the extractable electrical power output, P_W of the wind turbine system to the available kinetic wind power.

• Diesel Generator

The diesel generator can be used to electrify households when energy from renewable energy sources is not available. The fuel consumption of this diesel generator can be calculated using Equation 3 (Ouedraogo *et al.*, 2015).

$$F_G = B_G \times P_{G-rated} + A_G \times P_{G-out} \tag{3}$$

where $P_{G-rated}$ is the nominal power of the diesel generator, P_{G-out} is the output power, while A_G and B_G represent the coefficients of the fuel consumption curve as defined by the user (Liter / kWh).

• Battery

Batteries are mainly used to store energy from solar PVs or the wind turbine depending on the combination of the system. They are useful to compensate during the unavailability of energy from the other resources in order to have a continuous power flow in households. The batterie's storage capacity is calculated through Equation 4 (Ouedraogo *et al.*, 2015).

$$C_{Wh} = (E_L \times AD) / \eta_{inv} \times \eta_{batt} \times DoD \tag{4}$$

where E_L is the average daily load energy (kWh/day), AD is the daily autonomy of the battery; DoD is battery depth of discharge, while η_{inv} and η_{Batt} represent the inverter and battery efficiency respectively.

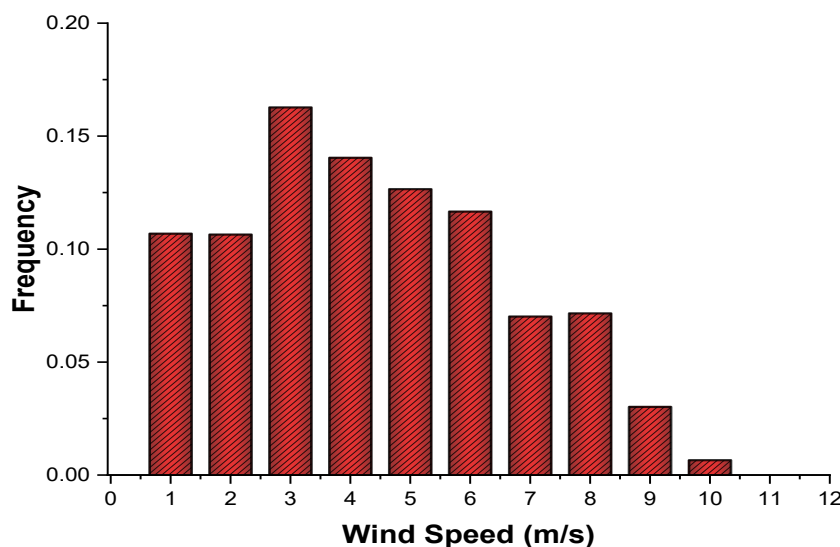

Fig. 3 Frequency of wind speed per year

Table 4
 Cost assumptions for different components of the proposed solutions.

Components		Investment costs	Replacement costs	Operating costs (annual)
Solar Photovoltaic	Canadian Solar 250 W CS6P-250P	\$ 270	\$ 243	\$ 2.7
Inverter	Power-One PVI-4.6-1-OUTD-x-US-y (208V)	\$ 984	\$ 886	\$ 9.8
Battery	BAE PVS Block 12V 210 AEOLOS V1	\$ 321	\$ 289	\$ 32
Wind turbine	1 kW	\$ 5,320	\$ 5,320	\$ 532
	10 kW	\$ 21,567	\$ 21,567	\$ 216
Diesel Generator	Generic 10 kW Fixed Capacity Genset	\$ 5,000	\$ 5,000	\$ 0.03/hr.

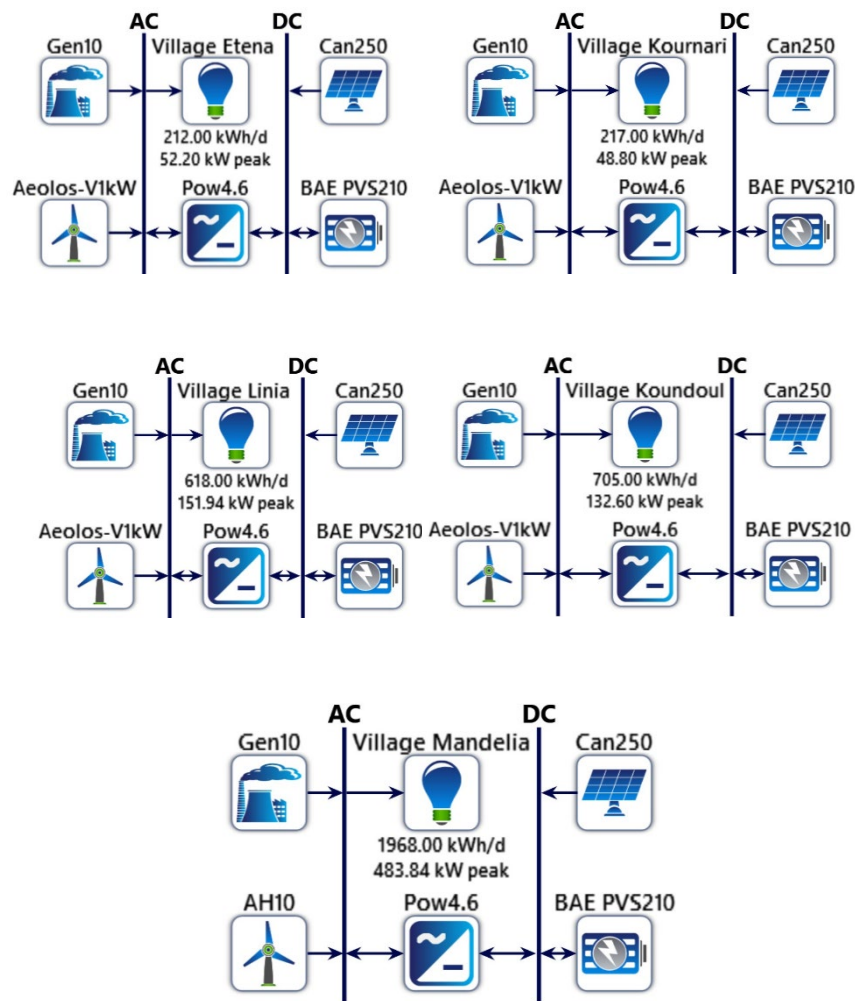

Fig.4 Schematic diagram for the hybrid system of selected villages

2.6. HOMER simulation

These studies are the initial steps in the process of rural electrification projects in Chad. In this section, the sites were studied with HOMER software in order to choose the best decentralized rural electrification solutions (Biswajit *et al.*, 2015).

2.7. Economic evaluation criteria

The comparison of the optimization results under HOMER is conducted based on several economic criteria. In our

study, three economic criteria were selected: the net present cost (NPC), levelized cost of energy (LCOE) and the penetration rate of renewable energies. These parameters are calculated according to the following formulas.

- *Net Present Cost*

NPC is defined as the present cost of the total cost of the system (both installation and operation) during the project's lifetime, minus the present value of the total revenue accrued during the project's lifetime. The NPC is

a function of initial capital cost, replacement cost, annual operating and maintenance cost as well as fuel costs. NPC is expressed as (Gilman & Lilienthal, 2006):

$$C_{NPC} = \frac{TAC}{CRF(i, N)} \tag{5}$$

where, TAC is the total annualized cost (\$/year), CRF the capital recovery factor is a function of annual real interest rate (8 %), and the project lifetime (25) years. CRF is given in Equation as (Bonah & Nutakor, 2020):

$$CRF_{(i,N)} = \frac{i(1+i)^N}{(1+i)^N - 1} \tag{6}$$

- *Levelized cost of energy (LCOE)*

The LCOE is the ratio of the sum of the entire cost accumulated during the project’s lifetime to the unit of electricity generated over the entire lifetime of the project. In this research, discount and inflation rates of 5% and 3%, are selected, respectively. The LCOE is calculated as (Hernández-Moro & Martínez-Duart, 2012):

$$LCOE = \frac{\sum_{i=0}^T \left[\frac{C_i + L_i + O\&M_i + I_i}{(1+d)^i} \right]}{\sum_{i=0}^T \left[\frac{E_i}{(1+d)^i} \right]} \tag{7}$$

where C_i is the expenditure from the cost of the system, L_i represents the cost of land, $O\&M_i$ is the cost of operation and maintenance, I_i is the insurance cost which is paid annually during the project lifetime T and d is the discount rate.

- *Renewable energy penetration rate*

Renewable fraction (RF) is the total amount of power generated by the renewable energy sources compared to

the total power generated from the entire hybrid system (Gilman & Lilienthal, 2006). The renewable fraction is obtained from:

$$RF(\%) = \left(1 - \frac{\sum P_{diesel}}{\sum P_{generated}} \right) \times 100 \tag{8}$$

3. Results

3.1. Categories of household electrical consumption

There are two consumption categories (categories 1 and 2) within these five villages, with percentages varying up to 100% of the total number of households in each village surveyed. As part of this study, 300 households were surveyed, distributed in the Table 5.

Based on the household electricity consumption estimations above, we were able to classify energy consumption into four categories as follow:

- Category 1: it is made up of poorer households corresponding veto basic lighting needs (3 lamps) and a mobile phone charger;
- Category 2: these are average households with 5 lamps, a mobile phone charger and a television set;
- Category 3: above average households, with 5 lamps, a fridge and a television set;
- Category 4: wealthy households with 5 lamps, 1 fan, 2 televisions sets, a fridge and an air conditioner (Table 6)

The distribution of these households according to the four consumption categories previously defined enabled us to note that the households located in rural areas are generally of categories 1 and 2. They represent up to 100% in the village of Kournari. On the other hand, in the Gozator district, which is located in an urban area, the households are of categories 3 and 4 (Table 7).

Table 5
Distribution of households surveyed for the 5 villages and one district of N'Djamena.

	Etena	Kournari	Linia	Koundoul	Mandelia	Gozator	Total
Number of households surveyed	20	30	50	30	50	120	300
Number of electrified households	5	0	11	12	20	120	168
Percentage of households electrified	25 %	0 %	22 %	40 %	40 %	100 %	56 %
Number of non-electrified households	15	30	39	18	30	0	132
Percentage of non-electrified households	75 %	100 %	78 %	60 %	60 %	0 %	44 %

Table 6
Distribution of categories of household electrical services

Type of services Number of devices	Category			
	Category 1	Category 2	Category 3	Category 4
Lamps	3	5	5	5
Phone charger	1	1	1	1
Television	0	1	1	2
Fridge	0	0	1	1
Ventilator	0	0	1	2
Air conditioner	0	0	0	1

Table 7
Typology of villages according to the distribution of categories

	Mandelia	Koundoul	Linia	Etena	Kournari	Gozator
Category 1	80 %	90 %	92 %	95 %	100 %	0 %
Category 2	20 %	7 %	8 %	5 %	0 %	0 %
Category 3	0 %	3 %	0 %	0 %	0 %	73 %
Category 4	0 %	0 %	0 %	0 %	0 %	27 %

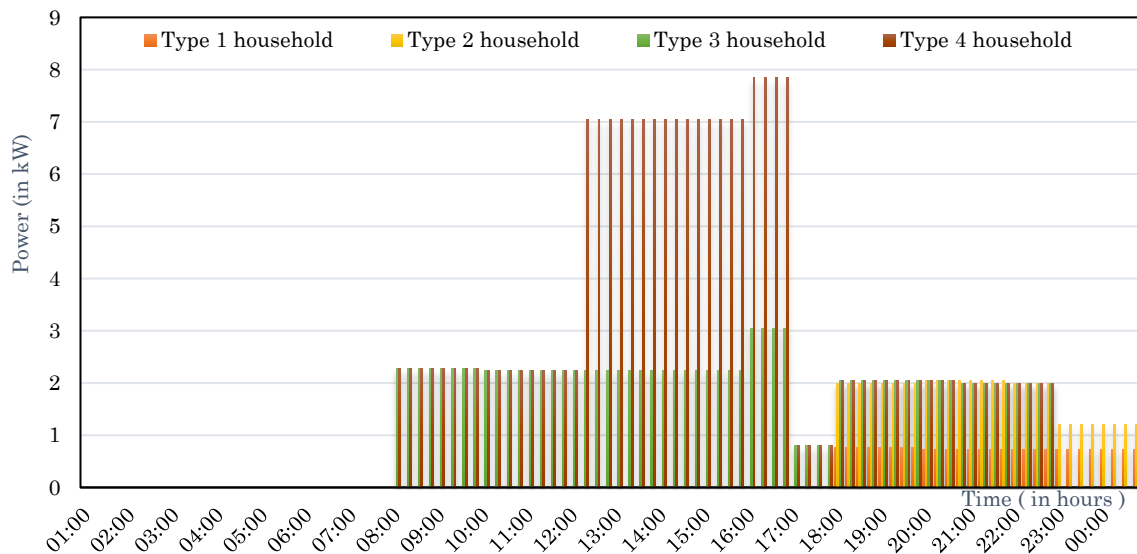

Fig.5 Load curve of daily electrical demand of four types of households

3.2. Daily profiles of the electricity demand of the four categories of households

The average daily electrical demand of the different households studied is given below and illustrated in Figure 5:

- 1 kWh/day for type 1 household;
- 2 kWh/day for type 2 household;
- 3 kWh/day for type 3 household;
- 8 kWh/day for type 4 household.

3.2.1. Estimated daily demand for electrical energy for the site of Mandelia

Figure 6 shows the evolution of the daily electricity demand of five sites. It can be seen that the lowest power peak is recorded at Kournari (about 45 kW), the highest are at Mandelia (138 kW) and Koundoul (144 kW). This is due to the basic electrical needs (lighting and charging of telephones) of type 1 households encountered in small villages while other devices (television, refrigerator, etc.) are used by type 2 and 3 households encountered in large villages.

Daily household electrical demand in Mandelia is estimated at 1,181 MWh/day. Figure 6 presents the analysis of five sites load curve and it shows that there is a zero consumption in the morning between 1 a.m. and 3

p.m. However, a period of heavy consumption is noticed in the evening from 4 p.m. to midnight. Meanwhile a stronger peak hour appears in the evening between 5 p.m. and 10 p.m. (around 138 kW).

3.2.2. Estimated daily demand for electrical energy of a site of Koundoul

Daily household electrical demand in Koundoul is estimated at 0.388 MWh/day. the analysis of the Koundoul load curve and it shows that a hollow period, but not zero, between midnight and 7 a.m is observed. Moreover, there is a low consumption in the morning between 7 a.m. and 4 p.m. However, there a period of high consumption from 6 p.m. to 10 p.m. Furthermore, a stronger peak hour (around 144 kW) is found in the evening between 6 p.m. and 8 p.m.

3.3.3. Estimated daily demand for electrical energy of a site of Linia

Linia's daily household electrical demand is estimated at 0.344 MWh/d. The load curve of Linia below illustrates that a zero consumption in the morning between 1 a.m. and 3 p.m. On the other hand, a period of heavy consumption is seen in the evening from 4 p.m. to 12 a.m. However, the stronger peak hour takes place in the evening between 6 p.m. and 9 p.m. (around 138 kW).

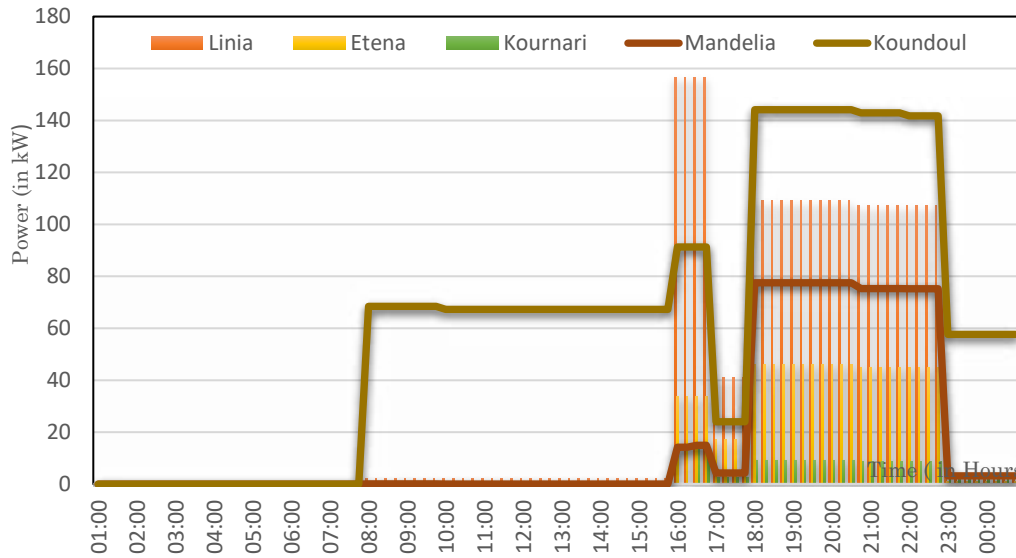

Fig. 6 Load curve of daily electrical demand of five sites surveyed

Table 8 Household payment capacity for subscribing to a category at the Mandelia site

Categories of consumption	Category 1	Category 2	Category 3	Category 4
Monthly household income (in FCFA)	30,000-45,000	60,000-90,000	120,000-150,000	180,000-210,000
Monthly payment capacity (in FCFA)	2,500	5,000	10,000	15,000
Percentage of categories	80%	20%	0%	0%
Number of current households by category	1,549	387	0	0
Number of actual households by categories in the future	801	202	0	0

3.3.4. Estimated daily demand for electrical energy of the site of Etena

Etena’s daily household electrical demand is estimated at 0.122 MWh/day. The analysis of the load curve in Figure 6 demonstrates that there is no consumption in the morning between 1 a.m. and 3 p.m. However, a period of heavy consumption is observed in the evening from 4 p.m. to 12 a.m. While the stronger peak hour is observed in the evening between 6 p.m. and 9 p.m. (around 55 kW).

3.3.5. Estimated daily demand for electrical energy of the site Kournari

The daily household electrical demand in Kournari is estimated at 0.158 MWh/d. The analysis of the Kournari load curve shows again that there is no consumption in the morning between 1 a.m. and 3 p.m. Similarly, the period of the heavy consumption takes place in the evening from 4 p.m. to 12 a.m. However, the stronger peak hour occurs in the evening between 8 p.m. and 9 p.m. (around 45 kW) (Figure 6)

3.3.6. Forecast of long-term dynamic electricity demand in villages

The data collected makes it possible to project long-term demand to optimize the sizing of different technologies (Silva & Ferr, 2011). For the scenario of the present study,

the following conditions have been considered (Salisu *et al.*, 2019; Zubi *et al.*, 2020). The demand is based on the increase in the number of different consumers, a realistic development of specific consumption, a realistic development of household income. It has also been considered that the demand will increase as the population and the size of households increases. It is based on the projection of demand over a period of 20 years (2020-2040) while the base year for forecasting demand is 2019.

Meanwhile, the transition from one consumption category to another is based on the assertion that households in category 1 in 2019 move to category 2 in 2024, those in category 2 in 2025 move to category 3 in 2030, then households in category 3 in 2031 move to category 4 in 2040. Moreover, it is assumed that the annual population growth rate is 3.4% according to INSEED (2014). Furthermore, the specific growth rate is defined by the capacity of a household subscriber to the desired category.

Although all the households surveyed wish to subscribe to a consumption category when the village is 100% electrified, however, for a return on investment, we must consider the ability of households to pay according to their monthly income. In the case of the Mandelia site, for a total population of 13,558 inhabitants distributed in 1,937 households, the average income per household is distributed as follows in Table 8.

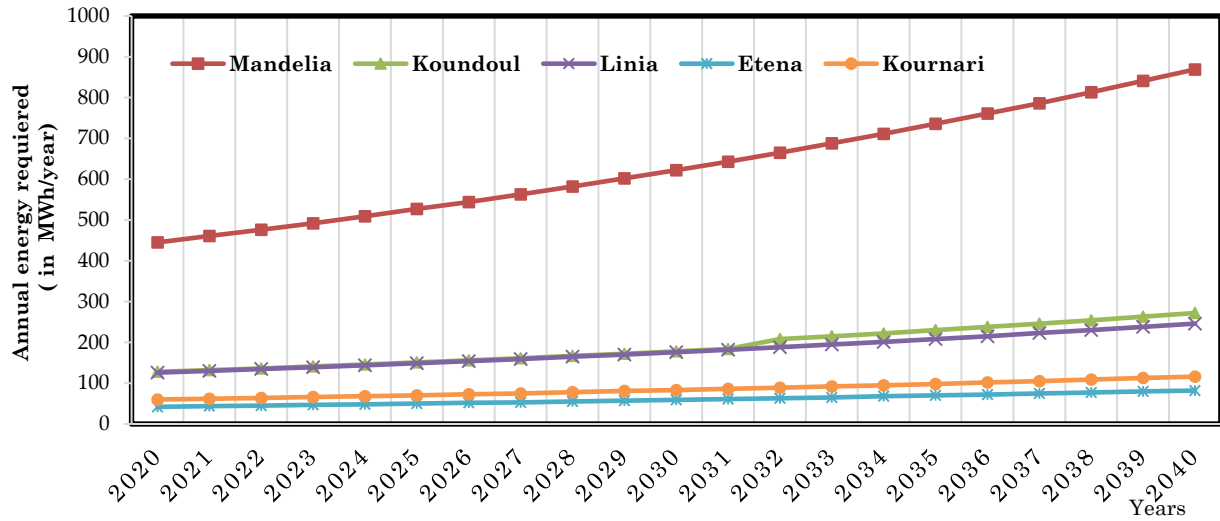

Fig. 7 Forecast of the electricity demand of 5 sites during the period 2020-2040

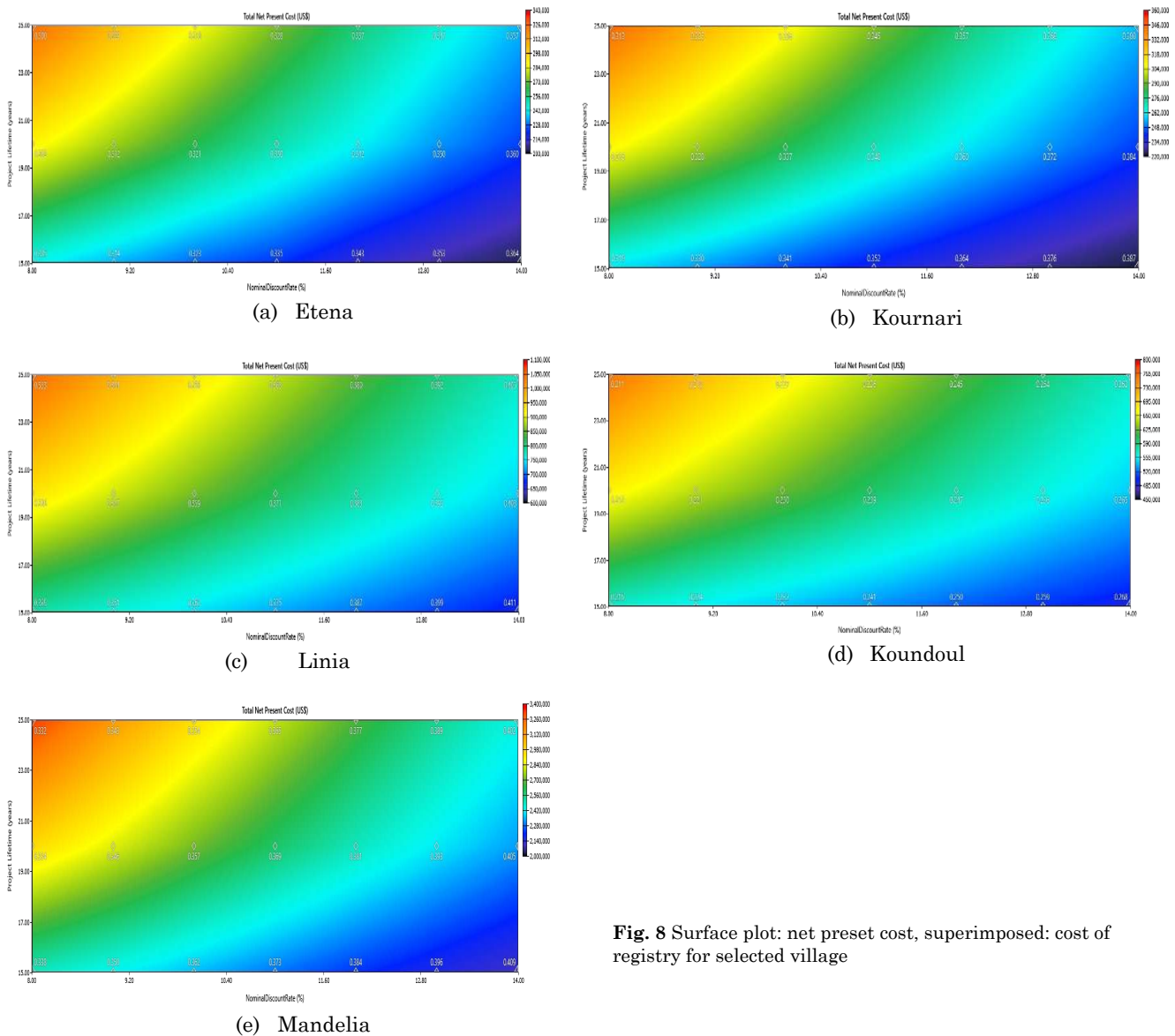

Fig. 8 Surface plot: net present cost, superimposed: cost of registry for selected village

Table 9
Optimization results by category

Village	Scenario	Architecture										Costs					System	
		PV (kW)	Wind	Diesel Generator (kW)	Battery (kWh)	Converter (kW)	Dispatch	COE (US\$/kWh)	NPV (US\$)	O&M cost (US\$/year)	Initial capital (US\$)	Renewable fraction (%)	CO ₂ (kg/year)					
Etena	PV/Diesel/Battery	110	10	10	119	32.5	LF	0.323	328,146	4,435	104,926	82.6	11,745					
Kournari	PV/ Battery	169			145	45.7	CC	0.321	360,395	5,545	137,208	100	0					
Linia	PV/ Battery	407			448	129	CC	0.363	745,496	16,728	380,611	100	0					
Koundoul	PV/ Wind/ Battery	396	1		312	104	CC	0.236	553,853	12,729	314,919	100	0					
Mandelia	PV/ Wind/ Diesel/ Battery	1,182	1	10	1,484	391	CC	0.362	2,037,000	903	1,021,000	99.6	2,626					

Table 10
Sensitivity results for the optimal hybrid system

Discount rate (%)	Project life (years)	Diesel fuel price (US\$/l)	Village	Scenario	Architecture					Costs					System	
					PV (kW)	Wind	Diesel Generator (kW)	Battery (kWh)	Converter (kW)	Dispatch	COE (US\$/kWh)	NPV (US\$)	O&M cost (US\$/year)	Initial capital (US\$)	Renewable fraction (%)	CO ₂ (kg/year)
10	25	0.50	Etena	PV/ Diesel/Battery	110	10	10	118	32.9	LF	0.300	328,146	4,435	104,926	82.6	11,647
10	25	0.50	Kournari	PV/battery	147			147	41.3	CC	0.313	349,522	5,545	137,208	100	0
10	25	0.50	Linia	PV/Battery	441			447	128	CC	0.333	1,006,000	16,728	380,611	100	0
10	25	0.50	Koundoul	PV/Wind/Battery	375			308	112	CC	0.221	765,313	12,729	314,919	100	0
10	25	0.50	Mandelia	PV/Wind/Diesel/ Battery	1,135	10	10	1,507	398	LF	0.332	3,037,000	903	1,021,000	99.6	2,434

Half of category 1 households with an income below 60,000 FCFA (120 US \$), would be excluded due to their low payment capacity. Individual solutions, such as solar kits would be offered to them. A total of 60% of the households in this village, (1,162 households) would be considered. The results of the demand forecast for different sites are presented in Figure 7.

It should be noted that during the period between 2020 and 2040, the electricity demand is projected as follow:

- From 44 to 82 MWh/year at the Etena site;
- From 62 to 116 MWh/year at the Kournari site;
- From 130 to 246 MWh/year at the Linia site;
- From 132 to 276 MWh/year at the Koundoul site;
- From 461 to 869 MWh/year at the Mandelia site.

This demand estimation or forecasting allowed us to plot both the load curve of different sites and also a forecast of demand from 2020 to 2040, as shown in Figure 7. It emerges from this study that the important parameters in an electrification project are demand percentages (2.5%), unlike the previous estimation of the rate of 10% was obtained by Erasmus (Muh & Tabet, 2018) in a case study of Cameroon, and the increase in the rate of population growth was estimated at 3.4%.

3.4. Simulation results

3.4.1. HOMER hybrid system optimization results

The simulations over the lifetime of each project (25 years) are conducted and several solutions are offered by HOMER. The most optimal results are chosen for each site. The comparison of these different scenarios is performed based on the following criteria: the net present value (NPC), the cost of energy (LCOE), low CO₂ emission rate, the penetration rate of renewable energy.

Thus, the multi-criteria optimization of different scenarios applied to each site constitutes a tool to help in decision-making in the selection of the best solutions. Table 9 summarizes the optimization results for each site. The results presented in the three categories are architecture, costs and systems (Table 9).

3.4.2. Sensitivity analysis

The sensitivity analysis allows us to appreciate certain important parameters that influence the feasibility of the project. The variation in the discount rate and in the price of reading diesel affects the economic criteria used for optimization, namely: net present cost (NPC) and discounted cost of energy (LCOE) (Table 10) and (Figure 8).

4. Discussion

4.1. Simulation results

The six solution architectures are optimized with the initial conditions: project lifespan 25 years; 5% discount rate and US \$ 1 diesel price. Based on these parameters, the optimal solutions were selected for the 5 sites under this study. These architectures include: PV/battery, PV/diesel/battery, PV/wind/battery, Wind/battery, Wind/diesel/battery and PV/wind/diesel/battery.

Based on the net present cost (NPC) criterion, the PV/battery system has the lowest value US \$ 328,146 and it was found at Etena village. The PV/Wind/Diesel/Battery hybrid configuration was the least optimum system and it has appeared in Mandelia village. In terms of energy cost, the lowest Levelized cost of energy (LCOE) was estimated at US\$ 0.236/kWh in a PV/Wind/Battery configuration at Koundoul site and the highest costs US \$ 0.363/kWh in the PV/Battery configuration at the Linia site. These results are comparable to those obtained by Azimoh in the cases of South Africa and Agykum and Ghana (Hernández-Moro & Martínez-Duart, 2012; Bonah & Nutakor, 2020) (Table 11)

4.2. Parameters sensitivity analysis

The sensitivity analysis makes it possible to assess the effect of the criteria identified on the main parameters selected for optimization, which include the net present cost (NPC), the cost of energy (LCOE) and the life of the project.

These two were chosen because they have the most influence on the cost of energy (LCOE). The results of the sensitivity of these parameters are shown in Table 10. Figure 8 illustrates the impact of changes in the discount rate and the price of diesel. Knowledge of these two parameters allows policy makers and investors to guide their decisions in choosing their investment policy in the field of renewable energy.

Over the lifespan of the project from 15 to 25 years, the optimal solutions are obtained for each solution based on two parameters; the discount rate and the price of diesel. The discount rate varies from 8 to 14% and diesel prices range between US \$ 0.50 - 1.50/litter. Moreover, when the price of diesel drops to \$ 0.50/litter and the discount rate increases to 10%, the LCOE for the Koundoul site decreases by \$ 0.221/kWh and its NPC increases to US \$ 765,331. Meanwhile, at Mandelia site, optimal solutions were obtained with the highest values, respectively US \$ 0.363/kWh for the LCOE and US \$ 2,037,000 NPC, a decrease in the LCOE (\$ 0.332/kWh) and an increase in the NPC (US \$ 3,037,000) were observed.

In Figure 8, the area represents the net present value (NPC) when the cost of energy is superimposed on the area. When the discount rate increases from 10% to 14%, the cost of energy varies from US \$ 0.416 / kWh to US \$ 0.486 / kWh at the Mandelia site.

We observed that the increasing the discount rate and the price of fuel implies the increasing of the cost of energy (LCOE). In order to attract investment in renewable energy, the Chadian government could apply lower fuel prices and apply a 0% interest rate to capital invested to make electricity available and accessible to the rural population.

Another parameter presented in Table 10 is the environmental impact of the hydride system compared to the diesel system. In this paper, the optimal hybrid solution avoids 2,548 kg / year of CO₂. This is the reduction in CO₂ emissions estimated in terms of the amount of emissions to be avoided annually for the protection of the environment linked to pollution from fossil fuels and to improve the quality of life of the population.

Table 11
Comparative studies of LCOE results

References	Geographical context	Method	Hybrid composition	LCOE (\$/kWh)
Bentouba <i>et al.</i> (2016)	Algeria	Optimization using HOMER software	PV-Wind-Diesel-Converter	0.176
Agyekum <i>et al.</i> (2020)	Ghana	Optimization using HOMER software	PV-Wind-Diesel-Battery	0.382
Current study (2021)	Chad	Optimization using HOMER software	PV-Wind-Diesel-Battery	0.363
Azimoh <i>et al.</i> (2016)	South Africa	Optimization using HOMER software	PV-Wind-Diesel-Battery	0.400
Muh <i>et al.</i> (2019)	Cameroon	Optimization using HOMER software	PV-Diesel-Hydro-Battery	0.443
Adarmola <i>et al.</i> (2017)	Ghana	Optimization using HOMER software	PV-Diesel-Battery-Converter	0.760

Uncertain factors in the calculation parameters (energy demand, fuel price, discount rate, etc.) could have a direct impact on the values of NPC and LCOE. In our study, we retained the optimal solution as a basic scenario where these values are constant: the discount rate of 8% and diesel price US \$ 1/litter. From a research perspective, real option methods (ROV) using dynamic programming, Monte Carlo simulation models can be used for NPC forecasts (Ma *et al.*, 2019; Guno *et al.*, 2021; Penizzotto *et al.*, 2019).

5. Conclusions

In this article, the economic feasibility of the following hybrid systems: PV/battery, PV/diesel/battery, PV/wind/battery, wind/battery, wind/diesel/battery and PV/wind/diesel/battery were analyzed using the multi-criteria assessment technique. It is observed that the combination of wind/diesel/battery hybrid system, resulted in a levelized cost of energy (LCOE) of US \$ 0.389/kWh, while the PV/wind/diesel/battery system gave an LCOE of US \$ 0.445 / kWh.

In terms of net present cost (NPC), the PV/battery system shows the lowest value with US \$ 299,859 at Kournari site. The highest value is obtained in the combination of PV/wind/diesel/battery at the Mandelia site with a value of US \$ 2,910,000. However, the lowest energy cost amounts to \$ 0.298 / kWh in a PV / Wind / Battery configuration and it is observed at the Koundoul site and the highest is \$ 0.445 / kWh in the PV / Wind / Diesel / Battery configuration and it is seen at the Mandelia site.

The estimate of household needs by survey carried out in situ while studies are making estimates. The declarations of household income are filled in by the respondents and compared with the macroeconomic data of the country. Also, the evaluation of solar and wind potentials is calculated from actual data collected at synoptic stations in the study area. It is concluded that for the isolated villages in Chad, hybrid solutions can be developed to make electricity available and accessible to the population

The government can play a crucial role in the most important factor in the variability of the cost of energy (LCOE), which is the price of diesel. The diesel price must be subsidized to cost 0.50 US \$ / litter instead of 1 US \$ / litter. The current existing price restrains the development of renewable energy in Chad, despite the fact that the country is endowed with huge solar energy potentials. Other policy implications can be recommended

for the government and its partners involved in the development of renewable energies in Chad:

1. Grant electricity consumption packages for low-income rural households;
2. Facilitate the business climate in order to attract foreign direct investment in the field of renewable energy;
3. Encourage public-private partnership in the execution of rural electrification projects.

The calculation parameters of LCOE, inflation and interest rates depend on the macroeconomic aggregates of the banking system of the economic zone of Central Africa, while each project could have its specificities. This continues a limit to the study. Also, the extension of the study sample to other sites in climatic zones of Chad.

The results of this study constitute a tool to support technical and economic decision-making in renewable energy investment projects in rural areas intended for political decision-makers, international investors and development partners. This constitutes a database for the construction of an atlas of renewable energy in Chad.

Acknowledgments

This research was funded by the Laboratory of Energy, Materials, Modelling and Methods, National Higher Polytechnic School of Douala, University of Douala (Cameroon) and by Universiti Tun Hussein Onn Malaysia through H919 grant.

References

- Adaramola, M. S., Quansah, D. A., Agelin-Chaab, M., & Paul, S. S. (2017). Multipurpose renewable energy resources based hybrid energy system for remote community in northern Ghana. *Sustainable Energy Technologies and Assessments*, 22, 161–170. <https://doi.org/10.1016/j.seta.2017.02.011>
- Agyekum, E. B., & Nutakor, C. (2020). Feasibility study and economic analysis of stand-alone hybrid energy system for southern Ghana. *Sustainable Energy Technologies and Assessments*, 39. <https://doi.org/10.1016/j.seta.2020.100695>
- Aleem, S. A., & Hussain, S. M. S. (2020). A Review of Strategies to Increase PV Penetration Level in Smart Grids. *Energies*, 13(10), 636. <https://doi.org/doi:10.3390/en13030636>
- Asuamah, E. Y., Gyamfi, S., & Dagoumas, A. (2021). Potential of meeting electricity needs of off-grid community with mini-grid solar systems. *Scientific African*, 11. <https://doi.org/10.1016/j.sciaf.2020.e00675>

- Azimoh, C. L., Klintonberg, P., Wallin, F., Karlsson, B., & Mbohwa, C. (2016). Electricity for development: Mini-grid solution for rural electrification in South Africa. *Energy Conversion and Management*, 110, 268–277. <https://doi.org/10.1016/j.enconman.2015.12.015>
- Barry, F., Sawadogo, M., Bologo, M., Ouédraogo, I. W. K., & Dogot, T. (2021). Key barriers to the adoption of biomass gasification in Burkina Faso. *Sustainability* 13(13). <https://doi.org/10.3390/su13137324>
- Bentouba, S., & Bourouis, M. (2016). Feasibility study of a wind–photovoltaic hybrid power generation system for a remote area in the extreme south of Algeria. *Applied Thermal Engineering*, 99, 713–719. <https://doi.org/10.1016/j.applthermaleng.2015.12.014>
- Biswajit, K., Mourshed, M., Pak, S., & Chew, K. (2015). Modelling and forecasting energy demand in rural households of Bangladesh. *Energy Procedia*, 75, 2731–2737. <https://doi.org/10.1016/j.egypro.2015.07.480>
- Bonah, E., & Nutakor, C. (2020). Feasibility study and economic analysis of stand-alone hybrid energy system for southern Ghana. *Sustainable Energy Technologies and Assessments*, 39. <https://doi.org/10.1016/j.seta.2020.100695>
- Didane, D. H., Wahab, A. A., Shamsudin, S. S., Rosly, N., Zulkafli, M. F., & Mohd, S. (2017). Assessment of wind energy potential in the capital city of Chad, N'Djamena. *AIP Conference Proceedings*, 1831. <https://doi.org/10.1063/1.4981190>
- Dufo-López, R., & Bernal-Agustín, J. L. (2008). Multi-objective design of PV-wind-diesel-hydrogen-battery systems. *Renewable Energy*, 33(12), 2559–2572. <https://doi.org/10.1016/j.renene.2008.02.027>
- Fuso Nerini, F., Dargaville, R., Howells, M., & Bazilian, M. (2015). Estimating the cost of energy access: The case of the village of Suro Craic in Timor Leste. *Energy*, 79, 385–397. <https://doi.org/10.1016/j.energy.2014.11.025>
- Gilman, P., & Lilienthal, P. (2006). Micropower system modeling. *John Wiley & Sons, Inc.* 379–418.
- Guno, C. S., Agaton, C. B., Villanueva, R. O., & Villanueva, R. O. (2021). Optimal investment strategy for solar pv integration in residential buildings: A case study in the philippines. *International Journal of Renewable Energy Development*, 10(1), 79–89. <https://doi.org/10.14710/ijred.2021.32657>
- Gupta, A., Saini, R. P., & Sharma, M. P. (2010). Steady-state modelling of hybrid energy system for off grid electrification of cluster of villages. *Renewable Energy*, 35(2), 520–535. <https://doi.org/10.1016/j.renene.2009.06.014>
- Haghighat Mamaghani, A., Avella Escandon, S. A., Najafi, B., Shirazi, A., & Rinaldi, F. (2016). Techno-economic feasibility of photovoltaic, wind, diesel and hybrid electrification systems for off-grid rural electrification in Colombia. *Renewable Energy*, 97, 293–305. <https://doi.org/10.1016/j.renene.2016.05.086>
- Hassane, A. I., Didane, D. H., Tahir, A. M., & Hauglustaine, J.M. (2018). Wind and Solar Assessment in the Sahelian Zone of Chad. *International Journal of Integrated Engineering*, 10(8), 203–213. <https://doi.org/10.30880/ijie.2018.10.08.026>
- Hernández-Moro, J., & Martínez-Duart, J. M. (2012). CSP electricity cost evolution and grid parities based on the IEA roadmaps. *Energy Policy*, 41, 184–192. <https://doi.org/10.1016/j.enpol.2011.10.032>
- Ma, Y., Swandi, K., Chapman, A., & Verbic, G. (2019). *Multi-Stage Compound Real Options Valuation in Residential PV-Battery Investment*. <http://arxiv.org/abs/1910.09132>
- Mahamat Tahir, A., Mouangue, R., Adoum Abdraman, M., & Kuitche, A. (2020). Estimate of the Wind Resource of Two Cities in the Sahara and Sahel in Chad. *International Journal of Energy and Power Engineering*, 9(6), 86–94. <https://doi.org/10.11648/j.ijepe.20200906.11>
- Micangeli, A., & Giglioli, R. (2019). Methodology for the Energy Need Assessment to Effectively Design and Deploy Mini-Grids for Rural Electrification. *Energies*, 12(10), 574. <https://doi.org/10.3390/en12030574>
- Mouangue, M.R, Tahir, A.M, Adoum Abdraman, M., & Kuiche, A.. (2019). Energy cartography of the wind resource in the city of faya and application to water pumping. *International Journal of Renewable Energy Sources*, 4, 56–67.
- Muh, E., & Tabet, F. (2018). Comparative analysis of hybrid renewable energy systems for off-grid applications in Southern Cameroons. *Renewable Energy*. <https://doi.org/10.1016/j.renene.2018.11.105>
- Nerini, F. F., Broad, O., Mentis, D., Welsch, M., Bazilian, M., & Howells, M. (2016). A cost comparison of technology approaches for improving access to electricity services. *Energy*, 95, 255–265. <https://doi.org/10.1016/j.energy.2015.11.068>
- Odou, O. D. T., Bhandari, R., & Adamou, R. (2020). Hybrid off-grid renewable power system for sustainable rural electrification in Benin. *Renewable Energy*, 145, 1266–1279. <https://doi.org/10.1016/j.renene.2019.06.032>
- Ouedraogo, B. I., Kouame, S., Azoumah, Y., & Yamegueu, D. (2015). Incentives for rural off grid electrification in Burkina Faso using LCOE. *Renewable Energy*, 78, 573–582. <https://doi.org/10.1016/j.renene.2015.01.044>
- Penizzotto, F., Pringles, R., & Olsina, F. (2019). Real options valuation of photovoltaic power investments in existing buildings. *Renewable and Sustainable Energy Reviews*, 114. <https://doi.org/10.1016/j.rser.2019.109308>
- Reserve, T. E., & Costa, T. S. (2020). Technical Evaluation of a PV-Diesel Hybrid System with Energy Storage: Case Study. *Energies*, 13(10), 2969. <https://doi.org/10.3390/en13112969>
- Salisu, S., Wazir, M., & Olatomiwa, L. (2019). Assessment of technical and economic feasibility for a hybrid PV-wind-diesel-battery energy system in a remote community of north central Nigeria. *Alexandria Engineering Journal*. <https://doi.org/10.1016/j.aej.2019.09.013>
- Seutche, R. V. N., Sawadogo, M., & Ngassam, F. N. (2021). Valuation of co2 emissions reduction from renewable energy and energy efficiency projects in Africa: A case study of Burkina Faso. *International Journal of Renewable Energy Development*, 10(4), 713–729. <https://doi.org/10.14710/ijred.2021.34566>
- Silva, C., & Ferr, P. (2011). Modeling hourly electricity dynamics for policy making in long-term scenarios. *Energy Policy*, 39, 4692–4702. <https://doi.org/10.1016/j.enpol.2011.06.062>
- Yimen, N., Hamandjoda, O., Meva'a, L., Ndzana, B., & Nganhou, J. (2018). Analyzing of a Photovoltaic/Wind/Biogas/Pumped-Hydro Off-Grid Hybrid System for Rural Electrification in Sub-Saharan Africa—Case study of Djoundé in Northern Cameroon. *Energies*, 11(10), 2644. <https://doi.org/10.3390/en11102644>
- Zubi, G., Dufo-lópez, R., Pasaoglu, G., & Pardo, N. (2020). Techno-economic assessment of an off-grid PV system for developing regions to provide electricity for basic domestic needs : A 2020 – 2040 scenario. *Applied Energy*, 176(2016), 309–319. <https://doi.org/10.1016/j.apenergy.2016.05.022>

