

# Comparison of laser beam propagation at 785 nm and 1550 nm in fog and haze for optical wireless communications

Isaac I. Kim, Bruce McArthur, and Eric Korevaar

Optical Access Incorporated  
10343 Roselle Street  
San Diego, CA 92121

## ABSTRACT

There is currently a misconception among designers and users of free space laser communication (lasercom) equipment that 1550 nm light suffers from less atmospheric attenuation than 785 or 850 nm light in all weather conditions. This misconception is based upon a published equation for atmospheric attenuation as a function of wavelength, which is used frequently in the free-space lasercom literature.<sup>1,2</sup> In hazy weather (visibility > 2 km), the prediction of less atmospheric attenuation at 1550 nm is most likely true. However, in foggy weather (visibility < 500 m), it appears that the attenuation of laser light is independent of wavelength, ie. 785 nm, 850 nm, and 1550 nm are all attenuated equally by fog. This same wavelength independence is also observed in snow and rain. This observation is based on an extensive literature search, and from full Mie scattering calculations. A modification to the published equation describing the atmospheric attenuation of laser power, which more accurately describes the effects of fog, is offered. This observation of wavelength-independent attenuation in fog is important, because fog, heavy snow, and extreme rain are the only types of weather that are likely to disrupt short (<500 m) lasercom links. Short lasercom links will be necessary to meet the high availability requirements of the telecommunications industry.

**Keywords:** laser communication, lasercom, free-space, optical wireless, atmospheric attenuation, Mie scattering, telecommunications, last mile bottleneck, last mile problem, last mile solution, 785 nm, 850 nm, 1550 nm, erbium doped fiber amplifiers, EDFA's, infrared, fog, haze, visibility, particle size distribution

## 1. INTRODUCTION

The general acceptance of free-space laser communication (lasercom) or optical wireless as the preferred wireless carrier of high bandwidth data has been hampered by the potential downtime of these lasercom systems in heavy, visibility-limiting, weather. There seems to be much confusion and many preconceived notions about the true ability of lasercom systems in such weather. Although this issue has been addressed previously<sup>3,4</sup>, there still is some confusion over how different laser wavelengths are attenuated by different types of weather. Due to a popular published equation<sup>1,2</sup>, there is currently a misconception in the lasercom community that 1550 nm is less affected by weather than 785 nm or 850 nm.<sup>3-12</sup> This paper addresses this misconception for fog (visibility < 500 m). An extensive search of the literature and some full Mie scattering calculations reveal that 1550 nm, 850 nm and 785 nm are all in fact equally attenuated in fog. A modification to the atmospheric attenuation as a function of wavelength equation, which is more realistic in fog, is presented. A better understanding of the behavior of lasercom in fog is critical to lasercom becoming the preferred solution to the last mile bottleneck. The reason for this is that in order to achieve the high availability requirements of the telecommunications (telecom) industry, lasercom links will have to be short (<500 m), or backed up by a redundant microwave or millimeter wave link at lower speed. Fog, heavy snow, and extreme rain are the primary types of weather that can affect these short lasercom links. When choosing a transmission wavelength for wireless optical telecom and datacom applications with high availability requirements, atmospheric attenuation is not a distinguishing factor.

---

Further author information

I.I.K. (correspondence): Email: [ikim@opticalaccess.com](mailto:ikim@opticalaccess.com); Web: <http://www.opticalaccess.com>  
Telephone: 858-792-8501; Fax: 858-792-8503

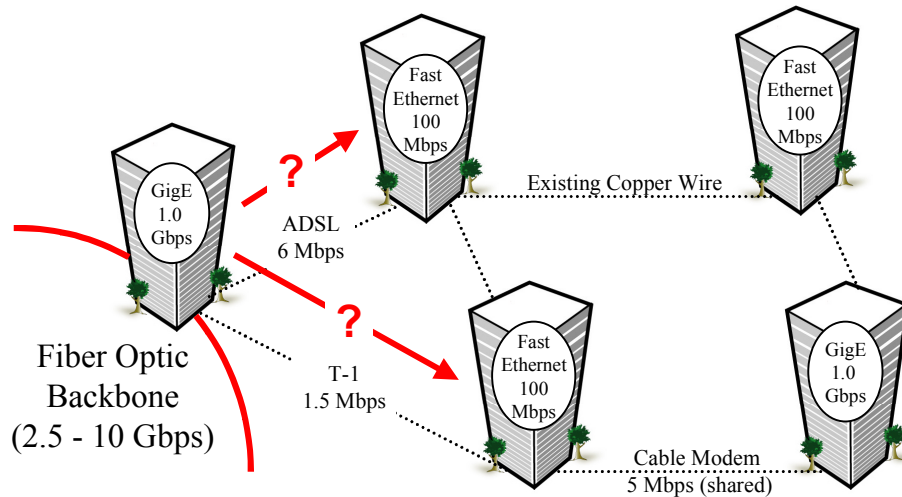
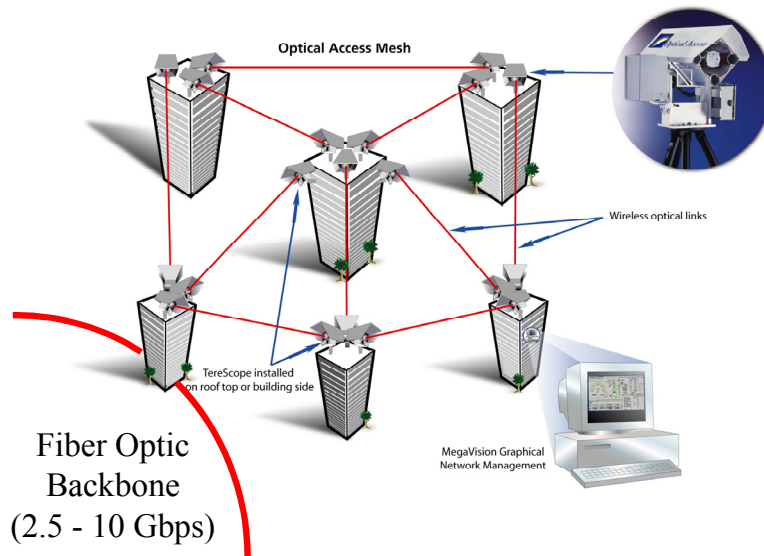

**Figure 1** The last mile problem: Studies show that less than 5% of all buildings in the US have a direct connection to the very high speed (2.5-10 Gbps) fiber optic backbone, yet more than 75% of businesses are within 1 mile of the fiber backbone.<sup>13</sup> Most of these businesses are running some high speed data network within their building, such as fast Ethernet (100 Mbps), or Gigabit Ethernet (1.0 Gbps). Yet, their Internet access is only provided by much lower bandwidth technologies available through the existing copper wire infrastructure (T-1 (1.5 Mbps), cable modem (5 Mbps shared) DSL (6 Mbps one way), etc). The last mile problem is to connect the high bandwidth from the fiber optic backbone to all of the businesses with high bandwidth networks.

## 2. THE LAST MILE PROBLEM

The current fiber optic backbone runs to central offices in most of the large population centers in the US. There has been much work done to upgrade the fiber optic backbone by both extending its reach, and increasing its bandwidth. The high bandwidth capability of the fiber optic backbone of 2.5 Gbps to 10 Gbps has been achieved by improvements in switching and optical components, and with the implementation of technologies such as wavelength division multiplexing (WDM). Most of the recent large effort of digging up the ground and laying down new fiber has been directed towards extending the fiber optic backbone to new central offices, and not laying fiber directly to the customer. In fact, only 5% of all buildings have a direct connection to the fiber optic backbone.<sup>9</sup> However, more than 75% of all businesses are within a mile of the fiber optic backbone.<sup>13</sup>

Within each of these businesses, high speed fast Ethernet (100 Mbps) or even Gigabit Ethernet (1.0 Gbps) local area networks (LAN's) are commonplace. While these data networks meet the needs for local connectivity within a single floor or building, there is a rapidly increasing need for similar high data rate connection speeds between buildings either locally or nationwide. This demand for wide-area high bandwidth is fueled by increasing commercial use of the Internet, private Intranets, electronic commerce, data storage and backup, virtual private networks (VPNs), video conferencing, and voice over IP. The key to high bandwidth wide-area connectivity is to make use of the nationwide fiber optic backbone. However, access to the fiber optic backbone for the majority of businesses, who are physically located within a mile of the fiber, is limited to the current phone or cable TV copper wire infrastructure. Newer technologies, such as Digital Subscriber Link (xDSL) or cable modems have increased the potential bandwidth over copper to 5 or 6 Mbps over more traditional Integrated Services Digital Network (ISDN) or T-1 (1.5 Mbps) lines. However, these copper-based transmission speeds are still much lower than what is necessary to fully utilize the Gbps fiber optic backbone. In addition, the ownership of the copper wires by the Regional Bell Operating Companies (RBOCs) requires leasing by any other carriers or network service providers. As shown in Figure 1, the last mile problem or bottleneck is to effectively provide a high bandwidth cost-effective connection between all of these local businesses to the fiber optic backbone.

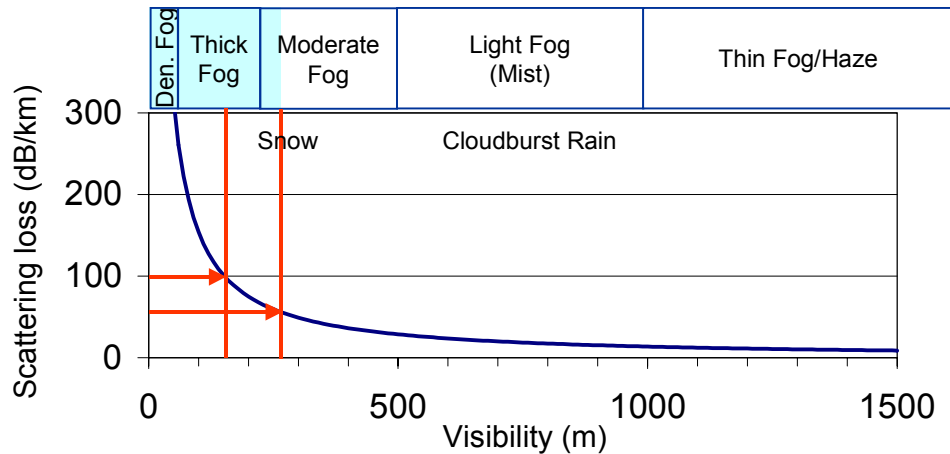

**Figure 2** A high-bandwidth cost-effective solution to the last mile problem is to use free-space laser communication (also known as or optical wireless) in a mesh architecture to get the high bandwidth quickly to the customers.

Possible solutions to the last mile bottleneck are: (1) deployment of fiber directly to all of these customers; (2) use of wireless radio frequency (RF) technology such as Local Multipoint Distribution Service (LMDS); or use of free-space laser communication (also known as optical wireless). Fiber run to every building would be the ideal solution to the last mile bottleneck from the standpoint of system availability. However, because of the high cost and the time to get right-of-way permits and to trench up the streets, fiber is not a very practical solution. LMDS is a wireless radio solution that does have bandwidth capabilities in the 100's of Mbps, but its carrier frequency lies within licensed bands. The additional large cost and time to acquire the license from the FCC makes this alternative less attractive. Also, just as with copper wire technologies, the demand for bandwidth will increase beyond what is provided by from RF technologies. Figure 2 shows the third solution, which uses free-space laser communication or optical wireless links to quickly provide local customers very high bandwidth access to the fiber optic backbone.

Free-space laser communication is very similar to fiber optic communication, except that instead of the light being contained within a glass fiber, the light is transmitted through the atmosphere. Since similar optical transmitters and detectors are used for free-space and fiber, similar bandwidth capabilities are achievable. It has also been demonstrated that WDM fiber technologies will also work in free-space, which further increases the bandwidth potential of wireless optical links.<sup>6-8,10,11</sup> However, a significant difference between free-space and fiber optic laser transmission is the predictability of the attenuation of laser power in the atmosphere compared to fiber. Fiber optic cables attenuate at a constant predictable rate. Current multimode fiber optic cables attenuate at 2 to 3 dB/km, and singlemode fibers attenuate at .5 to .2 dB/km. On the other hand, the atmosphere's attenuation of laser power is quite variable and difficult to predict.<sup>14,15</sup> Atmospheric attenuation can vary from .2 dB/km in exceptionally clear weather, to 310 dB/km in a very dense UK fog.<sup>14,15</sup> These large attenuation values in heavy fog are important because they can reduce the uptime or availability of lasercom systems.<sup>16</sup>

If proposed free-space lasercom systems, such as shown in Figure 2, are to be used in telecommunication applications, there will be requirements for very high availability. If the system link margin for atmospheric attenuation is 30 dB, then the maximum link range will have to be 100 m or less to always overcome the heaviest 300 dB/km fogs. This is the worst case scenario. In many cases, it will be very difficult to set up lasercom grids between buildings with all the links being less than 100 m in distance. By trading off more link margin and typically less extreme weather, the laser link range requirement can be extended slightly. But to satisfy telecom requirements for availability, the laser links ranges will still have to very short – on the order of less than 500 m, or be backed up by lower data rate microwave or millimeter wave links.



**Figure 3** The bottom graph shows amount of atmospheric attenuation as a function of visibility. The top shows the weather conditions that correspond to the visibility. Typical lasercom systems have 30 to 50 dB of margin at 500 m range which corresponds to handling attenuation up to 60 to 100 dB/km. The primary weather that can cause problems for these short (< 500 m) link ranges is fog and heavy snow.

For these short (<500 m) lasercom links, fog and heavy snow are the primary weather conditions which can cause link outages. This is demonstrated in Figure 3. The bottom of Figure 3 shows a plot of the atmospheric attenuation as a function of the visibility. The technical definition of visibility or visual range is the distance that light decreases to 2% of the original power, or qualitatively, visibility is the distance at which it is just possible to distinguish a dark object against the horizon.<sup>17</sup> The attenuation-visibility curve was calculated for 785 nm light from Equation 6. There is an obvious inverse relationship between visibility and the amount of attenuation. Also shown above the graph in Figure 3 are the descriptive weather conditions that are defined by the corresponding visibilities.<sup>14</sup> For example, thick fog is defined as the weather condition where the visibility is between 50 m and 250 m. Typical link margins for atmospheric attenuation can run from 30 dB to 50 dB at 500 m link range for high-end lasercom systems. 50 dB of link margin at 500 m corresponds to 100 dB/km of allowable atmospheric attenuation (see arrow at 100 dB/km on the scattering loss axis). This corresponds to weather with a visibility of 150 m (thick fog). Only weather that attenuates worse than 100 dB/km (visibility less than 150 m) will potentially take down the laser link. A system with 30 dB of atmospheric link margin at 500 m range will start to fade in weather which attenuates worse than 60 dB/km or weather with a visibility less than 270 m. In either case, it is fog (dense, thick or moderate) which is the type of weather of primary concern for these short (< 500 m) telecom lasercom links. There are also conditions of heavy snow and extreme rain that can attenuate at these high 60 to 100 dB/km levels. In this hypothetical example, losses due to scintillation fades are ignored. But for ranges of 500 m, typical scintillation fade margins are 2 to 5 dB, which is much less than the margins for atmospheric attenuation.<sup>3</sup>

### 3. ATMOSPHERIC ATTENUATION OF LASER POWER

The attenuation of laser power through the atmosphere is described by the exponential Beers-Lambert Law:<sup>2</sup>

$$\tau(R) = \frac{P(R)}{P(0)} = e^{-\sigma R} \quad (1)$$

where  $\tau(R)$  = transmittance at range  $R$ ,  
 $P(R)$  = laser power at  $R$ ,  
 $P(0)$  = laser power at the source, and  
 $\sigma$  = attenuation or total extinction coefficient (per unit length).

Typical attenuation coefficients are: clear air = 0.1 (0.43 dB/km); haze = 1 (4.3 dB/km), and fog = 10 (43 dB/km).<sup>14</sup>

Type	Radius (μm)	Size Parameter α	
		785 nm	1550 nm
Air Molecules	0.0001	0.0008	0.0004
Haze particle	0.01 - 1	0.08 - 8	0.04 - 4
Fog droplet	1 to 20	8 - 160	4 - 80
Rain	100 to 10000	800 to 80000	400 to 40000
Snow	1000 to 5000	8000 to 40000	4000 to 20000
Hail	5000 to 50000	40000 to 800000	20000 to 400000

**Table 1** Typical atmospheric scattering particles with their radii<sup>14,18</sup> and corresponding size parameter for laser transmission wavelengths of 785 nm and 1550 nm. The size parameters are plotted in Figure 4.

The attenuation coefficient has contributions from the absorption and scattering of laser photons by different aerosols and gaseous molecule in the atmosphere. Since lasercom wavelengths (typically 785 nm, 850 nm, and 1550 nm) are chosen to fall inside transmission windows within the atmospheric absorption spectra, the contributions of absorption to the total attenuation coefficient are very small.<sup>2</sup> The effects of scattering, therefore, dominate the total attenuation coefficient. The type of scattering is determined by the size of the particular atmospheric particle with respect to the transmission laser wavelength. This is described by a dimensionless number called the size parameter  $\alpha$ .<sup>18</sup>

$$\alpha = \frac{2\pi r}{\lambda} \quad (2)$$

where  $r$  = radius of the scattering particle, and  
 $\lambda$  = laser wavelength.

Table 1 shows radii of scattering particles within the atmosphere<sup>14,18</sup> and their corresponding size parameter for laser wavelengths of 785 nm and 1550 nm. The size parameters are plotted in Figure 4, along with the corresponding regions for Rayleigh, Mie, and non-selective or geometric scattering.<sup>18</sup>

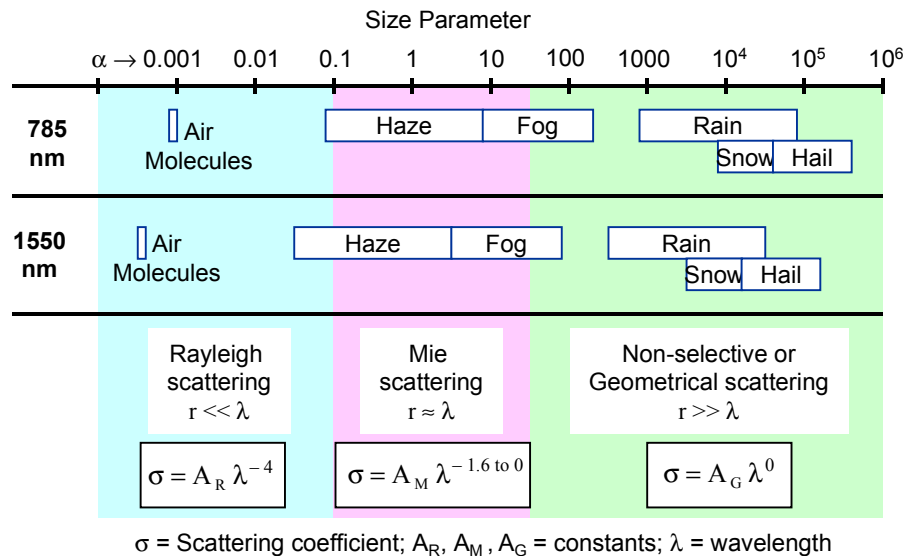

**Figure 4** Size parameters of atmospheric scattering particles in Table 1 for laser wavelengths of 785 nm and 1550 nm. Also plotted are the corresponding regions for Rayleigh, Mie, and non-selective or geometrical scattering. For each type of scattering, the approximate relationship between the particle size and wavelength, and the wavelength power law of the attenuation coefficient is shown.<sup>18</sup>

From Figure 4, Rayleigh scattering occurs when the atmospheric particles are much smaller than the wavelength. For the laser wavelengths of interest (785 nm and 1550 nm), Rayleigh scattering occurs primarily off of the gaseous molecules in the atmosphere.<sup>14</sup> The radiation from Rayleigh scattering is equally divided between forward and back scattering.<sup>18</sup> The attenuation coefficient varies as  $\lambda^{-4}$  (where  $\lambda$  is the wavelength). Since blue light is scattering much more than red light, Rayleigh scattering is responsible for the blueness of the sky.<sup>18</sup> Another consequence of Rayleigh scattering varying as  $\lambda^{-4}$  is that for the lasercom wavelengths of interest, the effect of Rayleigh scattering on the total attenuation coefficient is very small.<sup>1</sup>

As the particle size approaches the laser wavelength, the scattering of radiation off the larger particles becomes more dominant in the forward direction as opposed to the backward direction.<sup>14</sup> This type of scattering, where the size parameter varies between 0.1 and 50, is called Mie scattering.<sup>18</sup> The lasercom wavelengths are Mie scattered by haze and smaller fog particles. For Mie scattering, the exponent in the power law dependence on wavelength for the attenuation coefficient varies from 1.6 to 0.<sup>17</sup>

The third generalized scattering regime occurs when the atmospheric particles are much larger than the laser wavelength. For size parameters greater than 50, the scattering is called geometric or non-selective scattering.<sup>18</sup> The scattering particles are large enough that the angular distribution of scattered radiation can be described by geometric optics. Rain drops, snow, hail, cloud droplets, and heavy fogs will geometrically scatter lasercom light.<sup>18</sup> The scattering is called non-selective because there is no dependence of the attenuation coefficient on laser wavelength, i.e. the power law wavelength exponent is zero.<sup>17</sup>

The question this paper addresses is whether the amount of atmospheric scattering critical for telecom-type short laser links is wavelength dependent (Mie scattering), or wavelength independent (geometrical or non-selective scattering). This is an important factor when it comes to the wavelength selection for free-space lasercom systems.

#### 4. THE WAVELENGTH DEPENDENCE (?) OF ATMOSPHERIC SCATTERING

To determine whether the atmospheric attenuation critical for lasercom is wavelength dependent or not, we first go to scattering first principles. A scattering particle will have an effective scattering cross section  $C$ , which will vary depending on size parameter, which is the ratio of the size of the particle to the radiation wavelength (see Equation 2), and the difference in index of refraction between the scattering particle and the ambient air.<sup>18</sup> The scattering efficiency  $Q$  is defined as the scattering cross-section normalized by the particle cross-sectional area.<sup>19</sup>

$$Q = \frac{C}{2\pi r^2} \quad (3)$$

where  $r$  = radius of the particle.

Mie, using electromagnetic theory, derived theoretical expressions for the scattering efficiency.<sup>19</sup> Values for the scattering efficiency can be calculated using FORTRAN code, which uses Mie's theory and is available on the Internet (<http://atol.ucsd.edu/~pflatau/scatlib/>). The left side of Figure 5 shows calculated scattering efficiencies as a function of particle radius for particles made of water (index of refraction = 1.33) scattering 785 nm light. As the radius of the particle becomes large, the scattering efficiency approaches two, which is a diffraction geometrical optics effect.<sup>19</sup>

If the scattering particle size distribution is known (a distribution for a heavy fog is shown in the right side of Figure 5)<sup>20</sup>, the total scattering or attenuation coefficient  $\sigma$  can be calculated by summing the contributions from each particle size:

$$\sigma_{scat} = \sum_i n_i Q_i \pi r_i^2 \quad (4)$$

where  $n_i$  = distribution or concentration of the  $i$ th particle  
 $Q_i$  = scattering efficiency of the of the  $i$ th particle, and  
 $r_i$  = radius of the  $i$ th particle

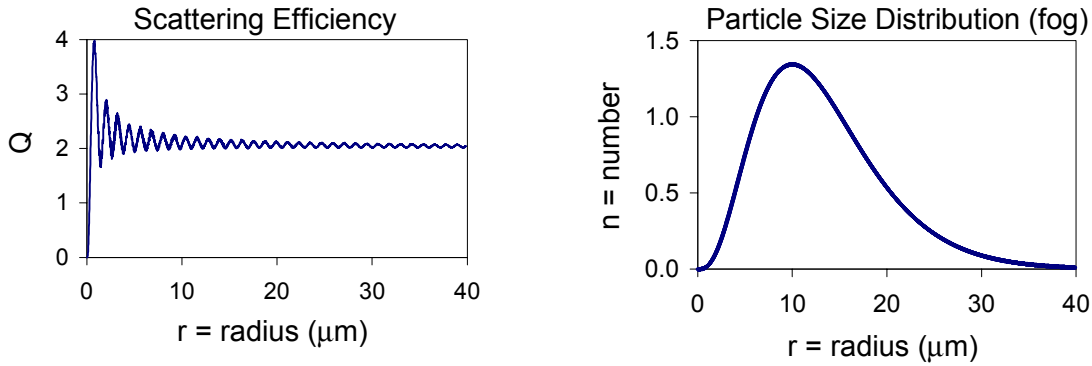

**Figure 5** (left) Scattering efficiency of water particles scattering 785 nm light as a function of particle size. (right) Particle size distribution for a heavy fog.<sup>20</sup> If the particle size distribution is known, the attenuation coefficient can be calculated by Equation 4 by summing over all particle sizes.

Unfortunately, at any given time, the scattering particle size distribution is not readily available, so determining the attenuation coefficient using Equation 4 is often not very practical. A more useful form of Equation 4 has been derived, which depends only on the visibility, which is a much more commonly available parameter.<sup>19</sup>

Since the scattering efficiency  $Q$  is a function of the size parameter, it is also a function of  $r/\lambda$ . Therefore, Equation 4 can be generalized to the form:

$$\sigma = A \lambda^{-q} \quad (5)$$

where  $A$  and  $q$  are constants determined by the size and distribution of the scattering particles.<sup>19</sup> An expression for  $A$  can be derived from the definition of visual range<sup>19</sup> and  $q$  can be determined from experimental data<sup>17</sup>, resulting in:

$$\sigma = \frac{3.91}{V} \left( \frac{\lambda}{550 \text{ nm}} \right)^{-q} \quad (6)$$

where  $\sigma$  = atmospheric attenuation (or scattering) coefficient  
 $V$  = visibility (in km)  
 $\lambda$  = wavelength (in nm)  
 $q$  = the size distribution of the scattering particles  
 = 1.6 for high visibility ( $V > 50$  km)  
 = 1.3 for average visibility ( $6 \text{ km} < V < 50 \text{ km}$ )  
 =  $0.585 V^{1/3}$  for low visibility ( $V < 6$  km)

This form to calculate the atmospheric attenuation coefficient is very handy because for a given wavelength, the amount of attenuation only depends on the visibility. The visibility is an easily obtainable parameter, either from airport or weather data. Historical visibility data from most global airports has also been archived for many years by NOAA.<sup>21</sup> These archived visibility distributions can be used along with Equation 6 and the lasercom system link budget to produce availability of lasercom as a function of link range curves.<sup>3,4</sup> These availability curves are very useful because they demonstrate geographically-local lasercom system performance over time. The value of  $q$  is important because it determines the wavelength dependence of the attenuation coefficient and the physical type of scattering (see Figure 4).

Equation 6 is referenced in lasercom textbooks<sup>1,2</sup> and used frequently in the lasercom literature.<sup>3-5,7,9,10,16</sup> Since this equation shows the atmospheric attenuation as a function of wavelength, it has been used to show that there is less attenuation or scattering using 1550 nm light compared to 785 nm light in all weather.<sup>5-12</sup> An example of this concept can be seen in Table 2.<sup>9</sup> The atmospheric attenuation values in Table 2 were calculated using Equation 6.

Visibility (km)	dB/km 785 nm	dB/km 1550 nm	Weather
0.05	315	272	Fog
0.2	75	60	
0.5	29	21	
1	14	9	Haze
2	7	4	
4	3	2	Clear
10	1	0.4	
23	0.5	0.2	

**Table 2** A table of atmospheric losses (in dB/km) as a function of visibility for 785 nm and 1550 nm calculated erroneously from Equation 6.<sup>9</sup> There appears to be a slight advantage in transmitting at 1550 nm in terms of atmospheric scattering losses in all weather. Compare to Table 4.

A search of the literature<sup>17,22-26</sup> agrees with Equation 6 (and Table 2) that there is a wavelength dependence for atmospheric attenuation in haze. However, for fog, the empirical data indicates there is no wavelength dependence for atmospheric attenuation between 785 nm and 1550 nm. A closer look at the experimental data from which the  $q$  values in Equation 6 were determined shows that the function of  $q$  at low visibility values:

$$q = 0.585 V^{1/3} \quad (7)$$

might be in error. Figure 6 shows a reproduction<sup>17</sup> of data by Wolff (solid curve)<sup>27</sup> and Löhle (circles)<sup>28</sup> used by Löhle to suggest Equation 7 (dashed curve) as a relationship between  $q$  and  $V$ . However, Middleton<sup>17</sup> has issues with the data collected for visibilities less than 1 km:

“It should be noted that these (data) are (collected) in “fog and dense haze,” so the significance of those for which  $V < 1$  km. is in doubt.” (p. 46, Middleton)<sup>17</sup>

In fact, there is strong empirical data which suggests that  $q = 0$  (ie. no wavelength dependence) for fogs where the visibility  $< 500$  m.<sup>17,22-25</sup>

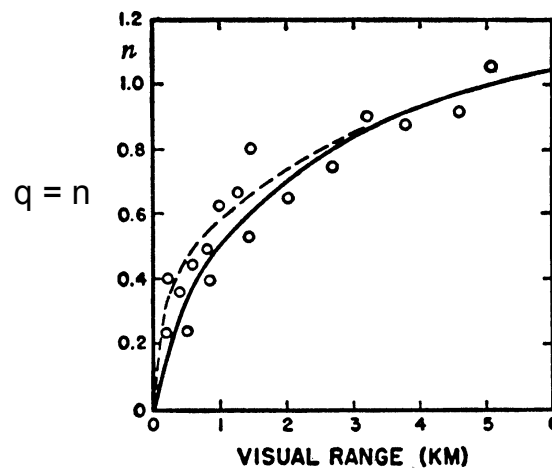

**Figure 6** Reproduction<sup>17</sup> of data by Wolff (solid curve)<sup>27</sup> and Löhle (circles).<sup>28</sup> The dashed curve is a plot of Equation 7, which was suggested by Löhle.<sup>27</sup>



Distribution Type	Modal Radius (μm)	a	α	γ	b	σ (km <sup>-1</sup> ) 785 nm	σ (km <sup>-1</sup> ) 1550 nm
Heavy Fog	10	0.027	3	1	0.3	28.4	29.0
Moderate Fog	2	607.5	6	1	3	8.93	9.71
Chu & Hogg Fog	1	341	2	0.5	4	1.62	1.71
Haze M (marine)	0.05	5.3e4	1	0.5	8.9	0.102	0.074
Haze L (continental)	0.07	5.0e6	2	0.5	15.1	0.034	0.015

**Table 3** Full Mie theory calculations for attenuation coefficient for 785 nm and 1550 nm for three fog<sup>24,31</sup> and two haze<sup>29</sup> particle distributions using Equation 4.  $a$ ,  $\alpha$ ,  $\gamma$  and  $b$  are parameters in the Deirmendjian modified gamma distribution (see Equation 8). It was assumed that the scattering particles were water (index of refraction = 1.33).

## 5. FULL MIE CALCULATIONS FOR THE ATMOSPHERIC ATTENUATION COEFFICIENT

Another approach to determine the wavelength dependence of atmospheric attenuation is to perform the full Mie calculation for some known particle size distributions (see Equation 4). A popular analytic size distribution model for atmospheric particles is the Deirmendjian modified gamma distribution:<sup>29</sup>

$$n(r) = a r^\alpha \exp(-b r^\gamma) \quad (8)$$

where  $n$  = particle concentration per unit volume per unit increment of the radius  
 $r$  = radius of the particle  
 $a$ ,  $\alpha$ ,  $b$ ,  $\gamma$  = positive and real constants, and  $\alpha$  is an integer.

The Deirmendjian modified gamma distribution goes to 0 at  $r = 0$  and  $\infty$ . An example of a Deirmendjian distribution for heavy fog is shown on the right side of Figure 5. As noted previously, the Bohren and Huffman FORTRAN code to calculate the scattering efficiency using Mie theory is available on the Internet (<http://atol.ucsd.edu/~pflatau/scatlib/>).<sup>30</sup> Table 3 shows the results of calculating attenuation coefficients using Equation 4 for three fog and two haze particle distributions.<sup>24,29,31</sup> It was assumed that the scattering particles were made up entirely of water (index of refraction = 1.33).

The first interesting observation is that for the heavy and moderate fogs, there is an actual slight increase in atmospheric attenuation at 1550 nm compared to 785 nm. The slight increase in attenuation as the wavelength increases for the Infrared in fog has been observed in other experimental data.<sup>17,22,23,25</sup> Whether there is a slight increase in attenuation in fog at 1550 nm compared to 785 nm, the effect is small and negligible. It is more significant to say that these calculations show that there is no significant difference in atmospheric attenuation between 785 nm and 1550 nm in fog. This calculated no wavelength dependence of attenuation in fog agrees with the empirical data.<sup>17,22-26</sup> The haze distributions do show an increase in calculated attenuation at 785 nm compared to 1550 nm. This increase in calculated attenuation as the wavelength decreases in haze is also observed in the empirical data.<sup>17,22-26</sup> Note that the calculated attenuation coefficients for the haze distributions are very low and are closer to values expected for clearer air.<sup>14</sup>

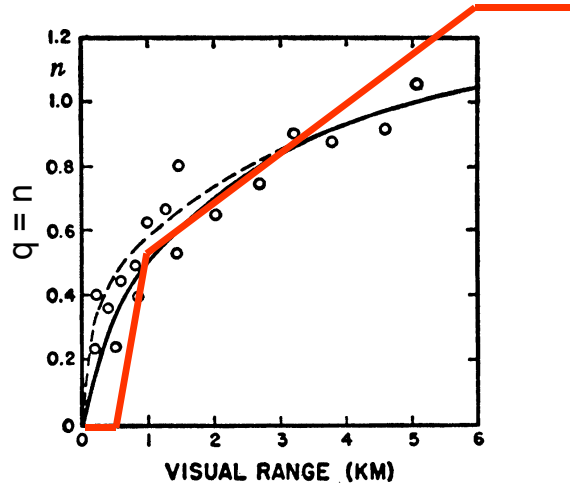

Figure 7 Plot of Figure 6 with proposed new wavelength dependence function (see Equation 9).

## 6. NEW WAVELENGTH DEPENDENCE FUNCTION FOR ATMOSPHERIC ATTENUATION

Both the full Mie theory calculations in the previous section, and other experimental data<sup>17,22-26</sup> show that in fog, there is no wavelength dependence to atmospheric attenuation. In haze, the atmospheric attenuation does increase as the wavelength decreases. Assuming that Middleton's questioning of the validity of the data in Figure 6 for visibilities less than 1 km, is correct, then the expression for  $q$  (see Equation 7) is suspect for the shorter visibilities. Eldridge<sup>25</sup> defined three generalized types of shorter visibility weather: fog for visibilities less than 500 m, haze for visibilities greater than 1000 m, and a transitional zone called mist for visibilities between 500 m and 1000 m. These zones are based on changes in observed particle size distributions and changes in the wavelength selectivity of measured attenuation coefficients, which have been mentioned previously. Eldridge<sup>25</sup> indicates that haze is primarily made of microscopic fine dust or salt or small water drops on the order of a few tenths of a micron. Fog occurs during very high relative humidity (> 95%) when water droplets of a few microns to a few tens of microns form over the haze particle nuclei. Mist occurs during the transition from haze to fog as the humidity increases to saturation. This transition is generally quick as there is a substantial increase in 1 to 2 micron droplets that causes a rapid deterioration of the visibility. From averaging other attenuation coefficient studies, Eldridge<sup>25</sup> determined that the mist transition is defined by visibilities between 500 m and 1000 m. Using Eldridge's definitions of the fog, mist, and haze regimes, the data from Figure 5 for visibilities greater than 1 km, and the observation that in fog, there is no wavelength dependence, a new expression for the value of  $q$  in Equation 6 for visibility < 6 km, is proposed. For simplicity, we have broken down the expression for  $q$  into 3 straight-line segments, one for each of Eldridge's low visibility regimes:

$$\begin{aligned}
 q &= 0 && \text{for fog } (V < 500 \text{ m}) \\
 &= V - .5 && \text{for mist } (500 \text{ m} < V < 1 \text{ km}) \\
 &= 0.16 V + 0.34 && \text{for haze } (1 \text{ km} < V < 6 \text{ km})
 \end{aligned} \tag{9}$$

where  $V$  is the visibility in km. These line segments are shown plotted over the original Wolff<sup>27</sup> and Löhle<sup>28</sup> data in Figure 7. In reality, the actual  $q$  equation is mostly likely some smoothed curved function, but to start with, we will use this simple three-segment model. We believe this expression is more realistic than Equation 7, especially for fog conditions, because it results in no wavelength dependence for atmospheric attenuation that has also been observed in experimental data. Equation 9 also transitions better to a  $q$  value of 1.3 for the visibility range of 6 to 50 km (see Equation 6). We propose Equation 9 replaces Equation 7 to determine  $q$  values for visibilities less than 6 km, which are then used in the atmospheric attenuation equation (Equation 6). Using  $q$  values from the new Equation 9, the values for atmospheric attenuation shown in Table 2 were recalculated. These new attenuation values are shown in Table 4. The values for atmospheric attenuation in fog are now the same between 785 nm and 1550 nm.

Visibility (km)	dB/km 785 nm	dB/km 1550 nm	Weather
0.05	340	340	Fog
0.2	85	85	
0.5	34	34	
1	14	10	Haze
2	7	4	
4	3	2	
10	1	0.4	Clear
23	0.5	0.2	

**Table 4** A table of atmospheric losses (in dB/km) as a function of visibility for 785 nm and 1550 nm calculated using the new expression for  $q$  (Equation 9). There is no longer any difference in attenuation losses transmitting at 1550 nm or 785 nm in fog conditions ( $< 500$  m visibility).

## 7. CONCLUSION

There is currently a misconception among the lasercom community that there is an inherent advantage of using 1550 nm over 780 nm with respect to atmospheric attenuation in all weather<sup>5-12</sup>. This misconception is based on a published equation that is referenced in lasercom textbooks<sup>1,2</sup> and used frequently in the lasercom literature.<sup>3-5,7,9,10,16</sup> In haze conditions, there is a wavelength dependence to the atmospheric attenuation. However, it has been shown through an extensive literature search of past experimental observations<sup>17,22-26</sup> and some full Mie theory scattering calculations, that this is not the case in fog. In fog conditions, where the visibility is less than 500 m, there is no advantage of 1550 nm over 785 nm when considering the effects of atmospheric attenuation. A new proposed part of the equation for the atmospheric attenuation is presented. In its complete form:

$$\sigma = \frac{3.91}{V} \left( \frac{\lambda}{550 \text{ nm}} \right)^{-q} \quad (10)$$

where  $\sigma$  = atmospheric attenuation (or scattering) coefficient

$V$  = visibility (in km)

$\lambda$  = wavelength (in nm)

$q$  = the size distribution of the scattering particles

= 1.6 for high visibility ( $V > 50$  km)

= 1.3 for average visibility ( $6 \text{ km} < V < 50 \text{ km}$ )

=  $0.16V + 0.34$  for haze visibility ( $1 \text{ km} < V < 6 \text{ km}$ )

=  $V - 0.5$  for mist visibility ( $0.5 \text{ km} < V < 1 \text{ km}$ )

= 0 for fog visibility ( $V < 0.5 \text{ km}$ )

This equation needs to be verified by new experimental work, which we propose to do in the future.

The reason why there is so much concern about lasercom performance in fog, is that fog (and heavy snow) are the most critical types of weather for short ( $< 500$  m) lasercom links. These short lasercom links will be necessary in future telecom/last mile optical wireless installations to meet the high availability requirements (telecom-required high availabilities can also be achieved by using a microwave back-up in tandem with the lasercom link). When selecting a transmission wavelength for a lasercom system, atmospheric attenuation is only one of many factors to consider. Other factors include eye safety limits, bandwidth capabilities of available components, and cost. One final note: The best way to overcome preconceived notions of the weather limitations of free-space lasercom is to educate the potential future users of the actual effects of weather (this paper is an attempt at that). It is critical to never over-sell the capabilities of lasercom. As long as lasercom is used within its capabilities, it will become the preferred high-bandwidth wireless technology for telecom carriers, and the solution to the last mile bandwidth bottleneck.

## REFERENCES

1. W. K. Pratt, *Laser Communication Systems*, J. Wiley & Sons, New York, 1969.
2. H. Weichel, *Laser Beam Propagation in the Atmosphere*, SPIE, Bellingham WA, 1990.
3. I. I. Kim, J. Koontz, H. Hakakha, P. Adhikari, R. Stieger, C. Moursund, M. Barclay, A. Stanford, R. Ruigrok, J. Schuster, and E. Korevaar, "Measurement of scintillation and link margin for the TerraLink™ laser communication system," *Wireless Technologies and Systems: Millimeter Wave and Optical, Proc. SPIE*, **3232**, pp. 100-118, 1997.
4. I. I. Kim, R. Stieger, J. Koontz, C. Moursund, M. Barclay, P. Adhikari, J. Schuster, and E. Korevaar, "Wireless optical transmission of Fast Ethernet, FDDI, ATM, and ESCON protocol data using the TerraLink laser communication system," *Opt. Eng.*, **37**, 3143-3155, 1998.
5. P. F. Szajowski, G. Nykolak, J. J. Auburn, H. M. Presby, G. E. Tourgee, E. Korevaar, J. Schuster, and I. I. Kim, "2.4 km free-space optical communication 1550 nm transmission link operating at 2.5 Gb/s – experimental results," *Optical Wireless Communications, Proc. SPIE*, **3532**, pp. 29-40, 1998.
6. G. Nykolak, P. F. Szajowski, J. Jacques, H. M. Presby, J. A. Abate, G. E. Tourgee, J. J. Auburn, "4x2.5 Gb/s 4.4 km WDM free-space optical link at 1550 nm," Post Deadline Paper Optical Fiber Conference, 1999.
7. P. F. Szajowski, J. J. Auburn, G. Nykolak, H. M. Presby, and G. E. Tourgee, "High power optical amplifiers enable 1550 nm terrestrial free-space optical data-link operating @ WDM 2.5 Gb/s data rates," *Optical Wireless Communications II, Proc. SPIE*, **3850**, pp. 2-10, 1999.
8. G. Nykolak, J. J. Auburn, H. M. Presby, P. F. Szajowski, and G. E. Tourgee, "Update on 4x2.5Gb/s, 4.4 km free-space optical communications link: availability and scintillation performance," *Optical Wireless Communications II, Proc. SPIE*, **3850**, pp. 11-19, 1999.
9. I. I. Kim, M. Mitchell, and E. Korevaar, "Measurement of scintillation for free-space laser communication at 785 nm and 1550 nm," *Optical Wireless Communications II, Proc. SPIE*, **3850**, pp. 49-62, 1999.
10. P. F. Szajowski, G. Nykolak, J. J. Auburn, H. M. Presby, G. E. Tourgee, D. M. Romain, "Key elements of high-speed WDM terrestrial free-space optical communications systems," *Free-Space Laser Communication Technologies XII, Proc. SPIE*, **3932**, pp. 2-14, 2000.
11. G. Nykolak, P. F. Szajowski, A. Cashion, H. M. Presby, G. E. Tourgee, J. J. Auburn, "A 40 Gb/s DWDM free space optical transmission link over 4.4 km," *Free-Space Laser Communication Technologies XII, Proc. SPIE*, **3932**, pp. 16-20, 2000.
12. T. H. Carbonneau and G. S. Mecherle, "SONAbeam optical wireless products," *Free-Space Laser Communication Technologies XII, Proc. SPIE*, **3932**, pp. 45-51, 2000.
13. Ryan, Hankin, and Kent study.
14. E. J. McCartney, *Optics of the Atmosphere*, J. Wiley & Sons, New York, 1976.
15. P. P. Smyth, P. L. Eardley, K. T. Dalton, D. R. Wisely, P. McKee, and D. Wood, "Optical wireless – a prognosis," *Wireless Data Transmission, Proc. SPIE*, **2601**, pp. 212-225, 1995.
16. B. R. Strickland, M. J. Lavan, E. Woodbridge, and V. Chan, "Effects of fog on the bit error rate of a free-space laser communication system," *Applied Optics*, **38**, pp. 424-431, 1999.
17. W. E. K. Middleton, *Vision Through the Atmosphere*, U. of Toronto Press, Toronto, 1952.
18. J. M. Wallace and P. V. Hobbs, *Atmospheric Science: An Introductory Survey*, Academic Press, Orlando, 1977.
19. P. W. Kruse, L. D. McGlauchlin, and R. B. McQuistan, *Elements of Infrared Technology: Generation, Transmission, and Detection*, J. Wiley & Sons, New York, 1962.
20. M. E. Thomas, and D. D. Duncan, "Atmospheric transmission," in *Atmospheric Propagation of Radiation*, SPIE Press, Bellingham, 1993.
21. *International station meteorological climate summary*. Ver. 4.0, Federal Climate Complex Asheville, 1996.
22. A. Arnulf, J. Bricard, E. Cure, and C. Veret, "Transmission in haze and fog in the spectral region 0.35 to 10 microns," *J. Optical Soc. of Am.*, **47**, pp. 491-498, 1957.
23. R. G. Eldridge, "Haze and fog aerosol distributions," *J. of Atmospheric Sc.*, **23**, pp. 605-613, 1966.
24. T. S. Chu and D. C. Hogg, "Effects of precipitation on propagation at 0.63, 3.5, and 10.6 microns," *Bell Syst. Tech. J.*, **47**, pp. 723-759, 1968.
25. R. G. Eldridge, "Mist – the transition from haze to fog," *Bull. Am. Meteorological Soc.*, **50**, pp. 422-426, 1969.
26. T. H. Carbonneau and D. R. Wisely, "Opportunities and challenges for optical wireless; the competitive advantage of free space telecommunications links in today's crowded marketplace," *Wireless Technologies and Systems: Millimeter Wave and Optical, Proc. SPIE*, **3232**, pp. 119-128, 1997.
27. M. Wolff, "Die lichttechnischen eigenschften des nebls," *Das Licht*, **8**, pp. 105-109, 128-130, 1938.
28. F. Löhle, "Über die lichtzerstreuung im nebel," *Phys. Zeits.*, **45**, pp. 199-205, 1944.
29. D. Deirmendjian, *Electromagnetic Scattering on Spherical Polydispersions*, Elsevier, New York, 1969.
30. C. F. Bohren and D. R. Huffman, *Absorption and Scattering of Light by Small Particles*, Wiley-Interscience, New York, 1983.
31. E. P. Shettle, "Models of aerosols, clouds, and precipitation for atmospheric propagation studies," *Atmospheric Propagation in the UV, Visible, IR, and MM-Wave region and Related Systems Aspects AGARD Conf. Proc.*, **454**, pp. 15-1 to 15-13, 1989.