

Comparison of Methods for On-Line Harmonic Estimation

Jovan M. Knežević and Vladimir A. Katić

Abstract—The aim of this paper is to present a comparison of some popular methods for online harmonic estimation. The well-known methods Discrete Fourier Transform (DFT), Enhanced Phase Locked Loop (EPLL), Adaptive Notch Filter (ANF) and method based on Extended Kalman Filter (EKF) are simulated and compared. The methods are compared in critical phases, such as the fast change of harmonic amplitudes and the change of the system frequency.

Index Terms—Power Electronics/Harmonic estimation /Simulation

I. INTRODUCTION

THE number of sensitive devices that require high power quality, i.e. high quality of power supply is constantly increasing [1]. On the other hand the use of applications of nonlinear loads, mostly consisting of power electronics devices, is growing even at faster pace. Such loads and devices are distorting supply waveforms and therefore polluting power system grid. The development of tools for accurate harmonic estimation enables a proper operation of the devices for mitigation of power quality imperfections.

The Fourier Transform (FT) and its discrete form the Discrete FT (DFT) have been the most common tool used by researchers and practitioners over last several decades [2]. The DFT decomposes signals into fundamental and higher order harmonics. Many problems of the DFT such as spectral leakage, picket fence effects and sensitivity to the variations of the system frequency are limiting its accuracy. To preserve time information in the signal the windowed DFT known also as Short Time Fourier Transform has been developed [2].

In recent years, in order to overcome above mentioned problems, the researchers have been developing methods that can adaptively track changes in the system. The methods based on the Enhanced Phase Locked Loop have been presented [3]-[5]. They use one EPLL block to adaptively track an amplitude and the phase of the particular harmonic.

Manuscript received 30 May 2012. Accepted for publication 10 June 2012. Some results of this paper were presented at the 16th International Symposium Power Electronics, Novi Sad, Serbia, October 26-28, 2012.

This paper is supported by the Ministry of Education and Science of Republic of Serbia, through project No. III 42004, Smart Electricity Distribution Grids Based on Distribution Management System and Distributed Generation (2011-2014).

J. M. Knežević is with BMW Peugeot Citroen GmbH, Munich, Germany (e-mail: jovan.knezevic@bpc-electrification.com).

V. A. Katić is with Faculty of Technical Sciences, University of Novi Sad, Novi Sad, Serbia. (e-mail: katav@uns.ac.rs).

The method of [3]-[5] makes a fundamental assumption that the existing frequency components in the signal are in the form of harmonics [2]. The Adaptive Notch Filter (ANF) presented in [6], on the other hand, relaxes that assumption and presents a major improvement of the methods presented in [7] and [8] which enables direct detection and extraction of arbitrary frequency components. Such methods are very accurate in a non-stationary environment but they have slower dynamic response than the DFT [6].

To achieve a higher resolution and better estimation accuracy and still to preserve adaptive feature, the Kalman Filter (KF) have been suggested [10]. The KF is a mathematical model that uses noisy and inaccurate measurement data and provides an efficient computational (recursive) means to estimate the past, present or future values in a way that minimizes the mean of the squared error. In order to achieve higher accuracy an accurate model is required. For nonlinear model, the extended KF is used [9].

In this paper several methods for online harmonic estimation are simulated and compared. The most common tool - the DFT, methods based on gradient descent method EPLL and ANF and ECKF are tested in the typical environment with fast dynamical changes of system parameters.

II. METHODS

A. Discrete Fourier Transform

The FT is one of the most frequently used techniques of signal analysis [1], [2]. The FT $X(f)$ of the continuous signal $x(t)$ is defined in (1). Considering the periodical nature of the electrical current and voltage as well as the use of the digital signal processing, the DFT is used as a conventional tool.

$$X(f) = \int_{-\infty}^{\infty} x(t)e^{-j2\pi ft} dt \quad (1)$$

The DFT $X[k]$ of the sampled signal $x[n]$ is defined as:

$$X[k] = \sum_{n=0}^{N-1} x[n]e^{-j\frac{2\pi kn}{N}} \quad (2)$$

$x[n]$ is the sampled value of the continuous signal $x(t)$ at time instant nT

$$x[n] = x(nT), \quad n = 0, 1, 2, \dots, N-1 \quad (3)$$

The recursive algorithm of the DFT can be easily represented by equations (4) and (5) assuming that the DFT is

implemented as the windowed DFT with the square window of the width equal to the period of the fundamental harmonic.

$$a_i[n] = a_i[n-1] + \frac{2}{N}(x[n] - x[n-N])\cos\left(\frac{2\pi ni}{N}\right) \quad (4)$$

$$b_i[n] = b_i[n-1] + \frac{2}{N}(x[n] - x[n-N])\sin\left(\frac{2\pi ni}{N}\right) \quad (5)$$

where N is the number of samples per period of the fundamental component of the signal, i is the order of the harmonic and a_i and b_i are the real and imaginary coefficients of the DFT. Fig. 1 presents MATLAB-Simulink model of the DFT. It shows how many calculations are necessary to obtain a_i and b_i coefficients of the DFT.

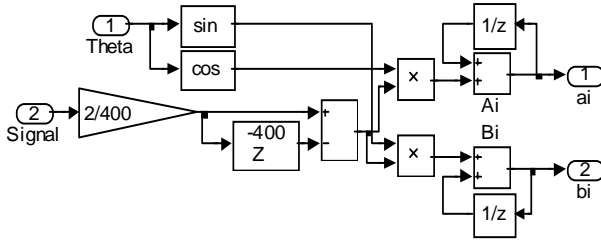

Fig. 1. MATLAB-Simulink model of the DFT.

It is obvious that it is very easy to calculate these Fourier coefficients, but if it is necessary to have the amplitude and the phase of a certain harmonic, such calculations require additional computational effort of the digital processor as given in (6) and (7).

$$A_i = \sqrt{a_i^2 + b_i^2} \quad (6)$$

$$\delta_i = \arctan\left(\frac{b_i}{a_i}\right) \quad (7)$$

After the amplitude and the phase are obtained, reconstruction of the particular harmonic is given as:

$$h_i(t) = A_i \sin(i\omega_1 t + \delta_i) \quad (8)$$

Some sources of errors in the DFT can be recognized as aliasing, spectral leakage, picket fence, etc. [2]. These errors are particularly enhanced in cases of fast varying signals of transients. In those cases the signal frequency is changing even with the pace faster than one period of the fundamental harmonic (20ms in 50Hz systems) [2].

B. The Enhanced Phase Locked Loop

Continuous signal can be represented as:

$$x(t) = \sum_{i=1}^N x_i \quad (9)$$

$$x_i(t) = A_i \sin(\omega_i t + \delta_i) \quad (10)$$

where i is the order of the harmonic so that ω_1 represents the fundamental frequency component (the first harmonic) and higher harmonic components are defined by $i > 1$. Usually $\omega_i = i\omega_1$, but this is not necessarily true in all cases. The task of the EPLL is to extract individual harmonic components of the signal $x(t)$. The least squares error between the input of the EPLL $x(t)$ and the estimated signal $x_i(t)$ is

minimized by the method of gradient descent [5]. The cost function is defined as:

$$J(t, A_i(t), \phi_i(t)) = \frac{1}{2} [x(t) - x_i(t, A_i(t), \phi_i(t))]^2 = \frac{1}{2} e^2(t, A_i(t), \phi_i(t)) \quad (11)$$

If it is assumed that $\Theta \in R^N$ is the vector of parameters $A_i(t), \phi_i(t)$ the gradient descent method can be written as:

$$\frac{\partial}{\partial t} \Theta(t) = -\mu_i \frac{\partial}{\partial \Theta} J(t, \Theta(t)) \quad (12)$$

The gradient descent method provides a method of adjusting the parameter Θ so that the cost function J converges to its minimum point. The EPLL is developed as an adaptive notch filter and is described by the following differential equations:

$$\frac{dA_i(t)}{dt} = \mu_{1i} e_i(t) \sin \phi_i(t) \quad (13)$$

$$\frac{d\omega_i(t)}{dt} = \mu_{2i} e_i(t) \cos \phi_i(t) \quad (14)$$

$$\frac{d\phi_i(t)}{dt} = \mu_{3i} \mu_{3i} e_i(t) \cos \phi_i(t) + \omega_{0i} \quad (15)$$

$$y_i(t) = A_i(t) \sin \phi_i(t) \quad (16)$$

$$e_i(t) = x(t) - y_i(t) \quad (17)$$

$$\phi_i(t) = \omega_{0i} t + \delta_i \quad (18)$$

Detailed derivations and stability analysis can be found in [5]. Fig. 2 shows a very simple implementation of the computational unit in the MATLAB/Simulink of the EPLL.

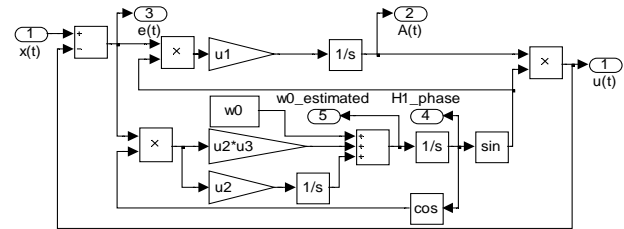

Fig. 2. MATLAB-Simulink model of the EPLL.

A proper setting of the parameters μ_{1i} , μ_{2i} and μ_{3i} ensures the convergence of the solution to differential equations. The parameter μ_{1i} controls the amplitude and the others control the phase and frequency tracking properties. Larger μ_{1i} guarantees a faster step response of the amplitude, but also introduces a higher steady state error. It is a trade-off between accuracy and speed. In order to reduce ripple in the response of the EPLL, it is possible to introduce filters for the amplitude and frequency, but this further decreases the time response.

C. Adaptive Notch Filter

An ANF has been recently proposed in [6]-[8]. The dynamic behaviour of the ANF is defined by following set of differential equations:

$$\ddot{y}_k + \theta_k^2(t) y_k = 2\zeta_k \theta_k(t) e(t) \quad (19)$$

$$\dot{\theta}_k(t) = -\gamma_k \theta_k(t) e(t), k = 1, \dots, n \quad (20)$$

$$e(t) = x(t) - \sum_{k=1}^n \dot{y}_k(t) \quad (21)$$

where $x(t)$ is the input signal, θ_k is the estimated frequency of the k th component, and γ_k and ζ_k are both real and positive numbers which determine the behaviour of the k th subfilter of the ANF in terms of accuracy and convergence speed.

It can be found that for the input signal $x(t)$ the dynamical system (19)-(21) has a unique quasi orbit given by:

$$P(t) = \left(P_1^T(t) \dots P_n^T(t) \right)^T \quad (22)$$

where $P_k(t)$ is given by

$$P_k(t) = \begin{pmatrix} \bar{y}_k \\ \dot{\bar{y}}_k \\ \bar{\theta}_k \end{pmatrix} = \begin{pmatrix} -\frac{A_k}{\omega_k} \cos \phi_k(t) \\ A_k \sin \phi_k(t) \\ \omega_k \end{pmatrix}, \quad k = 1, \dots, n \quad (23)$$

This means that the k th constituting component of the input signal as well as its frequency are directly provided by the k th set of the differential equations (19)-(21), and hence, a full decomposition is achieved if a sufficient number of filters are employed.

Detailed derivations and stability analysis can be found in [6]. Fig. 3 shows a very simple implementation of the subfilter unit of the ANF in the MATLAB/Simulink and its full decomposition of the parallel structure in fig.4..

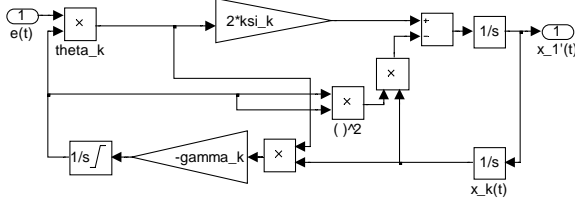

Fig. 3. MATLAB-Simulink model of one Subfilter of the ABF.

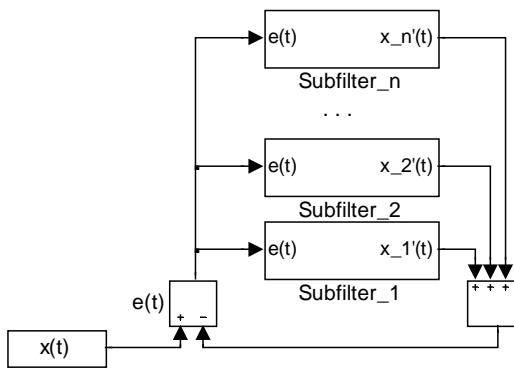

Fig. 4. Full Decomposition of the parallel structure of the ANF.

Similar to the DFT, the amplitude and phase shift of particular harmonic can be calculated as:

$$A_k = \sqrt{\bar{\theta}_k^2 \bar{x}_k^2 + \dot{\bar{x}}_k^2} \quad (24)$$

$$\phi_k = \arctan\left(\frac{\dot{\bar{x}}_k}{\bar{\theta}_k \bar{x}_k}\right) \quad (25)$$

D. The Extended Complex Kalman Filter

An observed signal at time k can be described in a power system as a sum of N of x_i sinusoids (9) with white noise v_i :

$$x_k = \sum_{i=1}^N (x_i + v_i) \quad (26)$$

$$v_i \approx N(0, R_i)$$

The observation noise v_i is a Gaussian white noise with zero mean and variance σ_v^2 . The covariance of measured errors is $R_k = E[v_k v_k^{*T}]$. For the sake of simplicity, let us consider only single complex sinusoid x with the angular frequency ω_l and the amplitude a_l . Complex type state variables are defined as [10]:

$$x_{k(1)} = e^{j\omega_l T_s}$$

$$x_{k(2)} = a_1 e^{j(k\omega_l T_s + \phi_1)} \quad (27)$$

$$x_{k(3)} = a_1 e^{-j(k\omega_l T_s + \phi_1)}$$

The state – space model is written as:

$$x_{k+1} = f(x_k) \quad (28)$$

$$y_k = Hx_k + v_k$$

where:

$$x_k = [x_{k(1)} \quad x_{k(2)} \quad x_{k(3)}]^T \quad (29)$$

$$f(x_k) = \begin{bmatrix} x_{k(1)} & x_{k(1)}x_{k(2)} & \frac{x_{k(3)}}{x_{k(2)}} \end{bmatrix}^T \quad (30)$$

$$H = [0 \quad -0.5i \quad 0.5]^T \quad (31)$$

The recursive process of the ECKF is then:

State Prediction

$$\tilde{x}_{k+1|k} = f(\hat{x}_{k|k}) \quad (32)$$

the symbols \sim and $\hat{\cdot}$ stand for the estimated and predicted values, respectively.

$$P_{k+1|k} = F_k P_{k|k} F_k^{*T} + Q_k \quad (33)$$

$$F_k = \frac{\partial f(x_k)}{\partial x_k} \quad (34)$$

$$F_k = \begin{bmatrix} 1 & 0 & 0 \\ x_{k(2)} & x_{k(1)} & 0 \\ -x_{k(3)}/x_{k(1)}^2 & 0 & 1/x_{k(1)} \end{bmatrix} \quad (35)$$

State Filter

$$\hat{x}_{k|k} = \tilde{x}_{k|k-1} + K_k (y_k - H\tilde{x}_{k|k-1}) \quad (36)$$

and the Kalman filter gain is calculated as:

$$K_k = P_{k|k-1} H^T [HP_{k|k-1} H^T + R_k]^{-1} \quad (37)$$

$$P_{k|k} = P_{k|k-1} - K_k H P_{k|k-1} \quad (38)$$

The parameters of the frequency f_k , and amplitude a_k at time k can be obtained as:

$$f_k = \frac{1}{2\pi T_s} \left[\text{Im}(\ln(\hat{x}_{k(1)})) \right] \quad (39)$$

$$a_k = \hat{x}_{k(2)} \quad (40)$$

More details about the ECKF can be found in [9] and [10].

III. SIMULATION

All of the mentioned methods have been simulated in the MATLAB/Simulink environment. In this paper these methods have been tested in the case of fast changes of system parameters, amplitude and the frequency. In order to do this, two test signals have been defined:

$$x_1(t) = A_1(t) \sin(\omega_1 t) \quad (41)$$

$$A_1(t) = \begin{cases} 1 & t \leq 100\text{ms} \\ 1.2 & t > 100\text{ms} \end{cases} \quad (42)$$

$$\omega_1 = 2 \cdot \pi \cdot 50$$

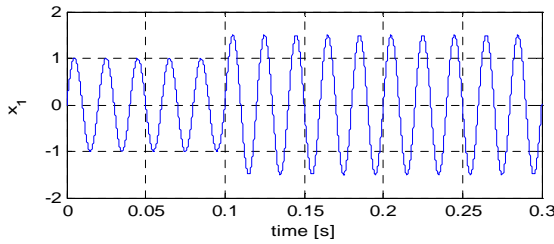

Fig. 5. Test signal x_1 .

and the second.

$$x_2(t) = A_2 \sin(\omega_2(t)t) \quad (43)$$

$$\omega_2(t) = \begin{cases} 2 \cdot \pi \cdot 50 & t \leq 100\text{ms} \\ 2 \cdot \pi \cdot 60 & t > 100\text{ms} \end{cases} \quad (44)$$

$$A_2 = 1$$

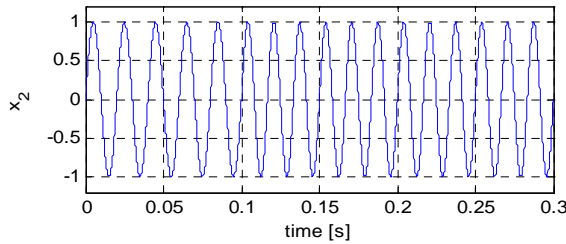

Fig. 6. Test signal x_2 .

A. Change of the amplitude

In fig.7 to fig.10 analysis of the signal x_1 is shown. A sudden step of the signal amplitude is analysed. As it is well known the DFT and ECKF have a faster step response while the EPLL and ANF are significantly slower.

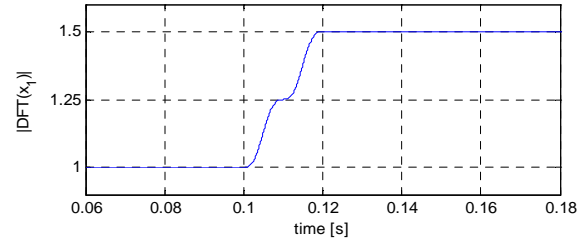

Fig. 7. Amplitude of the signal x_1 using DFT.

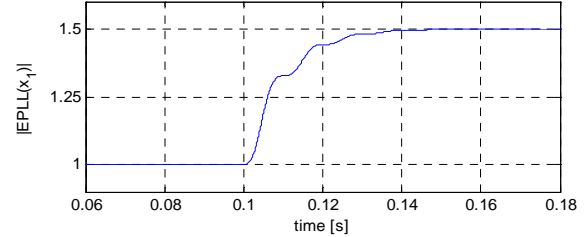

Fig. 8. Amplitude of the signal x_1 using EPLL.

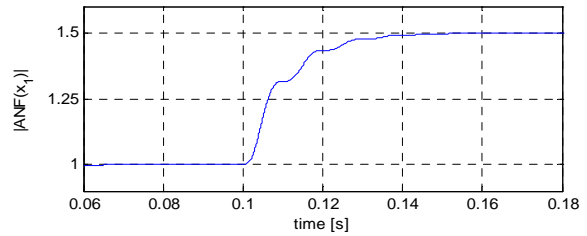

Fig. 9. Amplitude of the signal x_1 using ANF.

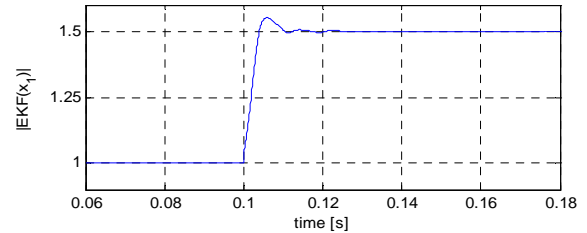

Fig. 10. Amplitude of the signal x_1 using ECKF.

B. Change of the frequency

In fig.11 to fig.14 analysis of the signal x_2 is shown. In the signal x_2 a sudden change of the frequency can be seen. A known problem of the DFT can be seen in fig.11. The DFT doesn't work properly in the case of variable frequency. The EPLL and ANF needed some time to converge to the new value of the signal frequency while the ECKF is obviously faster.

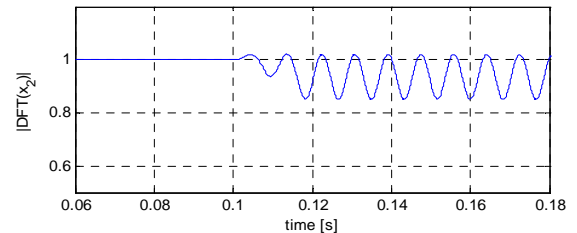
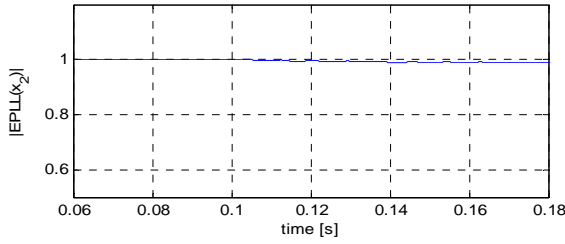
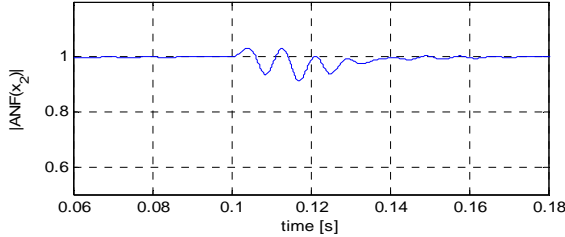
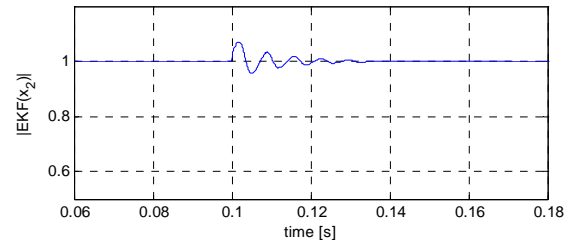

Fig. 11. Amplitude of the signal x_2 using DFT.

Fig. 12. Amplitude of the signal x_2 using EPLL.Fig. 13. Amplitude of the signal x_2 using ANF.Fig. 14. Amplitude of the signal x_2 using ECKF.

C. Example

In fig.15 the test signal x_3 is shown. It has a main harmonic as well as the 5th and 7th harmonic and white noise $n(t)$.

$$x_3(t) = A_1 \sin(\omega_0 t) + A_5 \sin(5 * \omega_0 t) + A_7 \sin(7 * \omega_0 t) + n(t) \quad (45)$$

$$A_1 = \begin{cases} 1 & t \leq 0.1 \\ 1.5 & t > 0.1 \end{cases} \quad (46)$$

$$A_5 = \begin{cases} 0 & t \leq 0.1 \\ 0.5 & t > 0.1 \end{cases}$$

$$A_7 = \begin{cases} 0 & t \leq 0.1 \\ 0.3 & t > 0.1 \end{cases}$$

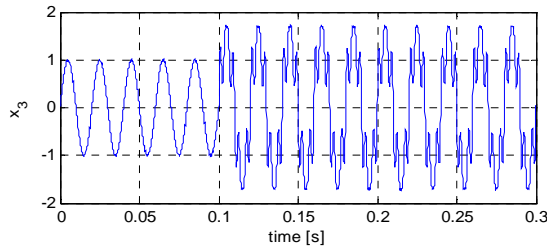
Fig. 15. Test signal x_3 .

The analysis of the signal x_3 is shown in fig.16 to fig.19. In the case of several harmonics and constant system frequency the DFT is very accurate with the delay of 20ms. The ECKF is

even faster if the parameters of the noise are known. Methods based on the gradient descent method need more time to converge to the steady state values.

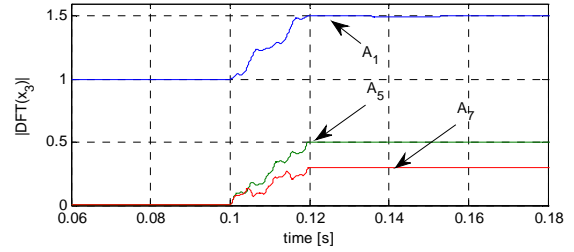
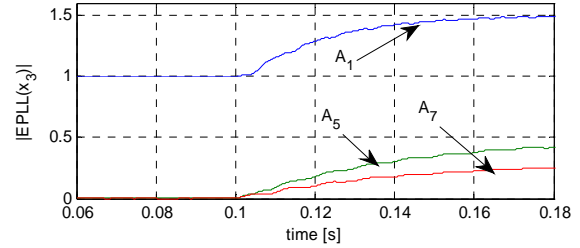
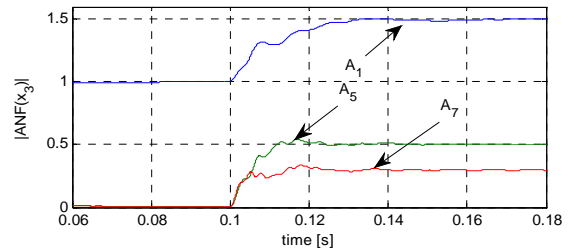
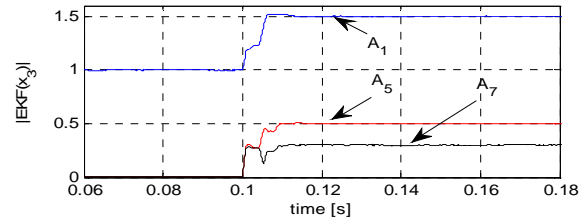
Fig. 16. DFT analysis of the signal x_3 .Fig. 17. EPLL analysis of the signal x_3 .Fig. 18. ANF analysis of the signal x_3 .Fig. 19. ECKF analysis of the signal x_3 .

IV. CONCLUSION

In this paper several methods for harmonic analysis are compared. The DFT, methods based on the gradient descent method the EPLL and ANF and ECKF are simulated in the typical environment with fast dynamical changes of system parameters. The DFT and ECKF are fast and accurate. In the case of the variable system frequency the DFT can produce significant errors. In the case of slow changes the EPLL and ANF can adaptively and accurately track the parameters of the system. The EPLL and ANF are simple and easy to implement while the ECKF is very complex and requires powerful processor.

REFERENCES

- [1] D. Sabin and A. Sandaram, "Quality Enhances Reliability," *IEEE Spectrum*, vol.33, no.2, pp.34-41, Feb.1996.
- [2] Sachin K. Jain and S.N. Singh, "Harmonics estimation in emerging power system: Key issues and challenges," *Electric Power Systems Research*, vol.81, pp.1754-1766, June 2011.
- [3] A.K. Ziarani and A. Konrad, "A method of extraction of non-stationary sinusoids," *Signal Processing*, vol. 84, no. 8, pp. 1323–1346, 2004.
- [4] M. Karimi-Ghartemani and M.R. Iravani, "Measurement of harmonics/inter-harmonics of time-varying frequencies," *IEEE Trans. on Power Delivery*, vol. 20, no. 1, pp. 23–31, Jan. 2005.
- [5] M. Karimi-Ghartemani and A.K. Ziarani, "Performance characterization of a nonlinear system as both an adaptive notch filter and a phase-locked loop," *Int. Journal on Adaptive Control Signal Processing*, vol. 18, pp. 23–53, 2004.
- [6] M. Mojiri, M. Karimi-Ghartemani and A. Bakhshai "Processing of harmonics and interharmonics using an adaptive notch filter," *IEEE Trans. on Delivery*, vol. 25, pp. 534–542, 2010.
- [7] M. Mojiri, M. Karimi-Ghartemani and A. Bakhshai "Time-domain signal analysis using adaptive notch filter," *IEEE Trans. on Signal Process*, vol. 55, pp. 85–93, Jan. 2007.
- [8] M. Mojiri and A. Bakhshai "Estimation of n frequencies usign adaptive notch filter," *IEEE Trans. Circuits Syst. II*, vol. 54, pp. 338–342, Apr. 2007
- [9] C.I. Chen, G.W. Chang, R.C. Hong and H.M. Li, "Extended Real Model of Kalman Filter for Time Varying Harmonic Estimation," *IEEE Trans. on Power Delivery*, vol. 25, pp. 17–28, Jan. 2010.
- [10] C.H. Huang, C.H Lee, K.J. Shih and Y.J. Wang, "Frequency Estimation of Distorted Power System Signals Using a Robust Algorithm," *IEEE Trans. on Power Delivery*, vol. 23, pp. 41–52, Jan. 2008.