

COMPARISON OF TOUGHENED COMPOSITE LAMINATES USING
NASA STANDARD DAMAGE TOLERANCE TESTS

Jerry G. Williams
NASA Langley Research Center
Hampton, Virginia

T. Kevin O'Brien
Army Structures Laboratory, USARTL (AVSCOM)
Hampton, Virginia

A. J. Chapman III
NASA Langley Research Center
Hampton, Virginia

ACEE COMPOSITE STRUCTURES TECHNOLOGY CONFERENCE

Seattle, Washington

August 13-15, 1984

INTRODUCTION

Composite structures technology for large transport aircraft has been successfully developed through contracts sponsored by the NASA Aircraft Energy Efficiency (ACEE) Project Office. Secondary and empennage composite components developed to replace metal structures on existing transport aircraft have demonstrated weight reductions of twenty to twenty-eight percent. The success of the NASA sponsored programs has encouraged manufacturers to employ composite structures in numerous components of their new generation transport aircraft. To translate the weight saving potential of composites into significant increases in operating efficiency, NASA is currently sponsoring contract programs with the commercial transport manufacturers to develop the technology required to design and build composite wing and fuselage structures.

An important consideration in attaining the potential structural efficiency improvements with resin matrix composite structures is the need to improve their resistance to impact damage which may occur in normal service, and to improve resistance to delamination which could result from unforeseen out-of-plane loads. Such improvements would enable the use of higher design strains and avoid penalizing factors to account for reduced structural properties resulting from damage or unforeseen loads. To meet the need for improved damage tolerance, the manufacturers of composite materials are developing materials having tougher resin matrices, where toughness is defined as the ability to deform elastically under interlaminar shear and peel stresses without the brittle fracture characteristic of the first generation resin matrices which are currently in use.

To promote systematic evaluation of the new materials, NASA and industry representatives have selected and standardized a set of five common tests for characterizing the toughness of resin matrix/graphite fiber composites. Procedures and specifications for these tests are described in Reference 1. Notch sensitivity is evaluated through open hole tension and open hole compression tests. Impact damage tolerance is evaluated through compression test following impact at selected energy levels. Resistance to delamination is evaluated through tension edge-delamination tests and double cantilever beam tests.

Several new resin/graphite fiber materials have been subjected to standard damage tolerance tests and results are compared to ascertain which materials may have superior toughness. In addition, test results from the various company and NASA laboratories are compared to indicate repeatability of test results and feasibility for developing a common data base. The materials tested represent the aircraft manufacturers' initial selection of newer toughened resin composites, and do not represent an endorsement of or commitment to use any particular material.

NASA/INDUSTRY STANDARD DAMAGE TOLERANCE TEST HISTORY

Proposed application of composites to transport wing and fuselage structures has prompted the search for tougher materials having improved resistance to impact damage and delamination. To evaluate the toughness of new materials against the more demanding requirements, NASA and the ACEE Contractors have identified and selected a set of "standard tests" which are now used by all of the ACEE Contractors as well as researchers at the Langley Research Center (figure 1). The tests were selected through workshops involving both NASA and Contractor representatives.

The need for standard evaluation of newly available toughened composites was agreed upon during the initial Peer Review for the Composite Wing Key Technology programs, held at Lockheed (Burbank, CA) during November 1981. Following this initial agreement, a workshop was held at Boeing (Seattle, WA) in December 1981, during which five tests were selected and specifications and procedures were worked out and mutually agreed upon. Each test was sponsored by one representative having wide experience with its application and results.

The five selected tests evaluate interlaminar fracture toughness (edge delamination tension and double cantilever beam tests), notch sensitivity (open-hole tension and compression tests), and the effect of impact damage on compression strength. Specifications and procedures for the standard tests are published in NASA Reference Publication 1092 (ref. 1) which is available for general distribution.

- NASA and ACEE contractors identified mutual need for standard test methods to evaluate merit of new toughened resin and fiber materials
- Test methods selected through NASA/Industry workshops
 - Key technology peer review - Lockheed - November 1981
 - Standard tests workshop - Boeing - December 1981
- Proposed tests
 - Interlaminar fracture toughness
 - Edge delamination
 - Double cantilever beam
 - Damage tolerance
 - Open-Hole tension and compression
 - Compression after impact
- NASA Reference Publication 1092: "Standard Tests for Toughened Resin Composites"
 - Published May 1982
 - Revised 1983

Figure 1

STANDARD TESTS FOR TOUGHENED COMPOSITES

Specimens used in the five standard damage tolerance tests designated ST1 through ST5 are shown drawn to the same scale in figure 2. Details of the specimens and test methods are described in reference 1. A quasi-isotropic laminate approximately 0.25 in. thick is specified for compression after impact (ST1), open hole tension (ST3), and open hole compression (ST4) tests. Two different orthotropic laminates designed to yield high transverse normal tension stresses are used in the edge delamination test (ST2) and a unidirectional laminate is used for the double cantilever beam test (ST5). An impact energy of 20 ft-lb obtained by dropping a 10-lb weight with a 0.5-in diameter hemispherical tip a distance of 2 feet is the specified impact test condition.

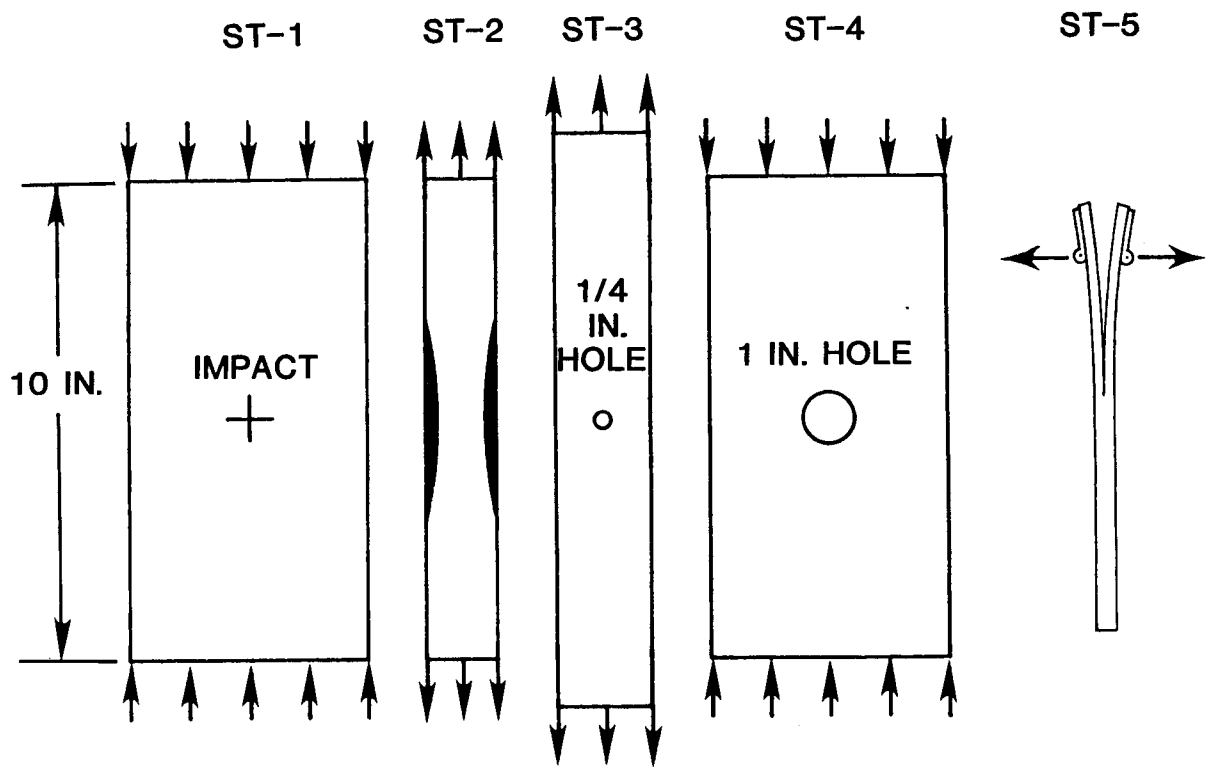

Figure 2

MATERIALS SYSTEMS

The eighteen materials systems studied in the current investigation along with the corresponding fiber and resin suppliers are presented in figure 3. The materials systems include combinations of seven fibers and thirteen resins provided by eight individual suppliers. Data for materials systems 1 and 2 are provided as a baseline for comparison purposes. T300/5208 is representative of the deficiency characteristic of most currently popular materials relative to reduced compression strength following impact damage (refs. 2, 3). Improved performance following impact damage has been demonstrated for several materials systems including T300/BP907 (ref. 4). Most of these toughened materials, however, have reduced strength properties at elevated temperatures or other deficiencies. Materials systems 3, 6-8, and 10-15 were selected by either Boeing, Douglas, or Lockheed for evaluation as toughened material candidates for evaluation under the NASA ACEE program. Data for materials systems 9, 16, and 17 were made available by Lockheed from independent study. Data for materials system 18 is taken from reference 5.

No.	Fiber	Resin	Fiber Supplier	Resin Supplier	Laminate Fabricator
1	● T300	5208	Union Carbide	Narmco	NASA
2	■ T300	BP907	Union Carbide	Amer. Cyanamid	NASA
3	T300	914	Union Carbide	Ciba Geigy	Douglas
4	T700	BP907	Union Carbide	Amer. Cyanamid	NASA
5	AS4	3502	Hercules	Hercules	NASA
6	AS4	2220-1	Hercules	Hercules	Lockheed
7	AS4	2220-3	Hercules	Hercules	Boeing
8	AS4	5245C	Hercules	Narmco	Boeing
9	AS6	2220-1	Hercules	Hercules	Lockheed ^a
10	AS6	2220-3	Hercules	Hercules	Boeing
11	AS6	5245C	Hercules	Narmco	Boeing
12	Celion	982	Celanese	Amer. Cyanamid	Lockheed
13	Celion HS	2566	Celanese	Ciba Geigy	Douglas
14	Celion HS	1504	Celanese	Hexcel	Lockheed
15	Celion HS	5245	Celanese	Narmco	Lockheed
16	Celion HS	806-2	Celanese	Amer. Cyanamid	Lockheed ^a
17	Celion HS	HST-7	Celanese	Amer. Cyanamid	Lockheed ^a
18	Courtaulds	Peek APC-1	ICI	ICI	ICI ^b

a Data from independent study

b Reference 5

Figure 3

EDGE DELAMINATION TENSION TEST MEASURES
INTERLAMINAR FRACTURE TOUGHNESS (ST-2)

A simple tension test has been developed for measuring the interlaminar fracture toughness of composites made with toughened matrix resins (refs. 6-10). The test involves measuring the modulus, E_{LAM} , and the nominal strain at onset of edge delamination, ϵ_c , during a tension test of an 11-ply $[\pm 30/\pm 30/90/90]_s$ or an 8-ply $[\pm 35/0/90]_s$ laminate (fig. 4). These quantities, along with the measured thickness, t , are substituted into a closed form equation for the strain energy release rate, G , for edge delamination growth in an unnotched laminate (ref. 6). The E^* term in the equation is the modulus of the laminate if the 0/90 interface is completely delaminated. The delamination modulus, E^* , may be calculated from the simple rule of mixtures equations shown in the figure by using laminated plate theory to calculate the sublaminates moduli. The critical value of G_c at delamination onset is a measure of the interlaminar fracture toughness of the composite. Furthermore, finite element analysis of the two edge delamination test (EDT) layups indicates that the $[\pm 30/\pm 30/90/90]_s$ layup consisted of 57 percent G_I due to interlaminar tension, whereas the $[\pm 35/0/90]_s$ layup consisted of nearly 90 percent G_I . In both cases, the remainder of G was due to G_{II} , resulting from interlaminar shear. Both of these layups were used to measure the interlaminar fracture toughness of toughened resin composites (ref. 1).

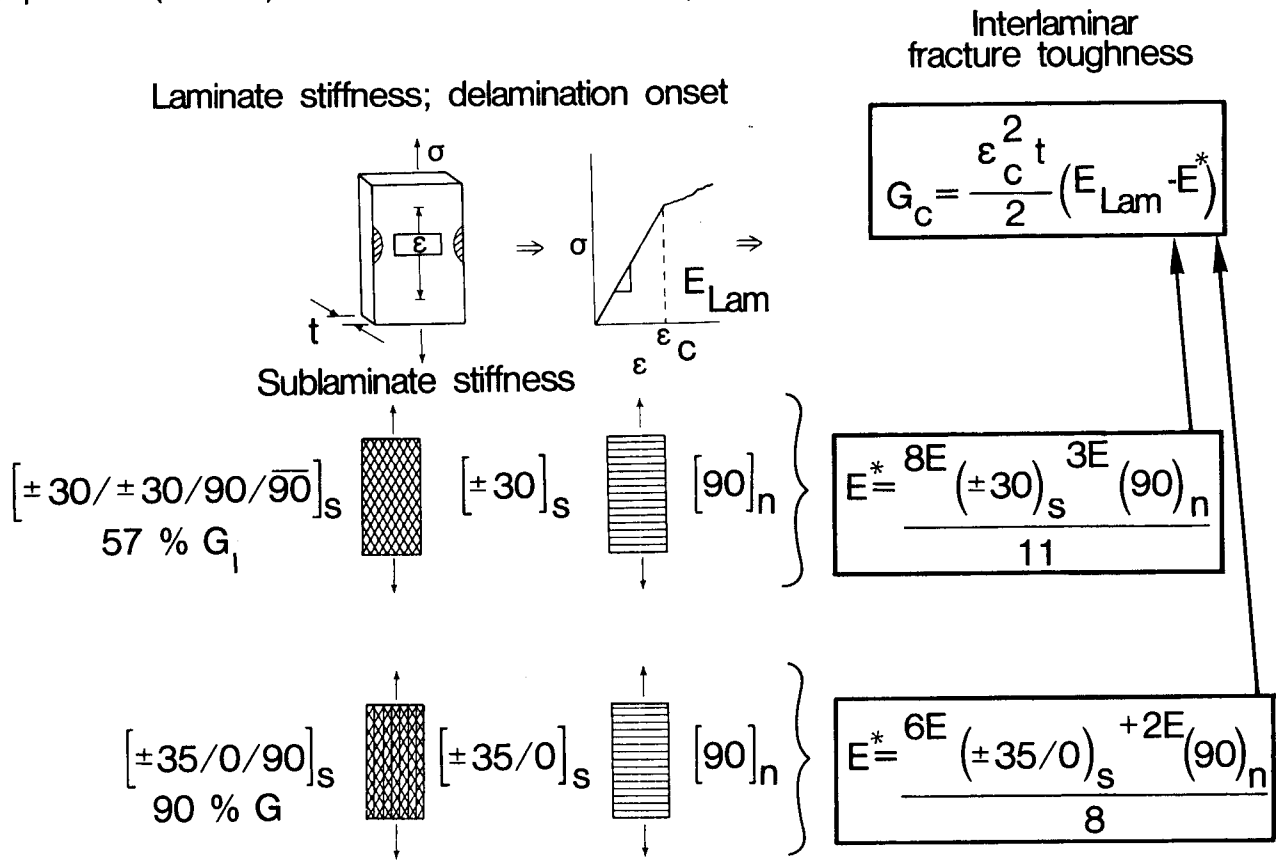

Figure 4

EDGE DELAMINATION TEST REPEATABILITY

Figures 5 and 6 show G_c values for five different graphite reinforced composite materials measured using the $[\pm 30/\pm 30/90/90]_s$ and $[\pm 35/0/90]_s$ edge delamination tests, respectively. Each material was tested by NASA Langley and by one of the key technologies contractors (Lockheed, Boeing, or Douglas). As the figures indicate, good repeatability of G_c measurements was achieved from tests conducted at the different laboratories.

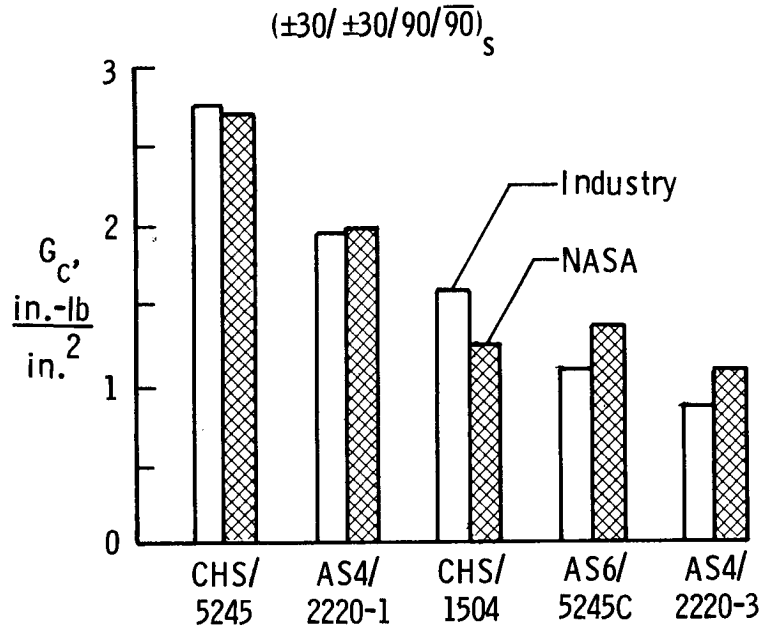

Figure 5

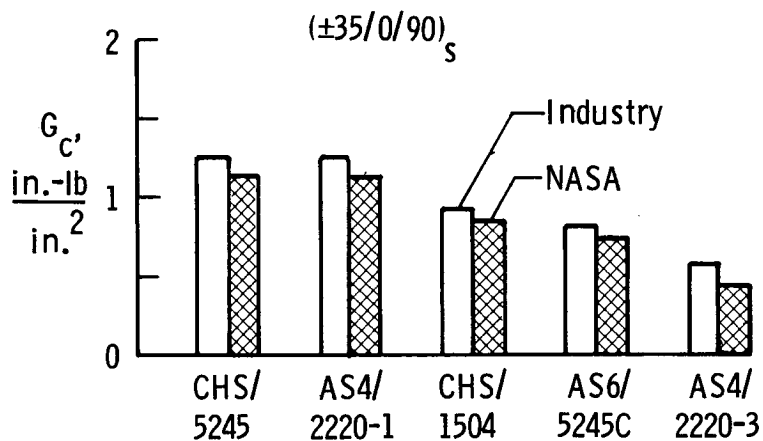

Figure 6

COMPARISON OF G_I COMPONENT OF G_C FOR TWO EDT LAYUPS

Figure 7 shows a comparison of the mode one component of G_C measured using the two Edge Delamination Test (EDT) layups for the five materials tested. With the possible exception of CHS/5245 material, which had the highest G_C values, the G_I component at delamination onset is nearly identical for both EDT layups. These results imply that delamination is governed in these materials by the critical value of G_{IC} and is nearly independent of the G_{II} shear component.

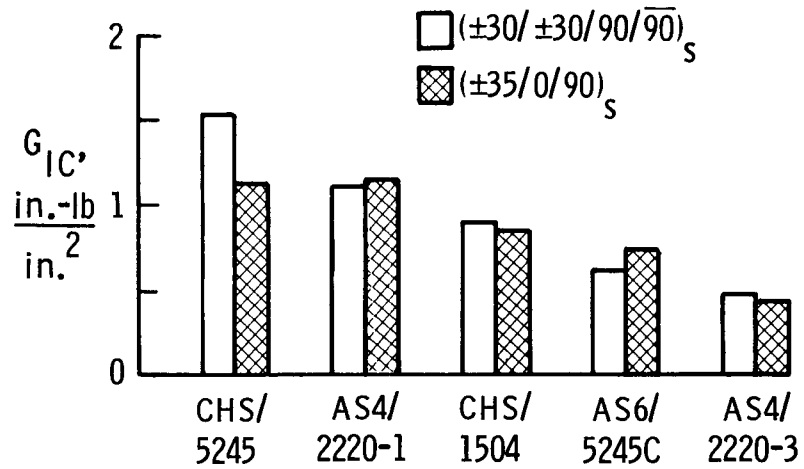

Figure 7

COMPARISON OF DCB AND EDT G_{IC} MEASUREMENT

Figure 8 shows a comparison of G_{IC} for five different materials systems as measured by a double cantilever beam (DCB) test, along with the average of the mode I components of G_c measured by the two EDT layups.

The G_{IC} values agree fairly well for the brittle T300/5208 material and the tougher CHS/5245 material. However, DCB values are consistently higher than EDT values for the intermediate toughness materials. The higher DCB values may result from fiber bridging that occurs when the delamination grows between similar zero degree plies. This mechanism may result in greater delamination resistance as the delamination grows. Such a change may be characterized by plotting G_{IC} as a function of delamination length. These "R-curve" plots, as shown in the figure, have been generated by several authors (refs. 11-12) to demonstrate that G_{IC} values taken at large delamination lengths, or average values over the entire length, may be higher than delamination onset values. Because the onset values are lowest and more realistically represent matrix behavior in multiplied laminates, they should be used for comparing materials. The edge delamination test data are reduced based on the initiation of delamination.

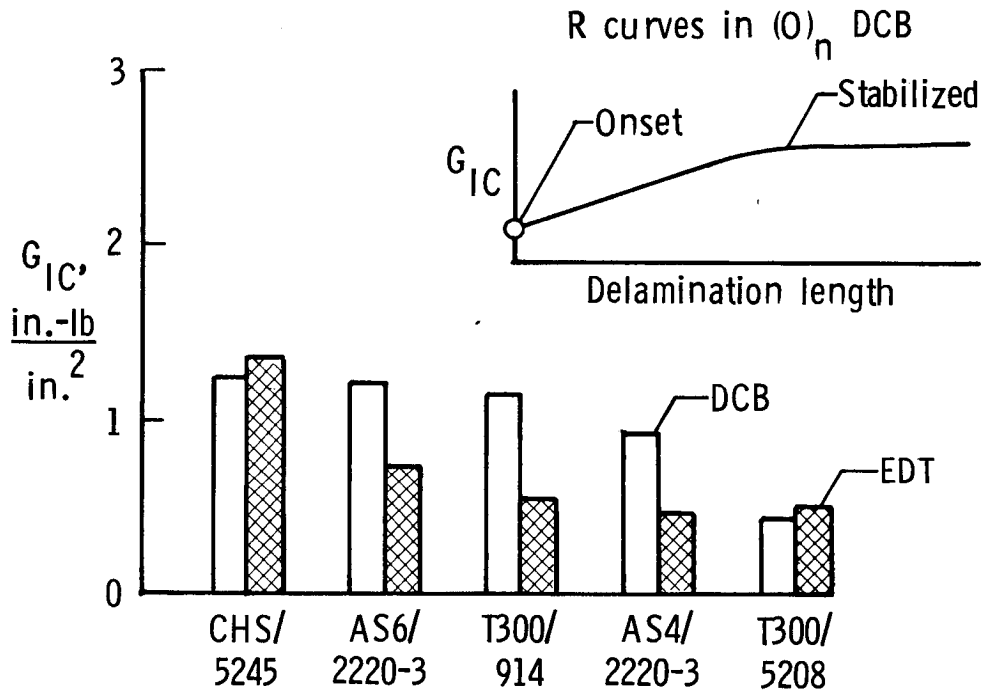

Figure 8

INTERLAMINAR FRACTURE TOUGHNESS OF TOUGHENED MATRIX COMPOSITES

Figure 9 compares G_{IC} values for several materials including (1) brittle epoxies: T300/5208 and AS4/3502, (2) five materials analyzed in the ACEE key technologies programs, (3) three "model" tough composites: T300/BP907, CHS H205, and CHS F185, and (4) a semi-crystalline thermoplastic Courtaulds/PEEK. Except for Courtaulds/PEEK, all the data represent the average G_I component of G_C measured for the two EDT layups. The Courtaulds/PEEK data were measured with a double cantilever beam (DCB) test as reported in reference 5. Figure 9 indicates that all five of the key technologies contract materials have low G_{IC} values and, at best, they represent only minor improvements over the baseline brittle epoxy composites.

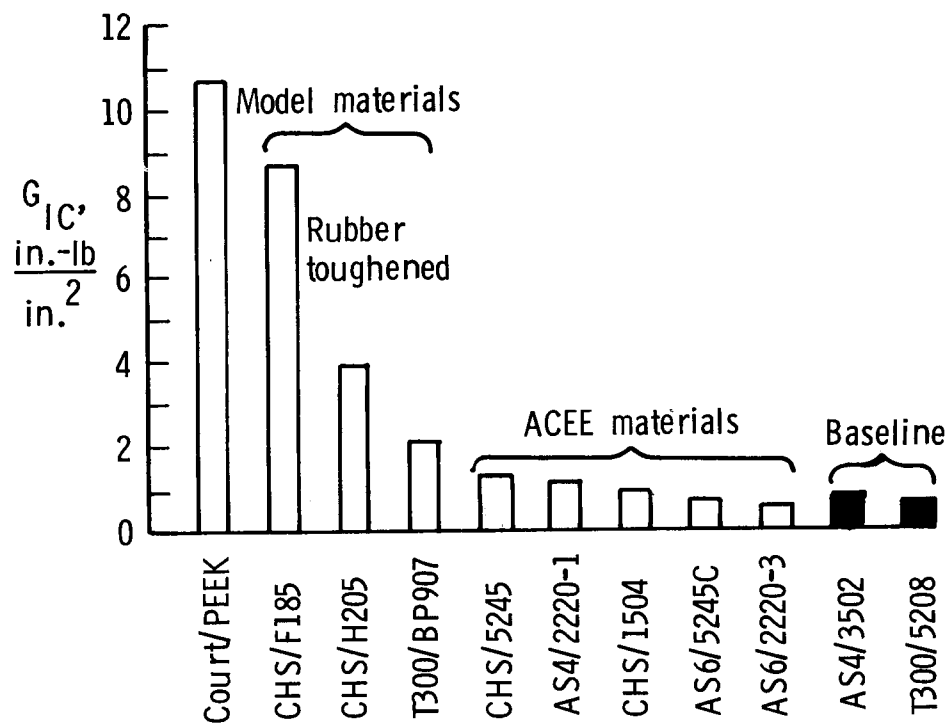

Figure 9

OPEN HOLE TENSION FAILURE STRESS (ST-3)

Tension failure stresses of specimens having a 0.25-inch diameter hole are shown in figure 10. The tests were performed according to standard test method ST-3 described in reference 1. Laminate failure stress is shown as a function of the representative ultimate tensile strain of the graphite fiber used in each material. Although failure stress generally increases with higher fiber ultimate strain, there is as much as twenty percent variation in the failure stresses of different materials systems containing the same fiber, depending on which resin system is used. Material containing the 5245C resin matrix system exhibited the highest strength with both intermediate and high strain fibers.

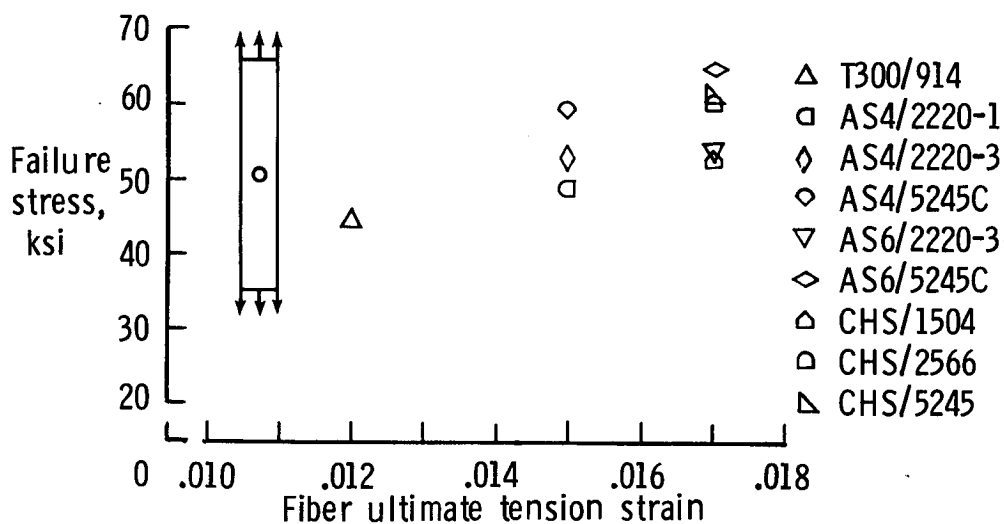

Figure 10

OPEN-HOLE COMPRESSION FAILURE STRAIN (ST-4)

A comparison of failure strain data for specimens containing a 1-inch diameter hole tested according to the standard test method ST-4 is presented in figure 11. Most of the materials have a failure strain of 0.005 to 0.006 with little improvement relative to the baseline materials. One exception is AS4/5245C, which has a failure strain of 0.007. The failure mode for 00-dominated laminates with local discontinuities loaded in compression is dominated by the stability of the fiber (ref. 13) which depends heavily on the shear modulus of the matrix and on the bending stiffness of the fiber. Examination of data for specimens with the same matrix but different fibers shows the failure strain for laminates with higher strain T700 and AS6 fibers to be lower than corresponding data for T300 and AS4 fibers. Celion High Strain fibers, however, have a higher failure strain than laminates with regular Celion fibers. The explanation for this difference may relate to the fiber diameter which is smaller for T700 and AS6 than T300 and AS4 but approximately the same for Celion and Celion High Strain fibers. Comparison of data generated by Industry and NASA shows good agreement with the exception of data for materials AS4/2220-1 and CHS/1504 in which a variation on the standard test method was used to generate the industry data.

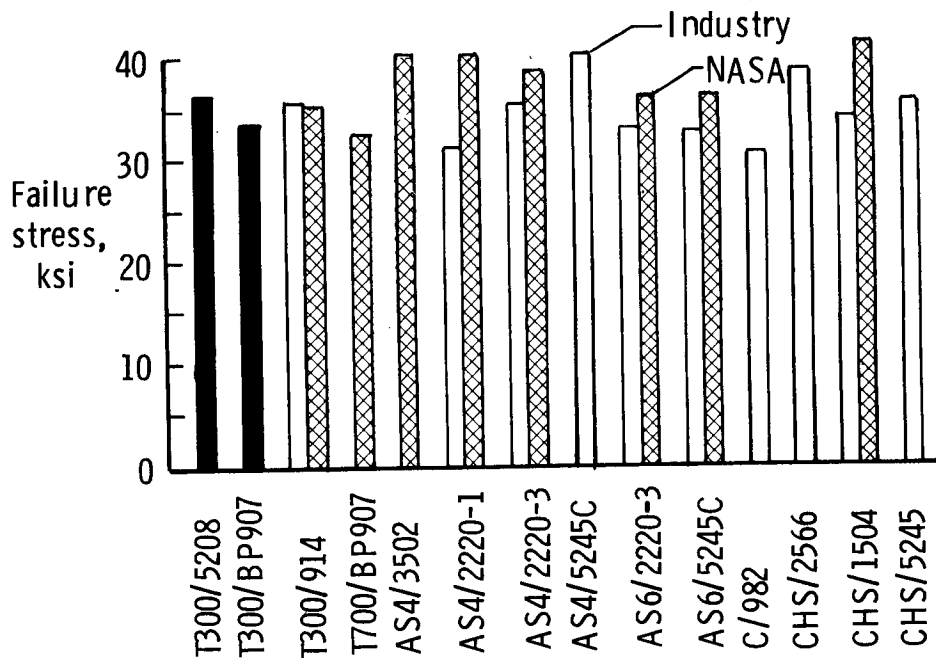

Figure 11

OPEN-HOLE COMPRESSION FAILURE STRESS (ST-4)

Data for the failure stress for the same open-hole compression specimens for which failure strain data were presented in figure 11 are presented in figure 12. Most of the materials systems have a failure stress between 35 and 40 ksi.

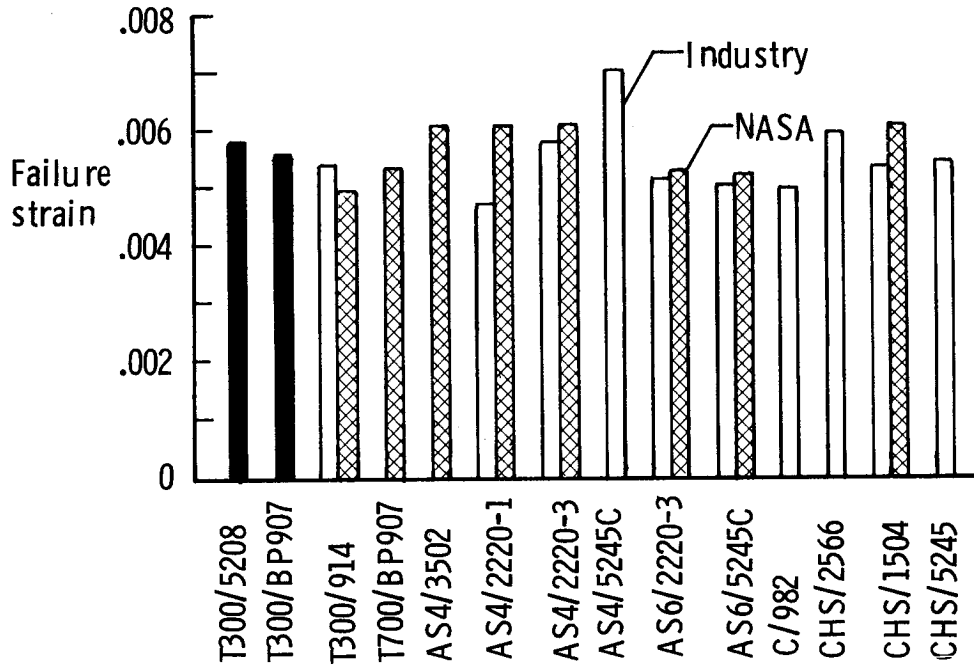

Figure 12

IMPACT DAMAGE TEST METHODS

The ST-1 test method for damaging a laminate is specified in reference 1 to be conducted in the following manner. The impactor shall weigh 10 pounds, be less than 10 in. in length, and have a 0.5-in. diameter hemispherical steel tip which strikes the specimen normal to its plane. The 7-in. by 12.5-in. specimen is mounted in an impact test fixture in which a picture frame with a 5-in. by 5-in. window is clamped over the specimen. The 10 pound weight is dropped from a height of 2 feet to provide the 20 ft-lb test condition. The specimen is then trimmed to a 5-in. by 10-in. size and placed in a compression fixture which imposes approximately fixed end boundary conditions on the loaded ends and simple support conditions on the lateral edges. With minor variations, this method is the test technique used by industry to damage specimens.

The technique used to impose impact damage on specimens tested by NASA involves propelling a small mass (0.5-in. diameter aluminum sphere) at approximately 443 ft/sec to achieve the 20 ft-lb impact condition. This damage test was conducted in the same fixture used to conduct the residual strength test. In both test methods, the specimen was removed from the fixture following the impact test to measure the damage size using ultrasonic equipment. The two test methods imposed identical impact energies; however, results presented in the following figures will show that the two tests are not necessarily equivalent. Photographs of the two test set-ups are presented in figure 13.

Industry



20 ft-lb impact

- 1/2-inch hemispherical steel tip
- 10 pound
- 11 ft/sec

NASA

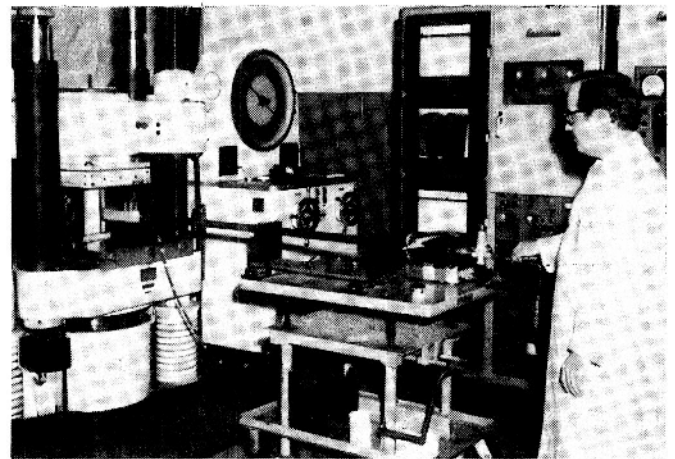

- 1/2-inch aluminum ball
- 0.0065-pound
- 443 ft/sec

Figure 13

IMPACT DAMAGE SIZE

In addition to the 20 ft-lb standard test impact condition, data were obtained for a range of impact energies. The damage size plotted as a function of impact energy is presented in figure 14 for the standard, approximately 0.25-in thick, quasi-isotropic laminate. The damage area was determined using ultrasonic C-scan equipment. The data indicate the damage size depends on the properties of both the resin and fiber with some materials showing considerably less damage for a specific impact energy than others. Industry data are indicated by solid lines and NASA data by dashed lines. For materials systems tested by both industry and NASA, results show considerably greater damage for the NASA low-mass/high-velocity impact test than for the industry dropped-weight test method. For the materials systems studied using the NASA test technique, none of the toughened epoxy systems has resistance to impact damage as high as the laminate with the baseline BP907 resin. The data for the Courtaulds/PEEK material taken from reference 5 is for a 0.2-inch thick 0-degree dominated orthotropic laminate. The Courtaulds/PEEK material shows large damage for energies up to 20 ft-lb; however, the slope of the curve is reduced for higher energies.

C-SCAN MEASURED DAMAGE AREA FOLLOWING IMPACT

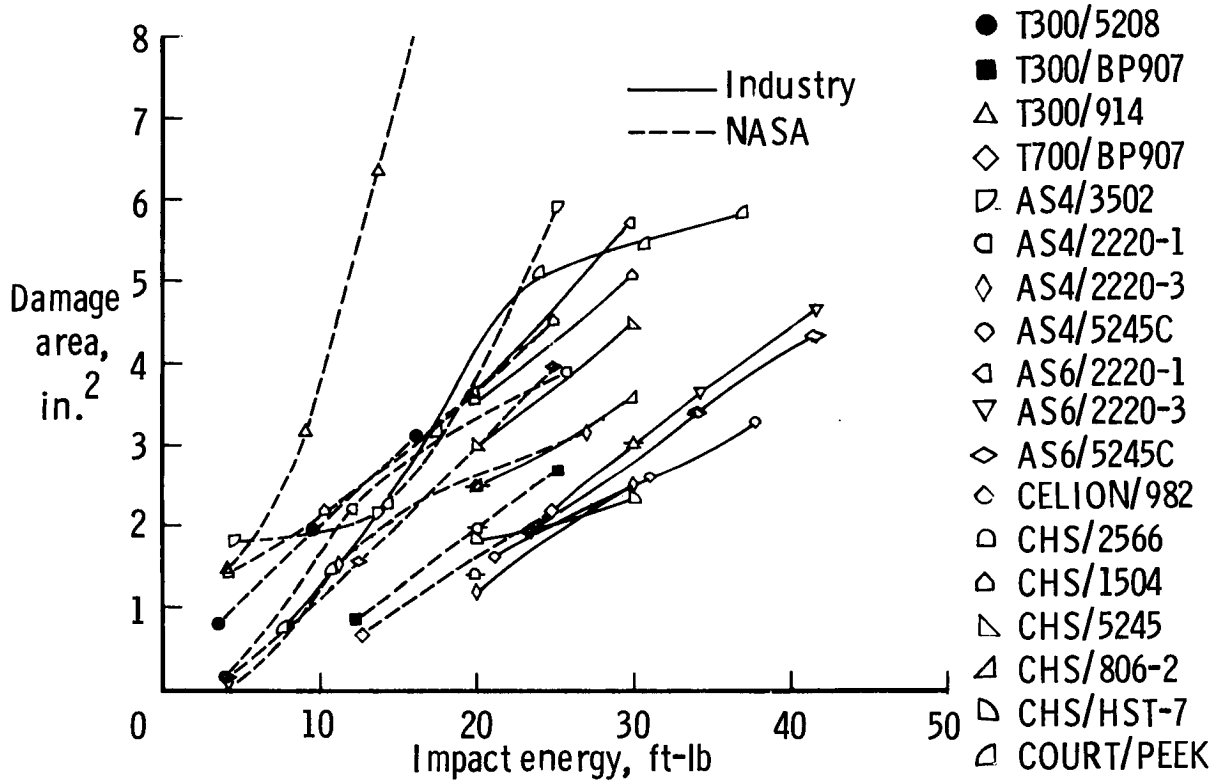

Figure 14

COMPRESSION AFTER IMPACT FAILURE STRAIN (ST-1)

The failure strain for specimens loaded in compression following impact damage at selected impact energies is presented in figure 15. Industry data are represented by solid lines and NASA data by dashed lines. In general, the NASA low-mass/high-velocity impact condition caused a greater reduction in failure strain than did the industry dropped-weight test. None of the materials tested by NASA has a higher failure strain at 25 ft-lb impact energy than the baseline T300/5208 material and all are substantially lower than the baseline T300/BP907 material. Laminates constructed using BP907 resin and the higher strain T700 fiber recorded a higher failure strain than did BP907 laminates with T300 fiber. For the materials tested by industry, Courtaids/PEEK and CHS/HST-7 had the highest failure strains.

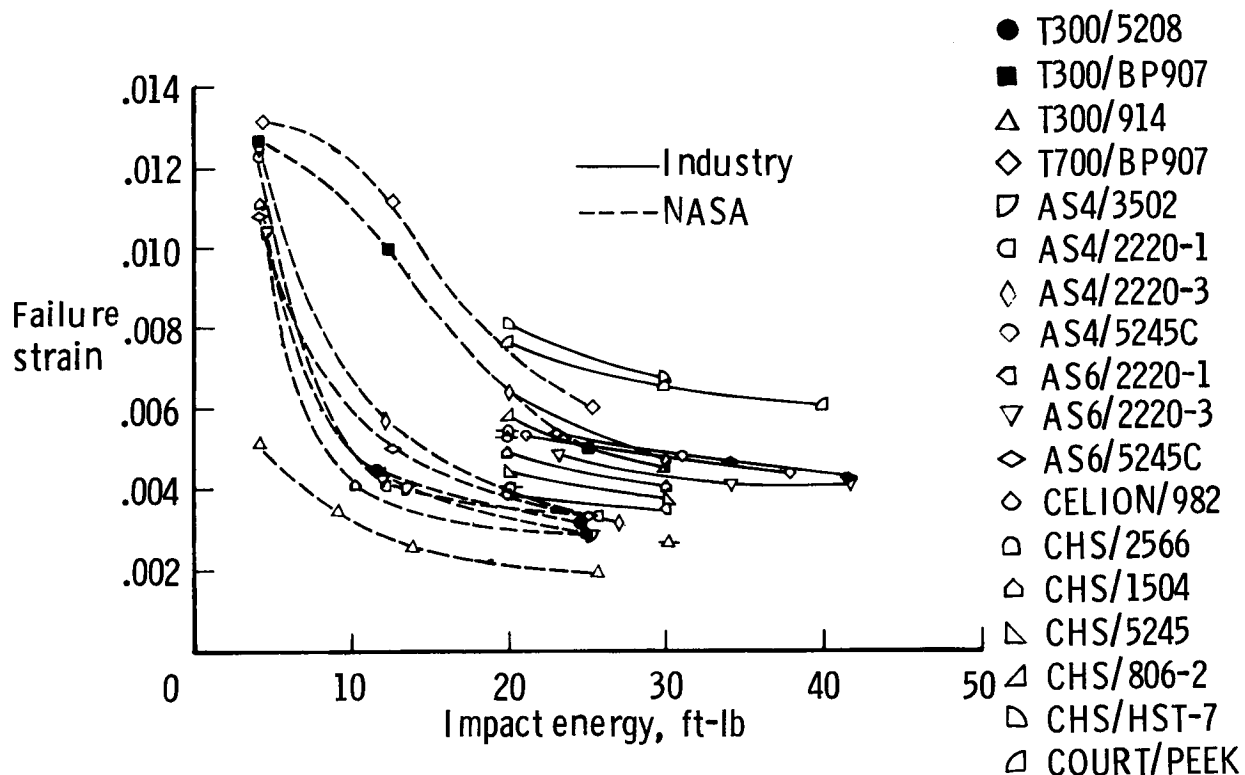

Figure 15

COMPRESSION AFTER IMPACT FAILURE STRESS (ST-1)

The stress at failure following impact damage for most of the data presented in figure 15 is presented in figure 16. Failure stress is a useful parameter for making materials comparisons for quasi-isotropic laminates because it predicts the relative load carrying capability and introduces the effect of variations in resin content and thickness. High resin content, for example, is the reason CHS/HST-7 shows less advantage on the basis of stress than strain. The T300/914 specimens were constructed using prepreg material with approximately twice the thickness of the other materials systems. The effect that ply thickness has on the compression strength of damaged laminates is not established. On the basis of failure stress, some improvement in performance can be credited to higher strain fibers. As was the case for the failure strain comparison, the NASA low-mass/high-velocity impact caused greater reductions in the failure stress than did the industry dropped-weight test.

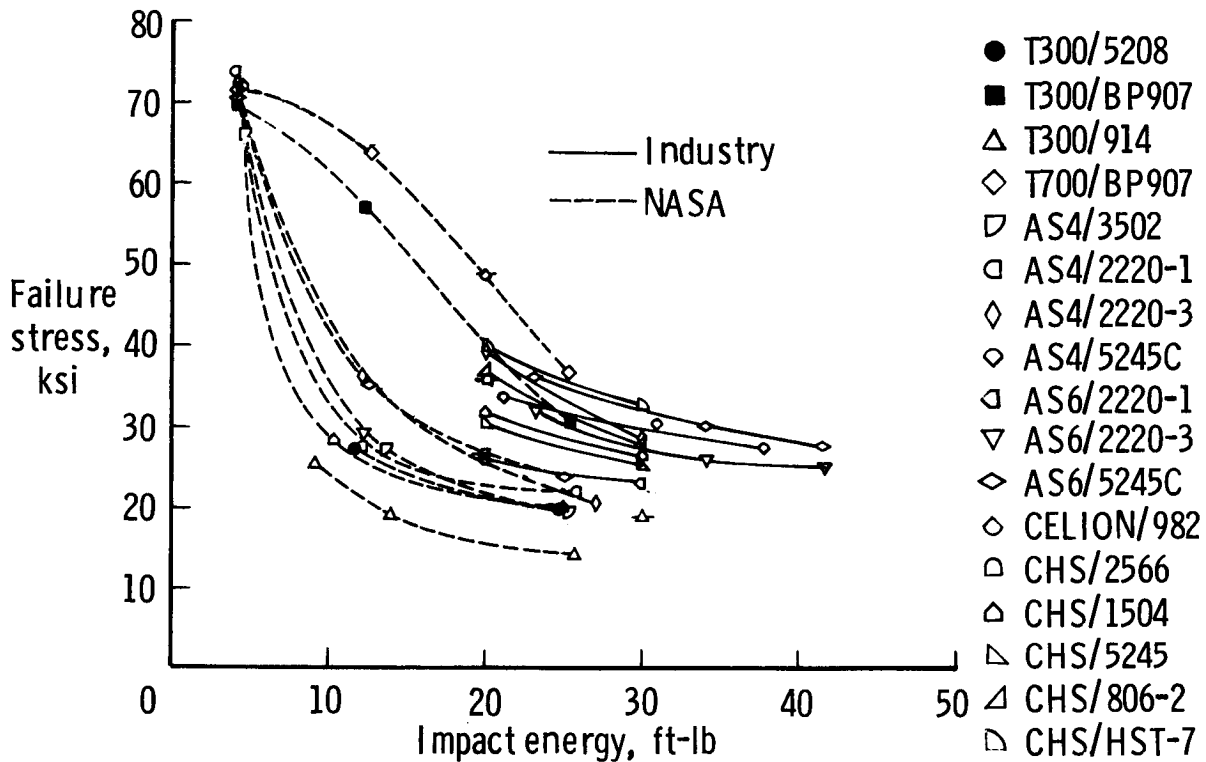

Figure 16

STRUCTURAL RESPONSE DURING IMPACT

The deformation response of the laminate during and following impact is illustrated in figure 17. Impact by the low mass 0.5-in.-diameter aluminum sphere at velocities from 300 to 500 ft/sec creates a compression stress wave which causes the material directly under the projectile to translate laterally in a time frame much less than that required for the overall response of the plate structure. This highly localized deformation gradient causes large transverse shear and normal stresses which can cause failure within the laminate. The compression wave reflects from the back surface as a tension wave and may cause further damage propagation. The local transient bending deflections of a 0.25-in.-thick laminate following a 300 ft/sec impact has been measured to have a maximum out-of-plane deflection of approximately .04 in. and affect a region approximately 1.5 in. in diameter (ref. 14). Impact by a high mass at low velocity with the same energy causes a smaller transient deformation gradient response. It is this difference which is believed responsible for the larger damage size and greater reduction in strength for the NASA low-mass/high-velocity impact test condition compared to that for the industry dropped-weight test.

IMPACT DEFORMATION RESPONSE MECHANISMS

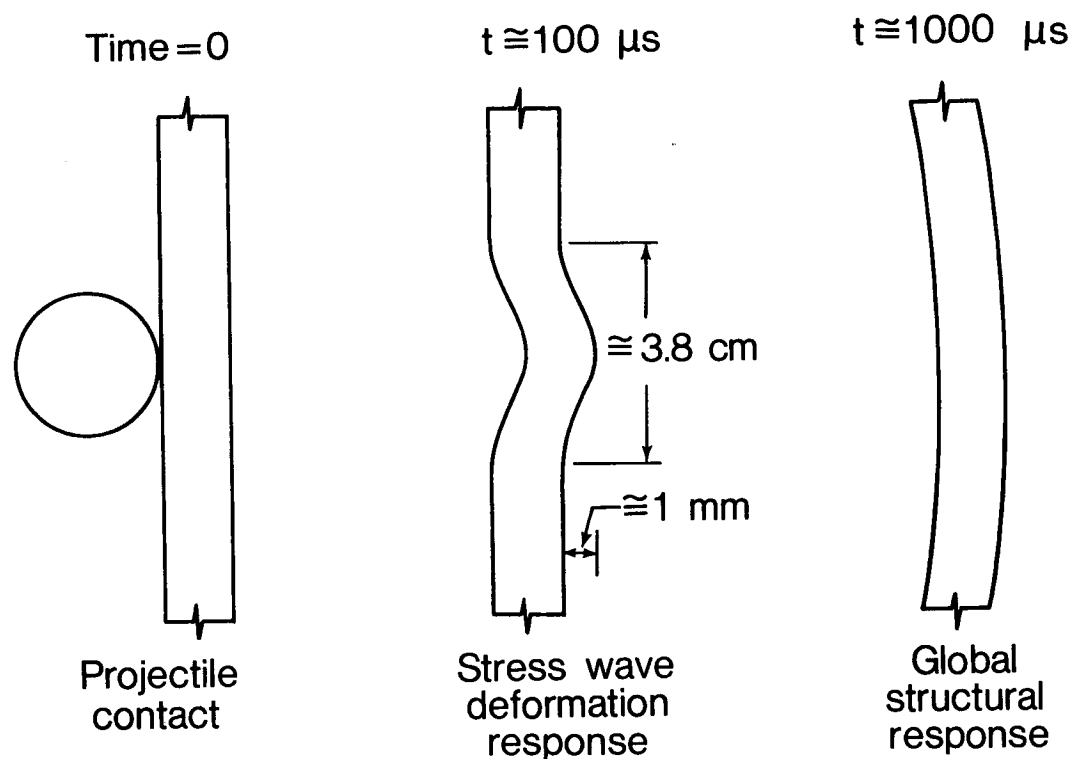

Figure 17

COMPARISON OF IMPACT DAMAGE TEST TECHNIQUES

The impact damage threat to aircraft structure includes dropped tools, runway debris and hailstones. A 2-in.-diameter hailstone, for example, would strike the upper (compression) surface of a stationary aircraft wing with a terminal velocity of approximately 176 ft/sec and 30 ft-lb of energy. The standard damage tolerance tests are not intended to generate aircraft design allowables, but were developed to assess the relative damage tolerance merit of new material systems and to provide indications of the bounds on the effect damage may have on structural performance. The data presented in preceding figures for the damage size and for the residual compression strength following impact indicate that the low-mass/high-velocity impact test is more severe than the dropped-weight test. In the context of establishing a lower bound, the low-mass/high-velocity test method would seem preferred to the low-velocity/dropped-mass technique (figure 18). The low-mass/high-velocity test may have the further advantage of being less influenced by the edge support boundary condition since much of the damage is believed to occur due to local deformation gradients in a time frame which precedes the overall structural response of the plate.

IMPACT-DAMAGE TEST TECHNIQUES

Industry

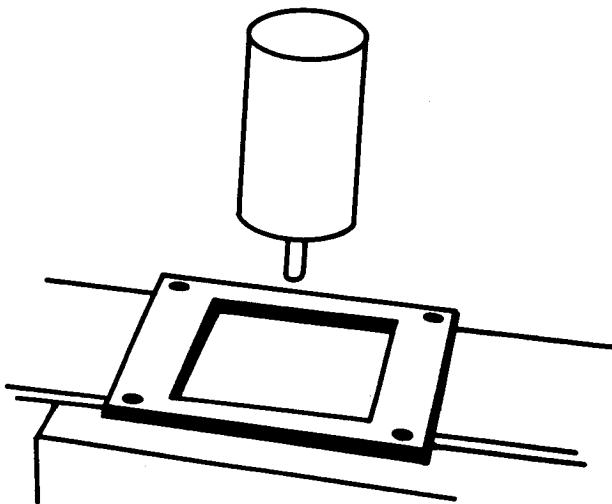

- 1/2-inch hemispherical steel tip
- 10 pound
- 11 ft/sec
- Plate-structural response
- Boundary interaction

NASA

20 ft-lb Impact

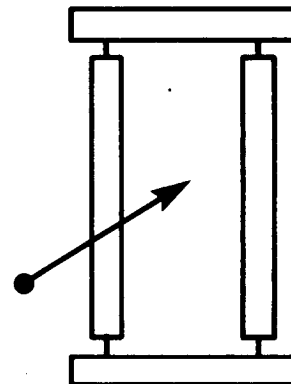

- 1/2-inch aluminum ball
- 0.0065 pound
- 443 ft/sec
- Local stress-wave deformation response
- Boundary effect limited

Figure 18

COMPRESSION AFTER IMPACT FAILURE STRAIN VERSUS INTERLAMINAR FRACTURE TOUGHNESS

Figure 19 shows a plot of compression failure strain for laminates subjected to impacts of 1000 in.-lb/in. versus the mode I interlaminar fracture toughness G_{Ic} . The solid symbols represent tests using the low-mass/high-velocity aluminum projectile as the impactor, whereas the open symbols represent tests using the high-mass/low-velocity dropped weight. Most of the baseline and ACEE materials have G_{Ic} values less than 1 in.-lb/in.² Data for T300/BP907 and Courtaulds/PEEK (ref. 5) suggest that if G_{Ic} is increased, a corresponding increase in compression failure strain after impact will be observed. More data are needed to further substantiate this observation and to define better the correlation curve suggested in figure 19.

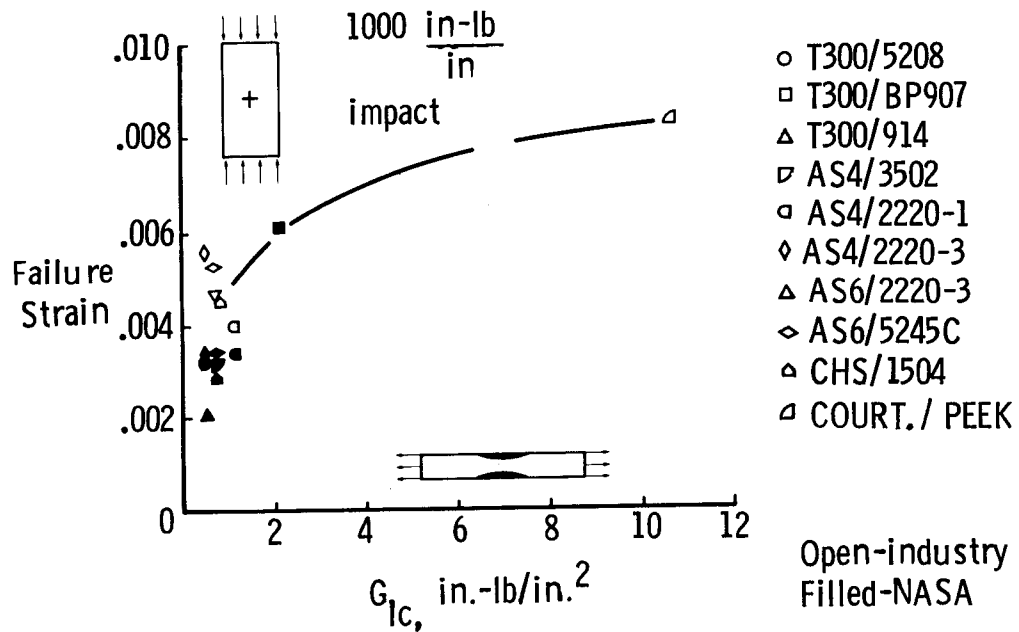

Figure 19

CONCLUDING REMARKS

Numerous candidate "tough" composite materials are available from the resin and fiber suppliers for evaluation as candidate materials for improved tolerance to impact damage and higher residual strength (see fig. 20). This proliferation of new materials makes difficult and expensive the determination of characteristic material properties and emphasizes the need for standardized test methods and the generation of a transportable data base. The development of NASA/Industry Standard Test Methods (ref. 1) for evaluating damage tolerance is an initial attempt to serve this need.

The edge delamination and double cantilever beam interlaminar fracture toughness test methods provide results which are in reasonable agreement for the relatively brittle systems evaluated. If a simple ranking of a material's relative toughness is all that is needed, than perhaps one of the test methods could be dropped from the Standard Tests set. Open-hole compression tests conducted by industry and NASA are in close agreement. Results for impact damage size and compression strength following impact appear to be affected by the velocity of the projectile at impact with the low-mass/high-velocity test method causing the most reduction in strength. The low-mass/high-velocity test method may have the further advantage of yielding results which are almost independent of the support boundary conditions.

The higher strength provided by high strain fibers seems to translate directly into improved laminate tension performance. For compression, however, where failure is usually controlled by the stability of the fiber, a smaller fiber diameter seems to offset the potential improvement available from a higher failure strain.

In summary, the most serious damage tolerance technology deficiency is still associated with the compression strength following impact. Most new materials systems have provided only marginal improvement in this property. The problem is complex and the fundamental mechanics of the problem are only now beginning to be understood. It would appear that the resin should exhibit high initial shear modulus and have a nonlinear stress-strain behavior initiating at high strains near ultimate. In addition, it should have a high interlaminar fracture toughness to resist delamination propagation. The highest potential for improved performance currently seems to favor the semi-crystalline thermoplastic resin systems such as PEEK.

- o NUMEROUS NEW FIBER AND RESIN MATERIALS AVAILABLE FROM INDUSTRY
- o STANDARD TEST METHODS AND COMMON DATA BASE DESIRABLE
- o INTERLAMINAR FRACTURE TOUGHNESS AND OPEN-HOLE COMPRESSION TEST RESULTS REPEATABLE
- o LOW-MASS/HIGH-VELOCITY IMPACT TEST PROVIDES LOWER BOUND TO STRENGTH REDUCTION AND MAY BE LESS SENSITIVE TO BOUNDARY CONDITIONS
- o HIGH STRAIN FIBER TRANSLATES INTO IMPROVED LAMINATE TENSION PERFORMANCE
- o MATERIALS TESTED UNDER ACEE CONTRACTS HAVE LOW INTERLAMINAR FRACTURE TOUGHNESS AND EXHIBIT LIMITED IMPROVEMENT IN COMPRESSION STRENGTH FOLLOWING IMPACT

Figure 20

1. Standard Tests for Toughening Resin Composites. NASA RP-1092, July 1983.
2. Rhodes, Marvin D.; Williams, Jerry G.; and Starnes, James H., Jr.: Low Velocity Impact Damage in Graphite-Fiber Reinforced Epoxy Laminates. Proceedings of 34th Annual Conference Reinforced Plastic/Composite Institute, The Society of the Plastics Industry, Inc., Jan. 29-Feb. 2, 1979.
3. Starnes, James H., Jr.; and Williams, Jerry G.: Failure Characteristics of Graphite-Epoxy Structural Components Loaded in Compression. Mechanics of Composite Materials - Recent Advances. Hashin and Herakovich, Editors, Pergamon Press, 1983.
4. Williams, Jerry G.; and Rhodes, Marvin D.: Effect of Resin on the Impact-Damage Tolerance of Graphite-Epoxy Laminates. ASTM STP 787, pp. 450-480, 1983.
5. Carlile, D. R.; and Leach, D. C.: Damage and Notch Sensitivity of Graphite/PEEK Composite. Proceedings of the 15th National SAMPE Technical Conference, October 1983, pp. 82-93.
6. O'Brien, T. K.: Characterization of Delamination Onset and Growth in a Composite Laminate. Damage in Composite Materials, ASTM STP 775, June 1982, p. 140.
7. O'Brien, T. K.; Johnston, N. J.; Morris, D. H., and Simonds, R. A.: A Simple Test for the Interlaminar Fracture Toughness of Composites. SAMPE Journal, Vol. 18, No. 4, July/August 1982, p. 8.
8. Johnston, N. J.; O'Brien, T. K.; Morris, D. H.; and Simonds, R. A.: Interlaminar Fracture Toughness of Composites II - Refinement of the Edge Delamination Test and Application of Thermoplastics. Proceedings of the 28th National SAMPE Symposium and Exhibition, Anaheim, California, April 1983, p. 502.
9. O'Brien, T. K.: Mixed-Mode Strain-Energy-Release-Rate Effects on Edge Delamination of Composites in the Effect of Defects in Composite Materials. ASTM STP 836, 1984. Also NASA TM-84592, January 1983.
10. O'Brien, T. K.; Johnston, N. J.; Morris, D. H.; and Simonds, R. A.: Determination of Interlaminar Fracture Toughness and Fracture Mode Dependence of Composites Using the Edge Delamination Test. Proceedings of the International Conference on Testing, Evaluation, and Quality Control of Composites, University of Surrey, Guildford, England, September 1983, pp. 223-232.
11. Russell, A. J.: Factors Affecting the Interlaminar Fracture Energy of Graphite/Epoxy Laminates. Progress in Science and Engineering of Composites, Proceedings of ICCM - IV, Tokyo, 1982, pp. 279-286.
12. deCharentenay, F. X., et. al.: Characterizing the Effect of Delamination Defect by Mode I Delamination Test. ASTM STP 836, Effect of Defects in Composites, 1984.

3. Hahn, H. Thomas; and Williams, Jerry G.: Compression Failure Mechanisms in Unidirectional Composites. NASA TM-85834, July 1984.
4. Williams, Jerry G.; Anderson, Melvin S.; Rhodes, Marvin D.; Starnes, James H., Jr.; and Stroud, W. Jefferson: Recent Developments in the Design, Testing, and Impact-Damage Tolerance of Stiffened Composite Panels. Proceedings of Fourth Conference on Fibrous Composites in Structural Design, San Diego, California, November 14-17, 1978.