

University of Groningen

Competition for light between phytoplankton species

Huisman, Jef; Jonker, R.R.; Zonneveld, C.; Weissing, F.J.

Published in:
 Ecology

DOI:
[10.1890/0012-9658\(1999\)080\[0211:CFLBPS\]2.0.CO;2](https://doi.org/10.1890/0012-9658(1999)080[0211:CFLBPS]2.0.CO;2)

IMPORTANT NOTE: You are advised to consult the publisher's version (publisher's PDF) if you wish to cite from it. Please check the document version below.

Document Version
 Publisher's PDF, also known as Version of record

Publication date:
 1999

[Link to publication in University of Groningen/UMCG research database](#)

Citation for published version (APA):

Huisman, J., Jonker, R. R., Zonneveld, C., & Weissing, F. J. (1999). Competition for light between phytoplankton species: Experimental tests of mechanistic theory. *Ecology*, *80*(1), 211 - 222.
[https://doi.org/10.1890/0012-9658\(1999\)080\[0211:CFLBPS\]2.0.CO;2](https://doi.org/10.1890/0012-9658(1999)080[0211:CFLBPS]2.0.CO;2)

Copyright

Other than for strictly personal use, it is not permitted to download or to forward/distribute the text or part of it without the consent of the author(s) and/or copyright holder(s), unless the work is under an open content license (like Creative Commons).

The publication may also be distributed here under the terms of Article 25fa of the Dutch Copyright Act, indicated by the "Taverne" license. More information can be found on the University of Groningen website: <https://www.rug.nl/library/open-access/self-archiving-pure/taverne-amendment>.

Take-down policy

If you believe that this document breaches copyright please contact us providing details, and we will remove access to the work immediately and investigate your claim.

Downloaded from the University of Groningen/UMCG research database (Pure): <http://www.rug.nl/research/portal>. For technical reasons the number of authors shown on this cover page is limited to 10 maximum.

COMPETITION FOR LIGHT BETWEEN PHYTOPLANKTON SPECIES: EXPERIMENTAL TESTS OF MECHANISTIC THEORY

JEF HUISMAN,^{1,2,5} RICHARD R. JONKER,³ COR ZONNEVELD,⁴ AND FRANZ J. WEISSING²

¹Laboratory for Microbiology, University of Amsterdam, Nieuwe Achtergracht 127,
1018 WS Amsterdam, The Netherlands; and

Department of Plant Biology, University of Groningen, P.O. Box 14, 9750 AA Haren, The Netherlands

²Department of Genetics, University of Groningen, P.O. Box 14, 9750 AA Haren, The Netherlands

³AquaSense, P.O. Box 95125, 1090 HC Amsterdam, The Netherlands

⁴Department of Theoretical Biology, Free University, De Boelelaan 1087, 1081 HV Amsterdam, The Netherlands

Abstract. According to recent competition theory, the population dynamics of phytoplankton species in monoculture can be used to make a priori predictions of the dynamics and outcome of competition for light. The species with lowest “critical light intensity” should be the superior light competitor. To test this theory, we ran monoculture experiments and competition experiments with two green algae (*Chlorella vulgaris* and *Scenedesmus protuberans*) and two cyanobacteria (*Aphanizomenon flos-aquae* and a *Microcystis* strain) in light-limited continuous cultures. We used the monoculture experiments to estimate the critical light intensities of the species. *Scenedesmus* had by far the highest critical light intensity. The critical light intensities of *Chlorella*, *Aphanizomenon*, and *Microcystis* were rather similar. According to observation, *Aphanizomenon* had a slightly lower critical light intensity than *Chlorella* and *Microcystis*. However, according to a model fit to the monoculture experiments, *Chlorella* had a slightly lower critical light intensity than *Microcystis*, which in turn had a slightly lower critical light intensity than *Aphanizomenon*. These subtle differences between observed and fitted critical light intensities could be attributed to differences in the light absorption spectra of the species. The competition experiments were all consistent with the competitive ordering of the species according to the fitted critical light intensities: *Chlorella* displaced all three other species, *Microcystis* displaced both *Aphanizomenon* and *Scenedesmus*, and *Aphanizomenon* only displaced *Scenedesmus*. Not only the final outcomes, but also the time courses of competition predicted by the theory, were in excellent agreement with the experimental results for nearly all species combinations.

Key words: chemostat; competition model; critical light intensity; cyanobacteria; green algae; light limitation; photosynthesis; phytoplankton; population dynamics; resource competition.

INTRODUCTION

Light is the sole energy source for nearly all plant species, ranging from the tiny phytoplankton to giant sequoia trees. As a consequence, the availability of light has a major impact on the dynamics and structure of most aquatic and terrestrial communities. Light differs from all other resources because it cannot be mixed. Instead, the unidirectional nature of light gives rise to a vertical gradient of light intensity as a function of depth. Since phototrophic organisms absorb light to make a living, this vertical gradient is not static but dynamic. The light gradient is at least partly created by the phototrophic organisms themselves; hence changes in species composition are usually accompanied by changes in the vertical shading pattern. Accordingly, a dynamic description of the light gradient

is a prerequisite for the understanding of competition for light.

While the fundamental importance of light is generally acknowledged, resource competition theory has thus far centered around competition for nutrients (Tilman 1977, Hansen and Hubbell 1980, Tilman and Sterner 1984, van Donk and Kilham 1990, Grover 1991, Sommer 1993, Rothhaupt 1996, Ducobu et al. 1998). Light has received far less attention as a selective factor, probably because the presence of a changing vertical light gradient makes light competition conceptually and experimentally more complex than nutrient competition.

Recently, we accepted the challenge to find a fuller understanding of light competition. We developed an analytically tractable model to analyze the effects of a dynamic light gradient on phytoplankton competition and community structure (Huisman and Weissing 1994, 1995, Weissing and Huisman 1994). The model considers a well-mixed water column that is illuminated from above with light of intensity I_{in} . The incident light is partly absorbed by phytoplankton species and partly

Manuscript received 27 August 1997; revised 10 February 1998; accepted 11 March 1998.

⁵ Address correspondence to this author at the first address listed above.

E-mail: jef.huisman@chem.uva.nl

by nonphytoplankton components. Light that has not been absorbed penetrates to the bottom of the water column with intensity I_{out} . The light intensity I_{out} is variable in time: when the phytoplankton species increase in abundance, they absorb more light, and hence less light penetrates to the bottom of the water column. The model predicts that each species has its own critical light intensity. If the light intensity at the bottom of the water column (I_{out}) is above its critical light intensity, the population of the species will increase; if I_{out} is below its critical light intensity, the population of the species will decrease. As a consequence, the outcome of phytoplankton competition for light can be predicted from the critical light intensities of the competing species. For instance, suppose that various species compete for light and that their critical light intensities, indicated by $I_{\text{out},i}^*$, are ordered as

$$I_{\text{out},1}^* < I_{\text{out},2}^* < I_{\text{out},3}^* < \dots < I_{\text{out},n}^* \quad (1)$$

In this case, the model predicts that, independent of the initial conditions, species 1 should competitively displace all other species (Huisman and Weissing 1994, Weissing and Huisman 1994). Species 1 is predicted to exclude all others because it has the lowest critical light intensity and is thus able to reduce I_{out} below the critical light intensities of all other species. Similarly, species 2 should be able to displace all species except species 1, and so on. In this sense, the concept of a critical light intensity plays a role similar to the concept of a critical nutrient level (often termed R^* ; Armstrong and McGehee 1980, Tilman 1982) in models of nutrient competition. Thus, the species with lowest critical light intensity should win.

The critical light intensity of a species can be measured in monoculture experiments. According to the model, a species in monoculture should continue to grow until it has reduced the light intensity that penetrates to the bottom of the water column to its own critical light intensity. Hence, the critical light intensity of a species can be measured as the light intensity at the bottom of a water column when the species has reached a monoculture steady state. In this way, the theory allows a priori predictions of the outcome of competition based on monoculture information. Several other aspects of monoculture growth are further investigated in Huisman (1999).

The present paper reports on tests of the competition theory. We performed monoculture experiments and competition experiments with two green algae and two cyanobacteria. The monoculture experiments were used to determine the critical light intensities and other model parameters of the species. Next, the time courses and final outcomes of competition were predicted on the basis of these monoculture measurements. These a priori predictions were then compared to the actual time courses and final outcomes of the various competition experiments.

THEORY

Consider a well-mixed water column with a number of phytoplankton species. Because the water column is well mixed, we assume that the population densities (in numbers per unit volume) of the various species are uniformly distributed over depth. Let ω_i denote the population density of a phytoplankton species i . The growth rate of species i depends on the balance between its production and loss rates:

$$\frac{d\omega_i}{dt} = \frac{1}{z} \int_0^z p_i[I(s)]\omega_i ds - D\omega_i \quad (2)$$

where $p_i(I)$ is the specific production rate of species i as an increasing function of light intensity, $I(s)$ is the light intensity as a decreasing function of depth s , z is the total depth of the water column, and D is the loss rate imposed by dilution.

Light penetration through the water column depends on the population densities of the phytoplankton species and on the background turbidity due to nonphytoplankton components. More precisely, according to Lambert–Beer's law the light intensity at depth s is given by

$$I(s) = I_{\text{in}} \exp\left(-\left[\sum_{j=1}^n k_j \omega_j s + K_{\text{bg}} s\right]\right) \quad (3)$$

where I_{in} is the incident light intensity, k_j is the specific light attenuation coefficient of species j , K_{bg} is the total background turbidity due to nonphytoplankton components, and n is the total number of phytoplankton species. Light that has not been absorbed penetrates to the bottom of the water column with an intensity $I(z) = I_{\text{out}}$.

In essence, this model formulation is a straightforward multi-species extension of commonly used models for phytoplankton photosynthesis (e.g., Bannister 1974, Platt et al. 1990, Kirk 1994). Eq. 2 states that the growth rates of the competing species are governed by light availability. In other words, there is no direct interference between the species. The species interact only via shading (in Eq. 3). Eqs. 2 and 3 can be combined to arrive at the following dynamical system (Huisman and Weissing 1994, Weissing and Huisman 1994):

$$\frac{d\omega_i}{dt} = \frac{1}{z} \frac{k_i \omega_i}{\sum_j k_j \omega_j + K_{\text{bg}}} \int_{I_{\text{out}}}^{I_{\text{in}}} \frac{p_i(I)}{k_i I} dI - D\omega_i$$

$$i = 1, \dots, n \quad (4a)$$

$$I_{\text{out}} = I_{\text{in}} \exp\left(-\left[\sum_{j=1}^n k_j \omega_j z + K_{\text{bg}} z\right]\right) \quad (4b)$$

This model predicts that each species has its own critical light intensity. This critical light intensity corresponds to that value of I_{out} at which the species remains stationary (i.e., at which $d\omega_i/dt = 0$). Accordingly, the

critical light intensity of a species can be deduced from monoculture measurements; it is the value of I_{out} at which the species remains in steady state. In a mixture of species, the model predicts that the species with lowest critical light intensity should be the superior competitor for light, because it is able to reduce I_{out} below the critical light intensities of all other species (for a formal proof, see Appendix C of Weissing and Huisman 1994).

METHODS

Species

The experiments were performed with two green algae (*Chlorella vulgaris* Beyerinck (strain UTEX 259) and *Scenedesmus protuberans* Fritsch), and two cyanobacteria (*Aphanizomenon flos-aquae* (L.) Ralfs (strain PCC7905) and a *Microcystis* strain). The cultures were not grown axenically, but regular inspection with the microscope during the experiments showed that bacterial contamination was low, usually less than 1% of the total biomass. *Chlorella vulgaris* is a small spherical alga, with a cell diameter between 2 and 3 μm . *Scenedesmus protuberans* grows in four-celled colonies, known as coenobia, of $\sim 20 \mu\text{m}$ length. *Aphanizomenon flos-aquae* grows in filaments of 8–50 cells; some of these cells specialize to heterocysts and are capable of N_2 -fixation. *Microcystis* species usually form large colonies, but the strain used here (isolated by P. M. Visser from Lake Nieuwe Meer, The Netherlands) was cultured as single cells of $\sim 2 \mu\text{m}$ diameter each. All four species are commonly found in eutrophic waters where light is a potentially limiting resource (Reynolds 1984).

Culture system

Experiments were performed in newly developed continuous culture systems, specifically designed to study the population dynamics of light-limited phytoplankton. Fig. 1 shows a schematic drawing of these systems. To avoid interference with other light sources, each culture system was placed in a separate black box. Within each box, light was provided by four white fluorescent tubes (Philips PLL 24W/84) of 29 cm length each, arranged next to each other to cover the full front of the culture vessel. A rectangular water jacket (20 \times 27 cm, with a thickness of 1.2 cm), connected to a Colora thermocryostat, was placed between the light source and the culture vessel to remove the heat of the lamps, and to maintain the temperature of the culture vessel at 20°C. Light entered at the front surface of the culture vessel, thus creating a unidirectional light gradient that was horizontal instead of vertical (i.e., photons did not traverse from top to bottom but from left to right; see Fig. 1A). The culture vessels were made of glass and laboratory built, following the design described by Matthijs et al. (1996). Each flat culture vessel had inner dimensions of 27 cm height, 18 cm

A) Side view

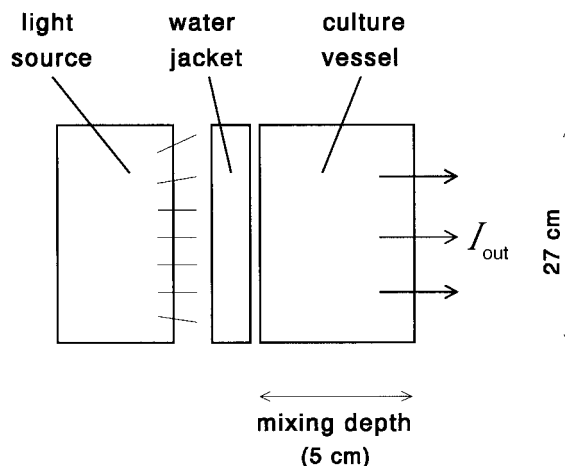

B) Front view

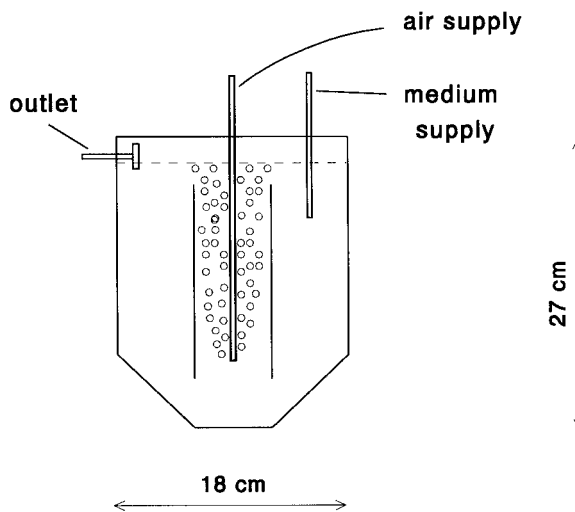

FIG. 1. Schematic diagram of the continuous culture system used in this study. (A) Side-view with light source, water jacket, and culture vessel. (B) Front view of the culture vessel.

breadth, and an optical path length ("mixing depth") of $z = 5.0 \text{ cm}$. The effective working volume of each vessel was 1600 ml. Culture vessels were heat sterilized prior to inoculation with phytoplankton. Mixing was ensured by flushing small air bubbles between two partitions within the culture vessel at a high rate of 100–150 L/h (see Fig. 1B). This caused an upward stream of water in the middle of the culture, and a corresponding downward stream at the right- and left-hand sides. This air-lift system led to well mixed, homogeneous cultures, also ensuring a sufficient supply of CO_2 . Wall growth was prevented by scraping the cultures once or twice a day (including the weekends) using a magnetic

stir bar. Mineral medium was pumped from 3-L bottles into the culture vessel by a peristaltic pump (Watson Marlow 101U/R MkII). An outlet allowed the growth medium, together with the cultured organisms, to leave the culture vessel at the same rate again. In all experiments, the pump was set at a dilution rate of $D = 0.015 \text{ h}^{-1}$.

Nutrients

The growth medium was composed of NaNO_3 (end concentration 1500 mg/L), $\text{MgSO}_4 \cdot 7\text{H}_2\text{O}$ (150 mg/L), $\text{CaCl}_2 \cdot 2\text{H}_2\text{O}$ (15 mg/L), citric acid (6 mg/L), Na_2EDTA (2 mg/L), H_3BO_3 (5.7 mg/L), $\text{MnCl}_2 \cdot 4\text{H}_2\text{O}$ (3.6 mg/L), $\text{ZnSO}_4 \cdot 7\text{H}_2\text{O}$ (0.4 mg/L), $\text{Na}_2\text{MoO}_4 \cdot 2\text{H}_2\text{O}$ (0.8 mg/L), $\text{CuSO}_4 \cdot 5\text{H}_2\text{O}$ (0.16 mg/L), and $\text{Co}(\text{NO}_3)_2 \cdot 6\text{H}_2\text{O}$ (0.1 mg/L). These salts were dissolved in double-distilled water and heat sterilized. To avoid precipitates, $\text{K}_2\text{HPO}_4 \cdot 3\text{H}_2\text{O}$ (80 mg/L), $\text{Fe}(\text{III})(\text{NH}_4)_3$ citrate (6 mg/L), and NaHCO_3 (84 mg/L) were sterilized separately and added to the growth medium after cooling to room temperature.

Light

Light intensities (PAR from 400 to 700 nm, in $\mu\text{mol photons} \cdot \text{m}^{-2} \cdot \text{s}^{-1}$) were measured with a Licor LI-190SA quantum sensor. The light intensity incident upon the front surface of the culture vessel (I_{in}) was set by neutral density filters that were placed in front of the water jacket. In all experiments, the incident light intensity was $I_{\text{in}} = 60 \mu\text{mol photons} \cdot \text{m}^{-2} \cdot \text{s}^{-1}$. Mirrors were placed against the side surfaces of the culture vessels to reduce losses of light by sideward scattering. The light intensity I_{out} was measured as the light intensity leaving the culture vessel at the back surface (with the air bubbles still running). To account for spatial variation, I_{out} was sampled at ten regularly spaced positions at the back surface. Spatial standard deviations of I_{out} were always quite low, indicating that there was not much spatial variation in light intensity on the plane perpendicular to the unidirectional light gradient. Background turbidity was calculated from measurements of I_{in} and I_{out} in the absence of phytoplankton according to $K_{\text{bg}} = \ln(I_{\text{in}}/I_{\text{out}})/z$. This yielded $K_{\text{bg}} = 0.072 \text{ cm}^{-1}$ (1 SD = 0.006 cm^{-1} , $N = 11$).

Evidence for light limitation was obtained in pilot experiments. Neither halving nor doubling of the nutrient dosage had an effect on the steady-state population densities of any of the species. This indicates that nutrients were neither limiting nor present in toxic amounts. In all experiments, the pH remained in the range 8.0–8.6, which indicates that the carbon dioxide concentration was not depleted to very low levels (whereas a strong reduction of the airflow led to a fast increase in pH, up to pH = 10.4). On the other hand, an increase of the incident light intensity yielded a proportional increase of the population densities in monocultures of all four species.

Sampling and counting

Monoculture experiments were sampled nearly every day, and the population densities were counted in triplo with a Coulter Counter (model ZM) directly after sampling. The *Aphanizomenon* filaments could not be counted in this way. Therefore, the number of *Aphanizomenon* filaments in the monoculture experiments was estimated from a linear regression of optical density of the cultures at 750 nm (OD) vs. counts of the filament numbers (F) with the EurOPA (“European Optical Plankton Analyser”) flow cytometer ($F = 5.79 \times 10^5 \times \text{OD}$, $r^2 = 0.98$, $N = 10$).

Competition experiments were sampled approximately every three days. Samples were fixed with a paraformaldehyde–glutaraldehyde solution (Tsuji and Yanagita 1981). The population densities in these species mixtures were analyzed with the EurOPA flow cytometer (Dubelaar et al. 1989, Jonker et al. 1995). The flow cytometer counted a total of 10^4 individual particles/sample and was able to discriminate between the species on the basis of their size and pigment fluorescence. When a species comprised <1% of the total number of individuals, the flow-cytometer counts became less accurate and the species was counted microscopically with a Sedgewick–Rafter counting cell.

We report population densities expressed as cells/mL in case of *Microcystis* and *Chlorella*, as coenobia/mL in case of *Scenedesmus*, and as filaments/mL in case of *Aphanizomenon*.

Quantitative analysis

The prediction that the species with lowest critical light intensity should be the superior competitor for light is only of a qualitative nature. In order to make quantitative predictions, it is necessary to choose a particular expression for the functions $p_i(I)$. Here we have assumed that the specific production rate increases with light intensity and saturates at high light intensities according to a simple Monod equation:

$$p_i(I) = \frac{p_{\text{max},i} I}{(p_{\text{max},i}/\alpha_i) + I} \quad (5)$$

where $p_{\text{max},i}$ is the maximum specific production rate of species i , and α_i is the slope of the $p_i(I)$ curve at $I = 0$. Using this Monod equation, the integral term in Eq. 4a can be solved, and the resulting competition model reads (Huisman and Weissing 1994):

$$\frac{d\omega_i}{dt} = \frac{1}{z} \frac{k_i \omega_i}{\sum_j k_j \omega_j + K_{\text{bg}}} \frac{p_{\text{max},i}}{k_i} \ln \left(\frac{p_{\text{max},i} + \alpha_i I_{\text{in}}}{p_{\text{max},i} + \alpha_i I_{\text{out}}} \right) - D \omega_i \quad (6a)$$

$$i = 1, \dots, n$$

$$I_{\text{out}} = I_{\text{in}} \exp \left(- \left[\sum_{j=1}^n k_j \omega_j z + K_{\text{bg}} z \right] \right). \quad (6b)$$

This model was used to make quantitative predictions of the time courses of the experiments. The system

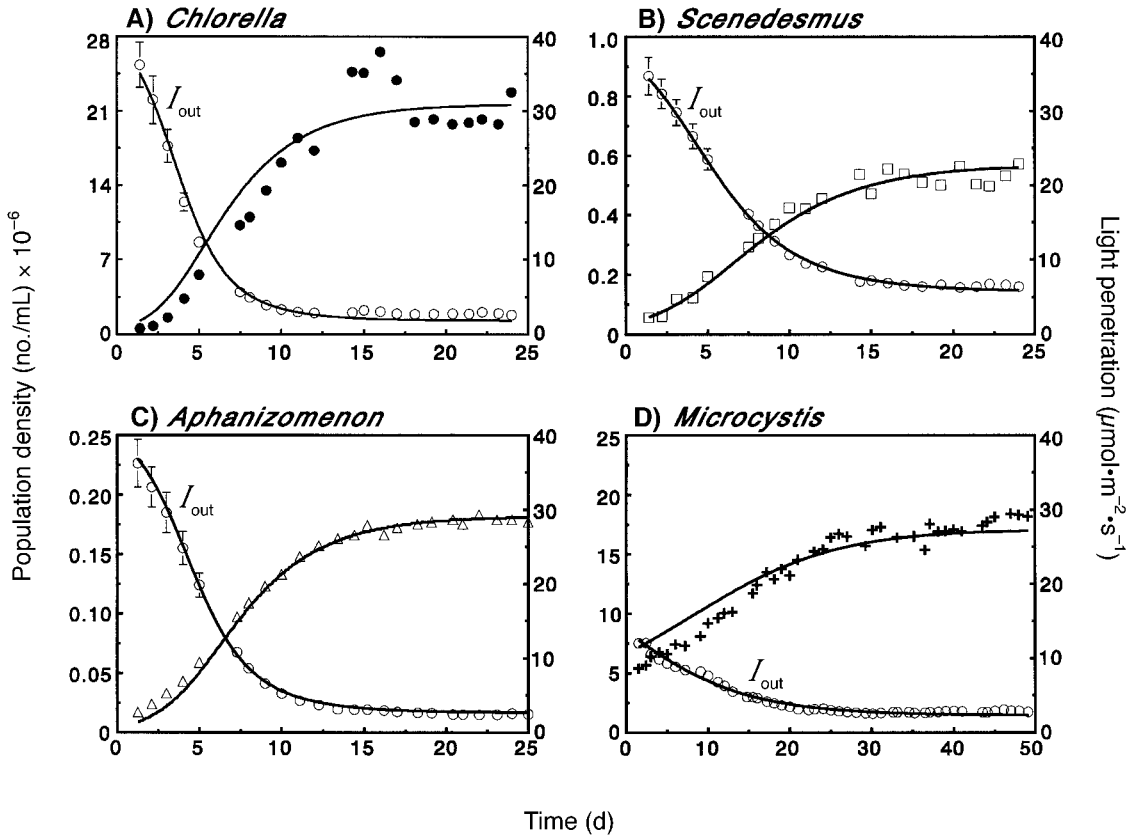

FIG. 2. Time course of the monoculture experiments: (A) *Chlorella vulgaris* (●), (B) *Scenedesmus protuberans* (□), (C) *Aphanizomenon flos-aquae* (△), (D) *Microcystis* sp. (+). The light intensity, I_{out} , penetrating through the cultures is indicated by open circles (○). Error bars around the open circles (○) indicate the spatial standard deviation of I_{out} ($N = 10$). When not visible, the spatial standard deviation did not exceed the size of the circle. Solid lines show the least-squares fit of Eqs. 6a and b to the data. The parameter estimates obtained from these least-squares fits are given in Table 1. Initial conditions: (A) *Chlorella* = 4.97×10^5 coenobia/mL; (B) *Scenedesmus* = 3.42×10^4 coenobia/mL; (C) *Aphanizomenon* = 4.27×10^3 filaments/mL; (D) *Microcystis* = 6.62×10^6 cells/mL.

parameters I_{in} , z , K_{bg} , and D were measured directly. The species parameters $p_{max,i}$, α_i , and k_i were estimated from the monoculture experiments, using a least-squares fit of model predictions of population density and I_{out} vs. observed values of population density and I_{out} . (For the methods to fit differential equations to data, see Richter and Söndgerath 1990). Note that the two dependent variables were measured on completely different scales (i.e., population density in millions of cells/mL and I_{out} in a few $\mu\text{mol photons}\cdot\text{m}^{-2}\cdot\text{s}^{-1}$). Therefore, we used the total sum of squares of each variable as a weighting factor to calculate the residual sum of squares. This has the effect that the two variables are given equal weight in the fitting procedure. The time courses of the competition experiments were predicted a priori, using the measured system parameters and the species parameters estimated from the monoculture experiments.

Critical light intensities

We used two different procedures to estimate the critical light intensity of a species. The critical light

intensity was directly measured as the light intensity penetrating through the culture when the species had reached a monoculture steady state. More precisely, this “observed” critical light intensity was calculated as the average I_{out} observed during the last seven days of each monoculture experiment. Alternatively, the critical light intensity was derived from the fit of Eqs. 6a and b to the monoculture experiments. This “fitted” critical light intensity was calculated as the equilibrium I_{out} predicted by Eqs. 6a and b when using the measured system parameters and the estimated species parameters.

RESULTS

Monoculture experiments

Fig. 2 shows the time course of the monoculture experiments. In each experiment, population density increased and, as a consequence, the light intensity I_{out} decreased until a steady state was reached. The two green algae, *Chlorella* and *Scenedesmus*, and the cyanobacterium *Aphanizomenon* reached a steady state

TABLE 1. Parameter estimates obtained from the monoculture experiments shown in Fig. 2. The species parameters α , p_{\max} , and k , were estimated using a least-squares fit of Eqs. 6a and b vs. observed values of population density, ω , and light intensity, I_{out} . Units are as follows: α , $\text{h}^{-1} \cdot (\mu\text{mol photons} \cdot \text{m}^{-2} \cdot \text{s}^{-1})^{-1}$; p_{\max} , h^{-1} ; k , $\text{cm}^2/10^6$ cells; ω , 10^6 cells/mL; I_{out} , $\mu\text{mol photons} \cdot \text{m}^{-2} \cdot \text{s}^{-1}$. All quantities are reported as means, with 1 SD in parentheses.

Species	$\alpha \times 10^3$	p_{\max}	k	Steady-state population density		Critical light intensity	
				Observed	Predicted	Observed	Predicted
<i>Chlorella</i>	0.904 (0.021)	[10]†	0.0291 (0.0011)	20.4 (1.1)	21.6	2.75 (0.11)	1.80
<i>Scenedesmus</i>	0.650 (0.004)	[10]†	0.700 (0.012)	0.53 (0.03)	0.57	6.49 (0.17)	5.71
<i>Aphanizomenon</i>	0.817 (0.004)	[10]†	3.04 (0.03)	0.18 (0.003)	0.18	2.44 (0.09)	2.64
<i>Microcystis</i>	8.13 (0.63)	0.0188 (0.0003)	0.0340 (0.0005)	17.9 (0.5)	17.1	2.85 (0.13)	2.30

Notes: System parameters were measured directly: $I_{\text{in}} = 60 \mu\text{mol photons} \cdot \text{m}^{-2} \cdot \text{s}^{-1}$; $z = 5.0$ cm; $K_{\text{bg}} = 0.072 \text{ cm}^{-1}$; $D = 0.015 \text{ h}^{-1}$. Observed steady-state population densities and critical light intensities were calculated as the average population density and average I_{out} observed during the last 7 d of each monoculture experiment ($N = 7$). Predicted steady-state population densities and critical light intensities were calculated as the equilibrium solutions of Eqs. 6a and b, using the given species and system parameters.

† For three species, the iterative fitting procedure led to an estimate for p_{\max} that diverged to infinity. This indicates that the light intensities encountered during mixing were still in the linear part of the $p_i(I)$ curve. Hence, for these species only the initial slope α is relevant, and p_{\max} was arbitrarily set to 10.

within 15–20 d. The other cyanobacterium, *Microcystis*, was inoculated at a slightly higher initial density because it grew more slowly. It approached a steady state approximately 30 days after the start of the experiment. Note that the steady-state population densities of *Chlorella* and *Microcystis* were much higher than those of *Aphanizomenon* and *Scenedesmus* (Fig. 2, Table 1). This is related to the size of the algae; the cells of *Chlorella* and *Microcystis* are much smaller than the filaments of *Aphanizomenon* or the four-celled coenobia of *Scenedesmus*. In terms of biomass or biovolume, the numbers would have been closer.

In all four cases, the model given by Eqs. 6a and b fits very well to the time course observed in the monoculture experiments (compare the symbols and solid lines in Fig. 2). The parameter estimates obtained from these model fits are given in Table 1.

According to the theory, the critical light intensities measured in monoculture can be used to predict the outcome of competition for light. The species with lowest critical light intensity should be the superior competitor (Huisman and Weissing 1994, Weissing and Huisman 1994). Of the four species, *Scenedesmus* had by far the highest critical light intensity (Table 1), and theory thus predicts that *Scenedesmus* should be displaced in combination with any of the other species. The critical light intensities of *Aphanizomenon*, *Chlorella*, and *Microcystis* were quite similar, however. Moreover, for these three species the observed critical light intensities gave another species ranking than the critical light intensities obtained by the model fits (Table 1). *Aphanizomenon* had the lowest observed critical light intensity, whereas *Chlorella* had the lowest critical light intensity according to the model fits. Therefore it is not really clear from the monoculture exper-

iments which of these three species should be the better competitor for light.

Competition experiments

Green algae.—In a first competition experiment, the two green algae, *Chlorella* and *Scenedesmus*, were both inoculated at low density (Fig. 3A). The population densities of both species initially increased and, thereby, the light intensity I_{out} declined. Competitive displacement started after approximately eight days. *Scenedesmus* was gradually displaced by *Chlorella*. Note that *Scenedesmus* started to decline when I_{out} had been reduced below its critical light intensity of $\sim 6 \mu\text{mol photons} \cdot \text{m}^{-2} \cdot \text{s}^{-1}$ (Table 1). The time course of this competition experiment was predicted a priori using Eqs. 6a and b, with the measured system parameters and the species parameters estimated from the monoculture experiments (Table 1). The predicted time course of competition (solid lines in Fig. 3A) is in excellent agreement with the actual time course observed in the experiment. In a subsequent experiment, a small number of *Chlorella* cells was inoculated in a steady-state monoculture of *Scenedesmus* (Fig. 3B). *Chlorella* was able to invade. The increase of *Chlorella* was accompanied by a gradual reduction of I_{out} , followed by a decline of the *Scenedesmus* population. Conversely, a few *Scenedesmus* coenobia were inoculated in a steady-state monoculture of *Chlorella* (Fig. 3C). *Scenedesmus* was not able to invade. Instead, the small *Scenedesmus* population declined while the *Chlorella* population remained unaffected. Again, the model predictions are in excellent agreement with the experimental data. Taken together, these three experiments show that *Chlorella* wins from *Scenedesmus* independent of their initial abundances.

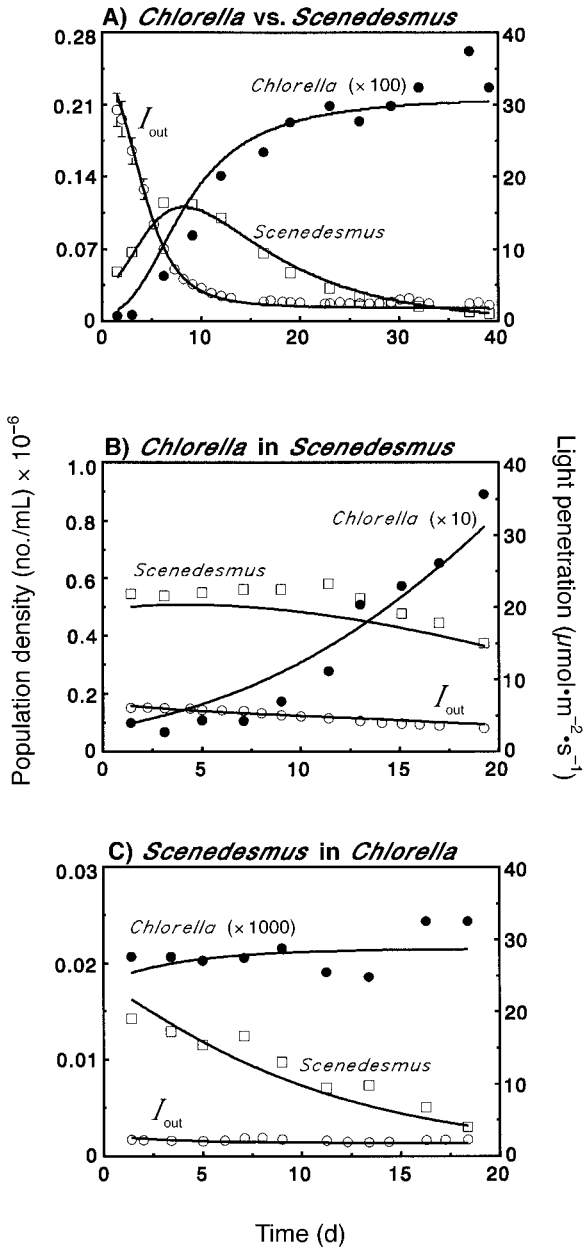

FIG. 3. Competition between two green algae. (A) *Chlorella* (●) displaces *Scenedesmus* (□). (B) *Chlorella* invades a steady-state monoculture of *Scenedesmus*. (C) *Scenedesmus* does not invade a steady-state monoculture of *Chlorella*. Open circles (○) indicate the light intensity I_{out} penetrating through the cultures. Solid lines show the time course of competition predicted by Eqs. 6a and b. For parameter values, see Table 1. Initial conditions: (A) *Chlorella* = 4.21×10^5 cells/mL, *Scenedesmus* = 2.53×10^4 coenobia/mL; (B) *Chlorella* = 7.73×10^5 cells/mL, *Scenedesmus* = 4.90×10^5 coenobia/mL; (C) *Chlorella* = 1.80×10^7 cells/mL, *Scenedesmus* = 1.80×10^4 coenobia/mL.

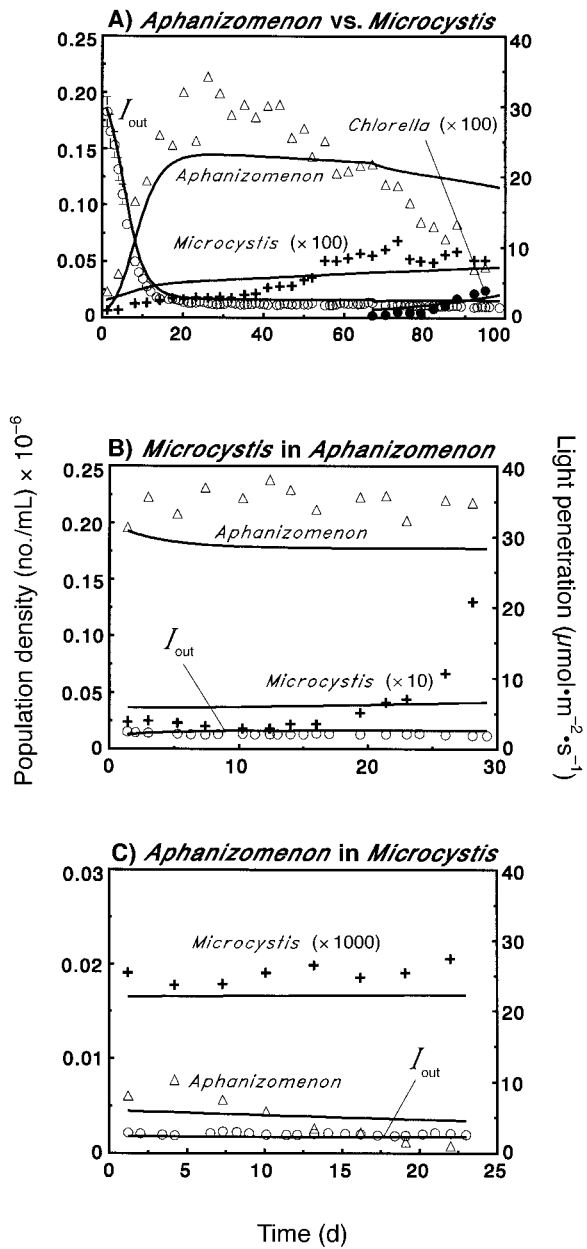

Fig. 4. Competition between two cyanobacteria. (A) *Aphanizomenon* (Δ) is displaced by *Microcystis* (+); by accident at the end of this experiment *Chlorella* (●) invades. (B) *Microcystis* invades a steady-state monoculture of *Aphanizomenon*. (C) *Aphanizomenon* does not invade a steady-state monoculture of *Microcystis*. Open circles (○) indicate the light intensity I_{out} penetrating through the cultures. Solid lines show the time course of competition predicted by Eqs. 6a and b. For parameter values, see Table 1. Initial conditions: (A) *Aphanizomenon* = 4.49×10^3 filaments/mL, *Microcystis* = 1.46×10^6 cells/mL, *Chlorella* (at day 67) = 7.41×10^5 cells/mL; (B) *Aphanizomenon* = 2.00×10^5 filaments/mL, *Microcystis* = 3.68×10^5 cells/mL; (C) *Aphanizomenon* = 4.51×10^3 filaments/mL, *Microcystis* = 1.65×10^7 cells/mL.

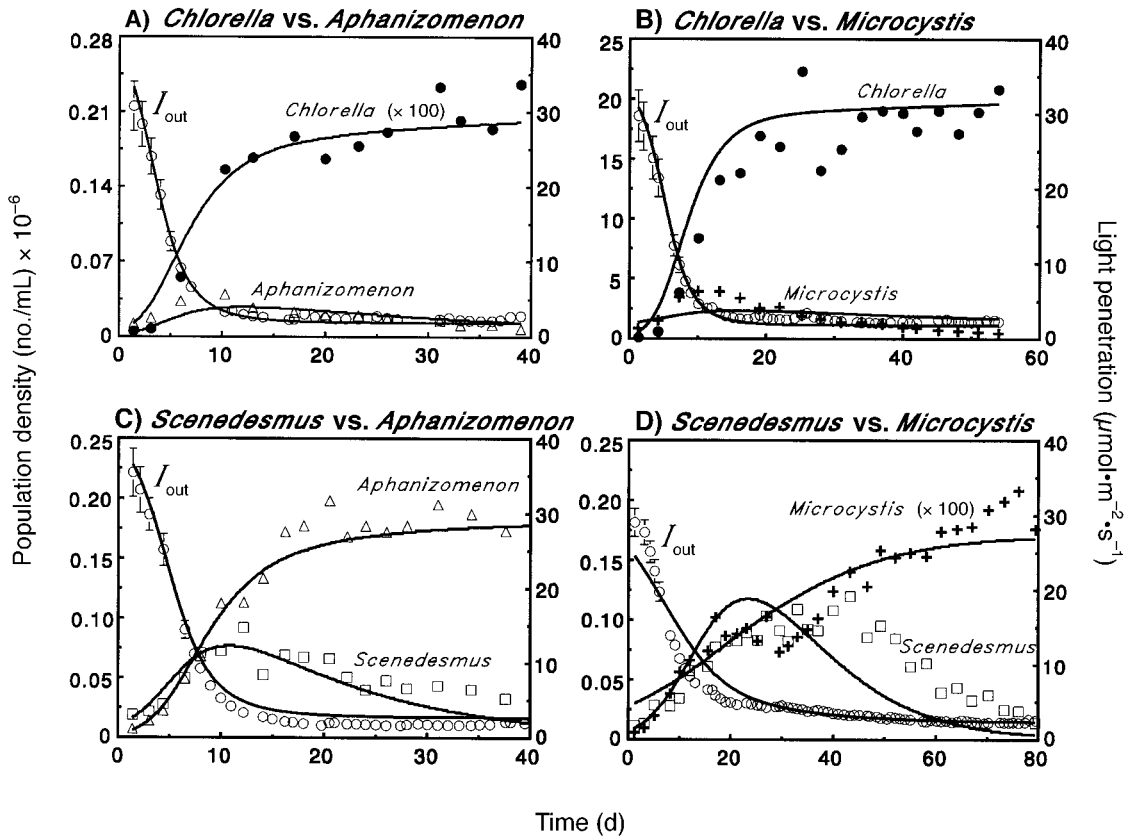

FIG. 5. Competition between a green alga and a cyanobacterium. (A) *Chlorella* (●) displaces *Aphanizomenon* (Δ). (B) *Chlorella* displaces *Microcystis* (+). (C) *Scenedesmus* (□) is displaced by *Aphanizomenon*. (D) *Scenedesmus* is displaced by *Microcystis*. Open circles (○) indicate the light intensity I_{out} penetrating through the cultures. Solid lines show the time course of competition predicted by Eqs. 6a and b. For parameter values, see Table 1. Initial conditions: (A) *Chlorella* = 5.04×10^5 cells/mL, *Aphanizomenon* = 2.01×10^3 filaments/mL; (B) *Chlorella* = 2.72×10^5 cells/mL, *Microcystis* = 1.25×10^6 cells/mL; (C) *Scenedesmus* = 9.50×10^3 coenobia/mL, *Aphanizomenon* = 2.80×10^3 filaments/mL; (D) *Scenedesmus* = 6.67×10^3 coenobia/mL, *Microcystis* = 2.78×10^6 cells/mL.

Cyanobacteria.—Similar competition experiments were performed with the two cyanobacteria. The monoculture experiments already showed that *Aphanizomenon* grows faster than *Microcystis* (Fig. 2C, D). Hence, when both species were inoculated at low density, *Aphanizomenon* was able to develop a dense population before being gradually displaced by *Microcystis* (Fig. 4A). By accident, at day 67 the experiment got infected by *Chlorella*. *Chlorella* was able to invade the *Aphanizomenon*–*Microcystis* mixture. Further (deliberately planned) invasion experiments showed that *Microcystis* was able to invade a steady-state monoculture of *Aphanizomenon* (Fig. 4B), while *Aphanizomenon* was not able to invade a steady-state monoculture of *Microcystis* (Fig. 4C). Hence *Microcystis* was a better competitor for light than *Aphanizomenon*, independent of the initial conditions. In all three *Microcystis*–*Aphanizomenon* experiments, the model given by Eqs. 6a and b does capture the qualitative trend, but the quantitative correspondence between model predictions and experimental data is not very convincing for this species combination.

Green algae vs. cyanobacteria.—Competition between a cyanobacterium and a green alga is studied in Fig. 5. The green alga *Scenedesmus* was competitively displaced by both *Aphanizomenon* and *Microcystis* (Fig. 5C, D). On the other hand, both *Aphanizomenon* and *Microcystis* were displaced by the other green alga, *Chlorella* (Fig. 5A, B). The model predictions coincide quite well with the time course observed in the experiments.

Four-species competition.—In one experiment the four species were inoculated together (Fig. 6). Initially, the populations of all four species increased, thus reducing I_{out} . After about one week, the populations of *Scenedesmus* and *Aphanizomenon* started to decline. A few days later, *Microcystis* also declined. They were gradually displaced by *Chlorella*, which became the final dominant in this experiment. Again, the model predictions match the experimental data.

DISCUSSION

This paper aims to predict the outcome of phytoplankton competition for light on the basis of mono-

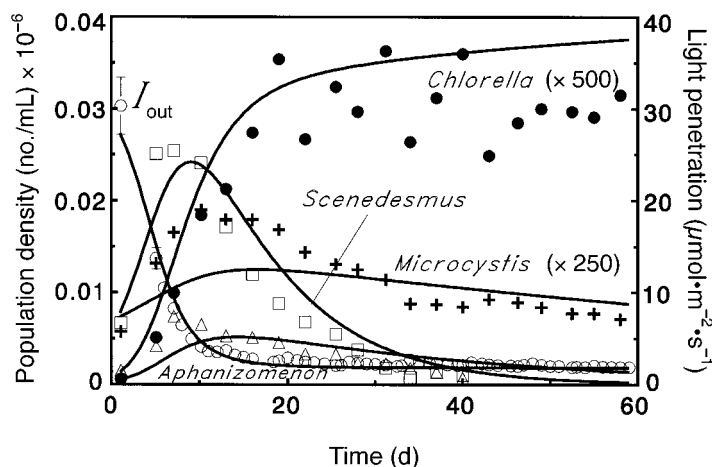

FIG. 6. Competition among four species: *Chlorella* (●), *Scenedesmus* (□), *Aphanizomenon* (△), and *Microcystis* (+). Open circles (○) indicate the light intensity I_{out} penetrating through the cultures. Solid lines show the time course of competition predicted by Eqs. 6a and b. For parameter values, see Table 1. Initial conditions: *Chlorella* = 4.11×10^5 cells/mL, *Scenedesmus* = 5.84×10^3 coenobia/mL, *Aphanizomenon* = 3.30×10^2 filaments/mL, *Microcystis* = 1.72×10^6 cells/mL.

culture measurements. According to recent resource competition theory, the species with lowest critical light intensity should be the superior light competitor (Huisman and Weissing 1994, Weissing and Huisman 1994). To test this prediction we used a simple procedure. The critical light intensities and other relevant model parameters were either directly observed or estimated from a model fit to monoculture experiments. Hence, the solid lines in Fig. 2 are fits of the model to the monoculture data. The parameter estimates thus obtained were used to predict the time course and outcome of the competition experiments. Accordingly, the solid lines in Figs. 3–6 are not model fits. They are model predictions that were made independent of the time course of the competition experiments. In general, the correspondence between the model predictions and the actual time course of the competition experiments was good.

We found that *Scenedesmus* had a much higher critical light intensity than the other species (Table 1). Indeed, as predicted, it was always competitively excluded (Figs. 3, 5C, 5D, 6). Also in line with the theory, *Scenedesmus* started to decrease in its abundance when the light intensity penetrating through the water column had been reduced below its critical light intensity. This demonstrates that the concept of a critical light intensity is capable of predicting the outcome of competition for light, at least when the critical light intensities of the competing species are sufficiently different.

Aphanizomenon, *Chlorella*, and *Microcystis* had rather similar critical light intensities (Table 1). Therefore it was not obvious from the monoculture experiments which of these three species should better compete for light. Two procedures to estimate the critical light intensity were used. The critical light intensity was measured as the observed light intensity penetrating through the water column when the species had

reached a monoculture steady state. Using this procedure, the species can be ranked according to their expected competitive ability for light as follows (Table 1):

$$\begin{aligned} &Aphanizomenon > Chlorella > Microcystis \\ &> Scenedesmus \end{aligned} \quad (7)$$

where “>” means “is a superior competitor to.” The critical light intensity was also derived from the fit of the model described by Eqs. 6a and b, using the measured system parameters and the species parameters estimated from the time course of the monoculture experiments. In this case, the competitive hierarchy reads (Table 1)

$$\begin{aligned} &Chlorella > Microcystis > Aphanizomenon \\ &> Scenedesmus. \end{aligned} \quad (8)$$

Note that the position of *Aphanizomenon* shifted from place 1 in Eq. 7 to place 3 in Eq. 8. Because inspection by eye showed that the *Aphanizomenon* monoculture had a slightly different color (gray-green) than the monocultures of the other species (bright green), we hypothesized that this shift was related to spectral aspects of light. To test this hypothesis, we took samples from the steady-state monocultures and measured the absorption spectra with an Aminco DW2000 spectrophotometer. Green algae such as *Chlorella* and *Scenedesmus* use carotenoids and chlorophyll *a* and *b* to absorb light in the red and blue region of the light spectrum, whereas they hardly absorb green and yellow light (525–650 nm range; Fig. 7A, B). In contrast to green algae, cyanobacteria contain phycobiliprotein pigments (e.g., Kirk 1994). The phycocyanin peak (at 620 nm) is clearly visible in the spectrum of *Microcystis* (Fig. 7C). The flat plateau from 575–630 nm suggests that *Aphanizomenon* contains both phycocyanin and phycoerythrocyanin (Fig. 7D). The spectra

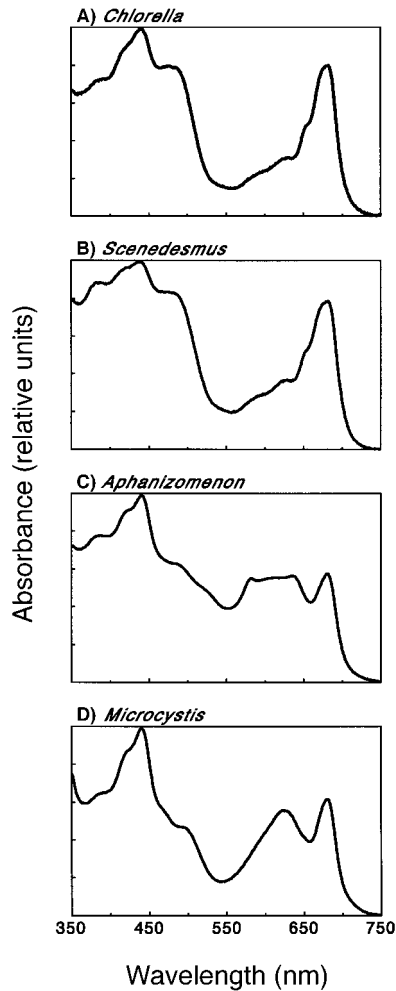

FIG. 7. Absorption spectra of samples taken from the steady-state monocultures of the two green algae (A) *Chlorella vulgaris* and (B) *Scenedesmus protuberans*, and the two cyanobacteria (C) *Aphanizomenon flos-aquae* and (D) *Microcystis* sp. For ease of comparison, the spectra are drawn at the same scale.

show that *Aphanizomenon* absorbs green light (525–600 nm range) more efficiently than the three other species (Fig. 7). This was confirmed by measurements of the spectral distribution of light penetrating through the steady-state monocultures with a Licor LI-1800 spectroradiometer. More than 80% of the total light (400–700 nm) penetrating through the steady-state cultures of *Chlorella* and *Microcystis* consisted of green light (525–600 nm). For *Aphanizomenon*, only 60% of the penetrating light was in this spectral region. The more efficient absorption of green light by *Aphanizomenon* might explain why less total light penetrated through the *Aphanizomenon* culture than through the cultures of *Chlorella* and *Microcystis*, and hence why *Aphanizomenon* had a lower observed critical light intensity than did the other species (Eq. 7).

Interestingly, the outcomes of the competition ex-

periments were all consistent with the competitive ordering of the species on the basis of their fitted critical light intensities (Eq. 8). That is, in the pairwise competition experiments *Chlorella* competitively displaced all three other species (Fig. 3A, 5A, 5B), *Microcystis* displaced both *Aphanizomenon* and *Scenedesmus* (Fig. 4A, 5D), and *Aphanizomenon* only displaced *Scenedesmus* (Fig. 5C). In the invasion experiments, *Chlorella* was able to invade *Scenedesmus*, whereas *Scenedesmus* was not able to invade *Chlorella* (Fig. 3B, C). *Chlorella* was also able to invade a *Microcystis*–*Aphanizomenon* mixture (Fig. 4A). *Microcystis* invaded *Aphanizomenon*, whereas *Aphanizomenon* did not invade *Microcystis* (Fig. 4B, C). In the four-species competition experiment, *Scenedesmus* and *Aphanizomenon* were the first species to decline, next *Microcystis* declined, and *Chlorella* became the final dominant (Fig. 6). Hence, all competition experiments in this study point at the competitive hierarchy of Eq. 8.

Why do the fitted critical light intensities yield a better correspondence between theory and the competition experiments than the observed critical light intensities? Perhaps it is just a matter of coincidence. A statistical explanation is also conceivable, however. The observed critical light intensities are based on data of the steady states only. In contrast, the fitted critical light intensities are derived from fits of the model to the complete time course of the monoculture experiments. Clearly, the model itself is a simplification of reality. Several aspects, like photoadaptation and the spectral distribution of light, are not included. If these aspects do play a role, however, it is possible that they are implicitly taken into account in the parameter estimates of the model fit. For example, above we discussed the idea that *Aphanizomenon* had a lower observed critical light intensity than the other species, not because of lower light requirements, but because it absorbs more green light than the other species. It might be that a model fit to the complete time course is sensitive to such spectral aspects and is thus able to partially correct for them. In other words, the complete time course may bear more information on the species characteristics than the steady-state data alone.

Our results do not support the general contention (Mur et al. 1977, Agusti et al. 1990, Schubert et al. 1995, Scheffer et al. 1997) that cyanobacteria are better adapted to low light conditions and hence better competitors for light than green algae. Low light conditions are thought to favor cyanobacteria because these prokaryotes have lower maintenance costs than the eukaryotic green algae (van Liere and Mur 1979, Gons and Mur 1980). In our experiments, the cyanobacteria *Microcystis* and *Aphanizomenon* were indeed better competitors for light than the green alga *Scenedesmus*. However, both cyanobacterial species were displaced by the other green alga, *Chlorella*. With only four species, our study is too limited to allow taxonomic generalizations, but it is possible that some cyanobacteria

and green algae perform better under light-limited conditions while others perform worse without any clear relationship with taxonomic affiliation. If so, the often observed dominance of cyanobacteria in eutrophicated waters (Paerl 1988, Steinberg and Hartmann 1988, Duarte et al. 1992) cannot be solely explained by competition for light.

Summarizing, the qualitative outcomes of the competition experiments were all consistent with the competitive ordering of the species predicted from the fitted critical light intensities estimated in the monoculture experiments (Eq. 8). Quantitatively, the predicted time courses of competition were in excellent agreement with the experimental results for most species combinations (solid lines in Figs. 3, 5, 6). For the green algae *Chlorella* and *Scenedesmus*, which have similar light absorption spectra (Fig. 7), the correspondence between model predictions and competition experiments is especially remarkable (Fig. 3). However, for some combinations (especially *Microcystis*-*Aphanizomenon*; Fig. 4), the model captured the qualitative trend but, quantitatively, further improvement seems desirable. Several factors not considered in the model might be relevant. These include (1) physiological adaptation of the algae to the changing light conditions during the experiments, and (2) differences in the light absorption spectra of the competing species. For example, we found that *Microcystis* lost most of its gas vesicles when I_{out} became low (J. Huisman, *personal observation*) and that *Aphanizomenon* absorbed green light more efficiently than the other species (Fig. 7). Studies of photoadaptation and spectral aspects of competition for light may therefore provide important next steps towards a further understanding of phytoplankton competition. In total, however, our results clearly demonstrate that at least under well controlled conditions a simple competition model is capable of capturing the essence of the struggle for light between phytoplankton species.

ACKNOWLEDGMENTS

Jef Huisman thanks Luuc Mur for providing the opportunity and facilities to run the experiments in his lab. We are very grateful to Bert van Groen, Ron Groenestein, and Geert Nijk, who assembled the culture vessels. We thank Hans Balke, Hans Matthijs, and Jutta Passarge for advice and practical support. Jelte van Andel, Luuc Mur, and the two anonymous referees are acknowledged for their helpful comments on the manuscript. The research of Cor Zonneveld was funded by the Dutch Government, National Research Program on Global Air Pollution and Climate Change (NOP grant 013/1204.10). The investigations of Jef Huisman were supported by the Life Sciences Foundation (SLW), which is subsidized by the Netherlands Organization for Scientific Research (NWO).

LITERATURE CITED

- Agusti, S., C. M. Duarte, and D. E. Canfield, Jr. 1990. Phytoplankton abundance in Florida lakes: evidence for the frequent lack of nutrient limitation. *Limnology and Oceanography* **35**:181-188.
- Armstrong, R. A., and R. McGehee. 1980. Competitive exclusion. *American Naturalist* **115**:151-170.
- Bannister, T. T. 1974. Production equations in terms of chlorophyll concentration, quantum yield, and upper limit to production. *Limnology and Oceanography* **19**:1-12.
- Duarte, C. M., S. Agusti, and D. E. Canfield, Jr. 1992. Patterns in phytoplankton community structure in Florida lakes. *Limnology and Oceanography* **37**:155-161.
- Dubelaar, G. B. J., A. C. Groenewegen, W. Stokdijk, G. J. van den Engh, and J. W. M. Visser. 1989. Optical Plankton Analyser: a flow cytometer for plankton analysis, II: specifications. *Cytometry* **10**:529-539.
- Ducobu, H., J. Huisman, R. R. Jonker, and L. R. Mur. 1998. Competition between a prochlorophyte and a cyanobacterium under various phosphorus regimes: comparison with the Droop model. *Journal of Phycology* **34**:467-476.
- Gons, H. J., and L. R. Mur. 1980. Energy requirements for growth and maintenance of *Scenedesmus protuberans* Fritsch in light-limited continuous cultures. *Archives of Microbiology* **125**:9-17.
- Grover, J. P. 1991. Resource competition in a variable environment: phytoplankton growing according to the variable-internal-stores model. *American Naturalist* **138**:811-835.
- Hansen, S. R., and S. P. Hubbell. 1980. Single-nutrient microbial competition: qualitative agreement between experimental and theoretically forecast outcomes. *Science* **207**:1491-1493.
- Huisman, J. 1999. Population dynamics of light-limited phytoplankton: microcosm experiments. *Ecology* **80**:202-210.
- Huisman, J., and F. J. Weissing. 1994. Light-limited growth and competition for light in well-mixed aquatic environments: an elementary model. *Ecology* **75**:507-520.
- Huisman, J., and F. J. Weissing. 1995. Competition for nutrients and light in a mixed water column: a theoretical analysis. *American Naturalist* **146**:536-564.
- Jonker, R. R., J. T. Meulemans, G. B. J. Dubelaar, M. F. Wilkins, and J. Ringelberg. 1995. Flow cytometry: a powerful tool in analysis of biomass distributions in phytoplankton. *Water Science and Technology* **32**:177-182.
- Kirk, J. T. O. 1994. *Light and photosynthesis in aquatic ecosystems*. Second edition. Cambridge University Press, Cambridge, UK.
- Matthijs, H. C. P., H. Balke, U. M. van Hes, B. M. A. Kroon, L. R. Mur, and R. A. Binot. 1996. Application of light-emitting diodes in bioreactors: flashing light effects and energy economy in algal culture (*Chlorella pyrenoidosa*). *Biotechnology and Bioengineering* **50**:98-107.
- Mur, L. R., H. J. Gons, and L. van Liere. 1977. Some experiments on the competition between green algae and blue-green bacteria in light-limited environments. *FEMS Microbiology Letters* **1**:335-338.
- Paerl, H. W. 1988. Nuisance phytoplankton blooms in coastal, estuarine, and inland waters. *Limnology and Oceanography* **33**:823-847.
- Platt, T., S. Sathyendranath, and P. Ravindran. 1990. Primary production by phytoplankton: analytic solutions for daily rates per unit area of water surface. *Proceedings of the Royal Society of London*, **B241**:101-111.
- Reynolds, C. S. 1984. *The ecology of freshwater phytoplankton*. Cambridge University Press, Cambridge, UK.
- Richter, O., and D. Söndgerath. 1990. Parameter estimation in ecology: the link between data and models. VCH, Weinheim, Germany.
- Rothhaupt, K. O. 1996. Laboratory experiments with a mixotrophic chrysophyte and obligately phagotrophic and phototrophic competitors. *Ecology* **77**:716-724.
- Scheffer, M., S. Rinaldi, A. Gragnani, L. R. Mur, and E. H. van Nes. 1997. On the dominance of filamentous cyanobacteria in shallow, turbid lakes. *Ecology* **78**:272-282.
- Schubert, H., H. C. P. Matthijs, L. R. Mur, and U. Schiewer. 1995. Blooming of cyanobacteria in turbulent water with

- steep light gradients: the effect of intermittent light and dark periods on the oxygen evolution capacity of *Synechocystis* sp. PCC 6803. *FEMS Microbiology Ecology* **18**: 237–245.
- Sommer, U. 1993. Phytoplankton competition in Plußsee: a field test of the resource-ratio hypothesis. *Limnology and Oceanography* **38**:838–845.
- Steinberg, C. E. W., and H. M. Hartmann. 1988. Planktonic bloom-forming cyanobacteria and the eutrophication of lakes and rivers. *Freshwater Biology* **20**:279–287.
- Tilman, D. 1977. Resource competition between planktonic algae: an experimental and theoretical approach. *Ecology* **58**:338–348.
- . 1982. Resource competition and community structure. Princeton University Press, Princeton, New Jersey, USA.
- Tilman, D., and R. W. Sterner. 1984. Invasions of equilibria: tests of resource competition using two species of algae. *Oecologia* **61**:197–200.
- Tsuji, T., and T. Yanagita. 1981. Improved fluorescent microscopy for measuring the standing stock of phytoplankton including fragile components. *Marine Biology* **64**:207–211.
- van Donk, E., and S. S. Kilham. 1990. Temperature effects on silicon- and phosphorus-limited growth and competitive interactions among three diatoms. *Journal of Phycology* **26**: 40–50.
- van Liere, L., and L. R. Mur. 1979. Growth kinetics of *Oscillatoria agardhii* Gomont in continuous culture, limited in its growth by the light energy supply. *Journal of General Microbiology* **115**:153–160.
- Weissing, F. J., and J. Huisman. 1994. Growth and competition in a light gradient. *Journal of Theoretical Biology* **168**:323–336.