

Complexity Analysis of Continuous Petri Nets*

Estíbaliz Fraca¹, Serge Haddad²

¹ Instituto de Investigación en Ingeniería de Aragón (I3A)
Universidad de Zaragoza, Zaragoza, Spain
E-mail: efrac@unizar.es

² Ecole Normale Supérieure de Cachan,
LSV, CNRS UMR 8643, INRIA, Cachan, France
E-mail: haddad@lsv.ens-cachan.fr

Abstract. At the end of the eighties, continuous Petri nets were introduced for: (1) alleviating the combinatorial explosion triggered by discrete Petri nets and, (2) modelling the behaviour of physical systems whose state is composed of continuous variables. Since then several works have established that the computational complexity of deciding some standard behavioural properties of Petri nets is reduced in this framework. Here we first establish the decidability of additional properties like boundedness and reachability set inclusion. We also design new decision procedures for the reachability and lim-reachability problems with a better computational complexity. Finally we provide lower bounds characterising the exact complexity class of the boundedness, the reachability, the deadlock freeness and the liveness problems.

1 Introduction

From Petri nets to continuous Petri nets. Continuous Petri nets (CPN) were introduced in [5] by considering continuous states (specified by a non negative real number of tokens in places) where the dynamics of the system is triggered either by discrete events or by a continuous evolution ruled by speed of firings. In the former case such nets are called autonomous CPNs while in the latter they are called timed CPNs. In both cases, the evolution is due to a *fractional* transition firing (infinitesimal and simultaneous in the case of timed CPNs).

Modelling with CPNs. CPNs have been used in several significant application fields. In [3], a method based on CPNs is proposed for the fault diagnosis of manufacturing systems that manage systems intractable with discrete Petri nets (for modelling of manufacturing systems see also [16]). In [14], the authors introduce a bottom-up modelling methodology based on CPNs to represent cell metabolism and solve in this framework the regulation control problem. Combining discrete and continuous Petri nets yields hybrid Petri nets with applications

* This work has been partially supported by CICYT - FEDER project DPI2010-20413, by a pre-doctoral grant of the Gobierno de Aragón and by Fundación Aragón I+D and by ImpRo (ANR-2010-BLAN-0317).

to modelling and simulation of water distribution systems [8] and to the analysis of traffic in urban networks [15].

Analysis of CPNs. While several analysis methods have been developed for timed CPNs there is no hope for fully automatic techniques in the general case since standard problems of dynamic systems are known to be undecidable even for bounded nets [12].

Due to the semantics of autonomous CPNs, a marking can be the limit of the markings visited along an infinite firing sequence. Thus most of the usual properties are duplicated depending on whether these markings are considered or not. When considering these markings, reachability (resp. liveness, deadlock-freeness) becomes lim-reachability (resp. lim-liveness, lim-deadlock-freeness).

Contrary to the timed case, the analysis of autonomous CPNs (that we simply call CPNs in the sequel) appears to be less complex than the one of discrete Petri nets. In [9], exponential time decision procedures are proposed for the reachability and lim-reachability problems for general CPNs. In [13] assuming additional hypotheses on the net, the authors design polynomial time decision procedures for (lim-)reachability and boundedness. In [12], (lim-)deadlock-freeness and (lim-)liveness are shown to belong in coNP. These procedures are based on “simple” characterisations of the properties.

Our contributions. First we revisit characterisations of properties in CPN establishing an alternative characterisation for reachability and the first characterisation for boundedness. Then based on these characterisations, we show that (lim-)reachability and boundedness are decidable in polynomial time. We also establish that the (lim-)reachability set inclusion problem is decidable in exponential time. Finally we prove that (lim-)reachability and boundedness are PTIME-hard and that (lim-)deadlock-freeness, (lim-)liveness and (lim-)reachability set inclusion problems are coNP-hard. We establish these lower bounds even when considering restricted cases of these problems.

Organisation. In Section 2, we introduce CPNs and the properties that we are analysing. In Section 3, we develop the characterisations of reachability and boundedness. Afterwards in Section 4, we design the decision procedures. Then, we provide complexity lower bounds in Section 5. Finally in Section 6, we summarise our results and give perspectives to this work. Two hardness proofs are given in appendix and will be omitted in the final version.

2 Continuous Petri nets: definitions and properties

2.1 Continuous Petri nets

Notations. \mathbb{N} (resp. \mathbb{Q} , \mathbb{R}) is the set of non negative integers (resp. rational, real numbers). Given a set of numbers E , $E_{\geq 0}$ (resp. $E_{>0}$) denotes the subset of non negative (resp. positive) numbers of E . Given an $E \times F$ matrix \mathbf{M} with E and F sets of indices, $E' \subseteq E$ and $F' \subseteq F$, the $E' \times F'$ submatrix $\mathbf{M}_{E' \times F'}$ denotes the restriction of \mathbf{M} to rows indexed by E' and columns indexed by F' . The support

of a vector $\mathbf{v} \in \mathbb{R}^E$, denoted $\llbracket \mathbf{v} \rrbracket$, is defined by $\llbracket \mathbf{v} \rrbracket \stackrel{\text{def}}{=} \{e \in E \mid \mathbf{v}[e] \neq 0\}$. $\mathbf{0}$ denotes the null vector. One writes $\mathbf{v} \geq \mathbf{w}$ when \mathbf{v} is componentwise greater or equal than \mathbf{w} and $\mathbf{v} \succeq \mathbf{w}$ when $\mathbf{v} \geq \mathbf{w}$ and $\mathbf{v} \neq \mathbf{w}$. One writes $\mathbf{v} > \mathbf{w}$ when \mathbf{v} is componentwise strictly greater than \mathbf{w} . $\|\mathbf{v}\|_1$ is the 1-norm of \mathbf{v} defined by $\|\mathbf{v}\|_1 \stackrel{\text{def}}{=} \sum_{e \in E} |\mathbf{v}[e]|$. Let $E' \subseteq E$, then $\mathbf{v}[E']$ denotes the restriction of \mathbf{v} to components of E' .

Here, we adopt the following terminology: a *net* denotes the structure without initial marking while a *net system* denotes a net with an initial marking. The structure of CPNs and discrete nets are identical.

Definition 1 A Petri net (PN) is a tuple $\mathcal{N} = \langle P, T, \mathbf{Pre}, \mathbf{Post} \rangle$ where:

- P is a finite set of places;
- T is a finite set of transitions, with $P \cap T = \emptyset$;
- \mathbf{Pre} (resp. \mathbf{Post}), is the backward (resp. forward) $P \times T$ incidence matrix, whose items belong to \mathbb{N} .

The incidence matrix \mathbf{C} is defined by $\mathbf{C} \stackrel{\text{def}}{=} \mathbf{Post} - \mathbf{Pre}$.

Given a place (resp. transition) v in P (resp. in T), its *preset*, $\bullet v$, is defined as the set of its input transitions (resp. places): $\bullet v \stackrel{\text{def}}{=} \{t \in T \mid \mathbf{Post}[v, t] > 0\}$ (resp. $\bullet v \stackrel{\text{def}}{=} \{p \in P \mid \mathbf{Pre}[p, v] > 0\}$). Its *postset* v^\bullet is defined as the set of its output transitions (resp. places): $v^\bullet \stackrel{\text{def}}{=} \{t \in T \mid \mathbf{Pre}[v, t] > 0\}$ (resp. $v^\bullet \stackrel{\text{def}}{=} \{p \in P \mid \mathbf{Post}[p, v] > 0\}$). This notion generalizes to a subset V of places (resp. transitions) by: $\bullet V \stackrel{\text{def}}{=} \bigcup_{v \in V} \bullet v$ and $V^\bullet \stackrel{\text{def}}{=} \bigcup_{v \in V} v^\bullet$. In addition, $\bullet V^\bullet \stackrel{\text{def}}{=} \bullet V \cup V^\bullet$.

Given $T' \subseteq T$, $\mathcal{N}_{T'}$ is the subnet of \mathcal{N} such that its set of transitions is T' and its set of places is $\bullet T'^\bullet$, and its backward and forward incidence matrices are respectively $\mathbf{Pre}_{\bullet T' \times T'}$ and $\mathbf{Post}_{T' \times T'}$.

We define \mathcal{N}^{-1} as the “reverse” net of \mathcal{N} , in which the places and transitions coincide, and its arcs are inverted.

Definition 2 Given a PN $\mathcal{N} = \langle P, T, \mathbf{Pre}, \mathbf{Post} \rangle$, its reverse net \mathcal{N}^{-1} is defined by $\mathcal{N}^{-1} \stackrel{\text{def}}{=} \langle P, T, \mathbf{Post}, \mathbf{Pre} \rangle$.

A *continuous* PN system consists of a net and a non negative real marking.

Definition 3 A CPN system is a tuple $\langle \mathcal{N}, \mathbf{m}_0 \rangle$ where \mathcal{N} is a PN and $\mathbf{m}_0 \in \mathbb{R}_{\geq 0}^P$ is the initial marking.

When a CPN system is an input of a decision problem, the items of \mathbf{m}_0 are rational numbers in order to characterise the complexity of the problem.

In discrete PNs the firing rule of a transition requires tokens specified by \mathbf{Pre} to be present in the corresponding places. In continuous PNs a non negative real *amount* of transition firing is allowed and this amount scales the requirement expressed by \mathbf{Pre} and \mathbf{Post} .

Definition 4 Let \mathcal{N} be a CPN, t be a transition and $\mathbf{m} \in \mathbb{R}_{\geq 0}^P$ be a marking.

- The enabling degree of t w.r.t. \mathbf{m} , $\text{enab}(t, \mathbf{m}) \in \mathbb{R}_{\geq 0} \cup \infty$, is defined by:

$$\text{enab}(t, \mathbf{m}) \stackrel{\text{def}}{=} \min\left\{\frac{\mathbf{m}[p]}{\text{Pre}[p,t]} \mid p \in \bullet t\right\} \quad (\text{enab}(t, \mathbf{m}) = \infty \text{ iff } \bullet t = \emptyset).$$
- t is enabled in \mathbf{m} if $\text{enab}(t, \mathbf{m}) > 0$.
- t can be fired by any amount $\alpha \in \mathbb{R}$ such that³ $0 \leq \alpha \leq \text{enab}(t, \mathbf{m})$, and its firing leads to marking \mathbf{m}' defined by: for all $p \in P$, $\mathbf{m}'[p] = \mathbf{m}[p] + \alpha C[p, t]$.

The firing of t from \mathbf{m} by an amount α leading to \mathbf{m}' is denoted as $\mathbf{m} \xrightarrow{\alpha t} \mathbf{m}'$. We illustrate the firing rule of a CPN with the system in Fig. 1(a) (example taken from [9]). In the initial marking $\mathbf{m}_0 = (1, 0, 1, 0)$, only transition t_1 is enabled and its enabling degree is 1. Hence, it can be fired by any real amount α s.t. $0 \leq \alpha \leq 1$. If t_1 is fired by an amount of 0.5, marking $\mathbf{m}_1 = (0.5, 0.5, 1, 0)$ is reached. In \mathbf{m}_1 , transitions t_1 and t_2 are enabled, with enabling degree both equal to 0.5.

Let $\sigma = \alpha_1 t_1 \dots \alpha_n t_n$ be a finite sequence with for all i , $t_i \in T$ and $\alpha_i \in \mathbb{R}_{\geq 0}$. σ is fireable from \mathbf{m}_0 if for all $1 \leq i \leq n$ there exist \mathbf{m}_i such that $\mathbf{m}_{i-1} \xrightarrow{\alpha_i t_i} \mathbf{m}_i$. This firing is denoted by $\mathbf{m}_0 \xrightarrow{\sigma} \mathbf{m}_n$. When the destination marking is irrelevant we omit it and simply write $\mathbf{m}_0 \xrightarrow{\sigma}$. Let $\sigma = \alpha_1 t_1 \dots \alpha_n t_n \dots$ be an infinite sequence then σ is fireable from \mathbf{m}_0 if for all n , $\alpha_1 t_1 \dots \alpha_n t_n$ is fireable from \mathbf{m}_0 . This firing is denoted as $\mathbf{m}_0 \xrightarrow{\sigma} \infty$.

Given a finite or infinite sequence $\sigma = \alpha_1 t_1 \dots \alpha_i t_i \dots$ and $\alpha \in \mathbb{R}_{\geq 0}$, the sequence $\alpha\sigma$ is defined by $\alpha\sigma \stackrel{\text{def}}{=} \alpha\alpha_1 t_1 \dots \alpha\alpha_i t_i \dots$. Given two infinite sequences $\sigma = \alpha_1 t_1 \dots \alpha_i t_i \dots$ and $\sigma' = \alpha'_1 t'_1 \dots \alpha'_i t'_i \dots$, the (non commutative) sum $\sigma + \sigma'$ is defined by: $\sigma + \sigma' \stackrel{\text{def}}{=} \alpha_1 t_1 \alpha'_1 t'_1 \dots \alpha_i t_i \alpha'_i t'_i \dots$. This notion generalises to arbitrary sequences by extending them to infinite sequences with null amounts of firings (the selected transitions are irrelevant).

Let $\sigma = \alpha_1 t_1 \dots \alpha_n t_n$ be a finite sequence and denote $\sigma^{-1} = \alpha_n t_n \dots \alpha_1 t_1$. By definition of the reverse net, $\mathbf{m} \xrightarrow{\sigma} \mathbf{m}'$ in \mathcal{N} iff $\mathbf{m}' \xrightarrow{\sigma^{-1}} \mathbf{m}$ in \mathcal{N}^{-1} .

The Parikh image (also called firing count vector) of a (finite or infinite) firing sequence $\sigma = \alpha_1 t_1 \dots \alpha_n t_n \dots$ denoted $\vec{\sigma} \in (\mathbb{R}_{\geq 0} \cup \{\infty\})^T$ is defined by: $\vec{\sigma}[t] \stackrel{\text{def}}{=} \sum_{i|t_i=t} \alpha_i$. As in discrete PNs, when $\mathbf{m} \xrightarrow{\sigma} \mathbf{m}'$, $\mathbf{m}' = \mathbf{m} + C\vec{\sigma}$ and this equation is called the *state equation*.

A set of places P' is a *siphon* if $\bullet P' \subseteq P'^{\bullet}$. When a siphon does not contain tokens in some marking, it will never contain tokens after any firing sequence starting from this marking. One call it an *empty siphon*.

An interesting difference between discrete and continuous PN systems is that the sequence of markings visited by an infinite firing sequence may converge to a given marking. For example, let us consider again the CPN of Fig. 1(a), and the marking $\mathbf{m}_1 = (0.5, 0.5, 1, 0)$. From \mathbf{m}_1 , $0.5t_2$ can be fired, reaching $\mathbf{m}_2 = (0.5, 0.5, 0, 0.5)$. From \mathbf{m}_2 transition t_3 can be fired by an amount of 0.5,

³ So from every marking, any (even disabled) transition can fire by a null amount without modifying the marking.

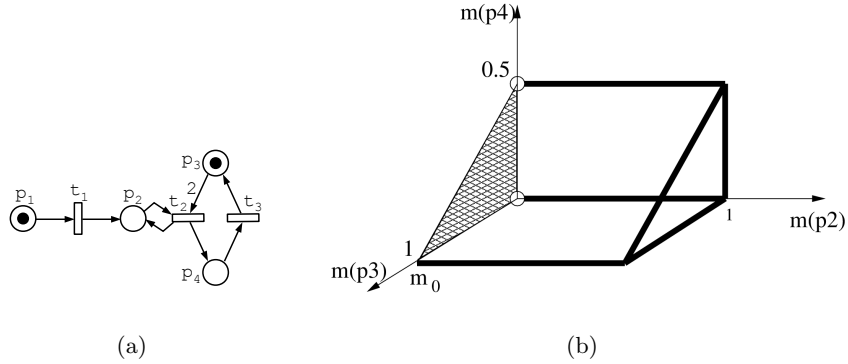

Fig. 1. (a) A CPN system (b) its lim-reachability set [9]

leading to $\mathbf{m}_3 = (0.5, 0.5, 0.25, 0)$. Iterating this process leads to the infinite firing sequence $\sigma = 2^{-1}t_22^{-1}t_3 \dots 2^{-n}t_22^{-n}t_3 \dots$ whose visited markings converge toward $(0.5, 0.5, 0, 0)$. Observe that the Parikh image $\vec{\sigma} = \vec{t}_2 + \vec{t}_3$ does not correspond to any finite firing sequence starting from \mathbf{m}_1 .

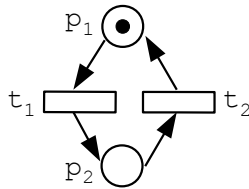

Fig. 2. A simple CPN system.

Consider now the PN in Fig. 2 with initial marking $\mathbf{m}_0 = (1, 0)$. Let $\sigma = 1t_1\frac{1}{2}t_2\frac{1}{3}t_1\frac{1}{4}t_2 \dots \frac{1}{2^i-1}t_1\frac{1}{2^i}t_2 \dots$. The sequence σ is infinite and its sequence of visited markings converges toward marking \mathbf{m} defined by: $\mathbf{m} \stackrel{\text{def}}{=} (1 - \log(2), \log(2))$. Here $\vec{\sigma} = \infty\vec{t}_1 + \infty\vec{t}_2$.

Let σ be an infinite firing sequence starting from \mathbf{m} whose sequence of visited markings converges toward \mathbf{m}' , one says that \mathbf{m}' is *limit reachable* from \mathbf{m} which

is denoted by: $\mathbf{m} \xrightarrow{\sigma}_{\infty} \mathbf{m}'$. Thus in CPNs, two sets of reachable markings are defined.

Definition 5 Given a CPN system $\langle \mathcal{N}, \mathbf{m}_0 \rangle$,

- Its reachability set $\text{RS}(\mathcal{N}, \mathbf{m}_0)$ is defined by:
 $\text{RS}(\mathcal{N}, \mathbf{m}_0) \stackrel{\text{def}}{=} \{\mathbf{m} \mid \text{there exists a finite sequence } \mathbf{m}_0 \xrightarrow{\sigma} \mathbf{m}\}.$
- Its lim-reachability set, $\text{lim-RS}(\mathcal{N}, \mathbf{m}_0)$, is defined by:
 $\text{lim-RS}(\mathcal{N}, \mathbf{m}_0) \stackrel{\text{def}}{=} \{\mathbf{m} \mid \text{there exists an infinite sequence } \mathbf{m}_0 \xrightarrow{\sigma}_{\infty} \mathbf{m}\}.$

RS or lim-RS are convex sets (see Section 3) but not necessarily topologically closed. In Fig. 1, marking $\mathbf{m} = (1, 0, 0, 0)$ belongs to the closure of RS or lim-RS, but it does not belong to these sets. Since an infinite sequence can include null amounts of firings, $\text{RS}(\mathcal{N}, \mathbf{m}_0) \subseteq \text{lim-RS}(\mathcal{N}, \mathbf{m}_0)$. More interestingly, for all $\mathbf{m} \in \text{lim-RS}(\mathcal{N}, \mathbf{m}_0)$, $\text{lim-RS}(\mathcal{N}, \mathbf{m}) \subseteq \text{lim-RS}(\mathcal{N}, \mathbf{m}_0)$ (see the proof in appendix). So there is no need to consider iterations of lim-reachability.

2.2 CPN properties

Here we introduce the standard properties that a modeller wants to check on a net. In the framework of CPNs, every property is defined either w.r.t. to the reachability set or w.r.t. to the lim-reachability set.

Reachability is the main property as it is the core of safeness properties.

Definition 6 (reachability) Given a system $\langle \mathcal{N}, \mathbf{m}_0 \rangle$ and a marking \mathbf{m} , \mathbf{m} is (lim-)reachable in $\langle \mathcal{N}, \mathbf{m}_0 \rangle$ if $\mathbf{m} \in (\text{lim-})\text{RS}(\mathcal{N}, \mathbf{m}_0)$.

Boundedness is often related to the resources needed by the system. For CPN, boundedness and lim-boundedness coincide [13].

Definition 7 (boundedness) A system $\langle \mathcal{N}, \mathbf{m}_0 \rangle$ is (lim-)bounded if there exists $b \in \mathbb{R}_{\geq 0}$ such that for all $\mathbf{m} \in (\text{lim-})\text{RS}(\mathcal{N}, \mathbf{m}_0)$ and all $p \in P$, $\mathbf{m}[p] \leq b$.

Deadlock-freeness ensures that a system will never reach a marking where no transition is enabled, i.e a *dead marking*.

Definition 8 (deadlock-freeness) A system $\langle \mathcal{N}, \mathbf{m}_0 \rangle$ is (lim-)deadlock-free if for all $\mathbf{m} \in (\text{lim-})\text{RS}(\mathcal{N}, \mathbf{m}_0)$, there exists $t \in T$ such that t is enabled at \mathbf{m} .

The net of Fig. 1 is deadlock-free but not lim-deadlock-free: $\mathbf{m} \stackrel{\text{def}}{=} (0, 1, 0, 0)$ is a *dead marking* which is limit-reachable but not reachable and no reachable marking is dead.

Liveness ensures that whatever the reachable state, any transition will be fireable in some future. So the system never “loses its capacities”.

Definition 9 (liveness) A system $\langle \mathcal{N}, \mathbf{m}_0 \rangle$ is (lim-)live if for all transition t and for all marking $\mathbf{m} \in (\text{lim-})\text{RS}(\mathcal{N}, \mathbf{m}_0)$ there exists $\mathbf{m}' \in (\text{lim-})\text{RS}(\mathcal{N}, \mathbf{m})$ such that t is enabled at \mathbf{m}' .

The net of Fig. 1 is neither live nor lim-live: once t_1 becomes disabled, it will remain so whatever the finite or infinite firing sequence considered.

A home state is a marking that can be reached whatever the current state. This property can express for instance that recovering from faults is always possible. A net is *reversible* if its initial marking is an home state. Both properties are particular cases of the reachability set inclusion problem.

Definition 10 (reachability set inclusion)

Given systems $\langle \mathcal{N}, \mathbf{m}_0 \rangle$ and $\langle \mathcal{N}', \mathbf{m}'_0 \rangle$ with $P = P'$, $\langle \mathcal{N}, \mathbf{m}_0 \rangle$ is (lim-)reachable included in $\langle \mathcal{N}', \mathbf{m}'_0 \rangle$ if $(\text{lim-})\text{RS}(\mathcal{N}, \mathbf{m}_0) \subseteq (\text{lim-})\text{RS}(\mathcal{N}', \mathbf{m}'_0)$.

A marking \mathbf{m} is a home state if $\text{RS}(\mathcal{N}, \mathbf{m}_0) \subseteq \text{RS}(\mathcal{N}^{-1}, \mathbf{m})$.

When $\mathbf{m} = \mathbf{m}_0$, one says that $\langle \mathcal{N}, \mathbf{m}_0 \rangle$ is reversible.

The following table summarises the results already known about the complexity of the associated decision problems. A net is *consistent* if there exists a vector $\mathbf{v} \in \mathbb{R}_{\geq 0}$ with $\llbracket v \rrbracket = T$ and $C\mathbf{v} = 0$. No lower bounds have been established.

Table 1. Complexity bounds: previous results

Problems	Upper bounds
(lim-)reachability	in EXPTIME [9] in PTIME for lim-reachability when all transitions are fireable at least once and the net is consistent [13]
(lim-)boundedness	in PTIME when all transitions are fireable at least once [13]
(lim-)deadlock-freeness	in coNP [12]
(lim-)liveness	in coNP [12]
(lim-)reachability set inclusion	no result

3 Properties characterisations

3.1 Preliminary results about reachability and firing sequences

Most of the results of this subsection are generalisations of results given in [13, 9].

The following lemma is an almost immediate consequence of firing definition and has for corollary the convexity of the (lim-)reachability set. In this lemma depending on the sequences $\rightarrow_{(\infty)}$ denotes either \rightarrow or \rightarrow_{∞} .

Lemma 11 Given a CPN system $\langle \mathcal{N}, \mathbf{m}_0 \rangle$, (finite or infinite) sequences $\sigma, \sigma_1, \sigma_2$ markings $\mathbf{m}, \mathbf{m}', \mathbf{m}_1, \mathbf{m}_2, \mathbf{m}'_1, \mathbf{m}'_2$ and $\alpha, \alpha_1, \alpha_2 \in \mathbb{R}_{>0}$:

- (0) $\mathbf{m}_1 \xrightarrow{\sigma} \mathbf{m}'_1$ and $\mathbf{m}_1 \leq \mathbf{m}_2$ implies $\mathbf{m}_2 \xrightarrow{\sigma} \mathbf{m}'_2$ with $\mathbf{m}'_1 \leq \mathbf{m}'_2$
- (1) $\mathbf{m} \xrightarrow{\sigma}_{(\infty)} \mathbf{m}$ iff $\alpha \mathbf{m} \xrightarrow{\alpha \sigma}_{(\infty)} \alpha \mathbf{m}'$
- (2) $\mathbf{m} \xrightarrow{\sigma}_{\infty}$ iff $\alpha \mathbf{m} \xrightarrow{\alpha \sigma}_{\infty}$
- (3) $\mathbf{m}_1 \xrightarrow{\sigma_1}_{(\infty)} \mathbf{m}'_1$ and $\mathbf{m}_2 \xrightarrow{\sigma_2}_{(\infty)} \mathbf{m}'_2$ implies $\mathbf{m}_1 + \mathbf{m}_2 \xrightarrow{\sigma_1 + \sigma_2}_{(\infty)} \mathbf{m}'_1 + \mathbf{m}'_2$
- (4) $\mathbf{m}_1 \xrightarrow{\sigma_1}_{\infty}$ and $\mathbf{m}_2 \xrightarrow{\sigma_2}_{\infty}$ implies $\mathbf{m}_1 + \mathbf{m}_2 \xrightarrow{\sigma_1 + \sigma_2}_{\infty}$
- (5) $\mathbf{m}_1 \xrightarrow{\alpha_1 \sigma}_{(\infty)} \mathbf{m}'_1$ and $\mathbf{m}_2 \xrightarrow{\alpha_2 \sigma}_{(\infty)} \mathbf{m}'_2$ implies $\mathbf{m}_1 + \mathbf{m}_2 \xrightarrow{(\alpha_1 + \alpha_2) \sigma}_{(\infty)} \mathbf{m}'_1 + \mathbf{m}'_2$
- (6) $\mathbf{m}_1 \xrightarrow{\alpha_1 \sigma}_{\infty}$ and $\mathbf{m}_2 \xrightarrow{\alpha_2 \sigma}_{\infty}$ implies $\mathbf{m}_1 + \mathbf{m}_2 \xrightarrow{(\alpha_1 + \alpha_2) \sigma}_{\infty}$

The two next lemmas constitute a first step for the characterisation of reachability since they provide sufficient conditions for reachability and lim-reachability in particular cases.

Lemma 12 Let $\langle \mathcal{N}, \mathbf{m}_0 \rangle$ be a continuous system, \mathbf{m} be a marking and $\mathbf{v} \in \mathbb{R}_{\geq 0}^T$ that fulfill:

- $\mathbf{m} = \mathbf{m}_0 + \mathbf{C}\mathbf{v}$;
- $\forall p \in \bullet[\mathbf{v}] \mathbf{m}_0[p] > 0$;
- $\forall p \in [\mathbf{v}]^{\bullet} \mathbf{m}[p] > 0$.

Then there exists a finite sequence σ such that $\mathbf{m}_0 \xrightarrow{\sigma} \mathbf{m}$ and $\vec{\sigma} = \mathbf{v}$.

Proof. Define $\alpha_1 \stackrel{\text{def}}{=} \min(\frac{\mathbf{m}_0[p]}{\sum_{t \in [\mathbf{v}]} \mathbf{Pre}[p,t]\mathbf{v}[t]} \mid p \in \bullet[\mathbf{v}])$

and $\alpha_2 \stackrel{\text{def}}{=} \min(\frac{\mathbf{m}[p]}{\sum_{t \in [\mathbf{v}]} \mathbf{Post}[p,t]\mathbf{v}[t]} \mid p \in [\mathbf{v}]^{\bullet})$ with the convention that $\alpha_1 \stackrel{\text{def}}{=} 1$

(resp. $\alpha_2 \stackrel{\text{def}}{=} 1$) if $\bullet[\mathbf{v}]$ (resp. $[\mathbf{v}]^{\bullet}$) is empty.

Due to the second and the third hypotheses α_1 and α_2 are positive.

Let $n \stackrel{\text{def}}{=} \max(\lceil \frac{1}{\min(\alpha_1, \alpha_2)} \rceil, 2)$.

Denote $[\mathbf{v}] \stackrel{\text{def}}{=} \{t_1, \dots, t_k\}$ and define $\sigma' \stackrel{\text{def}}{=} \frac{\mathbf{v}[t_1]}{n} t_1 \dots \frac{\mathbf{v}[t_k]}{n} t_k$ and $\sigma \stackrel{\text{def}}{=} \sigma'^n$.

We claim that σ is the required firing sequence.

Let us denote $\mathbf{m}_i \stackrel{\text{def}}{=} \mathbf{m}_0 + \frac{i}{n} \mathbf{C}\mathbf{v}$. Thus $\mathbf{m} = \mathbf{m}_n$.

By definition of α_1 and n , in \mathcal{N} $\mathbf{m}_0 \xrightarrow{\sigma'} \mathbf{m}_1$ and by definition of α_2 , $\mathbf{m}_n \xrightarrow{\sigma'^{-1}} \mathbf{m}_{n-1}$ in \mathcal{N}^{-1} . So in \mathcal{N} $\mathbf{m}_{n-1} \xrightarrow{\sigma'} \mathbf{m}_n$.

Let $1 < i < n - 1$.

Using lemma 11, $\frac{n-1-i}{n-1} \mathbf{m}_0 \xrightarrow{\frac{n-1-i}{n-1} \sigma'} \frac{n-1-i}{n-1} \mathbf{m}_1$ and $\frac{i}{n-1} \mathbf{m}_{n-1} \xrightarrow{\frac{i}{n-1} \sigma'} \frac{i}{n-1} \mathbf{m}_n$.

Using lemma 11 again and summing, one gets: $\mathbf{m} = \mathbf{m}_i \xrightarrow{\sigma'} \mathbf{m}_{i+1}$. ■

Lemma 13 Let $\langle \mathcal{N}, \mathbf{m}_0 \rangle$ be a continuous system, \mathbf{m} be a marking and $\mathbf{v} \in \mathbb{R}_{\geq 0}^T$ that fulfill:

- $\mathbf{m} = \mathbf{m}_0 + \mathbf{C}\mathbf{v}$;
- $\forall p \in \bullet[\mathbf{v}]^{\bullet} \mathbf{m}_0[p] > 0$.

Then there exists an infinite sequence σ such that $\mathbf{m}_0 \xrightarrow{\sigma}_{\infty} \mathbf{m}$ and $\vec{\sigma} = \mathbf{v}$.

Proof. Let \mathbf{m}_i be inductively defined by $\mathbf{m}_{i+1} = \frac{1}{2}\mathbf{m}_i + \frac{1}{2}\mathbf{m}$. and for $i \geq 1$, let $\mathbf{v}_i = \frac{1}{2^i}\mathbf{v}$ (thus $\llbracket \mathbf{v}_i \rrbracket = \llbracket \mathbf{v} \rrbracket$). Observe that $\mathbf{m}_i = \frac{1}{2^i}\mathbf{m}_0 + (1 - \frac{1}{2^i})\mathbf{m}$. So:

- $\mathbf{m}_{i+1} = \mathbf{m}_i + \mathbf{C}\mathbf{v}_i$;
- $\forall p \in \bullet \llbracket \mathbf{v}_i \rrbracket \bullet \mathbf{m}_i[p] > 0$ and $\mathbf{m}_{i+1}[p] > 0$.

Applying lemma 12, for all $i \geq 1$ there exists σ_i such that $\mathbf{m}_i \xrightarrow{\sigma_i} \mathbf{m}_{i+1}$. Since $\lim_{i \rightarrow \infty} \mathbf{m}_i = \mathbf{m}$, the sequence $\sigma = \sigma_1\sigma_2 \dots$ is the required sequence. ■

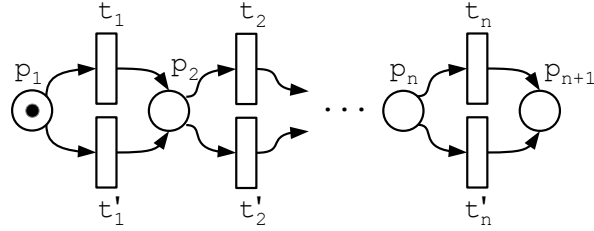

Fig. 3. a CPN system with an exponentially sized firing set.

The key concept in order to get characterisation of properties, is the notion of *firing set* of a CPN system [9].

Definition 14 Let $\langle \mathcal{N}, \mathbf{m}_0 \rangle$ be a CPN system. Then its firing set $FS(\mathcal{N}, \mathbf{m}_0) \subseteq 2^T$ is defined by:

$$FS(\mathcal{N}, \mathbf{m}_0) = \{ \llbracket \vec{\sigma} \rrbracket \mid \mathbf{m}_0 \xrightarrow{\sigma} \}$$

Due to the empty sequence, $\emptyset \in FS(\mathcal{N}, \mathbf{m}_0)$. The size of a firing set may be exponential w.r.t. the number of transitions of the net. For example, consider the CPN system of Fig. 3. Its firing set is:

$$\{ T' \mid \forall 1 \leq j < i \leq n \{t_i, t'_i\} \cap T' \neq \emptyset \Rightarrow \{t_j, t'_j\} \neq \emptyset \}$$

Thus its size is at least $2^{\frac{|T|}{2}}$.

The next two lemmas establish elementary properties of the firing set and leads to new notions.

Lemma 15 Let \mathcal{N} be a CPN and \mathbf{m}, \mathbf{m}' be two markings such that $\llbracket \mathbf{m} \rrbracket = \llbracket \mathbf{m}' \rrbracket$. Then $FS(\mathcal{N}, \mathbf{m}) = FS(\mathcal{N}, \mathbf{m}')$.

Proof. Since $\llbracket \mathbf{m} \rrbracket = \llbracket \mathbf{m}' \rrbracket$, there exists $\alpha > 0$ such that $\alpha \mathbf{m} \leq \mathbf{m}'$.
Let $\mathbf{m} \xrightarrow{\sigma}$. Using lemma 11 $\alpha \mathbf{m} \xrightarrow{\alpha \sigma}$. Since $\alpha \mathbf{m} \leq \mathbf{m}'$, $\mathbf{m}' \xrightarrow{\alpha \sigma}$.
Thus $FS(\mathcal{N}, \mathbf{m}) \subseteq FS(\mathcal{N}, \mathbf{m}')$. By symmetry, $FS(\mathcal{N}, \mathbf{m}) = FS(\mathcal{N}, \mathbf{m}')$. ■

So given $P' \subseteq P$, without ambiguity we define $FS(\mathcal{N}, P')$ by:

$$FS(\mathcal{N}, P') \stackrel{\text{def}}{=} FS(\mathcal{N}, \mathbf{m}) \text{ for any } \mathbf{m} \text{ such that } P' = \llbracket \mathbf{m} \rrbracket$$

Lemma 16 *Let $\langle \mathcal{N}, \mathbf{m}_0 \rangle$ be a CPN system. Then $FS(\mathcal{N}, \mathbf{m}_0)$ is closed by union.*

Proof. Let $\mathbf{m}_0 \xrightarrow{\sigma}$ and $\mathbf{m}_0 \xrightarrow{\sigma'}$.

Then using three times lemma 11, $0.5\mathbf{m}_0 \xrightarrow{0.5\sigma}$, $0.5\mathbf{m}_0 \xrightarrow{0.5\sigma'}$ and $\mathbf{m}_0 \xrightarrow{0.5\sigma+0.5\sigma'}$.
Since $\llbracket 0.5\sigma + 0.5\sigma' \rrbracket = \llbracket \sigma \rrbracket \cup \llbracket \sigma' \rrbracket$, the conclusion follows. ■

Notation. We denote $\max FS(\mathcal{N}, \mathbf{m}_0)$ the maximal set of $FS(\mathcal{N}, \mathbf{m}_0)$ that is the union of all members of $FS(\mathcal{N}, \mathbf{m}_0)$.

The next proposition is a structural characterisation for a subset of transitions to belong to the firing set. In addition, it shows that in the positive case, a “useful” corresponding sequence always exists and furthermore one may build this sequence in polynomial time.

Proposition 17 *Let $\langle \mathcal{N}, \mathbf{m}_0 \rangle$ be a CPN system and T' be a subset of transitions. Then:*

$$T' \in FS(\mathcal{N}, \mathbf{m}_0) \text{ iff } \mathcal{N}_{T'} \text{ has no empty siphon in } \mathbf{m}_0.$$

Furthermore if $T' \in FS(\mathcal{N}, \mathbf{m}_0)$ then there exists $\sigma = \alpha_1 t_1 \dots \alpha_k t_k$ with $\alpha_i > 0$ for all i , $T' = \{t_1, \dots, t_k\}$ and a marking \mathbf{m} such that:

- $\mathbf{m}_0 \xrightarrow{\sigma} \mathbf{m}$;
- for all place p , $\mathbf{m}(p) > 0$ iff $\mathbf{m}_0(p) > 0$ or $p \in \bullet T' \bullet$.

Proof.

Necessity. Suppose $\mathcal{N}_{T'}$ contains an empty siphon Σ in \mathbf{m}_0 . Then none of the transitions belonging to Σ^\bullet can be fired in the future. Since $\mathcal{N}_{T'}$ does not contain isolated places $\Sigma^\bullet (= \bullet \Sigma^\bullet) \neq \emptyset$ and so $T' \notin FS(\mathcal{N}, \mathbf{m}_0)$.

Sufficiency. Suppose that $\mathcal{N}_{T'}$ has no empty siphon in \mathbf{m}_0 . We build by induction the sequence σ of the proposition. More precisely, we inductively prove for increasing values of i that:

- for every $j < i$ there exists a non empty set of transitions $T_j \subseteq T'$ that fulfill for all $j \neq j'$, $T_j \cap T_{j'} = \emptyset$;
- for every $j \leq i$ there exists a marking \mathbf{m}_j with $\mathbf{m}_j(p) > 0$ iff $\mathbf{m}_0(p) > 0$ or $p \in \bullet T_k \bullet$ for some $k < j$;
- for every $j < i$ there exists a sequence $\sigma_j = \alpha_{j,1} t_{j,1} \dots \alpha_{j,k_j} t_{j,k_j}$ with $T_j = \{t_{j,1} \dots t_{j,k_j}\}$ and $\mathbf{m}_j \xrightarrow{\sigma_j} \mathbf{m}_{j+1}$.

There is nothing to prove for the basis case $i = 0$.

Suppose that the assertion holds until i . If $T' = T_1 \cup \dots \cup T_{i-1}$ then we are done. Otherwise define $T'' = T' \setminus (T_1 \cup \dots \cup T_{i-1})$ and $T_i = \{t \text{ enabled in } \mathbf{m}_i \mid t \in T''\}$. We claim that T_i is not empty. Otherwise for all $t \in T''$, there exists

an empty place p_t in \mathbf{m}_i . Due to the inductive hypothesis, $\mathbf{m}_0(p_t) = 0$ and $\bullet p_t \cap (T_1 \cup \dots \cup T_{i-1}) = \emptyset$. So the union of places p_t is an empty siphon of $\langle \mathcal{N}_{T'}, \mathbf{m}_0 \rangle$ which contradicts our hypothesis.

Let us denote $T_i = \{t_{i,1} \dots t_{i,k_i}\}$. Define $\alpha = \min(\frac{m_i(p)}{2k_i} \mid p \in \bullet T_i)$ with the convention that $\alpha = 1$ if $\bullet T_i = \emptyset$. The sequence $\sigma_i = \alpha t_{i,1} \dots \alpha t_{i,k_i}$ is fireable from \mathbf{m}_i and leads to a marking \mathbf{m}_{i+1} fulfilling the inductive hypothesis.

Since T'' is finite the procedure terminates. \blacksquare

Algorithm 1: Decision algorithm for membership of $FS(\mathcal{N}, \mathbf{m}_0)$

Fireable($\langle \mathcal{N}, \mathbf{m}_0 \rangle, T'$): status
Input: a CPN system $\langle \mathcal{N}, \mathbf{m}_0 \rangle$, a subset of transitions T'
Output: the membership status of T' w.r.t. $FS(\mathcal{N}, \mathbf{m}_0)$
Output: in the negative case the maximal firing set included in T'
Data: *new*: boolean; P' : subset of places; T'' : subset of transitions

```

1  $T'' \leftarrow \emptyset$ ;  $P' \leftarrow \llbracket \mathbf{m}_0 \rrbracket$ 
2 while  $T'' \neq T'$  do
3   new  $\leftarrow$  false
4   for  $t \in T' \setminus T''$  do
5     if  $\bullet t \subseteq P'$  then  $T'' \leftarrow T'' \cup \{t\}$ ;  $P' \leftarrow P' \cup t^\bullet$ ; new  $\leftarrow$  true
6   end
7   if not new then return (false,  $T''$ )
8 end
9 return true

```

We include the complexity result below since its proof relies in a straightforward manner on the sufficiency proof of the previous proposition.

Corollary 18 *Let $\langle \mathcal{N}, \mathbf{m}_0 \rangle$ be a CPN system and T' be a subset of transitions. Then algorithm 1 checks in polynomial time whether $T' \in FS(\mathcal{N}, \mathbf{m}_0)$ and in the negative case returns the maximal firing set included in T' (when called with $T = T'$, it returns $\maxFS(\mathcal{N}, \mathbf{m}_0)$).*

3.2 Characterisation of reachability and boundedness

In [9] a characterisation of reachability was presented. The theorem below is an alternative characterisation that only relies on the state equation and firing sets.

Theorem 19 *Let $\langle \mathcal{N}, \mathbf{m}_0 \rangle$ be a CPN system and \mathbf{m} be a marking. Then $\mathbf{m} \in RS(\mathcal{N}, \mathbf{m}_0)$ iff there exists $\mathbf{v} \in \mathbb{R}_{\geq 0}^{|T|}$ such that:*

1. $\mathbf{m} = \mathbf{m}_0 + C\mathbf{v}$
2. $\llbracket \mathbf{v} \rrbracket \in FS(\mathcal{N}, \mathbf{m}_0)$
3. $\llbracket \mathbf{v} \rrbracket \in FS(\mathcal{N}^{-1}, \mathbf{m})$

Proof.

Necessity. Let $\mathbf{m} \in \text{RS}(\mathcal{N}, \mathbf{m}_0)$. So there exists a finite firing sequence σ such that $\mathbf{m}_0 \xrightarrow{\sigma} \mathbf{m}$. Let $\mathbf{v} = \vec{\sigma}$, then $\mathbf{m} = \mathbf{m}_0 + \mathbf{C}\mathbf{v}$.

Since σ is fireable from \mathbf{m}_0 in \mathcal{N} , $\llbracket \mathbf{v} \rrbracket \in FS(\mathcal{N}, \mathbf{m}_0)$. In \mathcal{N}^{-1} , $\mathbf{m} \xrightarrow{\sigma^{-1}} \mathbf{m}_0$. Since $\mathbf{v} = \vec{\sigma^{-1}}$, $\llbracket \mathbf{v} \rrbracket \in FS(\mathcal{N}^{-1}, \mathbf{m})$.

Sufficiency. Since $\llbracket \mathbf{v} \rrbracket \in FS(\mathcal{N}, \mathbf{m}_0)$, using Proposition 17 and Lemma 11 there exists a sequence σ_1 such that $\llbracket \mathbf{v} \rrbracket = \llbracket \vec{\sigma}_1 \rrbracket$, for all $0 < \alpha_1 \leq 1$, $\mathbf{m}_0 \xrightarrow{\alpha_1 \sigma_1} \mathbf{m}_1$ with $\mathbf{m}_1(p) > 0$ for $p \in \bullet \llbracket \mathbf{v} \rrbracket^\bullet$.

Since $\llbracket \mathbf{v} \rrbracket \in FS(\mathcal{N}^{-1}, \mathbf{m})$, using Proposition 17 and Lemma 11 there exists a sequence σ_2 such that $\llbracket \mathbf{v} \rrbracket = \llbracket \vec{\sigma}_2 \rrbracket$, for all $0 < \alpha_2 \leq 1$, $\mathbf{m} \xrightarrow{\alpha_2 \sigma_2} \mathbf{m}_2$ in \mathcal{N}^{-1} with $\mathbf{m}_2(p) > 0$ for $p \in \bullet \llbracket \mathbf{v} \rrbracket^\bullet$.

Choose α_1 and α_2 enough small such that the vector $\mathbf{v}' = \mathbf{v} - \alpha_1 \vec{\sigma}_1 - \alpha_2 \vec{\sigma}_2$ is non negative and $\llbracket \mathbf{v}' \rrbracket = \llbracket \mathbf{v} \rrbracket$. This is possible since $\llbracket \mathbf{v} \rrbracket = \llbracket \vec{\sigma}_1 \rrbracket = \llbracket \vec{\sigma}_2 \rrbracket$.

Since $\mathbf{m}_2 = \mathbf{m}_1 + \mathbf{C}\mathbf{v}'$ and $\mathbf{m}_1, \mathbf{m}_2$ fulfill the hypotheses of Lemma 12, there exists a sequence σ_3 such that $\mathbf{v}' = \vec{\sigma}_3$ and $\mathbf{m}_1 \xrightarrow{\sigma_3} \mathbf{m}_2$.

Let $\sigma = (\alpha_1 \sigma_1) \sigma_3 (\alpha_2 \sigma_2)^{-1}$ then $\mathbf{m}_0 \xrightarrow{\sigma} \mathbf{m}$. ■

The following characterisation has been stated in [9]. We include the proof here since in that paper, the proof of necessity was not developed.

Theorem 20 *Let $\langle \mathcal{N}, \mathbf{m}_0 \rangle$ be a CPN system and \mathbf{m} be a marking.*

Then $\mathbf{m} \in \text{lim-RS}(\mathcal{N}, \mathbf{m}_0)$ iff there exists $\mathbf{v} \in \mathbb{R}_{\geq 0}^{|\mathcal{T}|}$ such that:

1. $\mathbf{m} = \mathbf{m}_0 + \mathbf{C}\mathbf{v}$
2. $\llbracket \mathbf{v} \rrbracket \in FS(\mathcal{N}, \mathbf{m}_0)$

Proof.

Necessity. Let $\mathbf{m} \in \text{lim-RS}(\mathcal{N}, \mathbf{m}_0)$. So there exists a firing sequence $\sigma = \alpha_1 t_1 \dots \alpha_n t_n \dots$ such that $\mathbf{m} = \lim_{n \rightarrow \infty} \mathbf{m}_n$, where $\mathbf{m}_n \xrightarrow{\alpha_n + 1 t_n + 1} \mathbf{m}_{n+1}$.

Thus there exists $B \in \mathbb{N}$ such that for all $p \in P$ and all $n \in \mathbb{N}$, $\mathbf{m}_n[p] \leq B$.

Let $T' \stackrel{\text{def}}{=} \{t \mid \exists i \in \mathbb{N} t = t_i\}$. There exists n_0 such that $T' = \{t \mid \exists i \leq n_0 t = t_i\}$ and so $T' \in FS(\mathcal{N}, \mathbf{m}_0)$.

Let $\alpha \in \mathbb{Q}_{>0}$ such that $\alpha \leq \min(\sum_{i \leq n_0, t_i = t} \alpha_i \mid t \in T')$.

Let us define LP_n an existential linear program where $\mathbf{v} \in \mathbb{R}^T$ is the vector of variables by:

1. $\mathbf{m}_n - \mathbf{m}_0 = \mathbf{C}\mathbf{v}$
2. $\forall t \in T' \mathbf{v}[t] \geq \alpha$
3. $\forall t \in T \setminus T' \mathbf{v}[t] = 0$

Due to the existence of the firing sequence σ , for all $n \geq n_0$ LP_n admits a solution. Using linear programming theory (see [11]), since $\mathbf{m}_n[p] \leq B$ for all n and all p , there exists B' such that for all $n \geq n_0$, LP_n admits a solution \mathbf{v}_n whose items are bounded by B' .

So the sequence $\{\mathbf{v}_n\}_{n \geq n_0}$ admits a subsequence that converges to some \mathbf{v} . By continuity, \mathbf{v} fulfills $\mathbf{m} - \mathbf{m}_0 = \mathbf{C}\mathbf{v}, \forall t \in T' \mathbf{v}[t] \geq \alpha$ and $\forall t \in T \setminus T' \mathbf{v}[t] = 0$. So $\llbracket \mathbf{v} \rrbracket = T'$ and \mathbf{v} is the desired vector.

Sufficiency. Since $\llbracket \mathbf{v} \rrbracket \in FS(\mathcal{N}, \mathbf{m}_0)$, using Proposition 17 and Lemma 11 there exists a sequence σ_1 such that $\llbracket \mathbf{v} \rrbracket = \llbracket \vec{\sigma}_1 \rrbracket$, for all $0 < \alpha_1 \leq 1$, $\mathbf{m}_0 \xrightarrow{\alpha_1 \sigma_1} \mathbf{m}_1$ with $\mathbf{m}_1(p) > 0$ for $p \in \bullet \llbracket \mathbf{v} \rrbracket \bullet$.

Choose α_1 enough small such that the vector $\mathbf{v}' = \mathbf{v} - \alpha_1 \vec{\sigma}_1$ is non negative and $\llbracket \mathbf{v}' \rrbracket = \llbracket \mathbf{v} \rrbracket$. This is possible since $\llbracket \mathbf{v} \rrbracket = \llbracket \vec{\sigma}_1 \rrbracket$.

Since $\mathbf{m} = \mathbf{m}_1 + \mathbf{C}\mathbf{v}'$ and \mathbf{m}_1 fulfills the hypotheses of lemma 13, there exists an infinite sequence σ_2 such that $\mathbf{v}' = \vec{\sigma}_2$ and $\mathbf{m}_1 \xrightarrow{\sigma_2} \infty \mathbf{m}$.

Let $\sigma = (\alpha_1 \sigma_1) \sigma_2$ then $\mathbf{m}_0 \xrightarrow{\sigma} \infty \mathbf{m}$. \blacksquare

We present below the first characterisation of boundedness for CPN systems.

Theorem 21 *Given a CPN system $\langle \mathcal{N}, \mathbf{m}_0 \rangle$. Then $\langle \mathcal{N}, \mathbf{m}_0 \rangle$ is unbounded iff: There exists $\mathbf{v} \in \mathbb{R}_{\geq 0}^T$ such that $\mathbf{C}\mathbf{v} \succeq \mathbf{0}$ and $\llbracket \mathbf{v} \rrbracket \subseteq \maxFS(\mathcal{N}, \mathbf{m}_0)$.*

Proof.

Sufficiency. Assume there exists $\mathbf{v} \in \mathbb{R}_{\geq 0}^T$ such that $\mathbf{C}\mathbf{v} \succeq \mathbf{0}$ and $\llbracket \mathbf{v} \rrbracket \subseteq \maxFS(\mathcal{N}, \mathbf{m}_0)$. Denote $T' \stackrel{\text{def}}{=} \maxFS(\mathcal{N}, \mathbf{m}_0)$. Using proposition 17, there exists $\mathbf{m}_1 \in RS(\mathcal{N}, \mathbf{m}_0)$ such that for all $p \in \bullet T' \bullet$, $\mathbf{m}_1(p) > 0$. Define $\mathbf{m}_2 \stackrel{\text{def}}{=} \mathbf{m}_1 + \mathbf{C}\mathbf{v}$, thus $\mathbf{m}_2 \succeq \mathbf{m}_1$. Since $\llbracket \mathbf{v} \rrbracket \subseteq T'$, \mathbf{m}_1 and \mathbf{m}_2 fulfill the hypotheses of lemma 12. Applying it, yields a firing sequence $\mathbf{m}_1 \xrightarrow{\sigma} \mathbf{m}_2$. Iterating this sequence establishes the unboundedness of $\langle \mathcal{N}, \mathbf{m}_0 \rangle$.

Necessity. Assume $\langle \mathcal{N}, \mathbf{m}_0 \rangle$ is unbounded. Then there exists $p \in P$ and a family of firing sequences $\{\sigma_n\}_{n \in \mathbb{N}}$ such that $\mathbf{m}_0 \xrightarrow{\sigma_n} \mathbf{m}_n$ and $\mathbf{m}_n(p) \geq n$. Since $\{\llbracket \vec{\sigma}_n \rrbracket\}_{n \in \mathbb{N}}$ is finite by extracting a subsequence w.l.o.g. we can assume that all these sequences have the same support, say $T' \subseteq \maxFS(\mathcal{N}, \mathbf{m}_0)$.

Let $\mathbf{v}_n \stackrel{\text{def}}{=} \mathbf{C}\vec{\sigma}_n$. Define $\mathbf{w}_n = \frac{\mathbf{v}_n}{\|\mathbf{v}_n\|_1}$. Since $\{\mathbf{w}_n\}_{n \in \mathbb{N}}$ belongs to a compact set, there exists a convergent subsequence $\{\mathbf{w}_{\alpha(n)}\}_{n \in \mathbb{N}}$. Denote \mathbf{w} its limit. Since $\|\mathbf{w}\|_1 = 1$, \mathbf{w} is non null. We claim that \mathbf{w} is a non negative vector. Since $\mathbf{m}_n(p) \geq n$, $\|\mathbf{v}_n\|_1 \geq \mathbf{v}_n[p] \geq n - \mathbf{m}_0[p]$. On the other hand, for all $p' \in P$, $\mathbf{w}_n[p'] \geq \frac{-\mathbf{m}_0[p']}{\|\mathbf{v}_n\|_1}$. Combining the two inequalities, for $n > \mathbf{m}_0[p]$, $\mathbf{w}_n[p'] \geq \frac{-\mathbf{m}_0[p']}{n - \mathbf{m}_0[p]}$. Applying this inequality to $\alpha(n)$ and letting n go to infinity yields $\mathbf{w}[p'] \geq 0$.

Due to standard results of polyhedra theory (see [1] for instance), the set $\{\mathbf{C}_{P \times T'} \mathbf{u} \mid \mathbf{u} \in \mathbb{R}_{\geq 0}^{T'}\}$ is closed. So there exists $\mathbf{u} \in \mathbb{R}_{\geq 0}^{T'}$ such that $\mathbf{w} = \mathbf{C}\mathbf{u}$. Considering \mathbf{u} as a vector of $\mathbb{R}_{\geq 0}^T$ by adding null components for $T \setminus T'$ yields the required vector. \blacksquare

4 Decision procedures

Naively implementing the characterisation of reachability would lead to an exponential procedure since it would require to enumerate the items of $FS(\mathcal{N}, \mathbf{m}_0)$

(whose size is possibly exponential). For each item, say T' , the algorithm would check in polynomial time (1) whether T' belongs to $FS(\mathcal{N}^{-1}, \mathbf{m})$ and (2) whether the associated linear program $\mathbf{v} > \mathbf{0} \wedge \mathbf{C}_{P \times T'} \mathbf{v} = \mathbf{m} - \mathbf{m}_0$ admits a solution. Guessing T' shows that the reachability problem belongs to NP.

Algorithm 2: Decision algorithm for reachability

Reachable($\langle \mathcal{N}, \mathbf{m}_0 \rangle, \mathbf{m}$): status
Input: a CPN system $\langle \mathcal{N}, \mathbf{m}_0 \rangle$, a marking \mathbf{m}
Output: the reachability status of \mathbf{m}
Output: the Parikh image of a witness in the positive case
Data: *nbsol*: integer; *v*, *sol*: vectors; T' : subset of transitions

```

1 if  $\mathbf{m} = \mathbf{m}_0$  then return (true,  $\mathbf{0}$ )
2  $T' \leftarrow T$ 
3 while  $T' \neq \emptyset$  do
4   nbsol  $\leftarrow 0$ ; sol  $\leftarrow \mathbf{0}$ 
5   for  $t \in T'$  do
6     solve  $\exists \mathbf{v} \mathbf{v} \geq \mathbf{0} \wedge \mathbf{v}[t] > 0 \wedge \mathbf{C}_{P \times T'} \mathbf{v} = \mathbf{m} - \mathbf{m}_0$ 
7     if  $\exists \mathbf{v}$  then nbsol  $\leftarrow$  nbsol + 1; sol  $\leftarrow$  sol +  $\mathbf{v}$ 
8   end
9   if nbsol = 0 then return false else sol  $\leftarrow$   $\frac{1}{\text{nbsol}}$  sol
10   $T' \leftarrow \llbracket \mathbf{sol} \rrbracket$ 
11   $T' \leftarrow T' \cap \text{maxFS}(\mathcal{N}_{T'}, \mathbf{m}_0[\bullet T' \bullet])$ 
12   $T' \leftarrow T' \cap \text{maxFS}(\mathcal{N}_{T'}^{-1}, \mathbf{m}[\bullet T' \bullet])$  /* deleted for lim-reachability */
13  if  $T' = \llbracket \mathbf{sol} \rrbracket$  then return (true, sol)
14 end
15 return false

```

In fact, we improve this upper bound with the help of Algorithm 2. When $\mathbf{m} \neq \mathbf{m}_0$, this algorithm maintains a subset of transitions T' which fulfills $\llbracket \vec{\sigma} \rrbracket \subseteq T'$ for any $\mathbf{m}_0 \xrightarrow{\sigma} \mathbf{m}$ (as will be proven in proposition 22). Initially T' is set to T . Then lines 4-9 build a solution to the state equation restricted to transitions of T' with a maximal support (if there is at least one). If there is no solution then the algorithm returns false. Otherwise T' is successively restricted to (1) the support of this maximal solution (line 10), (2) the maximal firing set in $\text{maxFS}(\mathcal{N}_{T'}, \mathbf{m}_0[\bullet T' \bullet])$ (line 11) and, (3) the maximal firing set in $\text{maxFS}(\mathcal{N}_{T'}^{-1}, \mathbf{m}[\bullet T' \bullet])$ (line 12). If the two last restrictions do not modify T' then the algorithm returns true. If T' becomes empty then the algorithm returns false.

Omitting line 12, Algorithm 2 decides the lim-reachability problem.

Proposition 22 *Algorithm 2 returns true iff \mathbf{m} is reachable in $\langle \mathcal{N}, \mathbf{m}_0 \rangle$.
Algorithm 2 without line 12 returns true iff \mathbf{m} is lim-reachable in $\langle \mathcal{N}, \mathbf{m}_0 \rangle$.*

Proof. We only consider the non trivial case $\mathbf{m} \neq \mathbf{m}_0$.

Soundness. Assume that the algorithm returns true at line 13.

By definition, vector *sol* which is a barycenter of solutions is also a solution

with maximal support and so fulfils the first statement of Theorem 19. Since $T' = \llbracket \mathbf{sol} \rrbracket$ at line 13, $\llbracket \mathbf{sol} \rrbracket \in FS(\mathcal{N}, \mathbf{m}_0)$ due to line 11 and $\llbracket \mathbf{sol} \rrbracket \in FS(\mathcal{N}^{-1}, \mathbf{m})$ due to line 12. Thus \mathbf{m} is reachable in $\langle \mathcal{N}, \mathbf{m}_0 \rangle$ since it fulfils the assertions of Theorem 19. In case of lim-reachability, line 12 is omitted. So the assertions of Theorem 20 are fulfilled and \mathbf{m} is lim-reachable in $\langle \mathcal{N}, \mathbf{m}_0 \rangle$.

Completeness. Assume the algorithm returns false.

We claim that at any time the algorithm fulfils the following invariant: for any $\mathbf{m}_0 \xrightarrow{\sigma} \mathbf{m}$, $\llbracket \vec{\sigma} \rrbracket \subseteq T'$.

This invariant initially holds since $T' = T$. At line 10 due to the first assertion of Theorem 19, for any such σ , $\llbracket \vec{\sigma} \rrbracket \subseteq \llbracket \mathbf{sol} \rrbracket$ since \mathbf{sol} is a solution with maximal support. So the assignment of line 10 lets true the invariant. Due to the second assertion of Theorem 19 and the invariant, any σ fulfils $\llbracket \vec{\sigma} \rrbracket \subseteq \maxFS(\mathcal{N}_{T'}, \mathbf{m}_0[\bullet T' \bullet])$. So the assignment of line 11 lets true the invariant. Due to the third assertion of Theorem 19 and the invariant, any σ fulfils $\llbracket \vec{\sigma} \rrbracket \subseteq \maxFS(\mathcal{N}_{T'}^{-1}, \mathbf{m}[\bullet T' \bullet])$. So the assignment of line 12 lets true the invariant.

If the algorithm returns false at line 9 due to the invariant the first assertion of Theorem 19 cannot be satisfied. If the algorithm returns false at line 15 then $T' = \emptyset$. So due to the invariant and since $\mathbf{m} \neq \mathbf{m}_0$, \mathbf{m} is not reachable from \mathbf{m}_0 .

The case of lim-reachability is similarly handled with the following invariant: for any $\mathbf{m}_0 \xrightarrow{\sigma \rightarrow \infty} \mathbf{m}$, $\llbracket \vec{\sigma} \rrbracket \subseteq T'$. ■

Proposition 23 *The reachability and the lim-reachability problems for CPN systems are decidable in polynomial time.*

Proof. Let us analyse the time complexity of Algorithm 2. Since T' must be modified in lines 11 or 12 in order to start a new iteration of the main loop, there are at most $|T|$ iterations of this loop. The number of iterations of the inner loop is also bounded by $|T|$. Finally solving a linear program can be performed in polynomial time [11] as well as computing the maximal item of a firing set (see corollary 18). ■

In [9], it is proven that the lim-reachability problem for consistent CPN systems with no empty siphons in the initial marking is decidable in polynomial time. We improve this result by showing that this problem and a similar one belong to $NC \subseteq PTIME$ (a complexity class of problems that can take advantage of parallel computations, see [10]).

Proposition 24 *The reachability problem for consistent CPN systems with no empty siphons in the initial marking and no empty siphons in the final marking for the reverse net belongs to NC.*

The lim-reachability problem for consistent CPN systems with no empty siphons in the initial marking belongs to NC.

Proof. Due to the assumptions on siphons and proposition 17 only the first assertion of Theorems 19 and 20 needs to be checked. Due to consistency, there exists $\mathbf{w} > \mathbf{0}$ such that $C\mathbf{w} = \mathbf{0}$. Assume there is some $\mathbf{v} \in \mathbb{R}^T$ such that $\mathbf{m} - \mathbf{m}_0 = C\mathbf{v}$. For some $n \in \mathbb{N}$ large enough, $\mathbf{v}' \stackrel{\text{def}}{=} \mathbf{v} + n\mathbf{w} \in \mathbb{R}_{\geq 0}^T$ and still fulfils $\mathbf{m} - \mathbf{m}_0 = C\mathbf{v}'$.

Now the decision problem $\exists? \mathbf{v} \in \mathbb{R}^T \mathbf{m} - \mathbf{m}_0 = \mathbf{C}\mathbf{v}$ belongs to NC [4]. ■

Proposition 25 *The boundedness problem for CPN systems is decidable in polynomial time.*

Proof. Using the characterisation of Theorem 21, one first computes in polynomial time $T' = \max\text{FS}(\mathcal{N}, \mathbf{m}_0)$ (see corollary 18). Then for all $p \in P$, one solves the existential linear program $\exists? \mathbf{v} \geq \mathbf{0} \mathbf{C}_{P \times T'} \mathbf{v} \geq \mathbf{0} \wedge (\mathbf{C}_{P \times T'} \mathbf{v})[p] > 0$. The CPN system is unbounded if some of these linear programs admits a solution. ■

In discrete Petri nets, the reachability set inclusion problem is undecidable, while the restricted problem of home state is decidable (see [7] for a detailed survey about decidability results in PNs). In CPN systems, this problem is decidable thanks to the special structure of the (lim-)reachability sets.

Proposition 26 *The reachability set inclusion and the lim-reachability set inclusion problems for CPN systems are decidable in exponential time.*

Proof. Let us define $TP \stackrel{\text{def}}{=} \{(T', P') \mid T' \in \text{FS}(\mathcal{N}, \mathbf{m}_0) \wedge P' \subseteq P \wedge T' \in \text{FS}(\mathcal{N}^{-1}, P')\}$. For every pair $(T', P') \in TP$, define the polyhedron $E_{T', P'}$ over $\mathbb{R}^P \times \mathbb{R}^{T'}$ by:

$$E_{T', P'} \stackrel{\text{def}}{=} \{(\mathbf{m}, \mathbf{v}) \mid \mathbf{m}[P'] > \mathbf{0} \wedge \mathbf{m}[P \setminus P'] = \mathbf{0} \wedge \mathbf{v} > \mathbf{0} \wedge \mathbf{m} = \mathbf{C}_{P \times T'} \mathbf{v}\}$$

and $R_{T', P'}$ by: $R_{T', P'} \stackrel{\text{def}}{=} \{\mathbf{m} \mid \exists \mathbf{v} (\mathbf{m}, \mathbf{v}) \in E_{T', P'}\}$

Using the characterisation of Theorem 19 and Lemma 15,

$$RS(\mathcal{N}, \mathbf{m}_0) = \bigcup_{(T', P') \in TP} R_{T', P'}.$$

Due to Lemma 11, the reachability set of a CPN system is convex. So $RS(\mathcal{N}, \mathbf{m}_0)$ can be rewritten as:

$$RS(\mathcal{N}, \mathbf{m}_0) = \left\{ \sum_{(T', P') \in TP} \lambda_{T', P'} \mathbf{m}_{T', P'} \mid \sum_{(T', P') \in TP} \lambda_{T', P'} = 1 \wedge \forall (T', P') \in TP \lambda_{T', P'} \geq 0 \wedge \mathbf{m}_{T', P'} \in R_{T', P'} \right\}$$

Observe that this representation is exponential w.r.t. the size of the CPN system.

Let $\langle \mathcal{N}, \mathbf{m}_0 \rangle$ and $\langle \mathcal{N}', \mathbf{m}'_0 \rangle$ be two CPN systems for which one wants to check whether $RS(\mathcal{N}, \mathbf{m}_0) \subseteq RS(\mathcal{N}', \mathbf{m}'_0)$. One builds the representation above for $RS(\mathcal{N}, \mathbf{m}_0)$ and $RS(\mathcal{N}', \mathbf{m}'_0)$. Then one transforms the representation of the set $RS(\mathcal{N}', \mathbf{m}'_0)$ as a system of linear constraints. This can be done in polynomial time w.r.t. the original representation [2]. So the number of constraints is still exponential w.r.t. the size of $\langle \mathcal{N}', \mathbf{m}'_0 \rangle$.

Afterwards for every constraint of this new representation, one adds its negation to the representation of $RS(\mathcal{N}, \mathbf{m}_0)$ and check for a solution of such a system. $RS(\mathcal{N}, \mathbf{m}_0) \not\subseteq RS(\mathcal{N}', \mathbf{m}'_0)$ iff at least one of these linear programs admits a solution. The overall complexity of this procedure is still exponential w.r.t. the size of the problem. The procedure for lim-reachability set inclusion is similar. ■

5 Hardness results

We now provide matching lower bounds for almost all problems analysed in the previous sections.

The proof of this proposition is in the appendix.

Proposition 27 *The reachability, lim-reachability and boundedness problems for CPN systems are PTIME-complete.*

We want to prove that the lower bounds are robust. To this aim, we recall free-choice CPNs.

Definition 28 *A CPN \mathcal{N} is free-choice if:*

- $\forall p \in P \forall t \in T \{ \mathbf{Pre}[p, t], \mathbf{Post}[p, t] \} \subseteq \{0, 1\}$;
- $\forall t, t' \in T \bullet t \cap \bullet t' \neq \emptyset \Rightarrow \bullet t = \bullet t'$.

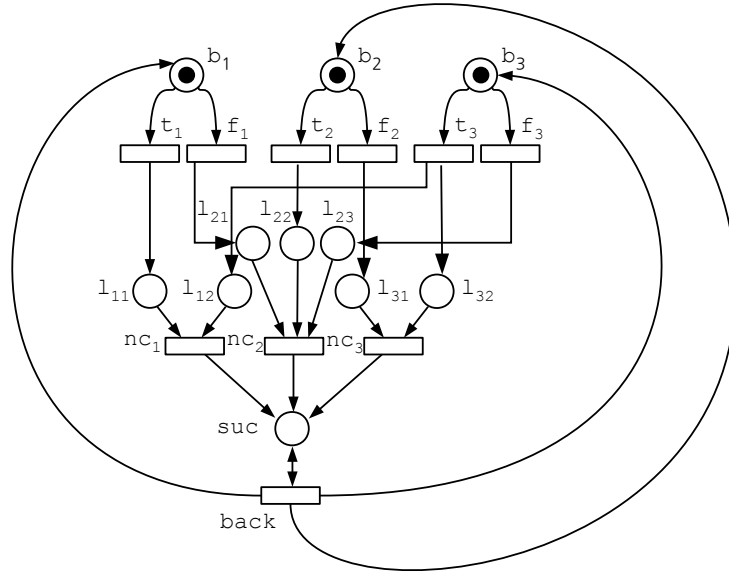

Fig. 4. The CPN corresponding to formula $(\neg x_1 \vee \neg x_3) \wedge (x_1 \vee \neg x_2 \vee x_3) \wedge (x_2 \vee \neg x_3)$.

Proposition 29 *The (lim-)deadlock-freeness and (lim-)liveness problems in free-choice CPN systems are coNP-hard.*

Proof. We use almost the same reduction from the 3SAT problem as the one proposed for free-choice Petri nets in [6]. However the proof of correctness is specific to continuous nets.

Let $\{x_1, x_2, \dots, x_n\}$ denote the set of propositions and $\{c_1, c_2, \dots, c_m\}$ denote the set of clauses. Every clause c_j is defined by $c_j \stackrel{\text{def}}{=} lit_{j1} \vee lit_{j2} \vee lit_{j3}$ where for all j, k , $lit_{jk} \in \{x_1, \dots, x_n, \neg x_1, \dots, \neg x_n\}$. The satisfiability problem consists in the existence of an interpretation $\nu : \{x_1, x_2, \dots, x_n\} \longrightarrow \{\mathbf{false}, \mathbf{true}\}$, such that for all clause c_j , $\nu(c_j) = \mathbf{true}$.

Every proposition x_i yields a place b_i initially marked with a token (all other places are unmarked) and input of two transitions t_i, f_i corresponding to the assignment associated with an interpretation. Every of literal lit_{jk} yields a place l_{jk} which is the output of transition t_i if $lit_{jk} = x_i$ or transition f_i if $lit_{jk} = \neg x_i$. Every clause c_j yields a transition nc_j with three input “literal” places corresponding to literals $\neg lit_{j1}, \neg lit_{j2}, \neg lit_{j3}$. An additional place suc is the output of every transition nc_j . Finally, transition $back$ has suc as a loop place and b_i for all i as output places. The reduction is illustrated in Fig. 4.

Assume that there exists ν such that for all clause c_j , $\nu(c_j) = \mathbf{true}$. Then fire the following sequence $\sigma = 1t_1^* \dots 1t_n^*$ where $t_i^* = t_i$ when $\nu(x_i) = \mathbf{true}$ and $t_i^* = f_i$ when $\nu(x_i) = \mathbf{false}$. Consider \mathbf{m} the reached marking. Since $\nu(c_j) = \mathbf{true}$, at least one input place of nc_j is empty in \mathbf{m} . Moreover $\mathbf{m}(suc) = \mathbf{m}(b_i) = 0$ for all i . So \mathbf{m} is dead.

Assume that there does not exist ν such that for all clause c_j , $\nu(c_j) = \mathbf{true}$. Observe that given a marking \mathbf{m} such that $\mathbf{m}(suc) > 0$ all transitions will be fireable in the future and suc will never decrease (thus $\mathbf{m}(suc) > 0$ for a lim-reachable marking \mathbf{m} as well).

So we only consider reachable marking \mathbf{m} such that $\mathbf{m}(suc) = 0$, i.e. when no transitions nc_j have been fired. Our goal is to prove that from such marking there is a sequence that produces tokens in suc . Examining the remaining transitions, the following invariants hold. For all atomic proposition x_i , and reachable marking \mathbf{m} , one has

$$\forall i \mathbf{m}[b_i] + \sum_{l_{jk} \in \{x_i, \neg x_i\}} \mathbf{m}[l_{jk}] \geq 1$$

$$\forall j, k, j', k' lit_{jk} = lit_{j'k'} \Rightarrow \mathbf{m}[l_{jk}] = \mathbf{m}[l_{j'k'}]$$

If for some i , $\mathbf{m}[b_i] > 0$, we fire t_i in order to empty b_i . Thus the invariants become:

$$\forall i \sum_{l_{jk} \in \{x_i, \neg x_i\}} \mathbf{m}[l_{jk}] \geq 1$$

$$\forall j, k, j', k' lit_{jk} = lit_{j'k'} \Rightarrow \mathbf{m}[l_{jk}] = \mathbf{m}[l_{j'k'}]$$

Now define ν by $\nu(x_i) = \mathbf{true}$ if for some $lit_{jk} = x_i$, $\mathbf{m}(l_{jk}) > 0$. Due to the hypothesis, there is a clause c_j such that $\nu(c_j) = \mathbf{false}$. Due to our choice of ν and the invariants, all inputs of nc_j are marked. So firing nc_j marks suc . ■

We show that even the hypotheses that allow the lim-reachability to belong in NC do not reduce the complexity of other problems. The proof of this proposition is in the appendix.

Proposition 30 *The (lim-)deadlock-freeness, (lim-)liveness and reversibility problems in consistent CPN systems with no initially empty siphons are coNP-hard.*

6 Conclusions

In this work we have analysed the complexity of the most standard problems for continuous Petri nets. For almost all these problems, we have characterised their complexity class by designing new decision procedures and/or providing reductions to complete problems. We have also shown that the reachability set inclusion, undecidable for Petri nets, becomes decidable in the continuous framework. These results are summarised in Table 2.

There are three fruitful possible extensions of this work. Other properties like coverability could be studied. A temporal logic provides a specification language for expressing properties. In Petri nets, the model checking problem lies on the boundary of decidability depending on the type of logics (branching versus linear, propositional versus event-driven). We want to investigate this problem for continuous Petri nets. Hybrid Petri nets encompass both discrete and continuous Petri nets. So it would be interesting to examine the complexity and decidability of standard problems for the whole class or some appropriate subclasses of this formalism.

Table 2. Complexity bounds

Problems	Upper and lower bounds
(lim-)reachability	P _{TIME} -complete in NC for lim-reachability (resp. reachability) when all transitions are fireable at least once (resp. and also in the reverse CPN) and the net is consistent
(lim-)boundedness	P _{TIME} -complete
(lim-)deadlock-freeness and (lim-)liveness	coNP-complete coNP-hard even for free-choice CPNs or for CPNs when all transitions are fireable at least once and the net is consistent
(lim-)reachability set inclusion	in EXPTIME coNP-hard even for reversibility in CPNs when all transitions are fireable at least once and the net is consistent

Acknowledgments. The authors would like to thank Jorge Júlvez and Manuel Silva for fruitful discussions on CPNs.

References

1. D. Avis, K. Fukuda, and S. Picozzi. On canonical representations of convex polyhedra. In A. M. Cohen, X.-S. Gao, and N. Takayama, editors, *Mathematical Software, Proceedings of the First International Congress of Mathematical Software*, pages 350–360. World Scientific Publishing, 2002.
2. R. Bagnara, P. M. Hill, and E. Zaffanella. Not necessarily closed convex polyhedra and the double description method. *Formal Aspects of Computing*, 17(2):222–257, 2005.
3. M. P. Cabasino, C. Seatzu, C. Mahulea, and M. Silva. Fault diagnosis of manufacturing systems using continuous Petri nets. In *Proceedings of the IEEE International Conference on Systems, Man and Cybernetics, Istanbul, Turkey*, pages 534–539. IEEE, 2010.
4. B. Codenotti, M. Leoncini, and F. P. Preparata. The role of arithmetic in fast parallel matrix inversion. *Algorithmica*, 30(4):685–707, 2001.
5. R. David and H. Alla. Continuous Petri nets. In *Proc. of the 8th European Workshop on Application and Theory of Petri Nets*, pages 275–294, Zaragoza, Spain, 1987.
6. J. Desel and J. Esparza. *Free Choice Petri Nets*. Cambridge Tracts in Theoretical Computer Science 40, 1995.
7. J. Esparza and M. Nielsen. Decidability issues for Petri nets - a survey. *Elektronische Informationsverarbeitung und Kybernetik*, 30(3):143–160, 1994.
8. B. Gudiño-Mendoza, E. López-Mellado, and H. Alla. Modeling and simulation of water distribution systems using timed hybrid Petri nets. *Simulation*, 88(3):329–347, 2012.
9. J. Júlvez, L. Recalde, and M. Silva. On reachability in autonomous continuous Petri net systems. In W. van der Aalst and E. Best, editors, *24th Int. Conf. on Application and Theory of Petri Nets*, volume 2679 of *LNCS*, pages 221–240, Eindhoven, The Netherlands, 2003. Springer.
10. C. H. Papadimitriou. *Computational complexity*. Addison-Wesley, Reading, Massachusetts, 1994.
11. C. H. Papadimitriou and K. Steiglitz. *Combinatorial Optimization. Algorithms and Complexity*. Dover publications, second edition, 1998.
12. L. Recalde, S. Haddad, and M. Silva. Continuous Petri nets: Expressive power and decidability issues. *Int. Journal of Foundations of Computer Science*, 21(2):235–256, 2010.
13. L. Recalde, E. Teruel, and M. Silva. Autonomous continuous P/T systems. In J. Kleijn S. Donatelli, editor, *Application and Theory of Petri Nets 1999*, volume 1639 of *LNCS*, pages 107–126, 1999.
14. R. Ross-Leon, A. Ramirez-Trevino, J. A. Morales, and J. Ruiz-Leon. Control of metabolic systems modeled with timed continuous Petri nets. In *ACSD/Petri Nets Workshops*, volume 827 of *CEUR Workshop Proceedings*, pages 87–102, 2010.
15. C. Renato Vázquez, H. Y. Sutarto, R. K. Boel, and M. Silva. Hybrid Petri net model of a traffic intersection in an urban network. In *Proceedings of the IEEE International Conference on Control Applications, CCA 2010*, pages 658–664, Yokohama, Japan, 2010.
16. N. Zerhouni and H. Alla. Dynamic analysis of manufacturing systems using continuous Petri nets. In *Proceedings of the IEEE International Conference on Robotics and Automation, Cincinnati, OH, USA*, volume 2, pages 1070–1075, Los Alamitos, CA, USA, 1990.

A Appendix: additional proofs

Proof.(that for all $\mathbf{m} \in \text{lim-RS}(\mathcal{N}, \mathbf{m}_0)$, $\text{lim-RS}(\mathcal{N}, \mathbf{m}) \subseteq \text{lim-RS}(\mathcal{N}, \mathbf{m}_0)$)
Let $\mathbf{m}' \in \text{lim-RS}(\mathcal{N}, \mathbf{m})$. Due to theorem 20, there exists $\mathbf{v}, \mathbf{v}' \in \mathbb{R}_{\geq 0}^{|\mathcal{T}|}$ such that:

1. $\mathbf{m} = \mathbf{m}_0 + \mathbf{C}\mathbf{v}$ and $\mathbf{m}' = \mathbf{m} + \mathbf{C}\mathbf{v}'$
2. $\llbracket \mathbf{v} \rrbracket \in FS(\mathcal{N}, \mathbf{m}_0)$ and $\llbracket \mathbf{v}' \rrbracket \in FS(\mathcal{N}, \mathbf{m})$

Thus $\mathbf{m}' = \mathbf{m}_0 + \mathbf{C}(\mathbf{v} + \mathbf{v}')$.

Due to proposition 17, since $\llbracket \mathbf{v} \rrbracket \in FS(\mathcal{N}, \mathbf{m}_0)$ there exists a sequence σ and a marking \mathbf{m}^* such that $\mathbf{m}_0 \xrightarrow{\sigma} \mathbf{m}^*$ and $\llbracket \vec{\sigma} \rrbracket = \llbracket \mathbf{v} \rrbracket$ and $\llbracket \mathbf{m}^* \rrbracket = \llbracket \mathbf{m}_0 \rrbracket \cup \bullet \llbracket \mathbf{v} \rrbracket \bullet$.

Since $\mathbf{m} = \mathbf{m}_0 + \mathbf{C}\mathbf{v}$, $\llbracket \mathbf{m} \rrbracket \subseteq \llbracket \mathbf{m}^* \rrbracket$ and so $\llbracket \mathbf{v}' \rrbracket \in FS(\mathcal{N}, \mathbf{m}^*)$. So $\llbracket \mathbf{v}' \rrbracket \cup \llbracket \mathbf{v} \rrbracket \in FS(\mathcal{N}, \mathbf{m}_0)$. Using in the other direction the characterization of theorem 20 with $\mathbf{v} + \mathbf{v}'$, one gets $\mathbf{m}' \in \text{lim-RS}(\mathcal{N}, \mathbf{m}_0)$. \blacksquare

Proof.(proposition 27) Due to propositions 23 and 25, we only have to prove that these problems are PTIME-hard. So we design a LOGSPACE reduction from the circuit value problem (a PTIME-complete problem [10]) to these problems.

A circuit \mathcal{C} is composed of four kinds of gates: **False**, **True**, **AND**, **OR**. Each gate has an output. There is a single **False** gate and a single **True** gate and they have no inputs. Gates whose type is **AND** or **OR** have two inputs. Any input of a gate is connected to an output of another gate. Let the binary relation \prec between the gates be defined by: $a \prec b$ if the output of a is connected to an input of b . Then one requires that the transitive closure of \prec is irreflexive. One of the gates of the circuit, *out*, is distinguished and its output is not the input of any gate. The value of the inputs and outputs of a circuit is defined inductively according to the relation \prec . The output of gate **False** (resp. **True**) is **false** (resp. **true**). The input of a gate is equal to the value of the output to which it is connected. The output of a gate **AND** or **OR** is obtained by applying its truth table to its inputs. The circuit value problem consists in determining the value of the output of gate *out*.

The reduction is done as follows: The gate **True** is modelled by a place p_{True} initially containing a token. This is the only place initially marked. The gate **False** is modelled by a place p_{False} . Any gate c of kind **AND** yields a place p_c and a transition t_c whose inputs and outputs is represented in Fig. 5(a) and any gate c of kind **OR** yields a place p_c and two transitions t_{c1} and t_{c2} whose inputs and outputs are represented in Fig. 5(b). Finally one adds the subnet represented in Fig. 6 with one transition $clean_p$ per place p different from p_{out} . This reduction can be performed in LOGSPACE.

We prove by induction on \prec that a transition t_c (resp. t_{c1} or t_{c2}) is enabled iff the gate c of kind **AND** (resp. **OR**) has value **true**.

Assume that gate c of kind **AND** has value **false**. Then one of its input say a has value **false**. If a is the gate **False** then p_a is initially unmarked and cannot be marked since it has no input. If a is a gate of kind **AND** then by induction on

\prec , t_a is never enabled and so p_a will always be empty. If a is a gate of kind **OR** then by induction on \prec , t_{a1} and t_{a2} are never enabled and so p_a will always be empty. Thus whatever the case t_c can never be enabled. The case of a gate c of kind **OR** is similar.

Assume that gate c of kind **AND** has value **true**. Then both its inputs say a and b have value **true**. If a (resp. b) is the gate **True** then p_a (resp. p_b) is initially marked. If a (resp. b) is a gate of kind **AND** then by induction on \prec , t_a (resp. t_b) can be enabled. If a is a gate of kind **OR** then by induction on \prec , some t_{ai} (resp. t_{bi}) can be enabled. Now consider the sequence $\mathbf{m}_0 \xrightarrow{\sigma} \mathbf{m}$ of proposition 17 w.r.t. $\max\text{FS}(\mathcal{N}, \mathbf{m}_0)$. In \mathbf{m} , every place initially marked or output of a transition that belongs to $\max\text{FS}(\mathcal{N}, \mathbf{m}_0)$ is marked. So t_c is enabled in \mathbf{m} . The case of a gate c of kind **OR** is similar.

Now observe that the total amount of tokens in the net can only be increased by transition $grow$ and in this case place p_{out} is unbounded. Since p_{out} can contain tokens iff the value of gate out is **true**, we have proved that the CPN system is unbounded iff the gate out is **true**.

Finally let \mathbf{m} be defined by $\mathbf{m}(p_{out}) = 1$ and $\mathbf{m}(p) = 0$ for all $p \neq p_{out}$. If the value of gate out is **false** then p_{out} will never be marked and so \mathbf{m} is not reachable. If the value of gate out is **true** then transition t_{out} can be fired by some small amount say $0 < \varepsilon \leq 1$. Then all the other places can be unmarked by transitions $clean_p$ followed by a finite number of firings of $grow$ in order to reach \mathbf{m} . So \mathbf{m} is (lim-)reachable iff the value of gate out is **true**. ■

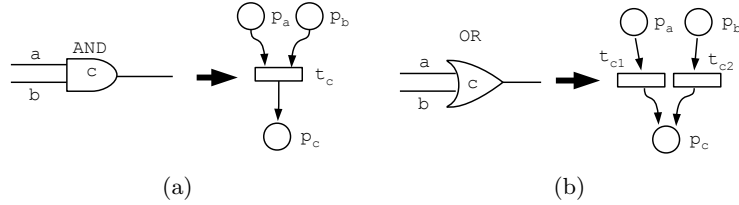

Fig. 5. Reductions of the gates (a) AND and (b) OR to CPN.

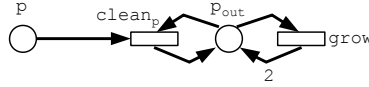

Fig. 6. An additional subnet.

Proof.(proposition 30) We use another reduction from the 3SAT problem already described in the proof of proposition 29.

Every proposition x_i yields a place b_i initially marked with a token (all other places are unmarked) and input of two transitions: (1) t_i with output place p_i

and, (2) f_i with output place n_i corresponding to the assignment associated with an interpretation. Every clause c_j yields a transition nc_j . Transition nc_j has three loop places corresponding to literals lit_{jk} : if $lit_{jk} = x_i$ then the input is n_i , if $lit_{jk} = \neg x_i$ then the input is p_i . An additional place suc is the output of transition nc_j . A transition nd has suc for input place and no output place. Finally for every x_i , there are transitions tb_i and fb_i which are respectively reverse transitions of t_i and f_i with an additional loop over place suc . The reduction is illustrated in Fig. 7. The net is consistent with consistency vector: $\sum_i (t_i + tb_i + f_i + fb_i) + \sum_j (nc_j + nd)$. It does not contain an initially empty siphon since every siphon includes some place b_i . This proves that every transition can be fired at least once from \mathbf{m}_0 .

Assume that there exists ν such that for all clause c_j , $\nu(c_j) = \mathbf{true}$. Then fire the following sequence $\sigma = 1t_1^* \dots 1t_n^*$ where $t_i^* = t_i$ when $\nu(x_i) = \mathbf{true}$ and $t_i^* = f_i$ when $\nu(x_i) = \mathbf{false}$. Consider \mathbf{m} the reached marking. Since $\nu(c_j) = \mathbf{true}$, at least one input place of nc_j is empty in \mathbf{m} . Moreover $\mathbf{m}(suc) = \mathbf{m}(b_i) = 0$ for all i . So \mathbf{m} is dead and the net is not reversible.

Assume that there does not exist ν such that for all clause c_j , $\nu(c_j) = \mathbf{true}$. Our goal is to prove that from any (lim-)reachable marking there is a sequence that comes back to \mathbf{m}_0 . Since from \mathbf{m}_0 all transitions are fireable at least once this proves that the net is (lim-)live and (lim-)deadlock free.

For all atomic proposition x_i , and reachable marking \mathbf{m} , one has

$$\forall i \mathbf{m}[b_i] + \mathbf{m}[p_i] + \mathbf{m}[n_i] = 1$$

Since a lim-reachable marking is a limit of reachable markings, this invariant also holds for lim-reachable markings.

If for some i , $\mathbf{m}[b_i] > 0$, we fire t_i in order to empty b_i . Thus the invariant becomes:

$$\forall i \mathbf{m}[p_i] + \mathbf{m}[n_i] = 1$$

Now define ν by $\nu(x_i) = \mathbf{true}$ if $\mathbf{m}(p_i) > 0$. Due to the hypothesis, there is a clause c_j such that $\nu(c_j) = \mathbf{false}$. Due to our choice of ν and the invariant, all inputs of nc_j are marked. So firing nc_j marks suc . Now fire transitions tb_i and fb_i in order to empty places p_i and n_i . So $\mathbf{m}(b_i) = 1$. Finally one fires nd in order to empty place suc and we are done. ■

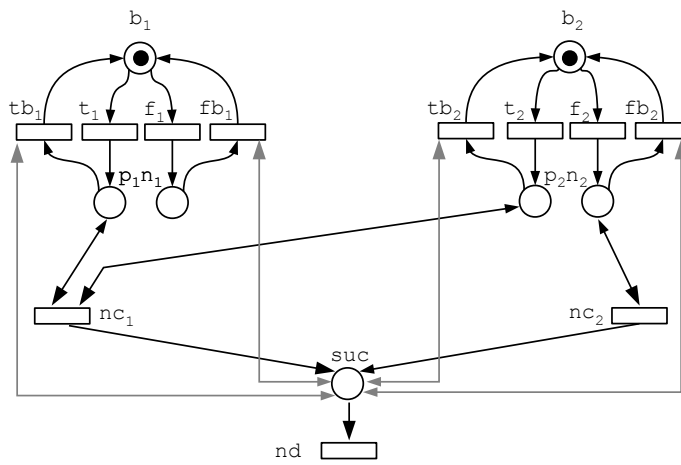

Fig. 7. The CPN corresponding to formula $(\neg x_1 \vee \neg x_2) \wedge x_2$.