







Research Article

Concentrated Solar Power and Photovoltaic Systems: A New Approach to Boost Sustainable Energy for All (Se4all) in Rwanda

Noel Hagumimana ¹, Jishi Zheng ¹, Godwin Norense Osarumwense Asemota ^{2,3},
Jean De Dieu Niyonteze ¹, Walter Nsengiyumva ⁴, Aphrodis Nduwamungu ²,
and Samuel Bimenyimana ^{5,6}

¹Fujian Province Key Laboratory of Automotive Electronics and Electric Drive, Fujian University of Technology, Fuzhou 350118, China

²University of Rwanda, African Centre of Excellence in Energy for Sustainable Development, Kigali 4285, Rwanda

³Morayo College, Nairobi, Kenya

⁴Laboratory of Optics, Terahertz and Non-destructive Testing, School of Mechanical Engineering and Automation, Fuzhou University, Fuzhou 350116, China

⁵Huaqiao University, Intelligence and Automation in Construction Provincial Higher-Educational Engineering Research Centre, 361021 Xiamen, China

⁶Hello Renewables Ltd., Kigali, Rwanda

Correspondence should be addressed to Noel Hagumimana; hagumanoel@gmail.com, Jishi Zheng; zhengjiishi@fjut.edu.cn, and Jean De Dieu Niyonteze; niyontezejado@gmail.com

Received 26 January 2021; Revised 5 April 2021; Accepted 11 May 2021; Published 16 June 2021

Academic Editor: Kumarasamy Sudhakar

Copyright © 2021 Noel Hagumimana et al. This is an open access article distributed under the Creative Commons Attribution License, which permits unrestricted use, distribution, and reproduction in any medium, provided the original work is properly cited.

The energy sector of today's Rwanda has made a remarkable growth to some extent in recent years. Although Rwanda has natural energy resources (e.g., hydro, solar, and methane gas, etc.), the country currently has an installed electricity generation capacity of only 226.7 MW from its 45 power plants for a population of about 13 million in 2021. The current national rate of electrification in Rwanda is estimated to 54.5% (i.e.; 39.7% grid-connected and 14.8% off-grid connected systems). This clearly demonstrates that having access to electricity is still a challenge to numerous people not to mention some blackout-related problems. With the ambition of having electricity for all, concentrated solar power (CSP) and photovoltaic (PV) systems are regarded as solutions to the lack of electricity. The production of CSP has still not been seriously considered in Rwanda, even though the technology has attracted significant global attention. Heavy usage of conventional power has led to the depletion of fossil fuels. At the same time, it has highlighted its unfriendly relationship with the environment because of carbon dioxide (CO₂) emission, which is a major cause of global warming. Solar power is another source of electricity that has the potential to generate electricity in Rwanda. Firstly, this paper summarizes the present status of CSP and PV systems in Rwanda. Secondly, we conducted a technoeconomic analysis for CSP and PV systems by considering their strengths, weaknesses, opportunities, and threats (SWOT). The input data of the SWOT analysis were obtained from relevant shareholders from the government, power producers, minigrid, off-grid, and private companies in Rwanda. Lastly, the technical and economical feasibilities of CSP and PV microgrid systems in off-grid areas of Rwanda were conducted using the system advisor model (SAM). The simulation results indicate that the off-grid PV microgrid system for the rural community is the most cost-effective because of its low net present cost (NPC). According to the past literature, the outcomes of this paper through the SWOT analyses and the results obtained from the SAM model, both the CSP and PV systems could undoubtedly play a vital role in Rwanda's rural electrification. In fact, PV systems are strongly recommended in Rwanda because they are rapid and cost-effective ways to provide utility-scale electricity for off-grid modern energy services to the millions of people who lack electricity access.

1. Introduction

Until recently, electrical energy is seen as a basic need in human life everywhere in the world. However, Rwanda along with many other countries is struggling from a severe lack of access to electricity. Frequent outage due to unbalance between supply and consumer demand continues to rise because of the rise in the Rwanda population as well as the world, the growth of industrial activities, and the improvement of living standards; the electricity demand for the population is growing day by day and has become a major concern, and it will also be much more needed in the years to come. The little dependency on solar energy and a small amount of hydropower in Rwanda is behind the lack of electricity access. Traditional fossil fuels such as oil and coal are continually depleted, causing emissions of carbon dioxide and global warming [1].

Solar energy is seen as one of the most promising sources of energy for producing electricity. On the surface of the earth, the energy obtained from the sun is around 885 million TWh, and this energy is projected to be 6200 times the commercial power needs of the world's population [2]. Each hour, 430 quintillion Joules of energy from the sun reaches the earth [3]. Solar energy production has traditionally been expensive and fairly inefficient, although there has been an improvement over the previous two decades. This is so because the worldwide amount of energy obtained from solar energy increased 300-fold from 2000 to 2019 [4]. The solar radiation beam is a key to CSP to generate electricity by using mirrors that focus onto a small area and concentrates the solar energy to energize the heat transfer fluid (HTF). The solid or gas is heated up to higher temperatures for generating steam required to move a heat engine for the generation of electricity, instead of using fossil fuels or nuclear reactions [5].

Unlike conventional power plants, concentrated solar power or solar thermal systems have an environmentally suitable electricity source, with no carbon dioxide emissions and no need for fuel consumption but sunlight [6]. The only concern on the environment of concentrating solar power plants (CSPs) is land use. Even though the land usage of concentrating solar power plants seems to be larger than that of a fossil fuel plant, it was found that the extra land for load building and mining exploration has led to approximately equal usage of the amount of land [7]. Other benefits of concentrating solar power plants include low operating costs and the ability to produce power during high-energy demand periods and to help increase the country's energy security and independence from foreign oil imports. Because CSPs store energy, they can operate in cloudy weather and after sunset. When combined with fossil fuels as a hybrid system, they can operate around the clock regardless of the weather [8].

Solid and liquid storage media are a sensible heat storage media used for thermal energy storage for CSP systems, and reversible chemical reactions like latent heat storage using phase change materials (PCMs) and thermochemical storage. The following variables are considered when implementing a thermal energy system (TES) for a CSP farm: (1) maximum

load and specific enthalpy drop in load, (2) operational strategy, (3) nominal temperature, and (4) integration into the power plant [9]. Several studies have studied the cost of TES, taking into account the different elements involved, including storage media, tanks, and other expenses.

Since Rwanda lies within the tropical and subtropical regions, it obtains large amounts of solar irradiation that is ideal for power generation. In recent years, Rwanda's peer influence on solar energy has increased and the production of electricity using solar energy is relatively inexpensive and suitable for rural and urban centers [10].

As Rwanda's weather condition is relatively stable, we can turn on emphasizing the availability of CSP generation during the dry and hot season, with CSP's ability to just provide firm capacity for eight hours a day, as data were reported daily throughout the year [5].

The fast integration of TES allows CSP to be dispatchable and unique out of all the other alternative options for generating renewable energy. As an intermediate phase for electricity generation, a TES system provides a highly efficient heat storage process [11]. It may minimize short load fluctuations and shifts or expand the energy supply, based on the size of the TES device. The economic benefit of CSP with TES is that it provides energy at times of strongest need with typically the maximum electricity costs [9].

The PV system is another way to produce electric power because they absorb sunlight and transforms part of it into electricity. There are no practical parts in motion that wear out, no fluids or gases (except in hybrid systems) can escape, there is no need for fuel to function, it has a rapid response, it can immediately attain full output, and it is able to operate at moderate temperatures [12]. The growth of Rwanda's solar energy infrastructure may boost energy security levels because it is an independent energy supply for imports.

The purpose of this research is twofold as follows: (a) to summarize the present status of CSP and PV systems in the Rwanda power sector, to see how the implementation of some new energy technologies can be the best strategies for rural electrification, and (b) to examine a technoeconomic analysis for CSP and PV systems using the system advisor model based on the data from the selected area and downloaded from NSRDB and SWOT analysis based on data collected from the top power producers in Rwanda. Also, the best option based on the past successful regional projects will be recommended after a comprehensive analysis.

2. Concept of CSP Technologies

CSP is an in-depth business methodology for electricity generation exploitation alternative from solar energy. CSP is suitable for areas with a lot of solar radiation and a lot of daylight hours. In CSP technologies, incoming sunlight is focused on a small target area through mirrors or lenses, resulting in medium- or high-temperature heat, depending on the technology [13, 14].

A CSP plant typically consists of a solar field, TES system, and power block as mentioned in Figure 1. The solar field is referred to as thermal energy production, and solar multiple (SM) determines the size of a solar field [15]. The solar field

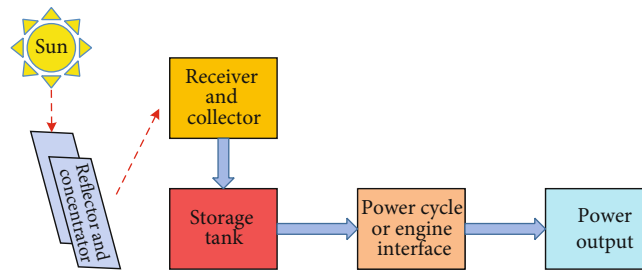

FIGURE 1: Concept of the CSP technology.

focuses solar radiation into a specific point (point focus) or line (line focus) where the heat transfer fluid is located in order to heat it. This HTF that has been heated can be used either directly or indirectly [16]. Directly, water is employed as HTF for direct steam generations; whereas within the indirect case, totally different HTFs like artificial oil, liquid salt, and Therminol VP-1 are accustomed to heat water for a steam generation [16]. While direct HTF is less expensive, commercial steam storage is insufficient. Indirect HTFs, on the other side, are more costly but can be stored. As a result, indirect HTFs are commonly used in CSP plants around the world [17].

The solar-heated HTF passes into the TES system, which stores extra energy for unceasing activity. As a result, the HTF is used to generate steam throughout the steam generator, which then drives the power unit to generate electricity. There are different kinds of CSP technologies depending on the structure and the way radiation is focused, with the same purpose of generating electricity but resulting in different temperature levels. According to the concentration technique, CSP is classified into 4 main types as listed [18, 19]. CSP static receivers stay put, unaffected by the focusing system, while mobile receivers follow it around. Furthermore, line focusing receivers focus solar radiation onto a single spot of line, while point focusing receivers project solar radiation onto a specific point of a receiver.

There are various CSP technologies as shown in Figure 2, but their operating system is the same. The structure and the focus of each of these systems are different, so they result in different temperature ranges that are generated [19].

2.1. Parabolic Trough Systems. The parabolic trough (PT) CSP is a very well-tested and mature solar power plant designed for CSP [16, 17, 20] as shown in Figure 3. This is why in comparison to other CSP configurations, PT plants are more commonly commercialized [17]. A series of parabolically curved mirrors/collectors and receivers make up the PT system. Solar radiation is focused on the receivers, which are loaded with HTF, by the collectors. Thermal storage is used to direct heat HTF to the power unit for power generation. Material demand and land use considerations are reduced due to a single-axis tracking system that follows solar radiation. This is why the PT plant's initial cost is less than that of double-tracking systems [17]. In most CSP plants, the power block uses a steam turbine to generate electricity, which consists of a boiler/steam generator. As a result,

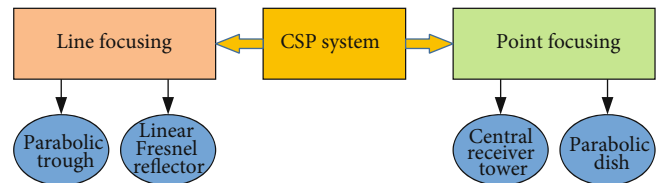

FIGURE 2: Flow diagram shows different CSP systems.

CSP plants can be easily integrated with traditional power plants [17].

2.2. Linear Fresnel Reflector Systems. The linear focusing CSP concentrates solar radiation on a linear absorber tube to keep the reflectors focused on a single axis fixed on the top (see Figure 4). The HTF inside the linear absorber tube can be oil or steam, which transfers the absorbed heat onto a steam turbine for the power cycle. The arrangements allow reflective glass strips to concentrate on an elevated linear receiver rotating around an independent parallel axis, which then in fact transfers the heat to the HTF. Unlike PT systems, linear fresnel reflector (LFR) systems detach the receiver from the reflectors, eliminating needed resources and the need for high-pressure rotating components. The cost of the LFR system is reduced due to the simplicity of the mirror's usage and small land usage [16].

2.3. Solar Tower System (STS). Solar tower technology concentrates solar radiation on a receiver at the upper point of the tower that generates higher temperatures. As noted in Figure 5, the mirrors in a solar power tower receive sunlight with the use of two axes for tracking the sun. Different heliostats of the solar tower are responsible for concentrating solar radiation on the receiver, which in turn are used to transfer the heat from absorbed radiation to the HTF, and later, HTF transfers the energy to the start power cycle fluid [22]. STS has a concentration ratio of 300–1000, resulting in higher working temperatures [16, 23]. This is why, as compared to other CSP configurations, the STS plant has a greater efficiency (20%–35%) [16, 23]. The initial/capital cost of the STS plants is high due to dual tracking and relatively large land needs. It is worth noting that STS systems continued to dominate the CSP market after PT systems were phased out [24].

2.4. Parabolic Dish Concentrator. Parabolic dish concentrators with a point focus device are composed of two main

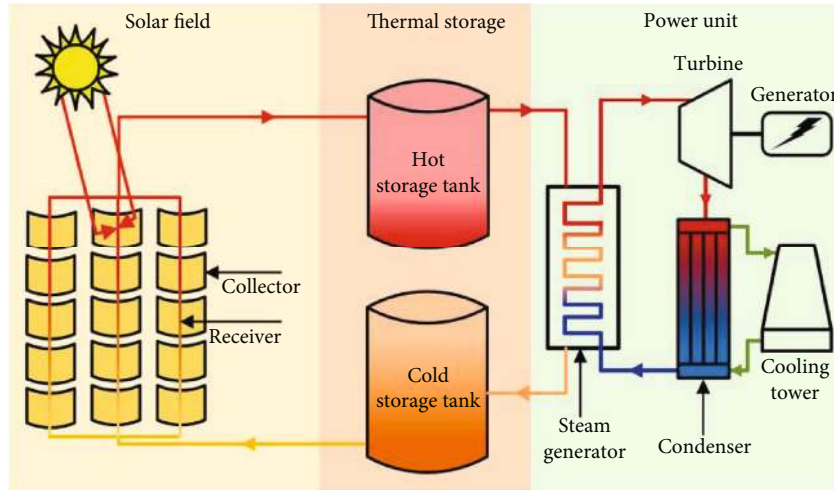

FIGURE 3: Schematic of the parabolic trough [21].

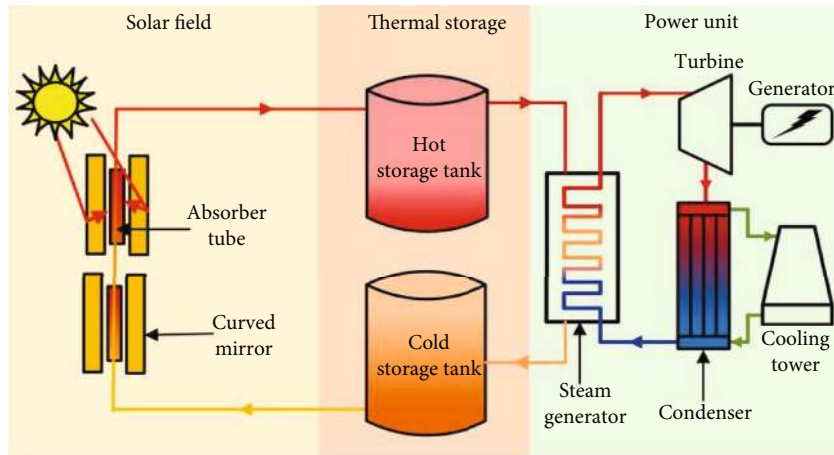

FIGURE 4: Illustration of a linear Fresnel reflector (LFR) system [21].

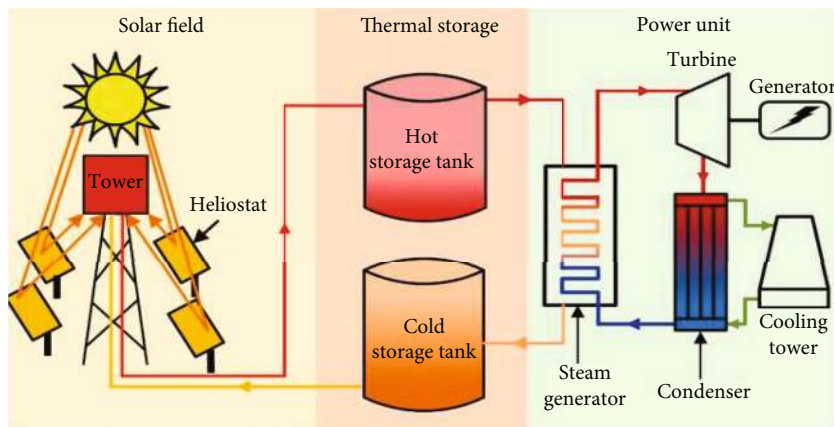

FIGURE 5: Schematic diagram of the solar tower system [21].

parts (in Figure 6), namely, parabolic reflectors and solar thermal receivers, which are located at the focal point [25].

The Stirling engine technology also uses a parabolic dish concentrator to generate electricity. In the shape of a sheet of

reflective material, the parabolic mirrors are constructed into a parabolic shape that concentrates incoming sunlight on a central receptor tube at the focal line of the collector. Parabolic dish technology can reduce the load on centralized

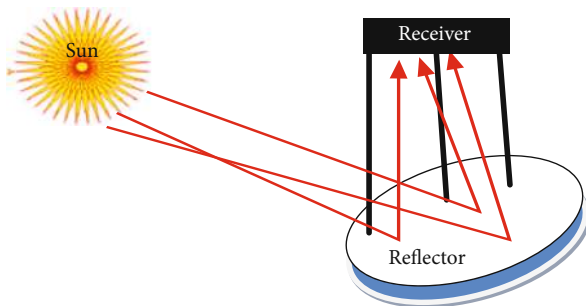

FIGURE 6: A diagram of the parabolic dish concentrator.

power plants [26]. The dish Stirling engine of the parabolic dish concentrator has comparatively good efficiency at approximately 30% and consists of an advanced Stirling converter, which is a linear alternator that directly generates electricity from the countering motion [27].

Stirling engines that are popular and do not require big water cooling systems like steam engines because as it is heated and cooled; they are powered by hydrogen gas expansion-contraction [28].

Direct normal irradiation (DNI) is the sum of solar radiation that is perpendicular (normal) to the unit area received from the incoming sun rays, depending on the time of the day. DNI should be at least 2000 kWh/m² per year to sustain a feasible energy production plant [29]. To estimate the expected energy production from future projects, the accuracy of the DNI data is very critical. Depending on each country's location as illustrated in Table 1, DNI values are different for various countries.

3. Concept of Photovoltaic Cell Based on Power Generation

A solar cell, also known as a photovoltaic cell (PV), is a device that uses the photoelectric effect to transform light into an electric current without interfering with any heat engine. When presented to light, a solar cell which is a solid-state device made up of thin layers of semiconductor materials generates an electric current.

The following modules are the commonly examined in the study: (1) crystalline silicon (c-Si), (2) laser grooved buried contact (LGBC) c-Si, (3) polycrystalline silicon (p-Si), (4) triple-junction amorphous silicon (3j a-Si), (5) copper indium diselenide (CIS), and (6) cadmium telluride [34]. The PV industry, on the other hand, has been able to dramatically reduce production costs and sale prices [35] by mass producing a large number of identical cells and modules in order to achieve a maximum economy scale. The PV industry as a whole has shown that this is possible, thanks in part to business incentives in Germany and other countries for their large contribution. Based on the end-user, there are two categories of solar PV systems: (a) grid-connected systems produce direct current (DC) power and are connected to the grid, which are first to convert DC into the compatible grid alternating current (AC) power and (b) autonomous systems (off-grid systems or stand-alone systems) produce electricity and operate on an independent basis and are usu-

ally installed at isolated sites in remote areas where the power grid is far away [36]. Figure 7 demonstrates various components for solar power production.

The PV cell technology is categorized into two main types and another special one (see Figure 8); they are all made of light-sensitive semiconductor materials that dislodge electrons using photons to transfer electrical current.

4. Potential of Solar Energy in Rwanda

Rwanda is a small Sub-Saharan African country situated just under two degrees below the equator in East Africa with a 12,089,721 (March 2018) [38] population on the land surface of 26,338 km². 94.7% of the overall surface is land and the remaining 5.3% is water occupied [39].

Geographically, it is enclosed with latitudes of 1.050 and 2.840°S and longitudes 28.860 and 30.900°E [40]. Rwanda usually experiences two annual rainy seasons a year, supplying water to the country's various river systems. The US National Air and Space Agency (NASA) and the University of Rwanda have measured solar radiation and solar resources in Rwanda. The report found that the Eastern Province of Rwanda has the strongest potential to generate electricity from solar resources.

In cooperation with the MININFRA Department of Meteorology, the approximate mean monthly solar irradiance ranges from 4.3 to 5.2 kWh per square meter per day across all regions of Rwanda though remains mostly unexploited [41, 42]. The data collected showed that the minimum value of global solar radiation for the Kigali station ($R_G = 4942 \text{ Wh/m}^2/\text{day}$, $R_G = 4960 \text{ Wh/m}^2/\text{day}$) arises in May, while the maximum value ($R_G = 5721 \text{ Wh/m}^2/\text{day}$, $R_G = 5738 \text{ Wh/m}^2/\text{day}$) occurs in May, based on research carried out in the global solar radiation estimation in Rwanda [42]. In recent decades, Rwanda has achieved rapid economic growth and is gifted with ample energy resources like hydro, solar, peat, gas, and biomass, but not fully exploited. Figure 9 shows that it presently has only around 226.7 MW of electricity installed used to supply the entire country [43].

Therefore, petroleum-based fuels, hydro, solar, methane gas, peat, geothermal, biomass, waste, and wind [44] are considered to contribute to electricity generation in Rwanda. Although Rwanda is in the proper direction to increasing access to electricity, reports indicate that the cost of supplying electricity is among the uppermost in the region and continues to restrict the economic and industrial growth of the country [45]. It is by 2024 that the National Transformation Plan intends to provide universal access to affordable electricity [10].

As shown in Figure 10, the basic energy resource utilization in Rwanda indicates that biomass covers 85% of the main energy consumed, where wood comprises 57%, charcoal 23%, crop residues, and peat 5% [46]. Nonbiomass sources contribute 15%, where petroleum products have 11% and electricity contribute approximately 4%.

4.1. Current Status of CSP and PV Technologies in Rwanda. Renewable energy is naturally available with no limited supply; this means that it can be used endlessly. However, only

TABLE 1: Threshold values of DNI in some countries.

Researchers	The threshold value of annual DNI (kWh/m ² /year)	References
Dawson and Schlyter, Australia, 2012	1,800	[30]
Breyer and Knies, Germany, 2009	2,000	[31]
South Africa, 2009	2,100	[32]
Purohit and Purohit, 2010	1,800	[33]
Qatar 2013	2,200	[32]
Australia 2013	2,564	[32]

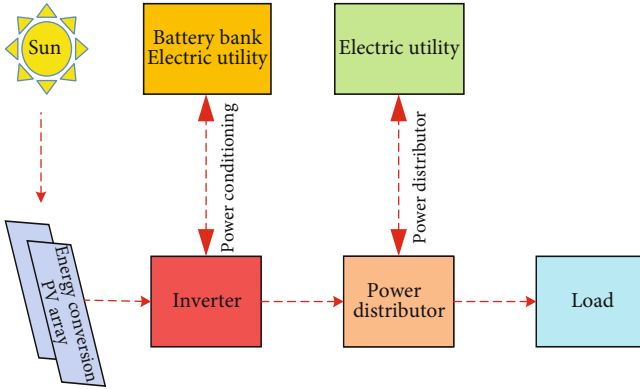

FIGURE 7: PV systems convert solar energy into electrical power with various components.

three renewable energy sources (biomass, geothermal, and solar) can be used to generate ample heat energy in Rwanda to generate electricity. Since geothermal sources are restricted to a few areas, solar energy has the greatest global potential and the supply of biomass does not exist everywhere in nature [18]. In parallel with the Global Solar Atlas, solar resource maps were published for Rwanda by the World Bank Group, funded by ESMAP, and prepared by Solargis in 2017 [48]. With a possible 4.5 kWh per m² per day and approximately 5 peak hours of sunlight, solar energy in Rwanda has enormous potential. Rwanda's total on-grid installed solar energy is 12.08 MW but CSP here remains untouched [49]. Figure 11 shows the global horizontal irradiation for Rwanda, which indicates that the country can benefit from solar energy in different locations and weather conditions, in particular the eastern province which is known for its high irradiance values [50].

PV and CSP penetration levels in the country are not very high, and it is known that solar panels contribute a lot to the mitigation of climate change since they promote a green economy. Rwanda's energy mix shows that solar energy has not reached a high level of production compared to the potential of solar radiation, where thermal is 27%, methane 14%, peat 7%, solar 6%, import 3%, and hydro 57% [52]. Solar PV is not sufficiently popular in Rwanda, although it is heavily connected to transnational actors like outside donors, nongovernmental organizations (NGOs), and other private sector operatives, which have helped in developing and executing Rwanda's response to its rising energy requirements.

The total on-grid installed solar energy in Rwanda is 12,230 MW from 5 solar power plants, i.e., Jali power plant 0.25 MW, Rwamagana Gigawatt 8.5 MW, Nasho Solar 3.3 MW, Nyamata solar 0.03 MW, and Ndera solar 0.15 MW (see Table 2) [53, 54].

A major restriction to the implementation of such systems is the high initial cost of PV systems. Luckily, the government of Rwanda is committed to supporting renewable energy options, such as imported solar equipment is exempted from all taxes [46]. Also, people are encouraged to use energy-efficient equipment. This can be seen in the continuous substitution of incandescent bulbs with compact fluorescent lamps (CFLs), which save electricity [55]. Energy-efficient appliances enable individuals to reduce their monthly electricity bills, in terms of making cost-effective solar systems. Besides, the use of energy-saving equipment enables the utility to reach more clients, one of the goals of the Economic Development and Poverty Reduction Strategy (EDPRS) [56].

The Rwandan government is targeting to raise solar power plants. To minimize the cost of electricity access, individuals are encouraged to use stand-alone solar PVs. Taking advantage of available renewable sources in Rwanda and lessening the production cost are the cornerstone as the government is targeting 100% electricity access by 2024 [10].

The purpose of the government of Rwanda (GoR) is to increase the number of solar power plants. Figure 12 below shows a 17-hectare solar field located near the Agahozo Shalom Youth Village in Rwamagana with 28,000 panels, which was built by private power companies. It is the first large-scale commercial solar field in East Africa, producing 8.5 megawatts of energy at its height, and generates 4% of the country's total power capacity [57]. This has provided power to more than 15,000 homes and is the largest solar plant in Africa. This ensures Rwanda's commitment to solar energy. Regardless of the amount of solar power capacity available, Rwanda still has many people without access to electricity [49].

In Rwanda, the daily solar insolation varies between 4 kWh/m²/day and 5 kWh/m²/day from the Photovoltaic Geographical Information System [47]. The highest solar radiation for the selected site is seen in July where the value is 5.87 kWh/m²/day. The yearly average solar radiation was 5.415 kWh/m²/day and the corresponding average clearness index was 0.541 as shown below. Clearness is characterized as a measure of the fraction of solar radiation transmitted to the earth's surface through the atmosphere [58].

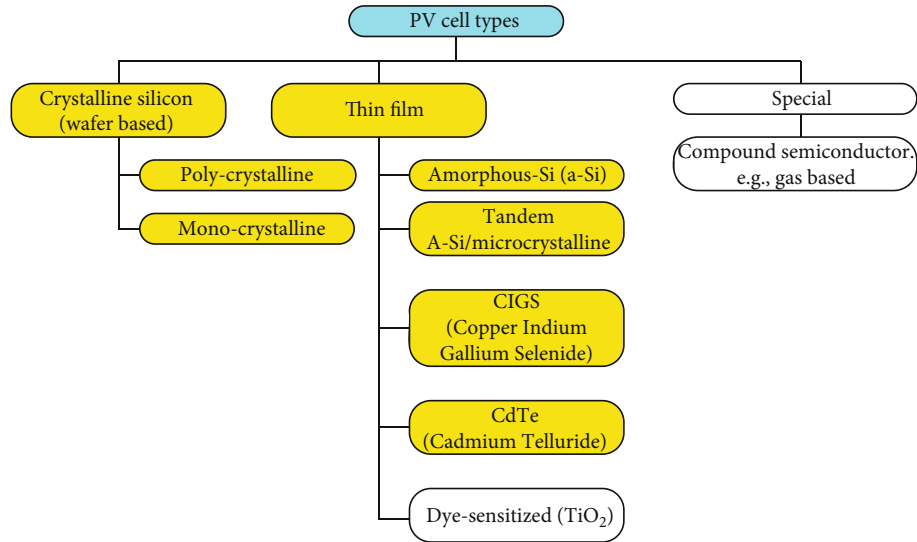

FIGURE 8: Common PV module technology [37].

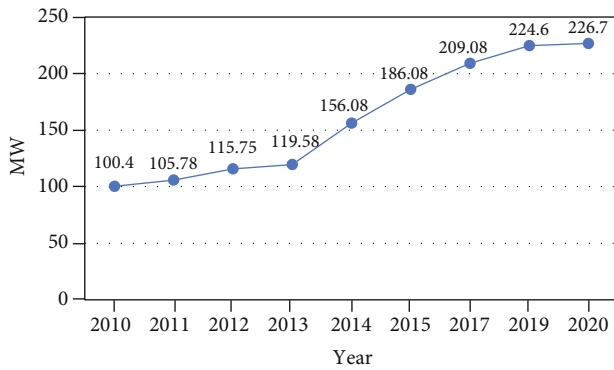

FIGURE 9: Assessment of installed generation capacity in MW on the national grid [43].

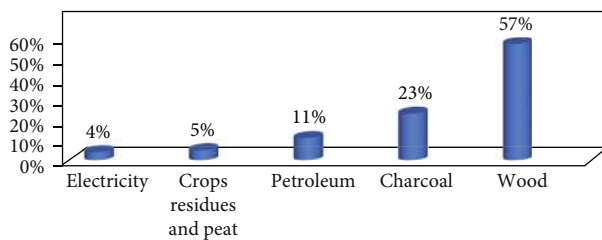

FIGURE 10: Main energy sources in Rwanda 2016 [47].

4.1.1. Impact of Hydropower on the Environment. Rwanda is gifted with two seasons: (a) dry season and (b) wet season. During the wet season, the rain provides water to numerous rivers that can be utilized for electricity generation. The growth of hydroelectric power resources is critical from a macroperspective in order to replace fossil fuels, diminish environmental pollution, and improve the energy structure for sustainable economic growth [59]. However, since the hydropower project is so massive and widespread, it will unavoidably damage the regional environment. The hydro-power station building is destined to take up a large amount

of land and kill vegetation, resulting in the depletion of agricultural land, water, and soil resources. Big reservoirs, extensive building, and a wide range of equipment, loads, and machinery [60] in use during construction and operation require big land and large investment as well.

The amount of land needed to generate hydroelectric power varies greatly depending on the location. Water reservoirs in a flat terrain are likely to be long and wide, while dams in mountains are likely to be higher and shorter, requiring less ground. Furthermore, reservoir-type hydroelectric power plants necessitate a large amount of land for the water reservoir. Table 3 gives an example of estimation of land utilization from Pacca and Horvath’s data [61] during the construction of the Glen Canyon Hydroelectric Plant. After land transformation factors, the result demonstrates an occupation area of 13.6 m²/GWh [61, 62].

Energy improvement can affect land use from various perspectives, going from peak evacuations and surface mining to the restearing of waterways and flooding for hydroelectric dams [60].

Despite the occurrence of two rainy seasons, as shown below, Figure 13 indicates how suitable solar PV and CSP can be applied in Rwanda on the latitude of -3° and longitude of 29° for a ten-year average.

As the temperature increases, the PV system’s output voltage decreases, while the output current is directly proportional to solar radiation [64].

In Rwanda, the average solar insolation is around 5.15 kWh/m²/day [66]. Although this value is a good indication for PV system deployment in Rwanda, it is important to know the average PV generation given by the insolation for different locations in Rwanda as shown in Figure 13.

In summary, the PV technology for off-grid Rwandan rural electrification has been tremendously grown. There are not only the PV solar power plants that are previously mentioned in Table 4, but there are also PV solar home systems that help 11% of Rwandan households to access electricity through solar off-grid solutions [67].

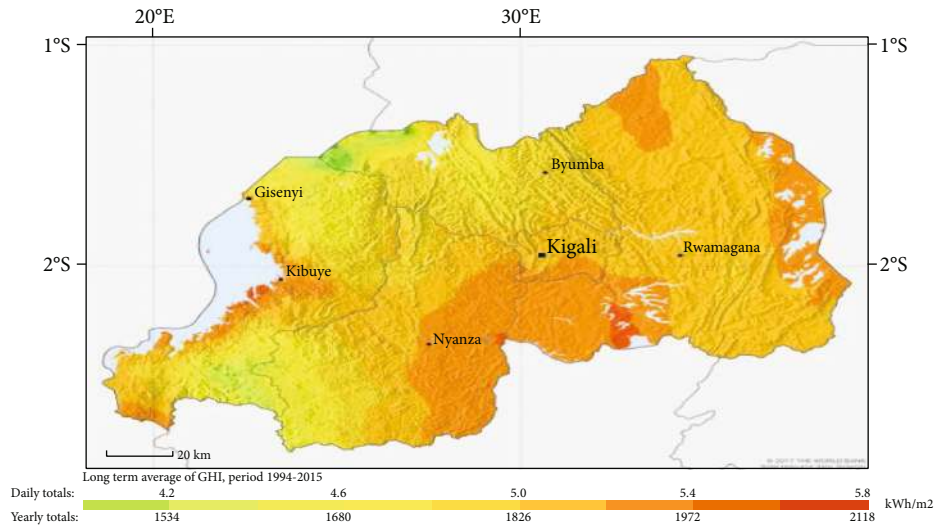

FIGURE 11: Global horizontal irradiation for Rwanda [49, 51].

TABLE 2: Solar energy existing projects in Rwanda.

Plant name	Power plant capacity	Established time	Connection
Mont Jali solar power plant	0.25 MW	2007	Grid connected
Rwamagana solar power plant	8.5 MW	2014	Grid connected
Nasho solar power plant	3.3 MW	2015	Off grid
Nyamata solar power plant	0.03 MW	2016	Off grid
Ndera solar power plant	0.15 MW	2016	Off grid



FIGURE 12: The Rwamagana solar power station [53].

On the other hand, during the first drafting of this paper, there is no evidence or data from government energy agencies or private power producers that show that CSP technology has been deployed in Rwanda yet. However, as a country with sufficient solar radiation intensity, CSP can also be implemented. Until recently, researchers have widely considered PV technology for millions of people who still lack electricity. Table 4 summarizes the recent publications on solar energy in Rwanda in the last ten years.

4.1.2. Rwanda’s Off-Grid Situation. Until December 2020, 59.7% of Rwandan households are wired, with 43.8 percent being connected to the national grid and 15.9% using off-grid systems (mainly solar) [68]. Rwanda’s government (GoR) is collaborating more closely with businesses that operate off grid and wants to electrify the whole nation by 2024 [10, 69]. Rwanda currently has five small stand-alone minigrid plants in service, three of which use solar power as a source of energy, and the other two use water as a generation source [70]. However, attempting to hit last-mile households, difficult landscape, rural households’ remoteness, low

demand, and minimal availability will require higher capital investment to extending the grid engendering slow electrification. Solar minigrid and solar off-grid systems offer investment opportunities in the country [71], though the sector’s growth is hampered by high initial costs and restrictions on high load use. Despite the fact that minigrids and stand-alone systems are playing an important role in increasing the rate of electrification, the rate is not quite as fast as it could be because their prices are prohibitively high, particularly for low-income households scattered, which predominate in rural communities [72].

Rwanda’s modern and green energy supply is typically subpar. The off-grid focus is to electrify more from locally accessible photovoltaic panels, lowering upfront costs as well as overall device costs, allowing low-income families to access power, and promoting local tenure [72]. Minigrids, in general, have made it easier for rural areas to evolve socio-economically. Furthermore, electricity will provide opportunities for rural residents to start new businesses as well as grow and prosper in existing ones [73].

Generally, many of the world’s smallest developed economies are found in Sub-Saharan Africa where Rwanda is among them. Furthermore, many people in this area do not have elementary electricity access. In a wider context, an increase in per capita energy intake is likely to be related to the social and economic growth of Sub-Saharan Africa [74].

In Table 5, the report in 2018, regarding Sub-Saharan countries where Rwanda takes part, shows the trajectory of Rwanda in terms of renewable energy accessibility. It

TABLE 3: Direct land transformation of the hydroelectric power plant [61, 63, 64].

Location/type	Capacity (MW)	Area (10 ⁴ m ²)	Lifetime electricity generation (GWh)	Lifetime (years)	Land transformation (m ² /GWh)	Reference
Colorado, Lake Powel Reservoir	1296	65,313	277,500	50	2,350	[61]
U.S., generic reservoir	114	75,000	30,000	30	25,000	[63]
Canada, reservoir	N/A	N/A	N/A	30	3,700	[65]
Canada, run-of-river	N/A	N/A	N/A	30	3	[65]

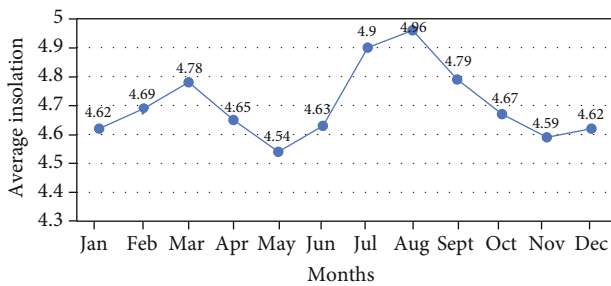

FIGURE 13: Rwanda monthly average solar insolation incident on a horizontal surface (kWh/m²/day). The data was collected from the National Administration of Aeronautics and Space (NASA), 2017.

suggests that 30.8% of the Sub-Saharan countries in the rural area have less than 20.6% of electricity access. Just nine countries had accessibility to over 60% of their rural populations, whereas access to electricity in rural areas ranged from 20% to 60% in the rest of the countries [75].

Table 6 demonstrates the final share of renewable energy in Rwanda compared to the rest where there is progress but is lower with respect to others [76].

5. SWOT Analysis of the Concentrated Solar Power and Photovoltaic Systems in Rwanda

5.1. *Introduction to SWOT Analysis.* Analysis of strengths, weaknesses, opportunities, and threats (SWOT) is an apparatus used to gauge the “strengths,” “weaknesses,” “opportunities,” and “threats” from accepted levels in an organization, a plan, a project, a person, or a business activity for the benefit of assisting planners to classify and prioritize the business goals and identify the procedures for accomplishing them [116].

SWOT analysis is introduced to help decision makers share and compare notes, arrive at clearer common goals, and understand factors for success or failure in business. It involves as demonstrated in Figure 14 internal and external environmental scanning for positive tangible and intangible assets, internal or external to the organization like constraints, financial resources, products, services, and decisions and activities to create and nurture competitive advantages. SWOT analysis is also helpful energy [117].

SWOT analysis was seen as a good tool for energy planning wherein we made a detailed study of the characteristic of energy in Rwanda. This study is aimed at mentioning through a literature review the existence of solar power in Rwanda, its potential, availability, and associated barriers.

We focused on the availability and barriers to the fulfillment of solar energy production that affects the private sector or government to invest more. Besides, SWOT analysis was performed based on a comprehensive literature review and stakeholder interviews.

5.2. *Data Collection and Analysis.* This paper uses a literature review to gather data from government energy agencies, power producers, and minigrid off-grid private companies in Rwanda and a SWOT approach to investigate the internal and external factors for PV and CSP development in Rwanda. In brief, all the secondary data used in this research analysis were collected through documents of projects and existing literature, and finally, we conducted the face-to-face interview which was done using a designed questionnaire to assess each factor from literature and other documents in detail. However, during the interviews, we obtained very many different factors and divergent views. Therefore, only those factors relevant and important to our research were included in the final SWOT analysis.

This study suggests that it is a critical time for Rwanda together with Sub-Saharan African countries to consider exploring their locally available and abundant solar resources. Africa requires more effort to meet Se4all’s target of universal access to sustainable energy. Climate change is also an existential challenge to the world’s poorest and most vulnerable on this occasion. That is why Africa needs an urgent and unprecedented effort to enjoy universal access to electricity. In Rwanda, especially for the World Bank cooperation, Rwanda can strive to seize the development opportunities brought by the World Bank through credit agreement of electricity access for all. Although the GoR is working to increase incentives for private sector participation in solar energy projects, consistent policies and the support from government are required to facilitate the sustainable and long-term developments of different solar technology deployments in Rwanda, especially in remote areas.

5.3. *SWOT Analysis Results of CSP and PV Systems in Rwanda.* The research process led to the identification of internal and external factors for SWOT analysis. This study was conducted for CSP and PV system deployment in Rwanda by applying SWOT analysis. Table 7 summarizes the SWOT analysis of solar technologies in Rwanda.

5.3.1. Strengths

(1) *Increase Experience in Solar Technologies through Off-Grid Projects.* Solar is already among Rwanda’s fastest-

TABLE 4: Recent publications on solar energy in Rwanda in the last five years.

S. no.	Years	Authors & references	Technology application	Case studies	A summary description of the main objective of the study
1.	2016	Abrams [77]	Solar energy investment	Rwanda	From the perspective of a licensed professional, this research examined the creation of East Africa's first utility-scale solar sector. The study used a plant in Rwanda as a case study to examine the elements needed for the effective implementation of financially successful utility-scale solar energy projects with the potential to help Africa bridge its severe power supply deficit.
2.	2021	Kizilcec and Parikh [78]	Pay-as-you-go solar home system	Rwanda (Bugesera and Kayonza districts)	This study examined the journey of a Pay-as-you-go solar home system customer using the case of Rwanda. This study clearly revealed that the journey of the customer is nonlinear and cyclical, recognizing that a household operates in a social network within which others may affect or be influenced. Moreover, it highlighted the increasing importance of solar home system recommendations in raising awareness of solar home systems, pointing to the shifts in the environment of the off-grid energy market where customer awareness no longer appears to be a key barrier to adoption.
3.	2021	Alonso-Montesinos et al. [79]	Solar-diesel hybrid minigrids	Rwanda (Nyabiheke camp)	The environmental and economic benefits of the fully renewable and diesel-hybrid minigrid were studied in this study. This research showed how environmental goals, operational timeframes, financial resources, and will influence the most appropriate system designed for humanitarian actors on a case-by-case basis.
4.	2021	Asemota [80]	Off-grid solar	Rwanda	A preview of off-grid solar performance targets in Rwanda.
5.	2020	Bisaga et al. [81]	Off-grid solar energy	Rwanda	This paper is aimed at mapping the synergies and trade-offs between energy and sustainable development goals by using the case of Rwanda.
6.	2020	Grimm et al. [82]	Off-grid solar energy	Rwanda	The study showed a willingness to pay for various solar technologies in rural Rwanda.
7.	2020	Brunet et al. [83]	Photovoltaic solar power plant	Rwanda	A large-scale solar PV solar power plant through a multilevel and multiscale perspective in Rwanda was assessed.
8.	2020	Nsengimana et al. [84]	Photovoltaic microgrid	Rwanda (Kigali)	A comparative study of the on-grid PV microgrid system and the off-grid PV microgrid system was designed and compared in this study.
9.	2020	Grimm et al. [85]	Off-grid solar electricity	Rwanda	The study was focused on the ability of households to pay significant sections of their electricity budget for various off-grid solar technologies in rural areas.
10.	2019	Bamundekere [86]	Solar energy in Rwanda	Rwanda	The study is aimed at disclosing the contributions of renewable energy to sustainable development.
11.	2019	Niyonteze et al. [87]	Solar-powered minigrids	Rwanda	The strategy and semiprivate operator model for solar-powered minigrids and smart metering systems have been suggested to provide a sustainable solution to the energy crisis and power to various energy users in Rwanda.
12.	2019	Kennedy et al. [88]	Off-grid solar energy	Rwanda and Kenya	A comparison of the nonparametric customer segmentation clustering approach with linear customer behavior models, classifying customers and exploring customer behavior-related demographic and recruitment variables.
13.	2019	Bisaga [71]	Off-grid solar energy access	Rwanda	The study is aimed at resolving a knowledge gap concerning the actions, needs, and expectations of energy usage, focusing on users of the solar home system.

TABLE 4: Continued.

S. no.	Years	Authors & references	Technology application	Case studies	A summary description of the main objective of the study
14.	2019	Bimenyimana et al. [51]		Rwanda	HOMER software has been used to model optimal, sustainable, effective, and accessible solar photovoltaic technologies as energy solutions for all (off-grid and on-grid users) to provide all people with affordable and reliable access to electricity.
15.	2019	Gloria et al. [89]	Solar energy	Rwanda (Agahozo Shalom)	A researcher reviews solar energy for sustainable urban development in rural areas.
16.	2019	Felix et al. [90]	Potential of solar and wind energies	Rwanda	In their report, an evaluation of the capacity of wind and solar energies in the eastern region of Rwanda was carried out. The potential for wind energy and the potential for solar energy were calculated and compared. The analysis indicated that wind energy potential is greater than solar energy potential in the area considered.
17.	2019	Mushimiyimana [91]	Solar energy	Rwanda (Kamonyi)	The research is concentrating and looking on a design of a photovoltaic of 0.8 kWh/day for a single household. The aimed target of the design was to increase the number of households connected to an off-grid photovoltaic system in Kamonyi District.
18.	2019	Soltowski et al. [92]	Off-grid systems	Rwanda	The main focuses were on the role of smart energy management (SEM) platform in the interconnection of off-grid systems and making bottom-up electrification scalable and how it can improve the overall sustainability, efficiency, and flexibility of off-grid technology.
19.	2019	Muvunyi [93]	Viability of micro-hydro-solar PV	Rwanda (Mwogo)	The study was based on the feasibility of a microhydro/PV pump hybrid electric supply system to one pilot village in Rwanda using PVSYST software as an optimization and sensitivity analysis tool. They came up saying that the integration of a solar PV pump and microhydro proved to be a viable operational system.
19.	2019	Munyaneza et al. [94]	Solar photovoltaic minigrid	Rwanda (Rwumba)	Solar photovoltaic minigrid that can provide the required power for the village was designed and optimized using HOMER software. The results that indicated the best results corresponding to the optimum PV minigrid were obtained at a capacity shortage of 3%.
20.	2018	Rodríguez-Manotas et al. [95]	Utility-scale solar PV	Rwanda	The multi-level perspective (MLP) has been used to model the study and interaction of the different sociotechnical levels to fully understand the conditions that allow this transformation. The study revealed the critical importance of bureaucratic and regulatory support for investment in low-carbon energy technology in a neoliberalization process-influenced political economy, thus creating substantial space for negotiating private contracts.
21.	2018	Bimenyimana et al. [96]	Stand-alone and grid-tied solar PV systems	Rwanda (Rwamagana)	Site visits and energy conservation estimates for a standard residential house were used to compare stand-alone and grid-linked PV systems capable of supplying 7.2 kWh/day, loading efficiently. The result was an increase in the production of electricity by domestic energy producers in Rwanda, due to lower initial investment costs and reduced payback periods.
22.	2018	Williams et al. [97]	Microgrid utilities for rural electrification	Rwanda	The outcome is the implementation of the Stochastic Techno-Economic Microgrid Model (STEMM), which allows it possible to determine, from an investment perspective, the influence of technological design decisions as well as the financial conditions on the financial feasibility of microgrid projects.

TABLE 4: Continued.

S. no.	Years	Authors & references	Technology application	Case studies	A summary description of the main objective of the study
23.	2018	Rutibabara [98]	Solar PV, diesel, and hybrid PV-diesel water pumping systems	Rwanda (Bugesera)	The project was conducted to examine the cost of solar PV, diesel, and hybrid PV-diesel water pumping systems for agricultural irrigation in Rwanda, both environmentally and economically. To determine both the environmental and economic feasibility of the proposed pumping systems, the HOMER optimization program was used to take account of the fluctuations in both solar radiation and fuel prices.
24.	2018	Nshimiyimana [99]	Solar PV on a grid system	Rwanda (Masaka)	The research discussed in this study explores the feasibility of using a grid-connected solar PV system in the village to supply electricity. To assess whether the investment will be financially worthwhile, a cost-benefit analysis was conducted. The findings show that solar energy is feasible at a moderate cost in this selected village.
25.	2018	Lameck [100]	PV-biogas hybrid system	Rwanda (Gakenke)	The analysis proposes a hybrid system consisting of PV and biogas with battery storage from renewable energy sources. The hybrid system is modeled and optimized utilizing HOMER software for technological and economic feasibility.
26.	2018	Emmanuel [101]	Solar-wind hybrid system	Rwanda (Kayonza)	During this work, they presented the development of an effective approach of design, simulation, and analysis of a wind-solar hybrid system for a typical rural village in one of the villages of our country. The optimal dispatch strategy of the diesel generator is load following and the total net present cost of each system configuration has been calculated for 20 years of the lifetime of the system to examine the lowest energy cost option.
27.	2017	Uwibambe [102]	Design of photovoltaic	Rwanda	The key focus of the project was on the design of off-grid photovoltaic systems, which included an economic assessment of the usage of a 200 W person solar home system and a 10 kW village PV system.
28.	2017	Ituze [103]	Hybrid solar photovoltaic-bioenergy system	Rwanda (Gicumbi)	The project evaluated the hybrid solar photovoltaic-bioenergy system for powering remote dwellings in the country.
29.	2017	Cyulinyana and Winkler [104]	Surface solar spectrum characteristics	Rwanda	The study represented a model adopted for tropical regions that shows the reliance on atmospheric constituents of surface solar radiation reaching ground level.
30.	2017	Rwema [105]	Energy policy implementation	Rwanda	The research describes hydro, solar, and wind: the effect of energy policy on the deployment of renewable energy in Rwanda.
31.	2017	Ma and Ma [106]	Off-grid photovoltaic system	Rwanda	There was a simple implementation of the development and design of a portable off-grid photovoltaic device with contingency functions for rural areas.
32.	2017	Bisaga et al. [107]	Scalable off-grid energy services	Rwanda and Kenya	This research project is aimed at demonstrating how BBOX, a solar home system company operating in South-Western Kenya and across Rwanda, can also use Internet of Things (IoT) technology to solve development problems.
33.	2017	Kuppa and Zimmerle [108]	Sizing off-grid electrical systems	Rwanda	Estimation of statistical failure method to scale off-grid electrical systems for developing world villages.
34.	2017	Bimenyimana et al. [109]	Photovoltaic power system	Rwanda	The research centered on the comparison of maximum power point output monitoring between incremental performance with disruption and observation of architectures in photovoltaic power generation.

TABLE 4: Continued.

S. no.	Years	Authors & references	Technology application	Case studies	A summary description of the main objective of the study
35.	2016	Collings and Munyehirwe [110]	Pay-as-you-go solar PV	Rwanda	The study claimed that different delivery problems were faced during the implementation of the project and valuable lessons were learned. The effect of considerably more hours of light and the opportunity to charge telephones at home on households using Azuri systems.
36.	2016	Grimm al. [111]	Solar kits	Rwanda	The research paper examined the adoption and impact of a fundamental pico-photovoltaic kit that barely meets the modern energy standard of the United Nations.
37.	2016	Collings and Munyehirwe [110]	Pay-as-you-go solar PV	Rwanda	The research found that small solar lantern adoption substantially decreased household spending on dry cell batteries and kerosene and improved air quality in the home.
38.	2016	Beyer and Habyarimana [112]	Increased application of solar energy	Rwanda	Detailed information from a dedicated network of ground stations on irradiance characteristics in Central Africa (Rwanda) for the characterization of irradiance field statistics and validation of satellite data derived from satellite data.
39.	2016	Nshimiyimana [113]	Hybrid solar PV-wind-fuel cell	Rwanda (Mukondo)	The work focused on sizing of a hybrid solar PV-wind-fuel cell power system for an isolated location.
40.	2016	Karugarama [114]	Microgrid	Rwanda (Kigali)	The analysis was carried out in Kigali on blackout prevention using a microgrid with advanced energy storage and solar photovoltaics.
41.	2015	Crossland et al. [115]	Off-grid photovoltaic system	Rwanda	The sociotechnical approach to increasing the battery life of off-grid photovoltaic systems used in a case study in Rwanda was the key focus.

growing renewable energy technologies. Accordingly, experts suggest that 100% electricity access for the country can be envisaged to come from off-grid technologies by using Rwanda's energy resources like hydro, solar, and methane gas. Presently, the off-grid electricity access rate is 15% of Rwandan households according to the Rwanda Energy Group (REG) [119]. Communities far from the proposed national grid coverage have been advised to use cheaper connections as an option like minigrids and PVs to access the electricity they can afford. Rwanda solar irradiance ranges from 4.3 to 5.2 kWh per square meter per day across all regions [42]. The country experiences a tropical climate, but there is a piercing difference between the northern and eastern sectors in climate conditions. This location places Rwanda in a proper location to establish a large-scale PV and CSP strategy.

(2) *Very High Interest among Investors.* Rwanda is considered to be one of the most politically stable countries in Sub-Saharan Africa, providing investors with a peaceful and predictable working environment. Rwanda, like the whole world, has the ambition of electricity for all. After the national demarcation electrification plan (NEP), there is an increase of registered solar companies, to make PV energy contributions more visible in the energy mix [120]. The solar market is rather very small, and it is mainly limited to the project market driven by donor funding. The main issue is the budget that is needed but talks are being held with all stakeholders, Ministry of Infrastructure (MININFRA), Min-

istry of Finance and Economic Planning (MINECOFIN), and others to see how the exploitation of different energy resources can help to ensure energy for all. The government aims to promote the green economic growth of the country by opening the gates to investors in the country's numerous renewable energy projects. The monitoring of project implementation has to be followed under REG, stakeholder coordination, research, and knowledge management as a key to achieving this goal. The government has also begun a risk reduction facility that decreases the risk of supplying solar products to the private sector and lowers the price charged by the consumer to an acceptable level.

(3) *Areas with Higher Solar Potential Near to an Existing National Grid.* PV and CSP have tremendous potential to contribute to a large degree and to fill the energy deficit in Rwanda. The NEP report demarcates the areas where solar energies should be applied. Geographically, Rwanda is on a horizontal surface near the equator, with plentiful sunlight and global solar radiation, which lies between 4.8 kWh/m² day and 5.5 kWh/m²/day. The yearly total global solar radiation per day is around 5.2 kWh/m²/day, and solar energy is a decent choice. Compared to the rest of the country, Rwanda's eastern province has the highest solar radiation potential [41]. Table 8 shows the potential of solar energy and daily sunshine duration.

(4) *Public Support for Solar (in Contrast to Other Energy Resources).* The fact that Rwanda is gifted with abundant

TABLE 5: Access to electricity in SSA [75].

Country	Access to electricity (% of population) (2018)	Access to electricity, rural (% of rural population) (2018)	Access to electricity, urban (% of urban population) (2018)	Electric power consumption kWh per capita) (2014)
Angola	43.3	3.8(2015)	73.7	312
Benin	41.5	18.3	67.4	100
Botswana	64.9	27.9	81.1	1816
Burkina Faso	14.4	4.7	62.3	—
Burundi	11.0	3.4	61.7	—
Cabo Verde	93.6	96.9	91.9	—
Cameroun	62.7	23.0	93.3	275
Central African Republic	32.4	16.3	55.2	—
Chad	11.8	2.7	41.8	—
Comoros	81.9	77.0	94.0	—
Congo, Demo. Republic	19.0	1.8	50.7	109
Congo, Rep.	68.5	20.2	92.4	203
Cote d'Ivoire	67.9	32.9	100.0	275
Equatorial Guinea	67.0	6.6	90.4	—
Eritrea	49.6	34.6	77.1	97
Ethiopia	45.0	32.7	92.0	69
Gabon	93.0	62.5	96.7	1168
Gambia, The	60.3	35.5	76.0	—
Ghana	82.4	67.3	94.2	351
Guinea	44.0	19.7	87.0	—
Guinea-Bissau	28.7	10.0	53.1	—
Kenya	75.0	71.7	84.0	164
Lesotho	47.0	37.7	70.7	—
Liberia	25.9	7.4	43.6	—
Madagascar	25.9	0.0	69.6	—
Malawi	18.0	10.4	55.2	—
Mali	50.9	25.4	85.6	—
Mauritania	44.5	0.6	82.4	—
Mauritius	97.5	100.0	88.5	2183
Mozambique	31.1	8.0	72.2	479
Namibia	53.9	35.5	72.2	1653
Niger	17.6	11.7	47.6	51
Nigeria	56.5	31.0	81.7	145
Rwanda	34.7	23.4	89.1	—
Sao Tome and Principe	71.0	55.7	76.7	—
Senegal	67.0	44.2	92.4	229
Seychelles	100	100.0	99.6	—
Sierra Leone	26.1	6.4	53.2	—
Somalia	35.3	14.6	60.5	—
South Africa	91.2	89.6	92.1	4198
South Soudan	28.2	23.7	46.8	44
Sudan	59.8	47.1	83.8	257
Switzerland	100	100.0	100.0	7520
Tanzania	35.6	18.8	68.3	104

TABLE 5: Continued.

Country	Access to electricity (% of population) (2018)	Access to electricity, rural (% of rural population) (2018)	Access to electricity, urban (% of urban population) (2018)	Electric power consumption kWh per capita) (2014)
Togo	51.3	22.4	91.9	155
Uganda	42.6	38.0	57.5	—
Zambia	39.8	11.0	77.2	717
Zimbabwe	41.0	20.0	85.3	609

TABLE 6: Renewable energy targets for share of primary or final energy of SSA, 2018, and progress, end-2016 [76].

Country	Primary energy		Final energy	
	Share	Target	Share	Target
Angola	—	7.5% by 2025	4.4%	—
Benin	59.6%	—	8.8%	25% by 2025
Burundi	—	—	2.6%	2.1% by 2020
Cote d'Ivoire	3%	15% by 2020 20% by 2030	7.6%	—
Gabon	76.7%	—	60.1%	—
Ghana	42.5%	—	13.5%	10% by 2030
Guinea	—	—	2.4%	30% by 2030
Guinea Bissau	—	—	7.8%	—
Liberia	5%	30% by 2030	73.8%	10% by 2030
Madagascar	—	—	38.6%	54% by 2020
Malawi	—	7% by 2020	47.3%	—
Mali	—	50% by 2020	4.3%	—
Mauritania	—	20% by 2020	1.1%	—
Niger	74.7%	10% by 2020	—	—
Rwanda	—	—	8.2%	—
Sudan	—	20% by 2020	24.7%	—
Switzerland	—	24% by 2020	—	—
Tanzania	22.3%	24% by 2020	19.8%	—
Togo	78.9%	—	12.7%	4% (no date given)

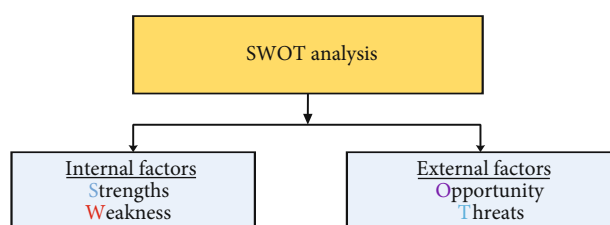

FIGURE 14: Basic elements of the SWOT analysis [118].

natural energy resources like solar has to be fully exploited. The identification and suggestion of an effective solar photovoltaic (PV) and the introduction of CSP technology depend on its annual capacity to generate electricity, electricity load, percentage of penetration of renewable energy, economic viability, feasibility, availability, carbon footprint, and degree of greenhouse gas emissions for climate change implications towards a green and clean future. The GoR has firmly defined the policy and regulatory structure for implementing the NEP, involving guidelines and technical requirements for

minigrids and off-grid solar items, among the energy indicators for all, and REG has endorsed an incentive scheme to make these electrification options viable (2019) [121]. In the power sector, the Nationally Determined Contribution (NDC) highlights (a) increasing the share of new grid-connected renewable capacity compared to fossil fuels, (b) installing solar photovoltaic (PV) minigrids in rural communities, and (c) increasing energy efficiency through demand-side measures and supply-side loss reduction measures [121]. Rwanda's ambition of 48% of the universal electrification target through off-grid solar systems by 2024 shows a big initiative in expanding electricity access to low-income households which is affordable for consumers and the government's capacity to fulfil its mandate [122].

(5) *A Possibility of Using Micropower Plants.* The NEP report demarcates the microgrid zone for solar, hydro, or hybrid systems all over the country. The GoR has stated that having access to electricity in Rwanda will require the supply of DC solar kits for low-demand residential customers below 50 Wp (watt peak). It will also determine a favorable place where

TABLE 7: Internal and external factors identified for SWOT analysis.

(a)

Strengths	Weaknesses
(1) Increase experience in solar technologies through off-grid projects	(1) High initial investment costs
(2) Very high interest among investors	(2) Lack of community engagement
(3) Areas with higher solar potential near to an existing national grid	(3) Highly subsidized electricity tariffs to final consumers
(4) Public support for solar (in contrast to other energy resources)	
(5) A possibility of using micropower plants	
(6) Shorter lead time for the construction of solar power plants	

(b)

Opportunities	Threats
1. Seasonal complementarity between solar and hydro resources	Lack of project financing
2. Establishment of new plans to privatize the solar energy market	Lack of international development partners
3. Development of industry connected to the solar power sector	Low participation of the private sector
4. Reduced emission of greenhouse gases	Insecure revenues
5. Decreasing global prices for solar energy	
6. Growing investment in solar energy in Rwanda	

TABLE 8: The minima and maxima values of monthly averaged global solar radiation over the period of 1974–1993 [41].

Year	G_{\min} (kWh/m ² /day)	Month	G_{\max} (kWh/m ² /day)	Month
1974	4.1	Jul	5.2	Aug
1975	4.1	May	5.1	Jan
1976	4	May	4.9	Jan
1977	4	Apr	5	Jul
1978	4.2	Jan	4.9	Jan
1979	3.8	May	5.1	Jul
1980	4.1	May	5.3	Aug
1981	—	—	—	—
1982	4.1	May	4.9	Jul
1983	4.2	Apr	4.9	Sep
1984	4.1	Nov	5.1	Jun
1985	4	Apr	5.4	Aug
1986	4.4	Apr	5.1	Jul
1987	4.1	May	5.3	Jan
1988	4.3	Apr	4.9	Jun
1989	4.3	May	5.1	Aug
1990	4.3	Feb	5.4	Jul
1991	4.1	May	5.2	Aug
1992	4.4	Dec	5.5	Aug
1993	4.4	Jun	5.7	Aug
Average	4.3		5.2	

stand-alone AC solar systems should be provided to larger customers who are too isolated from the network to justify an individual connection to the central grid or an off-grid microgrid [123]. Rwanda has shown improvement towards energy access, from 6% on-grid access in 2000 to 37% on-

grid access in 2019. Though there is a change, the off-grid access still has to gain more potential, as it accounts for about 14% of the population which is small compared to other countries. The potential for renewable energy minigrids is high [124]. Research conducted by the Energy Development Corporation Ltd. and funded by the Sustainable Energy Fund for Africa (SEFA) acknowledged over 200 potential minigrid sites. The recently approved NEP by REG Ltd. foresees 10% of off-grid targets to be met by minigrids connecting over 300,000 households [125]. This highlights that the PV and CSP can provide more assurance for energy generation in Rwanda.

(6) *Shorter Lead Time for the Construction of Solar Power Plants.* Electricity has been indispensable for improving economic activity and improving the quality of life of humans. Solar energy projects have a shorter time for project implementation compared to other energies. But it all depends on the suppliers we have and how much we want to invest in the construction. Generally, solar power plant technology construction is shorter and quicker than other forms of energy [125]. Despite the fact that CSP necessitates land preparation and water availability, the overall implementation time is also short.

5.3.2. Weaknesses

(1) *High Investment Cost.* Renewable energy power plants have high initial construction costs, with virtually no fuel costs and comparatively lower operating and maintenance costs, unlike traditional fossil fuel power plants [126]. Nevertheless, the large starting cost of capital associated with renewable energy technologies (RETs) makes it hard to attract investors to the sector, particularly in countries that are considered to be at risk [127]. The high initial cost

associated with PV and CSP technologies makes it difficult for Rwanda to develop. These expenses include the cost of solar panels, inverters, hardware for installation, wiring, installation, approvals, repairs, surveillance, maintenance, and other operations and overhead expenses. Such prices do not provide a storage system for batteries, which is an additional expense. Many power utilities in Sub-Saharan Africa (SSA) where Rwanda is located have inadequate electricity generation capacity, unreliable services, and high costs. They also face capital limitations that prevent them from making the required investments for expansion projects. Shortages of capacity have pushed power companies to use leased power-generating emergency units, at great socioeconomic and environmental costs [128].

(2) *Lack of Community Engagement.* While off-grid systems are the safest way to supply electricity to remote and island communities far from the national electricity grid, as a result of the lack of a clear policy structure for its growth, the development of this sector has not seen the necessary investment. Access to electricity, reliability, and costs remain problems across most Sub-Saharan Africa countries. The PV market in Rwanda is growing and largely dominated by an institutional market guided by the needs of providers of rural health and education services. Many of the installations have been fully funded by donors with little national government cooperation. People have explored various ways to get power to their new neighborhoods, and some have realized that the grid will never supply them who currently lack electricity because they live in neighborhoods that are spread around large areas and are too poor to afford such comprehensive infrastructure. Due to the high initial cost of solar energy projects, most people cannot afford it and makes it difficult for community engagement [129].

(3) *Highly Subsidized Electricity Tariffs to Final Consumers.* The production capacity of electricity and access to electricity is limited, and the size of the infrastructure is inadequate to meet requirements. Although Rwanda is on a high growth trajectory access to electricity, the cost of supplying electricity has been seen to be among the highest in the region and continues to hamper the economic and industrial growth of the country [45]. Most of the solar energy projects in Rwanda need high financial grants to be bankable or viable. It was suggested that for Rwanda to be able to reap and deepen the benefits of this reform program of electricity for all over the coming decade, The Rwandan Energy Group (REG), the country's publicly owned electricity corporation, is to place new public-private partnership investments defined in the lowest-cost plan in the driver's seat, rather than depending on unsolicited private sector suggestions [45]. The cost of electricity production employing solar PV and CSP which are yet-to-be-implemented technologies has declined significantly in recent years, and this trend is expected to continue. Thus, it is reasonable to consider this potential as an option and incentive for utilizing solar energy for future electricity demand. Solar electricity generation using PV and CSP is more favorable cost competitively against fossil fuels even in large interconnected systems in developed countries

[130]. Under the extremely costly conditions of generating electricity in Rwanda (because of its geopolitical situation), the solar output could be even more competitive and results in lower electricity costs. Rwanda has set out motivations for investors interested in this sector, like "(a) provision of transmission access to all power projects on government's cost, (b) authorized road access, water service, and all infrastructure needed during energy project development, (c) free tax on power equipment during energy project development, and (d) provision of land on power projects by the government or compensation to private developers on the cost of land" [40].

5.3.3. Opportunities

(1) *Seasonal Complementarity between Solar and Hydro Resources.* A major opportunity for rural power supply is microhydropower with rainfall that generates streams in various areas. Rwanda has restricted electricity generation, especially during the dry season, when many hydropower plants experience problems with water shortages. Rental diesel generation is then used to provide the power demands during this time, and this generation comes with a high cost. Therefore, solar energy generation would provide the highest output in the months when it is most needed. The GoR advises to combine both solar and hydroenergies which were applicable due to the small run-off rivers and also reduce the cost of solar energy storage [131].

(2) *Establishment of New Plans to Privatize the Solar Energy Market.* In Rwanda, solar power is predominantly a procurement sector for institutional government and NGO systems, while demand for solar homes is growing. The national policy is based on attracting investors and showing them the energy development opportunities including solar energy [132].

At the heart of Rwanda's National Strategy for Transformation is access to electricity for all Rwandans (NST) (2017/18–2023/24), with a view of achieving upper-middle-income country status by 2035 and high-income status by 2050. Off-grid solutions where on-grid solution is not reachable are expected to be driven by the private sector [133]. As specified by NEP, about US\$370 million of private finance is expected to be mobilized up to 2024 to support the implementation of off-grid solutions. Therefore, the NEP demarcates on-grid and off-grid energy expansion regions in order to mobilize private funding for off-grid solutions, providing a clear path to the private sector regarding their operations in off-grid areas [122].

Energy subsidies in the use of energy resources present an inefficient distortion in related technologies and a very big burden on the government budget that could undermine fiscal sustainability [134]. The poor participation of the private sector remains the biggest challenge to the growth outlook of Rwanda, as reforms to promote the business situation have not yet led to significant private sector investment in all sectors [40]. Therefore, appropriate energy pricing is important to make sure the consumers are encouraged to make efficient

and productive uses of energy and to ensure that energy suppliers can operate on a sustainable basis. Lack of investment and proper maintenance expertise have contributed to several technical issues, including malfunctioning batteries, defective wiring, and broken down DC appliances [135]. According to a participation commission organized by donors to improve the performance of institutional PV systems, the following measures were undertaken to (1) specify energy systems suitable for Rwandan health facilities, (2) enable partners in the creation of consistent design, installation, and after-service operations, (3) help grow the quality chain, by offering capacity-building exercises and implementing standards and good practices, and (4) organize periodic meetings among key stakeholders [135].

(3) *Development of an Industry Connected to the Solar Power Sector.* Rwanda is well favored with solar energy; even during the months of the rainy seasons, there is daily sufficient sunshine. The seasonal conditions change, with the average daily irradiation in the cloud hitting around 4.5 kWh/m^2 , and the total annual capacity in 2015 was estimated at 66.8 TWh [136]. Two solar PV plants, namely, GIGAWATT Global Solar Power (8.5 MW) and Jali Solar Power (0.25 MW), are connected to the national grid in the districts of Rwamagana and Gasabo, respectively [43]. Energy generation could be boosted through solar energy by increasing the development in other sectors such as industries. This is because electricity is the lifeblood of manufacturing, where raw materials are processed into finished goods. Furthermore, electrical energy is also one of the most convenient, safe, and clean forms of energy used in the home and job creation.

(4) *Reduced Emission of Greenhouse Gases.* Climate change is a major global issue for the world. It affects the society and biodiversity. It can jeopardize the world economy and generate international conflicts and political crises. Seasonal mean temperature anomaly distribution has changed to higher temperatures. The range of anomalies has since increased; therefore, researchers have turned to the benefits of clean energy where it decreases our dependency on fossil fuels and can combat climate change [137]. Therefore, adopting renewable energy use including solar energy technology reduces atmospheric pollution. This change is pushing down greenhouse gas emissions from power generation, heating and cooling of homes, and transport [138].

(5) *Decrease in Global Prices of Solar Energy.* RE prices are now dropping across the world, so it has been shown to be a cheaper source of electricity production compared to traditional sources that rely on fossil fuels—a 70% decrease since 2010 [139]. This rapid price decline has nothing to do with any other energy technology [140]. Accordingly, the Rwanda national electrification plan recommends the use of a solar home or solar stand-alone system to reduce energy costs. The government will assist people in different ways, like (a) setting up facilities that allow low-income households to gain access to modern, clean, and sustainable energy services using basic solar power systems, (b) establishing a strategy that makes it easier for the private sector and consumers to

make solar power products more affordable, and (c) enabling the private sector to build and establish minigrids, and the government will provide the assistance of site identification and adequate structure for site identification [141].

(6) *Growing Investment in Solar Energy in Rwanda.* Much of present installations have been financed by donors with low governmental coordination. The major constraints of the Rwanda power sector include (a) electricity demands almost equal with the generation, and with little reserves, (b) high petroleum product expenditures, (c) lack of investment financing, (d) lack of government subsidies, which cushion electricity retail prices, and (e) inability to participate in a large number of energy exports and trade due to relatively uncompetitive pricing structures [40]. It is vital to the private sector that minigrad projects are allowed in minigrad areas and subsidies for solar home systems (SHS) only are available in SHS areas, although the systems can be sold anywhere [134].

5.3.4. Threat

(1) *Lack of Project Financing.* High-capital investment ventures need reasonably easy access to capital in order to be viable. However, capital markets are not as developed in almost all Sub-Saharan African countries where Rwanda is located as in many other countries, making it difficult to access external investment. Sub-Saharan African countries' power generation has been facing some challenges like illiquidity, lack of depth, and small size. Special local support systems are needed to meet energy-poor rural communities through a market system targeted at supporters. Investors need to consider and limit the risks of investing in renewable energy ventures, as well as in the industry itself. To ensure fair returns over the life of the project, the private sector needs long-term assurances, since some projects last for decades. Also, long-term contracts and identifying components with a clear comparative advantage over imports will attract investors [142].

(2) *Lack of International Development Partners.* Rwanda needs the electricity sector to ensure an adequate, secure, sustainable, and more affordable electricity supply by 2024. It is important to learn how to mobilize global awareness and resources to boost access to solar energy (PV) and to reinforce the knowledge base of national governments on the ties between poverty, renewable energy, and climate change to guarantee secure operations [143]. Rwanda's private sector participation in solar power technology for rural development projects has established an enabling policy framework to encourage private sector investments through standardized power purchase agreements and feed-in tariff schemes [40]. The challenges of high electricity cost and frequent power outages (blackouts) in a small country with a relatively low average income and extremely low average consumption volumes lead to generation capacity and demand misalignment. These challenges are making it impossible to maintain an efficient tariff structure because if demand fails to keep pace with the increased generation capacity, then, the tariff will increase [144]. Commercial enterprises are hardly

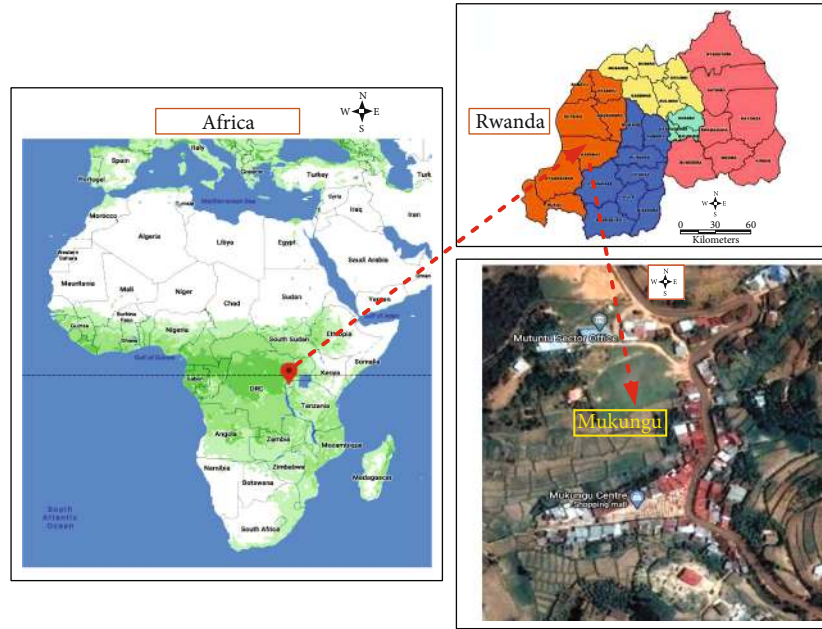

FIGURE 15: Map of the selected location study area.

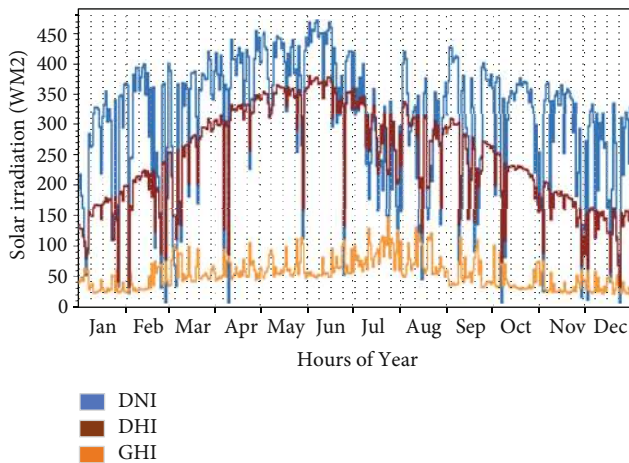

FIGURE 16: Hourly GHI, DNI, and DHI during a year.

interested in investing in energy generation since feed-in tariffs are kept low by the import parity price for electricity from neighboring countries. Enterprises are now focusing on the market through public tenders for broader programs for public institutions, such as hospitals and schools. In urban areas, the demand for solar water heating systems is booming [143]. Thus, all these constraints are sometimes due to a lack of international development partners.

(3) *Low Participation of the Private Sector.* The contribution of the private sector in enabling solutions to renewable energy to be integrated into the grid is also becoming economically viable. Compared to the fossil fuel cost spectrum, solar PV, CSP, and all other renewable energy generation technologies currently in commercial use are projected to decline, with most fossil fuel prices at the lower end or decreasing. Therefore, the International Renewable Energy

Agency (IRENA) thus aims to address obstacles to high upfront costs, investment risks, regulatory instability, the lack of trained practitioners, and environmental issues [145]. Energy sector financing should be accessible, which has been a big barrier in project implementation. IRENA addresses challenges that seem to halt or limit the African development in renewable energy, especially solar energy that includes [145] (a) high costs being inherent to the energy sector, (b) limited access to funding, (c) creditworthy utilities/insufficient cost recovery, (d) elastic demand/affordability, (e) foreign exchange risk, (f) lack of competition for networks, (g) inefficient tendering processes, (h) breach of contracts, and (i) inability to raise tariffs to cover costs [145].

(4) *Insecure Revenues.* The contribution of the private sector in enabling solutions to the renewable energy sector is profitability since it is the basis for establishing solar energy investment. The financial returns will be based on the underlying technology, and at which level of competitiveness it operates with other forms of technology is critical. Nevertheless, renewable energy production costs drop significantly and certain technologies are already productive in many parts of the world, or at “grid parity” with conventional sources of electricity [145]. Underpricing of power in Africa leads to poor revenues from public utilities in line with the low purchasing power of the population, poor revenue collection mechanisms, and high transmission and distribution losses. To inject capital for infrastructure maintenance and expansion, many countries have opened their markets to the private sector. The absence of laws and regulations promoting the creation of renewable energy technologies will delay their deployment [146]. This helps policies to build stable and predictable investment environments that address obstacles and ensure that project revenue sources are predictable [146].

6. Feasibility, Optimization, and Technoeconomic Assessment of Concentrated Solar and Photovoltaic Systems in Rwanda

6.1. Methodology

6.1.1. Introduction. As a result of increased industrial activities, growing populations, and significant changes in people's total energy consumption in recent times, global energy demand has exploded. This chapter traces the effectiveness of the PV and CSP system's technoeconomic model for a real residential aggregated load. The world's energy demand is expected to increase by 30% by the year 2040 [147]. So, many countries are taking advantage of their economic potential in order to meet their energy needs [148]. Rwanda, like many other developing countries, faces difficulties in meeting its energy demands. Rwanda's latest national electrification pace is at 59.7% (43.8% grid-connected and 15.9% off-grid-connected systems) [68]. An economic study is typically carried out to justify the use of PV and CSP systems in buildings and to illustrate the idea so that homeowners are willing to invest. PV and CSP system economic output is determined by a variety of factors, namely, capital cost, installation cost, operating and maintenance costs, and electricity tariff as well as payback period (PB), which is the time it takes to recoup the initial investment. Throughout the project, the technoeconomic study estimates the cost savings gained by implementing green technology against the cost of installed systems [149]. CSP and PV technologies are part of feasible and promising renewable energy technologies that can be built to produce electricity in order to further enhance renewable energy use across the world.

6.1.2. System Advisor Model. The system advisor model (SAM) is a computer model that measures renewable energy project technoeconomic efficiency and financial metrics. SAM was developed by the U.S. Department of Energy's National Renewable Energy Laboratory (NREL) [150]. SAM simulates photovoltaic, concentrated solar power, solar water heating, wind, geothermal, and biomass power system efficiency, as well as a simple standardized model for comparisons with traditional or other types of systems [151]. This is an electricity-generating model that assumes the RE system delivers its power to a grid- and off-grid-connected house, the electric grid, or a facility to satisfy an electric demand [150]. It is used to model real-world scenarios using local weather data and manufacturer-supplied equipment data. A system's produced output may also be used as an input into that system or other systems [152].

6.1.3. The Selected Site and Data Collection. In this study, to achieve the study's goal of evaluating the technical and economic performance of CSP and PV systems at the chosen location, the selected site as shown in Figure 15 was chosen to collect data based on the size of the system and load demand. The location was selected to analyze their ability to support large-scale PV and CSP power plants by evaluating their technoeconomic potentials. The provision of quality

TABLE 9: Selected site geographical data.

Parameters	Values
Latitude ($^{\circ}$ N)	50.29
Longitude ($^{\circ}$ E)	2.42
Altitude (m)	121
Annual DNI (kWh/m ² /day)	3.22
Average ambient temperature ($^{\circ}$ C)	19.98
Average wind speed (m/s)	3.0

TABLE 10: Monthly energy consumption in 2019.

Month	Consumption (kWh)
January	193
February	200
March	200
April	250
May	250
June	250
July	300
August	300
September	200
October	200
November	250
December	193

solar resources (i.e., DNI) is of the greatest priority when selecting the best sites for CSP implementation in a country [153]. CSP technologies absorb and concentrate DNI incident on the surface of the earth to heat a working fluid and then generate energy through a thermodynamic cycle. The selected site Mukungu is located in the western province at 50.29 $^{\circ}$ N latitude and 2.42 $^{\circ}$ E longitude. This site according to data from the National Solar Radiation Database (NSRDB) records has an annual average of solar global horizontal of 3.06 kWh/m²/day. Solar radiation availability has a major impact on the economic feasibility of large-scale PV power plants. The amount of solar radiation available at a given location has a major effect on the levelized cost of energy (LCOE) [154]. The hourly weather data features of the study sites collected from NSRDB are shown in the graph of Figure 16 below.

6.1.4. Selected System Details and Components

(1) PV System. This technoeconomic feasibility study's key contribution is to provide fundamental information for the viability of residential PV system use in the off-grid area in Rwanda. The proposed residential system design has a 5 kWp capacity and is made up of 20 monocrystalline silicon modules with a nominal power rating of 250 Wp each and a total module surface of 35 m². Furthermore, two inverters with a combined AC power of 4.2 kW have been employed in this analysis. The system configuration is 10 modules per string with a DC-to-AC ratio of 1.2. PV modules have a 25-

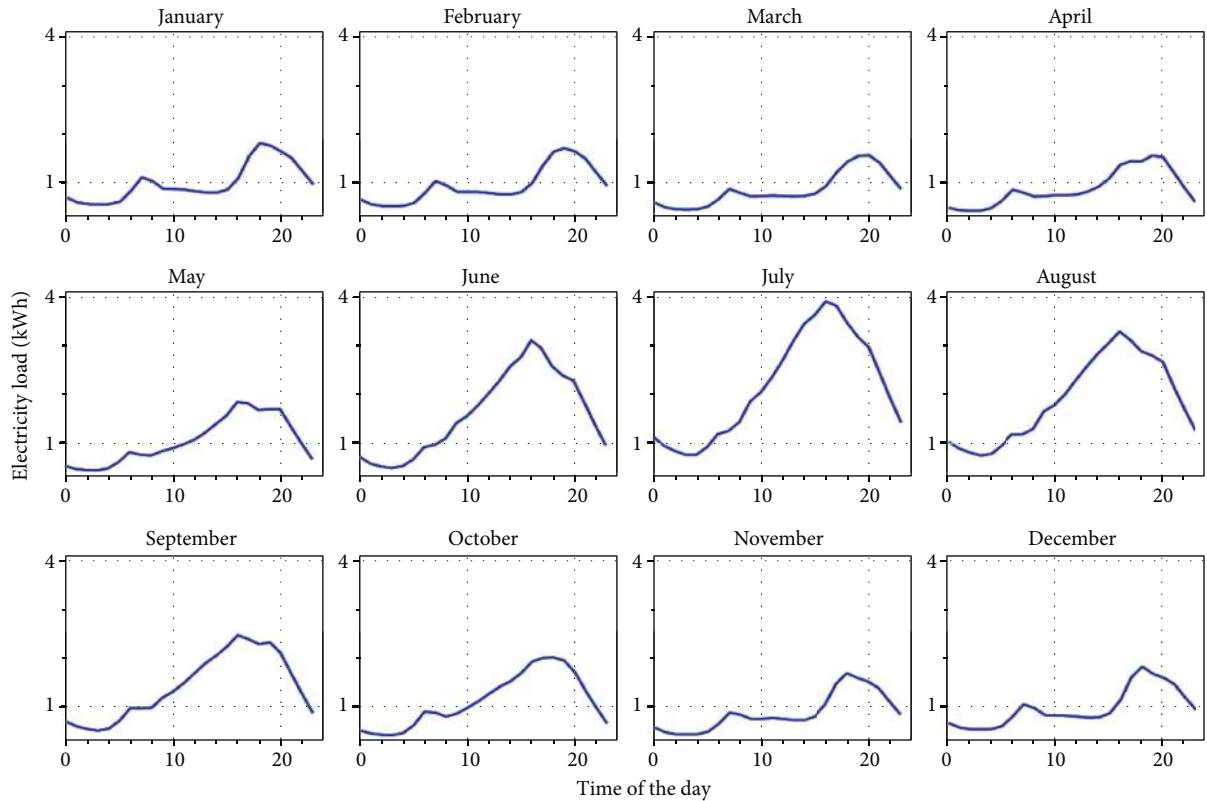

FIGURE 17: Load profile.

year life expectancy, with a 0.5 percent annual deterioration factor, while the inverter's life expectancy is set at 15 years.

(2) *CSP System.* CSP technologies absorb and concentrate DNI incident on the earth's surface to heat a working fluid and then generate energy via a thermodynamic cycle. The solar resource assessment is crucial for solar project site selection, annual power generation forecasting, and temporal output forecasting. Many factors go into determining the best locations for CSP installations in a country, but the availability of good solar resources (i.e., DNI) is critical [155]. For modeling CSP plants in the specified locations, reliable hourly DNI predictions are needed. The study introduces a methodology that can be used to investigate the techno-economic feasibility of CSP technology in other developing countries, especially those in Sub-Saharan Africa since the methodology addresses the effects of such economies' high financial uncertainties. A solar tower plant was chosen to be implemented in our study because it has the highest annual electrical energy generation, higher capacity factor, and lowest levelized cost of electricity.

In this report, Mukungu village, which is located in the Karongi district of Rwanda's western province and has GPS coordinates of S 02o13 9310' and E 29o24.590', was chosen to be used. Table 9 shows the survey site's essential topography and ambient weather conditions (as determined by the NSRDB). Different parameters like direct normal irradiation (DNI), global horizontal irradiance (GHI), and

direct horizontal irradiance (DHI) are presented as shown in Figure 16.

6.1.5. *Load Demand.* The selected site as illustrated in Table 10 shows the monthly energy usage of the area based on real electricity bills. There is no significant change in load consumption since there is no summer or winter as a result of moderate temperature. The average annual average load consumption is 232 kWh/m². The monthly cumulative electricity consumption is used by the system advisor model to approximate the monthly and annual load demands as shown in Figure 17.

6.1.6. *System Costs and Economic Parameters.* The capital cost, operating maintenance cost, and running cost of residential PV systems all play a role in the project's economic viability. The technology and installation costs were calculated using the cost database of the International Renewable Energy Agency (IRENA) [156]. The overall cost of capital investment is estimated to be \$11,529.46. Dissimilar to rotary power conversion technologies, a PV system has no tangible operating costs, though dust accumulation on the PV module's surface necessitates minimal cost of maintenance. The annual cost of operation and maintenance (O&M) is calculated to be \$9 per kW. Furthermore, financial variables such as Rwanda's interest and inflation rates were also taken into account. The deposit fraction (percentage of total capital cost to be borrowed) is set at 100% in this report, with a five-year loan term and a 2.5 percent interest rate.

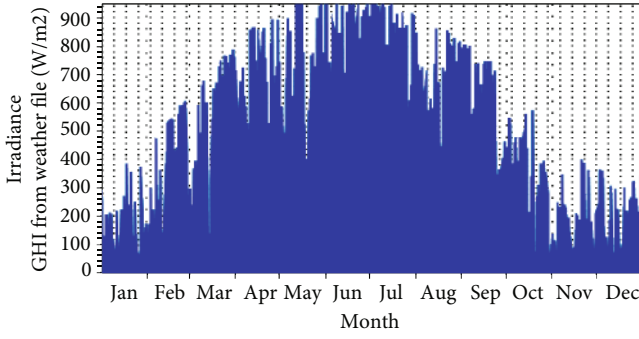

FIGURE 18: Time series data of GHI.

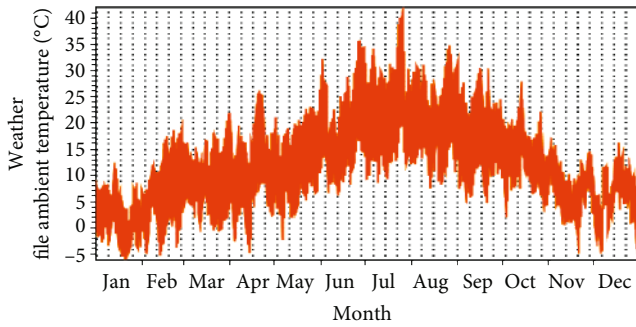

FIGURE 19: Time series data of ambient temperature.

6.1.7. Solar Resource. Solar irradiance and ambient temperature are two important factors that affect the performance of a PV system. As a result, the main inputs for estimating the system's size and performance are daily average solar radiation and daily average ambient temperature. Rwanda is located on a horizontal surface near the equator, with plenty of sunshine and global solar radiation ranging from 4.8 to 5.5 kWh/m²/day [41]. The PV module output as shown in equation (1) can be calculated by [157]

$$P_{PV} = Y_{PV} f_{PV} \left(\frac{G_T}{G_{T,STC}} \right) [1 - \alpha P (T_C - T_{C,STC})], \quad (1)$$

where Y_{PV} is the PV power output under standard test conditions (kW), f_{PV} is the PV module derating factor (%), G_T refers to the solar radiation incident on the PV module (kW/m²), $G_{T,STC}$ represents the incident radiations at STC (1 kW/m²), αP indicates the temperature coefficient of power (%/°C), T_C refers to PV cell temperature in the current time step (°C), and $T_{C,STC}$ is PV cell temperature at STC (°C).

A system advisor model allows the user to download data files from the National Solar Radiation Database (NSRDB) or upload any available climatic data in a comma-separated values (CSV) format for solar resource data for sites not included in the software library for the selected location.

In this study, we used data derived from the weather data of 2019 downloaded from NSRDB. The global horizontal irradiance (GHI) and ambient temperature time series data are presented in Figures 18 and 19 based on the data obtained.

6.2. Economic Metrics Modeling for CSP and PV. In order to determine energy management policies for any country, feasibility analyses and assessments of different energy system projects are essential. A viability study helps capital owners make the best decisions by contributing to the optimal allocation of energy resources at the state level. The LCOE and NPV metrics were used to calculate the viability of the power plants to perform the economic analysis. The software's financial model determines the project's inflows and outflows of cash over the course of its operating period. The value of electricity produced, incentives, project capital costs, operating and maintenance costs, dividends, and debt are all included in cash flow. The model also determines the after-tax cash flow's net present value and the payback period, which is the time it takes for the total after-tax cash flow to cover the project's initial capital cost.

6.2.1. Levelized Cost of Energy (LCOE). Over the project's lifetime, the levelized cost of energy (LCOE) estimates the price of per unit energy (\$/kWh). The LCOE is a metric that is used to compare the kWh costs of various power system technologies. As expressed in equation (2), the LCOE is calculated by dividing the project's lifespan cost by the predicted energy output [158].

$$LCOE = \frac{LCC}{E_{grid}}, \quad (2)$$

where LCC is shown in equation (3) which is the lifecycle cost and E_{grid} is the system energy yield. The lifecycle cost covers the initial capital cost, operation, and maintenance costs, as well as the substitution cost minus the salvage value, which is the project value at the end of the system's lifecycle.

$$LCC = C_{capital} + \sum C_{O\&M} + \sum C_{replacement} - C_{salvage}, \quad (3)$$

where $C_{capital}$ is the capital cost, $C_{O\&M}$ is the operation and maintenance cost, $C_{replacement}$ is the replacement cost, and $C_{salvage}$ is the salvage value or the project value at end of life.

The modeled CSP plants' main goal is to reduce the levelized cost of electricity (LCOE) provided by the CSP installations over their lifetime. To optimize a CSP plant, evaluate the TES capability and solar field size (i.e., SM) that maximize the economic benefits (i.e., reduce the LCOE). The ideal solar field area should optimize the amount of time the solar field produces enough thermal energy to drive the power block (at its rated capacity), reduce installation and operating costs, and take into account the TES system's efficiency and cost-effectiveness. The whole project lifespan costs and the total amount of electricity provided by the system are accounted for in the LCOE.

The model calculates both the real and the nominal LCOE for CSP as illustrated in equation (4). The nominal LCOE is a current dollar value, while the real LCOE is a fixed dollar (inflation-adjusted) value. The real (current) dollar LCOE was used in our analysis because it is more suitable for long-term analyses (to account for many years of inflation over the project life), while the nominal (constant) dollar

LCOE is more appropriate for short-term analyses (to account for many years of inflation over the project period). The following equation shows the real LCOE [159]:

$$\text{LCOE}(\text{real}) = \frac{-C_0 - (\sum_{n=1}^N c_n / (1 + d_{\text{nominal}})^n)}{(\sum_{n=1}^N Q_n / (1 + d_{\text{real}})^n)}, \quad (4)$$

where Q_n (kWh) is electricity generated by the system in year n (calculated by the performance model), N is the analysis period in years, C_0 is the project's equity investment amount, C_n is the annual project costs in year n (incl. installation, operation and maintenance, financial costs and fees—account for developer's margin defined by the project's internal rate of return, and tax benefit or liability and also account for incentives and salvage value), d_{real} is the real discount rate (the discount rate without inflation), and d_{nominal} is the nominal discount rate (the discount rate with inflation).

6.2.2. Net Present Value (NPV). The distinction between today's cash inflow and cash outflow over the lifetime of a project or company is referred to as the net present value. NPV in equation (5) is calculated during the planning phase of a project to determine its profitability, as shown in the following [160]:

$$\text{NPV} = \sum_{t=0}^N \frac{\text{revenue}_t - \text{cost}_t}{(1 + d)^t}, \quad (5)$$

where N is the number of years of the economic analysis, t is the year variable in each summation, d refers to the discount rate, revenue_t is the PV system revenue in year t , and cost_t represents the system cost in year t .

6.2.3. Internal Rate of Return (IRR). The internal rate of return is the discount rate at which the net present value of a specific investment's cash flow is zero. This rate is used to determine whether or not a potential investment would be profitable [160]. It can be calculated in equation (6) as follows:

$$\text{IRR} : \text{NPV} = \sum_{t=0}^N \frac{\text{revenue}_t - \text{cost}_t}{(1 + d)^t} = 0. \quad (6)$$

6.2.4. Payback Period (PbP). The time it takes for an investment to pay for itself in terms of earnings or net cash flow is known as the payback period. A simple payback period and a discounted payback period are the two types of payback periods. A simple payback period is one where the income equals the investment cost, whereas a discounted payback period takes the time value of money into the account. For residential PV systems, a simple payback period is provided as shown in equation (7) as follows [160]:

$$\text{Simple payback period} = \frac{\text{PV price} - \text{federal ITC}}{\text{annual PV revenue} - \text{O\&M}}. \quad (7)$$

6.3. Results and Analyses

6.3.1. Technical Analysis. The technoeconomic results for the modeled 5 kW solar PV power plant and 50 MW concentrated solar tower for the chosen Rwandan site are presented in this section. According to simulation results, the Mukungu solar power plant (PPP) produced good annual energy, owing to the area's high solar radiation. PV power plants differ from other renewable energy sources in that they go offline at sunset and stay that way until sunrise, which contributes to their low-capacity factor (CF) values when compared to other power plants. From the results obtained, the selected site has a CF of 15.5% and the recorded CF for the studied area is within the permissible CF range for PV power plants all over the world. According to [161], the CF for fixed mounted PVs around the world, as in the case of the modeled PV power plants in this research, ranges from 15% to 21%, putting this work on the right track in terms of performance, similar to what is currently available in other operating power plants around the world.

On the other hand, for CSP systems, the parameters representing energy quantities and the total energy production, the performance ratio, and the capacity factor are among their components. These variables aid in the evaluation of similar projects in order to decide which is the most efficient. To evaluate the effectiveness of the CSP technologies examined, the total energy yield (annual electrical energy generation (AEG)), the capacity factor (CF), the land (area) requirement, and the annual water usage/consumption (AWU) have been used.

6.3.2. Energy Production. The simulation result indicates that the total monthly energy production over the first year varies between 195 kW in January and 300 kW in July. The total electric energy generated by the system in the first year is estimated to be 839 kWh, with the monthly energy produced as shown in Figure 20 with an average of 416 kWh.

The annual energy production over the lifetime period is depicted in Figure 21. CSP systems focus the sun's energy using reflective devices to generate heat, which is then used to generate electricity. The upfront and the overall cost is high though the output power is also high.

6.3.3. Economic Analysis. The levelized cost of energy, payback period, and net present value are all part of the economic feasibility analysis for the PV system. The economic indicators for the PV system are summarized in Table 11 after determining the system's lifetime expenses and revenues using IRENA's renewable energy cost estimate. The nominal and real LCOEs are 0.96 \$/kWh and 0.76 \$/kWh, respectively. The nominal and real LCOE are both competitive with Rwanda's electrical company tariff.

The LCOE is a useful tool for comparing the cost of PV energy production in different sites or with alternative power generation, but it is insufficient for determining financial profitability. That is why the net present value and payback time

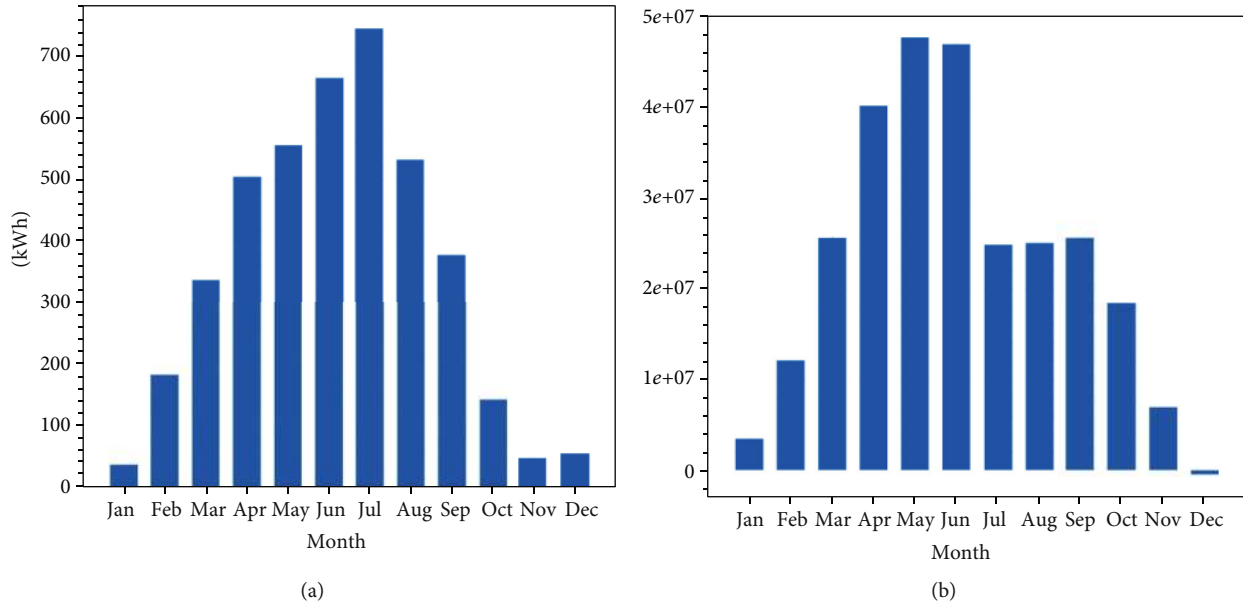

FIGURE 20: Monthly energy production (a) by the PV system and (b) by the CSP system.

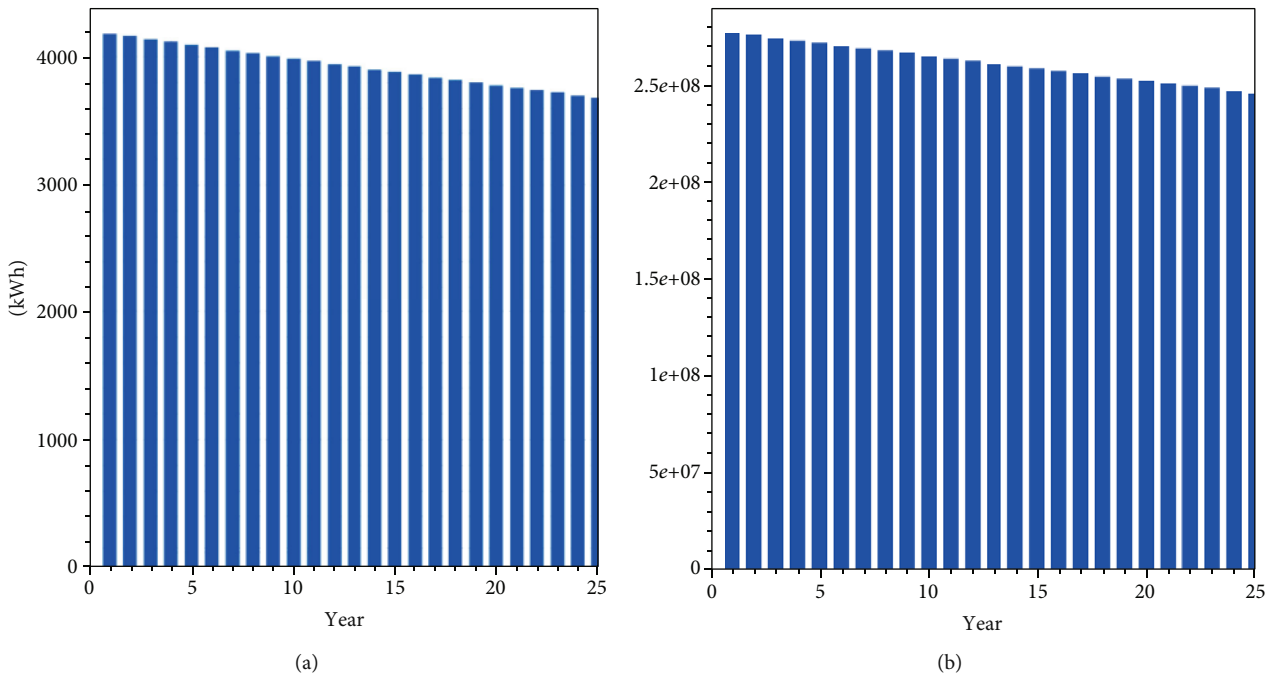

FIGURE 21: Total yearly lifetime energy yield (a) by the PV system and (b) by the CSP system.

are calculated. The net present value is one of the key principles that cannot be overlooked when evaluating grid-connected PV system feasibility. The net present value depicts the current worth of future net income over the task's lifetime. The estimated net present value of the system over its lifetime is \$131,239 for our PV system while it is \$451.091million for our CSP system which is big compared to that for the PV system. CSP provides a lot of electricity to the user but investment cost is very high compared to the PV system. A positive NPV means that the investor is making money and vice versa as shown in Table 11. This PV system discounted payback

period, or the amount of time it will take to recoup its investment cost is 11.1 years. LCOE and NPV indicators highlight residential PV systems' competitiveness as electric utilities in terms of energy costs. The long-term discounted payback period, on the other hand, decreases the investment appeal and desirability of PV system installation for investors.

Eventually, we compared the optimized cost metrics of a 50 MW solar CSP power plant under the same condition with PV. To evaluate the performance of the CSP technologies under consideration, the total energy yield (annual electrical energy production (AEP)), the capacity factor (CF), the land

TABLE 11: Economic evaluation between PV and CSP systems.

Indicator	PV	CSP
LCOE (nominal)	0.82 \$/kWh	16.89 ¢/kWh
LCOE (real)	0.24 \$/kWh	14.08 ¢/kWh
Electricity bill without the system (year 1)	\$474	—
Electricity bill with the system (year 1)	\$175	—
Net saving with the system (year 1)	\$298	—
NPV	\$131,239	—
Simple payback period	6 years	—
Discounted payback period	11.1 years	25 years
Net capital cost	\$13,400	\$899,820,288
Loan	\$13,400	—
Equity	\$0	\$1,247,413,248
Capacity factor	—	21.0%
Annual water usage	—	79,921 m ³
Year IRR is achieved	—	25 years
Annual net electrical energy production	—	505,789,536 kWh

(area) requirement, and the annual water consumption (AWC) were used. The levelized cost of electricity (LCOE), an economic estimate of the cost of energy from a generating project, is the value at which electricity from a given source must be produced in order for the project to break through over its lifespan. Because the study is based on a long-term scenario, the real LCOE, instead of the nominal one, is more fitting. The modeled solar tower CSP that was chosen due to its potential to work in hotter conditions (high temperature) has an LCOE of 14.08 ¢/kWh (¢/kWh, cent per kilowatt hour) which is high with respect to that of the PV system. Having a positive net present value of \$451.091 million means that the project is viable. They do, however, have the highest overall installation cost (OIC), which is approximately \$643.90 million compared to the PV system. Some parameters as shown in Table 11 determine our CSP solar tower output characteristics and PV system.

7. Discussion

Geographical position, political stability, and the availability of the RE Act were established as the key strengths for the sector as the results of the weighted analysis. The key opportunities are regional integration and growing electricity demand, while inadequate research and development (R&D) and changing environmental conditions are the main challenges to the successful development of RE in the country.

A strong desire for growth in the industrial, commercial, and domestic sectors in Rwanda will increase electricity demand. The erratic and unpredictable existence of solar energy can be replaced by CSP thermal energy storage technology, and its advancement is of great importance for the welfare of human communities.

To ensure solar energy access to the people of developing countries requires understanding their everyday life. Finance conditions dictate whether or not the implementation of the project will be successful or not. SAM as a computer technoe-

conomic model that helps financial metrics of renewable energy projects has made easy the decision making on the project feasibility. Technologies represented in SAM include photovoltaics (flat plate and concentrating), concentrating solar power (parabolic troughs, towers, linear Fresnel, dish Stirling), solar water heating, wind, geothermal, and biomass [162]. Project developers, equipment manufacturers, and researchers use SAM results in the process of evaluating financial, technological, and incentive options for the renewable energy project. SAM calculates the levelized cost of energy (LCOE) and other metrics for renewable energy projects by integrating annual time series power output models with financial models [163]. The final results of SAM allowed researchers to look at patterns for various system designs and compare them to other technologies.

Thermal storage involves transferring usable energy from the collector to the storage medium, which is converted into a rise in internal energy. Solar energy can be captured and stored by thermal, electrical, chemical, and mechanical methods [164]. This can happen with or without a phase change. Storage medium, tube, insulation, heat exchangers, heat-transfer fluid, pumps or blowers, and controls are commonly found in the recognizable subsystem. The storage temperature(s) and the storage period are two factors to consider when selecting a thermal storage device. Some storage technologies are currently being demonstrated to add value to solar, but a cost reduction is needed to achieve broader profitability [165]. The storage shall possess the following properties to be very useful to the users: (a) storage properties—high storage capacity, long charge/discharge times, good partial-load feature, and acceptable round-trip efficiency and (b) financial performance—low price per kWh heat energy stored, easy to maintain, and environment friendly [166]. The storage systems are projected to have a combined power rating of 1–20 MW (charging and discharging) and a storage capacity of 2–6 hours for on-demand transmission to the electric grid [167].

Stand-alone PV solar home systems (SHSs) and solar lamps (which are collectively referred to as off-grid solar devices, as well as solar PV minigrids) are some of the modern solutions that have rapidly increased in popularity throughout the developing countries [168]. Rwanda declared goals to improve access to electricity to even more than 70 percent by 2018, out of which 22 percent will be by off-grid connections [169]. At least 9% of the citizens in at least ten territories—Benin, Burkina Faso, Fiji, Jordan, Kenya, Papua New Guinea, Rwanda, Samoa, Tanzania, and Vanuatu—has gained from off-grid solar lighting systems [169]. In Table 5, the report in 2018 compares Rwanda's success in terms of renewable energy access to that of other countries with comparable levels of growth. The Rwandan government has shown transparent and massive support for the off-grid solar sector and included it in its budget of Economic Development and Poverty Reduction Strategy II [170]. In Sub-Saharan countries, e.g., Rwanda like other countries, grid connections are typically only located in the urban centers and their neighborhoods. Electricity companies do not have enough generating capacity or facilities to increase access to electricity [171–173]. Due to the human landscape of the country, where a significant majority of the population reside in rural areas and smaller communities, widespread access to electricity by grid extension is extremely expensive [171, 174, 175].

Given high energy savings and high energy efficiency, CSP plants are expected to generate a global electricity supply of 7% by 2030 and 25% by 2050 and could reach up to 6% of the world's energy demand by 2030 and 12% by 2050, as per the European Solar Thermal Power Association's forecasts [7]. Many variables demand the need to broaden or diversify the energy generation mix of a nation. For its electricity production, Rwanda relies mainly on hydro and fossil fuels. This puts a lot of pressure on the country's budget as fossil fuel prices rise, particularly as the country imports more fuel to run its thermal power plants.

Research on the SWOT study of the RE sector in Rwanda suggests the following suggestions for policy makers and decision makers in the country to assist with the growth of the RE sector.

- (i) Strengthen political regime: the country's stable politics of sustainability and development needs to be strengthened to further open up the country to domestic and foreign investments. The continuity of foreign direct investment (FDI) projects, in particular projects that are severely affected by current policies, is maintained by a stable political regime [176]. This is because FDI ventures are generally long-term investments, so investors prevent such investments in nations with risks that could adversely affect their potential return. In certain situations, political uncertainty leads to changes in policies, economic support, and legislation that pose a major challenge to FDI projects in the RE sector [177].
- (ii) Foreign cooperation: because of the high initial investments necessary for RES growth, it is difficult for the country to fund large-scale power plants

alone, hence the need for foreign participation. By offering consistent policy support that can survive any regime change, the government can encourage international cooperation

- (iii) Enhance research and development: this sector is efficient with strong R&D, the higher the sector's production, the more energy generated, and therefore, it will be necessary for the government to take a serious look at R&D. A research fund for the sector needs to be set up where research centers can access funds to embark on their research. By setting up technology centers where such research can be sent for further study and commercialization if bankable, the situation where research performed by scientists is not commercialized can also be reduced

With broad consensus among various stakeholders, the SWOT analysis revealed several supporting and limiting factors. Due to solar energy abundance, Rwanda will be positively and significantly impacted if it is well exploited. Therefore, minigrids and PVs are mostly encouraged to get affordable electricity to the people. This is so because the solar power plant construction period is shorter and quicker than other forms of energy. This may positively impact the Rwandan economy as the price of energy may fall and people may access it more readily.

Nonetheless, the SWOT study found some risks that could prevent this from happening. A typical burden for the government to invest in new generation capacity has been the heavily subsidized electricity costs. Since most solar energy, especially CSP, requires a large financial investment to be bankable or feasible, a national policy based on recruiting investors might demonstrate the energy development potential in solar energy by generating new plans to privatize the solar energy market.

8. Conclusion

In general, Rwanda has already accepted the critical role of electricity in enhancing the health and living conditions of its citizens. To this end, the country has been working vigorously to increase the rate of electrification especially in rural and remote areas where the distribution of electricity is generally difficult. For example, the Sustainable Energy for All (SE4All) Initiative launched in 2011 was mainly to boost the contribution of energy from renewables in the overall energy mix. It was also initiated to serve as a direct response to the problems of electricity shortage that was observed in the country, especially in the regions far away from the grid connection. High energy cost has been a heavy burden for the low- and middle-income people and it has greatly affected both their economic growth and basic infrastructure development. In this study, we summarized the status quo of CSP and PV systems in Rwanda by considering their strengths, weaknesses, opportunities, and threats (SWOT). Also, we conducted the techno-economic assessment on the practicability of PV and CSP systems and implementation using the System Advisor Model (SAM). The results of the

study provide an overview of the features of the solar technologies available.

The input data used in the implementation of the SWOT analysis were obtained from relevant shareholders from the government, power producers, and operators of mini-grid off-grid private companies in Rwanda. The study examined the likelihood of finding a reliable and affordable power generation system by considering the accessibility of people in the low- and middle-income groups. This is because the electric grid is not widely available to the masses, especially to those living beyond urban areas where regular power outages lead to significant losses. When the grid is down, customers must absorb the loss of production or resort to the relatively high cost of diesel backup power. The techno-economic performance and financial metrics result from modeled PV and CSP systems using SAM are shown in Table 11. The net present value has proved that the viability of both PV and CSP is possible where the net capital investment for PV is low compared to that for CSP. Also, both the Levelized and the project internal rate of return showed that the investment can be returned after a short period for the PV system than for the CSP system. Therefore, the viability of CSP can be greatly influenced by the government budget as it requires lots of money; PV system design and implementation are preferred due to its low investment cost and payback period.

Recently, the implementation of huge hydropower projects in Rwanda has destroyed large areas of the country. Through the SWOT analysis and using the data from government, power producers, and mini-grid off-grid private companies, the scenarios for deploying the CSP and PV systems are recommended as the first choice to boost sustainable energy for all in Rwanda (achieving universal energy access). As Rwanda receives some of the highest levels of annual radiation globally, people have to understand the contribution that solar energy could make in enhancing access to energy for all using PV and CSP plants. Undoubtedly, renewable energy such as solar PV is one of the best technologies to tackle the issues of the rising of carbon emissions, as the former does not pose any threat to key conservation areas in the country. Accordingly, the proposed solar technologies could be applied to other rural areas in Sub-Saharan African countries and elsewhere in the world, particularly the regions with similar climate conditions and SWOT analysis factors.

From the very recent literature of the Rwanda power sector and elsewhere, the comparison summary describing the analysis of the SWOT methodology is provided in Table 7. In light of this, we believe that both the PV and CSP technologies can significantly boost the continued implementation of Sustainable Energy for All (Se4all) in Rwanda today, tomorrow, and beyond. Although our findings have shown that CSP systems have the potential of producing a large amount of electricity which can serve a big number of citizens and help to avoid frequent power outages in the country, the initial/upfront investment and material use pose a big barrier to the investor wherein a country like Rwanda, people can be exposed to the high cost of electricity. However, the CSP system is more advantageous for industrial use and other big projects and this study recommends the implementation of PV solar technology for general use (i.e.; to provide

utility-scale electricity for the people who do not have access to electricity) to accelerate the universal electrification in Rwanda due to its availability, reliability, and affordability.

Data Availability

The data used to support the findings of this study are available from the corresponding author upon request.

Conflicts of Interest

The authors declare no conflict of interest.

Acknowledgments

This research was supported by the Natural Science Foundation of Fujian Province (Grant no. 2017J01728) and the Fujian University of Technology (Grant no. GY-H-20154).

References

- [1] V. Quaschnig, *Understanding Renewable Energy Systems - (Malestrom)*, Earthscan, 2005.
- [2] International Energy Agency, *Solar energy perspectives2020*, <http://www.eng.uc.edu/~beaucag/C1asses/SolarPowerForAfrica/SolarEnergyPerspectives6111251e.pdf>.
- [3] B. Online, "Nuclear fusion energy 8.1," *Online8-112011*, http://www.pitt.edu/~tjs120/writing_assignment_3.pdf.
- [4] "The future of solar is bright - science in the news," 2020, <http://sitn.hms.harvard.edu/flash/2019/future-solar-bright/>.
- [5] A. Kumar, O. Prakash, and A. Dube, "A review on progress of concentrated solar power in India," *Renewable and Sustainable Energy Reviews*, vol. 79, pp. 304–307, 2017.
- [6] M. S. Răboacă, G. Badea, A. Enache et al., "Concentrating solar power technologies," *Energies*, vol. 12, no. 6, pp. 1–17, 2019.
- [7] Estela, Greenpeace, and SolarPACES, *Solar thermal electricity - global outlook 2016*, 2016.
- [8] ASES, SolarPACES, SEIA, and EREN, "Concentrating solar power : energy from mirrors," *Energy Effic. Renew. energy2001*, <http://www.nrel.gov/docs/fy01osti/28751.pdf>.
- [9] J. Jorgenson, M. Mehos, and P. Denholm, "Comparing the net cost of CSP-TES to PV deployed with battery storage," in *AIP Conference Proceedings*, vol. 1734, p. 080003, AIP Publishing LLC, 2016.
- [10] J. D. D. Niyonteze, F. Zou, G. Norensé Osarumwense Asemota, S. Bimenyimana, and G. Shyirambere, "Key technology development needs and applicability analysis of renewable energy hybrid technologies in off-grid areas for the Rwanda power sector," *Heliyon*, vol. 6, no. 1, article e03300, 2020.
- [11] S. J. Wagner and E. S. Rubin, "Economic implications of thermal energy storage for concentrated solar thermal power," *Renewable Energy*, vol. 61, pp. 81–95, 2014.
- [12] P. Hersch and K. Zweibel, "Basic photovoltaic principles and methods," *Antimicrobial Agents and Chemotherapy*, vol. 58, no. 12, pp. 7250–7257, 1982.
- [13] W. Fuqiang, G. Zhennan, T. Jianyu, M. Lanxin, Y. Zhenyu, and T. Heping, "Transient thermal performance response characteristics of porous-medium receiver heated by multidish concentrator," *International Communications in Heat and Mass Transfer*, vol. 75, pp. 36–41, 2016.

- [14] X. Chen, X. L. Xia, X. L. Meng, and X. H. Dong, "Thermal performance analysis on a volumetric solar receiver with double-layer ceramic foam," *Energy Conversion and Management*, vol. 97, pp. 282–289, 2015.
- [15] T. Stoffel, D. Renné, D. Myers, and S. Wilcox, *Concentrating Solar Power Best Practices Handbook for the Collection and Use of Solar Resource Data*, National Renewable Energy Lab.(NREL), Golden, CO (United States), 2010.
- [16] B. Belgasim, Y. Aldali, M. J. R. Abdunnabi, G. Hashem, and K. Hossin, "The potential of concentrating solar power (CSP) for electricity generation in Libya," *Renewable and Sustainable Energy Reviews*, vol. 90, pp. 1–15, 2018.
- [17] A. Kassem, K. Al-Haddad, and D. Komljenovic, "Concentrated solar thermal power in Saudi Arabia: definition and simulation of alternative scenarios," *Renewable and Sustainable Energy Reviews*, vol. 80, pp. 75–91, 2017.
- [18] Concentrating Solar Power, "Technology Roadmap Concentrating Solar Power," *Current*, vol. 5, pp. 1–52, 2010.
- [19] J. J. C. S. Santos, J. C. E. Palacio, A. M. M. Reyes, M. Carvalho, A. J. R. Freire, and M. A. Barone, "Concentrating solar power," *Advances in Renewable Energies and Power Technologies*, vol. 1, pp. 373–402, 2018.
- [20] M. I. Soomro, A. Mengal, Q. N. Shafiq, S. A. Ur Rehman, S. A. Soomro, and K. Harijan, "Performance improvement and energy cost reduction under Different scenarios for a parabolic Trough Solar Power Plant in the Middle-East Region," *Processes*, vol. 7, no. 7, p. 429, 2019.
- [21] M. I. Soomro, A. Mengal, Y. A. Memon, M. W. A. Khan, Q. N. Shafiq, and N. H. Mirjat, "Performance and economic analysis of concentrated solar power generation for Pakistan," *Processes*, vol. 7, no. 9, p. 575, 2019.
- [22] J. Liu, D. Lei, and Q. Li, "Vacuum lifetime and residual gas analysis of parabolic trough receiver," *Renewable Energy*, vol. 86, pp. 949–954, 2016.
- [23] H. L. Zhang, J. Baeyens, J. Degreève, and G. Caceres, "Concentrated solar power plants: Review and design methodology," *Renewable and Sustainable Energy Reviews*, vol. 22, pp. 466–481, 2013.
- [24] "Renewables global status report - REN21," 2021, <https://www.ren21.net/reports/global-status-report/>.
- [25] A. Ummadisingu and M. S. Soni, "Concentrating solar power - technology, potential and policy in India," *Renewable and Sustainable Energy Reviews*, vol. 15, no. 9, pp. 5169–5175, 2011.
- [26] S. Skouri, S. Bouadila, M. Ben Salah, and S. Ben Nasrallah, "Comparative study of different means of concentrated solar flux measurement of solar parabolic dish," *Energy Conversion and Management*, vol. 76, pp. 1043–1052, 2013.
- [27] T. Mancini, P. Heller, B. Butler et al., "Dish-Stirling systems: an overview of development and status," *Journal of Solar Energy Engineering, Transactions of the ASME*, vol. 125, no. 2, pp. 135–151, 2003.
- [28] T. Jennings and L. Parsons, "Concentrated Solar Power-Focusing the sun's energy for large-scale power generation," *Environmental and Energy Study Institute*, pp. 1–4, 2009.
- [29] L. Martín and M. Martín, "Optimal year-round operation of a concentrated solar energy plant in the south of Europe," *Applied Thermal Engineering*, vol. 59, no. 1–2, pp. 627–633, 2013.
- [30] L. Dawson and P. Schlyter, "Less is more: strategic scale site suitability for concentrated solar thermal power in Western Australia," *Energy Policy*, vol. 47, pp. 91–101, 2012.
- [31] C. Breyer and G. Knies, "Global energy supply potential of concentrating solar power," 2009, 2020, http://www.desertec-uk.org.uk/reports/Breyer_paper_SolarPACES_GlobalEnergySupplyPotentialCSP_final_090630_proc.pdf.
- [32] M. Krarti, "Integrated design of communities," in *Optimal design and retrofit of energy efficient buildings, communities, and urban centers*, pp. 385–470, Elsevier, 2018.
- [33] I. Purohit and P. Purohit, "Techno-economic evaluation of concentrating solar power generation in India," *Energy Policy*, vol. 38, no. 6, pp. 3015–3029, 2010.
- [34] O. M. Abubakar and B. I. Adamu, "Comparative study of monocrystalline and polycrystalline silicon solar modules in Kebbi state environment," vol. 10, no. 9, 2019, <https://www.ijser.org/researchpaper/Comparative-Study-of-Monocrystalline-and-Polycrystalline-Silicon-Solar-Modules-in-Kebbi-State-Environment.pdf>.
- [35] ITRPV, "International technology roadmap for photovoltaics (ITRPV): Crystalline silicon technology-current status and outlook," in *Proceedings of the PV Manufacturing in Europe Conference*, pp. 18–40, Brussels, Belgium, 2017.
- [36] A. K. S. David Tan, *Handbook for Solar Photovoltaic Systems*, Energy Mark. Authority, Singapore Publ., 2011.
- [37] *Handbook for Solar Photovoltaic (PV) Systems Contents2020*, https://www.bca.gov.sg/publications/others/handbook_for_solar_pv_systems.pdf.
- [38] "Rwanda | The Commonwealth," 2020, <https://thecommonwealth.org/our-member-countries/rwanda>.
- [39] "Environmental and social management and framework for RSSP 3," *Rural Sector Support Project (RSSP 3)2020*, <http://documents1.worldbank.org/curated/en/285631468336663680/text/E28960v10P126400Box369243B00PUBLIC0.txt>.
- [40] S. Bimenyimana, G. N. O. Asemota, and L. Li, "The state of the power sector in Rwanda: a progressive sector with ambitious targets," *Frontiers in Energy Research*, vol. 6, 2018.
- [41] C. Museruka and A. Mutabazi, "Assessment of global solar radiation over Rwanda," in *2007 International Conference on Clean Electrical Power*, pp. 670–676, Capri, Italy, 2007.
- [42] B. K. Safari and J. Gasore, "Estimation of global solar radiation in Rwanda using empirical models," *Asian Journal of Scientific Research*, vol. 2, no. 2, pp. 68–75, 2009.
- [43] Rwanda Energy Group (REG), *Evaluation of the installed generation capacity2020*, <https://www.reg.rw/index.php?id=2>.
- [44] C. Turchi, "Solar power and the electric grid grid 101: how does the electric grid work?," 2020, <https://www.nrel.gov/docs/fy10osti/45653.pdf>.
- [45] "Rwanda economic update: making electricity accessible and affordable," 2020, <https://www.worldbank.org/en/news/feature/2019/07/01/rwanda-economic-update-making-electricity-accessible-and-affordable>.
- [46] J. Polo, L. Martín, and J. M. Vindel, "Correcting satellite derived DNI with systematic and seasonal deviations: application to India," *Renewable Energy*, vol. 80, pp. 238–243, 2015.
- [47] J. D. D. Uwisengeyimana, A. Teke, and T. Ibriki, "Current overview of renewable energy resources in Rwanda," *Journal of Energy and Natural Resources*, vol. 5, no. 6, pp. 92–97, 2016.
- [48] E. Kabir, P. Kumar, S. Kumar, A. A. Adelodun, and K. H. Kim, "Solar energy: potential and future prospects," *Renewable and Sustainable Energy Reviews*, vol. 82, pp. 894–900, 2018.

- [49] “Solar resource maps and GIS data for 180+ countries | Solar-gis,” 2020, <https://solargis.com/maps-and-gis-data/download/rwanda>.
- [50] J. Uwibambe, *Design of photovoltaic system for rural electrification in Rwanda*, [M. S. thesis], Universitetet i Agder; University of Agder, 2017, <http://dr.ur.ac.rw/bitstream/handle/123456789/201/JeannineUwibambe.pdf?sequence=1&isAllowed=y>.
- [51] S. Bimenyimana, G. N. O. Asemota, J. D. D. Niyonteze, C. Nsengimana, P. J. Ihirwe, and L. Li, “Photovoltaic solar technologies: solution to affordable, sustainable, and reliable energy access for all in Rwanda,” *International Journal of Photoenergy*, vol. 2019, Article ID 5984206, 29 pages, 2019.
- [52] H. Eustache, D. Sandoval, U. G. Wali, and K. Venant, “Current status of renewable energy technologies for electricity generation in Rwanda and their estimated potentials,” *Energy and Environmental Engineering*, vol. 6, no. 1, pp. 8–15, 2019.
- [53] Rwanda Energy Group (REG), *Solar2020*, <https://www.reg.rw/what-we-do/generation/solar/>.
- [54] G. Geoffrey, D. Zimmerle, and E. Ntagwirumugara, “Small hydropower development in Rwanda: trends, opportunities and challenges,” *IOP Conference Series: Earth and Environmental Science*, vol. 133, no. 1, p. 012013, 2018.
- [55] L. G. Rosa, J. Cruz Fernandes, and B. Li, “Structural integrity assessment of glass components in concentrated solar power (CSP) systems,” *Theoretical and Applied Fracture Mechanics*, vol. 80, pp. 14–21, 2015.
- [56] E. M. Framework, “Environmental and social management framework,” May 2018, <http://documents1.worldbank.org/curated/en/231671528451531272/pdf/SAIP-Environmental-and-Social-Management-Framework.pdf>.
- [57] “Rwanda’s largest solar field also empowers orphans | Voice of America - English,” 2020, <https://www.voanews.com/silicon-valley-technology/rwandas-largest-solar-field-also-empowers-orphans>.
- [58] “Rwanda energy sector review and action plan,” 2020, https://www.afdb.org/fileadmin/uploads/afdb/Documents/Project-and-Operations/Rwanda_-_Energy_Sector_Review_and_Action_Plan.pdf.
- [59] X.-z. Li, Z.-j. Chen, X.-c. Fan, and Z.-j. Cheng, “Hydropower development situation and prospects in China,” *Renewable and Sustainable Energy Reviews*, vol. 82, pp. 232–239, 2018.
- [60] M. Dorber, R. May, and F. Verones, “Modeling net land occupation of hydropower reservoirs in Norway for use in life cycle assessment,” *Environmental Science & Technology*, vol. 52, no. 4, pp. 2375–2384, 2018.
- [61] S. Pacca and A. Horvath, “Greenhouse gas emissions from building and operating electric power plants in the upper Colorado river basin,” *Environmental Science & Technology*, vol. 36, no. 14, pp. 3194–3200, 2002.
- [62] D. V. Spitzley and G. A. Keoleian, “Life cycle environmental and economic assessment of willow biomass electricity: a comparison with other renewable and non-renewable sources | Center for Sustainable Systems,” 2011, <http://css.umich.edu/publication/life-cycle-environmental-and-economic-assessment-willow-biomass-electricity-comparison>.
- [63] D. Pimentel and M. H. Pimentel, “Renewable energy: current and potential issues,” in *Food, Energy, and Society*, vol. 52, no. 12, pp. 259–276, CRC Press, 2007.
- [64] F. Brihmat and F. B. S. Mekhtoub, “PV cell temperature / PV power output relationships Homer methodology calculation,” *Conférence Internationale des Energies Renouvelables “CIER’13”/International Journal of Scientific Research & Engineering Technology*, vol. 2, no. 1, pp. 1–12, 2014.
- [65] V. Fthenakis and H. C. Kim, “Land use and electricity generation: a life-cycle analysis,” *Renewable and Sustainable Energy Reviews*, vol. 13, no. 6–7, pp. 1465–1474, 2009.
- [66] D. Dusabe, J. L. Munda, and A. A. Jimoh, “Small scale solar energy systems in Rwanda: status and sustainability,” *International Conference Domestic Use Energy*, vol. 2009, pp. 1–6, 2009.
- [67] “Solar home systems,” 2021, <https://www.reg.rw/what-we-do/offgrid-solutions/solar-home-systems/>.
- [68] Rwanda Energy Group, “Electricity access,” 2021, <https://www.reg.rw/what-we-do/access/>.
- [69] Rwanda Energy Group (REG), “Mini-grids,” 2021, <http://www.reg.rw/what-we-do/offgrid-solutions/mini-grids/>.
- [70] “Rwanda off-grid sector status report PDF free download,” 2021, <https://docplayer.net/amp/151460710-Rwanda-off-grid-sector-status-report-2018.html>.
- [71] I. Bisaga, “Scaling up off-grid solar energy access through improved understanding of customers’ needs, aspirations and energy use of decentralised (SMART) solar home systems – a case study of BBOXX customers in Rwanda,” p. 401, 2018, https://discovery.ucl.ac.uk/id/eprint/10069395/13/Bisaga_10069395_thesis_redacted_id_removed.pdf.
- [72] G. I. Rashed, G. Shyirambere, and G. Gasore, “Applicability study of battery charging stations in off-grid for rural electrification – the case of Rwanda,” in *Advances in Natural Computation, Fuzzy Systems and Knowledge Discovery*, vol. 1075, pp. 272–283, Springer, 2020.
- [73] A. Yadoo and H. Cruickshank, “The role for low carbon electrification technologies in poverty reduction and climate change strategies: a focus on renewable energy mini-grids with case studies in Nepal, Peru and Kenya,” *Energy Policy*, vol. 42, pp. 591–602, 2012.
- [74] K. J. Warner and G. A. Jones, “Energy and population in Sub-Saharan Africa: energy for four billion?,” *Environments*, vol. 5, no. 10, pp. 107–119, 2018.
- [75] “Indicators. Washington: The World Bank; c2021 – [cited 2021],” 2021, <https://data.worldbank.org/indicator>.
- [76] H. E. Murdock, D. Gibb, and T. André, *Renewables 2019 Global Status Report*, vol. 8, Tech. Rep. 3, REN21, 2019.
- [77] “Rwanda—A Case Study in Solar Energy Investment on JSTOR,” 2021, <https://www.jstor.org/stable/26256477?seq=1>.
- [78] V. Kizilcec, P. Parikh, and I. Bisaga, “Examining the Journey of a Pay-as-You-Go Solar Home System Customer : A Case Study of Rwanda,” *Energies*, vol. 14, no. 2, p. 330, 2021.
- [79] J. B. Alonso, P. Sandwell, and J. Nelson, “The Potential for Solar-Diesel Hybrid Mini-Grids in Refugee Camps: A Case Study of Nyabiheke Camp, Rwanda,” *Sustainable Energy Technologies and Assessments*, vol. 44, article 101095, 2019.
- [80] G. N. O. Asemota, “Rwanda’s Off-Grid Solar Performance Targets,” *Joule*, vol. 5, no. 1, pp. 22–23, 2021.
- [81] I. Bisaga, P. Parikh, J. Tomei, and L. S. To, “Mapping synergies and trade-offs between energy and the sustainable development goals: a case study of off-grid solar energy in Rwanda,” *Energy Policy*, vol. 149, article 112028, 2020.
- [82] M. Grimm, L. Lenz, J. Peters, and M. Sievert, “Demand for off-grid solar electricity: experimental evidence from Rwanda,” *Journal of the Association of Environmental and Resource Economists*, vol. 7, no. 3, pp. 417–454, 2020.

- [83] C. Brunet, O. Savadogo, P. Baptiste et al., "The three paradoxes of the energy transition - assessing sustainability of large-scale solar photovoltaic through multi-level and multi-scalar perspective in Rwanda," *Journal of Cleaner Production*, vol. 288, article 125519, 2021.
- [84] C. Nsengimana, X. T. Han, and L. L. Li, "Comparative analysis of reliable, feasible, and low-cost photovoltaic microgrid for a residential load in Rwanda," *International Journal of Photoenergy*, vol. 2020, Article ID 8855477, 14 pages, 2020.
- [85] W. Paper, R. E. Papers, and R. Economic, 2018, <https://www.econstor.eu>.
- [86] G. Bamundekere, *Contributions of renewable energy to sustainable development in Africa: case study of solar energy in Rwanda*, PAUWES, 2019.
- [87] J. D. D. Niyonteze, F. Zou, G. N. O. Asemota, and S. Bimenyimana, "solar-powered mini-grids and smart metering systems, the solution to Rwanda energy crisis," *Journal of Physics: Conference Series*, vol. 1311, article 012002, 2019.
- [88] R. Kennedy, S. Numminen, J. Sutherland, and J. Urpelainen, "Multilevel customer segmentation for off-grid solar in developing countries: evidence from solar home systems in Rwanda and Kenya," *Energy*, vol. 186, 2019.
- [89] H. Gloria, H. Olivier, and I. M. Angella, "Contribution of solar energy for sustainable urban development in Rwanda," *Civil Engineering and Architecture*, vol. 7, no. 6, pp. 271–277, 2019.
- [90] M. J. Felix, O. C. Uche, and O. P. Anthony, "Potential of solar and wind energy for large scale power generation in eastern region of Rwanda," vol. 1, no. 2, pp. 135–140, 2019.
- [91] A. Mushimiyimana, *Domestic Solar Energy as Solution for Non-Connected Rural Areas [Ph.D. thesis]*, University of Rwanda, 2019.
- [92] B. Soltowski, D. Campos-Gaona, S. Strachan, and O. Anaya-Lara, "Bottom-up electrification introducing new smart grids architecture-concept based on feasibility studies conducted in Rwanda," *Energies*, vol. 12, no. 12, p. 2439, 2019.
- [93] R. Muvunyi, *Viability of Micro Hydro-Solar PV Hybrid in Rural Electrification in Rwanda [Ph.D. thesis]*, University of Rwanda, 2019.
- [94] A. Munyaneza, K. Kaberere, and M. K. W. Mangoli, "Optimal design of a solar photovoltaic mini-grid for electrifying Rwumba village of Rwanda," *International Journal of Engineering Technology and Scientific Innovation*, vol. 4, no. 5, pp. 272–284, 2019.
- [95] J. Rodríguez-Manotas, P. L. Bhamidipati, and J. Haselip, "Getting on the ground: exploring the determinants of utility-scale solar PV in Rwanda," *Energy Research & Social Science*, vol. 42, pp. 70–79, 2018.
- [96] S. Bimenyimana, G. N. O. Asemota, and P. J. Ihirwe, "Optimization comparison of stand-alone and grid-tied solar PV systems in Rwanda," *OALib*, vol. 5, no. 5, pp. 1–18, 2018.
- [97] N. J. Williams, P. Jaramillo, and J. Taneja, "An investment risk assessment of microgrid utilities for rural electrification using the stochastic techno-economic microgrid model: a case study in Rwanda," *Energy for Sustainable Development*, vol. 42, pp. 87–96, 2018.
- [98] J. B. Rutibabara, *Environmental and Economic Cost Analysis of a Solar PV, Diesel and hybrid PV-Diesel water Pumping Systems for Agricultural Irrigation in Rwanda: Case study of Bugesera district [M. S. thesis]*, PAUWES, 2018.
- [99] E. Nshimiyimana, *Design of Home Electricity Supply System Using Solar PV and Its Integration to the National Grid: A Case Study of Masaka Village [M. S. thesis]*, PAUWES, 2018.
- [100] N. Lameck, "Design and Optimisation of PV-Biogas Hybrid system for rural electrification in Rwanda," 2018.
- [101] N. Emmanuel, C. W. Wabuge, and M. K. Mang'oli, *Design of Solar-Wind Hybrid System for Rural Electrification in Rwanda*, 2017.
- [102] J. Uwibambe and A. Prior, *Design of photovoltaic system for rural electrification in rwanda [M. S. thesis]*, Universitetet i Agder; University of Agder, 2017.
- [103] G. Ituze, *Evaluation Of A Hybrid Solar Photovoltaic-Bioenergy System For Powering Remote Dwelling In Rwanda [M. S. thesis]*, PAUWES, 2017.
- [104] M. Cyulinyana and H. Winkler, "Surface solar spectrum characteristics in tropical regions with specific reference to Rwanda," *Energy Procedia*, vol. 142, pp. 545–551, 2017.
- [105] M. Rwema, *Hydro, solar and wind: energy policy implication in renewable energy deployment in Rwanda*, Pan African University, 2017.
- [106] H. Ma and H. Ma, *Development and Design of a Portable Off-Grid Photovoltaic System with Contingency Functions for Rural Areas (Case Study Rwanda) Shaida Faiqi, DiVA*, 2017.
- [107] I. Bisaga, N. Puźniak-Holford, A. Grealish, C. Baker-Brian, and P. Parikh, "Scalable off-grid energy services enabled by IoT: a case study of BBOX SMART Solar," *Energy Policy*, vol. 109, pp. 199–207, 2017.
- [108] S. H. Kuppa and D. J. Zimmerle, "Statistical failure estimation method to size off-grid electrical systems for villages in developing countries," in *2017 IEEE Global Humanitarian Technology Conference (GHTC)*, pp. 1–6, San Jose, CA, USA, 2017.
- [109] S. Bimenyimana, G. N. O. Asemota, and L. Li, "Maximum power point performance tracking comparison between incremental conductance with perturb and observe algorithms in photovoltaic power systems," in *2017 2nd Int. Conf. Power Renew. Energy, ICPRE 2017*, pp. 919–924, Chengdu, September 2017.
- [110] S. Collings and A. Munyehirwe, "Pay-as-you-go solar pv in rwanda: evidence of benefits to users and issues of affordability," *Field Actions Science Reports*, vol. 2016, no. Special Issue 15, pp. 94–103, 2016.
- [111] M. Grimm, A. Munyehirwe, J. Peters, and M. Sievert, "A first step up the energy ladder? Low cost solar kits and household's welfare in rural Rwanda," *World Bank Economic Review*, vol. 31, no. 3, pp. lhw052–lhw649, 2016.
- [112] H. G. Beyer and F. Habyrarimana, "Detailed information on irradiance characteristics in Central Africa (Rwanda) from a dedicated network of ground stations and satellite derived data," vol. 2013, pp. 1–7, 2017.
- [113] D. Nshimiyimana, *Sizing of a hybrid solar PV-wind-fuel cell power system for isolated location*, PAUWES, 2016.
- [114] M. Karugarama, *Masters thesis: mitigation of blackout in Kigali using a microgrid with advanced energy storage and solar photovoltaics*, Virginia Polytech. Inst. State Univ., 2015.
- [115] A. F. Crossland, O. H. Anuta, and N. S. Wade, "A socio-technical approach to increasing the battery lifetime of off-grid photovoltaic systems applied to a case study in Rwanda," *Renewable Energy*, vol. 83, pp. 30–40, 2015.
- [116] Z. Srdjevic, R. Bajcetic, and B. Srdjevic, "Identifying the criteria set for multicriteria decision making based on SWOT / PESTLE analysis : a case study of reconstructing a water

- intake structure,” *Water Resources Management*, vol. 26, no. 12, pp. 3379–3393, 2012.
- [117] J. Terrados, G. Almonacid, and L. Hontoria, “Regional energy planning through SWOT analysis and strategic planning tools: Impact on renewables development,” *Renewable and Sustainable Energy Reviews*, vol. 11, no. 6, pp. 1275–1287, 2007.
- [118] K. C. Wang, “A process view of SWOT analysis,” in *Int. Soc. Syst. Sci. -51st Annu. Meet. Int. Soc. Syst. Sci. ISSS 2007*, pp. 484–495, Tokyo, Japan, 2007.
- [119] Rwanda Energy Group (REG), “Offgrid , 2020,” 2020, <https://www.reg.rw/what-we-do/access/offgrid/>.
- [120] *Solar energy distributions and manufactures in Rwanda*, Rwanda | Sun-Connect-News, 2020, <https://www.sun-connect-news.org/de/databases/distributorsmanufacturers/rwanda/>.
- [121] “Third Rwanda energy sector development policy financing,” 2020, <http://documents1.worldbank.org/curated/en/139261567389640856/pdf/Rwanda-Third-Rwanda-Energy-Sector-Development-Policy-Financing-Project.pdf>.
- [122] “The World Bank, Rwanda energy sector development policy financing,” 2019, 2020, <http://documents1.worldbank.org/curated/en/139261567389640856/pdf/Rwanda-Third-Rwanda-Energy-Sector-Development-Policy-Financing-Project.pdf>.
- [123] Ministry of Infrastructures, Rwanda Energy Group, “Review Assessment of current electrification programs,” 2020, http://www.reg.rw/fileadmin/user_upload/Task_Design_of_the_National_Electrification_Plan_in%20Rwanda_Report.pdf.
- [124] “Off-Grid Solar Market Assessment Rwanda Power Africa Off-grid Project,” 2019, 2020, https://sun-connect-news.org/fileadmin/DATIEIEN/Dateien/New/PAOP-Rwanda-MarketAssessment-Final_508.pdf.
- [125] B. K. Sovacool, A. Gilbert, and D. Nugent, “An international comparative assessment of construction cost overruns for electricity infrastructure,” *Energy Research and Social Science*, vol. 3, no. C, pp. 152–160, 2014.
- [126] I. Renewable and E. Agency, *Concentrating Solar Power*, International Renewable Energy Agency (IRENA), 2013.
- [127] E. B. Agyekum, V. I. Velkin, and I. Hossain, “Sustainable energy : is it nuclear or solar for African countries? Case study on Ghana,” *Sustainable Energy Technologies and Assessments*, vol. 37, p. 100630, 2020.
- [128] A. Scott, “Building electricity supplies in Africa for growth and universal access,” 2020, https://newclimateeconomy.report/workingpapers/wp-content/uploads/sites/5/2016/04/Building-Electricity-Supplies-in-Africa_NCE_final.pdf.
- [129] M. Grimm, L. Lenz, J. Peters, and M. Sievert, “Demand for off-grid solar electricity: experimental evidence from Rwanda,” 2016, 2020, <http://ftp.iza.org/dp10427.pdf>.
- [130] G. R. Timilsina, L. Kurdgelashvili, P. A. N. The, and W. Bank, “A review of solar energy markets, economics and policies,” 2011, 2020, <http://documents1.worldbank.org/curated/en/546091468178728029/pdf/WPS5845.pdf>.
- [131] “Catalyzing global markets for off-grid energy access,” 2016, 2020, <https://clasp.ngo/en/Resources/Resources/Headlines/2015/EA-EE-Using-Energy-Efficiency-to-Enhance-Energy->.
- [132] “Rwanda Energy Group, investment /Opportunities,” 2020, <https://www.reg.rw/what-we-do/investments/opportunities/>.
- [133] “2019 Rwanda voluntary national review (VNR) report,” 2019, 2020, https://sustainabledevelopment.un.org/content/documents/23432Rwanda_VNR_Document_Final.pdf.
- [134] “Rwanda: off-grid sector status report 2017,” 2020, https://endev.info/images/6/69/EnDev_Rwanda_-_Off-Grid_Sector_Status_Report_2017.pdf.
- [135] “Rwanda energy situation - energypedia.info,” 2020, https://energypedia.info/wiki/Rwanda_Energy_Situation.
- [136] R. Shabaneh and F. Tomas, *Identifying the roadblocks for energy access: a case study for Eastern Africa ’ s gas*, King Abdullah Petroleum Studies and Research Center, 2018.
- [137] M. A. Lima, L. F. R. Mendes, G. A. Mothé et al., “Renewable energy in reducing greenhouse gas emissions: reaching the goals of the Paris agreement in Brazil,” *Environmental Development*, vol. 33, article 100504, 2020.
- [138] O. Edenhofer, *IPCC, 2011: Summary for Policymakers*, IPCC Special Report on Renewable Energy Sources and Climate Change Mitigation, 2011.
- [139] “World Energy outlook 2017 – analysis - IEA,” 2020, <https://www.iea.org/reports/world-energy-outlook-2017>.
- [140] G. F. Nemet, “Beyond the learning curve: factors influencing cost reductions in photovoltaics,” *Energy Policy*, vol. 34, no. 17, pp. 3218–3232, 2006.
- [141] “Rural electrification strategy,” 2016, 2020, https://www.mininfra.gov.rw/fileadmin/user_upload/aircraft/Rural_Electrification_Strategy.pdf.
- [142] I Renewable Energy Agency, “Africa’s renewable future: the path to sustainable growth,” 2020, https://www.irena.org/documentdownloads/publications/africa_renewable_future.pdf.
- [143] “IOB evaluation access to energy in Rwanda impact evaluation of activities supported by the Dutch Promoting Renewable Energy Programme,” 2020, <https://www.oecd.org/derec/netherlands/Access-to-Energy-in-Rwanda.pdf>.
- [144] W Bank Group, “Growing affordable grid and off grid access while slimming subsidies,” 2019, 2020, <https://olc.worldbank.org/system/files/133963-BRI-PUBLIC-23-1-2019-12-26-0-CountryBriefRwanda.pdf>.
- [145] IRENA, “Scaling up renewable energy deployment in Africa detailed overview of IRENA’S engagement and impact,” 2020, 2020, https://www.irena.org/-/media/Files/IRENA/Agency/Publication/2020/Feb/IRENA_Africa_Impact_Report_2020.pdf?la=en&hash=BIAD828DFD77D6430B93185EC90A0D1B72D452CC.
- [146] “Barriers to renewable energy technologies development,” 2020, <https://www.energytoday.net/economics-policy/barriers-renewable-energy-technologies-development/>.
- [147] M. T. Islam, N. Huda, and R. Saidur, “Current energy mix and techno-economic analysis of concentrating solar power (CSP) technologies in Malaysia,” *Renewable Energy*, vol. 140, pp. 789–806, 2019.
- [148] H. Zou, H. Du, M. A. Brown, and G. Mao, “Large-scale PV power generation in China: a grid parity and techno-economic analysis,” *Energy*, vol. 134, pp. 256–268, 2017.
- [149] K. Say, M. John, R. Dargaville, and R. T. Wills, “The coming disruption: the movement towards the customer renewable energy transition,” *Energy Policy*, vol. 123, pp. 737–748, 2018.
- [150] N. Blair et al., “System advisor model (SAM) general description,” no. NREL/TP-6A20-70414, 2018, <https://www.nrel.gov/docs/fy18osti/70414.pdf>.
- [151] A. Jain, R. Mehta, and S. K. Mittal, “Modeling impact of solar radiation on site selection for solar PV power plants in India,” *International Journal of Green Energy*, vol. 8, no. 4, pp. 486–498, 2011.

- [152] S. E. Trabelsi, R. Chargui, L. Qoaidar, A. Liqreina, and A. A. Guizani, "Techno-economic performance of concentrating solar power plants under the climatic conditions of the southern region of Tunisia," *Energy Conversion and Management*, vol. 119, pp. 203–214, 2016.
- [153] A. Aly, S. S. Jensen, and A. B. Pedersen, "Solar power potential of Tanzania: identifying CSP and PV hot spots through a GIS multicriteria decision making analysis," *Renewable Energy*, vol. 113, pp. 159–175, 2017.
- [154] E. B. Agyekum, "Techno-economic comparative analysis of solar photovoltaic power systems with and without storage systems in three different climatic regions, Ghana," *Sustainable Energy Technologies and Assessments*, vol. 43, article 100906, 2021.
- [155] J. Alonso-Montesinos, J. Polo, J. Ballestrin, F. J. Batlles, and C. Portillo, "Impact of DNI forecasting on CSP tower plant power production," *Renewable Energy*, vol. 138, pp. 368–377, 2019.
- [156] IRENA, *Renewable Power Generations Costs*, International Renewable Energy Agency (IRENA), 2018.
- [157] J. O. Oladigbolu, M. A. M. Ramli, and Y. A. Al-Turki, "Techno-economic and sensitivity analyses for an optimal hybrid power system which is adaptable and effective for rural electrification: a case study of Nigeria," *Sustainability*, vol. 11, no. 18, p. 4959, 2019.
- [158] A. K. Abu-Rumman, "JARIE_Volume 4_Issue 4_Pages 252-258," *Journal of Applied Research on Industrial Engineering*, vol. 4, pp. 1–7, 2017.
- [159] W. Short, D. Packey, and T. Holt, "A manual for the economic evaluation of energy efficiency and renewable energy technologies," *Renewable Energy*, vol. 95, pp. 73–81, 1995.
- [160] E. Drury, P. Denholm, and R. Margolis, *The impact of different economic performance metrics on the perceived value of solar photovoltaics*, Tech. Rep., 2011.
- [161] S. Martín-Martínez, M. Cañas-Carretón, A. Honrubia-Escribano, and E. Gómez-Lázaro, "Performance evaluation of large solar photovoltaic power plants in Spain," *Energy Conversion and Management*, vol. 183, pp. 515–528, 2019.
- [162] N. Blair, C. Christensen, M. Mehos, and C. Cameron, "Modeling photovoltaic and concentrating solar power trough performance, cost, and financing with solar advisor model," in *Am. Sol. Energy Soc. - Sol. 2008, Incl. Proc. 37th ASES Annu. Conf., 33rd Natl. Passiv. Sol. Conf., 3rd Renew. Energy Policy Mark. Conf. Catch Clean Energy Wave*, vol. 2, pp. 1051–1076, USA, 2008.
- [163] A. Dobos, T. Neises, and M. Wagner, "Advances in CSP simulation technology in the system advisor model," *Energy Procedia*, vol. 49, pp. 2482–2489, 2014.
- [164] G. Alva, L. Liu, X. Huang, and G. Fang, "Thermal energy storage materials and systems for solar energy applications," *Renewable and Sustainable Energy Reviews*, vol. 68, pp. 693–706, 2017.
- [165] W. A. Braff, J. M. Mueller, and J. E. Trancik, "Value of storage technologies for wind and solar energy," *Nature Climate Change*, vol. 6, no. 10, pp. 964–969, 2016.
- [166] Y. Ding, Y. Li, C. Liu, and Z. Sun, *Solar Electrical Energy Storage*, Elsevier Ltd., 2015.
- [167] A. Thesis, *Optimal implementation of energy storage systems in power distribution networks*, Convers. Congr., 2012, <http://conservancy.umn.edu/handle/11299/132215>.
- [168] "The 2018 global off-grid solar market trends report / Lighting Global," 2021, <https://www.lightingglobal.org/2018-global-off-grid-solar-market-trends-report/>.
- [169] D. Henner and REN21, *Renewables 2020 Global Status Report*, REN21, 2017, https://www.ren21.net/wp-content/uploads/2019/05/GSR2017_Full-Report_English.pdf 13.
- [170] F. I. Monetary, *Rwanda: poverty reduction strategy paper; IMF Country Report; 2013-2018*, Tech. Rep. 13, International Monetary Fund, 2013.
- [171] M. T. S. C. Alleyne and M. M. Hussain, *Energy subsidy reform in Sub-Saharan Africa: Experiences and lessons*, International Monetary Fund, 2013.
- [172] A. Eberhard, O. Rosnes, M. Shkaratan, and H. Vennemo, *Africa's power infrastructure: investment, integration, efficiency*, The World Bank, 2011.
- [173] A. Eberhard, V. Foster, C. Briceño, F. Ouedraogo, and M. Shkaratan, *Africa infrastructure underpowered: the state of the power sector in Sub-Saharan Africa*, World Bank, 2008.
- [174] A. Eberhard and M. Shkaratan, "Powering Africa: meeting the financing and reform challenges," *Energy Policy*, vol. 42, pp. 9–18, 2012.
- [175] A. W. Bank and B. Practice, *Rural energy and development: improving energy supplies for 2 billion people – a World Bank best practice paper*, World Bank, 1996.
- [176] E. Asiedu, "On the determinants of foreign direct investment to developing countries: is Africa different?," *World Development*, vol. 30, no. 1, 2002.
- [177] A. R. Ikeeley and Y. Ikeda, "Determinants of foreign direct investment in wind energy in developing countries," *Journal of Cleaner Production*, vol. 161, pp. 1451–1458, 2017.