

# Concept of a Novel Four-wheel-type Mobile Robot for Rough Terrain, RT-Mover

Shuro Nakajima, *Member, IEEE*

**Abstract** - In many fields employing robots, e.g., wheelchair robots, rescue robots, and construction robots, those which can move on rough terrain are desired. A robot with a simple mechanism and high mobility for all-terrain is discussed in this paper. A novel type of four-wheel-type mobile robot is developed, and its design is discussed from a functional viewpoint. In addition, strategies for moving on rough terrain are introduced, and its fundamental capability of moving on rough terrain is verified through simulations and experiments.

**Index Terms** – Mobile Robot, Rough Terrain, Wheel-type Robot, Hybrid Mechanism, Leg-wheel Robot.

## I. INTRODUCTION

In many fields, there is a strong demand for mobile robots that can move on rough terrain, for example, to aid people who have difficulty in walking. However, there are few robots that are suitable for use in rough terrain.

Broadly speaking, the functions necessary in a mobile robot for use in rough terrain are path planning ability and movement ability. Many works have been performed on both these functions. They have also dealt with improving the mobility performance. To provide a few examples of leg-type robots, there are the ASV robot developed by the OSU group [1] and the TITAN series built by Hirose [2]. Examples of wheel- and crawler-type robots are Sojourner that was built by NASA and TAQT Carrier constructed by Hirose [3]. Roller-Walker designed by Hirose [4], Whlegs built by Quinn et al. [5], and the Chariot series developed by Nakano and co-workers [6]–[8] are examples of leg-wheel robots. Most of these works realized high performance with regard to the mobility in assumed environments.

For providing a rough terrain mobile robot with the path planning ability, it is necessary to develop a method that will facilitate high mobility performance by using a simple mechanism. In other words, there are few robots that can be used to address the path planning problem since only robots that show sufficient mobility performance for rough terrain and that employ a simple mechanism and involve an easy control method can be used.

In this study, a robot that shows sufficient mobility performance on rough terrain is examined. The robot employs a

simple mechanism and is therefore suitable for a practical use and an investigation of problems such as the path planning problem on rough terrain. Its fundamental capability of moving on rough terrain is verified through simulations and experiments.

### A. Target Environments

In this study, the target environment is defined as follows.

- 1) An indoor environment with an uneven ground surface
- 2) An artificial outdoor environment with an uneven ground surface and a staircase
- 3) Natural terrain like a promenade in a forest.

The maximum step height and the maximum height of obstacles such as stones are assumed to be 0.25 (m) and 0.15 (m), respectively.

## II. RELATED WORK

There are many mobile robots that can move on rough terrain. Most of these robots are classified into the following three categories of mechanism.

1) Legged robot: has the excellent mobility with high stability selecting the supporting point of the leg and maintaining its body by legs. Legged robots are well studied for their mobility, e.g. ASV[1], TITAN series[2], DANTE II[9], and hexapod robot[10].

2) Wheeled robot: is most commonly selected for traversing continuous surfaces including rough terrain. For an exploration rover, wheel mechanisms are mainly used because of its stability, maneuverability and simplicity to control. Micro 5[11], Rocky 7[12], Shrimp[13], CRAB[14] and Zaurus[15] are examples of wheeled mobile robots that have passive linkage mechanisms. SpaceCat[16] and Nanokhod[17] are examples with active linkage mechanisms.

3) Wheeled–legged robot: has both merits between leg mechanism and wheel mechanism. Work Partner[18] and Roller Walker are equipped with the wheels placed at the end of the legs. Chariot III[19]–[23] and RoboTrac[24] have the wheels and the legs separately. Wheeleg[25] has two front legs and two rear wheels.

Although legged mechanism has high mobility for rough terrain, the mechanism becomes complex and needs more energy for walking. Most of wheeled robot can't get over discontinuous terrain, however, that is usually the best solution for continuous terrain. The hybrid mechanism contains the both strength, although the mechanism also tends to become complex and tedious.

In this paper, the robot, RT-Mover, which has enough mobility for target environments with the simple mechanism, is developed. Its mechanism is different from those of

Manuscript received February 12, 2009. This work was partially supported by KAKENHI (19700194, Grant-in-Aid for Young Scientists (B)), the Suzuki Foundation, and the Yazaki Memorial Foundation for Science and Technology.

Shuro NAKAJIMA is with the Department of Advanced Robotics, Chiba Institute of Technology, 2-17-1 Tsudanuma, Narashino, Chiba, 275-0016, JAPAN(phone & fax: +81-47-478-0143; e-mail: shuro.nakajima@it-chiba.ac.jp).

conventional mobile robots. Four wheels are mounted at every leg tip, and the leg mechanism is quite simple. Therefore, RT-Mover has four active wheels and only other five active shafts, whereas the robot can move on discontinuous rough terrain with maintaining a sheet part of the robot horizontally. It can move like a wheeled robot and also walk over a step like a legged robot, in spite of consisting of the simple mechanism.

### III. MOBILE ROBOT FOR ROUGH TERRAIN

Table I shows the current state of the practical use of robots with different locomotion mechanisms. It is understood that robots with complex mechanisms are not suitable for practical use from the viewpoint of control, operation, and maintainability. On the other hand, wheel-type robots are suitable for practical applications.

TABLE I  
STATUS OF PRACTICAL USE OF MOBILE ROBOTS WITH DIFFERENT LOCOMOTION MECHANISMS

Type	Situation
Leg type	It has not been put to practical use yet.
Wheel type	There are some practical uses (for instance, cleaning robots).
Crawler type	There are a few practical uses (for instance, in the leisure and construction fields).
Composite mechanism type	It has not been put to practical use yet.

The main characteristics that a mobile robot used for general purposes in rough terrain should possess are enumerated below.

- 1) Good ability to move on rough terrain (essential for a rough terrain mobile robot)
- 2) High-speed mobility (essential for a mobile robot)
- 3) Easy control (indispensable factor in the operation of a robot)
- 4) Simplicity of mechanism (indispensable feature for maintenance)

There is no mechanism superior to the wheel mechanism from the viewpoint of high speed, and the leg mechanism is the best from the viewpoint of adjustment to rough terrain. Therefore, to perform the essential functions of mobile robots in rough terrain, both wheel and leg mechanisms are needed. In this paper, under the assumption that the robot performs the functions of both wheel and leg, both maintainability and easy control are attempted to realize by simplifying the mechanism as much as possible.

#### A. Mechanical Design

In this paper, the followings are premised.

- 1) A leg-wheel robot is used as the basic robot to discuss a suitable mechanism for rough terrain because both wheel and leg are necessary for rough terrain mobile robots. This type of robot, which has been studied by Hirose, the present author, and other researchers, has both high speed and high adaptability for unstructured terrain.
- 2) The proposed robot has four contact points on the ground. Four is the minimum number in order to maintain its stability when it raises one leg with supporting its body by the other three legs.
- 3) Each wheel is attached to the tip of a leg, because in many cases, sufficient space is not available to set the leg and wheel separately on the body of the robot.

TABLE II  
STRENGTHS AND LIMITATIONS OF LEG-WHEEL ROBOTS

Strengths	Mobility performance on rough terrain is high because of the use of the leg mechanism.
	High-speed movement is possible because of the use of the wheel mechanism.
	Robot capability can be enhanced by using leg and wheel mechanisms cooperatively.
Limitations	There is a danger of collision between the leg of the robot and a person in the leg's movement range.
	The number of actuators (required for the legs) increases, and thus, the cost also rises.
	Operability and maintainability worsen because of the complexity of the leg mechanism.

Table II shows the strengths and limitations of the leg-wheel robot. It is necessary to reduce the complexity of the leg mechanism and limit the leg's movement range. In the followings, the proposed mechanism is discussed by considering the necessary functions.

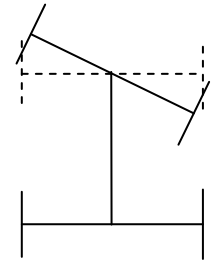

Fig.1: Steering mechanism

#### B. Stability of Occupant and Load

When the robot traverses a slope, the occupant and the load should be maintained in the horizontal position to make the ride comfortable. Therefore, the pitch of a sheet part of the robot (i) and the roll of a sheet part of it (ii) should be capable of being adjusted.

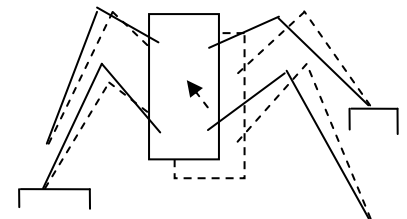

Fig.2: Body position adjustment without displacement of supporting points

#### C. Steering (iii)

Direction control of the robot is necessary. For this, the Ackermann steering mechanism or the mechanism illustrated in Fig.1 is used for steering.

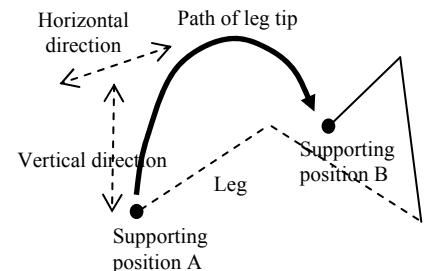

Fig.3: Leg-type robot can select the supporting position arbitrarily.

#### D. Function of Leg

The general functions that the leg mechanism facilitates are shown in Table III. When all the legs do not possess multiple degrees of freedom, function 3 in Table III cannot be realized (Fig.2). In this paper, it is assumed that only functions 1 and 2 are to be realized because function 3 is not necessarily needed if leg tip positions are adjusted by wheels. As a result, a leg mechanism can become quite simple. For realizing function 2, it is at least necessary for the leg tip to be capable of moving vertically (iv) and horizontally (v), as shown in Fig.3.

It is preferable to realize two or more functions with one degree of freedom in order to avoid a complex mechanism. Therefore, the axle is made to be controllable in the rolling direction, and both functions (ii) and (iv) are realized, as shown in Fig.4. Moreover, (iii) and (v) are realized by setting the other drivable shaft as shown in Fig.4. This mechanism is hereafter referred to as leg-like axle. In order to realize the function of four legs (Fig.5), the robot is equipped with a leg-like axle at both the front and rear.

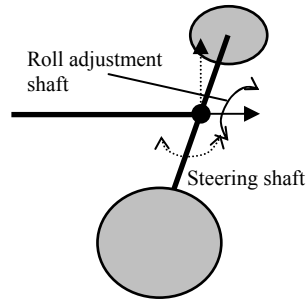

Fig.4: Mechanism of leg-like axle

TABLE III  
FUNCTIONS FACILITATED BY A LEG

No.	Function
1	Body can be supported.
2	Location of a supporting point can be arbitrarily selected.
3	Body position can be adjusted without changing the supporting points.

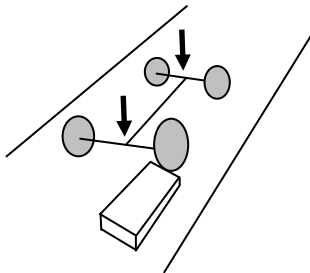

Fig.5: Leg-like axle is provided at both the front and rear, so every leg can raise its wheel.

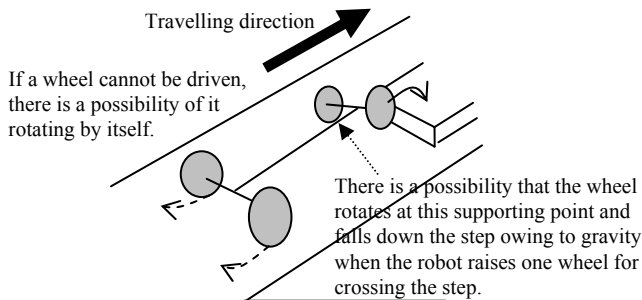

Fig.6: There is a possibility of the body falling if all the wheels cannot be driven.

Each wheel is driven and controlled independently owing to the following reasons.

- 1) There is a possibility of the body falling when moving over a rough terrain on a slope, as shown in Fig.6, if all the wheels are not active wheels.
- 2) The speed of the right wheel is different from that of the left wheel, even when moving straight on a rough terrain, because on a rugged road, the path of each wheel is different from the paths of the other wheels.

Finally, an adjustment shaft is attached to the body, as shown in Fig.7, to control the sheet's horizontal pitch.

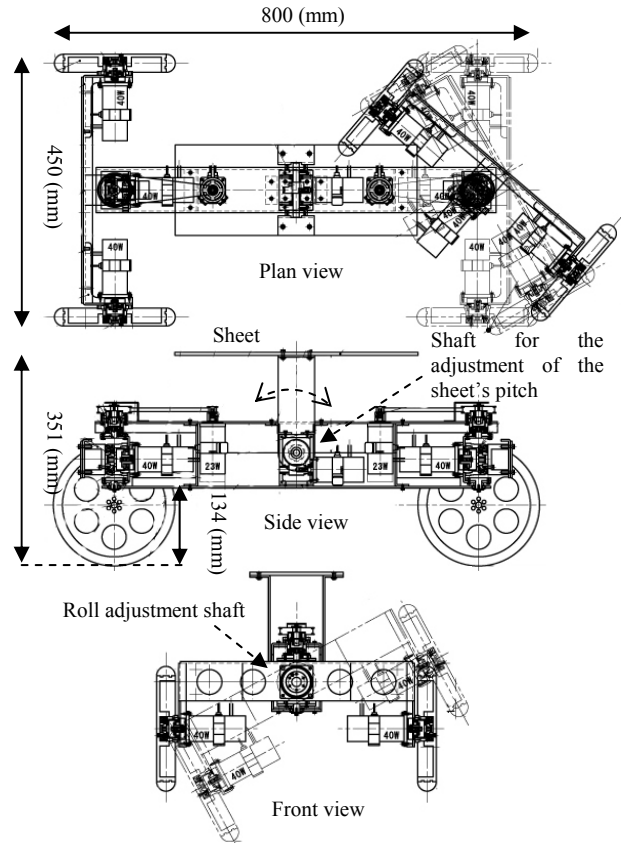
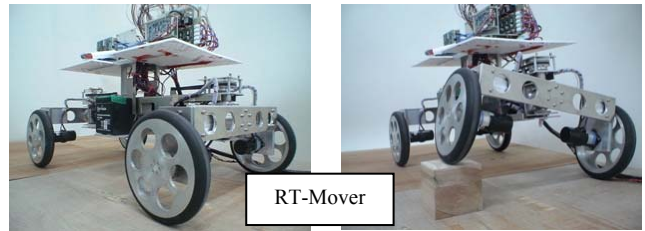

Fig.7: Assembly drawing of RT-Mover

TABLE IV  
MAIN SPECIFICATIONS

Principal dimensions	Length: 800 (mm); Width: 450 (mm); Height: 134 (mm)
Wheel size	Radius: 100 (mm); Width: 30 (mm)
Weight	21.5 (kg) (Weight of sheet part: 1.5 (kg))
Motor (DC Servo)	23 (W) (Steering: 2; Sheet's pitch: 1) 40 (W) (Wheel: 4; Sheet's roll: 2 (front and rear))
Gear ratio	40 (Sheet's pitch: 1 (warm gear)) 100 (Wheel: 4; Sheet's roll: 2 (harmonic gear)) 400 (Steering: 2; (Harmonic gear: 100; Belt drive: 4))
Sensor	Posture angle sensor (sheet's pitch and sheet's roll) Encoder and current sensor (each motor)
Power supply	Battery 24 (V)

The proposed robot, which was named “RT-Mover,” was designed as shown in Fig.7 and Table IV. RT-Mover has functions of four wheels and four legs, and has a controllable sheet part, therefore, it can move on rough terrain for someone or something riding on it horizontally. On the other hand, there are four active wheels and only other five active shafts. RT-Mover has the smallest degrees of freedom among other robots that have the same mobility specifications. So, this is a novel type of rough terrain robot.

The dimensions of the robot were about two thirds of the actual dimensions for simplifying the experiments performed to evaluate it.

#### IV. MOVING STRATEGY FOR ROUGH TERRAIN

Figs.8 and 9 shows moving strategies for many types of rough terrain. Real surface is mixed with some types of rough terrain. In this section, how to move on typical rough terrain is described. A method to integrate external sensor information with the robot system will be studied according to the progress of this research, because, for example, external sensor information is necessary to recognize a downward step before descending the step in Fig.9 (b).

At the current stage, the idea of the motion planning is proposed.

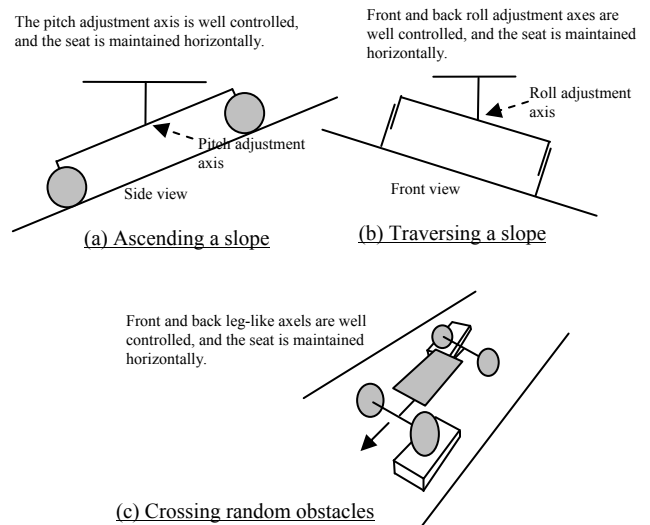

Fig 8: Moving strategies of wheel mode on rough terrain

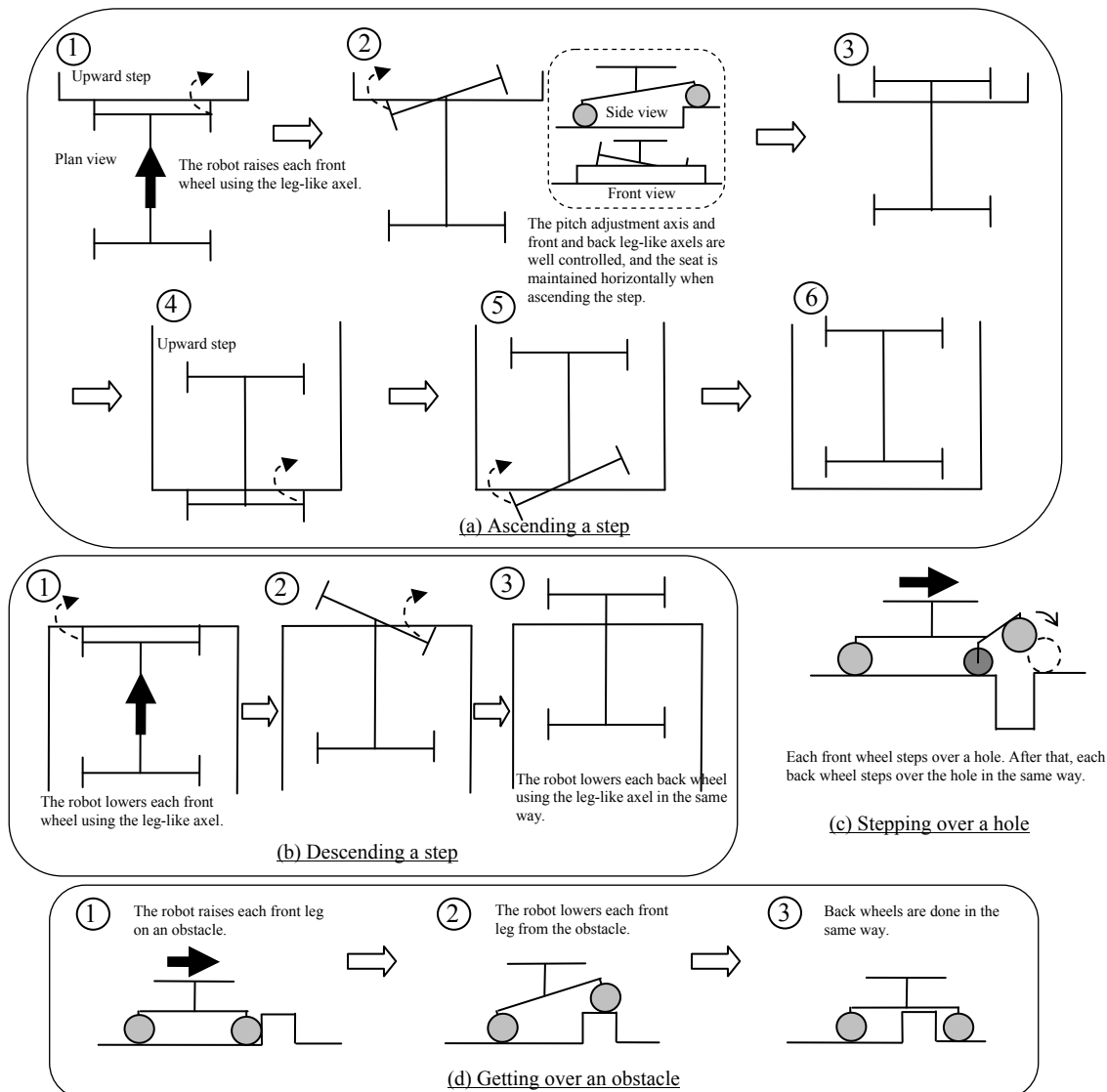

Fig 9: Moving strategies of leg mode on rough terrain

Fig.8 (a): RT-Mover moves stably on a slope with maintaining the seat horizontally by well controlling the pitch adjustment axis.

Fig.8 (b): RT-Mover traverses stably on a slope with maintaining the seat horizontally by well controlling both of the front and back roll adjustment axes.

Fig.8 (c): RT-Mover crosses stably with maintaining the seat horizontally by well controlling the pitch adjustment axis and both of the front and back roll adjustment axes.

Fig.9 (a): RT-Mover ascends an upward step with maintaining the seat horizontally by well controlling the pitch and roll adjustment axes. After recognizing the step by using some sensor information, the robot raises each front wheel using the leg-like axel and puts it on the step by well controlling both of the front and back steering angles and all supporting wheels' angles. After both front wheels ascend the step, the robot goes forward until the back wheels reach the step by well controlling both of the front and back steering angles and all wheels' angles. After that, it raises each back wheel in the same way.

Fig.9 (b): RT-Mover descends a downward step with maintaining the seat horizontally by well controlling the pitch and roll adjustment axes. After recognizing the step by using some sensor information, the robot lowers each front wheel using the leg-like axel and puts it down by well controlling both of the front and back steering angles and all wheels' angles. After that, the robot lowers each back wheel in the same way.

Fig.9 (c): RT-Mover steps over a hole using the leg-like axel. After recognizing the hole, the robot raises each front wheel and steps over the hole by well controlling both of the front and back steering angles and all supporting wheels' angles. After that, the back wheels step over the step in the same way of the front wheels.

Fig.9 (d): RT-Mover gets over an obstacle. After recognizing the obstacle, the robot raises each front wheel on the obstacle, and next, it lowers each front wheel in the similar way of (a) and (b). After that, each back wheel is done in the same way of the front wheels.

This paper is for a conference, so I just propose the concept of strategy to move on rough terrain. Detailed control methods will be discussed in another paper.

## V. VERIFICATION OF FUNDAMENTAL CAPABILITY OF MOVING ON ROUGH TERRAIN THROUGH SIMULATION

In this paper, as a first step, three fundamental cases (Fig.8 (a), (b), (c)) are simulated by using ODE in order to confirm that the robot can maintain the sheet in a horizontal position when moving on a rough terrain. The three cases are (a) moving on a slope, (b) traversing a slope, and (c) crossing random obstacles.

The control law concerning the sheet's pitch is

$$T_{\theta_p} = -K_p(\theta_p - \theta_{dp}) - D_p(\dot{\theta}_p - \dot{\theta}_{dp}) = -K_p\theta_p - D_p\dot{\theta}_p, \quad (1)$$

where  $T_{\theta_p}$  is the torque of the adjustment shaft controlling the sheet's pitch,  $\theta_p$  is the sheet's pitch,  $\theta_{dp}$  is the desired pitch,  $\dot{\theta}_p$  is the angular velocity of the adjustment shaft controlling the sheet's pitch,  $\dot{\theta}_{dp}$  is the desired angular velocity of that,  $K_p$  is the angle gain, and  $D_p$  is the angular velocity gain. Both the desired pitch and desired angular velocity become 0 when the

desired pitch is horizontal. The reason why not  $\dot{\theta}_p$  but  $\dot{\theta}_{dp}$  is used is that in case of the actual robot in this study, the data of angular velocity of the sheet's pitch is a little delayed owing to the specification of the posture angle sensor (max 10 (ms),

Fig.14) . Therefore,  $\dot{\theta}_{dp}$ , which is the data of the adjustment shaft's encoder, is better for controlling the robot in this study. On the other hand, if there were no data delay and no back lash etc., that is, the ideal situation,  $\dot{\theta}_p$  should be used for better performance.

The control law concerning the sheet's roll is

$$T_{\theta_r} = K_r(\theta_r - \theta_{dr}) - D_r(\dot{\theta}_r - \dot{\theta}_{dr}) = K_r\theta_r - D_r\dot{\theta}_r, \quad (2)$$

where  $T_{\theta_r}$  is the torque of the roll adjustment shaft,  $\theta_r$  is the sheet's roll,  $\theta_{dr}$  is the desired roll,  $\dot{\theta}_r$  is the angular velocity of the roll adjustment shaft,  $\dot{\theta}_{dr}$  is the desired angular velocity of that,  $K_r$  is the angle gain, and  $D_r$  is the angular velocity gain. This control law is applied to both the front and rear shafts. Because this roll adjustment shaft is for controlling not the sheet's roll but leg, the sign of  $K_r$  in (2) is different from that of (1).

The conditions employed in the simulation are as follows.

- 1)  $K_p = 150$  (N·m),  $D_p = 0.8$  (N·m·s),  $K_r = 220$  (N·m),  $D_r = 0.8$  (N·m·s)
- 2) The speeds of all the wheels are maintained at a constant value. ((a), (b): 0.3 (m/s); (c): 0.15 (m/s))
- 3) The steering angle of both the front and rear axles is maintained at 0.
- 4) The wheels and steering are controlled by PD control.

Fig.10 shows (A) the shape of the road in and a scene from the simulation and (B) the data of the sheet's pitch and roll and the adjustment shaft of the sheet's pitch for the movement from point A to B in (A). After moving on the plane, the robot ascended the 10° slope.

Both the sheet's pitch and roll are maintained within  $\pm 0.1$  (deg); however, this is hard to view in the figure because of overlapping data. Fig.10 shows that because the adjustment shaft controlling the sheet's pitch is appropriately controlled, the sheet's pitch continues to be horizontal.

At point A, the robot has already attained a constant speed, and hence, the influence of the acceleration at the beginning is not evident. (Figs.11 and 12 are similar to Fig.10.) The coordinate system used in the simulation is shown in Fig.10 (A).

Fig.11 presents the simulation data for the case of traversing a slope. After moving on the plane, the robot traverses the 10° downward slope. For the left wheel, the road height is the same between the plane and the slope. On the other hand, there is a downward step for the right wheel (actually, the rear left wheel moves on a very small downward step because of a little change of traversing direction after the right front wheel moves down the step). Fig.11 (B) shows the data of the sheet's pitch and roll and both the front and rear roll adjustment shafts for the movement from point A to point B. Both the sheet's pitch and roll are maintained within  $\pm 0.2$  (deg); however, this is hard to observe in the figure because of overlapping data. When each axle enters the sloping region, the corresponding roll adjustment shaft is controlled according to the inclination of the slope. As a result, the sheet's roll is maintained to be horizontal.

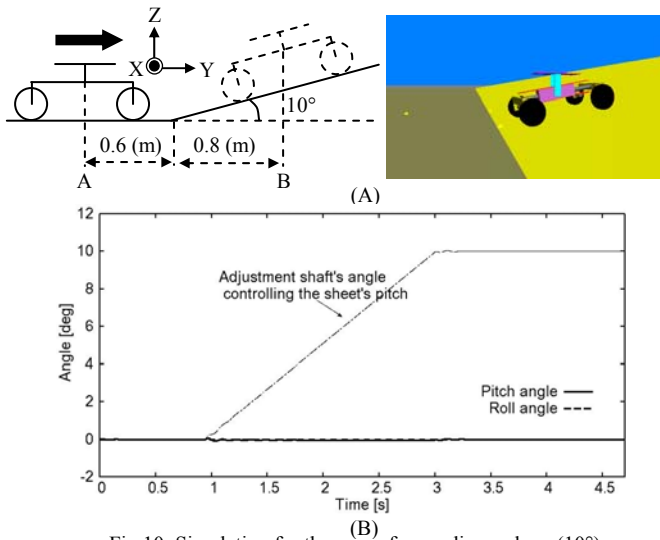

Fig.10: Simulation for the case of ascending a slope ( $10^\circ$ )

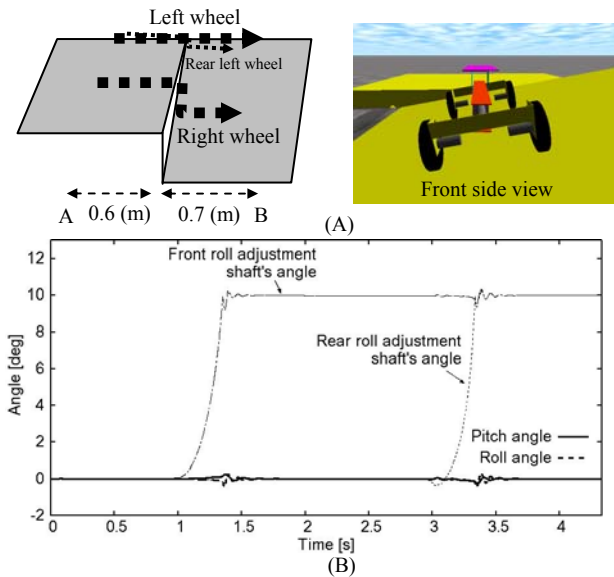
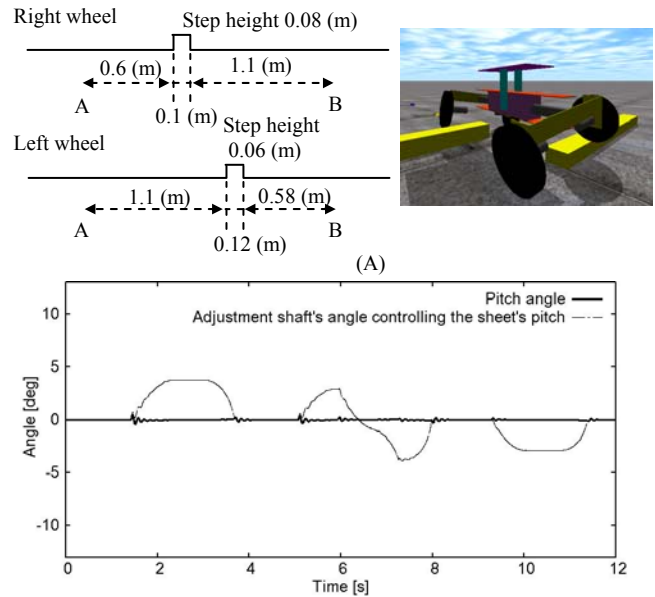

Fig.11: Simulation for the case of traversing a slope ( $10^\circ$ )

Fig.12 shows the simulation data for the case of crossing random obstacles. Fig.12 shows (A) the shape of the road in and a scene from the simulation, (B) the data of the sheet's pitch and the adjustment shaft controlling the sheet's pitch for the movement from point A to point B, and (C) the data of the sheet's roll and both front and rear roll adjustment shafts for the movement from point A to point B. (B) and (C) show that each adjustment shaft is controlled appropriately and the sheet's posture angle is maintained to be horizontal within  $\pm 0.5$  (deg), even when crossing random obstacles.

When the wheel hits an obstacle, the steering shaft is blurred because of the reaction force of the obstacle. If the robot is required to move exactly straight, it is necessary to adjust the corresponding wheel speed according to both the rotation angle of the steering shaft and that of the roll adjustment shaft. This case is a subject for a future study.



(B) Data of the sheet's pitch and adjustment shaft controlling the sheet's pitch

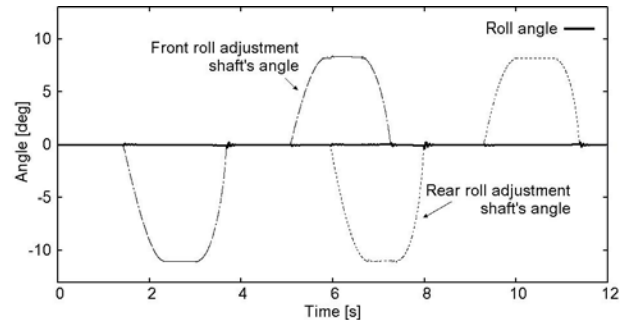

(C) Data of the sheet's roll and roll adjustment shafts at the front and rear

Fig.12: Simulation for the case of crossing random obstacles

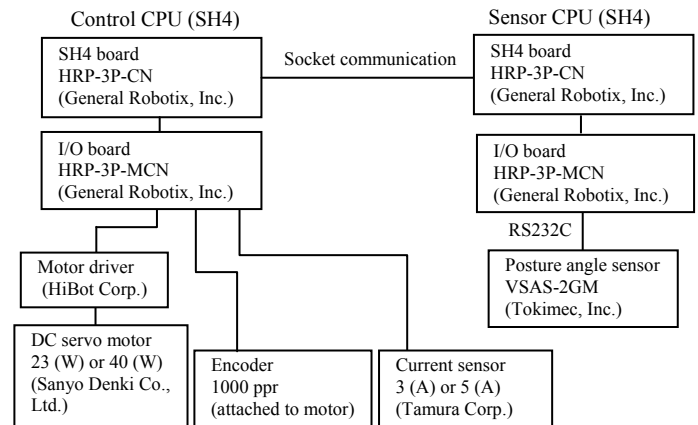

Fig.13: System configuration

## VI. EXPERIMENTAL RESULT

### A. System Configuration

The system configuration is shown in Fig.13. The robot is equipped with two SH4 boards—one for controlling the robot and the other for processing the posture angle sensor data. The I/O board is connected to each SH4 board and each of the data



is inputted or outputted through the I/O board. Each SH4 board communicates with the other SH4 boards through socket communication. The structure of the software is shown in Fig. 14. The robot is controlled in real time on ART-Linux. The control system is divided into two layers—gait strategy layer and motion control layer. In the former, the manner in which the leg-like axle, wheel, steering shaft, and adjustment shaft are used is planned, and in the latter, the robot gets each sensor's information, and by using the sensor information each actuator is controlled on the basis of the gait strategy.

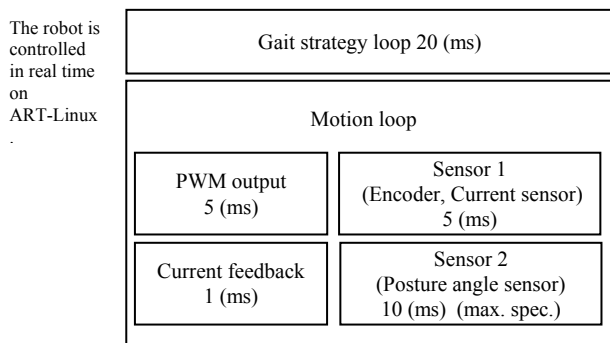

Fig. 14: Structure of software

### B. Experimental Results

The mobility performance of the robot for three fundamental cases (Fig.8(a)-(c)) is confirmed through experiments. The experimental conditions are the same as the conditions in the simulation, excluding  $D_p = 4.0$  (N·m·s) and  $D_r = 5.1$  (N·m·s). Owing to friction, every angular velocity gain value is different from that in the simulation. The experimental data corresponds to the movement from point A to point B in the figure. The speed of the robot steadies at point A.

The experimental data are shown in Figs.15–17. The result in each figure shows that the sheet of the robot, on which a person or thing is considered to be positioned in the case of a robot of the actual size, can be stably controlled when moving on three typical rough terrains. Posture angle of the sheet is maintained within (A)  $\pm 0.7$  (deg), (B)  $\pm 2.2$  (deg), and (C)  $\pm 1.2$ (deg). The difference between the experimental data and the simulation data is due to errors in modeling the friction along each axis and the inertia of each part. In particular, the cause of the oscillation in the sheet's pitch in Fig.17 is the backlash of the adjustment shaft controlling the sheet's pitch.

## VII. CONCLUSION

RT-Mover that shows sufficient mobility performance on rough terrain was developed. It has four drivable wheels and two leg-like axles. Each wheel is mounted on one side of the leg-like axles at the front and rear of the body.

RT-Mover has the smallest degrees of freedom among other robots that can move on discontinuous rough terrain for someone or something riding on it horizontally. Therefore, it is a novel type of four-wheel-type mobile robot for rough terrain.

In this paper, the idea of strategies for moving on rough terrain was proposed and its fundamental capability of moving on rough terrain was verified through simulations and experiments.

The simulations and experiments were performed for three road shapes. In every case, the robot was able to move on that rough terrain by maintaining the horizontal position of the sheet.

Since this research has just started, there are many future works that should be done. A few of those are as follows.

- 1) How to deal with the difference between right and left wheel control on rough terrain
- 2) Control method for moving on various types of rough terrain
- 3) Dynamic control method on rough terrain

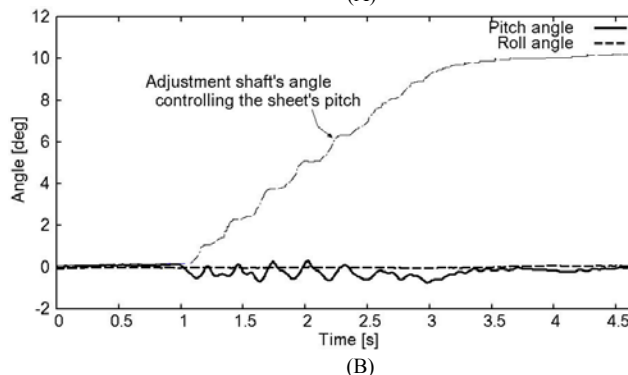
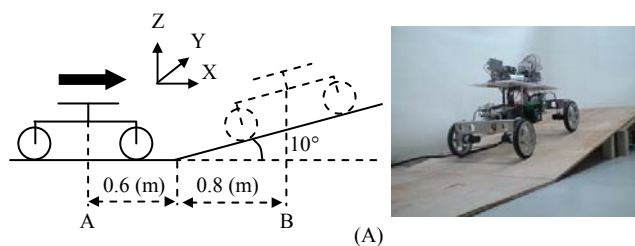

Fig. 15: Experimental data for the case of ascending a slope ( $10^\circ$ )

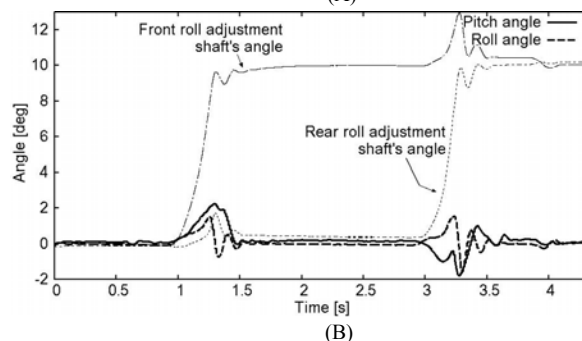
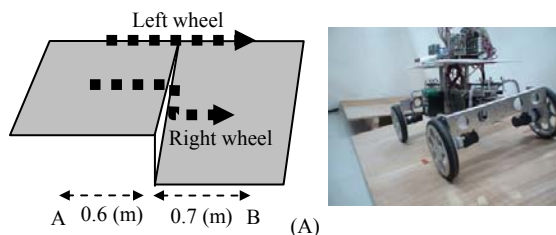
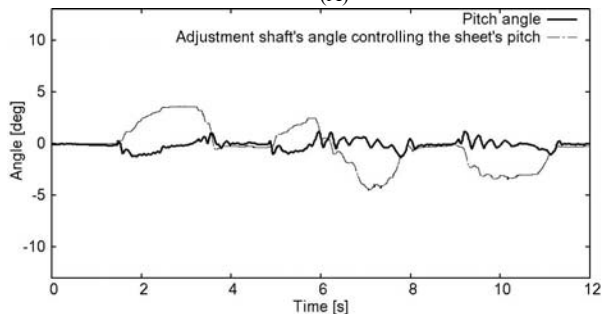
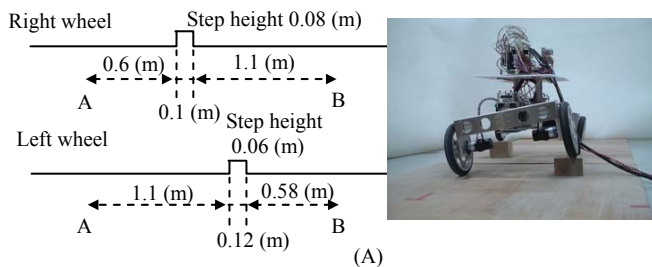
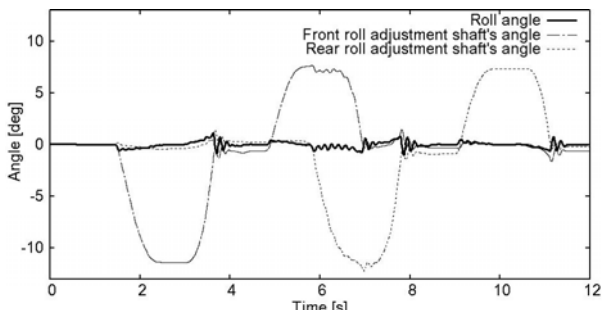

Fig. 16: Experimental data for the case of traversing a slope ( $10^\circ$ )



(B) Data of the sheet's pitch and adjustment shaft controlling the sheet's pitch



(C) Data of the sheet's roll and roll adjustment shafts at the front and rear

Fig.17: Experimental data for the case of crossing random obstacles

## REFERENCES

- [1] S. M. Song and K. J. Waldron, "Machines That Walk: The Adaptive Suspension Vehicle," MIT Press, 1989.
- [2] S. Hirose, et al., "The Gait Control System of the Quadruped Walking Vehicle," *Journal of the Robotics Society of Japan*, vol.3, no.4, pp.304-323, 1985.
- [3] S. Hirose, T. Sensu and S. Aoki: "The TAQT Carrier: A Practical Terrain-adaptive Quadru-track Carrier Robot," *Proceedings of International Conference on Intelligent Robots and Systems*, pp.2068-2073, 1992.
- [4] S. Hirose and H. Takeuchi, "Roller-Walker: A Proposal of New Leg- wheel Hybrid Mobile Robot," *Proceedings of the International Conference on Advanced Robotics*, pp.917-922, 1995.
- [5] Roger D. Quinn, et al., "Insect Designs for Improved Robot Mobility," *Proceedings of Climbing and Walking Robots Conference*, Prof. Eng. Pub., pp.69-76, 2001.
- [6] E. Nakano, et al., "A simplified Cooperational Motion Control Method of a Leg-Wheel Robot for an Unexplored Rough Terrain Environment," *Proceedings of The 4<sup>th</sup> World Multiconference on Systems, Cybernetics and Informatics*, vol.XII, pp.a27-a32, 2000.
- [7] S. Nakajima, et al., "Motion Control Technique for Practical Use of a Leg-wheel Robot on Unknown Outdoor Rough Terrains," *Proceedings of the International Conference on Intelligent Robots and Systems*, vol.1, pp.1353-1358, 2004.
- [8] S. Nakajima, et al., "Trot and Pace Gaits based on the Predictive Event Driven Method for a Leg-wheel Robot," *Journal of the Robotics Society of Japan*, vol.22, no.8, pp.1070-1081, 2004.

- [9] J. Bares and D. Wettergreen, "Lessons from the development and deployment of Dante II," *Proceedings of the 1997 Field and Service Robotics Conference*, December, 1997.
- [10] F. Delcomyn and M.E.Nelson, "Architectures for a biomimetic hexapod robot," *Robotics and Autonomous Systems*, 30 (2000) 5-15.
- [11] T. Kubota, Y. Kuroda, Y. Kunii, I. Nakatani, "Small, light-weight rover "Micro5" for lunar exploration," *Acta Astronautica*, 52 (2003) 447-453.
- [12] R. Volpe, J. Balaram, T. Ohm, R. Ivlev, , "Rocky 7: A next generation Mars rover prototype," *Journal of Advanced Robotics*, vol.11, no.4, pp.341-358, 1997.
- [13] T. Estier, et al., "An Innovative Space Rover with Extended Climbing Abilities," *Proceedings of the Space and Robotics 2000*, 2000.
- [14] T. Thueer, P. Lamon, A. Krebs, R. Siegwart, "CRAB-Exploration rover with advanced obstacle negotiation capabilities," *Proceedings of the 9<sup>th</sup> ESA Workshop on Advanced Space Technologies for Robotics and Automation*, Noordwijk, The Netherlands, 2006.
- [15] M. Sato, A. Kanda, K. Ishii, "An Environmental Adaptive Control System of a Wheel Type Mobile Robot for the Rough Terrain Movement," *Proceedings of the International Conference on Intelligent Robots and Systems*, pp.3962-3967, 2007.
- [16] M. Lauria, et al., "Design and control of an innovative micro-rover," *Proceedings of the Fifth ESA Workshop on Advanced Space Technologies for Robotics and Automation*, The Netherlands, 1998.
- [17] M. V. Winnendael, et al., "Nanokhod micro-rover heading towards Mars," *Proceedings of the Fifth International Symposium on Artificial Intelligence, Robotics and Automation in Space (ESA SP-440)*, Noordwijk, Netherlands, pp.69-76, 1999.
- [18] I. Leppanen, "Workpartner-HUT automations new hybrid walking machine," *Proceedings of the CLAWAR '98*, Brussels, 1998.
- [19] S. Nakajima and E. Nakano, "Adaptive Gait for Large Rough Terrain of a Leg-wheel Robot (First Report: Gait Strategy)," *Journal of Robotics and Mechatronics*, vol.20, no.5, pp.801-805, 2008.
- [20] S. Nakajima and E. Nakano, "Adaptive Gait for Large Rough Terrain of a Leg-wheel Robot (Second Report: Step-Up Gait)," *Journal of Robotics and Mechatronics*, vol.20, no.6, pp.913-920, 2008.
- [21] S. Nakajima and E. Nakano, "Adaptive Gait for Large Rough Terrain of a Leg-wheel Robot (Third Report: Step-Down Gait)," *Journal of Robotics and Mechatronics*, vol.21, no.1, pp.12-19, 2009.
- [22] S. Nakajima and E. Nakano, "Adaptive Gait for Large Rough Terrain of a Leg-wheel Robot (Fourth Report: Step-Over Gait)," *Journal of Robotics and Mechatronics*, vol.21, no.2, pp.285-292, 2009.
- [23] S. Nakajima and E. Nakano, "Adaptive Gait for Large Rough Terrain of a Leg-wheel Robot (Fifth Report: Integrated Gait)," *Journal of Robotics and Mechatronics*, vol.21, no.3, pp.419-426, 2009.
- [24] K. Six, A. Keeskem'ethy, "Steering properties of a combined wheeled and legged striding excavator," *Proceedings of the 10<sup>th</sup> World Congress on the Theory of Machines and Mechanisms*, vol.1, IFToMM, Oulu, Finland, pp.135-140, 1999.
- [25] M. Lacagnina, et al. "Kinematics, dynamics and control of a hybrid robot Wheelleg," *Robotics and Autonomous Systems*, 45 (2003) 161-180.