

# Lawrence Berkeley National Laboratory

## Recent Work

### Title

CONTINUOUS C14O2 AND CO2 EXCRETION STUDIES IN EXPERIMENTAL ANIMALS

### Permalink

<https://escholarship.org/uc/item/30f128gg>

### Authors

Tolbert, B.M

Kirk, Martha

Baker, E.M.

### Publication Date

1955-08-10

UNIVERSITY OF  
CALIFORNIA

*Radiation  
Laboratory*

CONTINUOUS  $C^{14}O_2$  AND  $CO_2$  EXCRETION  
STUDIES IN EXPERIMENTAL ANIMALS

TWO-WEEK LOAN COPY

*This is a Library Circulating Copy  
which may be borrowed for two weeks.  
For a personal retention copy, call  
Tech. Info. Division, Ext. 5545*

## **DISCLAIMER**

This document was prepared as an account of work sponsored by the United States Government. While this document is believed to contain correct information, neither the United States Government nor any agency thereof, nor the Regents of the University of California, nor any of their employees, makes any warranty, express or implied, or assumes any legal responsibility for the accuracy, completeness, or usefulness of any information, apparatus, product, or process disclosed, or represents that its use would not infringe privately owned rights. Reference herein to any specific commercial product, process, or service by its trade name, trademark, manufacturer, or otherwise, does not necessarily constitute or imply its endorsement, recommendation, or favoring by the United States Government or any agency thereof, or the Regents of the University of California. The views and opinions of authors expressed herein do not necessarily state or reflect those of the United States Government or any agency thereof or the Regents of the University of California.

UCRL-2941  
Chemistry Distribution

UNIVERSITY OF CALIFORNIA

Radiation Laboratory  
Berkeley, California

Contract No. W-7405-eng-48

CONTINUOUS  $C^{14}O_2$  AND  $CO_2$  EXCRETION STUDIES  
IN EXPERIMENTAL ANIMALS

B. M. Tolbert, Martha Kirk, and E. M. Baker

August 10, 1955

CONTINUOUS C<sup>14</sup>O<sub>2</sub> AND CO<sub>2</sub> EXCRETION STUDIES  
IN EXPERIMENTAL ANIMALS

B. M. Tolbert, Martha Kirk, and E. M. Baker  
Radiation Laboratory and Department of Chemistry  
University of California, Berkeley, California

August 10, 1955

ABSTRACT

An apparatus has been devised which permits, after administration of labeled compounds to animals, the continuous measurement and recording of CO<sub>2</sub> excretion by means of infrared absorption, C<sup>14</sup> excretion by ion chambers, and specific activity by a ratio analyzer. Comparative excretion studies have been made using labeled amino acids, fats, fatty acids, and sugars. The specific activity and total activity rate curves for breath carbon-14 are markedly different. The generally smooth nature of the specific activity curves gives an excellent indication of the continuous and steady processes by which radioactivity is distributed into the various body pools. Studies have been made with mice, rats, guinea pigs, and rabbits. As small an amount as 0.1  $\mu$ c C<sup>14</sup> has been used for an 8-hour study in mice. The instrument can be readily adapted for use in large animal or human studies following administration of small amounts of C<sup>14</sup>.

CONTINUOUS C<sup>14</sup>O<sub>2</sub> AND CO<sub>2</sub> EXCRETION STUDIES  
IN EXPERIMENTAL ANIMALS\*

B. M. Tolbert, Martha Kirk, and E. M. Baker

Radiation Laboratory and Department of Chemistry  
University of California, Berkeley, California

August 10, 1955

The excretion of carbon dioxide is quantitatively the most important end fate of carbon ingested in animal systems. Except for basal-metabolism measurements and respiratory-quotient determinations, the rate of excretion of this biologically important compound has not been extensively used in biochemical and physiological studies; much of this lack of use is because the carbon excreted comes from many different sources and is not specifically related to any given biochemical process. While the use of metabolites labeled with carbon-14 provides an answer to the lack of specificity in carbon dioxide excretion, it has not been easy to make use of such a test because of inadequate instrumentation.

We have devised an apparatus that permits the continuous measurement and recording of respiratory carbon-14 patterns after the administration of labeled compounds to experimental animals. The CO<sub>2</sub> excretion is measured by infrared absorption, the carbon-14 excretion by an ionization chamber, and the specific radioactivity by a ratio analyzer. A number of comparative respiratory patterns have been determined with this equipment, with labeled amino acids, fats, fatty acids, and sugars as substrates. Respiratory carbon-14 patterns have also been determined for a single substrate with mice, rats, and rabbits. Although complete interpretation of these respiratory patterns is going to be quite difficult, visual comparison of the data can be used to evaluate variation at the biochemical level of the over-all physiological state of intact animals. These possibilities are particularly interesting in view of the fact that the instrument may be easily modified to permit measurements on human subjects using very small amounts of administered radiocarbon.

---

\* A preliminary report of this work is presented in abstract form in Federation Proc. 14, 151 (1955). This paper was presented at the meeting of the Federation of American Societies for Experimental Biology, San Francisco, California, April 1955.

## EQUIPMENT AND EXPERIMENTAL PROCEDURE

The animal to be studied is injected with a carbon-14-labeled compound and placed in a cage no larger than necessary for the particular animal's size (see Fig. 1). A flow system provides air to the cage from a compressed air tank. A compressed air source is desirable since the air from such a source is clean, easy to maintain at a constant flow rate, and-- if aged for at least a month-- free of alpha contamination from radon and thoron.

The air from the animal cage is passed through a small sulfuric acid bubbler to remove most of the water, and into an ionization chamber. The beta radioactivity from the  $C^{14}O_2$  produces electrons, which are collected on the center electrode of the ion chamber; these electrons produce a voltage directly proportional to the radioactivity in the chamber. This voltage is measured by a vibrating-reed electrometer\* and recorded on a multichannel potentiometer† recorder. The electrometer-ion-chamber unit is calibrated by use of a tank of compressed 2%  $CO_2$ -in-air, which contains  $0.7 \mu c C^{14}$ /liter. The precision of calibration is about  $\pm 1\%$ .

Several ionization chambers were used for the experiments described in this paper, but the most satisfactory for small animal work was a novel one-liter screen-grid chamber (see Fig. 2). This ionization chamber has a very low and very stable background, and the screen grid suppresses electron showers and  $\alpha$  pulses originating from the walls.

The calibration constants for the several ionization chambers were all about  $2.5 \times 10^{-4} \mu c/mv$  for the  $10^{-12}$ -ohm grounding resistor (see later section). This sensitivity is such that a dose of  $40 \mu c C^{14}$  per kg body weight gives an excellent 8-hour respiration curve for rats. This is the value used for most of the experiments described in this paper. By increasing the grounding resistor to  $10^{13}$  ohms, decreasing the air-flow rate, and working closer to the ionization chamber background, one can reduce the dose-weight ratio to about  $0.2 \mu c/kg$  body weight and still give a respiration curve reliable to  $\pm 5\%$ .

---

\* Model 30, Applied Physics Corporation, Pasadena, California.

† Speedomax Recorder, 0- to 10- mv range, Leeds and Northrup, Philadelphia, Pa.

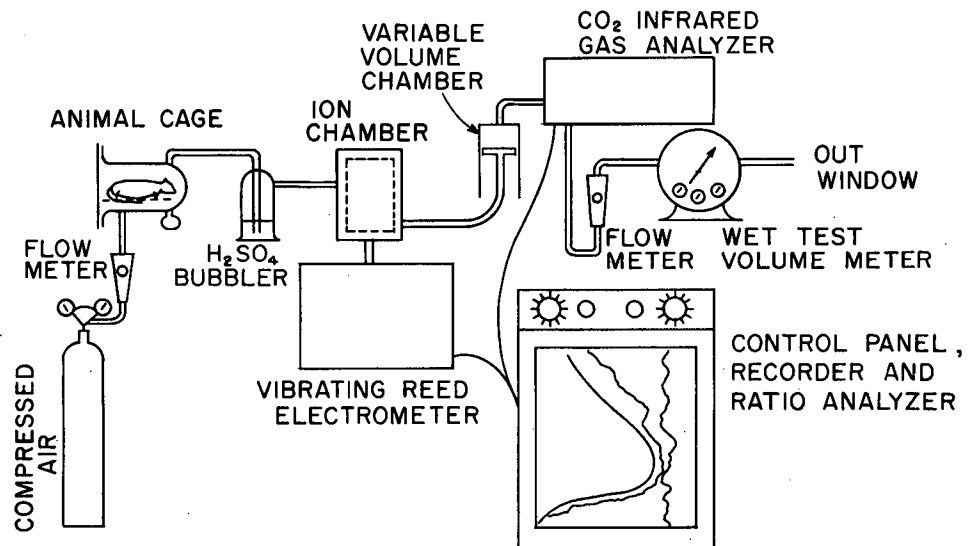

SCHMATIC DIAGRAM OF RESPIRATORY  $C^{14}O_2$  ANALYZER

MU-9185

Fig. 1. Schematic diagram of respiratory  $C^{14}O_2$  analyzer.



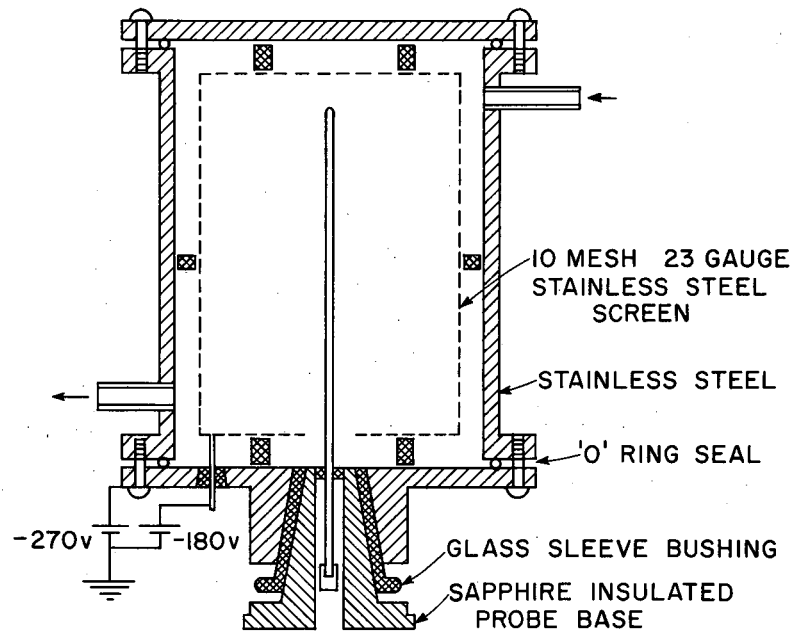

SCREEN GRID IONIZATION CHAMBER  
APPROXIMATE INTERNAL DIMENSIONS ARE 5 1/2" X 4"

MU-9186

Fig. 2. Screen-grid ionization chamber. The internal dimensions of the cylindrical chamber are 5.25 by 4 inches. The screen grid is kept at least 0.5 inch from the wall.

The air then passes through a variable-volume chamber (see later section) and into an infrared carbon dioxide analyzer\* which produces an electrical signal proportional to the percent  $\text{CO}_2$  present; this signal is sent to the recorder. Flow rates were such that  $\text{CO}_2$  concentrations varied from 1% to 2%. In this range no commercially available infrared  $\text{CO}_2$  analyzer is linear in response, primarily because of broadening of the  $\text{CO}_2$  absorption band in atmospheric pressure systems. We have compensated for this difficulty by standardizing the instrument so that it is correct at 0%  $\text{CO}_2$ , and at the nominal value of the  $\text{CO}_2$  concentration produced by the animal at the flow rate used. Maximum variation in  $\text{CO}_2$  production from this nominal value will not introduce errors of more than 2% to 3%. Standardized tanks of  $\text{CO}_2$ -in-air mixtures are used for these calibrations.

From the  $\text{CO}_2$  analyzer the air passes through a variable-area flowmeter,† and is exhausted outdoors. The accuracy of the radioactive measurements is directly dependent on the flow rate; since the flowmeter is not a very precise instrument, it is used mostly for an indication of the flow, and actual rate values are calculated from gas-volume measurements of the wet-test meter over given periods of time.

The Leeds and Northrup multichannel Speedomax recorder, which records the  $\text{C}^{14}$  and percent  $\text{CO}_2$  values, has been extensively modified so that it will also determine and record the  $\text{C}^{14}/\text{CO}_2$  value, i. e., the specific activity of the  $\text{C}^{14}\text{O}_2$ . In a three-step cyclic process the  $\text{C}^{14}$  and %  $\text{CO}_2$  potentials are each compared to a standard voltage, and then the  $\text{C}^{14}$  potential is compared to the %  $\text{CO}_2$  voltage. A 12-pole 4-wafer switch driven by the recorder motor is used to make these changes. Figure 3 indicates schematically what is happening. A series of 10-turn helical potentiometers is added to control the ranges of the several electrical signals, and the entire electrical instrument is carefully adjusted to about 1% accuracy with a standard potentiometer. It is generally desirable to maintain the %  $\text{CO}_2$  signal as high as possible because of the limited sensitivity of the servo-mechanism, which becomes critical in the ratio-analyzing position.

---

\* Liston-Becker Infrared Gas Analyzer, stabilized by means of a Sorenson voltage regulator.

† Tri-Flat Flowrater, Fischer-Porter Co., Hatboro, Pa.

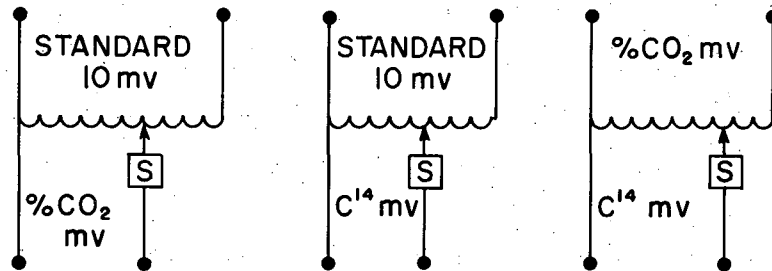

POSITION 1 : %CO<sub>2</sub>    POSITION 2 : C<sup>14</sup>    POSITION 3 : C<sup>14</sup>/%CO<sub>2</sub>

OPERATING PRINCIPLE OF THE RATIO ANALYZER AND RECORDER

S INDICATES A SERVO MECHANISM DRIVING THE SLIDE WIRE TO A POSITION OF NULL CURRENT FLOW

MU-9187

Fig. 3. Operating principle of the ratio analyzer and recorder. S indicates a servo mechanism which drives the slide wire to a position of null current flow.

### Response Times

A very important concept in the operation of this instrument and in the biological studies to follow is that of response times. We are dealing with a dynamic system in the form of an animal and its metabolic processes, and since there is a finite time involved in gas flow and in response of the two gas analyzers, it is necessary that all time factors be considered:

(a) The rat cage has an effective volume of about 400 cc; for larger animals this volume is proportionally increased. With an air flow of 400 cc/min and with complete mixing of the gases assumed, half of any radioactivity respired by the rat will be passed on in  $\ln 2$  minutes or about 42 sec. To get 99% transfer of a given quantity of respired air will require about 5 minutes. Since complete mixing of air in the rat cage does not occur, transfer times are markedly less than these figures. This mixing of fresh and stale air in the rat cage is the first limiting factor in the resolving power of the machine, i. e., its ability to record instantaneous respiratory carbon values. When larger cages are used for bigger animals flow rates are also increased, so this limiting resolving power of the machine remains more or less constant.

(b) The volume of the sulfuric acid bubbler is small compared to that of the animal cage and ionization chamber. As a first approximation its effect on time factors may be ignored.

(c) The time in seconds for 63% response of the electrometer is equal to the value (in ohms) of the grounding resistor times the capacitance (in farads) of the electrometer head. The capacitance of the electrometer is fixed at about  $12 \times 10^{-12}$  farad. The grounding resistance is inversely proportional to the sensitivity of the electrometer and is varied from  $10^{11}$  to  $10^{13}$  ohms. On the most sensitive range the 63% response time is 150 sec and 99% response requires 7.7 min. With the  $10^{11}$ -ohm resistor 63% response requires only one second.

(d) The half time for response of the ion chamber-electrometer combination to  $C^{14}$  is further modified by the continuous change of air in the ion chamber itself. For a one-liter ion chamber and 400 cc/min flow rate, and complete mixing of the gases, 1.8 min will be required for the gas concentration in the chamber to reach the mid-point of the differential between a given input  $C^{14}$  concentration and given initial chamber  $C^{14}$  concentration. Thus we see that, for these flow conditions, electrometer time response is the limiting

factor when the  $10^{13}$ -ohm resistor is used, but that otherwise the flow rate is the limiting time factor. For optimum operating conditions the electrometer response time should approximate the flow-rate time factor (see later section).

(e) The carbon dioxide infrared gas analyzer has an electrical 90% response time of 0.7 sec; the volume of the gas cell is only a few cc. Compared to the rest of the system this response is very fast.

If the  $C^{14}O_2$  specific activity values are to be representative of the actual values, and not artifacts of the machine, it is necessary that the half time for response of both the  $C^{14}$  and  $CO_2$  analyzer be the same and that there be no great time lag (i. e., phase shift) of one instrument with respect to the other. Since the response time of the  $CO_2$  analyzer is much faster than that of the  $C^{14}$  analyzer, it is necessary to provide additional mixing volume if the ion chamber and animal cage do not provide sufficient mixing of the respired air. This additional volume consists of a variable-volume chamber inserted between the  $C^{14}$  and the  $CO_2$  analyzers. The variable-volume chamber is adjusted by trial and error; it compensates for many factors. Since this variable-volume chamber introduces a time lag, i. e., a phase shift, of one instrument with respect to the other, its volume should be kept to a minimum. If the volume is comparable to that of the ion chamber, it is preferable to use a bigger ion chamber, which will then give a better dynamic balancing of the entire system as well as greater sensitivity for the  $C^{14}$  assay.

Experimental justification for the time concepts presented above have been obtained by adding  $C^{14}O_2$  to the flow system from a tank of compressed radioactive carbon dioxide, of about the specific activity exhaled by the experimental animal. This  $C^{14}O_2$  has a constant specific activity. As one varies the rate of addition of this  $C^{14}O_2$  to a properly adjusted system, a straight-line response for the  $C^{14}$  specific activity will be seen on the ratio recorder. This procedure also provides a convenient method for adjusting this variable-volume chamber.

Figure 4 is a reproduction of a typical rate curve as plotted by the recorder. The abrupt breaks in the  $C^{14}$  and the  $C^{14}/\% CO_2$  curves represent changes in the sensitivity of the electrical instruments, made to give maximum accuracy of the recorded results.

RESPIRATORY  $C^{14}O_2$  PATTERN FOR A  
RAT INJECTED WITH GLYCINE - 2 -  $C^{14}$

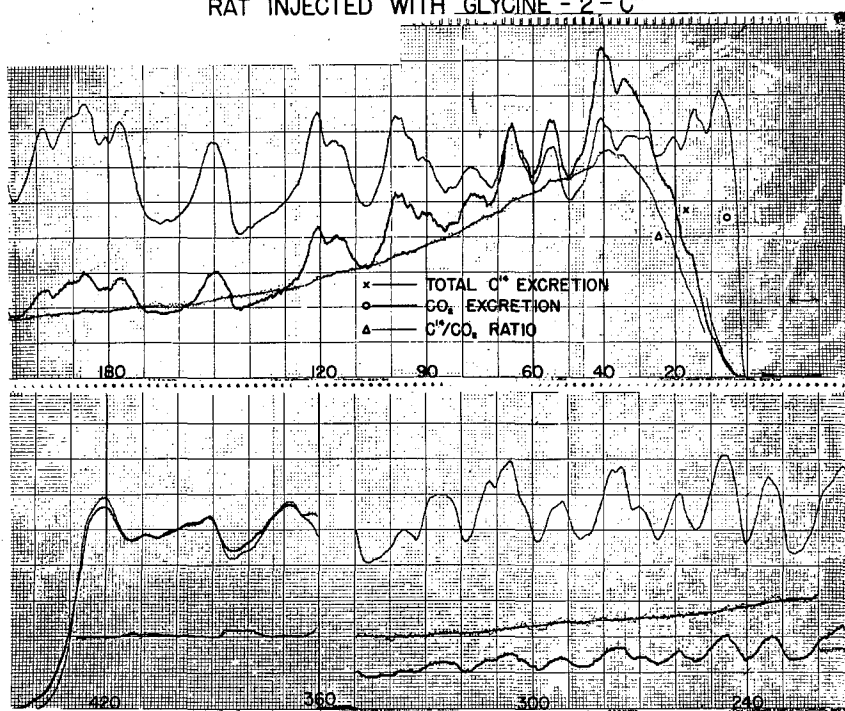

Fig. 4. Typical respiratory  $C^{14}O_2$  pattern for a rat injected with glycine-2- $C^{14}$ . The time in minutes is indicated on the bottom of the chart paper.

## EXPERIMENTAL RESULTS

The respiratory  $C^{14}O_2$  that is produced from a compound labeled in a given position represents the interaction of a complicated series of biochemical processes. It is this  $C^{14}O_2$  production that is measured by the machine just described. It does not seem possible at this time to represent these results by any simple series of numbers and equations. Eventually, it may be possible to describe respiratory patterns in terms of a mathematical equation, but this is another project. Therefore, we have chosen to present the respiratory  $C^{14}O_2$  production as a series of graphs to be visually compared and evaluated.

The respiratory  $C^{14}$  patterns for a given compound in a given animal are presented as two curves: the specific activity of  $C^{14}O_2$  in millimicrocuries (m $\mu$ c) per gram of carbon vs time in minutes; and as the cumulative respiratory excretion of  $C^{14}O_2$  in percent of injected dose vs time in minutes. The specific-activity curve comes directly from the ratio curve produced by the machine and known calibration factors; this curve is normalized to a dose-weight ratio of 40  $\mu$ c  $C^{14}$  per kg body weight. The cumulative excretion is determined by integrating the curve for the rate of  $C^{14}$  excretion with a polar planimeter and dividing the integrated  $C^{14}$  values by the injected dose of radioactivity to give percent excretion. For each experiment reported in this paper, several animals were studied, and the data presented are typical of the average.

Figures 5, 6, and 7 present the respiratory  $C^{14}$  patterns for sodium acetate-2- $C^{14}$ , glucose- $C^{14}_6$ , DL-leucine-3- $C^{14}$ , glycine-2- $C^{14}$ , and tri-palmitin-carboxyl- $C^{14}_3$ . The compounds were administered intraperitoneally (i. p.) in 1-to 5-mg quantities, containing about 10  $\mu$ c of  $C^{14}$  and dissolved in 0.2 ml water. Figure 5 shows the specific activity of the  $C^{14}O_2$  plotted on ordinary graph paper. Peak specific activities occur for all these compounds within the first hour. In order to show more accurately the low excretion-rate curves and to show the absence or presence of distinct first-order rate processes, we have also plotted these data on semilog paper (Fig. 6). There the increasing specific activity curves seem to be almost straight lines; the rest of the curves do not show any distinct first-order process, except for the DL-leucine-3- $C^{14}$  curve. Since the D-isomer is an abnormal metabolite, we may be seeing primarily the oxidation pattern for the D-isomer in the later part of the respiratory curve, and since this curve is a straight line,

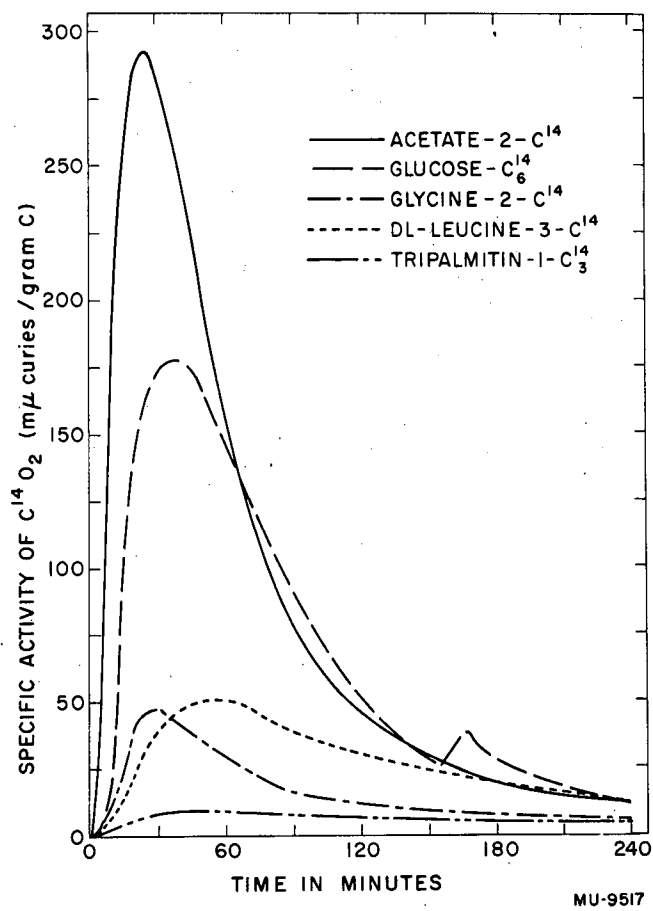

Fig. 5.  $C^{14}O_2$  excretion rate curves for several  $C^{14}$ -labeled metabolites.



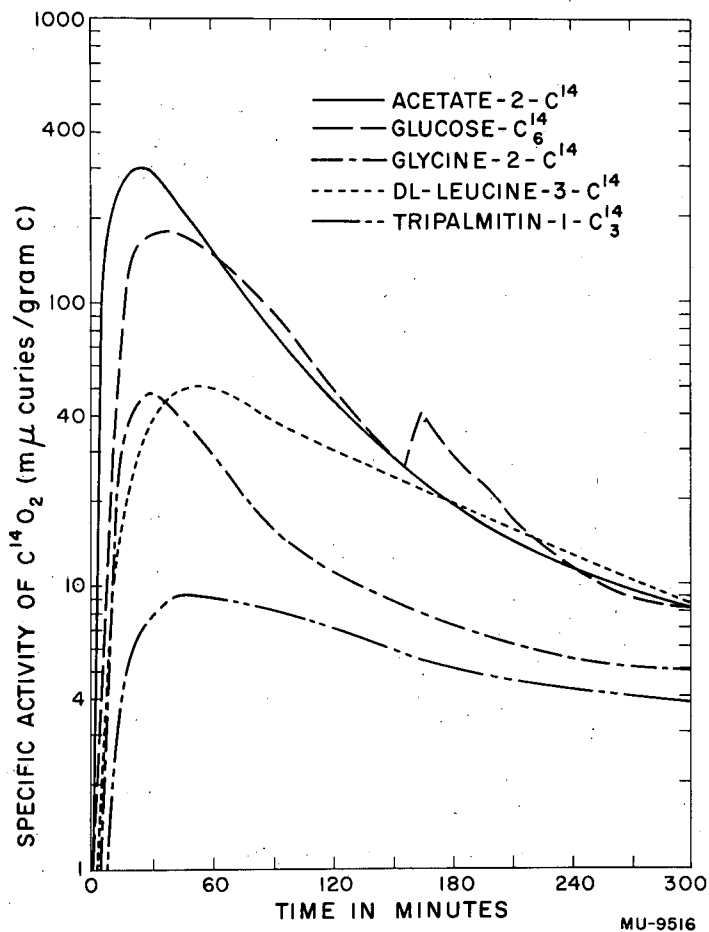
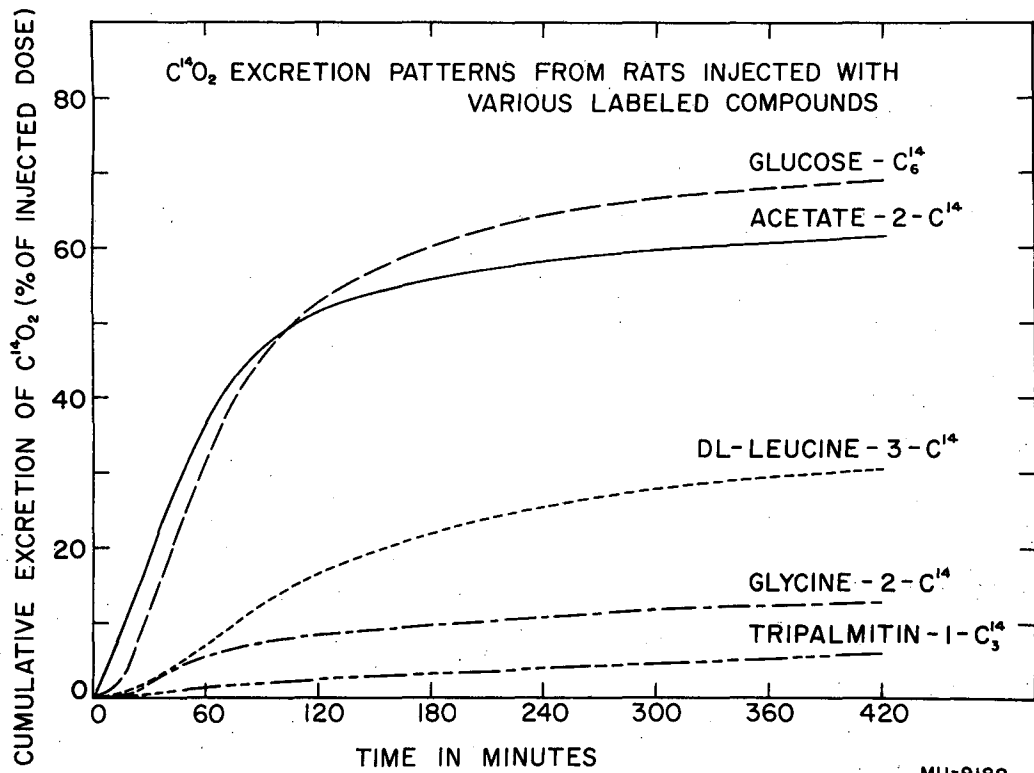

Fig. 6. Semilog plot of  $C^{14}O_2$  excretion rate curves for several  $C^{14}$ -labeled metabolites.



MU-9188

Fig. 7. Cumulative  $C^{14}O_2$  excretion for several  $C^{14}$ -labeled metabolites.

we can infer that the rate-limiting reaction in this process may be directly dependent on the D-leucine concentration and is probably a deamination reaction.<sup>2,3</sup>

Acetate-2-C<sup>14</sup> and glucose-C<sup>14</sup><sub>6</sub> are metabolized at comparable rates and the radioactivity is over 60% excreted in six hours. Glycine-2-C<sup>14</sup> and DL-leucine-3-C<sup>14</sup> are metabolized at about one-tenth the rate of the acetate. The fat, tripalmitin, is even less rapidly oxidized to CO<sub>2</sub>; it must be mostly equilibrated with a large body pool having a slow turnover rate. Figures 8, 9, and 10 compare the respiratory C<sup>14</sup> patterns for a given compound, sodium acetate-2-C<sup>14</sup>, in a normal rat and mouse. The variations in the rate at which these different animals excrete C<sup>14</sup>O<sub>2</sub> are less than the variations stemming from different types of compounds seen in the previous set of figures.

How satisfactorily this machine is able to represent the instantaneous respiratory levels of an animal system is an important question. As used, the machine's minimum 50% response time for respiratory changes was about one minute, except for the tripalmitin curves, which were made using a 50% response time of about 5 minutes. Figure 11 shows the variations in specific activity curves produced by changes in the grounding resistor and ion-chamber size which, in turn, change the 50% response time. The curves made using the 10<sup>13</sup>-ohm resistor show an appreciable time lag in peak excretion of C<sup>14</sup> as compared to those made using the 10<sup>12</sup>-ohm resistor. A smaller ion chamber helps to hasten the response of the system. Some of the differences in maximum specific activity of C<sup>14</sup>O<sub>2</sub> seen in the curves are due to animal variations.

Thus we see that a rapid instrument response is necessary in analyzing C<sup>14</sup>O<sub>2</sub> excretion rates for rapidly metabolized compounds. However, from the data of Gould et al.<sup>4</sup> we can estimate that the half time for elimination of body CO<sub>2</sub> is about 15 minutes, and this figure agrees with our calculated values. Except for carboxyl-labeled fatty acids, most compounds are oxidized more slowly than CO<sub>2</sub> is eliminated. Therefore, instrument response times do not need to be faster than 15 minutes except during the first hour or so after injection.

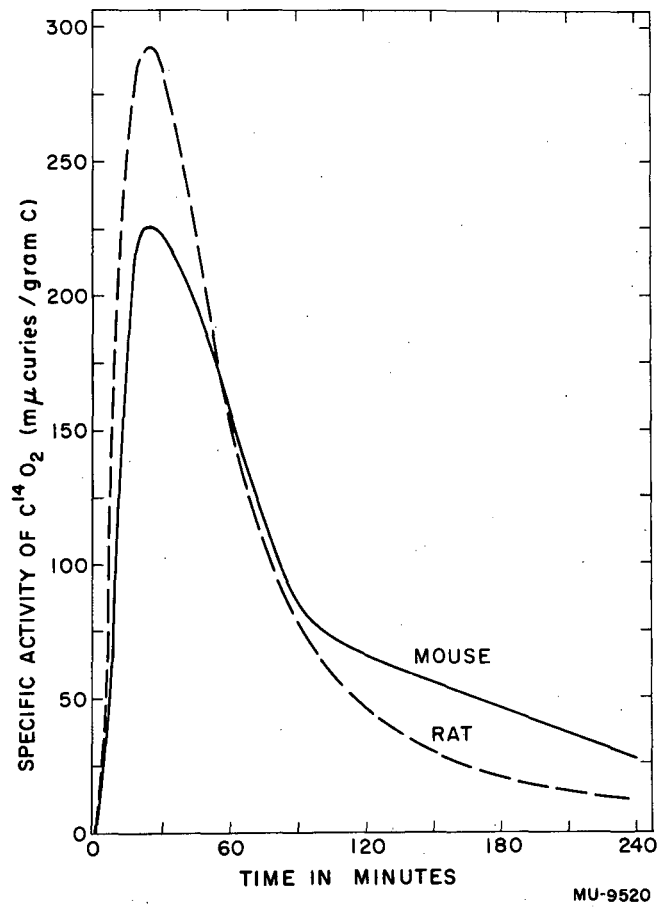

Fig. 8.  $C^{14}O_2$  excretion rate curves following injection of sodium acetate-2- $C^{14}$ .

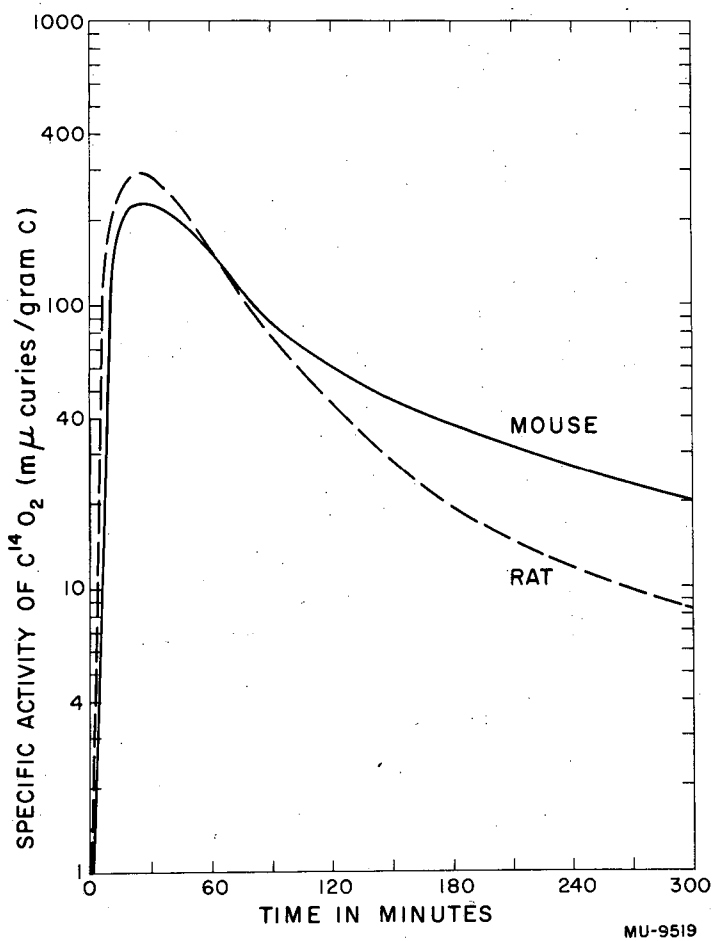

Fig. 9. Semilog plot of  $C^{14}O_2$  excretion rate curve following injection of sodium acetate-2- $C^{14}$ .

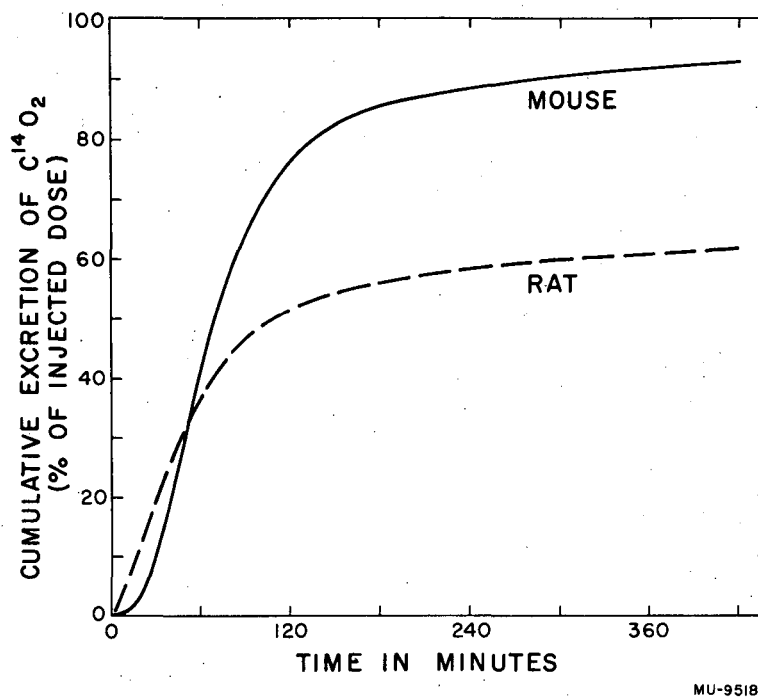
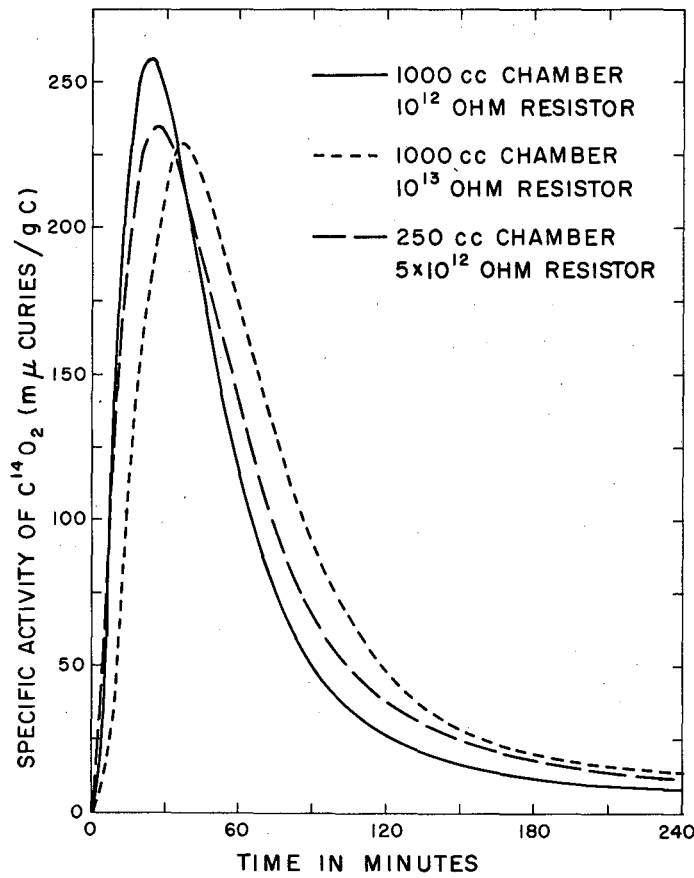

Fig. 10. Cumulative  $C^{14}O_2$  excretion following injection of sodium acetate-2- $C^{14}$ .



MU-9994

Fig. 11. Effect of instrument variables on  $C^{14}O_2$  excretion rate curves. The cumulative percent excretions for these three curves were 64.9%, 64.1%, and 64.7% of the injected dose in 7 hours.

## DISCUSSION

If correlations between the physiological state and the respiratory pattern for a series of compounds can be determined and interpreted, it may be possible to define a series of generalized tests that will help to evaluate physiological state on a biochemical level. The method and equipment described in this paper are capable of modification for use with almost any animal, and the sensitivity is such that satisfactory respiratory  $C^{14}$  patterns should be obtained with about 1  $\mu$ c of compounds such as acetate or glucose in humans.

Several interesting questions can be directly answered from the respiratory data. For compounds such as acetate and glycine the specific-activity excretion curves are smooth, continuous functions, increasing to a peak value and then always decreasing. Although the total  $C^{14}$  and the %  $CO_2$  excreted by an animal may vary by a twofold factor within a few minutes, there are no irregularities in the smoothly decreasing (or increasing) specific-activity curves.

For glucose- $C^{14}_6$  this is not the case, and with marked physical activity of the animal (rat) additional radioactivity is mobilized and temporarily reverses the gradual decrease of the  $C^{14}O_2$  specific activity. This effect was observed at least once in every rat glucose curve measured. Since this effect was not observed in the acetate or glycine curves, it is probable that this easily mobilized form of sugar is glycogen, stored in the liver. The work of Stetten and Stetten<sup>5</sup> has indicated that the recently laid down glycogen is more readily mobilized than glycogen deposited some time previously. The uniqueness of our glucose metabolism curves is interesting confirmation of these results.

After i. p. injection of acetate-2- $C^{14}$  or glucose- $C^{14}_6$ , or any of the other compounds listed, measurable quantities of  $C^{14}O_2$  appear in the breath in from one to three minutes. Since these time values are of the same magnitude as the minimum response time of the instrument, they set a limit for the minimum oxidation-excretion time of such labeled compounds. In the rat maximum excretion rates occur within the first hour for the five compounds studied.



### ACKNOWLEDGMENTS

The authors wish to thank Professor Melvin Calvin for his interest and help in this work, and to thank Mr. David Merrill for devising and constructing the modifications of the multichannel recorder.

This work was done under the auspices of the U. S. Atomic Energy Commission.

### REFERENCES

- (1) B. M. Tolbert, Ann M. Hughes, Martha R. Kirk, and M. Calvin, University of California Radiation Laboratory Report No. UCRL-2849, April 18, 1955; Arch. Biochem. Biophys., in press.
- (2) H. J. Almquist, in Amino Acids and Proteins, D. M. Greenberg, Ed., C. C. Thomas (publisher), 1951, p. 602.
- (3) H. Tarver, ibid., p. 773-781.
- (4) R. C. Gould, F. M. Sinex, I. N. Rosenberg, A. K. Solomon, and A. B. Hastings, J. Biol. Chem. 177, 295 (1949).
- (5) DeWitt Stetten, Jr., and Marjorie R. Stetten, "Glycogen Regeneration in Intact Animals," Federation Proc. 13, 304 (1954).