

Continuum Modeling of the Development of Intralaminar Cracking in Composite Laminates

RAMESH TALREJA

Department of Solid Mechanics, The Technical University of Denmark, Lyngby, Denmark

ABSTRACT

Intralaminar cracking in composite laminates has been found to develop as a set of parallel cracks whose average spacing reduces with increasing stress level or with increasing number of cycles of a given stress amplitude. The average crack spacing has been found in some instances to approach a minimum which has been interpreted as saturation or characteristic state. These features of the intralaminar cracking are predicted by the continuum model presented here. The model characterizes the intralaminar cracking by a second-order damage tensor defined on a representative volume element of the cracked laminate and describes the development of this cracking by the rate of the damage tensor. The components of the damage rate tensor are treated as response functions subjected to the initial material symmetry restrictions. An incremental solution to the rate equations shows that the crack density is an exponential function of the strain and displays the experimentally observed characteristics.

INTRODUCTION

Modeling of damage in composite materials has been undertaken by various authors. Most models have been based on a micromechanics type approach which by its nature treats a particular composite geometry and a particular crack geometry. (See, for instance, Laws, Dvorak and Hejazi 1983; Hashin 1985, 1987; and Aboudi 1987). All these models have aimed at predicting stiffness changes in composites due to cracking and have verified the calculated change in the longitudinal Young's modulus due to transverse cracks in a composite. The agreement between the calculated and the measured values of the Young's modulus has been good for all models, indicating the lack of sensitivity of this property to the details and assumptions of the models and thus not permitting a critical assessment of the models.

The present author presented a continuum characterization of damage and incorporated it as internal state variables in a constitutive theory of materials response based on the thermodynamics framework given by Coleman and Gurtin (1967) (Talreja 1985). This approach provided three main results which are not given by the models referred to above: 1) prediction of the changes in the initial material symmetry caused by damage, 2) stiffness changes for all possible crack patterns, and 3) possibility of formulating the damage evolution equations as an integral part of the theory. The stiffness change prediction methodology was developed, illustrated and verified by extensive comparison with experimental data (Talreja 1985, 1986).

The damage characterization, which was initially based on vectorial variables, was generalized to the second-order tensorial level and an initial attempt to treat damage evolution was presented

(Talreja 1987).

Recently, other phenomenological approaches to composite damage modeling have appeared in the literature (Allen, Groves and Harris 1987; Allen, Harris and Groves 1987; Harris, Allen and Nottorf 1987; and Weitsman 1987).

The present paper will report continuation of the effort to treat damage evolution in composites initiated in Talreja (1987). It will be shown that a treatment of the damage rate tensor as a response function, in the same way as other response functions such as stress and the Helmholtz free energy, leads to the result that the damage depends exponentially on strain in a load increment where the stress-strain response is linear. An exploitation of this result shows that the experimentally observed features of intralaminar crack development are in agreement with the damage rate equation and that these experimental results can be interpreted in a new light.

THE DAMAGE TENSOR

A tensorial characterization of damage has been presented in Talreja (1987). However, for the sake of completeness of the present paper, it will be briefly recapitulated here. Referring to Fig. 1 consider a generic point P in a damaged composite. Consider now a representative volume element of volume

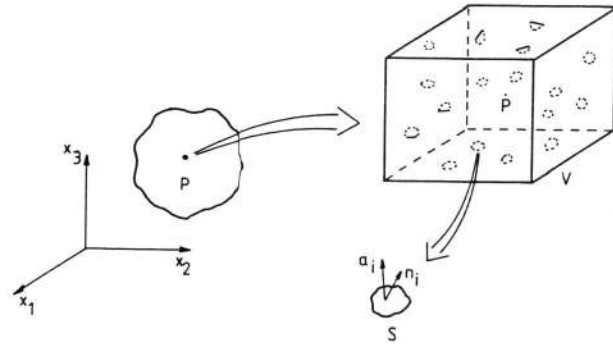

Fig. 1. A tensorial characterization of damage.

V about point P containing a number of damage entities. Let us assign two vectors \mathbf{a} and \mathbf{n} to the surface S of a damage entity such that \mathbf{n} is a unit outward normal to a considered point on S and \mathbf{a} represents, in some appropriate way, the "influence" of the point on the surrounding medium. The "influence" is, at this stage, a conceptual entity whose manifestation depends on the materials response characteristic under consideration at point P .

Let us define a damage entity tensor \mathbf{d} which in component form is given by,

$$d_{ij} = \int_S a_i n_j dS \quad (1)$$

Assuming now that the total set of damage entities in the volume V is separable into n subsets, each representing a damage mode, and denoting a damage mode by $\alpha = 1, 2, \dots, n$, let us define a damage mode tensor given by,

$$D_{ij}^{(\alpha)} = \frac{1}{V} \sum_{k=1}^n (d_{ij})_{k\alpha} \quad (2)$$

where k is the number of damage entities in the damage mode denoted by α .

Decomposing \mathbf{a} as

$$a_i = a_{ni} + b_{mi}, \quad n_{jm_i} = 0 \quad (3)$$

and assuming \mathbf{b} to be negligible, the damage mode tensor is expressed as

$$D_{ij}^{(\alpha)} = \frac{1}{V} \sum_{k=1}^n \left[\int_S a_{ni} n_j dS \right]_{k\alpha} \quad (4)$$

INTRALAMINAR CRACKING - DAMAGE TENSOR

The damage tensor (4) will now be expressed for intralaminar cracking in laminates. Consider a representative element of a laminate shown in Fig. 2 having a parallel array of cracks in a ply of thickness t_c . The volume of the element is $V = LWt$, where L , W and t are the length, width and thickness of the element. The surface area of a crack is $S = t_c W / \cos \theta$ where θ is angle between the

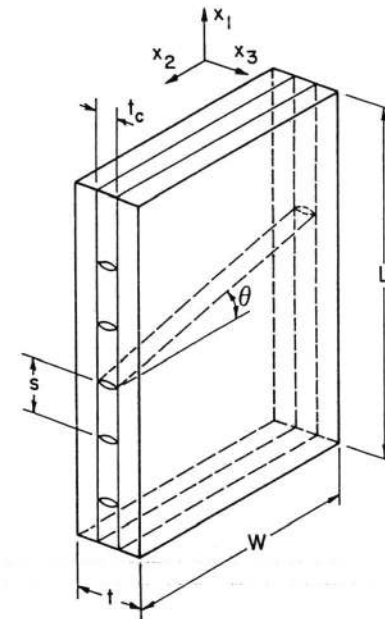

Fig. 2. A representative volume element of a laminate with intralaminar cracks.

fiber direction and the transverse direction. Assume, as a first approximation, the quantity a appearing in (4) to be proportional to the crack length (i.e. the cracked ply thickness) and write it as $a = \kappa t_c$. The damage tensor (4) can now be written for intralaminar cracks as

$$D_{ij} = \frac{\kappa t_c^2}{t \cos \theta} n_i n_j \quad (5)$$

where $n_j = (\cos\theta, \sin\theta, 0)$ and s is the crack spacing shown in Fig. 2. The index α for mode has been dropped here since we shall consider the intralaminar cracking only.

INTRALAMINAR CRACKING - DAMAGE RATE TENSOR

The damage tensors $D^{(\alpha)}$ may be regarded as internal state variables in a thermodynamics framework for description of the materials response. In the framework developed by Coleman and Gurtin (1967) the temporal rates of the internal variables are taken as response functions. Alternatively, one may define an internal dissipation potential as the work done by the thermodynamical generalized forces conjugate to the internal variables (see, for instance, Rice 1971) and regard this potential as a response function. The latter approach is commonly used where the internal variables are not found amenable to physical measurements. In our case, however, the damage tensor components can be specifically measured by nondestructive techniques, e.g. X-ray radiography. We therefore adopt the Coleman-Gurtin approach and write the damage rate tensor components for purely mechanical response as

$$\dot{D}_{ij}^{(\alpha)} = \dot{D}_{ij}^{(\alpha)} \left[e_{kl}, D_{mn}^{(\beta)} \right], \quad (6)$$

where e_{kl} is the small strain tensor.

We shall not treat the form of the damage rate tensors in a general case but only discuss the case of transverse cracking in thin, symmetric laminates subjected to inplane loading since the experimental data for this case is available.

Adopting the Voigt notation ($e_{11} = e_1, e_{22} = e_2, e_{33} = e_3, 2e_{23} = e_4, 2e_{13} = e_5, 2e_{12} = e_6; D_{11} = D_1, D_{22} = D_2, D_{33} = D_3, D_{13} = D_4, D_{12} = D_5, D_{23} = D_6$) and dropping the index for damage mode, (6) is rewritten as

$$\dot{D}_p = \dot{D}_p(e_q, D_r) \quad (7)$$

where $p = 1, 2, \dots, 6$.

For transverse cracking we have $\theta = 0$ in (5) and the only nonzero component of the damage tensor is

$$D_1 = D_{11} = \frac{\kappa t_c^2}{st} \quad (8)$$

The damage rate tensor (7) for plane stress becomes

$$\dot{D}_1 = \dot{D}_1(e_1, e_2, e_3, e_6, D_1) \quad (9)$$

The response function (9) must be restricted in form to comply with the initial material symmetry. Considering laminates with midplane symmetry the initial material symmetry is orthotropic and the function (9) for this case must be expressed in terms of the orthotropic invariants (see, for instance, Adkins 1959). Thus we have,

$$\dot{D}_1 = \dot{D}_1(e_1, e_2, e_3, e_6^2, D_1) \quad (10)$$

Writing (10) as a polynomial function in its variables and restricting it to quadratic terms in strain and linear terms in the damage component, we have,

$$\begin{aligned} \dot{D}_1 = & d_0 + d_1 e_1 + d_2 e_2 + d_3 e_3 + d_4 D_1 \\ & + d_5 e_1^2 + d_6 e_2^2 + d_7 e_3^2 + d_8 e_1 e_2 \\ & + d_9 e_1 e_3 + d_{10} e_2 e_3 + d_{11} e_6^2 + d_{12} e_1 D_1 \\ & + d_{13} e_2 D_1 + d_{14} e_3 D_1 + d_{15} e_1^2 D_1 \\ & + d_{16} e_2^2 D_1 + d_{17} e_3^2 D_1 + d_{18} e_1 e_2 D_1 \\ & + d_{19} e_1 e_3 D_1 + d_{20} e_2 e_3 D_1 + d_{21} e_6^2 D_1 \end{aligned} \quad (11)$$

where $d_0 - d_{21}$ are material constants that must be determined experimentally. A discussion concerning the determination of these constants is left for a future work. We shall here attempt to find some general features of the damage evolution process from the phenomenological expression (11).

Consider first the initial conditions for (11). Requiring that the damage rate be zero for undamaged and unstrained state, we get $d_0 = 0$. Furthermore, let us require that, until damage initiates at a certain strain state, the damage rate is zero, i.e.

$$\dot{D}_1 = 0 \text{ for } D_1 = 0 \quad (12)$$

This gives $d_1 = d_2 = d_3 = d_5 = d_6 = d_7 = d_8 = d_9 = d_{10} = d_{11} = 0$.

Since experimental data is only available for uniaxial loading of laminates in the longitudinal direction (along x-axis), let us consider a monotonic stress $\sigma_1 = \sigma_{11}$ applied at a constant rate $\dot{\sigma}_1 = r$. Since the stress is applied parallel to a symmetry direction there is no shear strain and (11) reduces, with initial conditions, to

$$\begin{aligned} \dot{D}_1 = & \left[d_4 + d_{12} e_1 + d_{13} e_2 + d_{14} e_3 + d_{15} e_1^2 + d_{16} e_2^2 \right. \\ & \left. + d_{17} e_3^2 + d_{18} e_1 e_2 + d_{19} e_1 e_3 + d_{20} e_2 e_3 \right] D_1 \end{aligned} \quad (13)$$

Let us now assume that the stress-strain response of a laminate is bilinear with the knee-point occurring at a threshold strain e_1^0 at which the initial damage D_1^0 (given by the initial crack density $\eta_0 = 1/s_0$) begins to grow. (See the schematic diagram in Fig. 3). The tangent modulus beyond the initiation of damage growth is given by

$$E_t = \frac{d\sigma_1}{de_1}, \quad e_1 > e_1^0 \quad (14)$$

Writing now

$$\dot{D}_1 = \frac{dD_1}{de_1} \frac{r_1}{E_t} \quad (15)$$

and using $\nu_{12} = -e_2/e_1$, and $\nu_{13} = -e_3/e_1$, (13) may be written as

$$\begin{aligned} \frac{dD_1}{D_1} = & \frac{E_t}{r_1} \left[d_4 + (d_{12} - d_{13}\nu_{12} - d_{14}\nu_{13})e_1 \right. \\ & \left. + \left[d_{15} + d_{16}\nu_{12}^2 + d_{17}\nu_{13}^2 - d_{18}\nu_{12} - d_{19}\nu_{13} + d_{20}\nu_{12}\nu_{13} \right] e_1^2 \right] de_1 \end{aligned} \quad (16)$$

which on integration gives

$$\log \frac{D_1}{D_1^0} = \frac{E_t}{r_1} \left[d_4 \left[e_1 - e_1^0 \right] + A \left\{ e_1^2 - (e_1^0)^2 \right\} + B \left\{ e_1^3 - (e_1^0)^3 \right\} \right] \quad (17)$$

where

$$A = \frac{1}{2}(d_{12} - d_{13}\nu_{12} - d_{14}\nu_{13}) \quad (18)$$

and

$$B = \frac{1}{3}(d_{15} + d_{16}\nu_{12}^2 + d_{17}\nu_{13}^2 - d_{18}\nu_{12} - d_{19}\nu_{13} + d_{20}\nu_{12}\nu_{13})$$

In integrating (16) ν_{12} and ν_{13} have been assumed constant in the range (D_1^0, D_1) . However, in general, ν_{12} and ν_{13} change with damage (Talreja 1986). Thus (17) may be used as a basis for an incremental solution of $D_1 - e_1$ variation with ν_{12} and ν_{13} calculated for the mean value of D_1 in each increment.

Using (8) in (17) with $\eta = 1/s$ we see that the crack density is an exponential function of strain. This is shown schematically in Fig. 3.

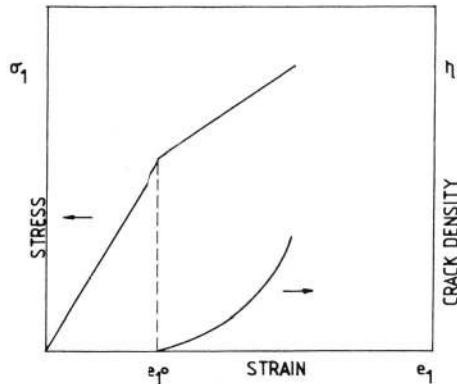

Fig. 3. A bilinear stress-strain behavior with associated development of transverse crack density.

If the stress-strain response displays two knee-points, shown schematically in Fig. 4, then using (17) in each range of constant tangent modulus, we see that the crack density evolves as two exponential curves shown schematically in Fig. 4. In the general case of nonlinear stress-strain

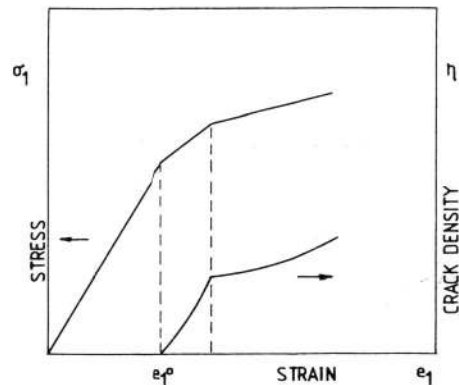

Fig. 4. A trilinear stress-strain behavior with associated development of transverse crack density.

response an incremental linearization shown schematically in Fig. 5 leads to the development of the crack density shown schematically in the figure in accordance with (17). An interesting feature is observed here: the crack density tends to a saturation value as the tangent modulus decreases from increment to increment. This result provides a new and different interpretation of the crack saturation process as compared to that given by the micromechanics analysis based on the local stress distributions, e.g. the shear lag analysis.

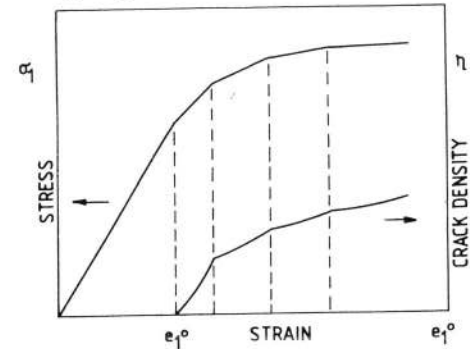

Fig. 5. An incrementally linear stress-strain behavior with associated development of transverse crack density.

DISCUSSION OF EXPERIMENTAL RESULTS

Consider first the experimental results on transverse cracking reported by Kistner, Whitney and Browning (1981), Fig. 6. A graphite-epoxy $(0,90)_4S$ laminate has been tested in monotonic tension in the 0° direction. The longitudinal stress - longitudinal strain and the longitudinal stress - transverse strain plots as well as the densities of the transverse cracks in the central two-ply thick layer and the outer one-ply thick layers are shown in the figure. The dotted lines indicate the stress and strain at which initiation of the transverse crack growth occurs. The tangent modulus following this is constant and in accordance with (17) and Fig. 3 the transverse crack evolution is predicted to be exponential, which is in agreement with the data in Fig. 6.

Consider next the data on transverse cracking of a glass-epoxy $(0,90)_3S$ laminate reported by Highsmith and Reifsnider (1982), Figs. 7 and 8. In Fig. 7 two knee-points are indicated by arrows.

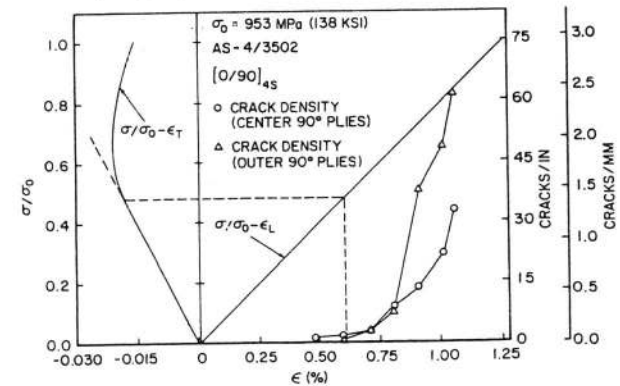

Fig. 6. The Kistner *et al.* data showing stress-strain behavior and associated transverse crack density of a graphite-epoxy $(0,90)_4S$ laminate.

(The discontinuity just before the second knee—point is assumed to correspond to this knee—point). The transverse crack density is shown plotted against the stress in Fig. 8. The data points are curve-fitted by two exponential curves, each corresponding to the straight—line region of the stress—strain plot, Fig. 7. The development of transverse cracking thus displayed is in agreement with the behavior predicted by (17) and illustrated by Fig. 4.

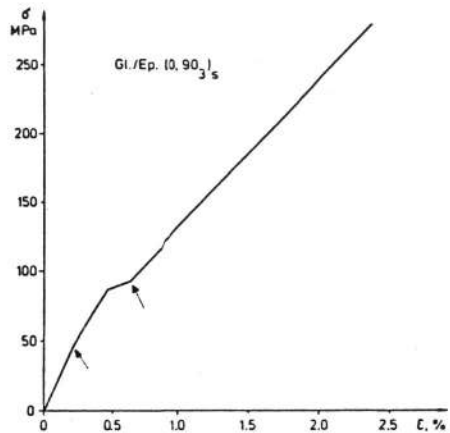

Fig. 7. Stress—strain behavior of a glass—epoxy $(0,90)_3s$ laminate reported by Highsmith and Reifsnider.

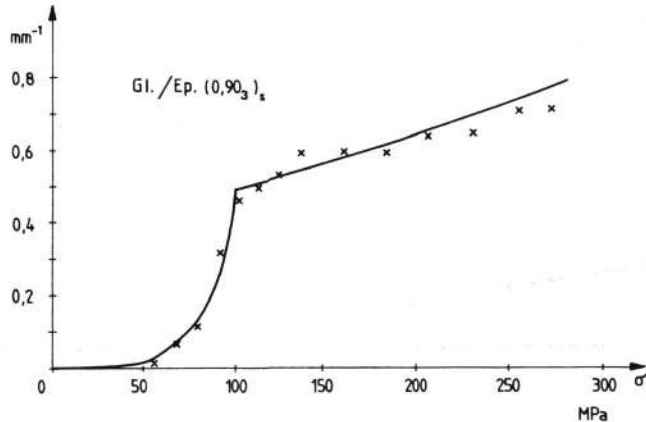

Fig. 8. Development of transverse crack density associated with the stress—strain behavior shown in Fig. 7.

Acknowledgement — The author thanks Dr. Nick Pagano for discussion and comments on this work.

REFERENCES

- Aboudi, J. (1987). Stiffness Reduction of Cracked Solids. *Engineering Fracture Mechanics*, 26, 637—650.
- Adkins, J.E. (1959). Symmetry Relations for Orthotropic and Transversely Isotropic Materials. *Archives of Rational Mechanics Analysis*, 4, 193—213.
- Allen, D.H., Groves, S.E. and Harris, C.E. (1987). A Thermomechanical Constitutive Theory for Elastic Composites With Distributed Damage — Part I. Theoretical Development. *International Journal of Solids and Structures*, 23, 1301—1318.
- Allen, D.H., Harris, C.E. and Groves, S.E. (1987). A Thermomechanical Constitutive Theory for Elastic Composites With Distributed Damage — Part II. Application to Matrix Cracking in Laminated Composites. *International Journal of Solids and Structures*, 23, 1319—1338.
- Coleman, B.D. and Gurtin, M.E. (1967). Thermodynamics With Internal State Variables. *Journal of Chemical Physics*, 47, 597613.
- Harris, C.E., Allen, D.H. and Nottorf, E.W. (1987). Damage Induced Changes in the Poisson's Ratio of Cross—Ply Laminates: An Application of a Continuum Damage Mechanics Model. In *Damage Mechanics in Composites*, A.S.D. Wang and G.K. Haritos (Eds.), AD—Vol. 12, American Society of Mechanical Engineers, New York, 17—24.
- Hashin, Z. (1985). Analysis of Cracked Laminates: A Variational Approach. *Mechanics of Materials*, 4, 121—136.
- Hashin, Z. (1987). Analysis of Orthogonally Cracked Laminates Under Tension. *Journal of Applied Mechanics*, 54, 872—879.
- Highsmith, A.L. and Reifsnider, K.L. (1982). Stiffness Reduction Mechanisms in Composite Laminates. In *Damage in Composite Materials*, ASTM STP 775, 103—117.
- Kistner, M.D., Whitney, J.M. and Browning, C.E. (1981). First Ply Failure of Graphite/Epoxy Laminates. In *Recent Advances in Composites in the United States and Japan*, ASTM STP 864, 44—61.
- Laws, N., Dvorak, G.J. and Hejazi, M. (1983). Stiffness Changes in Unidirectional Composites Caused by Crack Systems. *Mechanics of Materials*, 2, 123—137.
- Rice, J. (1971). Inelastic Constitutive Relations for Solids: An Internal Variable Theory and Its Application to Metal Plasticity. *Journal of Mechanics and Physics of Solids*, 19, 433455.
- Talreja, R. (1985). A Continuum Mechanics Characterization of Damage in Composite Materials. *Proceedings of the Royal Society, London*, A399, 195—216.
- Talreja, R. (1985). Transverse Cracking and Stiffness Reduction in Composite Laminates. *Journal of Composite Materials*, 19, 355—375.
- Talreja, R. (1986). Stiffness Properties of Composite Laminates With Matrix Cracking and Interior Delamination. *Engineering Fracture Mechanics*, 5/6, 751—762.
- Talreja, R. (1987). Modeling of Damage Development in Composites Using Internal Variables Concepts. In *Damage Mechanics in Composites*, AD—Vol. 12, American Society of Mechanical Engineers, New York, 11—16.
- Weitsman, Y. (1987). Coupled Damage and Moisture—Transport in Fiber—Reinforced, Polymeric Composites. *International Journal of Solids and Structures*, 23, 1003—1025.
- of a graphite—epoxy $(0,90)_{4S}$ laminate.