

We are IntechOpen, the world's leading publisher of Open Access books Built by scientists, for scientists

5,900

Open access books available

145,000

International authors and editors

180M

Downloads

Our authors are among the

154

Countries delivered to

TOP 1%

most cited scientists

12.2%

Contributors from top 500 universities



WEB OF SCIENCE™

Selection of our books indexed in the Book Citation Index
in Web of Science™ Core Collection (BKCI)

Interested in publishing with us?
Contact book.department@intechopen.com

Numbers displayed above are based on latest data collected.
For more information visit www.intechopen.com



Control of Efficient Intelligent Robotic Gripper Using Fuzzy Inference System

A.M. Zaki¹, O.A. Mahgoub², A.M. El-Shafei² and A.M. Soliman¹

¹*Power Electronics and Energy Conversion Department
Electronics Research Institute, Cairo*

²*Electric Power and Machines Department
Faculty of Engineering, Cairo University, Cairo
Egypt*

1. Introduction

In the last few years the applications of artificial intelligence techniques have been used to convert human experience into a form understandable by computers. Advanced control based on artificial intelligence techniques is called intelligent control. Intelligent systems are usually described by analogies with biological systems by, for example, looking at how human beings perform control tasks, recognize patterns, or make decisions. Fuzzy logic is a way to make machines more intelligent enabling them to reason in a fuzzy manner like humans. Fuzzy logic, proposed by Lotfy Zadeh in 1965, emerged as a tool to deal with uncertain, imprecise, or qualitative decision-making problems (Zadeh, 1965).

Controllers that combine intelligent and conventional techniques are commonly used in the intelligent control of complex dynamic systems. Therefore, embedded fuzzy controllers automate what has traditionally been a human control activity.

Traditional control approach requires modeling of the physical reality. Three methods may be used in the description of a system (Passino & Yurkovich, 1998) :

1. By experimenting and determining how the process reacts to various inputs, one can characterize an input-output table.
2. Control engineering requires an idealized mathematical model of the controlled process, usually in the form of differential or difference equations. But problems arise in developing a meaningful and realistic mathematical description of an industrial process: i- Poorly understood phenomena, ii- Inaccurate values of various parameters, iii-Model complexity.
3. Heuristic Methods: The heuristic method consists of modeling and understanding in accordance with previous experience, rules-of-thumb and often-used strategies. A heuristic rule is a logical implication of the form: If <condition> Then <consequence>, or in a typical control situation: If <condition> Then <action>. Rules associate conclusions with conditions. Therefore, the heuristic method is actually similar to the experimental method of constructing a table of inputs and corresponding output values where instead of having crisp numeric values of input and output variables, one use fuzzy values: IF input_voltage = Large THEN output_voltage = Medium.

Fuzzy control strategies come from experience and experiments rather than from mathematical models and, therefore, linguistic implementations are much faster accomplished. Fuzzy control strategies involve a large number of inputs, most of which are relevant only for some special conditions. Such inputs are activated only when the related condition prevails. In this way, little additional computational overhead is required for adding extra rules. As a result, the rule base structure remains understandable, leading to efficient coding and system documentation.

2. Logical inference

A connection between cause and effect, or a condition and a consequence is made by reasoning. Reasoning can be expressed by a logical inference or by the evaluation of inputs in order to draw a conclusion. We usually follow rules of inference which have the form: IF cause1 = A and cause2 = B THEN effect = C. Where A, B and C are linguistic variables.

2.1 Fuzzy sets

A fuzzy set is represented by a membership function defined on the universe of discourse. The universe of discourse is the space where the fuzzy variables are defined. The membership function gives the grade, or degree, of membership within the set of any element of the universe of discourse. The membership function maps the elements of the universe onto numerical values in the interval [0, 1]. A membership function value of zero implies that the corresponding element is definitely not an element of the fuzzy set, while a value of unity means that the element fully belongs to the set. A grade of membership in between corresponds to the fuzzy membership to the set. In practical situations there is always a natural **fuzzification** when someone analysis statements and a smooth membership curve usually better describes the grade that an element belongs to a set (Erdirencelebi et al., 2011).

Fuzzification: is the process of decomposing a system input and/or output into one or more fuzzy sets. Many types of curves can be used, but triangular or trapezoidal shaped membership functions are the most common because they are easier to represent in embedded controllers.

Fig. 1 shows a system of fuzzy sets for an input with trapezoidal and triangular membership functions.

The figure illustrates the process of fuzzification of the air temperature in order to control the operation of an air-conditioning system. There are five fuzzy sets for temperature: COLD, COOL, GOOD, WARM, and HOT.

Defuzzification: After fuzzy reasoning, we have a linguistic output variable that needs to be translated into a crisp value. The objective is to derive a single crisp numeric value that best represents the inferred fuzzy values of the linguistic output variable. Defuzzification is such inverse transformation which maps the output from the fuzzy domain back into the crisp domain.

Most commercial fuzzy products are rule-based systems that receive current information in the feedback loop from the device as it operates and control the operation of a mechanical or

other device (Simoes & Friedhofer, 1997; Simoes & Franceschetti, 1999). A fuzzy logic system has four blocks as shown in figure 2. Crisp input information from the device is converted into fuzzy values for each input fuzzy set with the fuzzification block. The universe of discourse of the input variables determines the required scaling for correct per-unit operation. The scaling is very important because the fuzzy system can be retrofitted with other devices or ranges of operation by just changing the scaling of the input and output. The decision-making-logic determines how the fuzzy logic operations are performed, and together with the knowledge base determine the outputs of each fuzzy IF-THEN rule. Those are combined and converted to crispy values with the defuzzification block. The output crisp value can be calculated by the center of gravity.

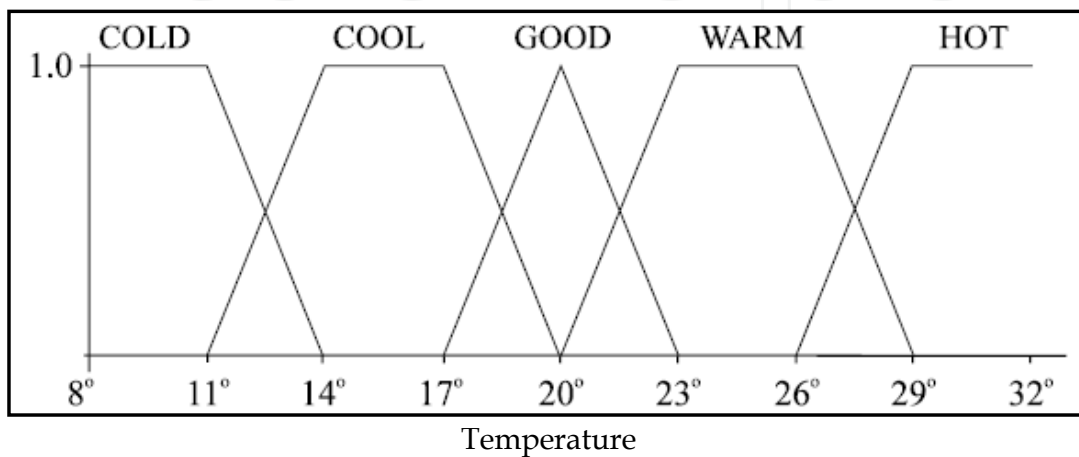

Fig. 1. Fuzzy sets defining temperature.

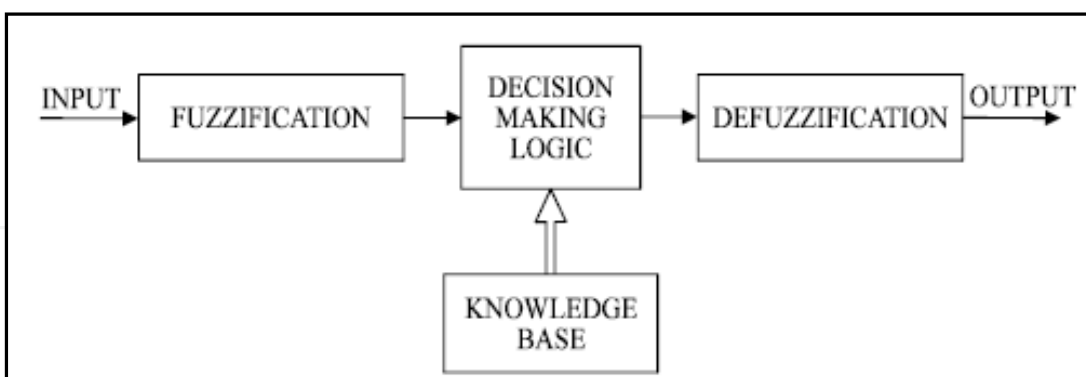

Fig. 2. Fuzzy Controller Block Diagram.

In order to process the input output reasoning, there are six steps involved in the creation of a rule based fuzzy system:

1. Identify the inputs and their ranges and name them.
2. Identify the outputs and their ranges and name them.
3. Create the degree of fuzzy membership function for each input and output.
4. Construct the rule base that the system will operate under.
5. Decide how the action will be executed by assigning strengths to the rules.
6. Combine the rules and defuzzify the output.

3. Adaptive Neuro-Fuzzy Inference System (ANFIS)

In spite of some non-linear control problems can be handled using neural control schemes, in situations where there is precise tracking of fast trajectories for non-linear systems with high nonlinearities and large uncertainties, neural control schemes are severely inadequate (Denai et al., 2004). Adaptive Neuro-Fuzzy Inference Systems are realized by an appropriate combination of neural and fuzzy systems and provide a valuable modeling approach of complex systems (Denai et al., 2004; Rezaeeian et al., 2008; Hanafy, 2010).

The proper selection of the number, the type and the parameter of the fuzzy membership functions and rules is crucial for achieving the desired performance and in most situations, it is difficult. Yet, it has been done in many applications through trial and error. This fact highlights the significance of tuning fuzzy system. Adaptive Neuro-Fuzzy Inference Systems are Fuzzy Sugeno models put in the framework of adaptive systems to facilitate learning and adaptation. Such framework makes FLC more systematic and less relying on expert knowledge. To present the ANFIS architecture, let us consider two-fuzzy rules based on a first order Sugeno model:

Rule 1: if (x is A_1) and (y is B_1) then

$$(f_1 = p_1x + q_1y + r_1)$$

Rule 2: if (x is A_2) and (y is B_2) then

$$(f_2 = p_2x + q_2y + r_2)$$

ANFIS architecture to implement these two rules is shown in figure 3. Note that a circle indicates a fixed node whereas a square indicates an adaptive node (the parameters are changed during training). In the following presentation O_L denotes the output of node i in layer L .

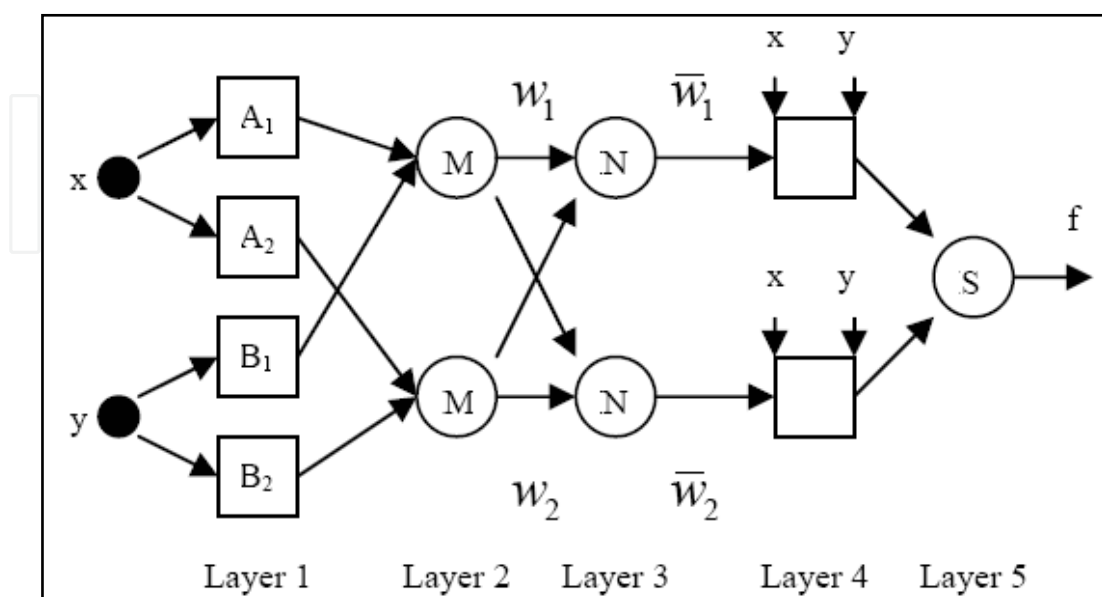

Fig. 3. Construct of ANFIS.

Layer 1: the fuzzy membership function (MF) represented by the node: All the nodes in this layer are adaptive nodes, i is the degree of the membership of the input to

$$O_{1,i} = \mu_{A_i}(x) \quad i=1,2$$

Where a_i , b_i , and c_i are the parameters for the MF

$$O_{1,i} = \mu_{B_{i-2}}(y) \quad i=3,4 \quad (1)$$

A_i and B_i can be any appropriate fuzzy sets in parameter form. For example, if bell MF is used then

$$\mu_{A_i}(x) = \frac{1}{1 + \left[\frac{(x - c_i)^2}{a_i} \right]^{b_i}} \quad i=1,2 \quad (2)$$

Layer 2: The nodes in this layer are fixed (not adaptive). These are labeled M to indicate that they play the role of a simple multiplier. The outputs of these nodes are given by:

$$O_{2,i} = w_i = \mu_{A_i}(x)\mu_{B_i}(y) \quad i=1,2 \quad (3)$$

The output of each node in this layer represents the firing strength of the rule.

Layer 3: Nodes in this layer are also fixed nodes. These are labeled N to indicate that these perform a normalization of the firing strength from previous layer. The output of each node in this layer is given by:

$$O_{3,i} = \bar{w}_i = \frac{w_i}{w_1 + w_2} \quad i=1,2 \quad (4)$$

Layer 4: All the nodes in this layer are adaptive nodes. The output of each node is simply the product of the normalized firing strength and a first order polynomial:

$$O_{4,i} = \bar{w}_i f_i = \bar{w}_i (p_i x + q_i y + r_i) \quad i=1,2 \quad (5)$$

Where: p_i , q_i , and r_i are design parameters (consequent parameter since they deal with the then-part of the fuzzy rule).

Layer 5: This layer has only one node labeled S to indicate that it performs the function of a simple summer. The output of this single node is given by:

$$O_{5,i} = f = \sum_{i=1}^2 \bar{w}_i f_i = \frac{\sum_{i=1}^2 w_i f_i}{\sum_{i=1}^2 w_i} \quad (6)$$

In this ANFIS architecture, there are two adaptive layers (1, 4). Layer 1 has three modifiable parameters (a_i , b_i , and c_i) pertaining to the input MFs. These parameters are called premise

parameters. Layer 4 has also three modifiable parameters polynomial. These parameters are called consequent parameters (p_i, q_i, r_i) pertaining to the first order.

In order to improve the training efficiency, a hybrid learning algorithm is applied to justify the parameters of input and output membership functions. The antecedent parameters (the parameters related to input membership functions) and the consequent parameters (the parameters related to output membership functions) are two parameter sets in the architecture which should be tuned. When we suppose that premise parameters are fixed, then the output of ANFIS will be a linear combination of the consequent parameters. So, the output can be written as:

$$f = \bar{w}_1 f_1 + \bar{w}_2 f_2 \quad (7)$$

With substituting Equation (5) in Equation (7), the output can be rearranged as:

$$f = (\bar{w}_1 x) p_1 + (\bar{w}_1 y) q_1 + (\bar{w}_1) r_1 + (\bar{w}_2 x) p_2 + (\bar{w}_2 y) q_2 + (\bar{w}_2) r_2 \quad (8)$$

So, the consequent parameters can be tuned by the least square method. On the other hand, if consequent parameters are fixed, the premise parameters can be adjusted by the gradient descent method. ANFIS utilizes hybrid learning algorithm in which the least square method is used to identify the consequent parameters in forward pass and the gradient descent method is applied to determine the premise parameters in backward pass.

Not yet, many recent developments in evolutionary algorithms have provided several strategies for NFIS design. Three main strategies, including Pittsburg-type, Michigan-type, and iterative rule learning genetic fuzzy systems, focus on generating and learning fuzzy rules in genetic fuzzy systems (Lin et al.;2008)

4. Fuzzy controllers using subtractive clustering

A common way of developing Fuzzy Controller is by determining the rule base and some appropriate fuzzy sets over the controller's input and output ranges. An efficient approach, namely, Fuzzy Subtractive Clustering is used here, which minimizes the number of rules of Fuzzy Logic Controllers. This technique provides a mechanism to obtain the reduced rule set covering the whole input/ output space as well as membership functions for each input variable. In (Chopra et al., 2006), Fuzzy subtractive clustering approach is shown to reduce 49 rules to 8 rules where simulation of a wide range of linear and nonlinear processes is carried out and results are compared with existing Fuzzy Logic Controller with 49 rules.

4.1 Introduction to cluster analysis

By definition, cluster analysis is grouping of objects into homogenous groups based on same object features. Clustering of numerical data forms the basis of many classification and system-modeling algorithms. The purpose of clustering is to identify natural grouping of data from a large data set to produce a concise representation of a system's behavior. Clustering algorithms typically requires the user to pre-specify the number of cluster centers and their initial locations. The locations of the cluster centers are then adapted in a way such that these can better represent a set of data points covering the range of data behavior. The Fuzzy Clustering Means (FCM) algorithm (Bezdek, 1990) method is well-known example of

such clustering algorithm. For these algorithms, the quality of the solution depends strongly on the choice of initial values i.e., the number of cluster centers and their initial locations (Nikhil et al., 1997) .

In (Yager & Filev, 1994), the authors proposed a simple and effective algorithm, called the mountain method, for estimating the number and initial location of cluster centers. Their method is based on girding the data space and computing a potential value for each grid point based on its distances to the actual data points; a grid point with the highest potential value is chosen as the first cluster center and the potential of all grid points are reduced according to their distance from the cluster center. The next cluster center is then placed at the grid point with the highest remaining potential value. This procedure of acquiring new cluster center and reducing the potential of surrounding grid points is repeated until the potential of all grid points falls below a threshold. Although this method is simple and effective, the computation grows exponentially with the dimension of the problem. The author in (Chiu, 1994) proposed an extension of this mountain method, called subtractive clustering, in which each data point, rather than the grid point, is considered as a potential cluster center. Using this method, the number of effective “grid points” to be evaluated is simply equal to the number of data points, independent of the dimension of the problem. Another advantage of this method is that it eliminates the need to specify a grid resolution, in which tradeoffs between accuracy and computational complexity must be considered.

4.2 The subtractive clustering method

To extract rules from data, we first separate the training data into groups according to their respective class. Consider a group of n data points $\{X_1, X_2, \dots, X_n\}$ for a specific class, where X_i is a vector in the input feature space. Assume that the feature space is normalized so that all data are bounded by a unit hypercube. We consider each data point as a potential cluster center for the group and define a measure of the potential of data point X_i to serve as a cluster center as

$$P_i = \sum_{j=1}^n e^{-\alpha \|x_i - x_j\|^2} \quad (9)$$

Where

$$\alpha = \frac{4}{r_a^2} \quad (10)$$

$\|\cdot\|$ denotes the Euclidean distance, and r_a is a positive constant. Thus, the measure of the potential of a data point is a function of its distances to all other data points in its group. A data point with many neighboring data points will have a high potential value. The constant r_a is effectively a normalized radius defining a neighborhood; data points outside this radius have a little influence on the potential. Note that because the data space is normalized, $r_a = 1.0$ is equal to the length of one side of the data space. After the potential of every data point in the group has been computed, we select the data point with the highest potential as the first cluster center. Let x_1^* be the location of the first cluster center and P_1^* be its potential value. We then revise the potential of each data point x_i in the group by the formula

$$P_i \Leftarrow P_i - P_1^* e^{-\beta \|x_i - x_1^*\|^2} \quad (11)$$

Where

$$\beta = \frac{4}{r_b^2} \quad (12)$$

and r_b is a positive constant. Thus, we subtract an amount of potential from each data point as a function of its distance from the first cluster center. The data points near the first cluster center will have greatly reduced potential, and therefore will unlikely be selected as the next cluster center for the group. The constant r_b is effectively the radius defining the neighborhood which will have measurable reductions in potential. To avoid obtaining closely spaced cluster centers, we typically choose $r_b = 1.25 r_a$ (Chopra et al. , 2006).

When the potential of all data points in the group has been reduced according to Equation 11, we select the data point with the highest remaining potential as the second cluster center. We then further reduce the potential of each data point according to their distance potential as the second cluster center. In general, after the K ' th cluster center has been obtained, we revise the potential of each data point by the formula

$$P_i \Leftarrow P_i - P_k^* e^{-\beta \|x_i - x_k^*\|^2} \quad (13)$$

Where x_k^* is the location of the K ' th cluster center and p_k^* is its potential value. The process of acquiring new cluster center and reducing potential repeats until the remaining potential of all data points in the group is below some fractions of the potential of the first cluster center P_1^* . Typically, one can use $p_k^* < 0.15P_1^*$ as the stopping criterion (Chiu, 1997).

Each cluster center found in the training data of a given class identifies a region in the feature space that is well populated by members of that class. Thus, we can translate each cluster center into a fuzzy rule for identifying the class.

Suppose cluster center x_i^* was found in the group of data for class $c1$; this cluster center provides the rule:

Rule i : If { x is near x_i^* } then class is $c1$.

The degree of fulfillment of { x is near x_i^* } is defined as

$$\mu_i = e^{-\alpha \|x - x_i^*\|^2} \quad (14)$$

Where α is a constant defined by Equation 10 .

By applying subtractive clustering to each class of data individually, we thus obtain a set of rules for identifying each class. The individual sets of rules can then be combined to form the rule base of the classifier. For example, suppose we found 2 clusters centers in class $c1$ data, and 5 cluster centers in class $c2$ data, then the rule base will contain 2 rules that identify class $c1$ members and 5 rules that identify class $c2$ members. When performing classification, the output class of the classifier is simply determined by the rule with the highest degree of fulfillment.

5. ANFIS control of an intelligent robotic gripper

The effectiveness of the Fuzzy Inference control will be illustrated here by applying the method to control the operation of a robotic gripper. The robotic gripper will be first described, its operation principle will be illustrated, then the application of the Adaptive Network Fuzzy Inference System control to the gripper system will be presented.

Generally, the main goal of robotic gripper during object grasping and object lifting process is applying sufficient force to avoid the risk of a difficult task or sometimes a task that could not be achieved. The problem can be posed as an optimization problem (Ottaviano et al.,2000; Bicchi & Kumar,2000). Sensory systems are very important in this field. Two types of sensing are most actively being investigated to increase robot awareness: contact and non-contact sensing. The main type of non-contact sensing is vision sensing where video camera is processed to give the robot the object information. However, it is costly and gives no data concerning forces (Lorenz et al.,1990). Tactile sensing, on the other hand, has the capability to do proximity sensing as well as force sensing, it is less expensive, faster and needs less complex equipment (Choi et al.,2005). The basic principle of the Slip-Sensitive Reaction used in this work is that, the gripper should be able to automatically react to object slipping during grasp with the application of greater force. A lot of researches have been focusing on fingertip sensors development to detect slippage and applied force (Dario & De Rossi ,1985; Friedrich et al., 2000), which requires complicated drive circuit and suffers from difficult data processing and calibration. Polyvinylidene fluoride (PVDF) piezoelectric sensors are presented in (Barsky et al.,1989) to detect contact normal force as well as slip. Also, an array 8x8 matrix photo resistor is introduced in (Ren et al.,2000) to detect slippage. A slip sensor based on the operation of optical encoder used to monitor the slip rate resulting from insufficient force is presented in (Salami et al, 2000). However, it is expensive and have some constrains on the object to be lifted. Several researchers handle finger adaptation using more than one link in one finger to verify stable grasping (Seguna & Saliba, 2001; Dubey & Crowder, 2004). This results in complicated mechanical system leading to difficulty in control and slow response. Fuzzy controllers have been very successful in solving the grasping problem, as they do not need mathematical model of the system (Dominguez-Lopez & Vila-Rosado, 2006). In this study, a new design and implementation of robotic gripper with electric actuation using brushless dc servo motor is presented. Standard sensors adaptation in this work leads to maintaining the simplicity of the mechanical design and gripper operation keeping a reasonable cost. The gripper control was achieved through two control schemes. System modeling had been introduced using ANFIS approach. A new grasping scenario is used in which we collect information about the masses of the grasped objects before starting the grasping process without any additional sensors. This is achieved through knowledge of object pushing force that allows applying an appropriate force and minimizing object displacement slip through implementation of the proposed fuzzy control.

5.1 Gripper design and configuration

A proper gripper design can simplify the overall robot system assembly, increase the overall system reliability, and decrease the cost of implementing the system. Hence, the design of the gripping system is very important for the successful operation.

5.1.1 Gripper design guidelines

It may not be possible to apply all the guidelines to any one design. Sometimes, one guideline may suggest one design direction while another may suggest the opposite. Each particular situation must be examined and a decision must be made to favor the more relevant guidelines (Monkman et al,2007). The design guidelines may be as follows: -

1. Minimize the gripper weight: This allows the robot to accelerate more quickly.
2. Grasp objects securely: This allows the robot to run at higher speeds thereby reducing the cycle time.
3. Grip multiple objects with a single gripper: This helps to avoid tool changes.
4. Fully encompass the object with the gripper: This is to help hold the part securely.
5. Do not deform the object during grasping: Some objects are easily deformed and care should be taken when grasping these objects.
6. Minimize finger length: Obviously, the longer the fingers of the gripper the more they are going to deflect when grasping an object.
7. Design for proper gripper-object interaction: If, however, a flat surface is being used, then a high friction interface is desired since the part would not be aligned anyway and the higher friction increases the security of the grasp.

5.1.2 Two fingers gripper selection

The objects may vary in size and shape. Thus the gripper should be able to handle objects of different shapes and sizes in a particular range. Gripper should be compact so that it does not interfere with other equipment. The use of conical fingers “three fingers or more” will help holding the parts securely. But if we have an object larger than these conical fingers, the object could not be gripped properly. Parallel moving fingers are a good solution in this case. This parallel movement also helps in gripping objects internally. Since the force is acting at a point or line in conical form of gripping it may lead to wear and tear of both the object and the finger. But in the parallel finger arrangement, the force will be distributed over an area. The two-fingers grasp may be considered the simplest efficient grasping configuration.

5.1.3 Gripper configuration

The developed gripper device was configured with a two parallel finger design for its wide applications in spite of its precise control need. One finger is fixed and the other is movable to ease the control and minimize the cost as shown in figure 4. The fingers are flat and rectangular in shape. The housing of the gripper and fingers were made of aluminum sheet for light weight consideration with proper thickness to ease the machining and holes puncture through edges. This gives simple assembly and ease in maintenance. The movable finger is driven on a lead screw and guided by a linear bearing system with the advantage of self-locking capability, low cost and ease of manufacture.

To control the gripping of the object, we need to measure both the force applied to the object and the object slip. A standard commercial force sensor resistor FSR (Flexiforce A201 working in the range of 0-1 lb (4.4N)) is used to measure the applied force. Also Phidget vibrator sensor is adapted as slip sensor to give information about object slip rate in m/sec. These two sensors are tactile sensors. The actuator used to drive the movable finger is a

permanent magnet brushless dc motor (BLDC). It has the advantage of high power density, ease of control, high efficiency, low maintenance and low rotor inertia. BLDC servo motor used is an internal rotor motor "BLD3564B" from Minimotor inc. with its drive circuit "BLD5604-SH2P" .

The design of the gripper fingers must take some restrictions into consideration. Long fingers require high developed torque and short fingers impose restrictions on object dimensions. Hence fingers are selected to be 15 cm long. Also, a contact rubber material area between the fingers and the object of 25 mm by 25 mm is used to decrease the pressure on the object, increase the friction, and avoid deformation from centric concentrated force. With this gripper configuration, we succeeded to verify all previous design guidelines except guideline no.4 as our proposed gripper doesn't fully encompass the object in order to be able to grasp a greater variety of objects, although this imposes more difficulty in the control during gripping.

6. Robotic gripper modeling

To build the proposed controller, we need to get information about the system characteristics for use in simulation and experimental work. Hence, input/output variables of the system are measured and processed. The input variable to the system is the speed control command to the servo motor drive expressed as reference voltage V_{ref} . The applied force on the object is the output variable F_{app} . The deformable compliant rubber material covering the contact area of the fingers, as shown in figure 4, is important to allow a wide range of force control for solid objects as well as decreasing the pressure on the object and increasing the friction. Hence, we need to model the variation of the applied force F_{app} by the gripper finger with time at different reference voltage control commands V_{ref} .

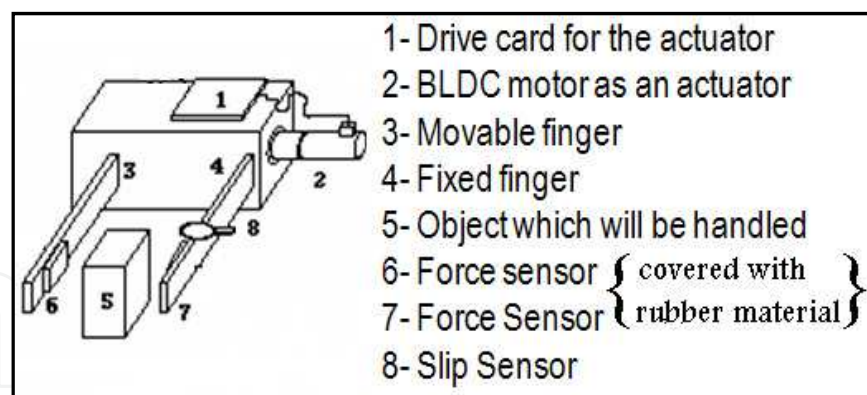

Fig. 4. Gripper configuration.

Experimentally, and due to the mechanism constraint according to the gripper design, the applied force by the gripper fingers F_{app} on the objects could not decrease if the reference voltage control command V_{ref} is decreased. To verify the proposed controller, a model was built using MATLAB software package considering the mechanical constraints, which in turn lead to the accumulation of the applied force when V_{ref} is changed. For practical control, a maximum limit was set to the applied force $F_{max.app}$, figures 5 & 6. From this simulation model, the set of training data, checking data and testing data to be used for ANFIS model training were prepared.

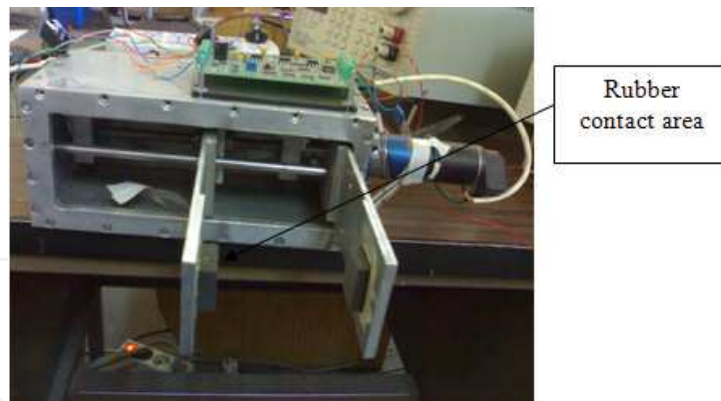

Fig. 5. Gripper prototype.

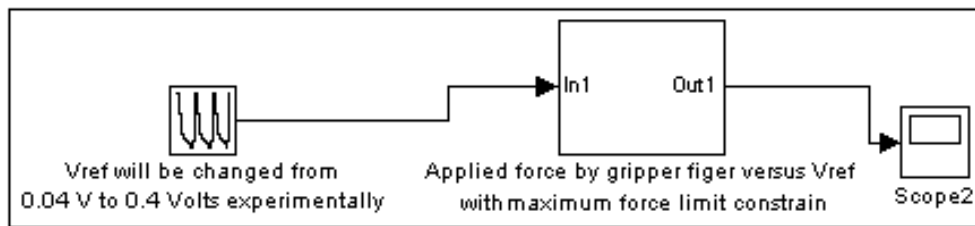

Fig. 6. Gripper simulation using MATLAB considering the maximum applied force.

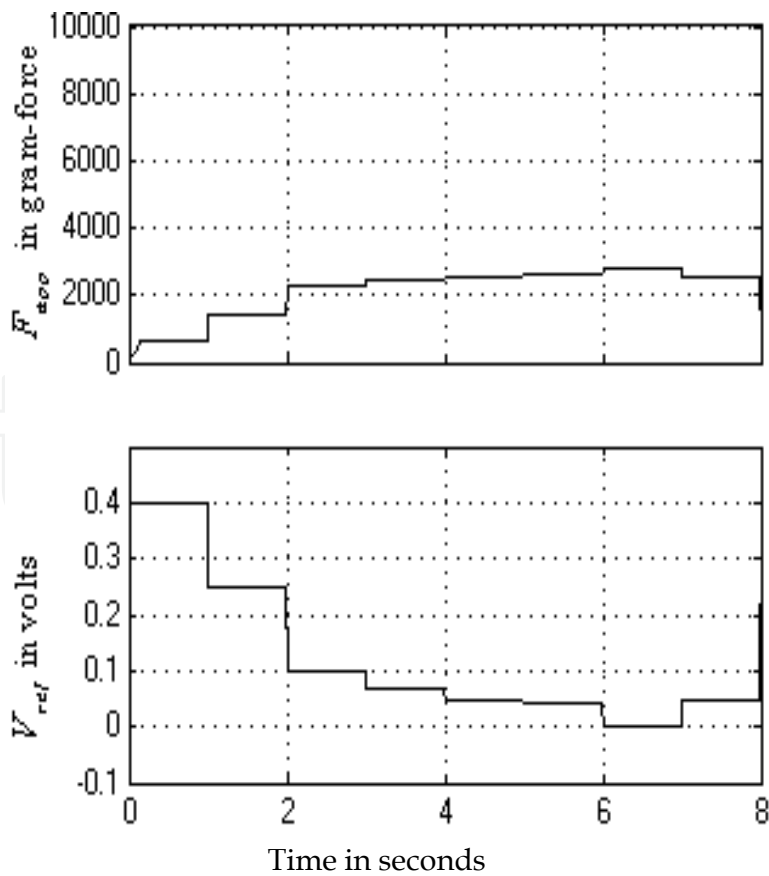

Fig. 7. Gripper simulation results considering the maximum applied force.

6.1 Force sensor calibration and modeling

The experiment was set up as shown in figure 8. Different masses were used for calibration considering the maximum force that can be applied to the sensor according to its data sheet. The whole sensitive area should be subjected to the applied force. Using the nonlinear least squares fitter we can fit a function to our recorded measurements as shown in figure.9. From the force sensor data sheet, the sensitive area is 0.7136 cm², whereas the contact area between the object and any finger is 6.25 cm² “the rubber material has a contact surface

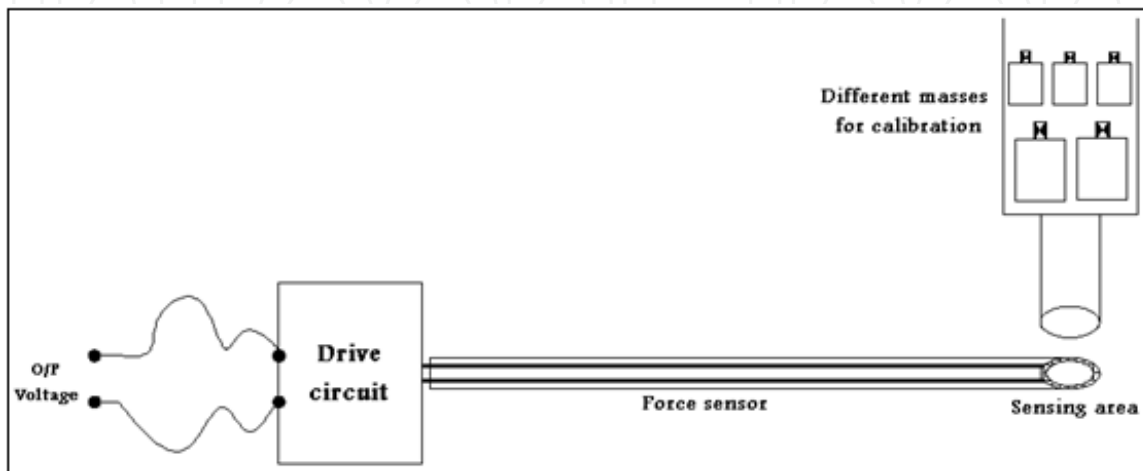

Fig. 8. Experimental test for force sensor calibration

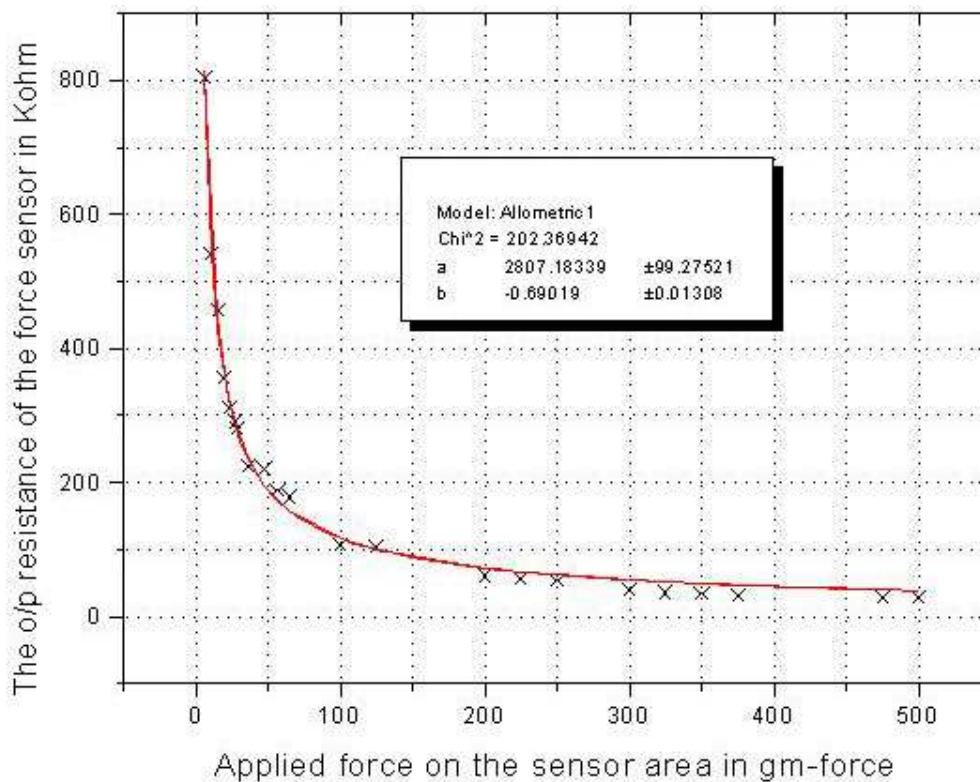

Fig. 9. Allometric function curve fitting.

dimensions 2.5cm x 2.5cm". Hence, there is a conversion factor, which converts the applied force by the finger on the object to the applied force on the sensor area as follows: -

$$F_{app} = 8.76 F_{sens} \quad (15)$$

Using the proposed drive circuit shown in figure 10, we can deduce a formula that describes the relation between the analog output voltage from the force sensor and the applied force by the gripper finger as follows: -

$$V_{out} = 5 * R_f / a * ((F_{app} / 8.76) ^ b) \quad (16)$$

Where: $a = 2807.18$, $b = -0.69019$ and $R_f = 65 \text{ Kohm}$

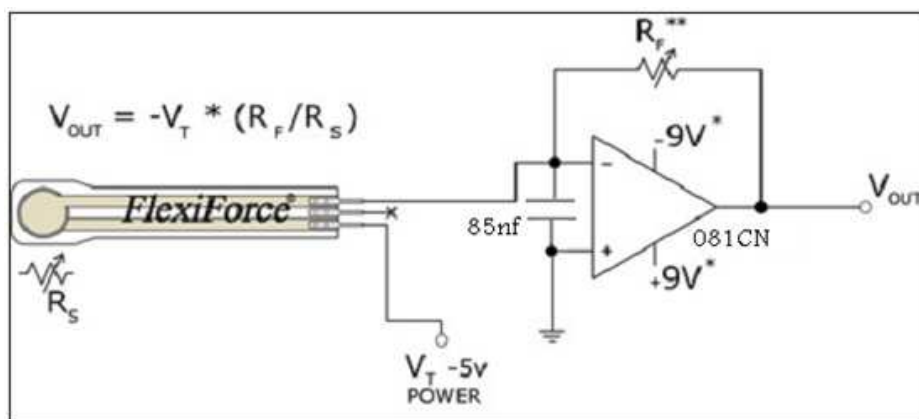

Fig. 10. Proposed drive circuit.

6.2 ANFIS modeling for input/output gripper variables

Adaptive Neuro-Fuzzy Inference Systems, ANFIS, are realized by an appropriate combination of neural and fuzzy systems and provide a valuable modeling approach of complex systems (Rezaeeian et al.,2008). The ANFIS structure is applied on our proposed robotic gripper, figure 11, based on the measured data which are simulated using MATLAB software package as shown in figure 6 and figure 7. We use 161 training data, 46 checking data, and 46 testing data. The training data are shown in figure 12. The surface rules viewer for the developed FIS model using ANFIS is shown in figure 13. Simulation results of the gripper using ANFIS modeling is shown in figure 14.

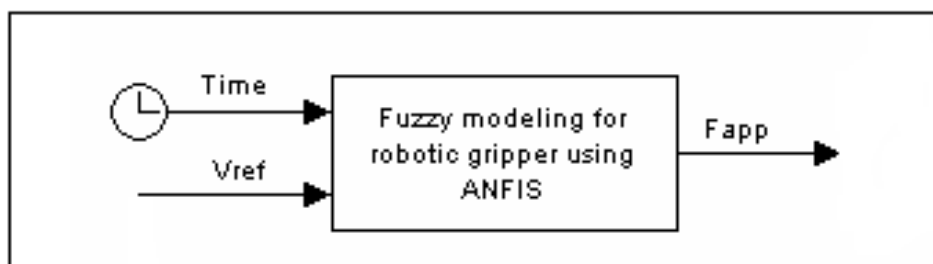

Fig. 11. Robotic gripper using ANFIS

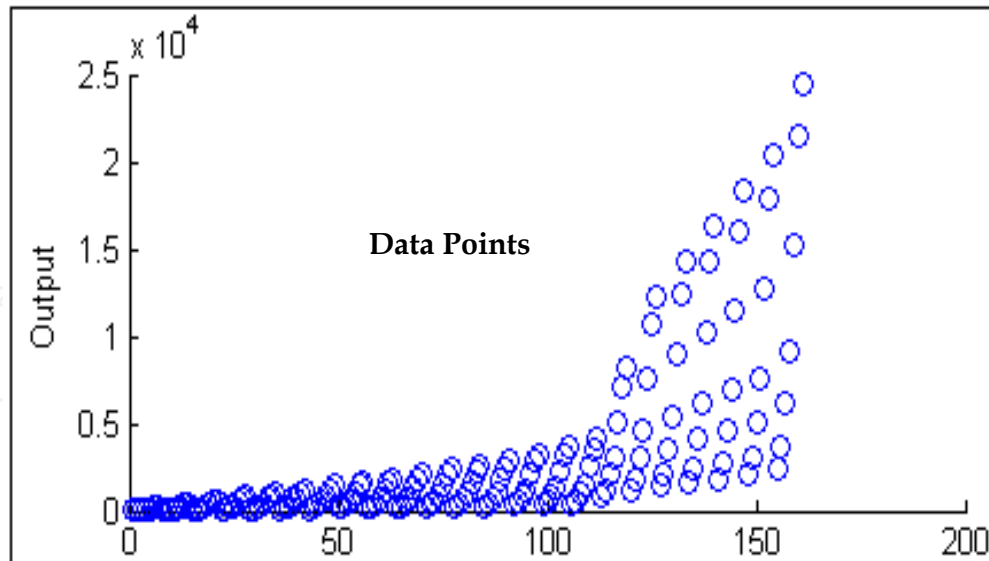

Fig. 12. Training data.

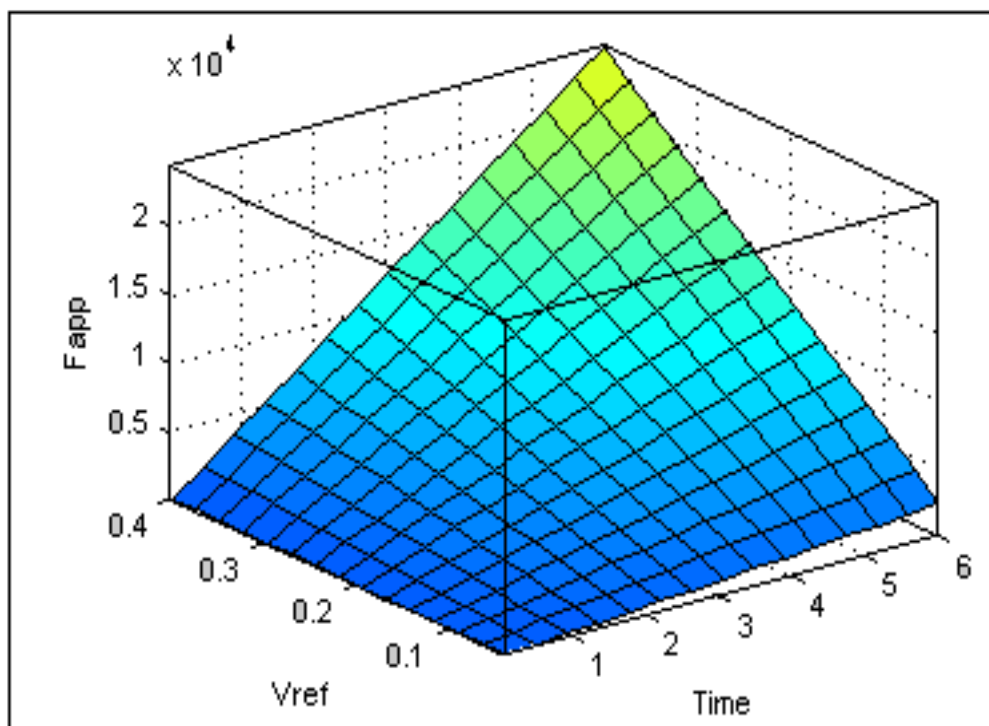

Fig. 13. Surface rules viewer for the developed FIS model using ANFIS.

6.3 Object modeling

It is known that the occurrence of slip for a solid object during grasping and lifting mainly depends on its mass, its coefficient of friction and also on the applied forces. If the applied force is not enough, acceleration is generated which leads to increased rate of slip and object dropping after certain time. This time depends on the applied force, the object mass and the coefficient of friction. Equation 3 determines the object acceleration as a function of

the normal applied forces by the gripper fingers and the coefficient of friction as shown in figure.14. Object simulation result is shown in figure.15, which indicates that the slippage is stopped after a period of time depending on the rate of force increase.

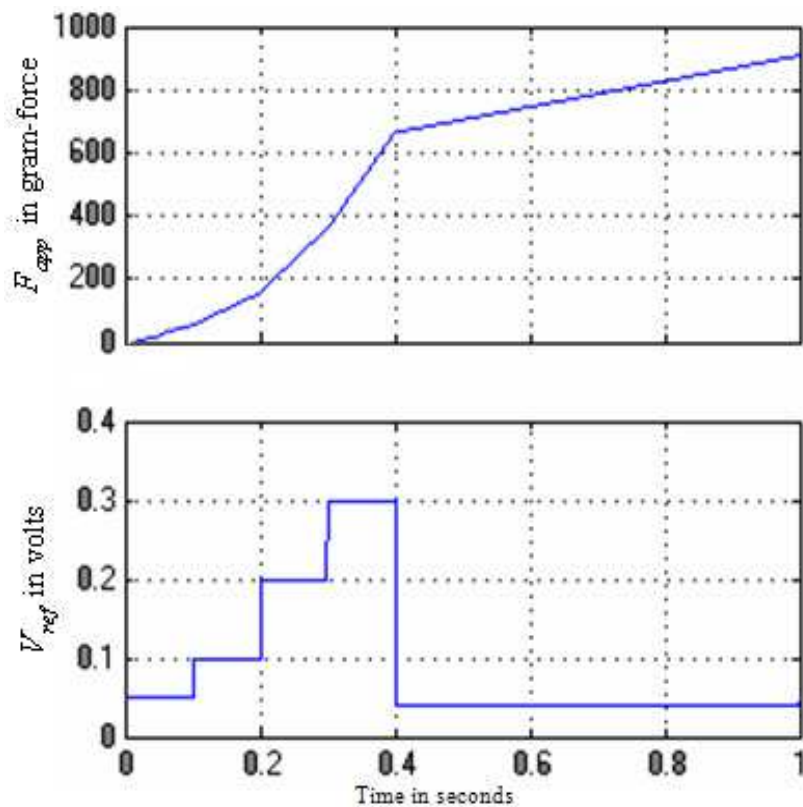

Fig. 14. Gripper simulation results using ANFIS modeling.

$$m \times a = m \times g - 2 \times \mu \times F_{app} \quad (17)$$

Where m is the object mass in kg, μ is the coefficient of friction, g is the earth gravity equal to 9.8 m/s^2 , and finally a is the object acceleration in m/s^2

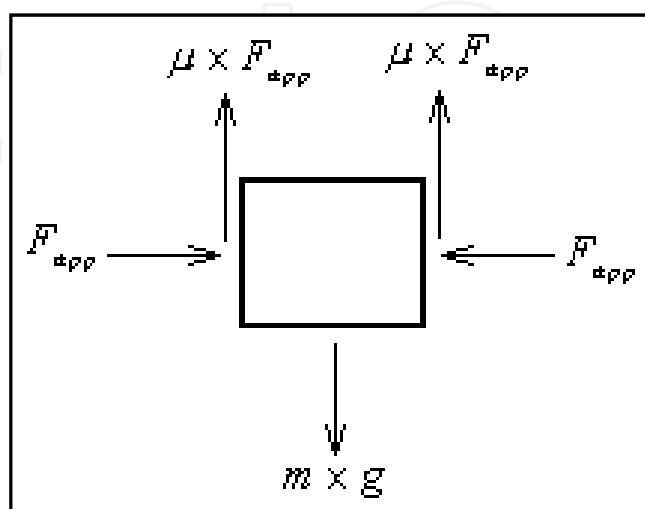

Fig. 15. Applied forces on the object.

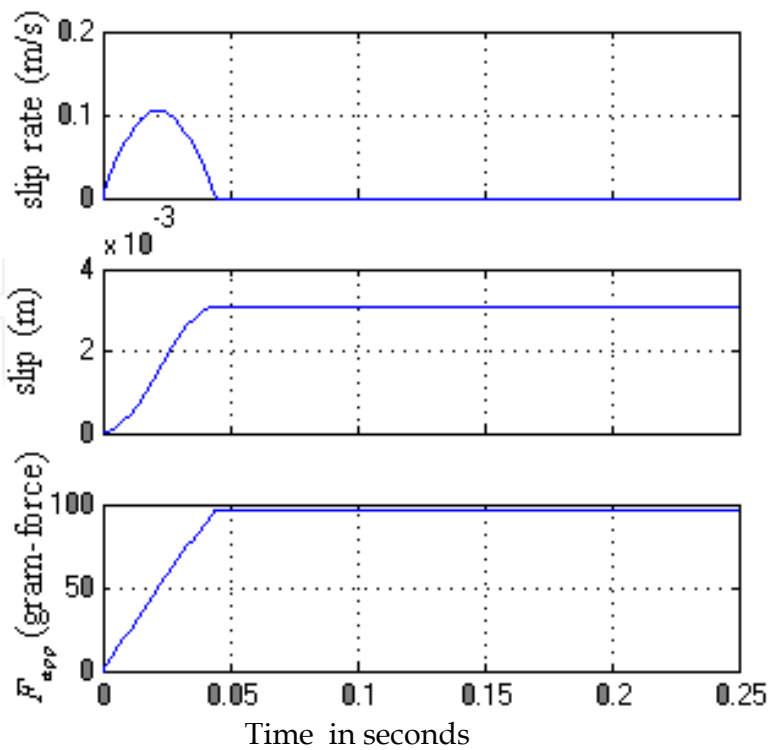

Fig. 16. Object simulation results when Mass=100 gm and $\mu=0.5$.

6.4 Slip sensor calibration and modeling

To measure the slip amount for an object subjected to grasping, lifting and handling, a piezoelectric vibration sensor was used. A piezoelectric transducer is displaced from the

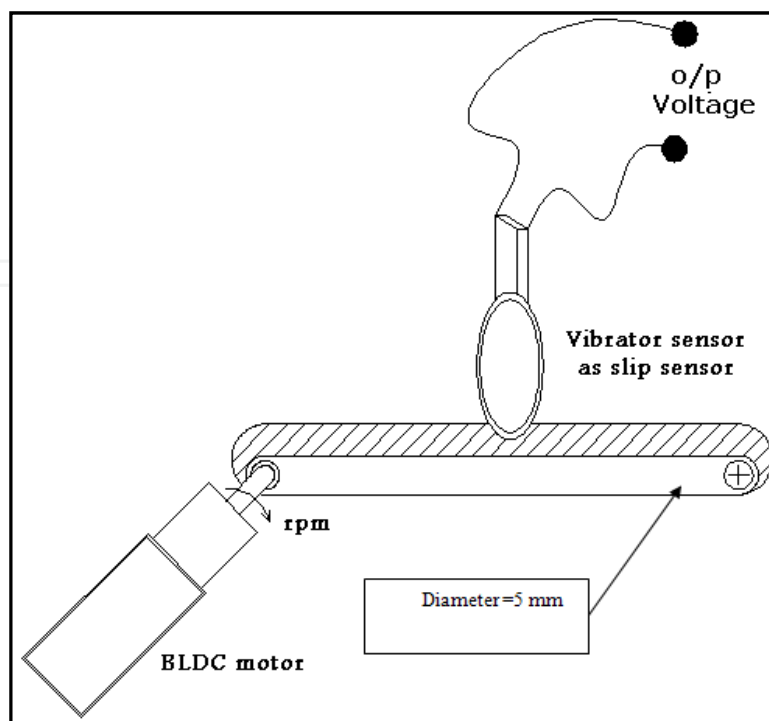

Fig. 17. Experimental tests for slip sensor calibration.

mechanical neutral axis, bending creates strain within the piezoelectric element and generates voltage signal. Experimentally, if the edge of this sensor is subjected to different speeds, it can generate different values of analog voltage that depend on those speed values. The experiment was set up as shown in figure 17. The motor was run at different speeds and the output of the sensor was recorded. The speed to which the sensor is subjected equals to $(\pi * 5 * \text{rpm}/60)$ mm/sec. Linear curve fitting had been applied to get the optimum modeling for the assigned slip sensor as shown in figure 18.

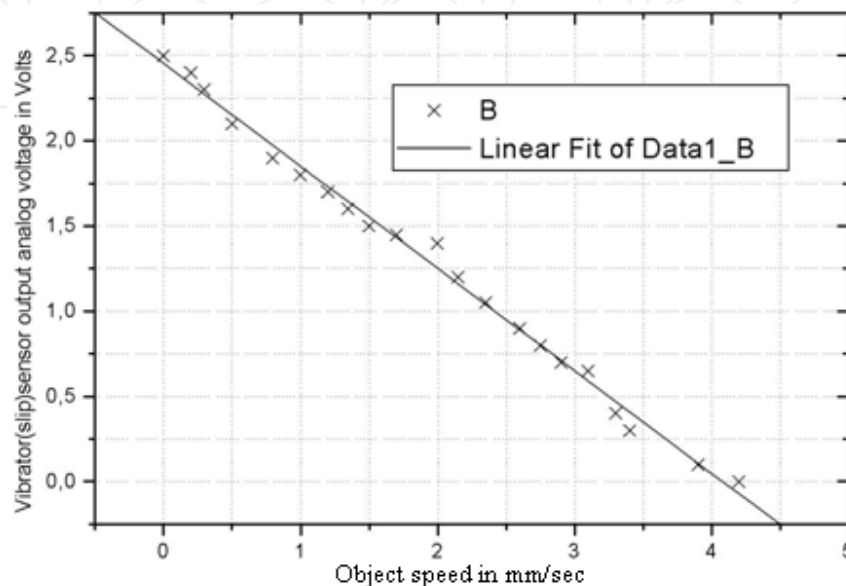

Fig. 18. Linear fit for slip sensor based on measured values.

The fitting parameters are recorded as follows:-

$$Y = A + B * X \quad (18)$$

Where: $A = 2,45319$, and $B = -0,60114$

X is an independent variable that represents the object slip rate "object speed" in mm/sec. Y is a dependent variable that represents the slip sensor analog output voltage in volts.

7. Gripper system controller

Our proposed controller was developed by emulating the action of the human to handle any, object during lifting it. First, he touches the object to examine its temperature and stiffness. Then, he tries to lift it by applying small force to move it or lift it in order to acquire some information about its weight and stiffness. Then he estimates the force needed to lift this object and takes the decision if he can lift it or not. Based on these observations, two control schemes were developed with different feedback variables.

7.1 First scheme controller

During object grasping and lifting process, it is not guaranteed that the two fingers will be in contact with the object at the beginning. Hence, a pushing force will be applied by one finger (the movable finger) until complete contact. Normally, this pushing force is less than

the force needed to lift the object, but is a function of the object mass and its coefficient of friction. Figure 19 shows the block diagram of the first proposed controller scheme. Two integrated fuzzy controllers were built in this scheme as follows:

1. The first fuzzy controller is a reference voltage controller with two input variables, the slip-rate and its derivative.
2. The second fuzzy controller is a gain controller for the output of the first controller with one input variable, the pushing force.

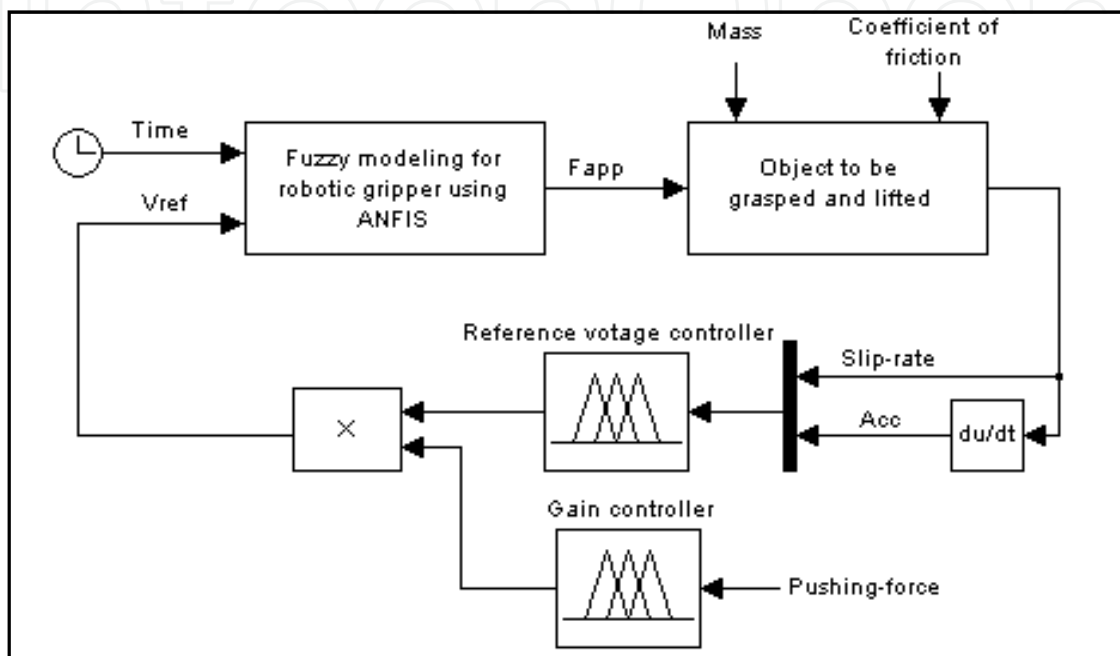

Fig. 19. Block diagram of the first scheme controller

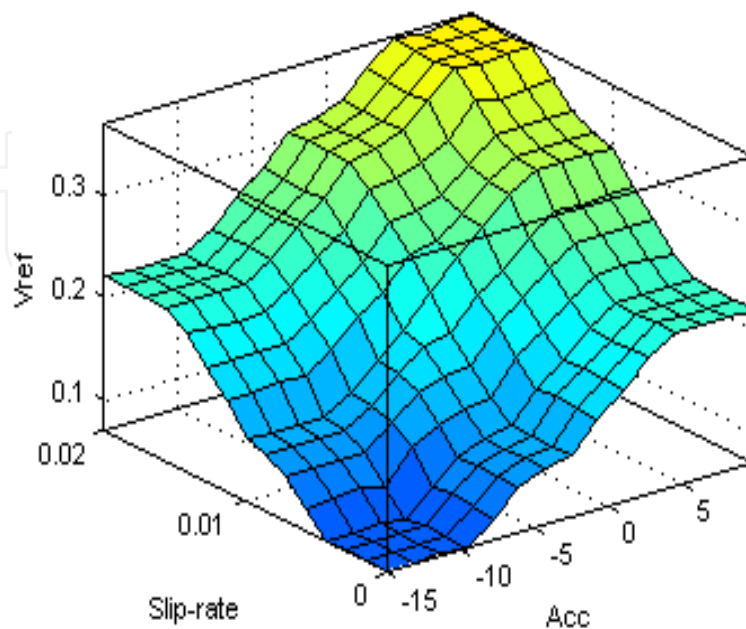

Fig. 20. Surface viewer of the reference voltage controller.

The function of the second controller is to decrease or increase the reference voltage command. The output of this controller is based on the pushing force applied on the object before grasping and lifting process. Figures 20 and 21 show the surface viewers for the two controllers in this scheme. Simulation results show the response of this scheme as shown in Figure 22.

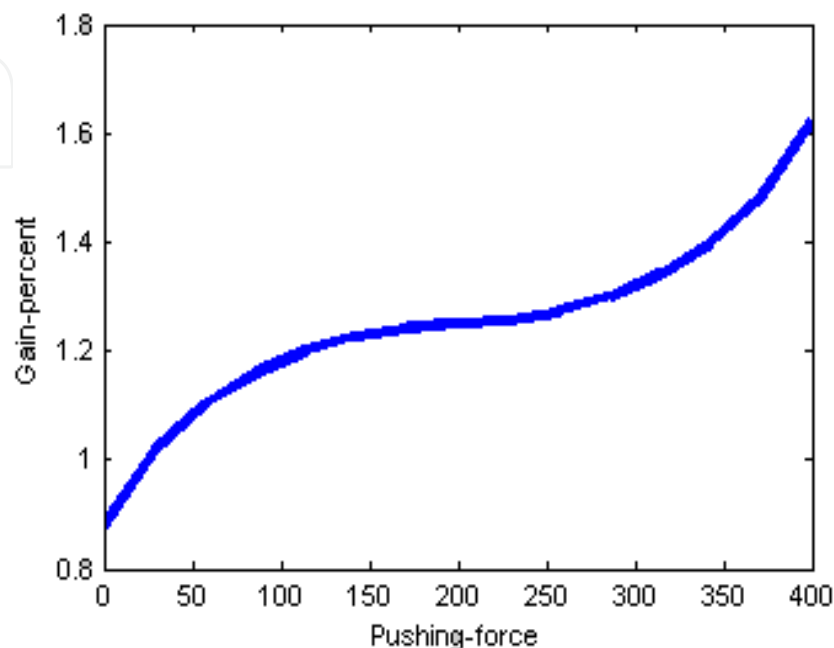

Fig. 21. Surface viewer of the gain controller.

7.2 Second scheme controller

Three integrated fuzzy controllers were built in this scheme as shown in figure 23:-

1. Guess starter reference voltage controller
2. Increased percent controller for starter reference voltage command.
3. Enhancement controller for the starter reference voltage command.

The first controller function is to guess the acceleration of the object resulting from small applied force and to give the suitable value of reference voltage command, the second controller function is to sense the pushing force to the object before the grasping process and its output is multiplied by the first controller output, the function of the third controller is to enhance the response of the two previous controllers based on the object acceleration and the applied force feed-back.

The controllers receive the object acceleration, object acceleration rate, pushing force and the applied force as feedback variables and adjust the finger motion. The response of this scheme is shown in figure 24 which indicates a faster response and lower slippage than the first scheme controller. Also figures 25 and 26 show the effect of pushing force variation on the system response. In the case shown in figure 26, F_{push} is higher than in the case shown in figure 25. So the higher value of F_{push} used as feed-back to the control system leads to lower slip amount.

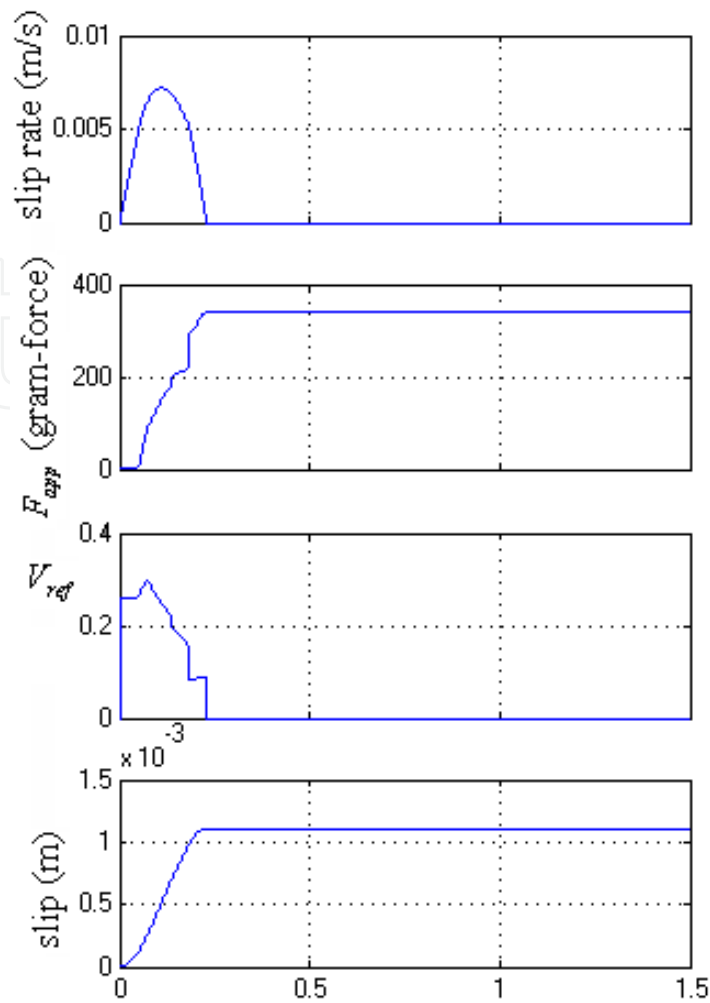

Fig. 22. System response for the first scheme controller: Mass=300 gm and F_{push} =150 g

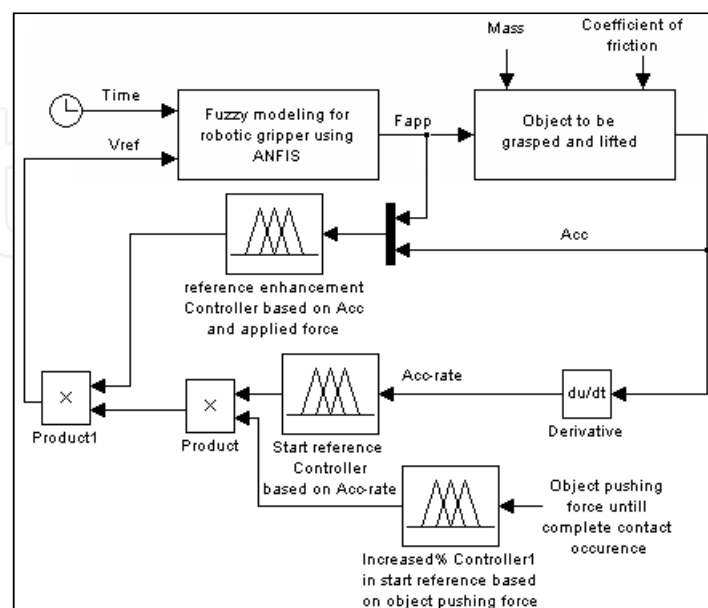

Fig. 23. Block diagram of the second scheme controller.

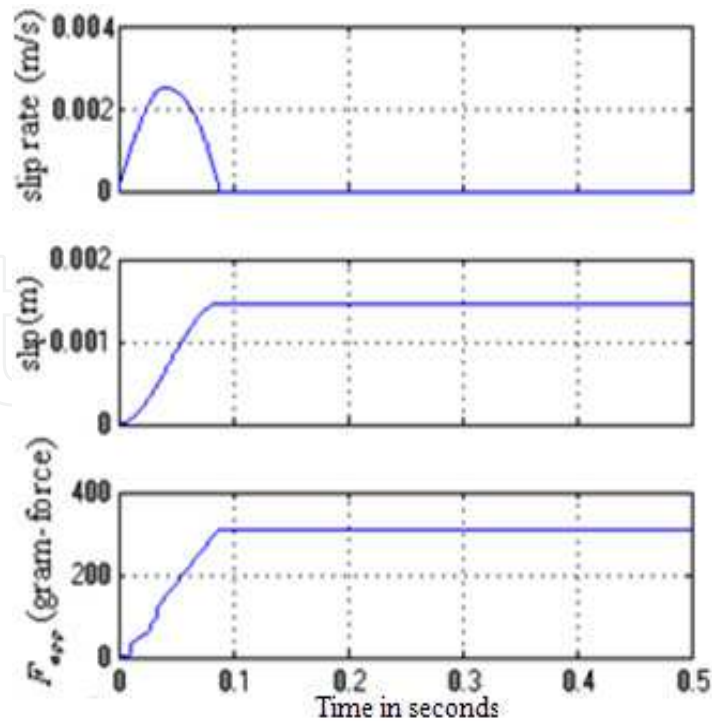
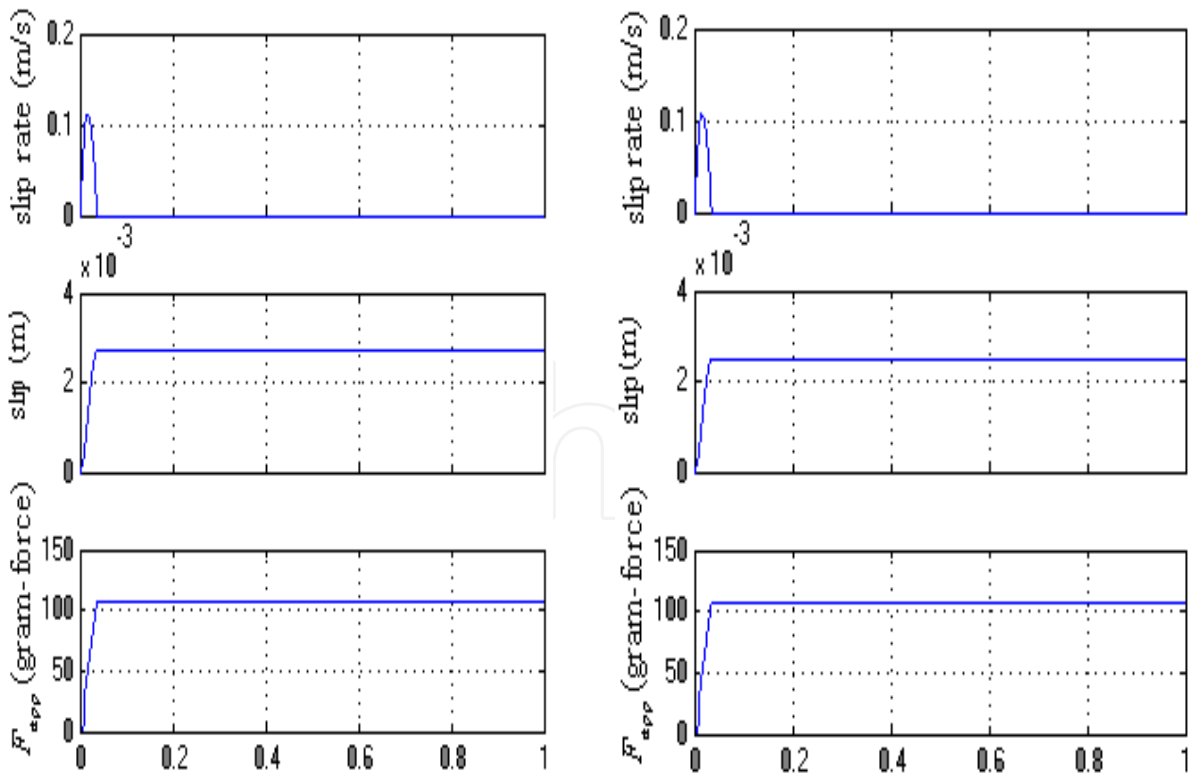

Fig. 24. System response for the second scheme controller Mass = 300 gm and F_{push} =150 g



(a) Mass=100 gm, μ =0.5, and F_{push} =20 gm-force

(b) Mass=100 gm, μ =0.5, and F_{push} =40 gm-force

Fig. 25. Slippage parameters and applied force.

8. Experimental results

Experimental work was established to verify the gripper system performance. Every part of the system was verified from the design concept, the manufacturing and control aspects. The mechanical system performance was tested and suitable refinements were performed. Sensors were calibrated and their necessary drive circuits were built. The actuator characteristics were studied in order to be taken into consideration during grasping process. Figure 26 shows the flowchart that describes the experimental scenario and proposed algorithm. Figures 27 and 28 show the system response during grasping and lifting for 1000gm object mass. Figures 27(a) and 28(a) show good performance although the start reference controller based on pushing

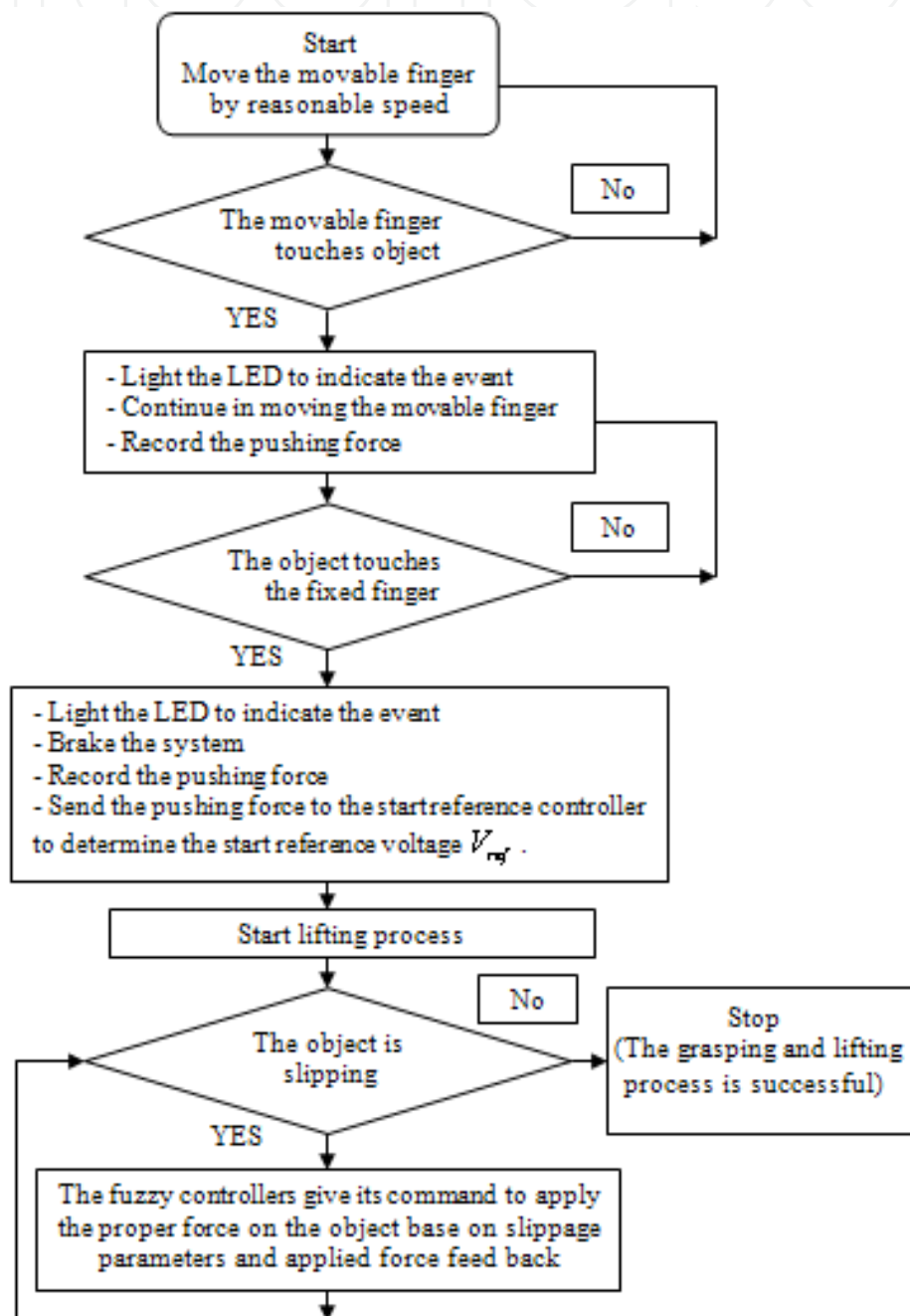
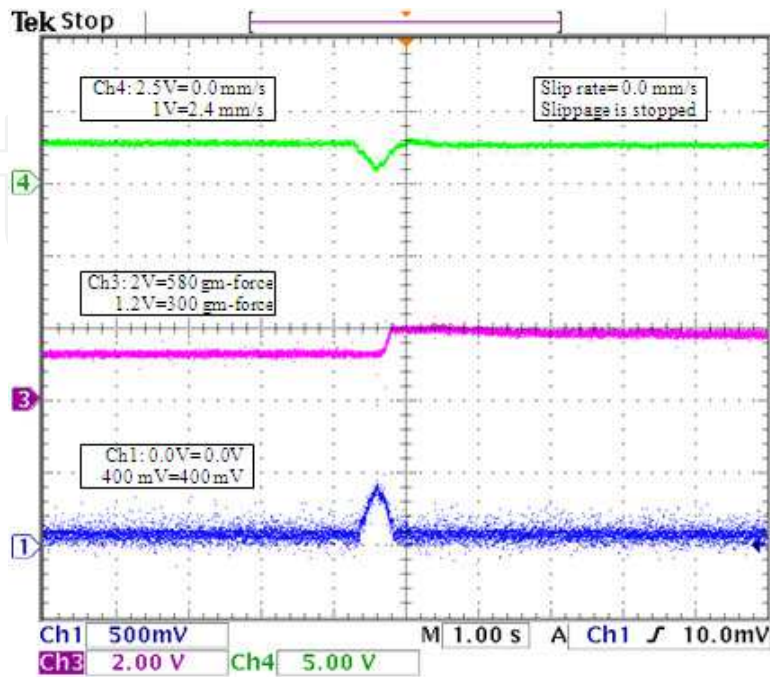

Fig. 26. Flow chart of the proposed scenario.

Considering the start reference controller based on pushing force as shown in Figure.27 (b) and in Figure. 28 (b), we can minimize the time of the grasping and lifting process. Moreover, a slip displacement reduction was achieved. To confirm and verify the robustness



Ch4: Slip-rate (mm/s) - Ch3: Fapp (gm-force) - Ch1: Vref (V)

(a) Pushing force is not considered

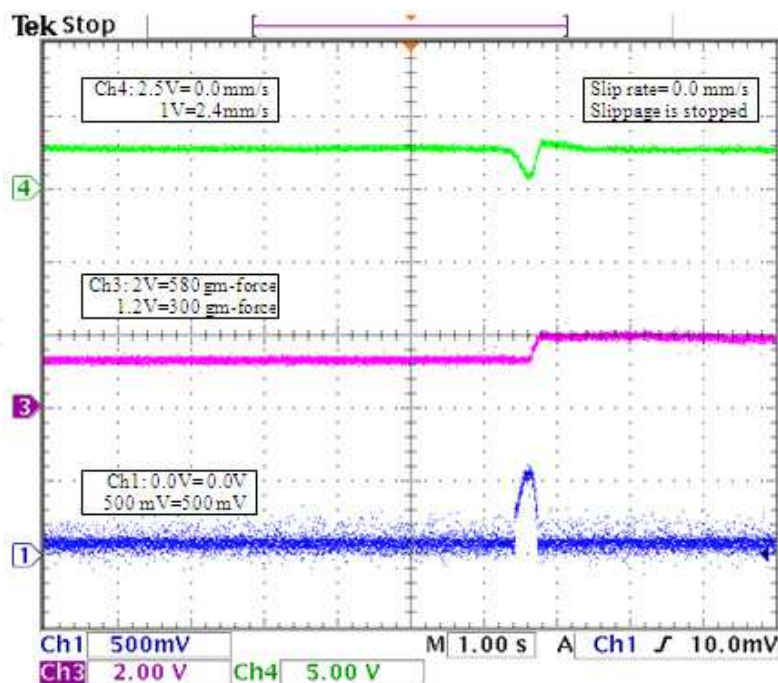

Ch4: Slip-rate (mm/s) - Ch3: Fapp (gm-force) - Ch1: Vref (V)

(b) Pushing force is considered

Fig. 27. System response when mass=550gm

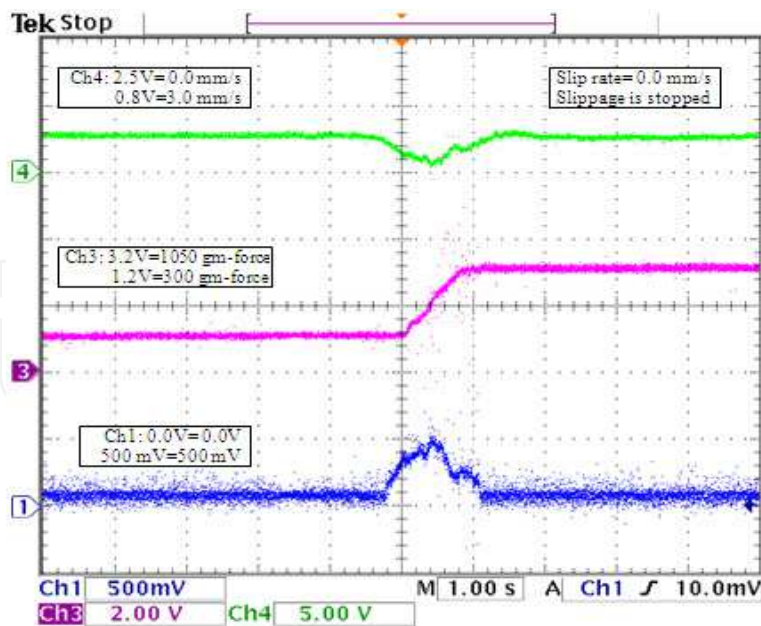

Ch4: Slip-rate (mm/s) - Ch3: Fapp (gm-force) - Ch1: Vref (V)

(a) Pushing force is not considered

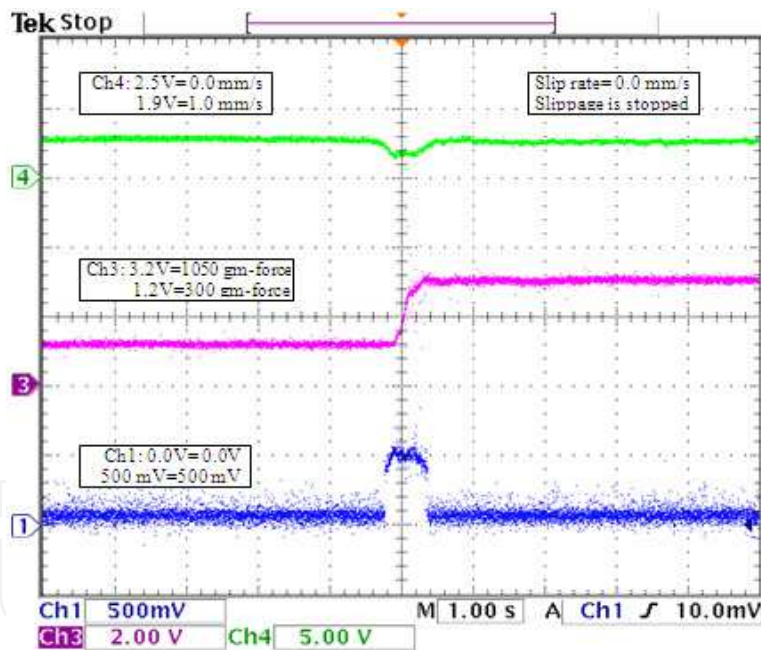

Ch4: Slip-rate (m/s) - Ch3: Fapp (gm-force) - Ch1: Vref (V)

(b) Pushing force is considered

Fig. 28. System response when mass=1000gm

force is not considered. The duration of the grasping and lifting process was in the range of 1 second and the slip displacement is in the range of 2 millimeters.

of the developed gripper set-up and its control, we disturb the assigned system by a sudden increase in object mass. The gripper system response was found as shown in Fig.29, which keeps the time of slippage and slip displacement in the range of 1 second and 2 millimeters

respectively. In the mean time Table 1 shows a comparison between the two proposed schemes. The enhancement in the response when the pushing force is considered gives us the opportunity to grasp safely objects with higher mass than in the first scheme where F_{push}

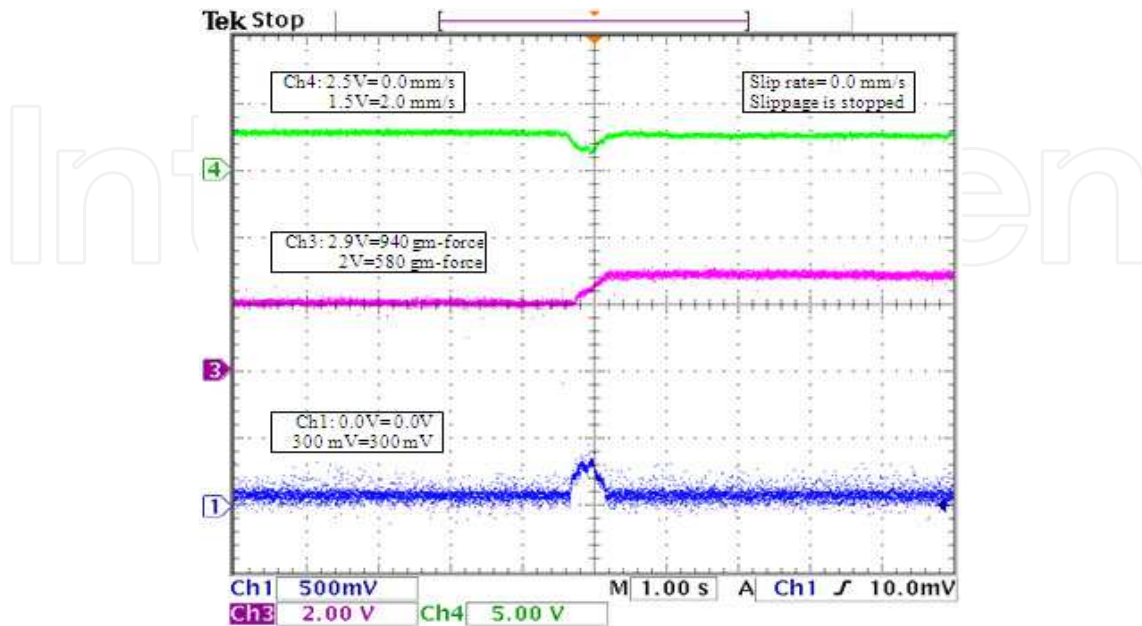

Ch 4:slip rate(mm/s) – Ch 3: Fapp(gm-force) – Ch1: Vref(V)

Fig. 29. System response when mass is suddenly increased from 550 to 900gm

Mass (gram)	Pushing force (gram-force)	First scheme controller response		Second scheme controller response	
		Time of process (sec)	Slip (mm)	Time of process (sec)	Slip (mm)
1000	Considered	0.73	4.15	0.502	3
1000	Not considered	1.35	5.56	1.05	3.9
550	Considered	0.441	2.73	0.312	1.85
550	Not considered	0.872	3.51	0.582	2.42
300	Considered	0.395	2.01	0.285	1.41
300	Not considered	0.623	2.88	0.533	1.95
100	Considered	0.201	1.45	0.19	1.11
100	Not considered	0.291	2.09	0.21	1.62

Table 1.

is not considered. It is clear from the table that the performance of the system in the case of the second controller scheme is better than in the case of the first controller. The duration of the process is lower in the second scheme and also the amount of the slip is reduced for all test cases where the mass of the object is varying between 100g and 1000g. This proves that the feedback variables choice is very important and has a great effect on the system performance.

9. References

- Barsky M. F., Lindner D. K., and Claus R. O.(1989), "Robot gripper control system using PVDF piezoelectric sensors", *IEEE Transaction on Ultrasonic, Ferroelectrics, and Frequency Control*, Vol. 36(No. 1), pp.129-134.
- Bicchi A. and Kumar V. (2000), "Robotic grasping and contact: A review", *Proceedings of the 2000 IEEE International Conference on Robotics and Automation*, San Francisco, CA, Vol.1, pp. 348-353.
- Chiu S.L. (1994), Fuzzy model identification based on cluster estimation, *Journal of Intelligent and Fuzzy System*, Vol.2, 267-278.
- Chiu S. L. (1997), An efficient method for extracting fuzzy classification rules from high dimensional data, *Journal of Advanced Computational Intelligence*, Vol.1(No.1), 31-35.
- Choi B., H. Choi H., and Kang S.(2005) ," Development of tactile sensor for detecting contact force and slip", *IEEE/RSJ International Conference on Intelligent Robots and Systems (IROS 2005)*, 2005, pp. 2638- 2643.
- Chopra S., Mitra R. & Kumar V. (2006), Analysis of fuzzy PI and PD type controllers using subtractive clustering, *International Journal of Computational Cognition* , Vol. 4(No. 2), 30-34.
- Chopra S., Mitra R., & Kumar V. (2006), Reduction of fuzzy rules and membership functions and its application to fuzzy PI and PD type controllers, *International Journal of Control, Automation, and Systems*, Vol. 4(No. 4), 438-447.
- Dario P. and De Rossi D. (1985), "Tactile sensors and the gripping challenge", *IEEE Spectrum*, Vol.5(No.22), pp.46-52.
- Denai M. A., Palis F. & Zeghib A. (2004), ANFIS based modeling and control of non-linear systems: A tutorial, *IEEE International Conference on Systems, Man and Cybernetics*, 3433-3438
- Dominguez-Lopez J. A., and Vila-Rosado D. N.," Hierarchical Fuzzy Control to Ensure Stable Grasping", *Seventh Mexican International Conference on Computer Science (ENC'06)*, Sept. 2006, pp. 37 - 43.
- Dubey V., and Crowder R. (2004), "Grasping and control issues in adaptive end effectors", in *ASME Design Engineering Technical Conferences*, Salt Lake City, Utah.
- Erdirencelebi D., Yalpir S. (2011), "Adaptive network fuzzy inference system modeling for the input selection and prediction of anaerobic digestion effluent quality", *Journal of Applied Mathematical Modelling*, Vol.35, pp 3821-3832.
- Friedrich W., Lim P., and Nicholls H. (2000), "Sensory gripping system for variable products", *Proceedings of the 2000 IEEE International Conference on Robotics and Automation*, San Francisco, California, USA, pp. 1982-1987.
- Hanafy O. Th. (2010), "A modified algorithm to model highly nonlinear system", *Journal of American Science*, Vol.6(No 12), pp747-759.

- Lin C. J., Chen C. H., & Lin C. T. (2008), "Efficient self-evolving evolutionary learning for neurofuzzy inference system" *IEEE Transactions On Fuzzy Systems*, Vol. 16(No. 6), 1476-1490.
- Lorenz R.D., Meyer K. M., and Van de Riet D.M.(1990), "A novel, compliant, four degree-of-freedom, robotic fingertip sensor", *IEEE Transaction on Industry Applications*, Vol. 26 (No. 4), pp. 613-619.
- Luo R.C., Su K.L. and Henry S.H.(2000), "An Implementation of Gripper Control Using the New Slipping Detector by Multi-sensor Fusion Method", *IECON 2000, 26th Annual Conference of the IEEE Industrial Electronics Society*, Vol.2, pp. 888 - 893.
- Monkman G. J., Hesse S., Steinmann R., and Schunk H. (2007), "Robot Grippers", Wiley-VCH.
- Nikhil R., Pal K., Bezdek J. C. & Runkler T. A. (1997), Some issues in system identification using clustering, *Proc. of International Conference on Neural Networks*, Vol. 4, 2524-2529
- Ottaviano E., Toti M., and Ceccarelli M.(2000), "Grasp force control in two-finger grippers with pneumatic actuation", *Proceedings of the 2000 IEEE International Conference on Robotics and Automation*, San Francisco, USA, Vol.2, pp. 1976 - 1981.
- Passino, K. M. & Yurkovich S. (1998), *Fuzzy Control*, Addison Wesley Longman Inc., Menlo Park, California.
- Rezaeeian A., Koma A. Y, Shasti B. & Doosthoseini A. (2008), ANFIS modeling and feed forward control of shape memory alloy actuators, *International Journal of Mathematical Models and Methods in Applied Sciences*, Vol.2 (No 2), 228-235.
- Salami M-J. E., N. Mir-Nassiri N. and Sidek S. N. (2000)," Design of intelligent multi-finger gripper for a robotic arm using a DSP-based fuzzy controller", *Proceedings of TENCON 2000*, Kuala Lumpur, Malaysia, Vol. 3, 24-27 Sept. 2000, pp. 348-353.
- Seguna C.M. and Saliba M.A.(2001), "The mechanical and control system design of a dexterous robotic gripper", *the 8th IEEE International Conference on Electronics, Circuits and Systems, ICECS 2001*, Vol. 3, pp. 1195 - 1201.
- Simoes M. G. & Friedhofer M. (1997), "An implementation methodology of a fuzzy based decision support algorithm", *International Journal of Knowledge-Based Intelligent Engineering Systems*, Vol.1 (No. 4), 267-275.
- Simoes M. G. & Franceschetti N. N. (1999), Fuzzy optimization based control of a solar array system, *IEE Proceedings-Electric Power Applications*, Vol. 14 (No.5), September 1999, 552-558.
- Yager R.R. & Filev D.P. (1994), Generation of fuzzy rules by mountain clustering, *Journal of Intelligent and Fuzzy System*, Vol.2, 209-219.
- Zadeh, L. A. (1965), Fuzzy set, *Information and Control*, Vol. 8, 338-353.

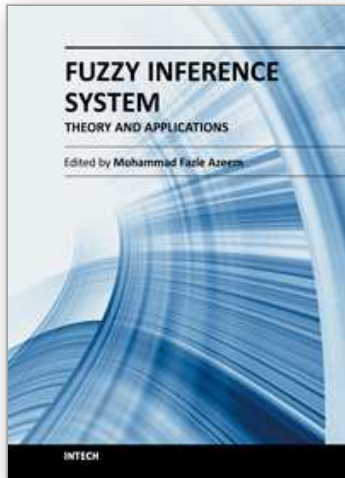

Fuzzy Inference System - Theory and Applications

Edited by Dr. Mohammad Fazle Azeem

ISBN 978-953-51-0525-1

Hard cover, 504 pages

Publisher InTech

Published online 09, May, 2012

Published in print edition May, 2012

This book is an attempt to accumulate the researches on diverse inter disciplinary field of engineering and management using Fuzzy Inference System (FIS). The book is organized in seven sections with twenty two chapters, covering a wide range of applications. Section I, caters theoretical aspects of FIS in chapter one. Section II, dealing with FIS applications to management related problems and consisting three chapters. Section III, accumulates six chapters to commemorate FIS application to mechanical and industrial engineering problems. Section IV, elaborates FIS application to image processing and cognition problems encompassing four chapters. Section V, describes FIS application to various power system engineering problem in three chapters. Section VI highlights the FIS application to system modeling and control problems and constitutes three chapters. Section VII accommodates two chapters and presents FIS application to civil engineering problem.

How to reference

In order to correctly reference this scholarly work, feel free to copy and paste the following:

A.M. Zaki, O.A. Mahgoub, A.M. El-Shafei and A.M. Soliman (2012). Control of Efficient Intelligent Robotic Gripper Using Fuzzy Inference System, Fuzzy Inference System - Theory and Applications, Dr. Mohammad Fazle Azeem (Ed.), ISBN: 978-953-51-0525-1, InTech, Available from:

<http://www.intechopen.com/books/fuzzy-inference-system-theory-and-applications/control-of-efficient-intelligent-robotic-gripper-using-fuzzy-inference-system>

INTECH
open science | open minds

InTech Europe

University Campus STeP Ri
Slavka Krautzeka 83/A
51000 Rijeka, Croatia
Phone: +385 (51) 770 447
Fax: +385 (51) 686 166
www.intechopen.com

InTech China

Unit 405, Office Block, Hotel Equatorial Shanghai
No.65, Yan An Road (West), Shanghai, 200040, China
中国上海市延安西路65号上海国际贵都大饭店办公楼405单元
Phone: +86-21-62489820
Fax: +86-21-62489821

© 2012 The Author(s). Licensee IntechOpen. This is an open access article distributed under the terms of the [Creative Commons Attribution 3.0 License](#), which permits unrestricted use, distribution, and reproduction in any medium, provided the original work is properly cited.

IntechOpen

IntechOpen