

Control Oriented Low Order Modelling of a Complex PWR Plant: a Comparison Between Open Loop and Closed Loop Methods[†]

Pascale Bendotti¹, Benoît Codrons², Clément-Marc Falinower¹ and Michel Gevers²

¹Électricité de France, Direction des Études et Recherches, 6 Quai Watier, F-78041 Chatou, France

Email: Pascale.Bendotti@der.edfgdf.fr, Clement-Marc.Falinower@der.edfgdf.fr

²CESAME, Université Catholique de Louvain, 4-6 avenue G. Lemaître, B-1348 Louvain-la-Neuve, Belgium

Email: Codrons@csam.ucl.ac.be, Gevers@csam.ucl.ac.be

Abstract

The most classical way of obtaining a low order model-based controller for a high order system is to apply closed loop reduction techniques to an accurate high order model or controller of the plant. The recent literature on identification for control has promoted the idea that an alternative way is to directly identify a low order model using a control-oriented identification criterion, and to compute a controller from this model. In this paper we illustrate the validity of this alternative route for the design of a controller for the secondary circuit of a nuclear Pressurized Water Reactor. In passing, this application also shows that the key feature for a successful control design is not so much the choice between order reduction or identification methods, but between open loop and closed loop techniques.

1 Introduction

There are several ways of obtaining low order controllers for high order systems. One line of thinking is that one can first obtain a very accurate high order model or to a high order controller computed from that model. There is an extensive literature on this subject. One of the important theoretical messages of this literature is that, if the ultimate objective is the low order controller (rather than the low order model), then it is essential that the closed loop performance objective be incorporated in the reduction technique. This is typically achieved by specific frequency weightings that translate these closed loop objectives in the model or controller reduction criterion.

[†]The authors acknowledge the Belgian Programme on Interuniversity Poles of Attraction, initiated by the Belgian State, Prime Minister's Office for Science, Technology and Culture. The scientific responsibility rests with its authors.

The recent research on identification for control has promoted the idea that one can, alternatively, obtain a low order model directly by closed loop identification, where the identification criterion takes account of the control performance objective. Even though practitioners, often unconsciously, perform some form of control-oriented identification because they are not allowed to open the control loops, their conscious objective is to identify "the best possible model" without taking account of control design objectives.

The main contribution of this paper is to add insight to this ongoing debate about identification for control. Our initial objective, while initiating this research, was to evaluate whether "identification for control" could be viewed as a viable alternative to model or controller reduction when the objective is to obtain a low order controller for a complex system¹. The main advantage of an identification-based route to a low order controller is that it alleviates the need for a high precision model of the actual system, which is the required starting point of all order reduction techniques. Starting from a realistic model of order 42² of a Pressurized Water Reactor (PWR) of a nuclear power plant, we produce a 12-th order LQG controller obtained through closed loop model reduction techniques that achieves a required level of performance. We show that the same performance is achieved by a 12-th order controller obtained directly from a low order model of the PWR identified via a control-oriented identification criterion.

A second contribution of this paper is to show that, whether the route to a low order controller is via model reduction techniques or via identification of a low or-

¹For reasons of space, we have limited our analysis in this conference paper to a comparison between low order closed loop identification and model reduction, the latter in open and closed loop. The computation of low order controllers by closed loop controller reduction leads to similar conclusions.

²As our colleague Douglas Adams explained, the universal true system is of order 42: see [1] p. 135.

der model, the key to the success of the operation is to inject weightings that reflect the closed loop performance objectives. Even though this message may not surprise the small community of identification for control experts, it is interesting to produce such evidence on a realistic industrial problem.

The outline of the paper is as follows. In Section 2 we sketch the modelling of the PWR plant, while Section 3 gives a description of the control problem and the control design procedure. Section 4 reviews the MIMO closed loop identification procedure. Section 5 describes the coprime factor model order reduction procedure, first in open loop, then when closed loop considerations are taken into account. It shows how the control objective can be used to select an adequate frequency weighting for the reduction. The controllers resulting from the different low order models, as well as their performance on the actual system, are compared in section 6. Finally, some conclusions are drawn in section 7.

2 Modelling of the PWR

A realistic nonlinear simulator, based on a first principles' model describing both primary and secondary circuits of the PWR (See Figure 1), has been developed at ÉLECTRICITÉ DE FRANCE (EDF). It includes all local controllers involved in both primary and secondary circuits.

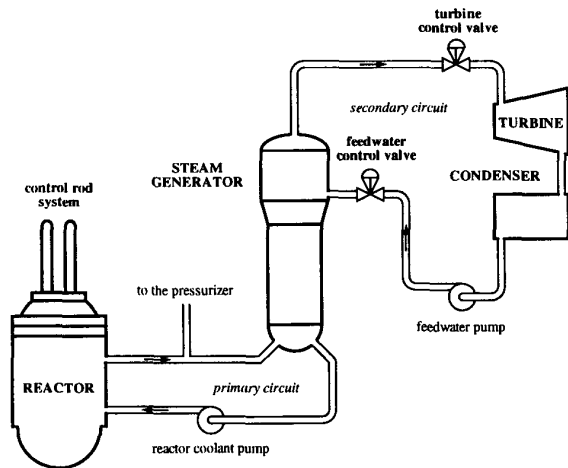

Figure 1: PWR plant description

In this paper, we focus on the behavior of the plant around a fixed operating point corresponding to 95% of maximum operating power. This results in a high (42-nd) order model P_{42} , which includes the dynamics of the primary and secondary circuits and of all local controllers, except some specific controllers of the secondary circuit that we want to redesign; these are

denoted K_{tb} and K_{cd} in Figure 2. They control the electrical power and the condenser water level, respectively, and their structures are very simple: K_{tb} is a PI controller acting on the difference between its two inputs, while K_{cd} is a second order two-input-one-output controller which includes an integrator. For the sake of simplicity, K_{tb} and K_{cd} will both be called "PID" controllers in the sequel.

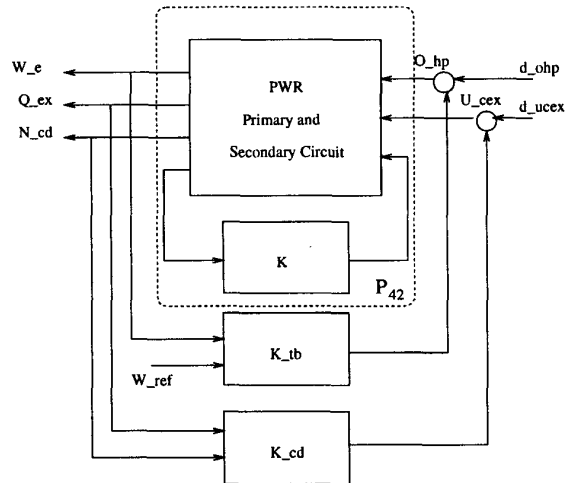

Figure 2: Interconnection of P_{42} with the PID controllers.

In Figure 2, W_e is the electrical power produced by the plant, controlled to follow the demand W_{ref} of the network, and directly related to the steam flow in the turbine, which depends on the high pressure turbine control valve aperture O_{hp} - see Figure 1; Q_{ex} is the extraction water flow, and N_{cd} the water level in the condenser (both are related to the locally controlled speed of the feedwater pump and to the extraction valve aperture U_{cex}). d_{ohp} and d_{ucex} represent additive terms on the control inputs that can be either perturbations, or excitations for identification purposes. Obviously, there is a strong coupling between W_e and O_{hp} on the one hand, and between N_{cd} and U_{cex} on the other hand, which explains the structure of the present PID controllers. However, the control performance might be enhanced by taking the cross-couplings into account.

3 Control design strategy

Our goal is to redesign controllers for the electrical power control in the secondary circuit, *i.e.* to replace the present PID controllers K_{tb} and K_{cd} by a single multivariable controller in order to achieve a better performance. The chosen control design is a Linear Quadratic Gaussian (LQG) controller computed from a reduced order model of the plant P_{42} .

The control objective is to use the feedwater tank, rather than the control rods in the primary circuit, to

absorb the fast and medium range variations in the power demands by acting on the valve apertures. The controller will have to ensure that the electrical power supply W_e follows accurately the reference signal W_{ref} , and to regulate the condenser water level N_{cd} around its nominal value. Also, it will have to reject possible perturbations acting on the system at the inputs d_{Ohp} and $d_{U_{ceex}}$. The validation will be done with step signals on W_{ref} , d_{Ohp} and $d_{U_{ceex}}$.

In order to remain consistent in the comparative study, the same LQG criterion is used with each reduced order model:

$$J_{LQG}(u) = \int_0^{\infty} (y_{filt}^T Q y_{filt} + u^T R u) dt, \quad (1)$$

where $u = [O_{hp} \ U_{ceex}]^T$ is the control vector and $y_{filt} = [(W_e - W_{ref}) \ N_{cd}]^T$ is the controlled output vector filtered through a filter $O_{filt}(s) = 3 + 1/s$ to ensure a zero static error. This filter is then connected to the corresponding inputs of the designed controller. Since the main goal is to control W_e (the regulation of N_{cd} being only a secondary requirement), more weight is put on the electrical power tracking error than on the condenser water level in J_{LQG} . On the other hand, since the nominal value of U_{ceex} is 0.01 while it is 1 for O_{hp} , more weight is put on U_{ceex} to ensure a correct scaling. The chosen weighting matrices are $Q = \text{diag}(1, 0.01)$ and $R = \text{diag}(0.01, 1000)$. These weightings have proved very satisfactory.

For the design of the Kalman filter, the external signals d_{Ohp} , $d_{U_{ceex}}$ and W_{ref} , which are in the low frequency ranges, are modeled as independent Gaussian white noises filtered through a low-pass filter $N_{filt} = 1/(s + 0.01)$. Since the external signals have a typical amplitude of 1 for d_{Ohp} and W_{ref} , and of 0.01 for $d_{U_{ceex}}$, their covariance matrix is chosen as $Q_n = \text{diag}(1, 0.0001, 1)$. In order to ensure a good roll-off at high frequency, the measurement noise is parametrized as a Gaussian white noise with very large covariance $R_n = \text{diag}(1000, 1000, 1000)$ (remember that Q_{ex} is measured and used for state estimation, although it is not regulated, which is why R_n is 3×3).

The presence of the filters O_{filt} (2 times) and N_{filt} (3 times) will yield a controller with order equal to that of the design model plus 5. This will put a requirement on the model order if a controller of some fixed order is desired.

4 First approach to a low order model for control design: system identification

The identification experiments have been carried out using P_{42} as the plant. In the spirit of the identifica-

tion for control literature (see e.g. [2, 3, 4]), the identification was conducted in closed loop with excitation signals d_{Ohp} and $d_{U_{ceex}}$ in the frequency range of interest. This has the effect of producing a model that is accurate in the frequency range that is important for control design. Our goal was to obtain a reasonably low order linear model for the plant around some operating point. We used the approach first presented in [5] for the identification of a model of the primary circuit of a PWR.

4.1 MIMO state-space description

Consider the system depicted in Figure 2. The physical system is described by a LTI system around an operating point given by the following:

$$\begin{bmatrix} x(k+1) \\ y_s(k) \end{bmatrix} = \begin{bmatrix} A & B \\ C & D \end{bmatrix} \begin{bmatrix} x(k) \\ u(k) \end{bmatrix} \quad (2)$$

where $y_s(k) = [W_e(k) \ Q_{ex}(k) \ N_{cd}(k)]^T$, $u(k) = [O_{hp}(k) \ U_{ceex}(k)]^T$ and $x(k)$ represent the output, the input and the state at time k , respectively.

Physical insights and preliminary identification of several SISO and MISO transfer functions were used to provide insight into an appropriate identifiable parameterization with a low number of parameters, the other entries of A , B , C and D being set at zeroes and ones. The electrical power and the water flow are mainly related to the control inputs by third order systems, while the water level integrates the water flow. Furthermore, O_{hp} affects essentially the electrical power, while U_{ceex} affects the water flow. Hence, the system is diagonal-dominant with some cross-couplings. These insights led to an identifiable state-space realization of order 7 with a vector θ of 19 free parameters.

4.2 MIMO identification

The output of the model is denoted

$$y(k, \theta) = \{C(\theta)[qI - A(\theta)]^{-1}B(\theta) + D(\theta)\}u(k). \quad (3)$$

A set of 10,000 input/output data collected on the closed loop system made up of P_{42} with the PID controllers K_{tb} and K_{cd} was used to determine the parameter estimates. A standard quadratic prediction error criterion was minimized [6].

A continuous time model of order 7, \hat{P}_7^{id} , is obtained by first order approximation of the identified discrete-time model, since the sampling period $T_s = 0.2$ s of the latter is much smaller than the fastest natural time constant of the system. It is then validated by checking how well it matches the behavior of the system P_{42} when simulated with a different data set (Figure 3).

This continuous time model \hat{P}_7^{id} will be used for control design in Section 6, and the performance of the ensuing

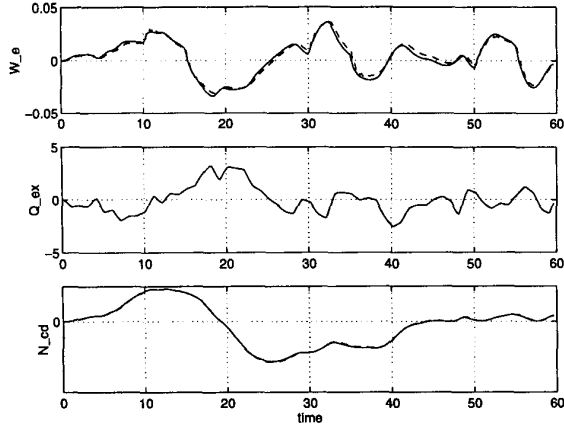

Figure 3: Time-domain responses of P_{42} (—) and \hat{P}_7^{id} (---) to validation data.

controller on the system P_{42} will be compared with that of the controllers obtained from other models of order 7 obtained by model reduction techniques.

5 Second approach to a low order model for control design: model reduction

Our second approach consists in reducing the order of the 42-nd order plant model P_{42} to a model of order 7 (for the sake of comparison with the model identified in the previous section) before controller synthesis. Since the system P_{42} includes unstable modes, a straight balanced truncation is not achievable. Therefore, we use a factorization method in which the system transfer function is factored into stable coprime factors, as proposed by Meyer [7]. A generalization of this technique to unstable uncertain systems was recently proposed in [8].

5.1 Open loop coprime factor reduction

If the unstable system under consideration is *detectable*, we can construct a stable left coprime factorization (LCF) using the following proposition, which is the dual of a result derived in [8] for right coprime factorization:

Proposition 1 *Given a detectable realization (A, B, C, D) of a transfer matrix P , and any constant stabilizing output injection matrix L , construct \tilde{N} and \tilde{M} as in*

$$\begin{bmatrix} \tilde{N} & \tilde{M} \end{bmatrix} = \left[\begin{array}{c|cc} A+LC & B+LD & L \\ \hline C & D & I \end{array} \right]. \quad (4)$$

Then $P = \tilde{M}^{-1}\tilde{N}$. Furthermore, the coprime factors can be normalized, meaning that

$$\tilde{N}\tilde{N}^* + \tilde{M}\tilde{M}^* = I.$$

The realization (4) is clearly stable (since $A + LC$ is stable), and therefore can be reduced using standard balanced truncation. It has 42 states, 5 inputs and 3 outputs. One advantage of using normalized coprime factors is that the error between the full and reduced order models can then be interpreted in the *graph metric* or *gap metric* [9, 7, 10]: the error is an upper bound on the distance between the graphs of the full and reduced order models. Let $[\tilde{N}_r \tilde{M}_r]$ denote the reduced LCF realization. To make the reduction process useful, we must ensure that the reduced factors \tilde{N}_r and \tilde{M}_r have the same denominator, and that their realizations have the same state, so that the order of the reduced model $\hat{P}_r = \tilde{M}_r^{-1}\tilde{N}_r$ is that of \tilde{N}_r and \tilde{M}_r rather than the sum of these.

We apply the LCF reduction method to P_{42} . The Hankel singular values (HSV) of the LCF are shown using a logarithmic scale in Figure 4. We denote by \hat{P}_r^{ol} the reduced order model obtained by truncating all but the first r singular values. Recall that for such model an upper bound on the committed approximation error in the \mathcal{H}_∞ norm is given by twice the sum of the truncated HSV's: $\|P_{42} - \hat{P}_r^{ol}\|_\infty \leq 2 \sum_{i=r+1}^{42} \sigma_i$. The model \hat{P}_7^{ol} produces a destabilizing LQG controller when applied to the true system. For the sake of future discussion and comparison, we shall therefore also consider the model \hat{P}_{12}^{ol} : based on an examination of the plot of singular values (Figure 4), this appears like a reasonable model, given the large gap between the 12-th and the 13-th HSV's.

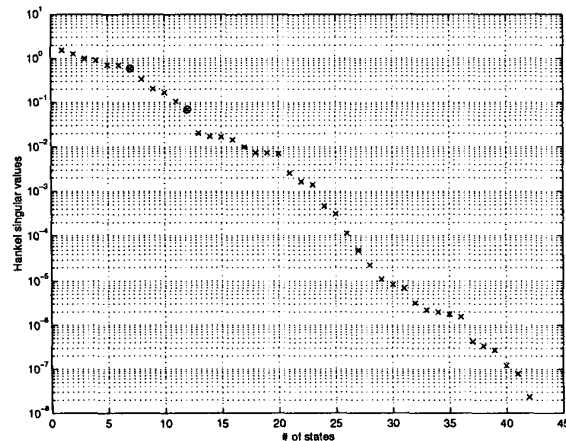

Figure 4: HSV's of the LCF decomposition. Circles indicate the truncations.

5.2 Closed loop coprime factor reduction

The idea of closed loop model reduction is to compute the reduced order model \hat{P}_r that ensures the best possible matching between the closed loop transfer functions $T(P_{42}, K)$ and $T(\hat{P}_r, K)$ where K is the presently acting controller. Here we rewrite the two PID controllers K_{tb} and K_{cd} of Figure 2 as a single

controller K_{pid} , mapping the output and reference vector $y = [W_e \ Q_{ex} \ N_{cd} \ W_{ref}]^T$ to the control vector $u = [O_{hp} \ U_{cex}]^T$. We then consider the closed loop transfer function $T(P_{42}, K_{pid})$ from the external inputs $w = [d_{Ohp} \ d_{Ucex} \ W_{ref}]^T$ to the controlled outputs $z = [W_e \ N_{cd}]^T$ as the object to be approximated by $T(\hat{P}_r, K_{pid})$, where \hat{P}_r is a reduced order model of order r : see Figure 5.

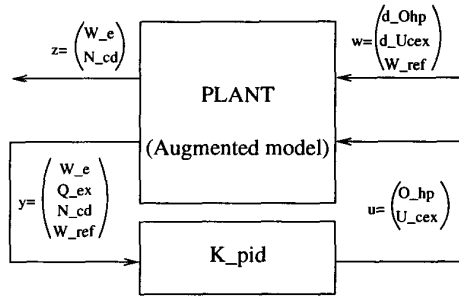

Figure 5: Standard plant configuration for the model P_{42} in feedback with the PID controller K_{pid} .

Some basic calculations show that minimizing the approximation error between these two closed loop transfer functions is equivalent with minimizing a frequency weighted difference between the LCF's of P_{42} and \hat{P}_r :

$$\begin{aligned} \min_{\hat{P}_r} & \quad \left\| T(P_{42}, K_{pid}) - T(\hat{P}_r, K_{pid}) \right\| \\ \Downarrow & \\ \min_{\{\tilde{N}_r, \tilde{M}_r\}} & \quad \left\| W \left[(\tilde{N} - \tilde{N}_r) (\tilde{M} - \tilde{M}_r) \right] \begin{bmatrix} I \\ 0 \end{bmatrix} \right\| \\ \Downarrow & \\ \min_{\tilde{N}_r} & \quad \left\| W (\tilde{N} - \tilde{N}_r) \right\|. \end{aligned} \quad (5)$$

Consider a right coprime factorization (RCF) $K_{pid} = UV^{-1}$ of the controller such that the Bezout identity

$$\begin{bmatrix} \tilde{N} \\ 0 \end{bmatrix} U + \begin{bmatrix} \tilde{M} & 0 \\ 0 & I \end{bmatrix} V = I$$

holds. Then, the output weighting filter is given by

$$W = \begin{bmatrix} 1 & 0 & 0 & 0 \\ 0 & 0 & 1 & 0 \end{bmatrix} V \begin{bmatrix} 1 & 0 & 0 \\ 0 & 1 & 0 \\ 0 & 0 & 1 \\ 0 & 0 & 0 \end{bmatrix}.$$

This defines an *output frequency weighted (OFW) balanced truncation* problem where the object to approximate is \tilde{N} . Since \tilde{M} does not play any role in the transfer function $T(P_{42}, K_{pid})$ that we consider, it can be approximated jointly with \tilde{N} in order that \tilde{N}_r and \tilde{M}_r have the same state matrix and define a LCF of \hat{P}_r .

We apply the OFW balanced truncation method to the stable normalized LCF of the system P_{42} . The reduced model of order 7, to be compared with the models of order 7 obtained by identification and by open loop reduction, is denoted \hat{P}_7^{cl} . For the sake of further discussion and comparison, we have also computed the model \hat{P}_4^{cl} of order 4 obtained by this procedure. The approximation error has the same property as in open loop reduction: $\|P_{42} - \hat{P}_r^{cl}\|_{\infty} \leq 2 \sum_{i=r+1}^{42} \sigma_i$ (here, the σ_i 's denote HSV's of the OFW LCF). The same interpretation in the gap metric holds, since the same normalized LCF of P_{42} is used.

6 Comparative study of controller performance

In this section we compare the performance on the actual system P_{42} of the controllers computed from the different models obtained by closed loop identification and by open or closed loop model reduction.

6.1 Performance of controllers of same order

We first consider the three models \hat{P}_7^{id} , \hat{P}_7^{ol} , and \hat{P}_7^{cl} of order 7. The corresponding controllers are computed as explained in Section 3. They are of order 12 and are respectively denoted K_{12}^{id7} , K_{12}^{ol7} and K_{12}^{cl7} .

Figure 6 shows the closed loop behavior of P_{42} controlled by K_{12}^{id7} and K_{12}^{cl7} in response to a step reference signal on W_{ref} (the responses to step disturbances on d_{Ohp} and d_{Ucex} are not shown due to space shortage, but they are qualitatively similar); for comparison purposes, the step responses with the initial PID controller K_{pid} are also shown. The controller K_{12}^{ol7} destabilizes the system P_{42} , and its responses can therefore not be shown. We observe that K_{12}^{id7} and K_{12}^{cl7} achieve very similar performance on the true system, and that their performance is significantly better than that of the initial PID controller.

6.2 Comments about other controllers

As stated above, for the sake of comparison, we have also computed a higher order model obtained by open loop reduction, \hat{P}_{12}^{ol} , and a lower order model obtained by closed loop reduction, \hat{P}_4^{cl} . The objective was to examine what order is required, using open loop model reduction techniques, to obtain a controller that would achieve a performance similar to that achieved by the controllers obtained from closed loop identification or closed loop reduction. Conversely, we wanted to examine how much further one could push down the order of the controller when closed loop reduction techniques are used, while still maintaining satisfactory performance. Using these models \hat{P}_{12}^{ol} and \hat{P}_4^{cl} , and the same LQG criterion, we have computed the corresponding controllers K_{17}^{ol12} and K_9^{cl4} . Their performance are

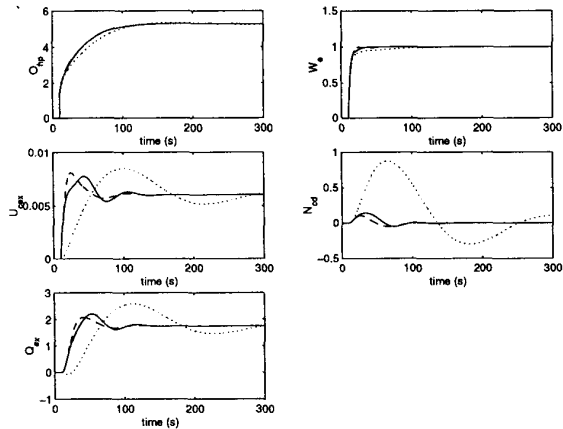

Figure 6: Responses to a step on W_{ref} : P_{42} controlled by K_{12}^{id7} (—), K_{12}^{cl7} (---) and K_{pid} (···).

presented in Figure 7, where they are compared with those of K_{12}^{cl7} .

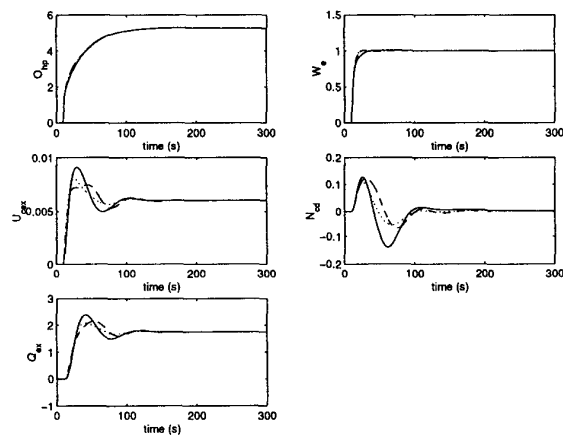

Figure 7: Responses to a step on W_{ref} : P_{42} controlled by K_9^{cl4} (—), K_{17}^{cl12} (---) and K_{12}^{cl7} (···).

We observe that these three controllers achieve similar performance on the actual plant. However note that, with open loop model reduction, a controller of order 17 is required to achieve a closed loop performance comparable to that achieved by the 12-th order controller K_{12}^{cl7} . Conversely, with closed loop reduction techniques, the reduction can be pushed further down to a 4-th order model (hence a 9-th order controller) that still gives reasonable performance.

7 Conclusions

In this study we have compared three different ways of obtaining a low order model for a plant in order to design a controller: open loop LCF reduction, closed loop (output frequency-weighted) LCF reduction, and

direct closed loop identification.

The methods have been tested on a realistic, high order linearized model of a PWR nuclear power plant, the goal being the replacement of two PID controllers by a single (coupled) LQG controller for the electrical power while ensuring an acceptable water level regulation in the condenser.

The comparison has produced two important findings. The first is that a specified level of performance can be achieved with controllers of much lower order when these are computed via closed loop model reduction or identification techniques. Alternatively, one could say that the performance achieved with controllers of the same order are better with controllers resulting from closed loop model reduction or identification techniques than with those obtained from open loop techniques. This message was probably familiar to theoreticians, but still needs to permeate industrial practice. More importantly, we have illustrated that closed loop identification is a viable alternative to model or controller reduction for the computation of low order controllers, with the added advantage that no high precision model is necessary to start with. Identification is then viewed as an order reduction technique.

References

- [1] D. Adams, *The Hitch-Hikers Guide to the Galaxy: Life, The Universe and Everything*. London: Pan Books, 1979.
- [2] M. Gevers, *Towards a Joint Design of Identification and Control? Essays on Control: Perspectives in the Theory and its Applications*, New York: Birkhauser, 1993.
- [3] M. Gevers, "Identification for control," *Proc. 5th IFAC Symposium on Adaptive Control and Signal Processing*, pp. 1-12, 1995.
- [4] P. V. den Hof and R. Schrama, "Identification and control - closed-loop issues," *Automatica*, vol. 31, pp. 1751-1770, December 1995.
- [5] P. Bendotti and B. Bodenheimer, "Identification and H_∞ control design for a Pressurized Water Reactor," *Proc. IEEE Conf. on Decision and Control*, pp. 1072-1077, 1994.
- [6] L. Ljung, *System Identification: Theory for the User*. Englewood Cliffs, NJ: Prentice-Hall, 1987.
- [7] D. Meyer, "A fractional approach to model reduction," *Proc. American Control Conference*, pp. 1041-1047, 1988.
- [8] C. Beck and P. Bendotti, "Model reduction for unstable uncertain systems," *Proc. 35th IEEE Conf. on Decision and Control*, pp. 3298-3303, 1997.
- [9] T. Georgiou and M. Smith, "Optimal robustness in the gap metric," *IEEE Trans Automatic Control*, vol. AC-35, pp. 673-686, 1990.
- [10] M. Vidyasagar, "The graph metric for unstable plants and robustness estimates for feedback stability," *IEEE Trans Automatic Control*, vol. AC-29, pp. 403-417, 1984.