

CONTROL SYSTEMS WITH NETWORK DELAY

Asif Šabanović¹, Kouhei Ohnishi², Daisuke Yashiro², Merve Acer¹, Nadira Š.-Behlilović¹

¹ Sabanci University, Orhanli, Istanbul, Turkey,

² Keio University, Yokohama, Japan

{asif.nadira@sabanciuniv.edu}, merveacer@su.sabanciuniv.edu, ohnishi@sd.keio.ac.jp, yasshi@sum.sd.keio.ac.jp

Abstract. In this paper motion control systems with delay in measurement and control channels are discussed and a new structure of the observer-predictor is proposed. The feature of the proposed system is enforcement of the convergence in both the estimation and the prediction of the plant output in the presence of the variable, unknown delay in both measurement and in the control channels. The estimation is based on the available data – undelayed control input, the delayed measurement of position or velocity and the nominal parameters of the plant and it does not require a priori knowledge of the delay. The stability and convergence is proven and selection of observer and the controller parameters is discussed. Experimental results are shown to illustrate the theoretical predictions.

Keywords. Control, Time-Delay, Motion Control, Disturbance observer.

1. INTRODUCTION

Control of system with delay in measurement and/or in control channel, due to the wide use of the network and teleoperation, is becoming very interesting research topics. Such systems are encountered in remotely controlled systems. Ideal bilateral control allows extension of a person's sensing to a remote environment. It has been paid considerable attentions in the recent and is expected to be an emerging point of modern developments in robotics, micro-parts handling, control theory and virtual reality systems. The potential applications of the teleoperation include network robotics, tele-surgery, space and seabed tele-manipulation, micro-nano parts handling, inspection and assembly. In recent years many interesting solutions ranging variation of the classic Smith predictor [1,2], control based on sliding modes [3], μ -Synthesis [4], Oboe and Fiorini proposed a design strategy of Internet-based telerobotics [5], Uchimura and Yakoh described bilateral robot system on hard realtime networks [6]. Passivity based approaches like scattering theory and wave variables have predominated the research field [7][8][9][10]. Those approaches assure the passivity as well as stability and are valid for constant delay. However, those are not able to be directly applied to time-varying delay cases. Among the proposed methods the communication disturbance observer (CDOB) based control of systems with delay [11] stands on its own as a simple design procedure based on well known disturbance observer method. It offers a framework for the application of the disturbance observer for the systems with constant and/or time-varying delay. Experimental results has confirmed applicability but at the same time revealed problem related to the convergence of the estimated-predicted value to the plant's output, especially in the case of the time-varying delay.

In this paper problems in control of motion systems with time delay in both measurement and the control channels will be discussed. The solution will be proposed in the general framework of disturbance observer method with

additional compensation selected to guaranty the convergence of the estimated plant variables in the presence of unknown possibly time varying time delay in both measurement and the control channels. This additional compensation terms are shown to be essential improvement of the CDOB guarantying the convergence and the stability.

The paper is organized as follows. In section II the plant and the problem statement are given. In section III the solution for systems with time delay and the dynamic distortion in the measurement channel are discussed. In section IV the solution for systems with delay in both measurement and the control channels are presented. In section V the closed loop behavior and the experimental results of the system with time delay in both measurement and the control channels are presented.

2. PLANT AND PROBLEM STATEMENT

Assume known one dof motion control system exposed to unknown time delay in control channel and unknown dynamics and delay in the measurement channel. The error in measurement may consist of time delay, dynamical distortion, and nonlinear gain in any combination. Due to the fact that it appears in the measurement channel it can be treated as a block in series with system output as depicted in Fig. 1. At the same time the transmission of the control signal is assumed to be distortion free except for the time-delay.

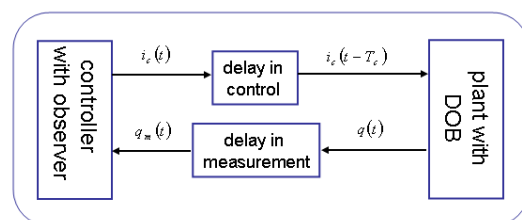

Fig. 1. Single dof system with distortion and delay in measurement and control channels

The analysis and design will be demonstrated on a simple single dof motion control system (1) for which the torque $\tau(t) = K_n i(t)$ is proportional to the current $i(t)$ and all uncertainties of the parameters and other forces acting on the system are lumped into the disturbance term $\tau_{dis}(t)$, thus dynamics is described by

$$\begin{aligned} \dot{q}(t) &= v(t) \\ a_n \dot{v}(t) &= K_n i(t) - \tau_{dis}(t), \quad \tau = K_n i(t) \\ \tau_{dis}(t) &= (a - a_n) \dot{v} + b(q, v) + g(q) + \tau_{ext}(t) \end{aligned} \quad (1)$$

Nominal inertia and torque constant a_n, K_n are assumed known. General acceleration control framework [?] for system (1) allows defining the control input in terms of the desired acceleration and consequently input current may be expressed as $K_n i(t) = a_n \dot{v}^{des}(t) + \hat{\tau}_{dis}(t) = K_n i_v(t) + K_n \hat{i}_{dis}(t)$. Component $K_n i_v(t)$ corresponds to the desired motion of the system $K_n i_v(t) = a_n \ddot{q}^{des}$ and component $\hat{\tau}_{dis} = K_n \hat{i}_{dis}(t)$ corresponds to the disturbance compensation.

In this paper the restoration of the system coordinates in the presence of network delay in the system and design of the network controller will be discussed. Nominal parameters of the plant are assumed known and measurements are subject to only network non idealities (delay and dynamic distortions) while control is subject only to network delay. The goal is to design controller based on available data such that stability of closed loop system is guaranteed and at least delay and nonlinearity in measurement channel is compensated while delay in control channel may result in delay in output.

3. NONLINEARITY AND DELAY IN MEASUREMENT CHANNEL

Further the output of the real plant at time (t) will be labeled as $q(t), v(t)$. For systems with delay in the control channel the output of the "ideal plant" without delay in the control channel will be labeled as $q_i(t), v_i(t)$. For plant without delay in the control channel these two sets of variables are equal thus $q(t) = q_i(t), v(t) = v_i(t)$ is valid. In system under consideration controller current command $i_c(t)$ is sent to the plant, the disturbance observer is applied so motion of the plant is driven by $K_n i(t) = K_n i_c(t) + K_n i_{ob}(t)$. Since component $i_{ob}(t)$ is originating on the plant side it is not subject to the delay in the control channel. Note that $i_{ob}(t)$ can be selected to compensate part of the disturbance thus it allows flexibility in selecting compensation strategy at plant side. The disturbance observer is assumed to enforce the nominal parameters of the system.

The measurements available at controller side are described as

$$\begin{aligned} q_m(t) &= q(t - T_m) = q(t, T_m) \\ v_m(t) &= v(t - T_m) = v(t, T_m) \end{aligned} \quad (2)$$

Where T_m stands for unknown, possibly varying time delay, in the measurement channel. The distortions in both position and the velocity measurements are assumed the same and both signals $q_m(t)$ and $v_m(t)$ are assumed available. In order to avoid long expressions a shorthand notation $x(t - T_m) = x(t, T_m)$ will be used from now on. The time " t " is referred to the time at controller side. Index "m" will be used to mark measurements.

Since there is no delay in the control channel input $K_n i_c(t)$ is transferred to the plant without delay. Available measurements dictate observer design based on plant nominal model and enforcement of tracking both or only one of the measured values $q_m(t)$ and $v_m(t)$. Let first analyze velocity tracking observer as in

$$a_n \dot{z}(t) = K_n i_c(t) - u_z(\varepsilon_z(t)), \quad \varepsilon_z(t) = v_m(t) - z(t) \quad (3)$$

Control $u_z(\varepsilon_z)$ in (3) forces the output $z(t)$ of the nominal plant, with parameters a_n, K_n and input $K_n i_c(t)$, to track the measured signal $v_m(t)$. Assume control $u_z(\varepsilon_z)$ is selected in such a way that finite-time convergence of error $\varepsilon_z(t) = 0$ is enforced (for example sliding mode is enforced by control $u_z(\varepsilon_z) = -k\varepsilon_z - \mu \text{sign}(\varepsilon_z), k, \mu > 0$ with μ being small positive constant that ensures finite time convergence in manifold $\varepsilon_z(t) = 0$). Then equivalent control $u_{zeq}(\varepsilon_z)$ maintaining motion in manifold $\varepsilon_z(t)|_{t>t_0} = 0$ with initial conditions $\varepsilon_z(t_0) = 0$ can be determined as

$$\begin{aligned} \dot{\varepsilon}_z(t) &= \dot{v}_m(t) - \dot{z}(t) = \dot{v}_m(t) - (K_n i_c(t) - u_{zeq}(\varepsilon_z)) / a_n = 0 \\ u_{zeq}(\varepsilon_z) &= K_n i_c(t) - a_n \dot{v}_m(t) \end{aligned} \quad (4)$$

Assuming that input to the plant (1) from controller side is the same as input to the observer $K_n i(t) = K_n i_c(t)$ then by solving second equation in (1) for $K_n i_c(t)$ and plugging $K_n i_c(t) = a_n \dot{v}(t) + \tau_{dis}(t)$ into (4) equivalent control $u_{zeq}(\varepsilon_z)$ may be expressed as $u_{zeq}(\varepsilon_z(t)) = \tau_{dis} - a_n (\dot{v}_m(t) - \dot{v}(t))$. Control $u_{zeq}(\varepsilon_z)$ represents difference between weighted acceleration of nominal plant and virtual plant, that with input $K_n i_c(t)$, will have output $v_m(t)$. From (4) one can derive

$$a_n (\dot{v}(t) - \dot{v}_m(t)) + \tau_{dis} = u_{zeq}(\varepsilon_z) \quad (5)$$

Now the observer estimating the velocity and position of the plant may be expressed from (5) in the following form

In order to avoid long expressions a shorthand notation $x(t-T_m) = x(t, T_m)$ and $x(t-T_c-T_m) = x(t, T_c, T_m)$ will be used from now on. The goal is to design a control system based on available measurements $q_m(t)$ and $v_m(t)$, the control input $K_n i_c(t)$ and the nominal parameters of the plant that will guaranty stable tracking of the reference. The response of the plant may have time delay equal to the control channel time delay.

Let us first construct the control forcing nominal plant with input $K_n i_c(t)$ to track the measured output $v_m(t)$ of the real plant as defined in (17)

$$a_n \dot{z}(t) = K_n i_c(t) - u_z(\varepsilon_z(t)), \quad \varepsilon_z(t) = v_m(t) - z(t) \quad (17)$$

Inserting acceleration from (1) (note that input to plant is $K_n i_c(t) = a_n \dot{v}_t(t) + \tau_{dis}(t)$) into expression for equivalent control yields

$$u_{zeq}(\varepsilon_z(t)) = a_n \dot{v}_t(t) - a_n \dot{v}_m(t) + \tau_{dis}(t) \quad (18)$$

From (18) one can write the predicted plant output at time "t" in the following form

$$\begin{aligned} a_n \hat{v}_t(t) &= u_{zeq}(\varepsilon_z) + a_n \dot{v}_m(t) - \tau_{dis}(t) \\ \hat{q}_t(t) &= \hat{v}_t(t) \end{aligned} \quad (19)$$

The full compensation of disturbance on the plant would lead to an observer without convergence term similarly as one given in (7). Let uncompensated disturbance term is $(K_D v(t) + K_P q(t))$ and that observer (17) is modified as

$$\begin{aligned} a_n \dot{z}(t) &= K_n i_c(t) - K_D \hat{v}_t(t) - K_P \hat{q}_t(t) - u_z(\varepsilon_z(t)) \\ \varepsilon_z(t) &= v_m(t) - z(t) \end{aligned} \quad (20)$$

The dynamics of plant (14) with uncompensated term $(K_D v(t) + K_P q(t))$ and with input $K_n i_c(t)$ may be written as

$$\begin{aligned} \dot{q}_t(t) &= v_t(t) \\ a_n \dot{v}_t(t) &= K_n i_c(t) - K_D v_t(t) - K_P q_t(t) - p_1(Q_d, \tau_{dis}) \end{aligned} \quad (21)$$

Here $p_1(Q_d, \tau_{dis})$ stands for the remaining disturbance compensation error. From tracking conditions in the observer (20) equivalent control may be expressed as

$$u_{zeq}(\varepsilon_z(t)) = K_n i_c(t) - K_D \hat{v}_t(t) - K_P \hat{q}_t(t) - a_n \dot{v}_m(t) \quad (22)$$

By deriving $K_n i_c(t)$ from second equation in (21) and inserting it into (22) one may obtain

$$\begin{aligned} u_{zeq}(\varepsilon_z) + a_n \dot{v}_m(t) &= \\ &= a_n \dot{v}_t(t) + K_D (v_t(t) - \hat{v}_t(t)) + K_P (q_t(t) - \hat{q}_t(t)) + p_1(Q_d, \tau_{dis}) \end{aligned} \quad (23)$$

In order to ensure convergence to zero of the estimation error $\Delta q(t) = q_t(t) - \hat{q}_t(t)$ the left hand side of (23) should be equal to $a_n \hat{v}_t(t)$ thus velocity observer has the following form

$$\begin{aligned} a_n \dot{z}(t) &= K_n i_c(t) - K_D \hat{v}_t(t) - K_P \hat{q}_t(t) - u_z(\varepsilon_z(t)) \\ a_n \hat{v}_t(t) &= a_n \dot{v}_m(t) + u_{zeq}(\varepsilon_z) \\ \hat{q}_t(t) &= \hat{v}_t(t), \quad \varepsilon_z(t) = v_m(t) - z(t) \end{aligned} \quad (24)$$

From (23) and (24) the estimation error may be expressed in the following form

$$\begin{aligned} a_n \Delta \ddot{q}_t(t) + K_D \Delta \dot{q}_t(t) + K_P \Delta q_t(t) &= -p_1(Q_d, \tau_{dis}) \\ \Delta q_t(t) &= q_t(t) - \hat{q}_t(t) \end{aligned} \quad (25)$$

Under the conditions that $p_1(Q_d, \tau_{dis}) = 0$ the estimation error will converge to zero if $K_D, K_P > 0$ are strictly positive.

The observer unites the function of the predictor and the compensation of the dynamic distortion. It should be noted here that almost the same result can be obtained if instead of the equivalent control the disturbance observer like structure is used. This follows from the nature of the information contained in the equivalent control – it is essentially the disturbance perceived as acting on the input of the nominal system without delays. Solution with disturbance observer is detailed in [11].

In the observer design no assumption on the nature of the delay in a sense of being constant or time varying or being equal or different in the control and measurement channels has been introduced. The elements determining the accuracy of the observer are related to the accuracy of the nominal parameters of the plant a_n, K_n , the accuracy of the compensation of disturbance on the plant and the design parameters K_D, K_P . From the structure of the convergence (25) or the estimation error follows that it actually depends on the nominal acceleration.

Essential part of the observer design is enforcing accurate calculation of the apparent disturbance perceived acting on the input of the system due to the time delays and distortions in the measurement and the control channels. The usage of the finite time convergence and the equivalent control is not essential. It has advantage of making convergence dynamics simpler. Application of the disturbance observer would introduce additional fast dynamics and it should be carefully evaluated. Such structure may be easier to implement and if high bandwidth is obtained may offer an easier way of implementing the systems.

5. CLOSED LOOP BEHAVIOR AND EXPERIMENTAL RESULTS

Analysis of closed loop behavior assumes knowing structure of the controller that provides control signal $K_n i_c(t)$. In order to make analysis simpler let controller be selected as PD with acceleration feed forward term as in (26)

$$K_n i_c(t) = (\ddot{q}^{ref}(t) + K_{DC}(\dot{q}^{ref}(t) - \hat{v}(t)) + K_{PC}(q^{ref}(t) - \hat{q}(t))) \quad (26)$$

The dynamics of the plant with delay in input channel is

$$\begin{aligned} \dot{q}(t) &= v(t) \\ a_n \dot{v}(t) &= K_n i_c(t - T_c) - K_D v(t) - K_P q(t) - p_1(Q_d, \tau_{dis}) \end{aligned} \quad (27)$$

By inserting control (26) into (27) the closed loop dynamics may be described in the following way

$$\begin{aligned} \ddot{q}(t) + K_D \dot{q}(t) + K_P q(t) + K_{DC} \dot{q}(t, \tau_c) + K_{PC} \hat{q}(t, \tau_c) &= \\ = \ddot{q}^{ref}(t, \tau_c) + K_{DC} \dot{q}^{ref}(t, \tau_c) + K_{PC} q^{ref}(t, \tau_c) \end{aligned} \quad (28)$$

Having convergence of the estimated values defined by (25) one can write $\hat{q}(t) = q(t) + \xi$ and $\hat{v}(t) = v(t) + \zeta$ with $\xi, \zeta \rightarrow 0$ (28) can be written as

$$\begin{aligned} \ddot{q}(t) + K_D \dot{q}(t) + K_P q(t) + K_{DC} \dot{q}(t, \tau_c) + K_{PC} q(t, \tau_c) &= \\ = \ddot{q}^{ref}(t, \tau_c) + K_{DC} \dot{q}^{ref}(t, \tau_c) + K_{PC} q^{ref}(t, \tau_c) + \varepsilon(\xi, \zeta) \end{aligned} \quad (29)$$

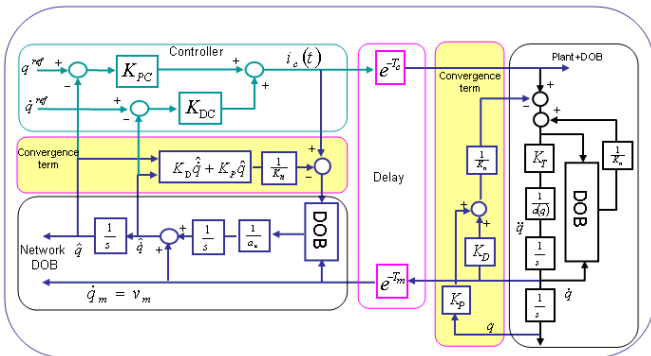

Fig.3. Structure of the closed loop control system with delay in both measurement and control channels

In (29) $\varepsilon(\xi, \zeta) \rightarrow 0$ and consequently closed loop behavior is described by

$$\begin{aligned} \ddot{q}(t) + K_D \dot{q}(t) + K_P q(t) + K_{DC} \dot{q}(t - \tau_c) + K_{PC} q(t - \tau_c) &= \\ = \ddot{q}^{ref}(t - \tau_c) + K_{DC} \dot{q}^{ref}(t - \tau_c) + K_{PC} q^{ref}(t - \tau_c) \end{aligned} \quad (30)$$

The expression (30) may be rewritten as

$$\begin{aligned} \begin{bmatrix} \dot{q} \\ \dot{v} \end{bmatrix} &= \begin{bmatrix} 0 & 1 \\ -K_P & -K_D \end{bmatrix} \begin{bmatrix} q \\ v \end{bmatrix} + \begin{bmatrix} 0 & 0 \\ -K_{PC} & -K_{DC} \end{bmatrix} \begin{bmatrix} q(t - \tau_c) \\ v(t - \tau_c) \end{bmatrix} = \\ &= \begin{bmatrix} 0 \\ \dot{v}^{ref}(t - \tau_c) \end{bmatrix} + \begin{bmatrix} 0 & 0 \\ -K_{PC} & -K_{DC} \end{bmatrix} \begin{bmatrix} q^{ref}(t - \tau_c) \\ v^{ref}(t - \tau_c) \end{bmatrix} \end{aligned} \quad (31)$$

In [1] it has been shown that for system represented in the form

$$\dot{\mathbf{x}}(t) = \mathbf{A}_1 \mathbf{x}(t) + \mathbf{A}_2 \mathbf{x}(t - \tau) \quad (32)$$

The stability requires $\mathbf{A}_1 + \mathbf{A}_2$ to be Hurwitz, and that there exist positive definite symmetric matrices $\mathbf{P}, \mathbf{S}, \mathbf{R}$ such that $\mathbf{A}_1^T \mathbf{P} + \mathbf{P} \mathbf{A}_1 + \mathbf{P} \mathbf{A}_2 \mathbf{S}^{-1} \mathbf{A}_2^T \mathbf{P} + \mathbf{S} + \mathbf{R} = \mathbf{0}$. Due to the fact that matrices $\mathbf{A}_1, \mathbf{A}_2$ depend only on the design parameters (the observer convergence gains and the controller gains) and not on the plant parameters one may use above stability conditions to determine range of the design parameters for which stability of the closed loop system will be ensured for selected matrices $\mathbf{P}, \mathbf{S}, \mathbf{R}$. The robustness on the change of delay should be separately investigated. Structure of the closed loop control system with delay in both measurement and control channels is depicted in Fig. 3.

Illustration of the closed system behavior is verified on the experimental system consisting of linear motor with driver attached to the PC under RT Linux. The experiments are conducted with time-delay in both measurement and the control loops being 10ms and the jitter in both loops being max 2.8 ms as depicted in Fig. 4. The transients of the closed loop system with controller gains $K_{DC} = 100, K_{PC} = 2500$, the filter in velocity and in DOB is set at $g = 200$, and the observer convergence gains K_D, K_P are depicted in Fig. 5-8. In all cases the error in the initial position of about 0.015 m is set in order to test the convergence on the reference and the mismatch in initial conditions.

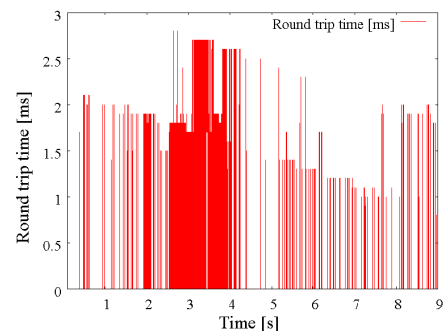

Fig. 4. The jitter in round trip time

In all figures the reference, the output of observer (control variable) and the output of the real plant are depicted. As expected the control of the observer output is confirmed in all figures. The behavior of the plant output depends on the enforcement of the convergence of the observer and the real

plant. In Fig. 5 the convergence from initial conditions and to step change of reference is confirmed. In Fig. 6 due to the absence of the position convergence term the steady state error in position is observed. In Fig. 7, due to the zero velocity convergence term the oscillation in the position is observed. In Fig. 8 due to the zero of both position and velocity convergence term the divergence of the plant position is observed.

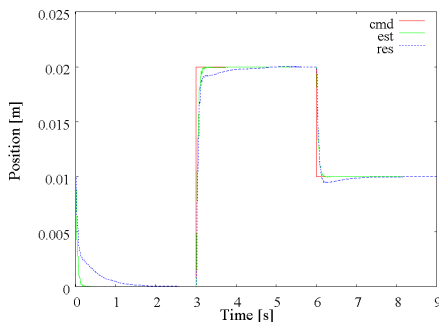

Fig. 6 Transients in closed loop system with $K_D = 8, K_p = 16$

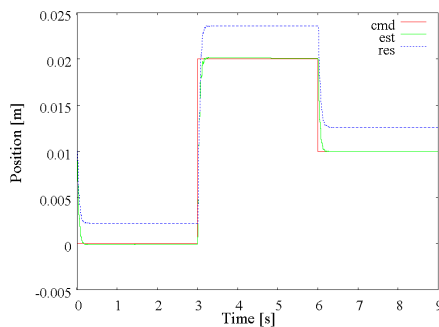

Fig. 7 Transients in closed loop system with $K_D = 8, K_p = 0$

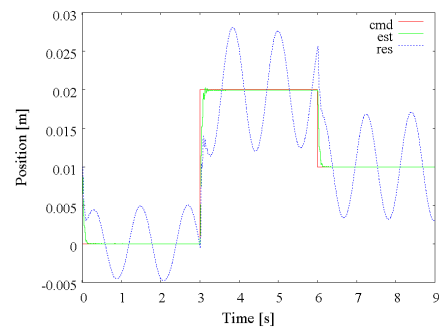

Fig. 8 Transients in closed loop system with $K_D = 0, K_p = 16$

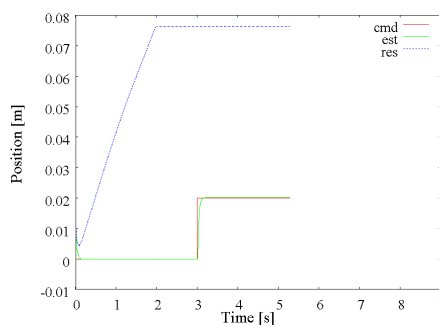

Fig. 9 Transients in closed loop system with $K_D = 0, K_p = 0$

6. CONCLUSIONS

The control of the system with network delay in the control and measurement channels is discussed and new structure of the communication disturbance observer is proposed. This structure is guarantying the convergence of the estimated output top the plant output despite the presence of the time varying time-delay in the loop. The time-delay is not required for the proof of the convergence, thus it is not needed to construct the observer. The estimation is provided based only on the available data – the control input and the measured plant output subject to the network delay in the measurement channel. Experimental results confirm predicted behavior of the system

7. ACKNOWLEDGEMENT

This work was supported in part by the SanTez Project 00183.STZ.2007-2, TUBITAK-NSF Project 106M533 and a Grant-in-Aid for the Global Center of Excellence for High-Level Global Cooperation for Leading-Edge Platform on Access Spaces from the Ministry of Education, Culture, Sport, Science, and Technology in Japan.

8. REFERENCES

- [1] Richard J-P, Time-delay systems: and overview of some recent advances and open problems, *Automatica*, 39 (2003), pp. 1667-1694
- [2] Z. J. Palmor, "Time-Delay Compensation -Smith Predictor and its Modifications-," *The Control Handbook*, W. S. Levine, Ed., pp. 224–237, Boca Raton, FL: CRC Press, 1966.
- [3] Vadim Utkin, Jürgen Guldner and Jingxin Shi, 1999, *Sliding Mode Control in Electromechanical Systems*, Taylor & Francis
- [4] N. Abe and K. Yamanaka, "Smith Predictor Control and Internal Model Control -ATutorial-," *Proceedings of SICE 2003 Annual Conference*, Fukui, Japan, vol. 2, pp. 1383–1387, August 2003.
- [5] G. M. H. Leung, B. A. Francis, and J. Apkarian, "Bilateral Controller for Teleoperators with Time Delay via μ -Synthesis," *IEEE Transactions on Robotics and Automation*, vol. 11, no. 1, pp. 105–116, 1995.
- [6] R. Oboe and P. Fiorini, "A Design and Control Environment for Internet-Based Telerobotics," *International Journal of Robotics Research*, vol. 17, no. 4, pp. 433–449, 1998.
- [7] Y. Uchimura and T. Yakoh, "Bilateral Robot System on the Real-Time Network Structure," *IEEE Transactions on Industrial Electronics*, vol. 51, no. 5, pp. 940–946, 2004.
- [8] P. F. Hokayem and M. W. Spong, "Bilateral Teleoperation : An historical survey," *Automatica*, vol. 42, no. 12, pp. 2035–2057, 2006
- [9] R. J. Anderson and M. W. Spong, "Bilateral Control of Teleoperators with Time Delay," *IEEE Transactions on Automatic Control*, vol. 34, no. 5, pp. 494–501, 1989.
- [10] G. Niemeyer and J. J. E. Slotine, "Stable Adaptive Teleoperation," *IEEE Journal of Oceanic Engineering*, vol. 16, no. 1, pp. 152–162, 1991.
- [11] Kenji Natori. 2008, Time Delay Compensation for Motion Control Systems, Ph.D. Thesis, Keio University, Yokohama, Japan