

NASA/TM-2014-218257



Coupling Damage-Sensing Particles to the Digital Twin Concept

*Jacob D. Hochhalter, William P. Leser, John A. Newman,
and Edward H. Glaessgen
Langley Research Center, Hampton, Virginia*

*Vipul K. Gupta and Vesselin Yamakov
National Institute of Aerospace, Hampton, Virginia*

*Stephen R. Cornell
Texas A&M University, College Station, Texas*

*Scott A. Willard
Science and Technology Corporation, Hampton, Virginia*

*Gerd Heber
The HDF Group, Champaign, Illinois*

NASA STI Program . . . in Profile

Since its founding, NASA has been dedicated to the advancement of aeronautics and space science. The NASA scientific and technical information (STI) program plays a key part in helping NASA maintain this important role.

The NASA STI program operates under the auspices of the Agency Chief Information Officer. It collects, organizes, provides for archiving, and disseminates NASA's STI. The NASA STI program provides access to the NASA Aeronautics and Space Database and its public interface, the NASA Technical Report Server, thus providing one of the largest collections of aeronautical and space science STI in the world. Results are published in both non-NASA channels and by NASA in the NASA STI Report Series, which includes the following report types:

- **TECHNICAL PUBLICATION.** Reports of completed research or a major significant phase of research that present the results of NASA Programs and include extensive data or theoretical analysis. Includes compilations of significant scientific and technical data and information deemed to be of continuing reference value. NASA counterpart of peer-reviewed formal professional papers, but having less stringent limitations on manuscript length and extent of graphic presentations.
- **TECHNICAL MEMORANDUM.** Scientific and technical findings that are preliminary or of specialized interest, e.g., quick release reports, working papers, and bibliographies that contain minimal annotation. Does not contain extensive analysis.
- **CONTRACTOR REPORT.** Scientific and technical findings by NASA-sponsored contractors and grantees.

- **CONFERENCE PUBLICATION.** Collected papers from scientific and technical conferences, symposia, seminars, or other meetings sponsored or co-sponsored by NASA.
- **SPECIAL PUBLICATION.** Scientific, technical, or historical information from NASA programs, projects, and missions, often concerned with subjects having substantial public interest.
- **TECHNICAL TRANSLATION.** English-language translations of foreign scientific and technical material pertinent to NASA's mission.

Specialized services also include organizing and publishing research results, distributing specialized research announcements and feeds, providing information desk and personal search support, and enabling data exchange services.

For more information about the NASA STI program, see the following:

- Access the NASA STI program home page at <http://www.sti.nasa.gov>
- E-mail your question to help@sti.nasa.gov
- Fax your question to the NASA STI Information Desk at 443-757-5803
- Phone the NASA STI Information Desk at 443-757-5802
- Write to:
STI Information Desk
NASA Center for AeroSpace Information
7115 Standard Drive
Hanover, MD 21076-1320

NASA/TM-2014-218257



Coupling Damage-Sensing Particles to the Digital Twin Concept

*Jacob D. Hochhalter, William P. Leser, John A. Newman,
and Edward H. Glaessgen
Langley Research Center, Hampton, Virginia*

*Vipul K. Gupta and Vesselin Yamakov
National Institute of Aerospace, Hampton, Virginia*

*Stephen R. Cornell
Texas A&M University, College Station, Texas*

*Scott A. Willard
Science and Technology Corporation, Hampton, Virginia*

*Gerd Heber
The HDF Group, Champaign, Illinois*

National Aeronautics and
Space Administration

Langley Research Center
Hampton, Virginia 23681-2199

April 2014

Acknowledgments

The work discussed in this report was enabled by the Aeronautics Research Mission Directorate (ARMD) Seedling Fund, which invests in early stage concepts. Computational resources supporting this work were provided by the NASA High-End Computing (HEC) Program through the NASA Advanced Supercomputing (NAS) Division at Ames Research Center. Professors Darren Hartl and Ibrahim Karaman of Texas A&M University provided significant support throughout this work: Prof. Hartl provided the material models used in the presented simulations and Prof. Karaman provided consultation on sensory alloy fabrication. One author (Stephen Cornell) contributed to this effort while funded by the Langley Aerospace Research Summer Scholars Program (LARSS).

Available from:

NASA Center for AeroSpace Information
7115 Standard Drive
Hanover, MD 21076-1320
443-757-5802

Abstract

The research presented herein is a first step toward integrating two emerging structural health management paradigms: digital twin and sensory materials. Digital twin is a life management and certification paradigm whereby models and simulations consist of as-built vehicle state, as-experienced loads and environments, and other vehicle-specific history to enable high-fidelity modeling of individual aerospace vehicles throughout their service lives. The digital twin concept spans many disciplines, and an extensive study on the full domain is out of the scope of this study. Therefore, as it pertains to the digital twin, this research focused on one major concept: modeling specifically the as-manufactured geometry of a component and its microstructure (to the degree possible).

The second aspect of this research was to develop the concept of sensory materials such that they can be employed within the digital twin framework. Sensory materials are shape-memory alloys that undergo an audible phase transformation while experiencing sufficient strain. Upon embedding sensory materials with a structural alloy, this audible transformation helps improve the reliability of crack detection especially at the early stages of crack growth. By combining these two early-stage technologies, an automated approach to evidence-based inspection and maintenance of aerospace vehicles is sought.

Introduction

It is expected that concept vehicles that will enable future missions will: be designed for service conditions that are not repeatable in a lab; experience loads and environments that are not foreseen during the design phase; and require extensive empirical data for the multifunctional next-generation materials. Each of these constitutes significant sources of uncertainty in safety and reliability of vehicles and missions. Furthermore, novel materials and structures add to the uncertainty in our design and management methods due to the lack of experience that comes with charting new territory.

Current structural life-management approaches are typically based on empirically-derived estimates of a worst-case scenario. Relying on worst-case scenarios derived from testing implies that in-service loading conditions are well understood; tails of material behavior distributions are accurately modeled; and coupled damage modes that lead to reduced life are identified. Unfortunately, actual in-service loading conditions and material behavior are not recorded and no validation of these assumptions can currently be made. Thus, uncertainty estimates are applied in an attempt to gauge the range of potential outcomes as dependent on errors in the assumptions.

Heavy reliance on empirical data and worst-case scenarios to quantify and handle uncertainty comes at the cost of over design, extensive test programs, overly-conservative inspection, and unnecessarily frequent part replacement [1,2]. These inefficiencies not only delay the implementation of novel materials and structural designs into NASA missions, but also maintain unnecessarily high maintenance costs for the vehicles currently in use. Therefore, improvements to current design and management approaches should focus on methods that help mitigate uncertainty and heavy reliance on empirical data.

Digital twin is an emerging concept which employs modeling and simulation of the as-built vehicle state, as-experienced loads and environments, and other vehicle-specific history to enable high-fidelity modeling of individual vehicles throughout their service lives [3,4]. Using this

method, each as-manufactured aircraft (or critical components) will be digitally replicated, then managed based on the data gathered from on-board sensors and damage progression simulations. The digital twin method, therefore, will preclude the issues related to assuming a worst-case scenario. Furthermore, a close coupling between diagnosis from nondestructive evaluation (NDE) and continual prognosis from updated simulations will provide better estimates for when inspections should occur and improve reliability for each vehicle individually. Essentially, digital twin aims to reduce uncertainty by incorporating into available models as much initial and in-service information as possible.

To provide a real-time monitoring capability, sensory particles can be embedded within structural components, see Figure 1. Sensory particles are micron-sized segments of a shape memory alloy that, when embedded in a material, can undergo a magnetic and audible phase transformation upon reaching a critical transformation strain. During transformation, sensory particles produce a characteristic acoustic signal when in the presence of a crack, which are then detected and used to triangulate crack location during flight. During transformation the material deforms by rapid twinning [5] generating an acoustic emission (AE) signal that is much stronger than the emission from crack growth in common structural alloys.

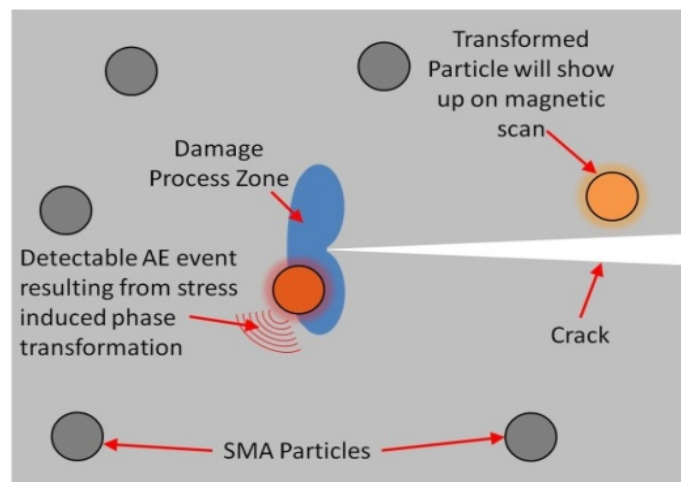

Figure 1: Schematic of embedded sensory particles near a crack.

Existing nondestructive evaluation (NDE) methods are typically limited by the physical response of the inspected material. As a result, existing methods do not reliably detect microstructurally-small cracks or localized plastic deformation [6,7]. Early detection of damage is critical since it reduces uncertainty for components where test data and validated predictive tools are lacking and will extend the manageable life of each vehicle. Since sensory particles can be placed throughout the material, at small length scales, damage detection can be made much earlier than with existing NDE technologies alone.

Combining the digital twin concept with the sensory particles technology addresses two main shortcomings in the way aerospace vehicles are currently designed and managed. First, digital twin will provide an individualized approach to inspection, repair, and replacement; ensuring functional parts will not be retired earlier than necessary. Second, automated monitoring will enable detection of unforeseen damage initiation in real-time and provide the digital twin with updates of actual usage and damage states. Such preventative and individualized condition-based inspection intervals provided by the proposed methodology will result in significant cost reduction by minimizing unnecessary inspections and early retirement

of parts. Furthermore, in most NASA missions, the ability to inspect vehicle components after going into service is an extremely difficult task and impossible in some long-duration flight cases. These two new techniques could direct an autonomous healing technology in the cases where repair is necessary. This process would not only improve the efficiency of current materials and practices, but permit faster implementation of novel, more efficient materials and structural designs into future NASA missions.

The purpose of this initial research was to: define and develop digital twin through a simple use case; verify acoustic emission detection from a shape memory material during transformation; embed sensory particles in a commonly-used aluminum alloy in aerospace applications and assess near-crack-tip phase transformation; and generate a digital twin model of a fatigue test specimen with sensory particles and simulate the observed phase transformation. Each of these topics is discussed in sequence below.

A Simple Digital Twin Example

The digital twin concept spans many disciplines, and an extensive study on the full domain is out of the scope of this study. Therefore, as it pertains to the digital twin, this research focused on one major concept: modeling specifically the as-manufactured geometry of a component. A simple, non-standard material test specimen which failed along one of two different likely crack paths was considered, as posed in a National fracture challenge problem by Sandia National Laboratories [8]. Small deviations in geometry resulted in crack path ambiguity, motivating the consideration of as-built geometry in the prediction of component behavior. The material of interest was an off-the-shelf precipitation hardened stainless steel. Thirteen challenge specimens were machined with the nominal specimen geometry shown in Figure 2. The posed question of interest to this seedling research was: Through which holes (B, C, and D) does the crack navigate on its way to the back edge, E?

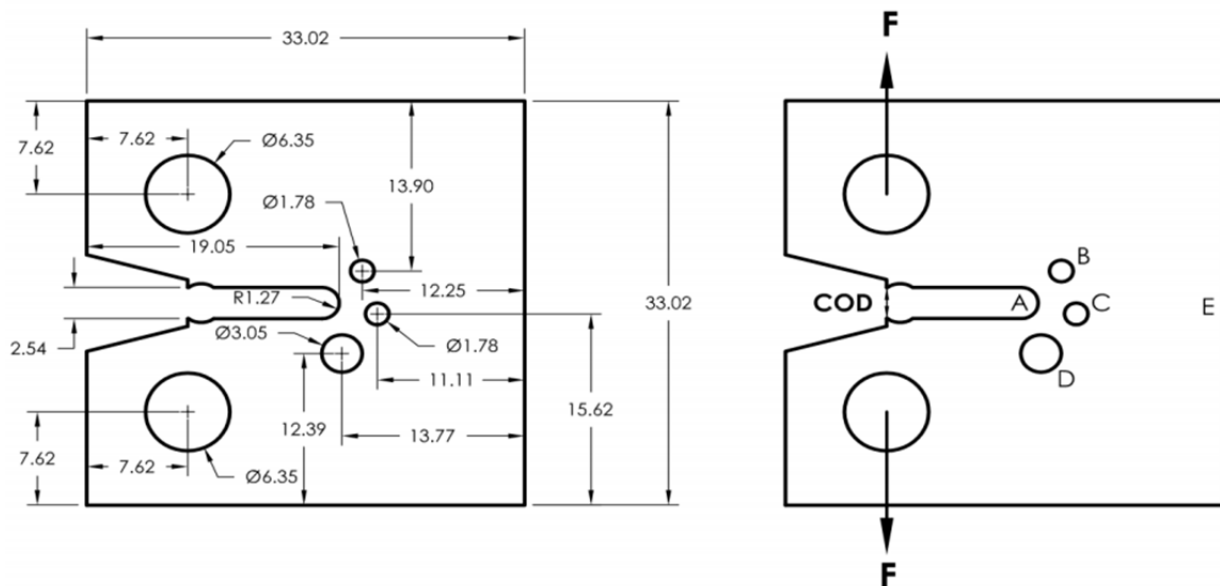

Figure 2: Challenge specimen configuration, thickness = 3.18 mm (to scale) [8].

First, using a calibrated damage plasticity model, blind crack path predictions were provided, without knowledge of any as-built geometry. After a sensitivity study of specimen geometry, it was determined from simulation (using Abaqus [9]) that the crack path would consistently be A-C-E. However, two crack paths were observed in the physical testing of the challenge

specimens: A-C-E and A-D-C-E. Of the thirteen specimens, ten cracked along the path defined by A-D-C-E, while three cracked along A-C-E. Further investigation showed only one of the specimens was machined to-specifications and its crack path was A-C-E, consistent with the blind prediction; however, the others exhibited deviations up to twice the specified tolerance (0.05 mm). The precise location of C in relation to D was observed to be critical.

This discrepancy between predicted and observed behavior is a result of the epistemic uncertainty in the blind prediction. In practice, the as-built geometry of structural components is not considered as predictions are based on an assumed (specified) nominal geometry. As a test of employing the digital twin concept, the simulations were run a second time, but with the as-built geometry of each of the challenge specimens. It was found that by considering the as-built geometry, instead of a single nominal geometry, the crack path was correctly predicted for each of the 13 specimens, rather than just 3 of the 13 specimens. A detailed account of these results is given in [10].

One of the major payoffs of the digital twin method has been identified: the reduction of epistemic and aleatoric uncertainty. Epistemic uncertainty, systematic variation of measurable variables, was shown to be mitigated through this challenge problem. Aleatoric uncertainty, statistical variation from unknown variables that cannot be suppressed by more accurate measurement, was reduced by updating the material model to account for damage modes not observed in the calibration specimens, but affected the challenge specimens that were not machined within the specified tolerance. Although this example addressed the efficacy of the digital twin as a beneficial concept, further developments are required to incorporate Bayesian updating aspects, a critical aspect of digital twin.

Sensory Alloy Testing

Acoustic Emission Sensing

A schematic of the AE system used during experiment is shown in Figure 3. AE events were captured using Digital Wave B-1025 piezo sensors. The captured signals were pre-amplified by 20 db before being routed to a Digital Wave FM-1 digitizer/signal conditioner where further amplification and/or filtering could be applied as needed before the signals were digitized and recorded using the commercial software Wave Explorer [11]. All signals were recorded at a sampling rate of 10 MHz.

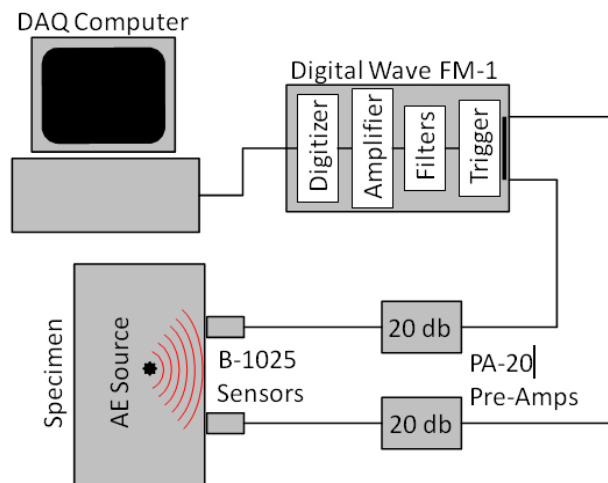

Figure 3: Schematic of the data acquisition system used to capture and record AE events.

Bulk Sensory Alloy Experiment

A proof-of-concept of the acoustic emission process was conducted using a Nickel-Titanium (Ni-Ti) tensile specimen. Ni-Ti was chosen as the proof-of-concept material since it is readily available, relatively cheap, and much is already known about its behavior. Tensile tests on Ni-Ti were conducted using an Instron servo-hydraulic machine as shown in Figure 4. Two AE sensors were attached at either end of the gage section in order to allow for one-dimensional location to be calculated for acquired AE events. Strain in the sample was monitored with a one inch extensometer as well as with digital image correlation (DIC). DIC was performed using a speckle pattern created by airbrushing the surface of the specimen with a coat of black paint, followed by a dusting of white paint to create a pattern as shown in Figure 4. This pattern was then monitored via a stereo set of cameras, calibrated and focused before testing. As the test progresses, the cameras continuously take images. The images are then correlated using the commercially available software VIC3D [12]. Deformations in the painted pattern are tracked from image to image creating a full field strain map for the painted area of the specimen. Figure 5 illustrates the measured strain field with the location of the detected AE events superimposed. The location of recorded events tracks the movement of the transformation front.

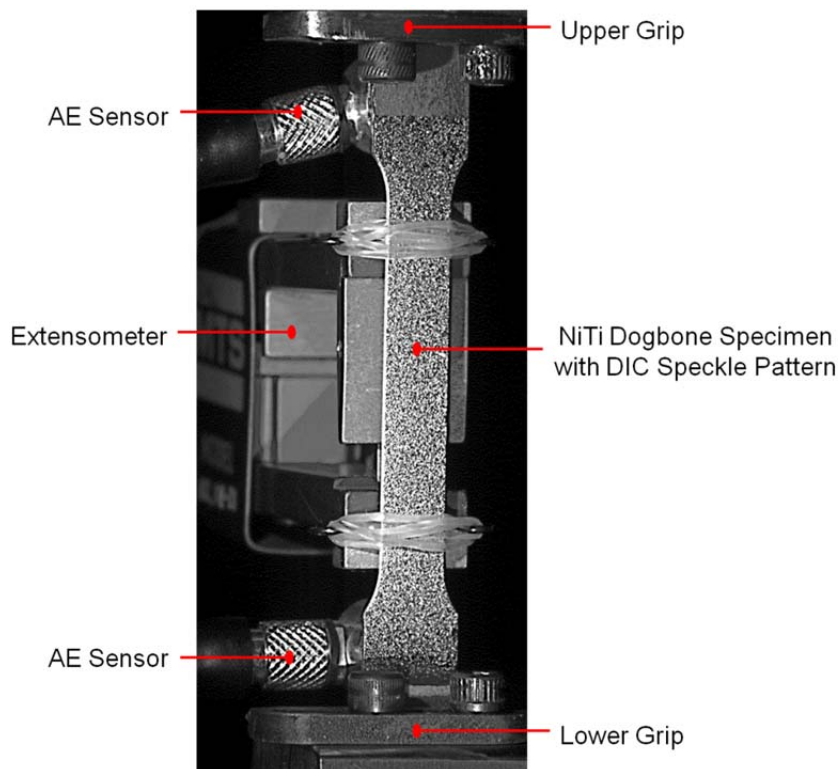

Figure 4: Illustration of the Ni-Ti tensile specimen with measurement devices annotated.

The amplitude of the acoustic emission was determined to be approximately 10 times greater than that of cracking in common aluminum alloys, significantly increasing the likelihood of crack detection. Although these bursts were detected, and occurred at the expected load levels, the AE energy should be increased to enhance signal detection. This can be achieved by using a different material composition for the sensory particles. Compositions that are expected to release more acoustic energy and provide other benefits are being identified for subsequent testing.

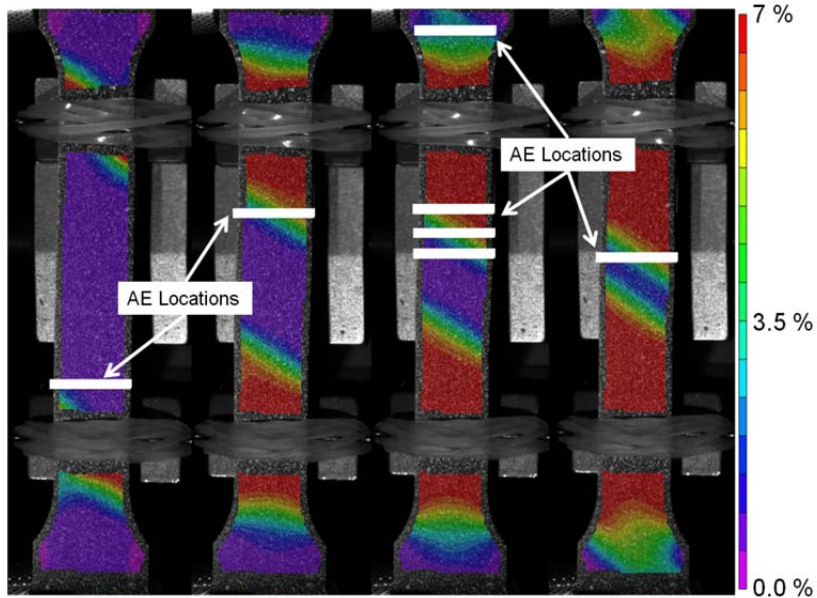

Figure 5: Measured principal strain fields at 4 load levels (increasing from left-to-right) and triangulated acoustic event locations (white boxes).

Embedded Sensory Particles Experiment

Since testing of the bulk specimens proved that transformation could be audibly detected, the next step in development was to test if transformation of embedded particles could also be detected. To this end, a specimen with embedded sensory particles was fabricated at NASA Langley Research Center (LaRC) utilizing vacuum hot press (VHP). Gas atomized shape memory alloy (SMA) particles were hot-pressed between two plates of aluminum alloy (AA) 7050 at 490°C. When cut orthogonal to the plane of the particles, the resulting specimens contained Ni-Ti surface particles along their centerline. These single edge notch (SEN) specimens were then cyclically loaded until a fatigue crack initiated and approached the particles. The specimen was then removed and prepared for strain mapping using in-situ DIC within a scanning electron microscope (SEM), Figure 6. Gupta *et al.* [13] describes in detail the speckle pattern application process and resolution.

Assessing Transformation of Embedded Particles

Once a crack had propagated up to a sensory particle, DIC was used to measure the strain during fatigue loading. These measurements quantified the strain within each embedded particle. By measuring the strain in and around each sensory particle, verification was made that the particles near the crack tip were transforming. By relating the measured particle strain to the applied load, a determination of the transformation strain could be made. This determination was readily made since there was a distinct change the load-strain slope, indicating a fundamental change in sensory material stiffness. The critical transformation strain was determined to be ~1%. Figure 7 illustrates the results of the DIC measurement (for the same sensory particles as in Figure 6), and shows that the sensory particles near the fatigue crack tip were nearly fully transformed under the applied load. In Figure 7, each point on the surface of the particle where strain was greater than 1% (i.e. purple contour fill) transformed.

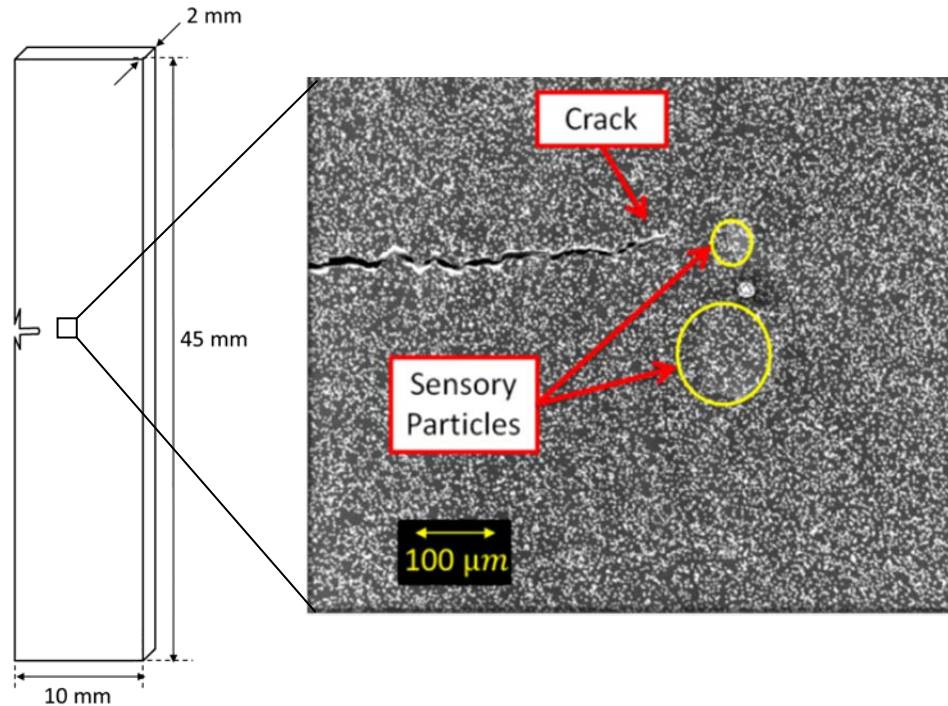

Figure 6: Illustration of embedded sensory particles near a growing crack. The black and white dots are the DIC speckle pattern.

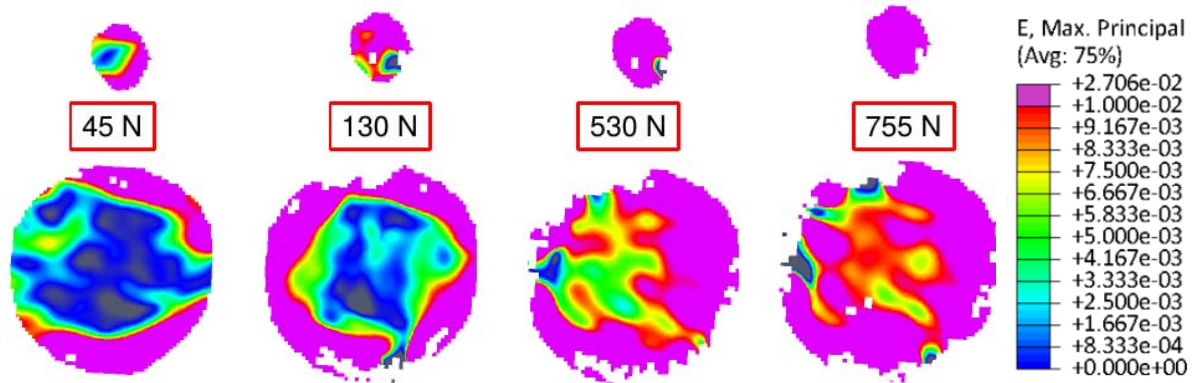

Figure 7: Measured strain in the near-crack-tip sensory particles. Regions colored with purple indicate transformed material.

Similar to the bulk tensile specimens discussed above, these embedded particle specimens also had the acoustic sensing system attached during loading. Acoustic signals were detected at the applied load values where the measured strain values indicated transformation was occurring. This provides a second verification that the particles transformed near the crack tip, and that they emit sufficient acoustic energy to be detected. For this configuration of crack size and its location with respect to neighboring sensory particles, transformation was detected to occur at a load level indicative of a severe overload cycle. Future work should include a reduction in the required transformation strain of the sensory particles, such that they could also detect cracks growing under high-cycle fatigue, where applied load amplitudes are reduced.

Modeling and Simulation of Embedded Particles

Once each specimen was fabricated, with particles embedded, X-ray computed tomography (CT) was used to determine the 3D geometry of each embedded particle, see Figure 8. These data were then used to generate a finite element model: a digital twin with the as-built geometry was instantiated. The digital twin models generated from x-ray CT were too large to simulate on a desktop or with commercially-available software, thus high-performance computing and a custom code was required. An explicit finite element software was written to employ Pleiades (a NASA Ames supercomputer) to carry out the simulations. The software was written in collaboration with The HDF Group for this seedling research. Several verification problems were tested successfully.

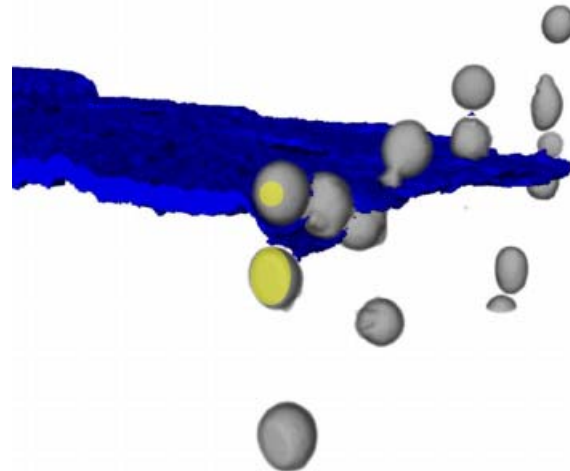

Figure 8: X-ray CT results showing embedded particles (gray) and the crack surface (blue).

The loads applied during testing were then used during simulation of the digital twin FEM and the evolution of strain fields and transformation within the sensory particles were computed. Figure 9 illustrates the simulated strain fields, which are in good agreement with the test data of Figure 7. It is seen in both measurement and simulation that sensory particles initially transform along their boundaries with remaining regions transforming at higher load. A computational study which provides the optimal sensory particle composition should be undertaken next.

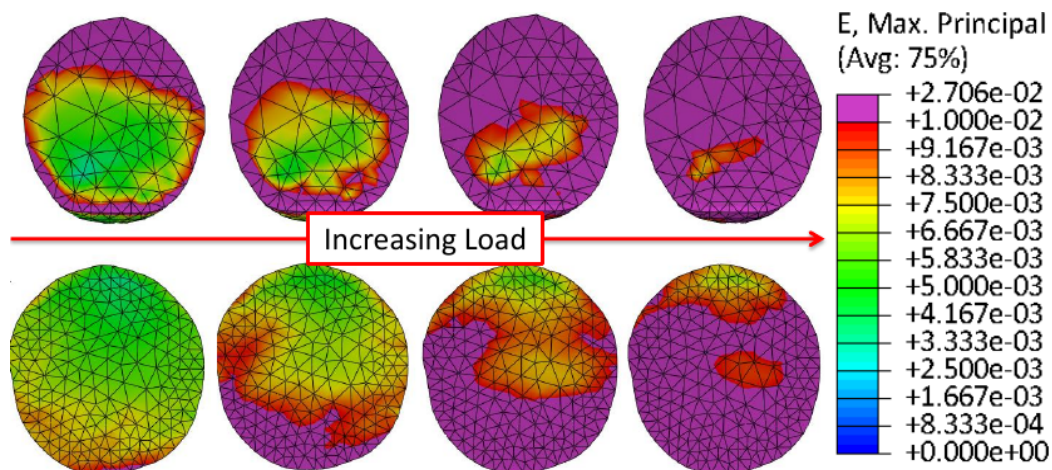

Figure 9: Digital twin finite element model with computed strain field in both sensory particles shown in Figures 3 and 4.

Concluding Remarks

The digital twin example presented herein is intended to be a simple first step to motivate adoption of the technique. The example presented simply shows that by incorporating the as-fabricated geometry of a specimen, along with over-the-counter software, predictions of behavior while in-service can be significantly improved. It is expected that incorporating real-time sensing of damage and Bayesian updating, this methodology will become increasingly accurate and cost effective. One major question that should be answered through future research is: How can the loads be measured in service, which are necessary to inform the digital twin?

The sensory alloy research illustrated several encouraging results. First, it was observed in the bulk tensile specimens of Ni-Ti that the location of transformation within the specimen could be triangulated using acoustic emission sensors. Second, Ni-Ti sensory particles were successfully embedded in a commonly-used aluminum alloy using standard fabrication techniques. Third, the transformation of the embedded sensory particles near a growing crack was detected using both strain measurements and acoustic emission sensing, which verified the overall concept. Finally, X-ray CT was used to replicate the as-build geometry of the specimen (including each embedded sensory particle), and subsequent finite element simulations successfully reproduced the observed strain fields at transformation. Future work for sensory particle development should include investigation of alternative sensory alloys and fabrication techniques. The next step for digital twin development should involve automating feedback of the acoustic emission events from the sensory particles to update its computational model.

Much research is still required for combining the digital twin concept with the sensory particles technology to address any shortcomings in the way aerospace vehicles are currently designed and managed. However, the direction of combining a methodology such as digital twin, with real-time damage detection is important and recognized in NASA aeronautics. One of NASA aeronautics three main research goals is to “maintain or improve safety of aircraft in an increasingly complex system.” The importance of this goal is exemplified in the Aviation Safety Program (AvSP). The AvSP lists the top ten technical challenges, of which 3 are directly addressed by the digital twin and sensory particle research proposed above: discovery of precursors to safety incidents; prognostic algorithm design for safety assurance; and maintaining vehicle safety between major inspections. The digital twin method will provide a capability to predict and prevent safety issues by constantly monitoring usage and simulating possible future damage states. In addition to coping with weather, traffic congestion, and other terrestrial or airborne security concerns already addressed by AvSP research, the digital twin and sensory particles concepts will provide pilots and controllers the ability to modify flight parameters due to unforeseen issues with structural integrity before and during flight.

References

- [1] Christodoulou L., Larsen J.M., “Using materials prognosis to maximize the utilization potential of complex mechanical systems,” JOM, 2004, vol. 56, pp. 15-19.
- [2] Lincoln J.W., “Damage-Tolerance – USAF Experience,” Proceedings of the 13th Symposium of the Int. Comm. on Aeronautical Fatigue, Pisa Italy, 1985, pp. 1-31.
- [3] Glaessgen E.H., Stargel D.S., “The digital twin paradigm for future NASA and U.S. Air Force Vehicles,” 53rd Struct. Dyn. Mater. Conf. Special Session: Digital Twin, Honolulu, HI, U.S., 2012, pp. 1-14.

- [4] Tuegel E.J., Ingraffea A.R., Eason T.G., Spottswood S.M., "Reengineering aircraft structural life prediction using a digital twin," *Int. J. Aerosp. Engr.*, 2011, pp. 1-14.
- [5] Pun G.P., Mishin Y., "Molecular dynamics simulation of the martensitic phase transformation in NiAl alloys," 2010, *J. of Phys.: Condensed Matter*, vol. 22., pp. 1-7.
- [6] Lindgren E. A., Knopp J. S., Aldrin J. C., Steffes G. J., Buynak C. F., "Aging aircraft NDE: capabilities, challenges, and opportunities," AFRL-ML-WP-TP-2006-497, 2006.
- [7] Duke J. C. Jr., Green R. E. Jr., "Simultaneous monitoring of acoustic emission and ultrasonic attenuation during fatigue of 7075 aluminum," *Int. J. Fat.*, 1979, vol. 1, pp. 125-132
- [8] Boyce B.L., Kramer S.L.B., Fang H.E., Cordova T.E., Neilsen M.K., Dion K., *et al.* "The Sandia fracture challenge: blind round robin predictions of ductile tearing," *Int. J. Fract.*, 2013, pp. 1-64.
- [9] Simulia, "Abaqus 6.11 user manual," Providence, RI, 2011.
- [10] Cerrone A., Hochhalter J.D., Heber G., Ingraffea A.R., "A usage case for digital twin," 2014, *IJAE*, *submitted for review*.
- [11] Digital Wave, <http://www.digitalwavecorp.com>, 2014.
- [12] Correlated Solutions, <http://www.correlatedsolutions.com>, 2014.
- [13] Gupta V.K., Willard S.A., Hochhalter J.D., Smith S.W., "Image correlation and EBSD-based study of crack tip and grain deformation in aluminum alloys," 2014, *ASTM Special Edition*, *submitted for review*.

| REPORT DOCUMENTATION PAGE | | | Form Approved OMB No. 0704-0188 | | |
|--|-------------|--|---|------------------------------|---|
| <p>The public reporting burden for this collection of information is estimated to average 1 hour per response, including the time for reviewing instructions, searching existing data sources, gathering and maintaining the data needed, and completing and reviewing the collection of information. Send comments regarding this burden estimate or any other aspect of this collection of information, including suggestions for reducing this burden, to Department of Defense, Washington Headquarters Services, Directorate for Information Operations and Reports (0704-0188), 1215 Jefferson Davis Highway, Suite 1204, Arlington, VA 22202-4302. Respondents should be aware that notwithstanding any other provision of law, no person shall be subject to any penalty for failing to comply with a collection of information if it does not display a currently valid OMB control number.</p> <p>PLEASE DO NOT RETURN YOUR FORM TO THE ABOVE ADDRESS.</p> | | | | | |
| 1. REPORT DATE (DD-MM-YYYY) 01-04-2014 | | 2. REPORT TYPE Technical Memorandum | | 3. DATES COVERED (From - To) | |
| 4. TITLE AND SUBTITLE Coupling Damage-Sensing Particles to the Digital Twin Concept | | | 5a. CONTRACT NUMBER | | |
| | | | 5b. GRANT NUMBER | | |
| | | | 5c. PROGRAM ELEMENT NUMBER | | |
| 6. AUTHOR(S) Hochhalter, Jacob D.; Leser, William P.; Newman, John A.; Glaessgen, Edward H.; Gupta, Vipul K.; Yamakov, Vesselin I.; Cornell, Stephen R.; Willard, Scott A.; Heber, Gerd | | | 5d. PROJECT NUMBER | | |
| | | | 5e. TASK NUMBER | | |
| | | | 5f. WORK UNIT NUMBER | | |
| 7. PERFORMING ORGANIZATION NAME(S) AND ADDRESS(ES) NASA Langley Research Center Hampton, VA 23681-2199 | | | 8. PERFORMING ORGANIZATION REPORT NUMBER L-20401 | | |
| 9. SPONSORING/MONITORING AGENCY NAME(S) AND ADDRESS(ES) National Aeronautics and Space Administration Washington, DC 20546-0001 | | | 10. SPONSOR/MONITOR'S ACRONYM(S) NASA | | |
| | | | 11. SPONSOR/MONITOR'S REPORT NUMBER(S) NASA-TM-2014-218257 | | |
| 12. DISTRIBUTION/AVAILABILITY STATEMENT Unclassified - Unlimited Subject Category 01 Availability: NASA CASI (443) 757-5802 | | | | | |
| 13. SUPPLEMENTARY NOTES | | | | | |
| 14. ABSTRACT The research presented herein is a first step toward integrating two emerging structural health management paradigms: digital twin and sensory materials. Digital twin is an emerging life management and certification paradigm whereby models and simulations consist of as-built vehicle state, as-experienced loads and environments, and other vehicle-specific history to enable high-fidelity modeling of individual aerospace vehicles throughout their service lives. The digital twin concept spans many disciplines, and an extensive study on the full domain is out of the scope of this study. Therefore, as it pertains to the digital twin, this research focused on one major concept: modeling specifically the as-manufactured geometry of a component and its microstructure (to the degree possible). The second aspect of this research was to develop the concept of sensory materials such that they can be employed within the digital twin framework. Sensory materials are shape-memory alloys that undergo an audible phase transformation while experiencing sufficient strain. Upon embedding sensory materials with a structural alloy, this audible transformation helps improve the reliability of crack detection especially at the early stages of crack growth. By combining these two early-stage technologies, an automated approach to evidence-based inspection and maintenance of aerospace vehicles is sought. | | | | | |
| 15. SUBJECT TERMS Aerospace vehicles; Cracks; Digital twin; Fatigue; Sensory materials; Shape memory alloys | | | | | |
| 16. SECURITY CLASSIFICATION OF: | | | 17. LIMITATION OF ABSTRACT | 18. NUMBER OF PAGES | 19a. NAME OF RESPONSIBLE PERSON |
| a. REPORT | b. ABSTRACT | c. THIS PAGE | | | STI Help Desk (email: help@sti.nasa.gov) |
| U | U | U | UU | 15 | 19b. TELEPHONE NUMBER (Include area code) (443) 757-5802 |