



Current Status of Hybrid Bearing Damage Detection

Paula J. Dempsey
Glenn Research Center, Cleveland, Ohio

Joseph M. Certo
U.S. Army Research Laboratory, Glenn Research Center, Cleveland, Ohio

Wilfredo Morales
Glenn Research Center, Cleveland, Ohio

The NASA STI Program Office . . . in Profile

Since its founding, NASA has been dedicated to the advancement of aeronautics and space science. The NASA Scientific and Technical Information (STI) Program Office plays a key part in helping NASA maintain this important role.

The NASA STI Program Office is operated by Langley Research Center, the Lead Center for NASA's scientific and technical information. The NASA STI Program Office provides access to the NASA STI Database, the largest collection of aeronautical and space science STI in the world. The Program Office is also NASA's institutional mechanism for disseminating the results of its research and development activities. These results are published by NASA in the NASA STI Report Series, which includes the following report types:

- **TECHNICAL PUBLICATION.** Reports of completed research or a major significant phase of research that present the results of NASA programs and include extensive data or theoretical analysis. Includes compilations of significant scientific and technical data and information deemed to be of continuing reference value. NASA's counterpart of peer-reviewed formal professional papers but has less stringent limitations on manuscript length and extent of graphic presentations.
- **TECHNICAL MEMORANDUM.** Scientific and technical findings that are preliminary or of specialized interest, e.g., quick release reports, working papers, and bibliographies that contain minimal annotation. Does not contain extensive analysis.
- **CONTRACTOR REPORT.** Scientific and technical findings by NASA-sponsored contractors and grantees.

- **CONFERENCE PUBLICATION.** Collected papers from scientific and technical conferences, symposia, seminars, or other meetings sponsored or cosponsored by NASA.
- **SPECIAL PUBLICATION.** Scientific, technical, or historical information from NASA programs, projects, and missions, often concerned with subjects having substantial public interest.
- **TECHNICAL TRANSLATION.** English-language translations of foreign scientific and technical material pertinent to NASA's mission.

Specialized services that complement the STI Program Office's diverse offerings include creating custom thesauri, building customized databases, organizing and publishing research results . . . even providing videos.

For more information about the NASA STI Program Office, see the following:

- Access the NASA STI Program Home Page at <http://www.sti.nasa.gov>
- E-mail your question via the Internet to help@sti.nasa.gov
- Fax your question to the NASA Access Help Desk at 301-621-0134
- Telephone the NASA Access Help Desk at 301-621-0390
- Write to:
NASA Access Help Desk
NASA Center for Aerospace Information
7121 Standard Drive
Hanover, MD 21076



Current Status of Hybrid Bearing Damage Detection

Paula J. Dempsey
Glenn Research Center, Cleveland, Ohio

Joseph M. Certo
U.S. Army Research Laboratory, Glenn Research Center, Cleveland, Ohio

Wilfredo Morales
Glenn Research Center, Cleveland, Ohio

Prepared for the
2004 Annual Meeting and Exhibition
sponsored by the Society of Tribologists and Lubrication Engineers
Toronto, Canada, May 17-20, 2004

National Aeronautics and
Space Administration

Glenn Research Center

Available from

NASA Center for Aerospace Information
7121 Standard Drive
Hanover, MD 21076

National Technical Information Service
5285 Port Royal Road
Springfield, VA 22100

Available electronically at <http://gltrs.grc.nasa.gov>

Current Status of Hybrid Bearing Damage Detection

Paula J. Dempsey
National Aeronautics and Space Administration
Glenn Research Center
Cleveland, Ohio 44135
E-mail: paula.j.dempsey@nasa.gov

Joseph M. Certo
U.S. Army Research Laboratory
National Aeronautics and Space Administration
Glenn Research Center
Cleveland, Ohio 44135
E-mail: joseph.m.certo@grc.nasa.gov

Wilfredo Morales
National Aeronautics and Space Administration
Glenn Research Center
Cleveland, Ohio 44135
E-mail: wilfredo.morales@nasa.gov

Summary

Advances in material development and processing have led to the introduction of ceramic hybrid bearings for many applications. The introduction of silicon nitride hybrid bearings into the high pressure oxidizer turbopump, on the space shuttle main engine, led NASA to solve a highly persistent and troublesome bearing problem. Hybrid bearings consist of ceramic balls and steel races. The majority of hybrid bearings utilize Si_3N_4 balls. The aerospace industry is currently studying the use of hybrid bearings and naturally the failure modes of these bearings become an issue in light of the limited data available.

In today's turbine engines and helicopter transmissions, the health of the bearings is detected by the properties of the debris found in the lubrication line when damage begins to occur. Current oil debris sensor technology relies on the magnetic properties of the debris to detect damage. Since the ceramic rolling elements of hybrid bearings have no metallic properties, a new sensing system must be developed to indicate the system health if ceramic components are to be safely implemented in aerospace applications. The ceramic oil debris sensor must be capable of detecting ceramic and metallic component damage with sufficient reliability and forewarning to prevent a catastrophic failure.

The objective of this research is to provide a background summary on what is currently known about hybrid bearing failure modes and to report preliminary results on the detection of silicon nitride debris, in oil, using a commercial particle counter.

Introduction

As NASA's lead center for aerospace propulsion and power, Glenn Research Center develops critical technologies for all aspects of advanced turbomachinery, including advanced health maintenance for propulsion systems. The Mechanical Components Branch at Glenn performs research for health monitoring and diagnostics of drive systems and aircraft engines.

Rolling element bearings are critical components in rotating machinery. Silicon nitride hybrid bearings, consisting of ceramic balls and metal races, are beginning to replace conventional bearings in

special applications. Two reasons for this transition are that silicon nitride balls are about 30 percent harder and 40 percent lighter than steel. In addition, they have high wear resistance and greater corrosion resistance compared to steel balls. It is interesting to note that one of the main reasons for the initial development of silicon nitride some 30 thirty years ago was to replace metal with ceramics for future gas turbine and reciprocating engines. The engineer's "holy grail" of an all ceramic, oil-free engine has not been achieved, but that research has led to a number of other applications in both the industrial and aerospace industries.

In today's turbine engines and helicopter transmissions, the health of the bearings is most often detected by the presence of debris found in the lubrication line when component damage begins to occur. Vibration data is also used to indicate the health of the bearing by monitoring the fundamental defect frequencies of the rolling element bearings such as the fundamental cage frequency, ball pass frequencies of the inner and outer race, and the ball spin frequency [1]. Several types of oil debris sensors exist for detecting metallic bearing debris [2]. Plug-type chip detectors, the most common oil debris sensor, consists of a magnetic plug fitted with electrical contacts in which debris forms an electrical bridge between the contacts, causing the state of an indicator to change. Inductance type, on-line debris sensors measure debris size and count particles based on disturbances of a magnetic field caused by passage of a metallic particle.

Current oil debris sensor technology for aerospace applications relies on the metallic properties of the debris to detect damage. Since ceramic rolling elements debris has different properties, a new sensing system is needed to indicate the system health if ceramic components are to be safely implemented in the aerospace community. The ceramic debris sensor must be capable of indicating component damage with sufficient reliability and forewarning to prevent a catastrophic failure.

Extensive resources have been invested in ceramic material development for use in new aerospace applications such as hybrid bearings. Diagnostic tools are required to decrease maintenance costs and improve safety of this enabling technology. Lack of diagnostics for ceramic/hybrid bearings is a barrier to the widespread deployment of this technology. If reliable sensing diagnostic tools are not developed to indicate ceramic component health, ceramic components will have limited benefit to the aerospace industry.

Development of a reliable, on-line sensing system for detecting damage to aerospace bearings is one goal of the Mechanical Components Branch. Future hybrid bearings will be a combination of ceramic and metallic components. For this reason, the health monitoring system may require the integration of two measurement technologies to indicate damage. Sensor fusion techniques have been developed integrating oil debris and vibration based component damage detection techniques into intelligent health monitoring systems for gears and bearings with improved detection and decision-making capabilities. Applying multi-sensor data fusion techniques to detect hybrid bearing damage is a logical extension of this approach.

Background

In order to identify a diagnostic tool for component damage, the failure mechanism under investigation must be defined. Unfortunately, limited published data exists on the failure progression of state-of-the-art ceramic hybrid bearings. Failure progression published data were reviewed to determine if ceramic and/or metallic debris are generated during hybrid bearing failures (ceramic balls, metal races).

Results of a literature search of hybrid bearings applications will be discussed. Table 1, taken from reference [3], compares the properties of silicon nitride and bearing steel. The properties of silicon nitride shown differ from the steel. The advantages cited for using hybrid bearings to improve turbine engine performance include reduced skidding due to changes in rotational speed, reduced friction and heat generation, a larger range of bearing operating temperatures, increased bearing stiffness, improved

operating life under poor lubricating conditions, and reduced contact stress in the outer ring due to lower density rolling elements [4].

Although limited data is available from full scale engine tests with hybrid bearings, wear mechanisms of silicon nitride have been studied in a lab environment. Silicon nitride wear mechanisms in sliding and rolling contact, studied by Chao et al. [5], identified three basic wear mechanisms. The first, oxidation-tribochemical wear, is due to a tribochemical reaction with H₂O in a humid environment. The coefficient of friction and wear rate was reduced by moisture. Additives in the lubrication may also have different reactions and result in different antiwear functions. The second, plastic deformation, is the wear mechanism due to a change in morphology of the surface due to a change volume. The third, microfracture is due to localized fracture due to fracture of one or more grains.

The literature also identifies common failure modes of the silicon nitride rolling elements. Chao [5] identified spalling, similar to bearing steels, as the most common mode of failure. Galbato [6] observed silicon nitride ball failure due to spalling. Ebert [7] observed similar failure phenomena with steel and ceramic materials. Burrier [8] observed degradation of the bearing in the form of micro-spalling of the steel race surfaces. Yoshida et al. [9] also investigated rolling contact fatigue characteristics of ceramic rollers and observed spalling failures.

Duffy [10] performed nine tests using conventional ball bearing endurance rigs. Bearing failures were detected by accelerometers on the load arm and housing. Of the nine tests performed, 4 failed due to inner race spalls, 3 failed due to outer race spalls, 1 had both inner and outer races spalls, and 1 ball failure. Hybrid bearing spalls occurred on edges of the ball tracks, as compared to steel bearings that occur in the center of the running track.

O'Brien et al. [11] investigated rolling element fatigue life of hybrid bearings consisting of Si₃N₄ balls, REX20 steel inner races and CRU20 outer races. Bearing dimensions were 72 mm outer diameter, 35 mm inner bore diameter, with a ball width of 11.906 mm. The bearings were thrust loaded at 5400 rpm, and lubricated with MIL-L-7808 oil, 1.88 GPA Hertzian stress. Six groups were tested with 4 bearings in each group. All of the 6 groups of 4 hybrid bearings exceeded 2600 hr of testing. Four groups of hybrid bearings were then tested at 2.29 GPA. Of the 4 test groups, 3 bearings failed at 1548, 3408, and 3441 hr due to ball failures, the fourth bearing failed at 2550 hr due to inner race failure. Ball failures were identified as spalls (5 mm) observed on the balls.

Rhoads and Bashyam [12] compared hybrid bearings to all steel bearings operating under severe shock loading conditions for turbine engine applications. They found failure mode and time to failure similar for both hybrid and AISI M50 steel balls. During one of the induced defect tests, metallic and nonmetallic debris were collected from both the M50Nil steel rings and the silicon nitride balls. Several of the silicon nitride chips were large enough to be caught in a 400 micron screen: 80 by 160 and 150 by 400 microns. They also found a large amount of metallic debris was generated, indicating oil debris analysis based on detection of the metallic properties of the debris generated by the failing component may still be used to detect some failures.

After reviewing several papers on hybrid bearing failure characteristics, it can be concluded that debris produced by fatigue failures of hybrid bearings are similar to conventional bearings. Additional data is required to identify other failure mechanisms. The next step is to determine if diagnostic tools used for conventional bearings can detect damage to hybrid bearings.

Ohtu and Satake [13] compared vibration characteristics of all ceramic with hybrid and conventional steel ball bearings. They tested 3 samples of each type of bearing and used kerosene as the lubricant. Looking at the overall vibration velocity in decibels, they measured the lowest vibration signal on the all ceramic bearing, and the highest on the hybrid bearing. They also found vibration levels increased with speed, but did not change significantly with axial loads for all 3 types of bearings.

Takebayashi [14] compared the rolling fatigue life of steel, hybrid, and all ceramic bearings. Vibration was used as the diagnostic tool to indicate bearing fatigue damage. Similar to other cited references, he found damage to all ceramic and hybrid ceramic bearings due to contact fatigue was identical to that of the rolling contact fatigue. This damage was flaking observed in the bearing steel,

and was picked up by vibration. When vibration reached 2X starting level, test equipment was automatically shutdown.

Rhoads and Bashyam [12] reviewed sensor technologies that could detect both magnetic and nonmagnetic debris. They evaluated different measurement technologies for ceramic chip detection using the following criteria: cost; reliability, full-flow and on-line operation; real time data detection; detect debris larger than 200 microns; detect a minimum of 10 chips; commercially available; and ability to detect metallic and nonmetallic debris. Using the results of this analysis, they combined an ultrasonic pulse echo sensor with a full-flow debris retention screen and an infrared photoelectric sensor with a full-flow debris retention screen. They found both sensors can detect magnetic and non magnetic debris, but a similar response of the sensor due to entrained air limits both techniques. They also found a commercially available vibration sensing system can detect outer ring, cage, and rolling element defects on the hybrid bearings.

Another sensor that has recently been developed detects and monitors increased levels of electrostatic charge produced as a result of machinery component deterioration. This oil line sensor is capable of detecting non-metallic particulate and wear debris [15]. However, this sensor is expensive since it is currently in the R&D phase. This analysis is limited to commercially available sensors that are relatively inexpensive (<\$1000).

Description of Sensors

The first sensor considered was a commercially available capacitance sensor used to detect the deterioration of lubricants in automobile engines. The sensor measures the change in the dielectric constant of the oil as the oil quality decreases with use. The sensor also incorporates temperature compensation to remove the effect of change in capacitance due to change in temperature. Preliminary results indicated the temperature compensation in the sensor had to be redesigned for this application. Until this is done, the sensor cannot be used for this application, or for testing the oil quality of a system in which the oil temperature varies.

The second sensor tested was a commercially available optical particle counter. This sensor measures the amount of light blocked by the particle, detected by a photodiode and translated into an output signal in which the frequency and amplitude is proportional to particle size and particle concentration. The light source for the sensor is a laser diode [16, 17]. A description of the sensor operation is shown in Figure 1.

The sensor counts particle concentration in microns/milliliter and sizes the debris that blocks the light in four size ranges: >4, >6, >14, and >21 $\mu\text{m}/\text{mL}$. Note that that the sizes are “greater than.” The >4 $\mu\text{m}/\text{mL}$ size range will always measure the maximum number of particles because it includes the counts measured in the 3 larger sizes. The >6 $\mu\text{m}/\text{mL}$ size range counts includes the counts measured in the >14 and >21 $\mu\text{m}/\text{mL}$ size ranges. The maximum particle size the sensor can measure is 1 mm due to the size of the flow cell. The maximum particle concentration the sensor can measure is 2.5 million counts/mL, in the >4 $\mu\text{m}/\text{mL}$ size range. However, the sensor can produce false counts due to water droplets and entrained air bubbles if they block the light [18]. The particle counter accuracy is limited by false counts due to water droplets and air bubbles, extremely dark fluids, or high particulate contamination levels that cause several particles to be in the light path at the same time [19].

Particle counters measure the number of particle counts per volume of the oil sample in a specified time period. The particle concentration for a volume sampled by the sensor is affected by flow. Particle counters require some form of flow control device. Since temperature affects oil viscosity, changing flow rates and temperatures should also be monitored.

The sensor investigated for this analysis can be used for in-line flow applications. The sensor has an internal check valve to divert flow from a varying pressure/flow system. A cross section of the particle counter showing the flow diverted is shown in Figure 2. The sensor has a flow control device that creates a constant pressure drop and diverts a portion of the flow through the sensor and is compensated for in the

particle concentration measurement. Although this sensor is in the main supply line, only a small portion of the total oil flow volume is measured by the sensor. The sensor measures a flow index, a non-dimensional number used to verify fluid is passing through the sensor, with no blockage due to large particles. This flow index is not proportional to system flow, and variations in flow index are compensated for in the counts/mL measurement. The sensor will indicate an error if the flow index is not within 40 to 350. Additional details of the flow index are proprietary to the manufacturer [20]. The sensor viscosity specifications are 2 cSt and greater.

In addition to the flow index, the sensor also measures and checks that the following parameters are within the required range: sensor received power 4.70 to 4.90 VDC; laser drive current 30 to 62 mA; sensor system temperature -20 to 80 °C. If these parameters are not within range, an error occurs and is indicated by the sensor.

Test Procedure

Tests were performed to evaluate an inexpensive ($< \$1000$), commercially available sensor in the Oil Debris Sensor Flow Test Rig. A photo of the rig is shown in Figure 3. The rig is a closed loop, consisting of a reservoir and variable speed peristaltic pump. A peristaltic pump was used to limit contamination of the pump with the debris, since the pumped liquid is completely isolated from all moving parts of the pump. A flexible tube is pressed by a set of rollers and an even flow is produced by this squeezing action. A filter installed in the line was bypassed during all the tests.

Flow was approximately 1.9 liters/min during all tests. The volume of oil in the test rig reservoir and piping for this test was 3.75 liters. The oil used was a turbine engine oil equivalent to Mobil Jet Oil II.

For this experiment, five silicon nitride particle samples were prepared. The samples were separated into 2 size ranges using U.S.A. Standard Test Sieves and weighed. Table 2 describes the samples. Sample one consisted of samples that passed through the < 20 micron sieve. The other 4 samples passed through the 53 microns sieve, but were too large to pass through the > 20 sieve. Note that samples could contain large size particles if debris particle length was larger than width. Sensor data was recorded every 90 sec which is user selected based on a 60 sec sample volume period and a 30 sec hold time. Note that a new reading was taken every 90 sec, recorded sensor counts/mL do not accumulate. Also note that the sample period can affect the sensitivity of the sensor to measure low concentrations of particles. If particle concentration of < 10 counts/mL is expected, increase the sample period to 2 min. Since the filter was not in the line during these tests, and the flow rate was low, the particle concentration should not vary significantly during tests. The sample was mixed with oil and injected in approximately 10 sec. The injector is labeled in Figure 3. The particle then passes through the pump before reaching the sensor. Based on the flow and oil volume, it would take approximately 2 min for the entire oil volume to be re-circulated through the sensor. However, only a portion of the oil is bypassed through the sensor, and oil flow does not equal particle flow. During all the injection experiments, the test rig ran for several hours before a sample was injected, then several hours after injection. The oil was not changed for each experiment. All 5 experiments were run with the same oil in the system over a 3 week period.

Results and Discussion

Figure 4 shows the particles measured by the particle counter in the 4 particle concentration size ranges plotted on a logarithmic scale. The flow ran for several hours prior to injecting silicon nitride debris. The 2 dashed lines indicate when sample 1 and sample 2 silicon nitride particles were injected. Sample 1 was injected first. When the particles are initially injected, a spike occurs in the measured counts/mL in all the size ranges, and in the flow index then stabilizes. Slight increases were also observed in the > 4 microns size range that correlated with slight increases in the flow index, indicating possibly a

particle cluster increasing counts before releasing. From the data, the average particle counts in each size range measured by the sensor increased when the particles were injected. At sizes below 6 microns, significantly more particles were observed during injection of the first sample which contained on average debris of smaller size relative to sample 2. During injection of sample 2, the change in particle concentration measured in the 6, 15, and 21 size ranges was larger than when the first sample was injected. This was qualitatively correct. The fluid temperature, and therefore sensor temperature during this experiment increased from 22 to 28 °C. The flow index varied from 100 to 149. An estimate of the counts due to injection can be made by multiplying the counts/ml change by the system volume. An estimate of the mass of the particle concentration requires the density of the material, and volume of the particles. Although, one can assume the particle is shaped like a sphere, an estimate of the diameter of the particle could vary significantly because the sensor measures particles greater than a specific range, not within a range. For this reason, mass was not estimated.

The flow rig was run another 7 hr, and then the third sample was injected. Data from this experiment is shown in Figure 5. The dashed line indicates when the sample was injected. Note the initial count reading decreased after running for several hours after experiment 1, even though no filter was in the line. This drop in counts/mL was also observed between the next two experiments. Particles must be getting trapped in the reservoir and tubing prior to measurement by the sensor. However, the particle concentration never dropped to the baseline values shown in Figure 4 prior to sample 1 debris injection for the 4 and 6 micron size ranges. Flow index fluctuations did not occur during this test, although the flow steadily decreased during testing. The sensor temperature during this experiment increased from 32 to 36 °C and flow index varied from 121 to 158 during testing. Samples 4 and 5 were injected and are plotted in Figures 6 and 7. The dashed line indicates when the sample was injected on both figures. The sensor temperatures increased from 30 to 36 °C over the duration of the experiment for sample 4 injection, and increased from 30 to 37 °C during sample 5 injection. Flow index varied from 117 to 151 during sample 4 injection, and varied from 117 to 150 during sample 5 injection.

Several observations were made from the data collected during these 4 experiments. The $>4\mu\text{m}$ concentration size indicates the largest particle concentration increase during the every sample injection. This makes sense since all the particles injected were $>4\mu\text{m}$. All size ranges showed an initial increase when the samples were injected, but the >14 and $>21\mu\text{m}$ slowly decrease to pre-injection counts/mL, where the >4 and $>6\mu\text{m}$ maintain the increase after hours of operation. Between each injection experiment, the rig was shutdown, then run for several hours. The initial count reading decreased from the last reading during the previous experiment, indicating the particles were possibly trapped in the line, or settled to the bottom of the reservoir. This may also be due to the low oil flow and the small amount of oil that is diverted through the sensor. For aircraft applications, it is likely that for the larger debris sizes, the debris would pass-by the sensor only one time, and then be trapped in the filter. Additional tests are required on other rigs to further investigate schemes for establishing thresholds to indicate normal operation versus operation with a degrading ceramic component. One interesting thing to note is that the particles measured in this rig represent the particles measured in an aero application. A study conducted by Bensch [21] sampled 44 different machines for particle contamination. Particle counts from aircraft were extrapolated for $5\mu\text{m}$ size, and found 2500 particles at $>5\mu\text{m}$ and 320 particles at $>15\mu\text{m}$ for typical contamination levels of aircraft. The numbers of particles detected during these tests are within this range indicating this type of data would be observed in an aircraft system.

Conclusion

Oil debris sensors were investigated to determine their use in detection of hybrid bearing fatigue damage. Prior to experimentally testing sensors for this application, the failure mechanism for hybrid bearings was researched via a literature search. Next, a simple oil flow rig was designed for performance testing oil debris sensors. The sensors were selected based on commercial availability and low cost. The

capacitance type sensor would not perform in the rig due to temperature compensation problems, and was not further tested. Samples of silicon nitride particles were injected into the oil line to determine if an optical sensor can respond to this type of oil debris. The sensor responded qualitatively when silicon nitride debris was injected. During injection of the first sample (<20 microns), significantly more particles were observed in sizes below 6 microns. During injection of the second sample (>20 <53 microns) sample which contained on average debris of larger size relative to sample 1 the change in particle concentration measured in the 6, 15, and 21 microns size ranges was larger than when the first sample was injected. The sensor indicated an increase in particle concentration during injection of all 5 samples. Damage limits could be set based on a change from the normal baseline. Further testing is required to verify the affect of filtration on flow and sample rates.

References

1. Crawford, A.R. and Crawford, S. (1992), *The Simplified Handbook of Vibration Analysis: Volume 1: Introduction to Vibration Analysis Fundamentals*. Computational Systems, Inc.
2. Hunt, T.M. (1993), *Handbook of Wear Debris Analysis and Particle Detection in Fluids*, Elsevier Science Publishers Ltd., London.
3. Niizeki, Shin (2000), "Ceramic Bearings for Special Environments," *Motion and Control*, No. 8.
4. Warrior, S.G., Jarmon, D.C. and Chin, H.A. (2000), "Finite Element Analysis of the Critical Flaw Size in Hybrid Silicon Nitride Bearing Ball," in *Proc. Of the ASME Turbo Expo 2000*, May 8-11, 2000, Munich, Germany.
5. Chao, L.-Y., Shetty, D.K., Adair, J.H. and Mecholsky, Jr., J.J., (1995), "Development of Silicon Nitride for Rolling Contact Bearing Applications: A Review," *Journal of Materials Education*, volume 17, pp. 245–303.
6. Galbato, A.T., Cundill, R.T., Harris, T.A. (1992), "Fatigue Life of Silicon Nitride Balls," *Lubrication Engineering*, Nov., pp. 886–894.
7. Ebert, F.J. (1990), "Performance of Silicon Nitride Components in Aerospace Bearing Applications," *ASME 90-GT-166*.
8. Burrier, H.I. and Burk, C. (1995), "Ceramic Bearing Development. Volume 1, Fatigue and Wear Behavior of NBD-200 Silicon Nitride Balls," WL-TR-96-4015, Wright Patterson AFB, OH.
9. Yoshida, A., Nagamori, K., Haishi, H. and Fujii, M. (1989), "Rolling Contact Fatigue Characteristics of Fine Ceramics," *Proc. of the 5th International Congress on Tribology*, June 12–15, Espoo, Finland, vol. 4, pp. 54–59.
10. Duffy, Paul (1991), "Exploratory Testing and Analysis of Full Ceramic Ball Bearings," *Proc. of the International Off-Highway & Powerplant Congress and Exposition*, Milwaukee, WI, September 9–12, 1991, SAE Technical Paper Series 911800.
11. O'Brien, M.J., Presser, N., and Robinson, E.Y. (2003), "Failure Analysis of Three Si₃N₄ Balls Used in Hybrid Bearings," *Engineering Failure Analysis*, vol. 10, issue 4, pp. 453–473.
12. Rhoads, M. and Bashyam, M. (1994), "Engine Hybrid Ceramic Bearings," WL-TR-95-4081, Wright Patterson AFB, OH.
13. Ohtu, H. and Satake, S. (2002), "Vibrations of the All-Ceramic Ball Bearing," *Transactions of ASME*, July, vol. 124.
14. Takebayashi, H. (2001), "Bearings for Extreme Environments-Part 3, Basic Performance of Ceramic (Silicon Nitride) Bearings," *KOYO Engineering Journal English Edition*, No. 158E.
15. Powrie, H., Wood, R., Harvey, T., Wang, L., and Morris, S. (2002), "Electrostatic Charge Generation Associated with Machinery Component Deterioration," *Proc. of the 2002 Aerospace Conference*, March 9–16, Big Sky, MT, vol. 6.
16. Rossi, P. and Young, K. A. (2000), "HIAC's Low Cost Online Contamination/Condition Monitor," *Practicing Oil Analysis Magazine*, October.

17. Rossi, P. and Young, K.A. (2001), "An Online Particle Counter as a CBM-Enabling Technology," http://www.particle.com/whitepapers_hiac/PM4000_CBM.htm
18. Williamson, Martin (2002), "The Low-Down on Particle Counters," *Practicing Oil Analysis Magazine*, July.
19. Hayzen, T., Garvey, R., Lin, M.C., and Mountain, J. (1999), "Contamination Control Requires Particle Count and Size Distribution," *Computational Systems Incorporated*. <http://www.compsys.com>, DoctorKnow® Application Paper.
20. HIAC (2002), *HIAC Model PM4000 Owners Manual*, Part Number 701213, Revision D, Pacific Scientific Instruments, Grants Pass, OR, 97526-8882.
21. Bensch, L.E. (1992), A Modern Review of Field Contamination Levels Based on Analyses of 25,000 Samples, *Proc. of the International Fluid Power Exposition and Technical Conference*, March 24-26, 1992. http://www.particle.com/whitepapers_hiac/benscha.htm

Table 1.—Comparison of silicon nitride properties and steel properties [3]

Property	Silicon nitride	Bearing steel AISI 52100
Density (g/cm ³)	3.2	7.8
Hardness (Hv)	1600	700
Elastic modulus (GPa)	310	210
Thermal expansion coefficient (10 ⁻⁶ /°C)	2.8	12.5

Table 2.—Sizes and weights of injected samples

Sample	Sieve Size (microns)	Weight (mg)
1	< 20	9.8
2	>20 <53	5.1
3	>20 <53	5.5
4	>20 < 53	5.4
5	>20 <53	5.3

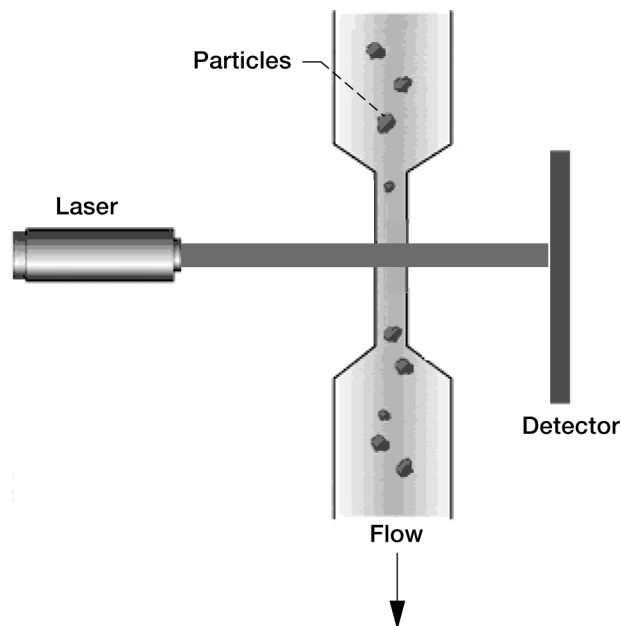

Figure 1.—Particle counter [18].

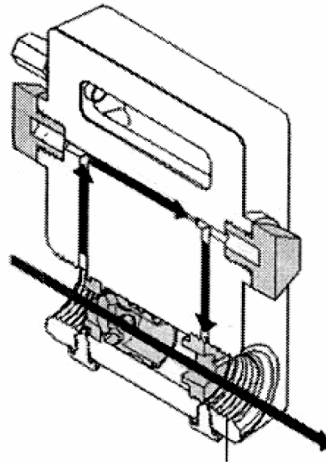

Figure 2.—Particle counter cross section [20].

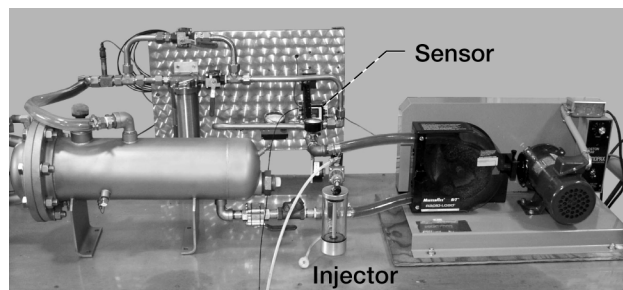

Figure 3.—Oil debris sensor flow test rig.

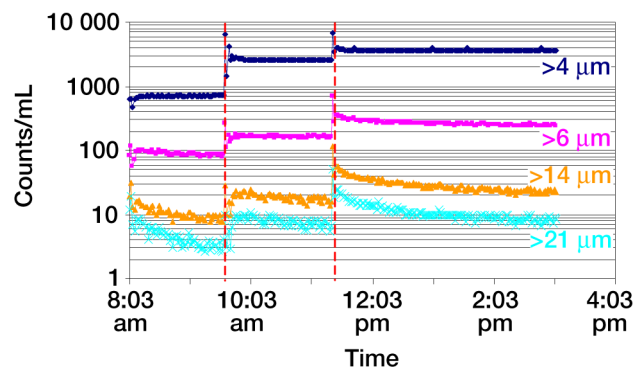

Figure 4.—Particle counter data with samples 1 and 2 injected.

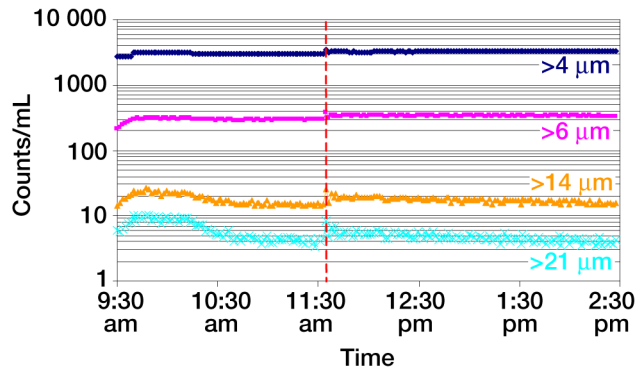

Figure 5.—Particle counter data with sample 3 injected.

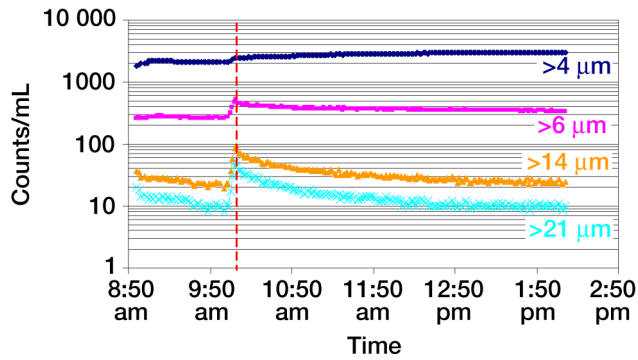

Figure 6.— Particle counter data with sample 4 injected.

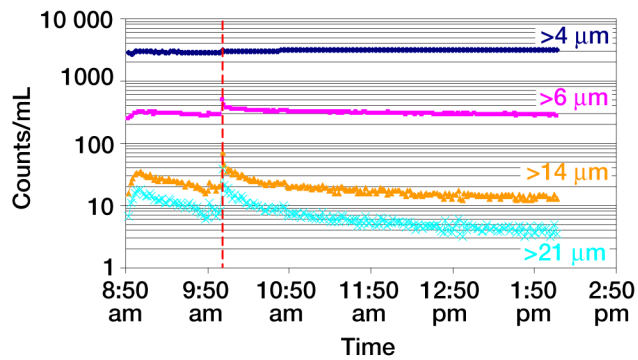

Figure 7.— Particle counter data with sample 5 injected.

REPORT DOCUMENTATION PAGE

Form Approved
OMB No. 0704-0188

Public reporting burden for this collection of information is estimated to average 1 hour per response, including the time for reviewing instructions, searching existing data sources, gathering and maintaining the data needed, and completing and reviewing the collection of information. Send comments regarding this burden estimate or any other aspect of this collection of information, including suggestions for reducing this burden, to Washington Headquarters Services, Directorate for Information Operations and Reports, 1215 Jefferson Davis Highway, Suite 1204, Arlington, VA 22202-4302, and to the Office of Management and Budget, Paperwork Reduction Project (0704-0188), Washington, DC 20503.

1. AGENCY USE ONLY (<i>Leave blank</i>)		2. REPORT DATE June 2004	3. REPORT TYPE AND DATES COVERED Technical Memorandum	
4. TITLE AND SUBTITLE Current Status of Hybrid Bearing Damage Detection			5. FUNDING NUMBERS WBS-22-704-01-03 1L162211A47A	
6. AUTHOR(S) Paula J. Dempsey, Joseph M. Certo, and Wilfredo Morales				
7. PERFORMING ORGANIZATION NAME(S) AND ADDRESS(ES) National Aeronautics and Space Administration John H. Glenn Research Center at Lewis Field Cleveland, Ohio 44135-3191			8. PERFORMING ORGANIZATION REPORT NUMBER E-14296	
9. SPONSORING/MONITORING AGENCY NAME(S) AND ADDRESS(ES) National Aeronautics and Space Administration Washington, DC 20546-0001 and U.S. Army Research Laboratory Adelphi, Maryland 20783-1145			10. SPONSORING/MONITORING AGENCY REPORT NUMBER NASA TM-2004-212882 ARL-TR-3119	
11. SUPPLEMENTARY NOTES Prepared for the 2004 Annual Meeting and Exhibition sponsored by the Society of Tribologists and Lubrication Engineers, Toronto, Canada, May 17-20, 2004. Paula J. Dempsey and Wilfredo Morales, NASA Glenn Research Center; and Joseph M. Certo, U.S. Army Research Laboratory, NASA Glenn Research Center. Responsible person, Paula J. Dempsey, organization code 5950, 216-433-3398.				
12a. DISTRIBUTION/AVAILABILITY STATEMENT Unclassified - Unlimited Subject Category: 27 Available electronically at http://gltrs.grc.nasa.gov This publication is available from the NASA Center for AeroSpace Information, 301-621-0390.			12b. DISTRIBUTION CODE	
13. ABSTRACT (<i>Maximum 200 words</i>) Advances in material development and processing have led to the introduction of ceramic hybrid bearings for many applications. The introduction of silicon nitride hybrid bearings into the high pressure oxidizer tubopump, on the space shuttle main engine, led NASA to solve a highly persistent and troublesome bearing problem. Hybrid bearings consist of ceramic balls and steel races. The majority of hybrid bearings utilize Si ₃ N ₄ balls. The aerospace industry is currently studying the use of hybrid bearings and naturally the failure modes of these bearings become an issue in light of the limited data available. In today's turbine engines and helicopter transmissions, the health of the bearings is detected by the properties of the debris found in the lubrication line when damage begins to occur. Current oil debris sensor technology relies on the magnetic properties of the debris to detect damage. Since the ceramic rolling elements of hybrid bearings have no metallic properties, a new sensing system must be developed to indicate the system health if ceramic components are to be safely implemented in aerospace applications. The ceramic oil debris sensor must be capable of detecting ceramic and metallic component damage with sufficient reliability and forewarning to prevent a catastrophic failure. The objective of this research is to provide a background summary on what is currently known about hybrid bearing failure modes and to report preliminary results on the detection of silicon nitride debris, in oil, using a commercial particle counter.				
14. SUBJECT TERMS Ceramic; Bearing; Diagnostics; Particle counter			15. NUMBER OF PAGES 16	
			16. PRICE CODE	
17. SECURITY CLASSIFICATION OF REPORT Unclassified	18. SECURITY CLASSIFICATION OF THIS PAGE Unclassified	19. SECURITY CLASSIFICATION OF ABSTRACT Unclassified	20. LIMITATION OF ABSTRACT	

