

We are IntechOpen, the world's leading publisher of Open Access books Built by scientists, for scientists

5,900

Open access books available

145,000

International authors and editors

180M

Downloads

Our authors are among the

154

Countries delivered to

TOP 1%

most cited scientists

12.2%

Contributors from top 500 universities



WEB OF SCIENCE™

Selection of our books indexed in the Book Citation Index
in Web of Science™ Core Collection (BKCI)

Interested in publishing with us?
Contact book.department@intechopen.com

Numbers displayed above are based on latest data collected.
For more information visit www.intechopen.com



DC Network Indoor and Outdoor LED Lighting

Alfonso Gago-Calderón,
Rami D. Orejón-Sánchez and
Manolo J. Hermoso-Orzáez

Additional information is available at the end of the chapter

<http://dx.doi.org/10.5772/intechopen.74974>

Abstract

LED lighting products have become a significant revolution in this technological sector. These components are, by nature, digital emitters created with semiconductor crystals that are powered with very low voltage and direct current (DC). Under these conditions, they have become one of the most relevant actors in the present tendency that is recovering the DC as the channel to transport and distribute energy and is reinforcing the photovoltaic (PV) panels as a relevant sustainable energy source that allows to improve the efficiencies of all types of lighting installations with the local self-generated energy. An analysis of the working principles of this component and the mechanism implemented for their control as lighting equipment to be powered with both conventional alternate current (AC) and DC is presented. A specific differentiation is done upon indoor and outdoor applications where new standards and regulations, specific technical procedures, and singular experimental project descriptions are detailed. The results expose the advantages and difficulties of implementation of this new DC paradigm, the main conclusion obtained up to this moment, and trends of future evolution.

Keywords: direct current grid, smartgrid, photovoltaic energy, LED lighting, LED drivers

1. Introduction

The manufacturing industry is pushing a technological evolution toward the general adoption of the increasingly extended digital systems. This process has been observed in cameras, televisions, automotive controlling, telephones, and, lately, in lighting products with the introduction of LEDs as effective light sources.

In this last sector, this new nature implies bigger energy efficiencies (which make a major contribution to sustainability as, approximately, 20% of the total energy consumed in the world is used for indoor and outdoor illumination [1]) and robustness and easiness of control (allowing brightness regulation, status supervision, or even the generation of a proprietary data transmission network [2]). However, minimizing energy usage within this new trend goes far beyond the light source and the saving that can be achieved through occupancy sensing and dimming. It also brings a new way or energy use: the opportunity for better efficiency also extends to their power grid.

As LEDs work naturally on direct current (DC), drivers are a basic requirement for any lighting equipment powered with the common alternate current (AC) power network of public lighting and buildings. The movement toward a new DC grid allows to enhance the characteristics of LED luminaires: better global efficiencies (minimizing power conversions) and reliability (AC/DC systems have a natural lifetime expectation significantly lower than the LEDs, and they are the most common point of failure in AC luminaires), simplifies household equipment (eliminating many small power supplies), and may obtain better security conditions as very low voltage distribution (VLDC $<75 V_{DC}$ European Council Directive 73/23/EEC) may be possible in many cases. Moreover, advance lighting controls are being developed that are fully integrated inside these DC systems at no higher cost [3].

Until recently, DC LED lights were designed exclusively to be used with battery-based off-grid power sources. However, DC grids have been investigated more intensely in the last decade since many renewable energy sources as well as electronic and control technologies are being developed.

Modern energy consumption grids are thought to be powered in DC either by renewable energy – mainly photovoltaic (PV) panels – centralized AC/DC conversion units, energy storage systems – bank of batteries, electric cars (V2G), and so on – or a combination of all of them.

In this chapter, we analyze the evolution and present developments of new DC energy consumption grids and how LED control technologies are evolving to adapt themselves to these new powering models. Lately, we expose, analyze, and discuss several significant initiatives and projects developed for both indoor and outdoor related to DC LED lighting.

1.1. DC grids

The world runs on AC since electrical power transmission was introduced in the last quarter of the nineteenth century, and AC and DC competed to become the standard power distribution system in the process known as the “War of the Currents.”

The light bulb, incorporating a high-resistance carbon filament, was industrially developed in the last quarter of the eighteenth century. Thomas Alva Edison was developing an industry to manufacture these bulbs but also to provide a complete infrastructure of power plants, transportation grids, and end-use devices such as fuses and switches. Edison opted for DC to share the same grid that was used to power electric engines, which ran this way at the time.

However, George Westinghouse (Westinghouse Electric Corporation) focused on the limited range of the low-voltage DC. At a time when power electronics were too limited, he found in

1883 the first technically usable transformer which made possible to step up and down easily the AC voltage to carry power over long distances from a power plant.

As DC electricity was not converted efficiently into high voltages until the 1960s, a DC power network implied the installation of small/medium power plants in every block of a city (which reduces the efficiency of the system), and, besides, Nikola Tesla presented in 1888 the first AC engine, eliminating the other greatest argument for building up DC grids.

More than 120 years later, AC still constitutes the basis of our power infrastructure. However, two converging factors have renewed the interest in DC power consumption grids in this last decade:

- There are better alternatives for decentralized power generation, PV panels being its most significant technology. They produce DC power and so do chemical batteries, which are the most practical storage technology for PV systems [4].
- Most of our electrical appliances operate internally on DC power. AC electricity is transformed into DC with specific nonefficient internal converters.

Within the next 15 years, more than half of the total household loads are expected to run directly on DC, and LED lights are one of the main actors of this trend [5].

1.2. LED technology

LEDs are an “old” technology that, in recent years, is undergoing numerous advances and transformations toward new applications that are leading the latest revolution in the lighting industry [6].

The first fully electronic-type light source consists of a semiconductor diode base on the junction of two segments of a crystal. When a differential voltage is applied on both extremes of the diode—direct way polarization—it generates photons with an electromagnetic radiation of a specific frequency related by the Planck constant. This allows efficient monochromatic light generation if the frequency emitted is within the range of the human eye vision (~400–700 nm). The research on dopants and crystal structures has led to more efficient and higher-power LEDs. However, white-light sources have been possible through a long path of development generated aside this type of semiconductor.

At the end of the 1990s, the blue LED became a reality developed by Isamu Akasaki and Hiroshi Amano (Nagoya University) and Shuji Nakamura (Nichia Corp). They were awarded with the Nobel Prize in physics in 2014 for this work. They were looking for a precise tool to improve optic data storage systems but they also achieved the basic principle of the latest breakthrough in LED technology: a very efficient and stable white-light emission using phosphorus, not as a dopant, but as a coating for the silicon crystal of blue LEDs and, consequently, to be able to use these devices as sources in general lighting applications as substitutes of fluorescent bulbs and discharge lamps (see **Figure 1**).

Mass-produced LEDs are reaching rapidly comparable results to prototypes being developed in research laboratories, and the electronic drivers that operate LED lamps are also constantly improving on efficiency and robustness. Present projections are contingent on technology developments that achieve the goal of 200 lm/W luminaire efficacy by 2025 [7].



Figure 1. High power 3000 K white XTE LED by CREE. Blue emitter with phosphorus cover.

2. Working behavior of a high-power LED

The light output of a high-power (HP) LED depends basically on two factors: the electric inputs—forward voltage (“ V_f ”) and current (“ I_f ”) values—and its crystal junction temperature (“ T_j ”). This last value inevitably increases as electrons and holes combine.

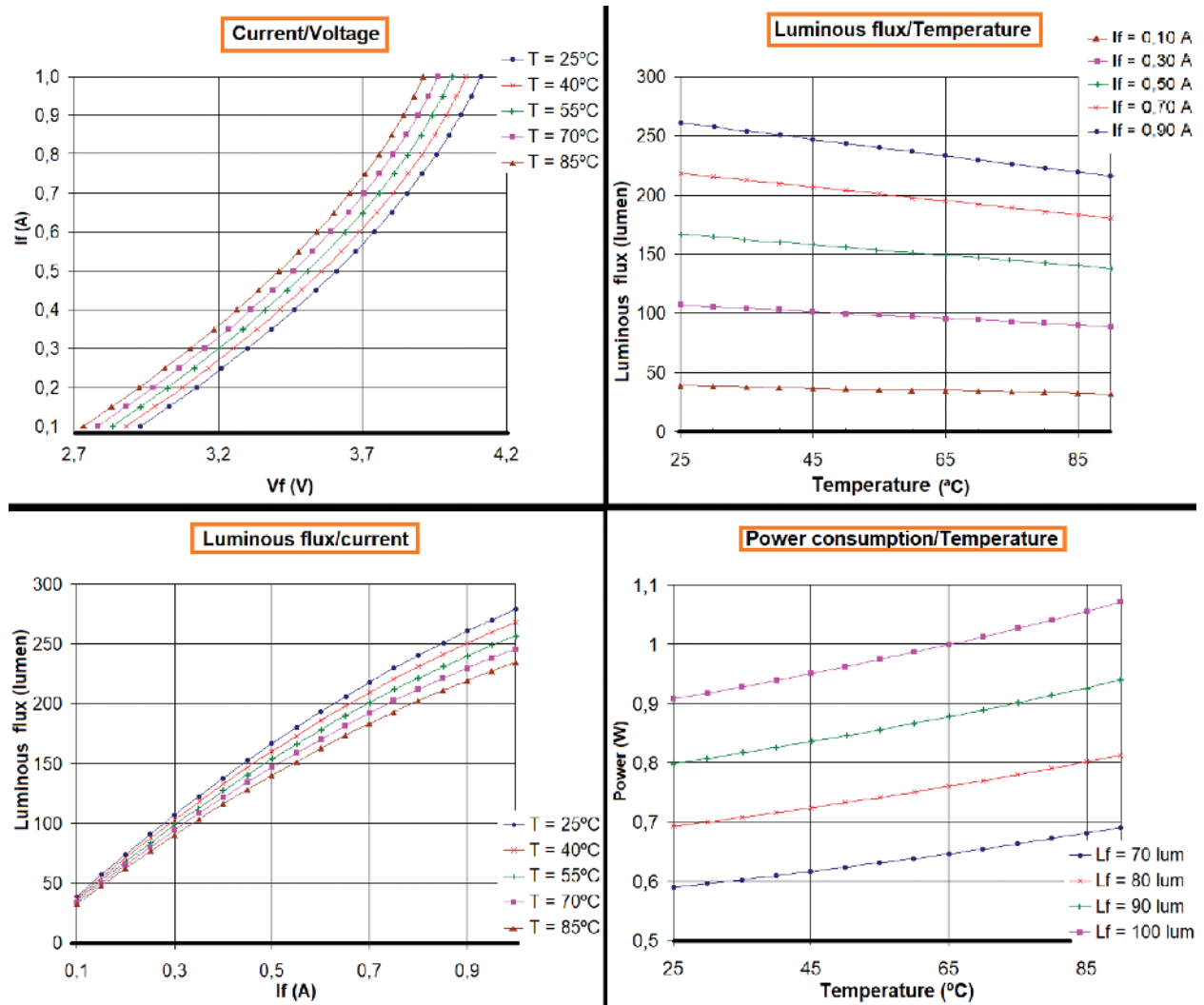

Figure 2. Working parameters of a high-power XT-E white LED by CREE.

Given a constant T_j , the illuminance of HP LED varies linearly with its I_f at small values and tends to saturate at higher values. Otherwise, if a constant current (CC) drive is forced, the light emitted moves down as T_j increases. This is caused by the variation relationship between V_f and T_j , which is approximately proportional [8]. For the XT-E LED by CREE, the typical relationship is $-2.5 \text{ mV}/^\circ\text{C}$. This effect makes itself visible in the displacement of its working curves. These V_f - I_f - T_j -“Luminous flux” relationship curves of the mentioned LED are shown in **Figure 2**.

Consequently, if a CC is applied on the LED, the increase in the junction temperature causes only a slight decrease in its V_f drop and, at the same time, in the illumination obtained, creating a natural mechanism of negative feedback that maintains the stability of the system.

However, if we use a constant V_f with LEDs, its power consumption increases along with its T_j , produced by a significant increment in the forward current, creating a positive feedback that will finally conduct to a catastrophic burn failure. This phenomenon is generally known as thermal runaway and is the reason why the standard method of driving LEDs is the use for DC current sources.

3. DC LED drivers

Because of this electrical behavior of HP LEDs, in case of DC supply, we need to have a current control device in series with the LEDs to guarantee stable working conditions. Creating a regulated current source can go from a very simple concept, using a passive polarization resistor, to a more complex solution using active current regulator circuits. Here, we summarize the general trends found in the study and the market to achieve this objective, accounting nonsteady (batteries) and steady (switching converter outputs) DC sources.

3.1. Passive control methods: polarization resistors

The simplest driver is a current-limiting resistor placed along with the powered LEDs. The reduction in the polarization voltage of LEDs due to temperature increment is compensated with the larger drop in the resistor (negative feedback effect). If the supply voltage is very well defined and stable, close to V_f , this is the simplest, most reliable, and long-lasting LED driver. However, it is not significantly efficient as all the required current is driven through these impedances generating a significant amount of heat, and a substantial resistance value is required to keep current within an adequate range. If the voltage source is not stable, the brightness of the LED would vary remarkably because a small voltage variation would already lead to large changes of the output power. This system is only able to correct the variations of the behavior of the LED due to the changes of its T_j .

3.2. Active control methods

3.2.1. Linear power drivers

Active current control uses bipolar or MOSFET transistors as regulation devices or feedback elements to regulate the current driven through the LEDs. In contrast to the polarization resistors,

this solution is the next step in a complexity qualification as it uses again a resistor but now as a current sensor load that is able to modify the gate signal of the control transistor. The resistor can be of a much lower value as it will not work as a limitation but as a sensor.

The obtained efficiency is also good in case there is a constant forward DC voltage source on the range of the nominal polarization voltage of the LED because the control neglects the entire voltage drop in the semiconductor. If the voltage variation is within $\pm 10\%$ of the nominal LED polarization, voltage efficiency can still be above 84% on the worst case [9].

This solution can be improved using linear voltage regulators (LVRs) set as CC control elements (e.g., LM317 or NTE956) instead of transistors [10]. They use an internal voltage reference that offers a more accurate solution, but they have a minimum dropout voltage—as high as a few volts—which introduces significant energy losses (see **Figure 3**).

In general, these types of solutions, as well as the first option, have as main advantages that both include no EMIF generation as there is no current commutations (thus, no filtering is required). However, they allow a limited supply voltage range; the LED load voltage has to be lower than the supply voltage, and there are significant energy losses due to heat dissipation.

3.2.2. CC switch-mode converter drivers

This is the most implemented type of solution for commercial DC LED lighting drivers. Although there are many different variations, three standardized models are widely recognized to configure CC generators for HP LEDs. Each of them is prepared for a different relationship between the supply and the LED voltage that has to be maintained independently of the variations that can suffer the supply or the load due to “Tj” changes:

- Buck converters: very efficient step-down topology with many implementations: synchronous switching, average current, peak current, or hysteric control.
- Boost converters: step-up topology very common in battery-powered equipment. The two basic implementations are inductive boosts or charge pumps.
- Boost-buck converters (single-winding fly-back converters): they drive power loads with both step-up and step-down requirements. This model is characteristic from stand-alone systems powered with batteries where input voltage can suffer large variations. They are more flexible but less efficient than the two previous options.

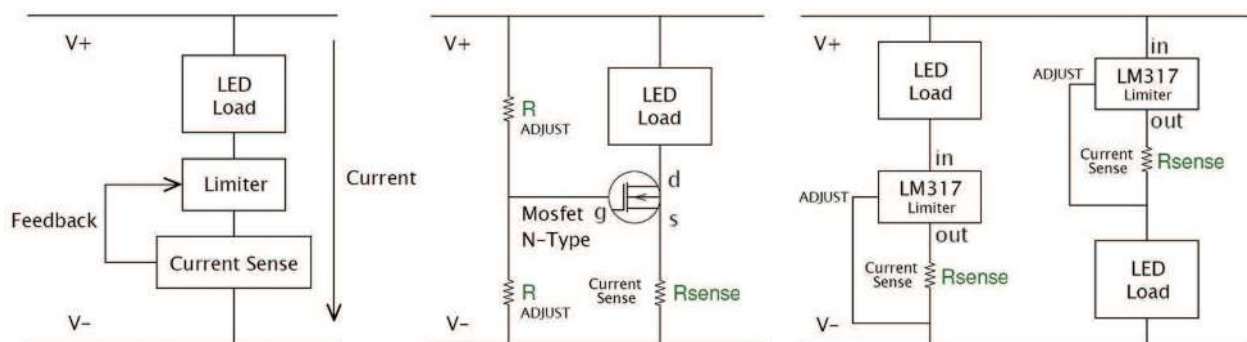

Figure 3. Linear power LED driver configurations: (A) MOSFET and (B) linear voltage regulator.

A large number of ICs from many manufacturers are available in the market to implement these types of drivers. Efficiencies over 95% can be achieved with adequate designs as observed in **Figure 4**. However, these CC drivers present the following main drawbacks:

- a. They do not control the temperature of LEDs. This defines their lifetime expectation.
- b. They include components that are not as reliable as LEDs (inductors, electrolytic capacitors, etc.) which become the weakest points of these types of lamps.
- c. They generate an electric conversion that provides a current-regulated output. In all cases, this reduces efficiency, performance, and, as mentioned, reliability.

3.2.3. LED matrix temperature-feedback drivers

Another driver option is to use MOSFET transistors as commutators to create a pulse-width modulation (PWM) signal that controls the energy introduced into the LED matrix. Under this concept, DC lamps can be driven with an electronic circuit that applies regulated current PWM cycles according to the LED matrix temperature or the voltage level of the source.

The control principle assures that the temperature of the LED is kept below high values to guarantee the expected lifetime in all working conditions using only a reliable hardware architecture of very few components: one low-power microcontroller, one temperature sensor, and a power MOSFET (N-type) that acts as the control actuator in the LED matrix, plugging or unplugging this with a PWM commutation (see **Figure 5**).

This control architecture can execute, if required, a smooth reduction on the active period of the LED driving signal (from a normal status of 100% active) to reduce the power consumption. This

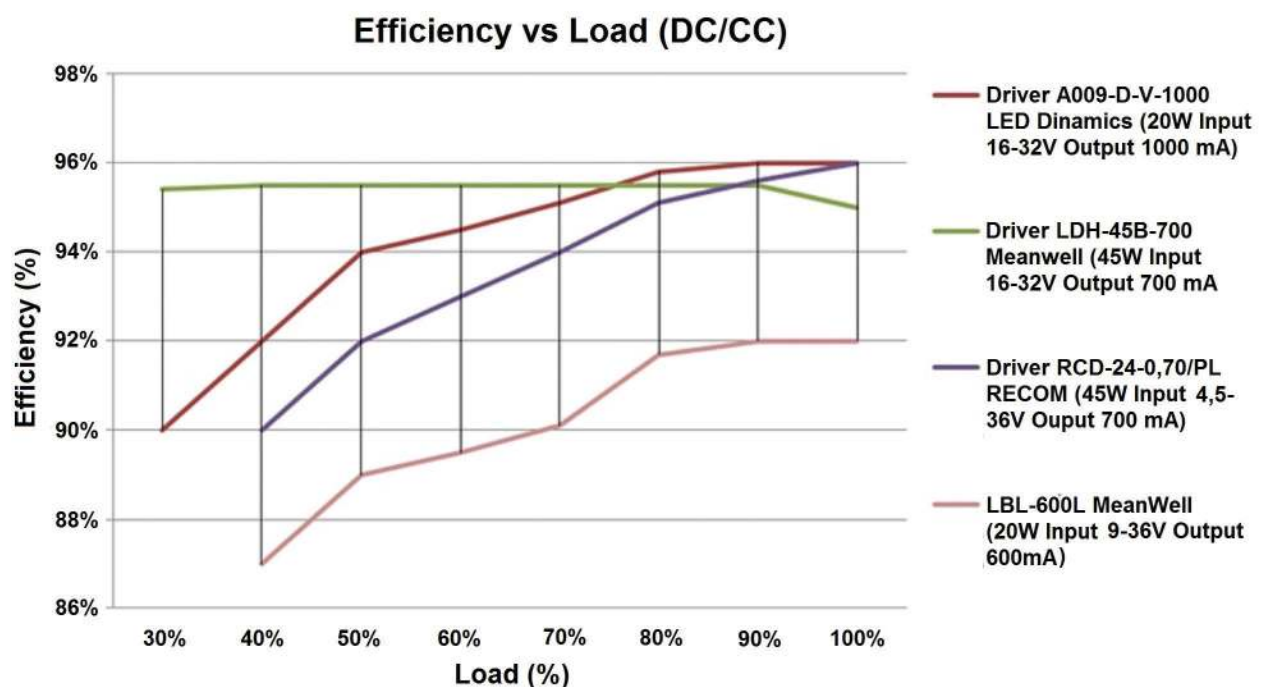

Figure 4. Efficiency versus load curve of commercial DC/CC switch-mode converter drivers.

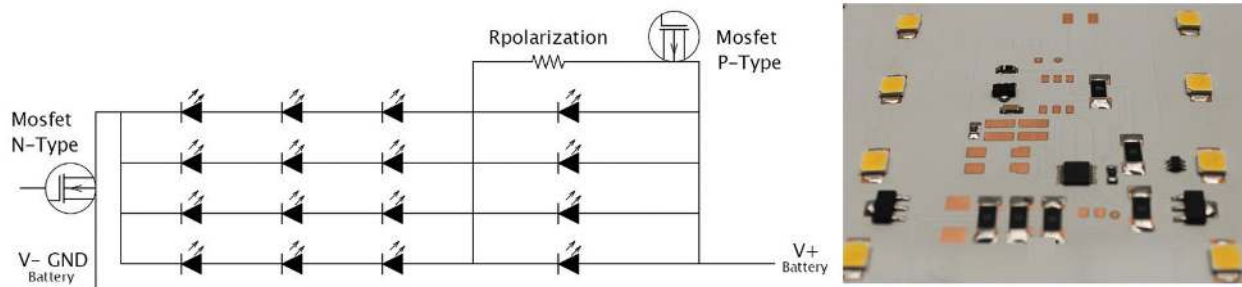

Figure 5. LED lamp with temperature and input voltage-feedback driver implementation.

implies reducing the light emitted but also the heat generated inside the LEDs. This situation can be reached by either abnormal working operation conditions or unusually high working temperatures. This control is a negative feedback compensation mechanism of current increments due to high “ T_j ” while powering with constant voltage DC values. The commutation frequency must be high enough to avoid significant flickering and low enough to produce no excessive EMIF. Values between 0.5 and 1.0 KHz are suitable.

A common DC driver adapts the grid values to the specific impedance of an LED matrix, but it is possible to flip this concept and evolve this driver to be able to modify the impedance of its LED lamp to adapt it to the variable voltage of a nonsteady power source.

The LED matrix may include also a P-channel MOSFET in series with a small impedance resistor (R) placed in parallel with the first LEDs connected on each branch of our matrix. This scheme is designed to adapt the lamp to the wide range of voltage supply of batteries. For example, the circuit in **Figure 5** is prepared for the voltage supplied by a 12 V_{DC} lead acid battery that can vary between 11 and 15 V_{DC} . The exponential V-I relationship of a white LED makes its brightness decrease dramatically when the voltage gets below 12.3 V_{DC} (3.1 V_{DC} per diode), generating unsatisfactory luminance. If the control detects an input voltage below this threshold, it activates the second PWM signal that takes out the first LED of each branch of the lamp for discrete moments. In this way, the impedance of the matrix is reduced keeping the rest of the LEDs with adequate “ V_f ” polarization and brightness.

This sample LED luminaire design varies its consumption from 13 (at 12.6 V_{DC}) to 7.5 W (at 11 V_{DC}). This behavior can be considered good for PV stand-alone systems as the lamp consumption is reduced at low voltage (low energy in the battery) which contributes to a safe management of the system while maintaining a good level of illumination. The energy efficiency of the proposed control scheme is, on average, 15% higher than the one obtained with a CC switch converter control powering the same LED lamp [11].

3.3. Control method selection

Designers may consider that if the voltage of the LED lamp is just below that of the DC source, both linear current regulators and temperature feedback controllers are simple, high-efficient, cost-effective, and very reliable solutions. If the design is well adjusted to the input voltage, efficiencies can be extremely high; otherwise, significant losses appear. In those cases,

switching current regulators are needed: boost or boost-buck solutions if the voltage of the LED lamp is over the DC source voltage and buck implementations if the voltage of the matrix of emitters is significantly below (80% or less) the DC source voltage.

3.4. Advantages of DC versus AC drivers

DC LED lighting allows eliminating components that are necessary in AC/DC conversion. To compare the component effort required in solutions with AC and DC current supplies, **Figure 6** shows a block diagram of a typical lamp driver AC operated. Once it reaches the last stage of the chain (DC/DC box), all the abovementioned for LED matrix powering are applicable [9].

These blocks are as follows:

- **Filter:** It suppresses high-frequency contents of the input source. Most of the international regulations (e.g., IEC 61000-3 or IEEE STD 519-2014) order that the maximum total harmonic distortion (THD) of the voltage and current signals generated must be under certain limits. It is also a necessary part of an active power factor corrector (PFC). It may still be required in DC drivers if switched conversions are used to avoid the generation of fluctuations in the energy source.
- **Rectifier:** It is typically implemented with a bridge of diodes. It might also be useful in DC operation to allow an arbitrary connection of the positive and negative lines. However, this problem may be solved with a mechanical system that avoids a wrong connection.
- **PFC circuit:** It increases the ratio between the useful (W) and the total power (VA) consumed by the driver. Many drivers use switch converters (typically a boost-type circuit) but this requires an input filter to limit high-frequency THD generation. The next review of the IEC 61000-3-2 intends to raise the requirement of integrating a PCF circuit in any lamp driver from 25 to 5 W.

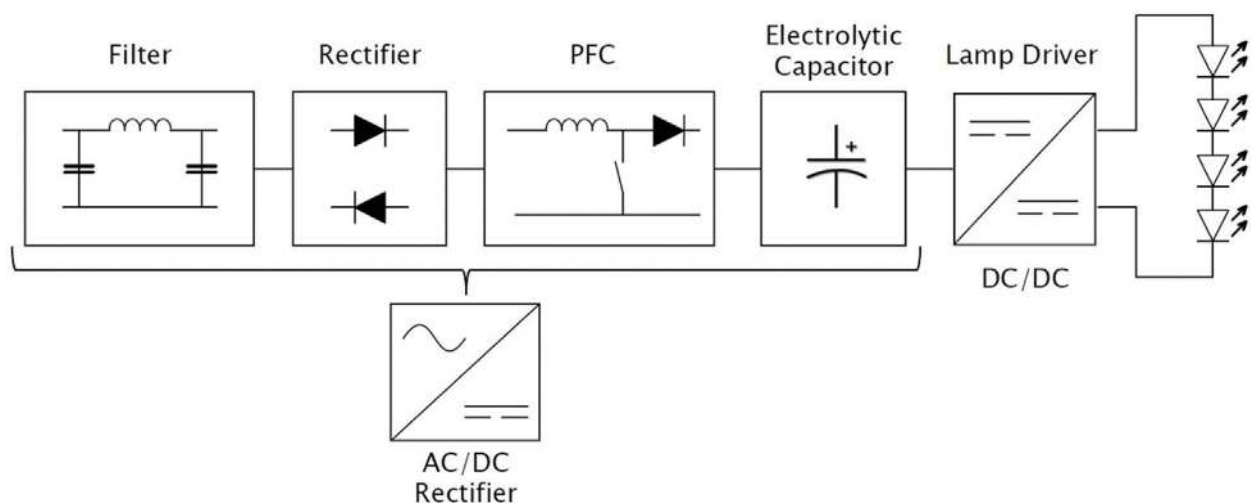

Figure 6. Typical topology of an AC lamp driver.

- Electrolytic capacitor: It levels the pulsating rectified voltage signal. In DC, they can suppress voltage dips of the energy source but most lighting applications may consider acceptable to pass them and allow short flickers on the LEDs.

The LED driver can be housed in an external case or in the device itself (which is much cheaper and significantly simplifies the luminaire configuration). Eliminating the AC/DC components

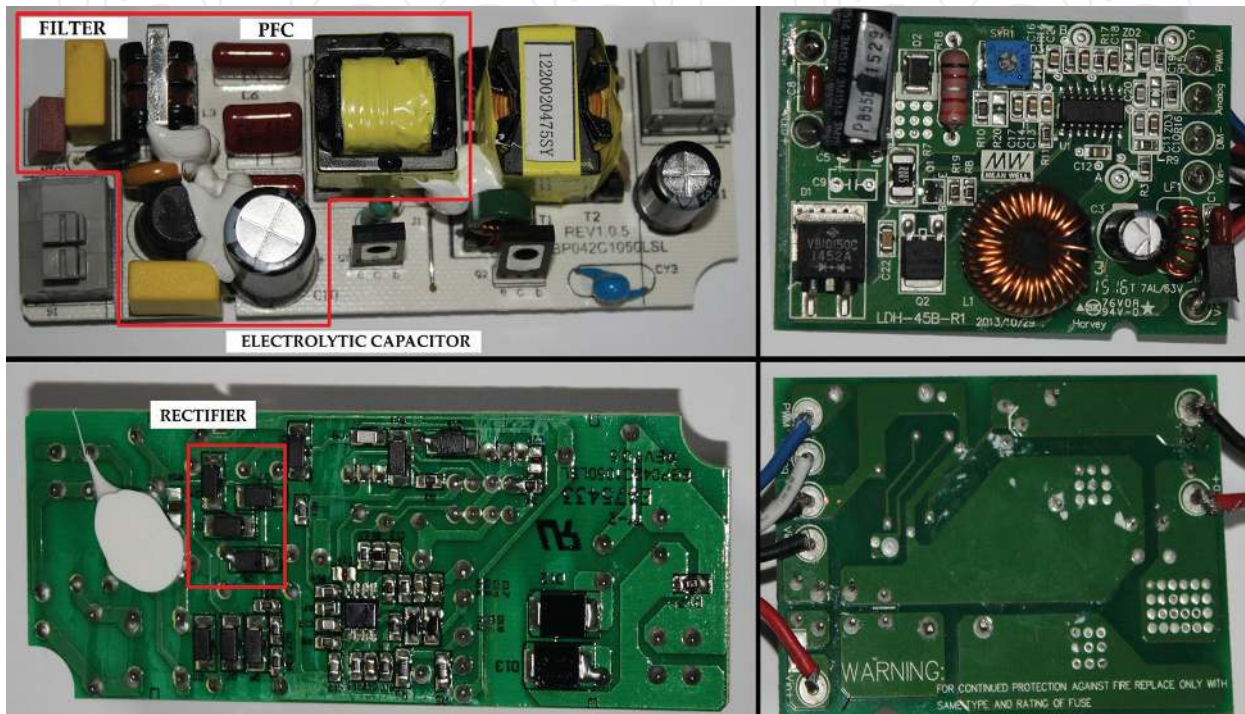

Figure 7. Typical topology of a common AC lamp driver compared to a DC counterpart.

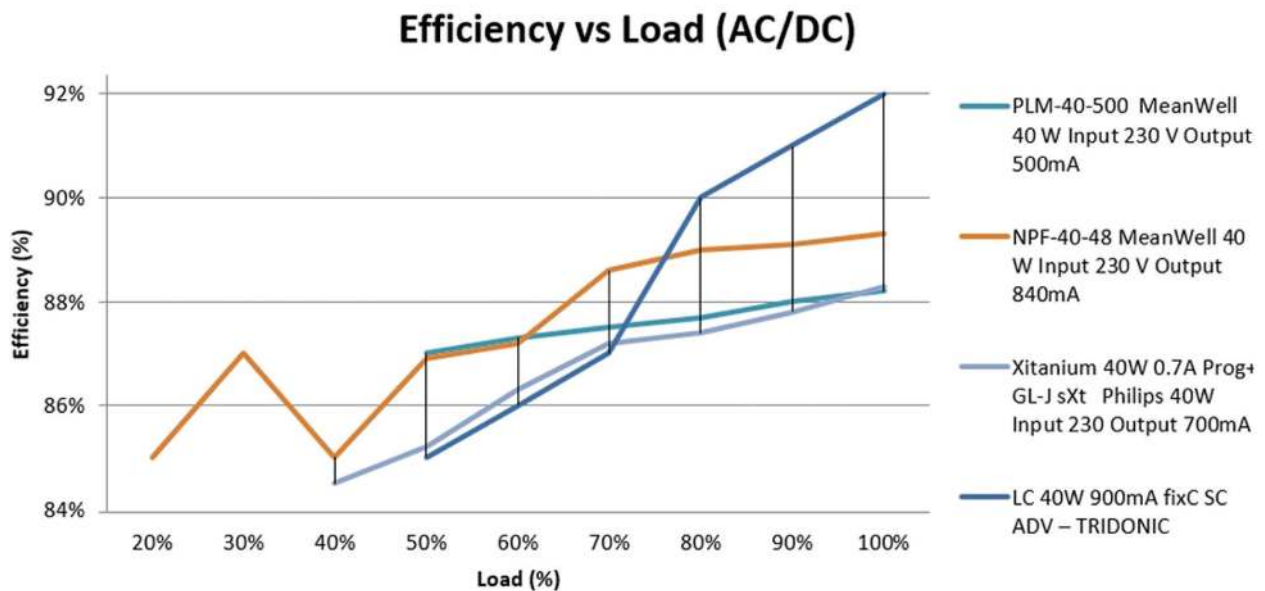

Figure 8. Efficiency versus load curve of commercial AC/CC switch-mode converter drivers.

means less space requirements, cost reduction, and simpler installation. Between 40 and 50% of the printed circuit board (PCB) in an AC/DC, LED driver is occupied by the AC components.

Figure 7 shows a photograph of two LED drivers. On the left, we present a 42-W AC unit by Eagle Rise with PF corrected over 0.95, an efficiency between 0.89 and 0.92 (60–100% loads) and no dimming possibilities. All parts that are necessary for AC conversion are highlighted. On the right, we have a $24V_{DC}$ (18–32 V_{DC} range) input LDH-45B-700 DC dimmable LED driver by Mean Well with efficiencies between 0.95 and 0.96 (30–100% loads). It has no input diode bridge so that polarity has to be checked before powering the equipment.

Figure 8 presents, similar to **Figure 4**, the efficiency of four commercial AC/CC drivers versus their load. These curves present larger slopes and an average decrement of efficiency of 5–6% compared to their DC/CC counterparts.

4. Indoor and outdoor DC-lighting experience

Nowadays, the US is the country that is adapting more DC-lighting installation in a context where, according to the 2016 calculation of its Energy Information Administration (EIA), this country used 15% of all its consumed energy for lighting purposes [12]. This is a significant reduction from the 22% calculated in 2009 due to the massive installation of LED equipment and efficiency initiatives as the AC to DC residential and commercial indoor grid translations. On account of this, these two sectors figure as very significant with 7% of the total electricity consumed (approx. 279 billion kWh) [13].

If all general purpose lighting equipment in the world were converted to LED light sources (agreeing an average 40% saving at each point), their energy consumption could be decreased by around 1000 TW h/year, reducing 200 million tons of greenhouse gas emission [7]. Any additional development that allows higher efficiencies, as the elimination of the AC losses, has also significant relevance due to the large amount of energy involved.

4.1. Indoor direct current indoor led lighting: trends and applications

On average, 80% of the energy used in modern buildings power DC loads. Low-power devices (≤ 50 W), like most indoor LED lamps, are responsible for 35–50% of this use, and all of them work with small power-wasting converters. LEDs and DC power distribution in buildings can notably enhance the efficiency of this significant amount of energy.

As it is considerably difficult to eliminate all the AC loads and the general distribution grid, the basic consensus is to replace all the many AC/DC converters placed on each luminaire with a common centralized frontend to provide high-efficiency conversion and protection and then conduct the electric power in DC to the LED fixtures.

4.1.1. Development of systems

LED matrixes may work from just $3.3 V_{DC}$. Over this voltage, many possible solutions can be implemented using different serial/parallel LED configurations. It is important to select the

most appropriate solution to achieve the highest energy efficiency and the safest operation conditions. The main problem is that these two concepts are here antagonists. A significant number of DC distribution systems have emerged over the years, and, at present, it seems yet far to achieve a unique standard. Special focus has been put over several specific supply voltage levels along with the type of cable and connections to be used. The most developed proposals are presented in **Table 1**. The most significant aspects that are important to consider choosing one of these systems for a specific installation are described in the subsequent text.

4.1.1.1. Solar energy

These renewable sources are not yet the perfect solutions but match significantly well with LED lighting. In fact, DC LED lighting was first developed to be powered off-grid exclusively with solar energy as LED-lighting technology is efficient enough as to reduce its required

Range	Characteristics	V_{DC}	Details	Standards
VLDC	ADVANTAGES	12	Most used in cars, trucks, motor homes, caravans, and boats	UL 1838 & UTSFfSHS (Universal Technical Standard for Solar Home Systems) [14]
<75 V_{DC} Council Directive 73/23/EEC	<ul style="list-style-type: none"> • Safe from electric shock and fire hazard • Many commercially available devices • No grounding needed • No protection against direct contact is required 	24	Intermediate solution	UL 2108
<60 V_{DC}	<ul style="list-style-type: none"> • Simple adaptation of PV generators and batteries 	48	Allows working with higher power devices	IEC 60364-7-715:2011 EDISON project (EU) http://www.project-edison.eu/ [13]
NFPA 70 National Electrical Code	DISADVANTAGES	60	Ethernet cabling combines power and control.	PoE (Power over Ethernet) Lighting systems [15, 16]
	<ul style="list-style-type: none"> • - Relatively high cable losses (depends on the length) 		Maximum allowed: 100 W at 60 V	
DC <1500 V_{DC}	ADVANTAGES	380	Similar DC voltage than 230 V_{AC} (needs equal insulation properties). Generates only about one-third of the losses in converters and cables [17]	IEC SG 4 Group "LVDC distribution systems up to 1500 V_{DC} "
Low Voltage Directive (LVD) 2006/95/EC	<ul style="list-style-type: none"> • - Minimum cable losses DISADVANTAGES <ul style="list-style-type: none"> • - Complex security systems are required • - Arcing appears when a load is unplugged Internal arcing chambers. Voltage broken protection Standard IEC 60947-2 -3			TBINK-LVDC working group at DKE/VDE

Table 1. Common voltage levels for DC indoor lighting: characteristics and standards.

consumption within PV power generation capability, especially when combined with control systems that are able to regulate energy consumption to avoid deep discharges.

According to the nature of LEDs, PV panels, and batteries, it is easy to use LVDC with this type of integrations as they allow a more flexible PV panel configuration and reduce voltage conversions.

4.1.1.2. Cable losses

Cable losses are determined by their length, diameter, and the conducting material. A copper wire with a 10-mm² cross section, distributing 100 W at 12 V_{DC} over a 10-m distance, generates an energy loss of 3%. If this length increases to 50 m, energy loss becomes 16% and for 100 m raises to 32% (which erases all the efficiency advantages of DC lighting). Cable losses also limit the use of high power luminaires. In a 12V_{DC} 10-mm² copper wire, 1-kW LED projector has 16% energy losses in a 1-m cable and 47% in 3 m. Working with higher voltages, even still within VLDC, reduces these losses by a square factor of the voltage variation. Moving from 12 to 48V_{DC} improves cable transmission efficiency by a factor of 16.

The spatial layout is very important to limit this distribution problem. Large buildings will require several energy AC/DC converters placed in different powering sectors. Another way to reduce cable losses is to set up several independent power supply units (PV panels and batteries) in these sectors. Although this strategy implies the use of extra solar charge controllers, this might be the most efficient way to illuminate large buildings.

4.1.1.3. Protections

Protection systems are among the main challenges in the design and operation of DC lighting. DC power distribution, as well as AC, becomes more dangerous as its voltage level increases but, in all cases, fast-speed fault protection, including coordination and interruption, is the essential requirement to be protected against failures as short circuits.

The primary protection in DC lighting grids is the circuit disconnection by overcurrent detection devices: circuit breaker or fuses. They have to be specifically designed as in DC there is no zero crossing in the waveform and they have to break the full fault current. However, they are becoming more common as more DC installations are generated. On the other hand, as total power is reduced and the most extended standards work in VLDC, grid-lighting protection is usually incorporated inside the driver modules with solid-state circuit breakers, and there is no need of adding it externally.

4.1.2. Research installation experiences

Several significant experimental research installations involving DC lighting with published results are presented in **Table 2** [18].

4.2. DC outdoor led lighting: trends and applications

Worldwide, outdoor public lighting means, on average, a reduced amount of the total energy usage (3% of the total energy consumed) compared with that used for indoor installations

Project	V_{DC}	Details	Results and conclusions
Philips Research Eindhoven (NL) [19]	380	2 kWpk photovoltaic (PV) 54 LED downlights (37 W) 3 power grids of 100 m length ($3 \times 2.5 \text{ mm}^2$)	DC energy demand 2.24% lower than the AC equivalence
Fort Bragg, North Carolina (US) [20]	24	Bosch DC microgrid: 15 kW PV array. 44 DC lights. Direct power from 100 kW lithium-ion battery system	VEEI: $1.80 \text{ W}_{AC}/\text{m}^2/100\text{Lux}$ of AC fluorescents Vs $0.87 \text{ W}_{DC}/\text{m}^2/100\text{Lux}$ of the 380 VDC LEDs
Fraunhofer Institute in Erlangen (GR) [21]	380 & 24	DC office building with lighting and a 24 V DC grid for electronic loads. Batteries back-up storage	The DC system demonstrated electricity savings ranging from 2.7 to 5.5% over an equivalent AC system
Xiamen University, Xiamen (PRC) [22]	380 & 24	150 kWp solar panels. 20 kW LED lighting: 14 W tube lights as T5 fluorescent tubes retrofits	DC microgrid with bidirectional inverter and battery storage. Static payback period 5.5 years ($\$0.887/\text{W}$)

Table 2. DC indoor-lighting experimental research installations.

(17%) [1]. However, this is still a major market where efficiency improvements can make significant advances in sustainability.

Planning a similar approach than those presented in indoor lighting, one of the first studies generated to compare DC versus AC grids in outdoor LED lighting was realized in 2013. The results of a 220 V_{DC} centralized street-lighting system over conventional 230 V_{AC} power system showed that the efficiency can be improved by 13 (full loads) and 17% (dimmed loads) [23].

However, and independently of this trend that is still under a very early stage of development, the first and most consolidated architecture used to develop DC LED streetlight is the autonomous solar-powered equipment. Modern PV DC luminaires have become the most extended element by virtue of its simplicity, function, and robustness of its components: battery, LED luminaire, and PV panels. This technical evolution and the growth of emerging countries with underdeveloped electrification infrastructures have boosted the market of lighting installations powered only by locally produced energy from the sun [24].

Park et al. [25] remark that the development and installation costs of a micro-distributed ESS-based smart LED streetlight system have been reduced by 33% in just a few years. Moreover, Loomba and Asgotraa [26] claim that DC solar microgrids are 25–30% more efficient than their AC counterparts. The global energy efficiency benefits may vary a lot depending on the location. According to information from the World Bank, the average electric transmission losses are only 4% in Germany and the Netherlands but raise slightly, 6%, in the USA and China and much more, between 15 and 20%, in Turkey and India.

Solar low-power equipment is widespread and participates already in many in-use installations. As an example, we have participated in a public-lighting renewal project developed with 1365 autonomous 50 W LED lighting poles in the city of Cuimba (Angola), as illustrated in **Figure 9**. The equipment used is designed to store enough energy to work three nights with no solar energy input. Development installation costs were reduced in more than 35% compared to renew and bury the AC grid existing already.



Figure 9. Solar autonomous public streetlight installation in Cuimba, Angola, 2017.

However, there are still uncertainties about the technical capability of this type of equipment in order to match their performance to their AC grid equivalents in lighting installations with large regulatory requirements: high-density traffic roads. We present a technical evaluation of the capability of present equipment to achieve these requirements in different global locations based on energy generation capability of solar panels, efficiency of DC LED luminaires, and capacity and long-term reliability of batteries.

4.2.1. Dimensioning of an autonomous led-lighting installation

The DIALux software has been used to size the requirements of the luminaires to fulfill the requirements of the ME2 and ME3 roads with geometric aspects as presented in **Table 3**. We simulate these specifications with different high-class DC LED street luminaires by three manufacturers (Philips, Solitec, and Schreder Socelec), and the results are compared with the normative classification assigned. The power and luminance requirements for each manufacturer

Road parameters	Road Type A	Road Type B
Road classification	ME3a	ME2
Number of lanes	2	4
Road width	7 m	14 m
Interdistance	30 m	35 m
Height of light point	9 m	12 m
Placement setup	Unilateral	Bilateral face to face
Luminaires manufacturer/model	Luminous flux/power	Luminous flux/power
Solitec/Navia G	8805 lm/80 W	12,101 lm/110 W
Philips/UniStreet	7654 lm/76 W	11,050 lm/110 W
Schreder/Ampera	9905 lm/87 W	11,972 lm/105 W

Table 3. Geometric data and luminaires selection for the ME2 and ME3 roads under study.

to achieve the objectives established are also presented in **Table 3**. All three results are very similar, and for the rest of the study, we use the average power in each road case. Dimming during the night is included as energy efficiency regulations advice for this possibility. This leads to a total energy consumption of 75% of the nominal value calculated previously. Moreover, the battery storage system has to accumulate at least double of the energy to bright as programmed for one night.

There are two power distribution possibilities: autonomous poles with PV panels and storage systems integrated with each luminaire (simplest installation) or an independent renewable generation system that powers a smart micro-grid with several luminaries (more complex and expensive due to wiring canalization). The first option is limited by the amount of PV surface that is mechanically adaptable in a single pole. The availability of each solution depends on the amount of energy that is possible to generate depending on the geographical latitude. This value conditions the functional elements of the facilities, the simplicity and cost of the installation, the protection requirements, and maintenance and operation cost. Several representative locations have been chosen between or close to the Tropics of Cancer and Capricorn as these are the regions that receive the greatest amount of solar radiation. The PV energy generation capability on the main cities of this portion of the world is shown in **Figure 10**. For calculation purposes, the extreme representative possibilities are found in the following:

- Rabat, Morocco (2770 Wh/m² per day). Latitude 34°00'47"N. Its radiations present considerable differences along the year, and it has long nights in winter.
- Brasilia, Brazil (4523 Wh/m² per day). Latitude 15°46'46"S. On the other hand, it receives very constant solar radiations, and the night duration is similar all year long.

The equations used to define the power generation capability by PV panels in these two locations are presented in **Table 4**. **Table 5** shows the components required to light both classes of roads under study on the worst scenario (design day in winter in the city of Rabat), and **Figure 11** explains that while in Brasilia, it is possible to install fully integrated autonomous

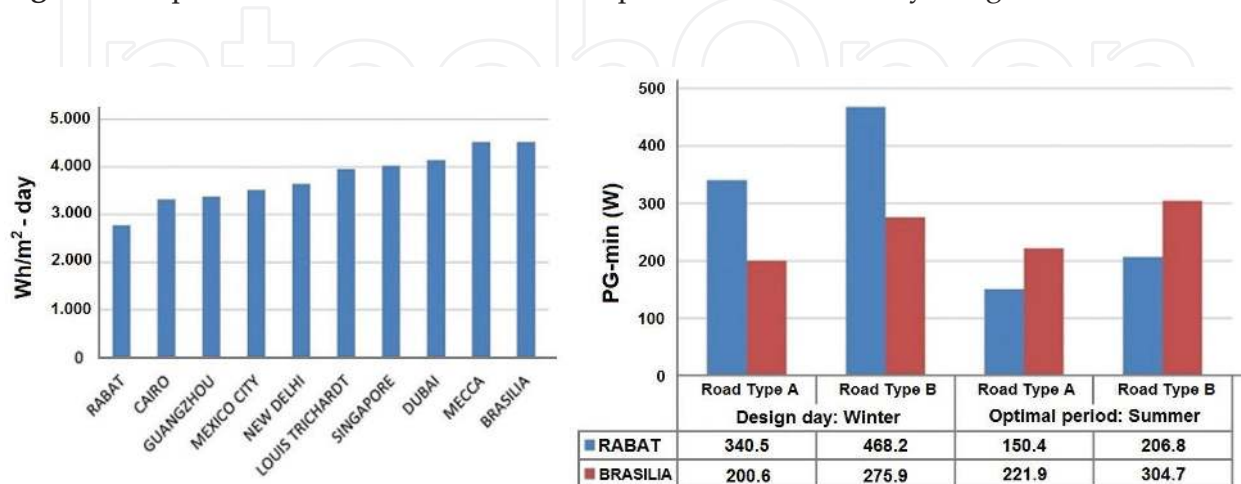

Figure 10. Solar energy input and design requirements of the streetlighting equipment for capital cities close to the tropics.

Minimum power required by the photovoltaic generator

$$P_{G-min} = \frac{W_d \cdot G_{CEM}}{G(\alpha, \beta) \cdot K_r}$$

- W_d : Energy consumption [Wh/day]
- G_{CEM} : Standard radiation, 1000 W/m²
- $G(\alpha, \beta)$: Incident radiation in the panel [Wh/m²-day]
- K_r : Battery and regulator efficiency [%]

Energy accumulation system

$$C_N = \frac{Q_d \cdot A}{PD_{MAX} \cdot \eta_{con}}$$

- Q_d : Nominal daily capacity [Ah/day]
- A : Days of autonomy
- PD_{MAX} : Maximum discharge depth of the battery
- η_{con} : Battery and regulator performance
- U_n : Rated voltage of the photovoltaic generator [V]

Regulation system

$$U_{OC(Tmin)} = U_{OC} + \beta \cdot (T_{min} - 25)$$

$$I_R = 1,25 \cdot I_{G,sc}$$

- $U_{OC(TMIN)}$: Rated voltage of the photovoltaic generator [V]
- T_{min} : Historical minimum temperature (°C)
- U_{OC} : Open circuit voltage [V]
- $I_{G,SC}$: Short-circuit current of the generator [A]

Table 4. Equations for the dimensioning of LED luminaires powered by photovoltaic panels.

PV luminaire poles to fulfill ME2 and ME3 requirements in Rabat, this is not possible with ME2 roads as, at least, 2.52 m² of 30 kg PV panels are required, which makes it impossible to integrate them on top of a single lighting pole due to mechanical limitations.

Type of road		A (ME3)	B (ME2)
Photovoltaic generator	PG-min design	340.5 W	468.2 W
	Equipment	SunPower SPR-X21-345	2 × HIT-235
	Surface	1.60 m ²	2.52 m ²
	Weight	18.6 kg	30.0 kg
Energy accumulation and regulation system	Cn	C _{10,14} = 95.88 Ah	C _{10,13} = 263.60 Ah
	Equipment	Move MPA 110-12	Move MPA 245-6XL
	Weight	33.3 kg	39.0 kg
	Number	4	4
	Voltage	12 V	6 V
Energy regulatory system	Equipment	Steca Tarom 4545-48	Steca Solarix 2020-x2
	Weight	0.8 kg	0.5 kg
	Uoc	≤100 V	≤60 V
	I	45 A	20 A

Table 5. Component requirements for a solar LED luminaire at worst case: city of Rabat.

□ RABAT – ROAD TYPE A

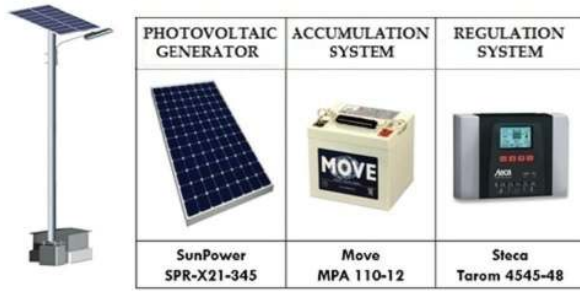

□ RABAT – ROAD TYPE B

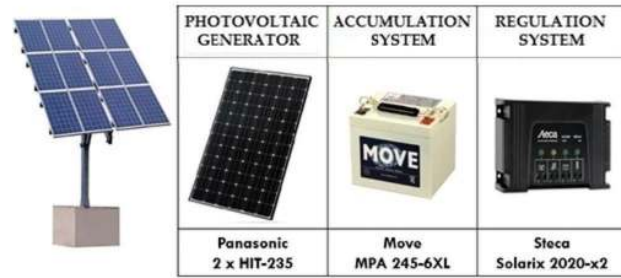

□ BRASILIA – ROAD TYPE A / ROAD TYPE B



Rabat	C _n [Ah]	t _A [Ah]	U _{OC(Tmin)} [V]	I _R [A]
ROAD TYPE A	95,88	10,14	72,39	8,00
ROAD TYPE B	263,60	10,13	51,80	14,60

Brasilia	C _n [Ah]	t _A [Ah]	U _{OC(Tmin)} [V]	I _R [A]
ROAD TYPE A	148,40	15,09	51,80	7,30
ROAD TYPE B	145,60	19,00	73,46	7,50

Figure 11. Basic configurations and available integrations for ME3 (Type A) and ME2 (Type B) road regulation accomplishment in the cities of Rabat and Brasilia.

Nowadays and according to these results, this technology has still a further step to evolve before autonomous pole luminaries can be used on high-density traffic roads worldwide with autonomy assurance. However, many demonstration projects are already being constructed. For example, autonomous PV luminaires have been installed in the A⁻⁶² motorway (ME3 road), in Salamanca, Spain. In this case, promoters also appraise the quick installation process (only 3 days) that avoids large dangerous installation process along traffic conditions.

5. Conclusions

Many Scientifics and technicians consider that the conversion of the lighting sector toward a full DC environment is its natural evolution trend as LED technology has become the basic engine of almost any new equipment developed for both indoor and outdoor applications.

Better energy efficiencies and larger lifetime expectations are the basic economic forces that are conducting this process that, nevertheless, is still facing considerable challenges in this primitive stage of development.

The unavailability of DC infrastructures and the lack of training/educations are the main drawbacks that are being overcome as universities and private research centers have considered this a priority research line. However, some other concerns are still far to be solved such as the consolidations of worldwide regulations and standards that ensure acceptable energy savings and total human safety. The first parameter varies significantly in each experimental installations ranging from 3 to 30% [18]. This will also lead to establish common safety

procedures and voltage levels for LED-lighting DC grids that will allow mass production of devices that may work anywhere as well as their AC equivalents.

Considering the relationship between LEDs and PV energy generation, the direct interconnection possibility and the advance in efficiency of the new light emitters have renewed the interest in autonomous applications, both stand-alone and with a backup energy grid. Thus, the number of solar-powered LED equipment installed is increasing exponentially. However, a further step in the evolution of these two technologies is still expected to improve the integration capability and the autonomy in high-latitude locations.

Acknowledgements

We would like to acknowledge Alfonso C. Gago-Bohórquez for the deep critical reading, Tiara L. Orejón-Sánchez for her useful recommendations, and the Solitec Foundation (Spain) for its support in contributing with technical resources.

Author details

Alfonso Gago-Calderón^{1*}, Rami D. Orejón-Sánchez¹ and Manolo J. Hermoso-Orzáez²

*Address all correspondence to: agago@uma.es

¹ Department of Graphic Expression, Design and Projects, Universidad de Málaga, Spain

² Department of Graphic Expression, Design and Projects, Universidad de Jaen, Spain

References

- [1] Montoya F-G, Peña-García A, Juaidi A, Manzano-Agugliaro F. Indoor lighting techniques: An overview of evolution and new trends for energy saving. *Energy and Buildings*. 2017;**140**:50-60. DOI: 10.1016/j.enbuild.2017.01.028
- [2] Held G. *Introduction to Light Emitting Diode Technology and Applications*. Boca Raton, FL (USA): CRC Press; 2016. 161p. ISBN: 9781420076622
- [3] Jhunjhunwala A, Vasudevan K, Kaur P, Ramamurthi B, Bitra S, Uppal K. Energy efficiency in lighting: AC vs DC LED lights. In: *International Conference on Sustainable Green Buildings and Communities (SGBC)*; December 2016. IEEE. pp. 1-4
- [4] Ciriminna R, Meneguzzo F, Albanese L, Pagliaro M. Solar street lighting: A key technology en route to sustainability. *Wiley Interdisciplinary Reviews: Energy and Environment*. 2017;**6**(2). DOI: 10.1002/wene.218
- [5] Willems S, Aerts W. *Study and Simulation of a DC Micro Grid with focus on Efficiency, Use of Materials and Economic Constraints*. Leuven, Belgium: University of Leuven; 2014

- [6] Pimputkar S, Speck J-S, DenBaars S-P, Nakamura S. Prospects for LED Lighting. *Nature Photonics*. 2009;3(4):180-182. DOI: 10.1038/nphoton.2009.32
- [7] National Academies of Sciences. *Assessment of Solid-State Lighting, Phase Two*. Washington, DC (USA): The National Academies Press; 2017. 100 p. ISBN 978-0-309-45257-1. DOI: 10.17226/24619
- [8] Biber C. LED light emission as a function of thermal conditions. In *Twenty-Fourth Annual IEEE Semiconductor Thermal Measurement and Management Symposium, 2008. Semi-Therm 2008*; IEEE; 16-20 March 2008; San Jose, CA, USA. pp. 180-184. DOI: 10.1109/STHERM.2008.4509387
- [9] Waffenschmidt E. Direct current (DC) supply grids for LED lighting. *LED Professional*. 2015;48. Available from: http://www.100pro-erneuerbare.com/netze/publikationen/2014-10-Waffenschmidt-DC_Grid_for_LED-LpS2014/Waffenschmidt-DC_Grid_for_LED-LpS2014.pdf
- [10] Winder S. *Power Supplies for LED Driving*. 2nd ed. Newnes; 2016. p. 320. ISBN: 9780081010242
- [11] Gago-Calderón A, Fernández-Ramos J, Narvarte L. Temperature-controlled light-emitting diode lamp for photovoltaic rural applications. *Progress in Photovoltaics: Research and Applications*. 2013;21(2):232-239. DOI: 10.1002/pip.1170
- [12] International Energy Agency [IEA]. *Market-based Instruments for Energy Efficiency Policy Choice and Design*. Paris (France): OECD/IEA; 2017. Available from: https://www.iea.org/publications/insights/insightpublications/MarketBased_Instruments_for_Energy_Efficiency.pdf [Accessed: 2018-01-14]
- [13] Thielemans S, Di Zenobio D, Touhafi A, Lataire P, Steenhaut K. DC grids for smart LED-based lighting: The EDISON solution. *Energies*. 2017;10(10):1454. DOI: 10.3390/en10101454
- [14] Calderón A-G, Fernández L-N, Moreno L-M-C, Barba J-S. LED bulbs technical specification and testing procedure for solar home systems. *Renewable and Sustainable Energy Reviews*. 2015;41:506-520. DOI: 10.1016/j.rser.2014.08.057
- [15] Rosenheck T. *POE for Organizations with a Repetitive Building Type. Building Performance Evaluation*. Cham (Switzerland): Springer; 2018. pp. 183-192. DOI: 10.1007/978-3-319-56862-1_14
- [16] Tuenge J, Poplawski M. *PoE Lighting System Energy Reporting Study Part 1. Solid-State Lighting Program Building Technologies Office, Office of Energy Efficiency and Renewable Energy, U.S. Department of Energy*; 2017. PNNL-26284. Available from: https://energy.gov/sites/prod/files/2017/03/f34/ssl-poe-part1_feb2017.pdf [Accessed: 2018-01-14]
- [17] Wuthipong S. *MW Scale Stand-Alone PV Hybrid Mini Grid System. Presentation at World Alternative Energy Forum; Chiang Mai, Thailand, 1;-14. Dec. 2012*. Available from: <http://www.adicet.cmru.ac.th/waef2012/> [Accessed: 2018-01-14]

- [18] Vossos V, Johnson K, Kloss M, Khattar M, Gerber D, Brown R. Review of DC Power Distribution in Buildings: A Technology and Market Assessment. Lawrence Berkeley National Laboratory; 2017. Available from: <https://cloudfront.escholarship.org/dist/prd/content/qt2dd536p1/qt2dd536p1.pdf> [Accessed: 2018-01-14]
- [19] Boeke U, Wendt M. DC power grids for buildings. IEEE 1st International Conference on DC Microgrids; 7-10 June 2015; Atlanta, USA. pp. 180-184. DOI: 10.1109/ICDCM.2015.7152040
- [20] Fregosi D, Ravula S, Brhlik D, Saussele J, Frank S, Bonnema E, Wilson E. A comparative study of DC and AC microgrids in commercial buildings across different climates and operating profiles. IEEE 1st International Conference on DC Microgrids; 7-10 June 2015; Atlanta, USA. pp. 159-164. DOI: 10.1109/ICDCM.2015.7152031
- [21] Weiss R, Ott L, Boeke U. Energy efficient low-voltage DC-grids for commercial buildings. IEEE 1st International Conference on DC Microgrids; 7-10 June 2015; Atlanta, USA. pp. 154-158. DOI: 10.1109/ICDCM.2015.7152030
- [22] Zhang F, Meng C, Yang Y, Sun C, Ji C, Chen Y, Yang G. Advantages and challenges of DC microgrid for commercial building a case study from Xiamen university DC microgrid. IEEE 1st International Conference on DC Microgrids; 7-10 June 2015; Atlanta, USA. pp. 355-358. DOI: 10.1109/ICDCM.2015.7152068
- [23] Panguloori R, Mishra P, Kumar. Power distribution architectures to improve system efficiency of centralized medium scale PV street lighting system. *Solar Energy*. 2013;**97**:405-413. DOI: 10.1016/j.solener.2013.08.034
- [24] Khalil A, Rajab Z, Amhammed M, Asheibi A. The benefits of the transition from fossil fuel to solar energy in Libya: A street lighting system case study. *Applied Solar Energy*. 2017;**53**(2):138-151. DOI: 10.3103/S0003701X17020086
- [25] Park S, Kang B, Choi M, Jeon S, Park S. A micro-distributed ESS-based smart LED street-light system for intelligent demand management of the micro-grid. *Sustainable Cities and Society*. 2017. In Press. DOI: 10.1016/j.scs.2017.10.023
- [26] Loomba P, Asgotraa S. DC solar microgrids—A successful technology for rural sustainable development. 2016 IEEE PES Power Africa Conference; 28 June-3 July 2016; Livingstone, Zambia. DOI: 10.1109/PowerAfrica.2016.7556601

