

DCE
21

4th DOCTORAL
CONGRESS
IN ENGINEERING

DOCTORAL CONGRESS
IN ENGINEERING

Book of Abstracts



*Symposium on Electrical and
Computer Engineering*

DCE
21

4th DOCTORAL
CONGRESS
IN ENGINEERING

Book of Abstracts

of the

4th Symposium on Electrical and Computer Engineering

Editors:

J. Silva Matos, L. Almeida, M. Gaitán, W. Oliveira

Porto
June 2021

This volume contains the abstracts presented at the Symposium on Electrical and Computer Engineering, within the 4th Doctoral Congress in Engineering – DCE21, held online, between June 28th and 29th, 2021.

Title: DCE21- Symposium on Electrical and Computer Engineering: Book of Abstracts

Edited by: José Silva Matos, Luís Almeida, Miguel Gaitán, Waldri Oliveira

Published by: FEUP Edições

<https://doi.org/10.24840/978-972-752-276-7>

June 2021

ISBN. 978-972-752-276-7

Universidade do Porto, Faculdade de Engenharia, Departamento de Engenharia Eletrotécnica e de Computadores, Rua Dr. Roberto Frias s/n 4200-465 Porto, Portugal

This book contains information obtained from authentic sources. Reasonable efforts have been made to publish reliable data information. Still, the authors and the publisher cannot assume responsibility for the validity of all materials or the consequences of their use. Trademark Notice: Product or corporate names may be trademarks or registered trademarks and are used only for identification and explanation, without intent to infringe.

Copyright@FEUP and this Book of Abstract authors.

WELCOME

June 28th, Porto, Portugal

The **Symposium of Electrical and Computer Engineering (ECE)**, integrated in the 2021 edition of FEUP's Doctoral Congress of Engineering is an important showcase for PhD research in this broad and vibrant area, and an opportunity for doctoral students to interact, to improve communications skills, and to gather feedback on their research work.

The students of PDEEC, **FEUP's Doctoral Program in ECE**, played a major role in the organization of the Symposium. As members of the Technical Program Committee, they reviewed papers, helped putting together the program and became involved in the inner works of organizing this type of event. As participants in the Symposium, they also offer their views, share and develop new ideas, get involved in technical discussions. It is a learning experience!

With the help of the Technical Program Committee and of the Scientific Committee of PDEEC we have put together a rich program that, we hope, will be of interest to all participants. It includes three technical sessions (**Energy & Control Systems**, **Cyber-Physical Systems and Networks**, and **Sensing & Applications**) presenting research work on very relevant, timely and "hot" topics.

We will also have two panels that offer complementary views on a subject that should be of interest to all doctoral students: **PhDs in Industry**. We will have the views of former PDEEC students, who are now working in companies in Portugal and abroad, who will tell us about their experiences, and how the education they received proved valuable (or may be not?) in their current activities. In a second panel, we will hear and discuss the point of view of employers: what do they value and what do they look for when hiring a PhD graduate to work with them. In both panels we will have participants from innovation-leading companies that operate across multiple regions.

To top it up we will have a great keynote speech, given by a distinguished researcher: **Prof. Lothar Thiele, of ETH Zurich**. He will speak about the novel architectures, design processes and validation strategies that are needed to meet the dependability challenges of the Internet of Things.

To all doctoral students who submitted their work, and to all participants, we do hope you enjoy the Symposium, and make the most of this experience.

The Organizing Committee:

José Silva Matos
Luís Almeida
Miguel Gaitán
Waldri Oliveira

CONTENTS

Welcome	3
Contents	4-5
Committees	6
Programme	7-9
Keynote Speaker	10-11
Oral Presentations	12-52
Session 1 Energy & Control Systems	13-20
Comparison of L0 and L1 Path-Following Controllers for Airborne Wind <i>Sergio Vinha, Luís Tiago Paiva and Fernando A.C.C. Fontes</i>	13
Path-Following Model Predictive Control Scheme for Airborne Wind Energy Systems <i>Manuel C.R.M. Fernandes, Luís Tiago Paiva and Fernando A.C.C. Fontes</i>	14
Study of Parameter Influence in a High-Frequency Transformer Model <i>Luis Braña, Artur Costa and Ricardo Lopes</i>	15-17
Study on the Simple Pendulum: Experimental results with Kalman filter <i>Eduardo Azevedo and Waldri Oliveira</i>	18-20
Session 2 Cyber-Physical Systems and Networks	21-34
Design of a Context-Aware Routing System Model with Mobility Prediction for NDN-based VANET <i>Elidio Silva, Joaquim Macedo and António Costa</i>	21-23
Network Centrality: An insight for gateway designation in real-time wireless sensor networks <i>Miguel Gutiérrez Gaitán, Luís Almeida, Alejandro Figueroa and Diego Dujovne</i>	24-26
A Wireless Safety and Security Layer Architecture for Reliable Co-CPS <i>Enio Vasconcelos Filho, Ricardo Severino, Anis Koubâa and Eduardo Tovar</i>	27-29
Open Issues in Analyzing the Schedulability for the 3-Phase Task Model using Partitioned Scheduling <i>Jatin Arora, Cláudio Maia, Syed Aftab Rashid and Eduardo Tovar</i>	30-32
Towards the Safe Deployment of Runtime Monitors in Mode-Change Supported Cyber-Physical Systems <i>Giann Spilere Nandi, David Pereira, José Proença and Eduardo Tovar</i>	33-34

Session 3 Sensing & Applications	35-52
A Hybrid Supervised Approach for Human Robot Interaction with Children with Autism Spectrum Disorder <i>Vinicius Silva, Filomena Soares and João Sena Esteves</i>	35-37
Preliminary Simulation-based Feasibility Study for Breast Tumor Diagnosis Using Machine Learning <i>Raquel A. Martins, João M. Felício, Jorge R. Costa, Ana Fred and Carlos A. Fernandes</i>	38-40
Instrumented Suit for Clothing Design and Performance Improvement in Cycling <i>Miguel Velhote Correia and Waldri Oliveira</i>	41-43
Circuit Traces on Plastic Surfaces: Laser direct structuring allows selective metallization for sensors development and integration <i>Luciano Rietter, Ricardo Freitas and Filipa Carneiro</i>	44-46
Ka-band Low Loss and Cost MMIC-integration in Standard QFN-Package <i>H. Safdary and H. M. Salgado</i>	47-49
Sustainability Analysis of Complex Multi-Lane Intelligent Signalized Intersections <i>Radha Reddy, Luís Almeida, Miguel Gaitán, Pedro Santos and Eduardo Tovar</i>	50-52
Authors Index	53-54

COMMITTEES

Organizing Committee

José Silva Matos | FEUP

Luís Almeida | FEUP

Miguel Gaitán | FEUP

Waldri Oliveira | FEUP

Scientific Committee

José Silva Matos | FEUP

Luís Almeida | FEUP

Manuel Ricardo | FEUP

Nuno Fidalgo | FEUP

João Paulo Cunha | FEUP

Technical Program Committee

Motaz M. A. Ayiad | FEUP

Yousef Emami | FEUP

Yassine Boukili | FEUP

Radha Reddy | FEUP

Mubarak Ojewale | FEUP

João Ribeiro Pinto | FEUP

Jatin Arora | FEUP

Ishfaq Hussain | FEUP

Helder Henrique Avelar | FEUP

Hassan Safdary | FEUP

Giann Nandi | FEUP

Ênio Vasconcelos Filho | FEUP

Flávia Pires | FEUP

Vítor Morais | FEUP

Yillian Ribot | FEUP

PROGRAMME

Day 1 – 28th June, 2021

Global activities – 08h30 - 10h00

Session 1 – 10h00 - 11h15 | Energy & Control Systems

Chaired by José Nuno Fidalgo and Miguel Gaitán

- **Comparison of L0 and L1 Path-Following Controllers for Airborne Wind**
Sergio Vinha, Luís Tiago Paiva and Fernando A.C.C. Fontes
 - **Path-Following Model Predictive Control Scheme for Airborne Wind**
Manuel C.R.M. Fernandes, Luís Tiago Paiva and Fernando A.C.C. Fontes
 - **Study of Parameter Influence in a High-Frequency Transformer Model**
Luis Braña, Artur Costa and Ricardo Lopes
 - **Study on the Simple Pendulum: Experimental results with Kalman filter**
Eduardo Azevedo and Waldri Oliveira
-

Break – 11h15 - 11h30

Panel 1 – 11h30 - 13h00 | PDEEC Training & Industry – the view of Alumni

Moderated by Manuel Ricardo

With the participation of:

- Tânia Calçada | Sonae MC
 - Dakshina Dasari | Bosch
 - Filipe Abrantes | Citizen - Twitter Group
 - Manuel José Costeira da Rocha | Smart Energy
 - Xuanle Ren | Alibaba Group
-

Global activities – 13h00 – 15h00

PROGRAMME

Keynote Talk – 15h00 - 16h00

Chaired by Luís Almeida

Invited Talk:

- **Internet of Things – The Quest for Dependability**
by Prof. Dr. Lothar Thiele, *ETH Zurich, Switzerland*

Break – 16h00 - 16h30

Session 2 – 16h30 - 18h00 | Cyber-Physical Systems and Networks

Chaired by Luís Almeida and Waldri Oliveira

- **Design of a Context-Aware Routing System Model with Mobility Prediction for NDN-based VANET**
Elidio Silva, Joaquim Macedo and António Costa
- **Network Centrality: An insight for gateway designation in real-time wireless sensor networks**
Miguel Gutiérrez Gaitán, Luís Almeida, Alejandro Figueroa and Diego Dujovne
- **A Wireless Safety and Security Layer Architecture for Reliable Co-CPS**
Enio Vasconcelos Filho, Ricardo Severino, Anis Koubâa and Eduardo Tovar
- **Open Issues in Analyzing the Schedulability for the 3-Phase Task Model using Partitioned Scheduling**
Jatin Arora, Cláudio Maia, Syed Aftab Rashid and Eduardo Tovar
- **Towards the Safe Deployment of Runtime Monitors in Mode-Change supported Cyber-Physical Systems**
Giann Spilere Nandi, David Pereira, José Proença and Eduardo Tovar

Global activities – 18h00 – 18h45

PROGRAMME

Day 2 – 29th June, 2021

Global activities – 08h30 - 09h00

Session 3 – 09h10 - 11h00 | Sensing & Applications

Chaired by José Silva Matos and Flávia Pires

- **A Hybrid Supervised Approach for Human Robot Interaction with Children with Autism Spectrum Disorder**
Vinicius Silva, Filomena Soares and João Sena Esteves
- **Preliminary Simulation-based Feasibility Study for Breast Tumor Diagnosis Using Machine Learning**
Raquel A. Martins, João M. Felício, Jorge R. Costa, Ana Fred and Carlos A. Fernandes
- **Instrumented Suit for Clothing Design and Performance Improvement in Cycling**
Miguel Velhote Correia and Waldri Oliveira
- **Circuit Traces on Plastic Surfaces: Laser direct structuring allows selective metallization for sensors development and integration**
Luciano Rietter, Ricardo Freitas and Filipa Carneiro
- **Ka-band Low Loss and Cost MMIC-integration in Standard QFN-Package**
Hassan Safdary and Henrique M. Salgado
- **Sustainability Analysis of Complex Multi-Lane Intelligent Signalized Intersections**
Radha Reddy, Luís Almeida, Miguel Gaitán, Pedro Santos and Eduardo Tovar

Break – 11h00 - 11h30

Panel 2 – 11h30 - 13h00 | PDEEC Training & Industry – The view of employers

Moderated by João Paulo Cunha

With the participation of:

- João Barros | VENIAM
- Cipriano Lomba | EFACEC
- Mario Machado Leite | LNEG
- Eduardo Marques Pereira | Loggi
- Célio Alburquerque | Synopys

Global activities – 13h00 – 18h00

KEYNOTE SPEAKER

Short Bio



Prof. Dr. Lothar Thiele

*ETH Zurich, Switzerland
Swiss Federal Institute of Technology Zurich
Computer Engineering and Networks Laboratory*

Lothar Thiele joined ETH Zurich, Switzerland, as a full Professor of Computer Engineering, in 1994.

His research interests include models, methods and software tools for the design of real-time embedded systems, internet of things, cyberphysical systems, sensor networks, embedded software and bioinspired optimization techniques.

Lothar Thiele was associate editor of INTEGRATION - the VLSI Journal, Journal of Signal Processing Systems, IEEE Transaction on Industrial Informatics, Journal of Systems Architecture, and is still active in IEEE Transactions on Evolutionary Computation, Journal of Real-Time Systems, ACM Transactions on Sensor Networks, ACM Transactions on Cyberphysical Systems, and ACM Transaction on Internet of Things.

In 1986 he received the "Dissertation Award" of the Technical University of Munich, in 1987, the "Outstanding Young Author Award" of the IEEE Circuits and Systems Society, in 1988, the Browder J. Thompson Memorial Award of the IEEE, and in 2000-2001, the "IBM Faculty Partnership Award". In 2004, he joined the German Academy of Sciences Leopoldina. In 2005, he was the recipient of the Honorary Blaise Pascal Chair of University Leiden, The Netherlands. Since 2010, he is a member of the Academia Europaea. In 2013, he joined the National Research Council of the Swiss National Science Foundation SNF. Lothar Thiele received the "EDAA Lifetime Achievement Award" in 2015. Since 2017, Lothar Thiele is Associate Vice President of ETH for Digital Transformation. Lothar Thiele has been elected IFIP Fellow by the International Federation for Information Processing (IFIP) as part of its first cohort of fellows in 2020. In 2021, he received the IEEE TCRTS Achievement and Leadership Award.

See <https://people.ee.ethz.ch/~thiele/> for more information.

KEYNOTE SPEAKER

Invited Talk

June 28th, 15h00 – 16h00

Internet of Things – The Quest for Dependability

If visions and forecasts of industry come true then we will be soon surrounded by billions of interconnected embedded devices. We will interact with them in a cyber-human symbiosis, they will not only observe us but also our environment, and they will be part of any visible and ubiquitous objects around us. We have the legitimate expectation that the individual devices as well as the overall system behaves in a reliable, predictable and trustworthy manner.

Besides, there are many application domains where we rely on a correct and fault-free system behavior. We expect trustworthy results from sensing, computation, communication and actuation due to economic importance or even catastrophic consequences if the overall system is not working correctly, e.g., in industrial automation, distributed control of energy systems, surveillance, medical applications, or early warning scenarios in the context of building safety or environmental catastrophes. Finally, trustworthiness and reliability are mandatory for the societal acceptance of human-cyber interaction and cooperation.

It will be argued that we need novel architectural concepts, an associated design process and validations strategies to satisfy the strongly conflicting requirements and associated design challenges of platforms for the Internet of Things: Handle at the same time limited available resources, adaptive run-time behavior, and predictability. These challenges concern all components and functions of an IoT system, e.g., information extraction from global data, local decision making, computation, storage, wireless communication, energy management, energy harvesting, sensors, sensor interfaces, and actuation. The focus of the presentation is on new models and methods as well as examples from various fields in environmental monitoring.

ORAL PRESENTATIONS

Comparison of L0 and L1 path-following controllers for Airborne Wind Energy Systems

Sérgio Vinha^{*1}, Luís Tiago Paiva^{*2}, Fernando A.C.C. Fontes^{*3}

^{*}Systec-ISR, Faculty of Engineering, University of Porto

¹svinha@fe.up.pt, ²ltpaiva@fe.up.pt, ³faf@fe.up.pt

Abstract

In the last decades, renewable energy is gaining increasing attention from the research community and new technologies, trying to further exploit renewable sources, are emerging. An example is AWES - Airborne Wind Energy Systems (Schmehl 2018). These systems generate electricity using tethered wings (kites) that harvest high altitude winds.

In this work, we address the testing of trajectory controllers for kites to follow a prescribed geometric path. For that, we analyze the path-following guidance method reported in (Silva 2019) and implemented in *Ardupilot* software. This controller is a modification of the nonlinear guidance logic described in (Park 2004).

The navigation control is done by using the $L1$ distance reference to the desired point in the trajectory. We compute the angle η between the kite current velocity \dot{p} and $L1$ and perform the required lateral acceleration. An adjustment to this controller was performed. We define the closest point in the path and then a reference target point is defined as the point distancing $L0$ from the closest point in the path. In the end, the $L1$ resulting from this approach is given by the calculating the hypotenuse between the cross-track distance d , to the path and the distance $L0$.

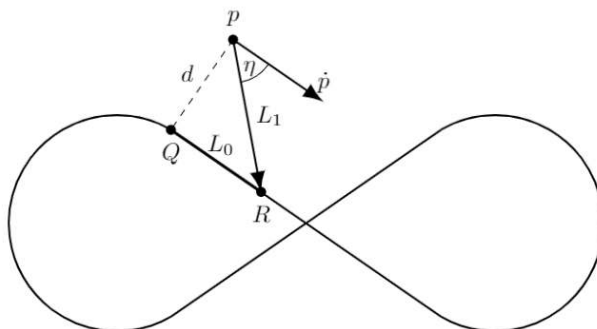

Figure 1 - Path to be followed and signals included.

The two methods were simulated and compared by the help of *JSBSim* under, for example, fast changing wind conditions, such as wind gusts.

We can conclude that the new guidance method is capable of following the desired path through software-in-the-loop simulations with *Ardupilot*. It is possible to follow the path, even when the aircraft is distant from the desired one, without adding new conditions to the old controller. A stable $L0$ can be adjusted accordingly to the flight characteristics of the aircraft.

Keywords Airborne Wind Energy Systems, *Ardupilot*, Guidance Logic, Path-following, UPWIND

References

- Schmehl, Roland. 2018. "Airborne Wind Energy: Advances in Technology Development and Research". Green Energy and Technology. Springer Singapore.
- Silva, Gonçalo B., Paiva, Luís Tiago and Fontes, Fernando A.C.C.. 2019. "A Path-following Guidance Method for Airborne Wind Energy Systems with Large Domain of Attraction". In 2019 American Control Conference (ACC), 2771–76.
- Park, Sanghyuk, Deyst, John and How, Jonathan. 2004. "A New Nonlinear Guidance Logic for Trajectory Tracking". In AIAA Guidance, Navigation, and Control Conference and Exhibit. Providence, Rhode Island: American Institute of Aeronautics and Astronautics. <https://doi.org/10.2514/6.2004-4900>.

Path-Following Model Predictive Control Scheme for Airborne Wind Energy Systems

Manuel C.R.M. Fernandes¹, Luís Tiago Paiva², Fernando A.C.C. Fontes³

¹SYSTEC-ISR/FEUP - mcrmf@fe.up.pt

²SYSTEC-ISR/FEUP/FEP - ltpaiva@fe.up.pt

³SYSTEC-ISR/FEUP - faf@fe.up.pt

Abstract

Airborne Wind Energy Systems (AWES) aim at harvesting wind power at higher altitudes than conventional wind turbines, where wind speeds are generally stronger and more consistent (Schmehl 2018). There are several different concepts. One of the most researched and more promising concepts are Pumping Kite Generators (PKG).

PKG comprise a kite (or airfoil) connected through a tether which is coiled around a winch drum coupled to a generator placed on the ground. Its operation relies on a cycle with a power productive and a power consuming phase. During the first phase the kite is steered to follow a fast crosswind motion which maximizes the power withdrawn from the wind, reeling out the tether and forcing the generator to produce electricity. During the second phase the kite is controlled in such a way that minimizes the power extracted from the wind and the generator works as a motor to recoil the tether, thus restarting the cycle. The cycle net energy output is positive due to a proper kite control which maximizes power production and minimizes power consumption during the first and second phases, respectively. For a reliable and performant operation, the kite must follow a predefined path, typically a figure-of-eight, during its power productive phase.

In this work, we present a combined control architecture summing a basis controller term and a Model Predictive Control (MPC) term to improve the controller performance. The chosen basis controller has been shown to have a large domain of attraction and asymptotic stability (Silva 2019). The proposed MPC framework uses a Lyapunov function pair for the system as Lagrange and Mayer costs, thus guaranteeing stability and convergence to the path (Fontes 2001). The combined control strategy holds several benefits, since the basis controller serves as an already feasible and stabilizing initial guess for the MPC, thus increasing the optimization process efficiency, and serves as a backup in case we are not able to find a better solution.

Keywords. Airborne Wind Energy; Model Predictive Control; Path-Following; Pumping Kite Generator.

References

- Schmehl, Roland, ed. 2018. "Airborne Wind Energy: Advances in Technology Development and Research". Green Energy and Technology. Springer Singapore.
- Silva, Gonçalo B., Luís Tiago Paiva and Fernando A.C.C. Fontes. 2019. "A Path-following Guidance Method for Airborne Wind Energy Systems with Large Domain of Attraction". In 2019 American Control Conference (ACC), 2771-7.
- Fontes, Fernando A.C.C. 2001. "A General Framework to Design Stabilizing Non-Linear Model Predictive Controllers". Systems & Control Letters, Volume 42, Issue 2, 127-143.

Study of Parameter Influence in a High-Frequency Transformer Model

L. Braña^{1,2}, A. Costa² and R. Lopes¹

¹ Efacec Transformers R&D - Apartado 1018 • 4466-952 S. Mamede de Infesta, Portugal
e-mail: luis.brana@efacec.com, ricardol@efacec.com

² Department of Electrical Engineering, FEUP, University of Porto, Rua Roberto Frias, 4200-465 Porto, Portugal
e-mail: acosta@fe.up.pt

Abstract

This paper presents a high-frequency model to be integrated into a time-domain equivalent circuit. The model is based on a lumped parameter network, which models the internal geometry of the transformer in detail. The high-frequency component of this model has been validated through Small-Signal Internal Voltage Transfer measurements obtained by the Cigré JWG A2/C4.52 in a power transformer used as a reference for the working group. Several parameters which are frequency dependent have been parametrized and calibrated with experimental data in order to analyze the accuracy and consistency of the model for predicting the transient response of the transformer at high frequency.

Keywords. Electromagnetic Transients, Power Transformer, Simulation, White-Box Model.

1. Introduction

When modeling a transformer to perform electromagnetic transient studies, transformers are usually represented with different detail level depending on the model application. The applied model in this work is a lumped parameter network which represents in detail the internal geometry of the transformer in a white-box model (Cherry 1949). The model has been established from geometrical and constructional information from the manufacturer, together with available material characteristics.

2. White-Box Modelling

The transformer manufacturers make use of detailed models, the so-called white-box model for predicting the internal voltage stresses. The main concept of white-box modelling is to represent the transformer topology through passive elements in an electrical circuit.

In the applied model depicted in Figure 1, each winding is composed of different cells linked in series. Windings are linked each other through parallel capacitances (C_{db}/C_{dc}) and to the core through ground capacitances. Each cell as the one depicted in Figure 2 represents a group of turns, including series and parallel capacitance, self and mutual inductance, a resistance for ohmic losses, and a resistance which governs the damping of the electrical equivalent circuit.

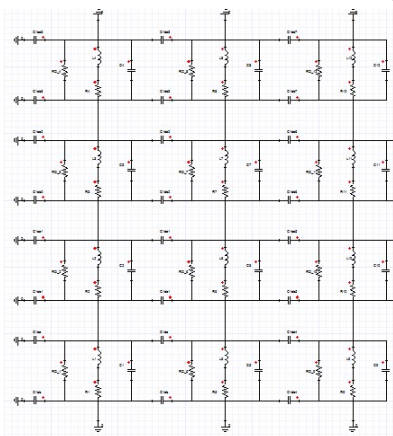

Figure 1. Transformer model.

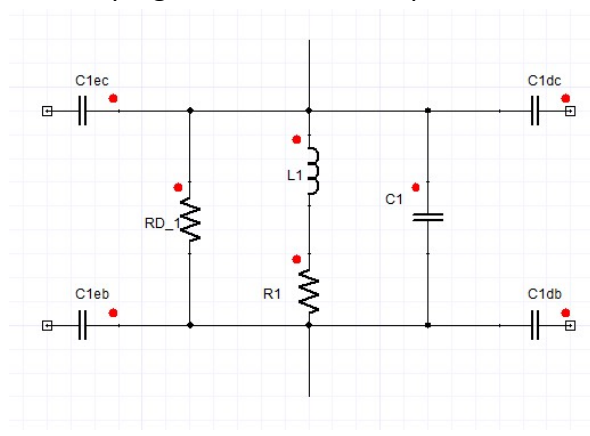

Figure 2. Detailed cell.

3. Experimental Test

Calibration of a transformer model can only be performed by comparing its response with experimental data. For low frequencies, this can be achieved by no-load and short circuit tests. At high frequencies, the model can only be validated through non-standard tests as the Small Signal Internal Voltage Transfer Measurement Test.

The Small Signal Internal Voltage Transfer Measurement Test is a more modern approach. In this test voltage responses are obtained using voltage transfer frequency sweep measurements that are converted into time-domain waveforms through recursive convolutions (Gustavsen et al. 2016). This procedure presents few uncertainties in measurement accuracy.

3.1. Transformer Data

The tested transformer is a three-leg, 50 MVA, core-type, one-phase power transformer with a rated frequency of 60 Hz. The rated voltages are 220 kV, 69 kV, and 50 kV for the high voltage, low voltage, and tertiary voltage respectively with connection YN_ynd. Bushing Insulation Level for High Voltage is AC 395 kV_{rms} / SI 850 kV_{peak} / LI 1050 kV_{peak}.

3.2. Voltage Transfer Measurements

The basic approach is to measure the voltage transfer function from one transformer terminal to a second terminal, as a function of discrete frequency. The voltage transfer function $h(\omega)$ is defined as the response voltage $V_2(\omega)$ divided by the excitation voltage $V_1(\omega)$.

A large set of measurements of node-ground voltages were performed, representing voltage transfer between external terminals. In addition, the voltage transfer from external terminals to three points (R1, R5, R11) inside the tap changer was measured.

4. Model Parametrization

A critical point in the transformer modeling is to calculate with enough accuracy the model parameters since the degree of accuracy will be highly dependent on the lumped parameter network.

This work intends to assess the influence of key parameters of a high-frequency transformer model. These parameters are frequency-dependent and somehow unknown for the transformer designer.

4.1. Permeability Parametrization

In this study, several simulations have been performed with core relative magnetic permeabilities of 0.1, 1, and 1000. Magnetic core has been designed for a 2D axisymmetric model according to (Steurer and Frohlich 2002) keeping a constant section along the radial dimension

4.2. Permittivity Parametrization

Although for this transformer the experimental data has been taken in a transformer still not filled with oil, pressboard is partially impregnated of this material thus its permittivity has been calibrated. In this work simulations with air and impregnated oil in the pressboard have been performed.

4.3. Model Discretization

At high frequencies, each winding is considered as a transmission line in which lumped equivalent parameters represent the magnetic and electric characteristics of the turns. Nevertheless, a model turn-to-turn may be unapproachable due to the computational effort required by a complex geometry. Therefore, turns are grouped into cells.

A cell can represent a group of disks or a single one, depending on the desired accuracy. Each cell should be small enough in order to assume that the current which flows is constant and is not influenced by displacement currents. The greater number of cells, the more accurate and slower is the model thus a compromise must be achieved between computational speed and time. In this work, several models with different refinement degrees have been tested.

5. Results

Voltage transferred measurements were performed between different terminal points applying voltage with standardized shape (1.2 / 50 μ S).

5.1. Permeability

Results showed a good correlation with measured values. Simulations with the highest permeability show a phase displacement regarding measured values. On contrary, relative permeabilities less than the unity show better phase agreement with measured values in line with previous studies (Gharehpetian, Mohseni, and Moller 1998). This fact is due to the fact that at high and very high frequencies magnetic flux does not penetrate the magnetic core on account of the displacement currents which are significant at this range of frequencies (Sánchez Lago 2013).

5.2. Permittivity

Simulations with impregnated oil show a phase displacement. This can be explained due to a greater capacitance, which in turn increases the frequency of the response if the model is simplified as a simple RLC circuit. Amplitude between simulations does not dramatically change, thus the parameter can vary its value between the range of air and impregnated oil.

5.3. Geometry Refinement

In the calculated results there are non-significant differences between the refined models thus the partially refined model seems to be the best option in terms of the balance between accuracy and computational time, considering that each simulation took about 15 minutes compared with the 80 minutes of the fully refined model.

References

- Cherry, E. C. 1949. 'The Duality between Interlinked Electric and Magnetic Circuits and the Formation of Transformer Equivalent Circuits'.
- Gharehpetian, G.B., H. Mohseni, and K. Moller. 1998. 'Hybrid Modelling of Inhomogeneous Transformer Winding for Very Fast Transient Overvoltage Studies'. *IEEE Transactions on Power Delivery* 13 (1): 157–63. <https://doi.org/10.1109/61.660873>.
- Gustavsen, Bjørn, Alvaro Portillo, Rodrigo Ronchi, and Asgeir Mjelve. 2016. 'High-Frequency Modeling and Simulation of a Single-Phase Three-Winding Transformer Including Taps in Regulating Winding', November.
- Sánchez Lago, Luis. 2013. 'Modelo Unificado Físico-Terminal Para Transformadores, Universidade de Vigo'.
- Steurer, M., and K. Frohlich. 2002. 'The Impact of Inrush Currents on the Mechanical Stress of High Voltage Power Transformer Coils'. *IEEE Transactions on Power Delivery* 17 (1): 155–60. <https://doi.org/10.1109/61.974203>.

Acknowledgments

This work has been co-funded under the European Framework P2020 incentive program to the Portuguese Industry. The project acronym is GreenEst (Project POCI-01-0247-FEDER-033811).

Study On the Simple Pendulum: Experimental Results with Kalman Filter

Eduardo Azevedo ¹, Waldri Oliveira ²

¹INESCTEC/FEUP, University of Porto, Portugal – eduardo.a.azevedo@inesctec.pt

²INESCTEC/FEUP, University of Porto, Portugal – waldri.oliveira@fe.up.pt

Abstract

This work describes an experiment to detect and identify the movement of a simple pendulum. The back-and-forth motion of a swing demonstrates the physics of a pendulum. In this experiment, you will investigate the factors that affect the speed and duration of an oscillating motion. The tasks are carried out to estimate the states of the system using sensors. A Kalman filter (KF) is used to estimate the fundamental parameters from inaccurate measured data [[Del Gobbo et al. 2001]]]. For a realistic assessment of its performance, the detection scheme was implemented in a simple pendulum and aided by the image analysis software. The system is tested under several initial conditions, observed by sensors installed at different points, and experimental results are presented to validate the approach's effectiveness.

Author Keywords. Kalmann filter. Pendulum. Arduino.

1. Introduction

The object of study is a simple pendulum (Figure 1a), which oscillates free of resistance forces around a fixed point "O". Using two Arduino boards associated with two sets of sensors, an accelerometer and gyroscope. One plate installed with the sensors at the base of the pendulum rod and the other at the rod's tip. The used sensor, the MPU9250 (Figure 1b), include accelerometers, gyroscopes, and magnetometers. The accelerometer can measure acceleration experienced by a body. The gyroscope is a sensor that uses the piezoelectric force to indicate the angular velocity of a given object in space, identifies the turning on its axis. The magnetometer is used to detect magnetic fields.

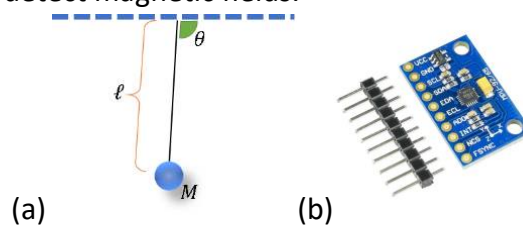

Figure 1: Methodology and sensors used for this work.

Because of the two sensors (accelerometer and gyroscope), since one measures the acceleration of a body, the other measures the position thereof, are commonly employed together, seeking to make more accurate measurements. Such an approach is called a sensor fusion. A more effective strategy is using the Kalman filter, wherein each sensor provides information for each system state. In the experiments we used two models of microcontrollers, Arduino Mega 2560 and Arduino Uno. In this proposal, we use the Arduino as a programmable tool for data collection. What sets the function of this board is the way it is programmed, and its programming language based on C / C ++ languages. The integration of the Arduino with MATLAB is performed to make it possible to read data via USB communication/serial. The sensor data collection is completed and recorded in MATLAB environment, but it is necessary to pre-Arduino programming in their IDE (Integrated Development Environment). With the help of a video camera, the Tracker software makes motion analysis using image recognition, which is obtained the actual measurements of the angles. The Tracker is a free online software for analysis and modelling Open-Source Physics (OSP) Java framework designed for physics education. The Tracker interface carried out the analysis frame by frame of the physical behavior of the experiment, recording the position and velocity of the impactor through the images in the video.

2. Test the predictions using an accelerometer and gyroscope.

The experimental test for the theoretical model presented here was carried out with an impactor with a stem of 45 cm, weight 0.2 kg. In initial testing, we used a set of sensors located in the pendulum's mass, then a second set of the exact origin of the shank to capture data from a different perspective. The pendulum and the plates were fixed on a whiteboard with the available angles marked. Thus, it was possible to minimize the movement in the direction perpendicular to the plane formed by the x and y axes of the accelerometer, allowing the approach movement in two dimensions only, reducing interference and noise within the system, and improving the video capture. Applying the Kalman filter in the experimental model of sensors at the end of the pendulum (Figure 3a) with the Kalman filter results with the measured data (Figure 3b).

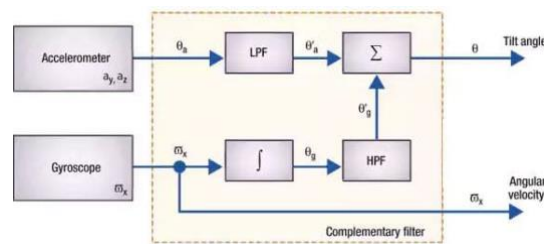

Figure 2: Accelerometer and gyroscope for additional filtering (Felipe,)

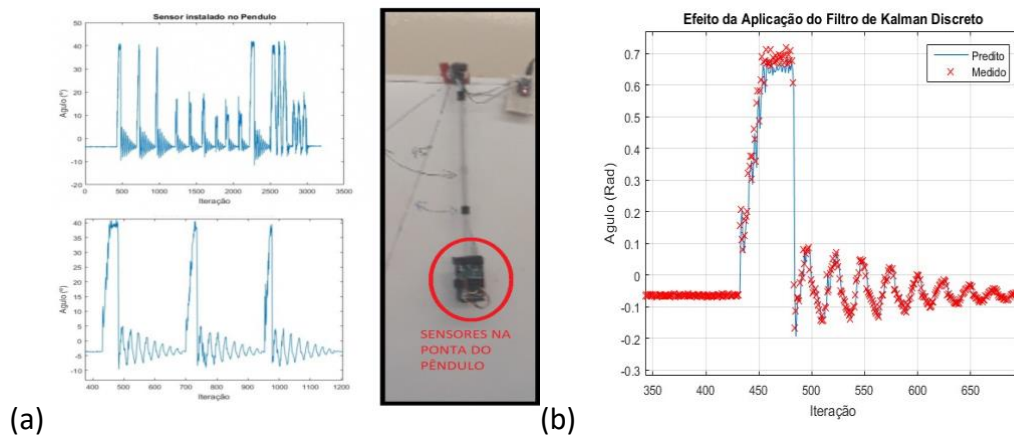

Figure 3: The Kalman filter with the sensors at the end of pendulum.

In Figure 4a, there is recorded sensor data located at the origin of the shank by the sensors. The data collected have greater resemblance to the characteristics of the simple pendulum motion. Figure 4b illustrates the application of the Kalman filter in the experimental model of the sensors at the origin of the pendulum rod in the filter response blue and red given the measurement z [1].

2.1. Additional analysis with the Tracker

Figure 5a analyzes the pendulum state with sensors at the origin of three ways, in blue the response of the Kalman algorithm in red sensor data, to measure the accelerometer being completed and corrected by the gyro, and finally, in green, the analysis of the Tracker by filming. It is noticed that the data are very close, just after the external manual interference (or input torque) stop in the displacement occurred between samples from 1150 to 1200, the system starts to act freely as a studied model. Figure 5b, compared to the same tracker data was performed, but now using the sensors installed on the mass of the pendulum. The data recorded by the sensors differ in the origin of the rod and by image analysis of the captured motion tracker.

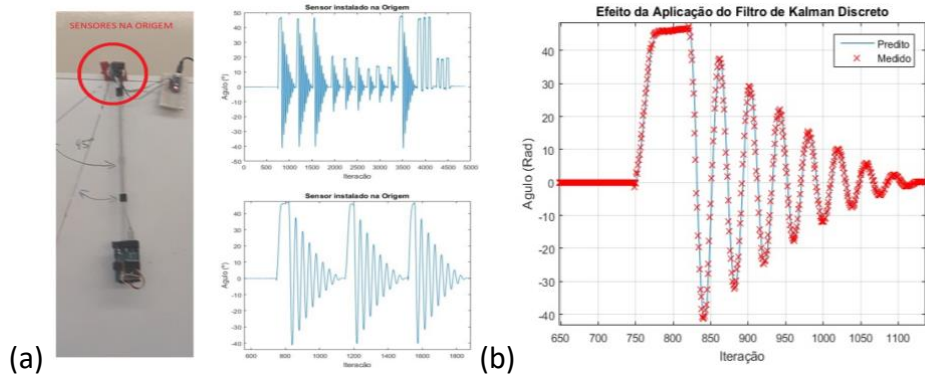

Figure 4: The recorded sensor data located at the origin of the shank with the filter.

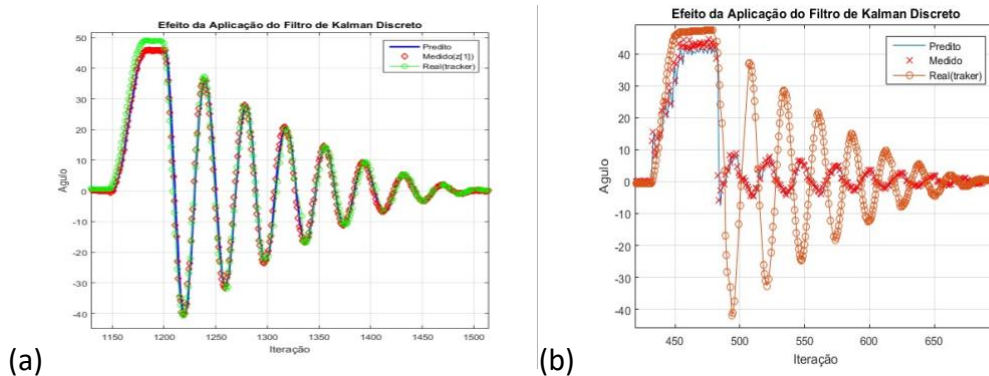

Figure 5: Comparing the measured data, the Kalman filter and the Tracker.

3. Conclusion

When the experiment recorded by the set of sensors at different points of the pendulum is analyzed, there is a significant divergence between them. Considering that the Tracker data is accurate measurements, it is concluded that the measurement with sensors in the non-inertial reference, that is, when the sensors are installed in the pendulum mass, is at least inefficient. According to [Silva et al. 2020], “any object placed in the center of oscillation is free from tangential forces”, that is, once the pendulum is in a free fall regime, its gravitational acceleration in its referential is null. Therefore, it is impossible to obtain this state, angular position, using the accelerometer installed in the pendulum. On the other hand, when observing the analysis of the second state, the angular velocity, it is concluded that it is perfectly possible to measure it at any point on the pendulum, regardless of the referential. The graphs show that the Kalman filter is an excellent state estimator and can be used in any linear or nonlinear linear model. Since it was possible to use data from different sensor types, the algorithm proved to be an excellent strategy to perform the fusion of sensors. For future work, the authors intend to apply this knowledge in the dynamics of robotic navigation systems, where more complex curvilinear movements and varying parameters occur, and such systems being constantly disturbed by external and control actions.

References

- Del Gobbo et al. 2001, Napolitano, M., Famouri, P., and Innocenti, M. Experimental application of extended Kalman filtering for sensor validation. *IEEE transactions on control systems technology*, 9(2):376–380.
- N. Felipe. Introdução a Fusão de sensores. 2017. Disponível em <<https://www.embarcados.com.br/introducao-fusao-de-sensores-parte-1/>>. Acesso em: 12 de agosto de 2020
- Silva, C. B. C. d., Fagundes, B. B., Ribeiro, J. D., Tonel, A. P., Silveira, F. L. d., and Dorneles, P. F. (2020). Forças no sistema de referência acelerado de um pêndulo: estudo teórico e resultados experimentais. *Revista Brasileira de Ensino de Física*, 42.

Design of a Context-Aware Routing System Model with Mobility Prediction for NDN-based VANET

Elídio Tomás da Silva, Joaquim Melo H. de Macedo, António Luís D. Costa
Algoritmi Centre, School of Engineering - University of Minho

Abstract

The current internet architecture was originally designed for point-to-point communications, and have the content location as the key element for communications. The adaptation of this architecture to the emerging communication requirements, such as the specific for Vehicular Ad hoc Networks (VANET), is challenging. In fact, aspects such as node mobility, content privacy, network security, and scalability, are still research challenges. Some emerging architectures, e.g., Named Data Networking (NDN) are designed with those aspects in consideration. NDN can provide better management of VANET, due to its name-based routing, In-network caching, and built-in data security. This work aims at leveraging the characteristics of NDN in VANET, to address the aforementioned issues. NDN-based context-aware routing, and caching, are the main topics to be explored in this work. Moreover, the mobility prediction will be applied for reducing the frequency of beacon broadcasts. The final goal is to improve the network performance, and provide quality requirements, demanded by the user. Herein, only the justification of the needs is presented, a model design is currently undergoing.

Author Keywords. Vehicular Ad hoc Networks, Named Data Networking, Routing, Mobility prediction, Caching.

1. Introduction

The development of Intelligent Transportation Systems (ITS) is intimately attached to the development of vehicular communications. In turn, the development of vehicular communications presents specific challenges, due to their intrinsic characteristics, such as frequent network partitioning, highly dynamic topology, short-lived links between nodes, etc.

Among these challenges, a specific topic (i.e., Routing), has seen a crescent interest among the research community within the network communications area. One of the main challenges in designing a routing protocol in VANET is the management of routes to the content source, which is precisely related to the high node speed, and the aforementioned resulting characteristics.

State-of-the-art NDN-based solutions do not maintain routes in the forwarding table, i.e., the Forwarding Information Base (FIB). Instead, they resort to packet broadcasting to forward the Interest to the content source. Broadcasting in a wireless channel can be disastrous, when each forwarding node overhearing each packet, re-broadcasts it back to the network without some kind of broadcast control. The result of this procedure is dubbed a broadcast storm problem. Although some of these proposed solutions include specific mechanisms to avoid the broadcast storm problem, the level of network traffic produced by broadcast is not negligible. A more efficient mechanism to forward packets, without flooding them is still necessary.

A means to overcome this issue, and improve routing in VANET, is the use of localization systems to track the location and the trajectory of a vehicle in a given network. The widespread development of localization systems has brought opportunities for the development of several mobility prediction schemes. Knowing the possible trajectory of a sender or requester node, the network can forward the requested packets towards those trajectories or through nodes with similar trajectories, instead of blindly broadcasting the packets through the network. Moreover, due to node mobility, identifying the contents exclusively by their relative location in the network is problematic. In fact, it can result in a network scalability problem, given that the range of ID to identify the locations is

limited by the chosen protocol (i.e., IPv4, IPv6). Named Data Networking (NDN) (Zhang et al. 2010), a specific realization of Content-Centric Networks (CCN) (Jacobson et al. 2009), identifies the contents by their names instead of the relative location. The namespace in this case is infinite, and given a content name, any node can request and share the content independently of their relative location. This characteristic (i.e., name-based content identification and routing) brings another important architectural advantage of NDN, the capacity of sharing the existing content with whoever requests the content, and without the need to request it from the original content source.

2. Routing model design

In order to survey the state-of-the-art of NDN-based VANET solutions, a Systematic Literature Review (SLR) was performed in (Silva, Macedo, and Costa 2021)

The result of the aforementioned study indicates that although some proposals applied NDN-based routing for VANET, none of them included the mobility prediction to help updating the list of neighbors and in selecting better relays nodes for packet forwarding, avoiding broadcasting. Existing solutions resort mainly on Interest flooding to content discovery, and do not leverage the in-network Caching for routing decisions. Actually, the study by (Duan et al. 2018) considers the use of Caching for content discovery but does so by allowing each vehicle in the network to perform flooding, requesting each other node to share the list of their cached content. None of the surveyed solutions considers the different network scenarios, and do not adapt the solution to the characteristics of the network where the model is applied, i.e., they are not context-aware.

This work aims at proposing a context-aware routing model, designed to resort on mobility prediction in order to forward packets to specific nodes whose trajectories are known, and avoid whenever possible, the broadcasting. To leverage Caching for routing decision the vehicles will share their list of cached contents but, instead of allowing all vehicles to broadcast their list, a request-based mechanism from the Road-Side Unit (RSU) is adopted, and only the vehicles on the path from the content source to the RSU will be allowed to share the list of cached contents. The list of cached contents, is periodically updated by means of overhead packets from intermediate nodes, and by the mobility algorithm.

Although processing capacity is considered as not being a constraint in VANET, it is still not obvious to what extent this capacity will really be supported. Having this aspect in mind, the present proposal is designed to consider two models for mobility prediction: 1) Short-term mobility prediction - which will run on all moving nodes. It will be mainly used to update the list of neighbor nodes and help the forwarding plane on sending packets to specific nodes; and 2) Long-term mobility prediction - which will run on all static nodes (i.e., RSU). The long-term mobility prediction will be more complex and will be based on the node mobility history. The reason to run a more complex mobility prediction algorithm on the RSU is that they will have a broader knowledge of the network and will possibly be equipped with more powerful computing resources.

Several existing mobility prediction proposals consider only the spatial dimension. To further improve the prediction accuracy, the long-term mobility prediction will include the temporal dimension. Existing proposals, e.g. (Mathew, Raposo, and Martins 2012), include the temporal dimension by clustering the trajectory history, in a predetermined and fixed number of clusters. The present proposal will encode each pair of <location, timestamp> as an observation that will feed the mobility prediction module.

Although NDN routing is name based, each packet flowing in the network will be adapted to carry optional information about the ID of the node sending or forwarding the packet. The inclusion of this information is optional in the sense that whenever necessary, the model will fall back to the normal NDN operational mode, flooding the network to discover new content sources.

The model will preferably use communication through RSU whenever possible. An intermediate node receiving a packet destined to RSU can, however, redirect the packet to the content source if it finds that a route to this content source exists in its own Forwarding Interest Base (FIB). When using Vehicle-to-Vehicle (V2V) communications, the model will limit the number of allowed hops, allowing better control of broadcast, thus avoiding the broadcast storm problem.

3. Materials and Methods

The definition of the central topic to be developed in this work, was based on the results and conclusions from a SLR by (Silva, Macedo, and Costa 2021). The design of a model aiming at closing the still existing gaps, as presented by the conclusion from the developed SLR, is being finalized. The model is composed of forwarding strategy, and the routing protocol which includes the mobility prediction and Caching for routing decisions.

The developed model will be evaluated by means of simulation, and real experimentation (whenever possible). For simulation, ndnSIM (Mastorakis, Afanasyev, and Zhang 2017) and Simulation of Urban MObility (SUMO) (Lopez et al. 2018) will be used.

Several vehicular trajectory datasets exist, e.g. (Uppoor et al. 2014), and one will be prepared, and used to train the long-term mobility prediction algorithm.

The simulation results will be extracted and statistically analyzed, using either MATLAB or R environment. The comparison of these results with state-of-the-art similar solutions will be performed, drawing then the final conclusion on the validity of the proposed model.

References

- Duan, M, C Zhang, Y Li, W Xu, X Ji, and B Liu. 2018. "Neighbor Cache Explore Routing Protocol for VANET Based on Trajectory Prediction." In *2018 IEEE 3rd Advanced Information Technology, Electronic and Automation Control Conference (IAEAC)*, 771–76.
- Jacobson, Van, Diana K Smetters, James D Thornton, Michael F Plass, Nicholas H Briggs, and Rebecca L Braynard. 2009. "Networking Named Content." In *Proceedings of the 5th International Conference on Emerging Networking Experiments and Technologies*, 1–12. CoNEXT '09. New York, NY, USA: ACM. <https://doi.org/10.1145/1658939.1658941>.
- Lopez, Pablo Alvarez, Michael Behrisch, Laura Bieker-Walz, Jakob Erdmann, Yun-Pang Flötteröd, Robert Hilbrich, Leonhard Lücken, Johannes Rummel, Peter Wagner, and Evamarie Wießner. 2018. "Microscopic Traffic Simulation Using SUMO." In *IEEE Intelligent Transportation Systems Conference (ITSC)*. IEEE. <https://elib.dlr.de/124092/>.
- Mastorakis, Spyridon, Alexander Afanasyev, and Lixia Zhang. 2017. "On the Evolution of NdnSIM: An Open-Source Simulator for NDN Experimentation." *ACM Computer Communication Review*, July.
- Mathew, Wesley, Ruben Raposo, and Bruno Martins. 2012. "Predicting Future Locations with Hidden Markov Models." In *Proceedings of the 2012 ACM Conference on Ubiquitous Computing*, 911–918. UbiComp '12. New York, NY, USA: Association for Computing Machinery. <https://doi.org/10.1145/2370216.2370421>.
- Silva, Elidio, Joaquim Macedo, and Antonio Costa. 2021. "Systematic Literature Review on the Improvement of VANET by NDN."
- Uppoor, Sandesh, Oscar Trullols-Cruces, Marco Fiore, and Jose M Barcelo-Ordinas. 2014. "Generation and Analysis of a Large-Scale Urban Vehicular Mobility Dataset." *IEEE Transactions on Mobile Computing* 13 (5): 1061–75. <https://doi.org/10.1109/TMC.2013.27>.
- Zhang, Lixia, Deborah Estrin, Jeff Burke, Van Jacobson, Jim Thornton, Diana Smetters, Beichuan Zhang, et al. 2010. "Named Data Networking (NDN) Project."

Network Centrality: An insight for gateway designation in real-time wireless sensor networks

Miguel Gutiérrez Gaitán^{1,2,3}, Luís Almeida¹,
Alejandro Figueroa³, Diego Dujovne⁴

¹CISTER/FEUP, Universidade do Porto, Portugal - mgg@fe.up.pt;

²CISTER/ISEP, Politécnico do Porto, Portugal

³Facultad de Ingeniería, Universidad Andrés Bello, Chile.

⁴Esc. de Informática y Telecomunicaciones, Universidad Diego Portales, Chile.

Abstract

This research explores the notion of network centrality as a criterion to designate a node as sink or gateway in real-time wireless sensor networks (WSN). Since centrality is a quantitative measure of how important a node is with respect to others in a given network, we propose to designate as gateway the node with the highest centrality measure. To this purpose, four classical centrality metrics from social network analysis are evaluated, namely, (i) degree centrality, (ii) closeness centrality, (iii) betweenness centrality, and (iv) eigenvector centrality. Simulation results under varying configurations show that using network centrality as a gateway designation criterion is, in general, an effective and promising approach to improve schedulability in WSNs.

Author Keywords. Centrality, EDF, TDMA, TSCH, WSN.

1. Motivation

WSN applications that require real-time coordination and communication are numerous and long-standing, from monitoring and control for safety-critical or military, to environmental or domestic infrastructure (Stankovic et al. 2003). WSNs usually consist of a large number of wirelessly linked nodes deployed to sense and/or control a particular environment. Typically, one of the WSN nodes acts as a sink and/or gateway for the others, thus being responsible for collecting all the sensors data (e.g. measurements), often in a centralized and convergecast fashion. While designating one of these nodes as gateway may depend on many different factors, its relative position w.r.t. the rest of the nodes has a significant impact on the overall network performance. In particular, for the case of real-time WSNs, i.e. those operating under specific timing constraints (e.g. maximum end-to-end delays), this observation is highly relevant since the problem of how to judiciously assign to a node the role of a gateway has not been explored yet for real-time performance.

In this work, we address such a challenge by proposing the notion of network centrality as a criterion to designate a node as a gateway in order to improve network schedulability. More concretely, we propose to designate as gateway the node with the highest centrality measure, particularly, using conventional centrality metrics borrowed from the field of social network analysis. Since, to the best of our knowledge, no other work in the literature address this issue from the perspective of real-time networks, we compare the results of our approach against an arbitrary (random) gateway designation.

2. Performance Evaluation

For the purposes of evaluation, we consider the network and flow models as in (Gaitán et al. 2021a), specifically, assuming the network is a mesh operating under a centralized resource-management framework which uses shortest-path routing and earliest-deadline-first (EDF) scheduling. Moreover, without loss of generality, we assume the medium-access-control

(MAC) is based on a TSCH or time-synchronized channel-hopping protocol, whose predictable nature allows us to apply the supply/demand-bound based schedulability test proposed in (Gaitán and Yomsi 2018). This test, as shown in (Gaitán et al. 2020), is a state-of-the-art schedulability assessment for TSCH WSNs under EDF. As for the centrality, we consider: (i) degree, (ii) closeness, (iii) betweenness, and (iv) eigenvector centrality metrics, as commonly defined in the literature of social network analysis. These specific metrics are chosen because, as reported in (Valente et al. 2010), are deemed as near optimally correlated, which is a highly desirable feature for the purposes of benchmarking. Here, due to space restrictions, we do not further discuss the metric definitions, but we refer the reader to the fundamental expressions commonly found in the literature, e.g. in (Rodrigues 2019). We recall that in this work, we select as gateway the node with the highest centrality.

2.1. Simulation Setup

Consider 100 test cases obtained from the random generation of network topologies with fixed number of nodes, $N = 80$, and target node density of 0.1. For each topology we select one of these N nodes as sink or gateway, according to the centrality criteria above indicated. We assume the number of radio channels is fixed, i.e. $m = 16$, and the number of real-time flows is varying according to $n \in [1, 10]$. Moreover, the flow periods are generated randomly within the range $[2^4, 2^7]$ slots, and the deadlines are assumed as in implicit-deadline model. The length of the interval of evaluation for the schedulability test is set as equal to the hyper-period, here $H = 2^7 = 128$ slots. Further details about this setup, as well as about other related parameters, can be found in (Gaitán et al. 2021a). As for the centrality, we refer the reader to the centrality implementations available in MATLAB¹.

2.2. Preliminary Results

Figure 1 shows the results of the schedulability ratio evaluation of the four centrality metrics chosen when compared against a random baseline. These results suggest that under varying workload conditions, the performance of a centrality-driven designation criterion is always better than or equal to the baseline. Notably, achieving up to 40% of improvement under particular settings. From all metrics, the eigenvector centrality finished with the greatest growth in performance, while the degree centrality the lowest. Yet, since the degree centrality is the simplest one, it remains preferable in terms of computational complexity. The rest of metrics performed alike to the eigenvector centrality, while not showing clear dominance from one measure above the other. Thus, leaving this research question open for further research. We note that an alternate version of these results can be found in (Gaitán et al. 2021b), specifically, with additional details in terms of the network connectivity.

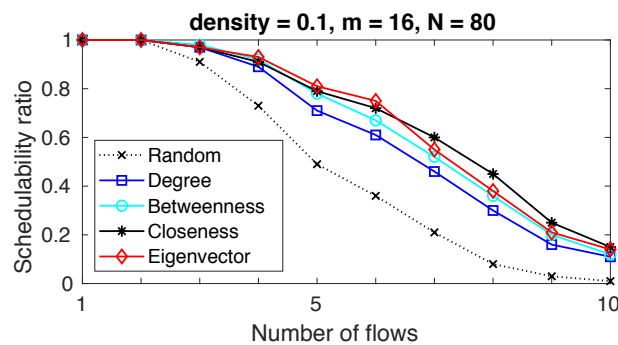

Figure 1: The schedulability ratio under varying number of flows $n \in [1, 10]$.

¹ "Measure node importance - MATLAB centrality". MathWorks. Accessed May 13, 2021. <https://www.mathworks.com/help/matlab/ref/graph centrality.html>.

3. Summary & Future Work

This research proposes network centrality as a criterion for gateway designation in real-time WSNs. It reports preliminary, but promising, results for four of the most common centrality metrics in social network analysis. It further shows that any of the centrality metrics evaluated can be used to improve schedulability in real-time WSNs. Notably, achieving up to 40% of improvement w.r.t. a random baseline. More importantly, these preliminary findings offer a number of research opportunities, where we identify two as the most promising. First, to design novel methods for gateway designation in real-time WSNs motivated by the fact that arbitrary decisions are far from optimal. Second, to explore further concepts in network science that may bring additional benefits from a real-time systems perspective. We envision these two directions are not only relevant for the case of WSNs, but also for related fields such as software-defined networks (SDN) or time-sensitive-networks (TSN), where the relative sink (or controller) position, as well as further details of the structural properties of the network, have not been fully explored for real-time performance.

References

- Stankovic, John A., T. E. Abdelzaher, Chenyang Lu, Lui Sha, and Jennifer C. Hou. "Real-time communication and coordination in embedded sensor networks." *Proceedings of the IEEE* 91, no. 7 (2003): 1002-1022.
- Gaitán, Miguel G., Luís Almeida, Pedro M. Santos, and Patrick Meumeu Yomsi. "EDF scheduling and minimal-overlap shortest-path routing for real-time TSCH networks." In *Proceedings of the 2nd Workshop on Next Generation Real-Time Embedded Systems (NG-RES 2021)*, vol. 87, pp. 2-1. Schloss Dagstuhl--Leibniz-Zentrum für Informatik, 2021.
- Gaitán, Miguel G., and Patrick M. Yomsi. "FF-DBF-WIN: On the forced-forward demand-bound function analysis for wireless industrial networks." *Proceedings of the Work-in-Progress Session (ECRTS 2018)* (2018): 13-15.
- Gaitán, Miguel G., Patrick M. Yomsi, Pedro M. Santos, and Luís Almeida. "Work-in-Progress: Assessing supply/demand-bound based schedulability tests for wireless sensor-actuator networks." In *2020 16th IEEE International Conference on Factory Communication Systems (WFCS)*, pp. 1-4. IEEE, 2020.
- Valente, Thomas W., Kathryn Coronges, Cynthia Lakon, and Elizabeth Costenbader. "How correlated are network centrality measures?." *Connections* 28, no. 1 (2008): 16.
- Rodrigues, Francisco A.. "Network centrality: an introduction." In *A Mathematical Modeling Approach from Nonlinear Dynamics to Complex Systems*, pp. 177-196. Springer, 2019.
- Gaitán, Miguel G., Luís Almeida, Alejandro Figueroa, and Diego Dujovne. "Impact of network centrality on the gateway designation of real-time TSCH networks." In *2021 17th IEEE International Conference on Factory Communication Systems (WFCS)*, pp. 1-4. IEEE, 2021.

Acknowledgments

This work was partially supported by National Funds through FCT/MCTES (Portuguese Foundation for Science and Technology), within the CISTER Research Unit (UIDB/04234/2020); by the Operational Competitiveness Programme and Internationalization (COMPETE 2020) under the PT2020 Agreement, through the European Regional Development Fund (ERDF); also by FCT and the ESF (European Social Fund) through the Regional Operational Programme (ROP) Norte 2020, under PhD grant 2020.06685.BD.

A Wireless Safety and Security Layer Architecture for Reliable Co-CPS

Ênio Vasconcelos Filho¹, Ricardo Severino¹, Anis Koubaa², Eduardo Tovar¹

¹CISTER – Research Centre in Real-time & Embedded Computing Systems, Instituto Superior de Engenharia do Porto, Rua Alfredo Allen 535, 4200-135 Porto, Portugal; ({enpvf,rarss,emt}@isep.ipp.pt), ORCID 0000-0001-5459-6821, 0000-0002-4215-3238, 0000-0001-8979-3876

²Prince Sultan University, Saudi Arabia; (akoubaa@psu.edu.sa), ORCID 0000-0003-3787-7423

Abstract

The advancements in wireless communication technologies have been enabling an unprecedented pervasiveness and ubiquity for Cyber-Physical Systems. Such technologies can now empower true Systems-of-Systems which cooperate to achieve more complex and efficient functionalities, such as vehicle platooning. However, for such Cooperative Cyber-Physical Systems (Co-CPS) applications to become a reality and fulfill their potential, safety and security must be guaranteed, particularly in critical systems, since they heavily rely on open communication systems, prone to intentional and non-intentional interferences.

To address these issues, in this work, we propose the design of an architecture of a Wireless Safety and Security Layer (WSSL), to be implemented in critical Co-CPS to increase the reliability of these critical communications by enabling the detection of communication errors. Our approach is based upon a safety standard (IEC 61508) directed at open communication systems, which suggests a Black Channel strategy. Thus, the WSSL does not rely on the equipment's safety functionalities or uncertified proprietary mechanisms. Instead, aiming at reducing development and validation costs, it intermediates network communications, implementing a set of defense mechanisms, while additionally guaranteeing security parameters.

Author Keywords. Safety Communication, Wireless Networks, Cyber-Physical Systems, Cooperative Systems.

1. Introduction

The type of integration between devices in Co-CPS makes them subject to various types of safety or cybersecurity flaws, be them intentional or not (Yaacoub et al. 2020). Such a condition implies the need for error detection and subsequent action that does not cause a network overload or compromises the application's response time.

In this work, we present a modular Wireless Safety and Security Layer (WSSL) architecture, developed over a ROS (Robot Operating System) environment, to enable the validation of the communication transactions between Co-CPS, establishing a safe way for the exchange of information.

2. Context and Motivation

Cyber threats have been thoroughly studied in the literature, including the causes, impacts, and the development of attack models, including in Co-CPS scenarios (Yaacoub et al. 2020). Also, several works like (Kholidy 2021), (Mousavinejad et al. 2020), and (Chen and Park 2020) presents solutions to some of these threats. However, the lack of a broader model that allows validating the cooperation between devices in a broad Co-CPS scenario, with devices from different manufacturers, is still an obstacle for implementing more complex solutions.

These cyber threats are also pointed in safety standards like IEC 61508 and EN 50159. These define the guidelines by which such threats should be mitigated, towards a certification that is independent of the network interface vendor, enabling for instance the exchange of a radio transceiver, while maintaining the inherent safety guarantees of the communication system. IEC 61508 defines a safety certification for network communications systems, using a White

or Black Channel approach. The White channel approach assumes that all the equipment are individually certificated, while in the black channel, just the network communication interfaces must be certificated, reducing the implementation costs (Creech 2007). Thus, the proposal of a WSSL that can be implemented over a non-secure or safe transmission system can allow communication systems from different manufacturers to interact freely, as long as they are compatible radio-wise, while increasing communications security and reducing safety risks.

3. Wireless Safety and Security Layer (WSSL) Architecture

The implementation of WSSL seeks to increase trust between the various players in a Co-CPS scenario where communication failures or malicious interactions can have critical consequences. The WSSL consists of an additional layer to the adopted communication system, implementing defenses against all relevant communication errors, and where by establishing a safe and secure connection between each WSSL end-point, one can provide an extra level of safety and security to the Co-CPS systems, as it is presented in [Figure 1](#).

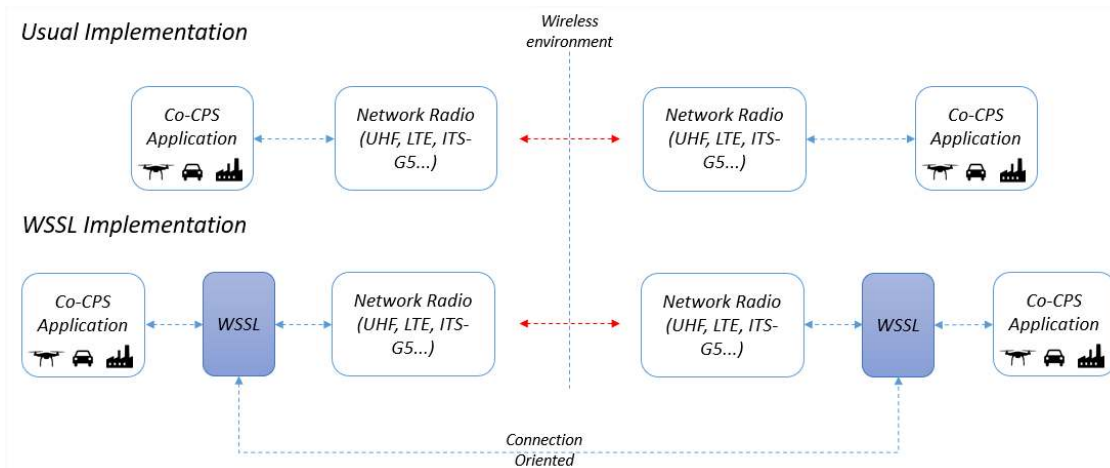

Figure 1: WSSL architecture implementation

A challenging scenario in Co-CPS is the Cooperative Vehicular Platooning (Co-VP), as it deals with a critical operation in a dynamic environment that involves vehicles and eventually passengers, which increases the need to guarantee the safety parameters of the system. Thus, to develop and test the WSSL, we will implement it to the CopaDrive (Filho et al. 2020), a ROS based simulator. By integrating WSSL within a ROS environment, we will achieve much higher flexibility in the layer development, allowing the integration with several communication systems and Co-CPS devices.

The WSSL will establish and guarantee connections between vehicles, protecting communications, acting as an intermediate layer between the application and the ITS-G5 communications stack of the On-Board Unit communications module.

The objective of WSSL is to build a modular architecture that can be easily implemented in low-cost devices that can adapt to the needs of the Co-CPS application, using ROS. In [Figure 2](#), we present the general network threats that the WSSL addresses and the defenses that must be implemented, at least one per threat.

Although, some of the defenses involve verifying the origin and destination of the messages sent, the WSSL is agnostic to the message contents or application payload, guaranteeing the data's trust and privacy. In addition, its implementation is independent, as much as possible, of the communication stack used. An example sequence connection diagram is presented in [Figure 3](#).

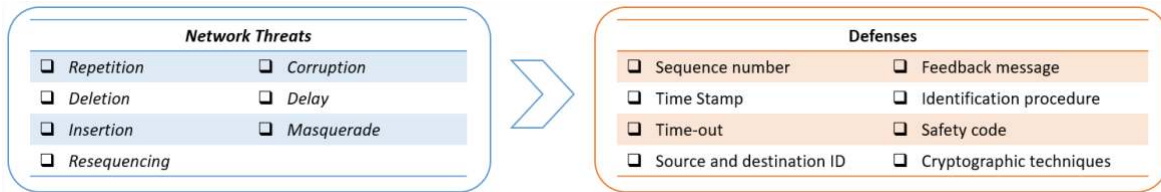

Figure 2: WSSL Threats and Defenses

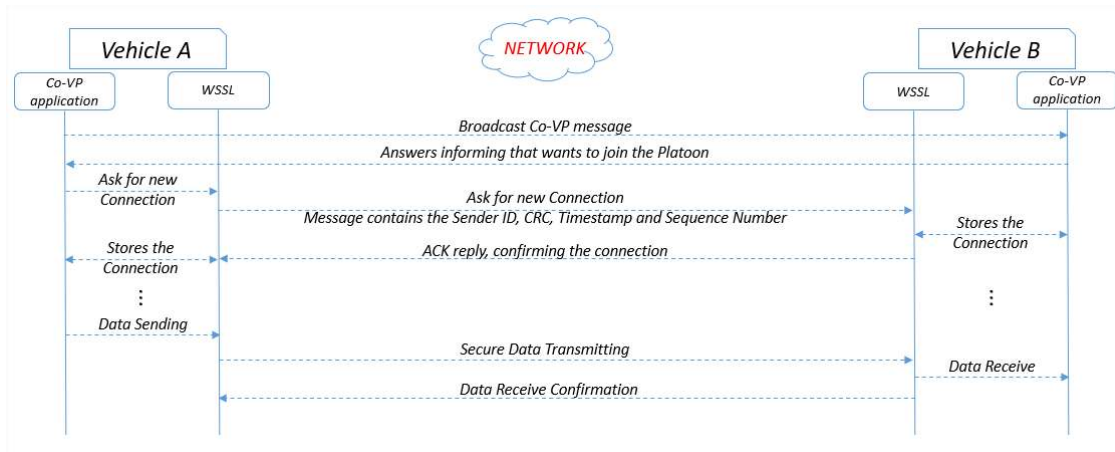

Figure 3: Sequence Connection Diagram

4. Conclusions

The safety and security requirements for Co-CPS systems must be urgently addressed given the criticality of many of these systems. We believe the adoption of WSSL in a modular way is a fundamental proposal to mitigate a series of problems in currently unsecured and unsafe wireless communication systems.

References

- Chen, Zheng, and Byungkyu Brian Park. 2020. "Preceding Vehicle Identification for Cooperative Adaptive Cruise Control Platoon Forming." *IEEE Transactions on Intelligent Transportation Systems* 21 (1): 308–20. <https://doi.org/10.1109/TITS.2019.2891353>.
- Creech, Gerry. 2007. "Black Channel Communication: What Is It and How Does It Work?" *Measurement and Control* 40 (10): 304–9. <https://doi.org/10.1177/002029400704001003>.
- Filho, Enio Vasconcelos, Ricardo Severino, Anis Koubaa, and Eduardo Tovar. 2020. "An Integrated Lateral and Longitudinal Look Ahead Controller for Cooperative Vehicular Platooning." In *4th EAI International Conference on Intelligent Transport Systems (EAI INTSYS 2020)*, 18. Online.
- Kholidy, Hisham A. 2021. "Autonomous Mitigation of Cyber Risks in the Cyber–Physical Systems." *Future Generation Computer Systems* 115 (February): 171–87. <https://doi.org/10.1016/j.future.2020.09.002>.
- Mousavinejad, Eman, Fuwen Yang, Qing-Long Han, Xiaohua Ge, and Ljubo Vlacic. 2020. "Distributed Cyber Attacks Detection and Recovery Mechanism for Vehicle Platooning." *IEEE Transactions on Intelligent Transportation Systems* 21 (9): 3821–34. <https://doi.org/10.1109/TITS.2019.2934481>.
- Yaacoub, Jean-Paul A., Ola Salman, Hassan N. Noura, Nesrine Kaaniche, Ali Chehab, and Mohamad Malli. 2020. "Cyber-Physical Systems Security: Limitations, Issues and Future Trends." *Microprocessors and Microsystems* 77 (September): 103201. <https://doi.org/10.1016/j.micpro.2020.103201>.

Acknowledgments

This work was partially supported by National Funds through FCT/MCTES (Portuguese Foundation for Science and Technology), within the CISTER Research Unit (UIDP/UIDB/04234/2020); also by the FCT and the EU ECSEL JU under the H2020 Framework Programme, within project(s) ECSEL/0010/2019, JU grant nr. 876019 (ADACORSA). Disclaimer: This document reflects only the author's view and the Commission is not responsible for any use that may be made of the information it contains.

Open Issues in Analyzing the Schedulability for the 3-Phase Task Model using Partitioned Scheduling

Jatin Arora*, Cláudio Maia*, Syed Aftab Rashid*[†], Eduardo Tovar*

*CISTER Research Centre, ISEP, IPP, Porto, Portugal.

[†]VORTEX CoLab, Porto, Portugal.

{jatin,crrm,syara,emt}@isep.ipp.pt

Abstract

Modern multicore processors have the potential to provide raw computing power while being energy-efficient and cost-effective. While many of the systems have already deployed multicore processors for their operations, their adoption in systems that run time-sensitive applications is still active research. The main reason behind this is the architecture of a typical multicore processor. The typical architecture used in commercial-off-the-shelf (COTS) platforms makes use of shared system bus, main memory, shared caches, etc., among all/several cores. A task can suffer inter-core interference from the co-running tasks while accessing these shared resources. This inter-core interference can impact the temporal behavior of the tasks and analyzing the worst-case timing behavior of a task becomes extremely challenging. The 3-phase task model was proposed to circumvent this problem by dividing the execution of each task into memory and execution phases. In the 3-phase task model, the memory accesses can only happen during a memory phase and a core can execute a memory phase while other cores are busy executing the execution phases. Even though some existing approaches focus on analyzing the schedulability of the 3-phase task model under partitioned scheduling, several open issues exist. In this paper, we identify the key open issues that are important to address in order to derive the schedulability analysis for 3-phase tasks scheduled using partitioned scheduling.

Author Keywords. Multicore Platforms, Schedulability Analysis, Partitioned Scheduling, Bus Contention, Memory Contention.

1. Introduction

Multicore processors were introduced to meet the increasing demand for computing power, energy-efficiency, and cost-effective solutions. Many devices such as mobile phones, computers, smart TV, etc. have integrated multicore processors in their designs in order to take advantage of these features. However, the use of multicore platforms in systems that run time-sensitive applications such as avionics, automotive, railways, etc. is under scrutiny of the real-time systems research community. The main reason is that COTS multicore platforms have shared resources such as system bus, shared cache, main memory, etc. that are shared between the cores. Due to such architectural design, a task running on a given core may suffer inter-core interference from the tasks running on other cores (co-running tasks) while accessing these shared resources. This inter-core interference is dependent on specific properties of co-running tasks such as the number of memory requests, maximum time required to serve each memory request, type of memory request, etc.

The 3-phase task model [1,2] was introduced to reduce the unpredictability caused by the shared resource accesses in COTS multicore systems. In the 3-phase task model, the execution of each task is divided into three phases, i.e., *Acquisition* (A), *Execution* (E), and *Restitution* (R) phases. A task fetches the data from the main memory by accessing the system bus and loads it in the core's local memory during the A-phase. During the E-phase, the core executes the

task by accessing the data available in the core's local memory. Finally, during the R-phase, the task writes-back the modified data to the main memory by accessing the system bus. Consequently, A- and R-phases are considered memory phases whereas the E-phase is the execution phase. In the 3-phase task model, a core can execute a memory phase without suffering the inter-core interference when other cores are executing the execution phases.

2. Problem Definition

Even though the 3-phase task model can reduce the temporal unpredictability in multicore systems, tasks can still suffer inter-core interference in some scenarios. Such a scenario happens when tasks running on different cores want to execute a memory phase at the same time. Since the system bus is responsible to connect all the cores with the main memory, there can be a scenario in which a task wants to access the system bus while the system bus is busy handling the memory phase of co-running tasks. This phenomenon is known as bus-contention. Similarly, tasks can suffer inter-core interference at the main memory when the main memory is serving the memory requests of co-running tasks. This phenomenon is known as memory-contention. The problem of bus-contention and memory-contention in the 3-phase task model can negatively impact the temporal behavior of the tasks. Therefore, it is necessary to compute the upper-bound on the bus-contention and memory-contention to safely derive the schedulability analysis for 3-phase tasks.

3. State-of-the-Art

Works like [3] proposed a fine-grained bus-contention analysis for the 3-phase task model using fixed-priority partitioned scheduling. The bus blocking analysis is formulated by considering the set of memory phases running on the core under analysis and on all the other cores.

On the other hand, works like [4] compute the main memory-contention that can be suffered by the 3-phase tasks under partitioned scheduling. Such analysis accounts for the type of memory request (i.e., read or write), number of memory requests, and locality of the requested memory block in the main memory. By integrating the maximum memory-contention suffered by the 3-phase tasks, the memory-aware response time analysis is formulated for fixed-priority partitioned scheduling.

4. Open Issues

Even though the above-mentioned works focus on the schedulability analysis for the 3-phase tasks under partitioned scheduling, the following open issues still exist:

- **Open Issue 1:** Casini et al. [4] proposed a fine-grained analysis to compute the main memory-contention suffered by the 3-phase task using partitioned scheduling. However, their approach assumes a specific architecture that has a cross-bar switch that is responsible for point-to-point communication between the cores and the main memory. Thus, it ignores the problem of bus-contention that can be suffered by a task from co-running tasks due to the shared system bus accesses. This limits the applicability of [4] to only certain multicore architectures.
- **Open Issue 2:** The bus blocking analysis proposed in [3] assumes that the bus arbitration policy is First-Come First-Served (FCFS). Such an assumption limits the work of [3] to a certain bus arbitration policy. It is not known whether such analysis can be directly applied to multicore platforms that employ different bus arbitration policies such as processor-priority, round-robin, TDMA, etc. Furthermore, their approach does

not account for the worst-case time taken by the main memory to serve each memory request on the basis of type of request, location of requested memory block, etc.

Addressing the above-mentioned open issues is important because it will allow to derive a safe bound on the worst-case response time for the 3-phase task model under partitioned scheduling. However, addressing the above-mentioned open issues can be extremely challenging due to the complexity of the problem. For instance, the complexity can significantly increase while holistically analyzing the impact of bus-contention and memory-contention under the same framework.

5. Conclusion

In this work, we briefly discuss the problem of bus-contention and memory-contention that can be suffered by the 3-phase task model in fixed-priority partitioned scheduling. We further identified the open issues that have not been addressed in the state-of-the-art, their importance and possible challenges.

References

- [1] Girbal, Sylvain & Durrieu, Guy & Faugere, Madeleine & Gracia Pérez, Daniel & Pagetti, Claire & Puffitsch, Wolfgang. (2014). Predictable Flight Management System Implementation on a Multicore Processor. URL: <https://hal.archives-ouvertes.fr/hal-01121700/document> (Accessed on 08/06/2021).
- [2] C. Maia, L. Nogueira, L. M. Pinho and D. G. Pérez, "A closer look into the AER Model," 2016 IEEE 21st International Conference on Emerging Technologies and Factory Automation (ETFA), 2016, pp. 1-8, URL: <https://ieeexplore.ieee.org/document/7733567> (Accessed on 08/06/2021).
- [3] Jatin Arora, Cláudio Maia, Syed Aftab Rashid, Geoffrey Nelissen and Eduardo Tovar, "Bus-Contention Aware Schedulability Analysis for the 3-Phase Task Model with Partitioned Scheduling", in the 29th International Conference on Real-Time Networks and Systems (RTNS'21) URL:<https://easychair.org/publications/preprint/gdNJ> (Accessed on 28/04/2021).
- [4] D. Casini, A. Biondi, G. Nelissen and G. Buttazzo, "A Holistic Memory Contention Analysis for Parallel Real-Time Tasks under Partitioned Scheduling," 2020 IEEE Real-Time and Embedded Technology and Applications Symposium (RTAS), 2020, pp. 239-252. URL: <https://ieeexplore.ieee.org/document/9113115> (Accessed on 08/06/2021).

Acknowledgments

This work was partially supported by National Funds through FCT/MCTES (Portuguese Foundation for Science and Technology), within the CISTER Research Unit (UIDB-UIDP/04234/2020); also by the Operational Competitiveness Programme and Internationalization (COMPETE 2020) under the PT2020 Partnership Agreement, through the European Regional Development Fund (ERDF), and by national funds through the FCT, within project POCI-01-0145-FEDER-029119 (PREFECT); also by FCT, under PhD grant 2020.09532.BD.

Towards the Safe Deployment of Runtime Monitors in Mode-Change Supported Cyber-Physical Systems

Giann Spilere Nandi, David Pereira, José Proença, Eduardo Tovar
CISTER Research Centre/ISEP Polytechnic Institute of Porto, Portugal
{giann, drp, pro, emt}@isep.ipp.pt

Abstract

Complex safety-critical Cyber-Physical Systems require modern approaches that can provide evidence of their correct functioning. Among the many state-of-the-art approaches is *runtime verification*, which constantly verifies if a system's behavior complies with its specification. However, the coupling of monitors causes an inevitable overhead that could compromise the system's safety. We present the concept of a framework capable of analyzing the schedulability of a set of mode-change supporting Cyber-Physical Systems in the presence of coupled runtime monitors.

Author Keywords. Runtime Verification, Cyber-Physical Systems, Real-Time Scheduling.

1. Introduction

Runtime verification is a technique based on formal methods that dynamically checks if a set of system's runs satisfy correctness properties regarding formal specifications (Leucker and Schallhart, 2009). It consists of enhancing systems with computational entities, named monitors, that run alongside it and issue verdicts about its behavior. By being executed together with a target system, monitors incur an inevitable overhead that, depending on its deployment, can negatively influence the system's safety and security properties. Such impact is especially problematic in the context of safety-critical systems, such as most Cyber-Physical Systems (CPS), where the occurrence of faults can result in catastrophes.

2. The Challenge

Among the many safety properties related to CPS is the schedulability of real-time tasks. When we consider software-based monitors, their inevitable performance overhead must also be considered by the system's task scheduler. In this work, we focus on safety-critical CPS that support mode-changes (Real and Crespo, 2004). These systems optimize the use of their computational resources by modifying, at runtime, the task sets to be scheduled consonant to the systems' modes of execution, i.e., by dynamically 1) adjusting the scheduling parameters of the current executing real-time tasks; 2) adding new tasks that were not needed; and 3) aborting tasks that are no longer needed. Supporting changes of modes in safety-critical CPS is challenging as such systems must guarantee the correct scheduling of their task set in each of the modes individually (before and after a mode-change) and during the transition period between two modes.

3. Proposed Work

To help obtaining evidence of the correct scheduling of real-time tasks, even in the presence of coupled runtime monitors, we propose a framework that extends a set of works in the real-time literature that support mode-change schedulability analysis. These analyses contemplate specific system configuration settings, including the number of cores, the scheduling algorithm, and the allocation policy of tasks.

Our framework, which is driven by a domain specific language, requires developers and engineers to (1) specify a set of computing nodes and assign to them the execution modes, each with a set of associated tasks and monitors with specific scheduling parameters, and (2) specify the possible mode transitions supported by the system. As output, our framework states if a system is schedulable considering finite and possible infinite sequences of mode changes by combining state-of-the-art algorithms and our case-specific tailored analysis, and possibly suggest improvements to the scheduling parameters.

Currently, we support two types of system configurations: *single-core* with a fixed-priority scheduling algorithm (rate monotonic) (Huang and Chen, 2015) and *multi-core*, also with rate monotonic, considering a global allocation policy of the tasks (Baek, Shin, Lee, 2020). On top of that, our algorithms do not limit the number of nodes and modes used to specify the target systems. The decision to support only the aforementioned system configurations at this early stage goes in line with one of the latest surveys of industrial practices in the real-time domain (Akesson, 2020). To validate our results, we expect to use our framework to analyze a set of industry-focused use cases and synthetic use cases that could represent problems that are not yet present in real-world applications.

References

- Baek, H., K. G. Shin, and J. Lee. 2020. "Response-Time Analysis for Multi-Mode Tasks in Real-Time Multiprocessor Systems." IEEE Access. <https://doi.org/10.1109/access.2020.2992868>
- Real, J., and Crespo, A. "Mode Change Protocols for Real-Time Systems: A Survey and a New Proposal." Real-Time Systems 26, no. 2 (2004): 161–97. <https://doi.org/10.1023/b:time.0000016129.97430.c6>
- Huang, W.-H., and J.-J. Chen. 2015. "Techniques for Schedulability Analysis in Mode Change Systems under Fixed-Priority Scheduling." In 2015 IEEE 21st International Conference on Embedded and Real-Time Computing Systems and Applications. IEEE. <https://doi.org/10.1109/rtcsa.2015.36>
- Akesson, B., M. Nasri, G. Nelissen, S. Altmeyer, and R. I. Davis. 2020. "An Empirical Survey-Based Study into Industry Practice in Real-Time Systems." In 2020 IEEE Real-Time Systems Symposium (RTSS). IEEE. <https://doi.org/10.1109/rtss49844.2020.00012>
- Leucker, M., and C. Schallhart. 2009. "A Brief Account of Runtime Verification." The Journal of Logic and Algebraic Programming. <https://doi.org/10.1016/j.jlap.2008.08.004>

Acknowledgments

This work was partially supported by National Funds through FCT/MCTES (Portuguese Foundation for Science and Technology), within the CISTER Research Unit (UID/CEC/04234); also by the Norte Portugal Regional Operational Programme (NORTE 2020) under the Portugal 2020 Partnership Agreement, through the European Regional Development Fund (ERDF) and also by national funds through the FCT, within project NORTE-01-0145-FEDER-028550 (REASSURE); also by FCT within project ECSEL/0016/2019 and from the ECSEL Joint Undertaking (JU) under grant agreement No 876852. The JU receives support from the European Union's Horizon 2020 research and innovation programme and Austria, Czech Republic, Germany, Ireland, Italy, Portugal, Spain, Sweden, Turkey.

A Hybrid Supervised Approach for Human Robot Interaction with Children with Autism Spectrum Disorder

Vinícius Silva, Filomena Soares, and João Sena Esteves
Center Algoritmi, University of Minho, Campus de Azurém, Guimarães, Portugal

Abstract

Individuals with Autism Spectrum Disorder (ASD) are characterized by difficulties in social communication and restricted patterns of behaviour. Technological tools such as social robots and Objects with Playware Technology (OPT) have been employed in support sessions with individuals with ASD. The present work proposes a supervised behavioural system using a hybrid approach (robot + OPT) to enable a more natural and adaptive interaction. In general, it is possible to conclude that the children understood the mechanics of the games and successfully interacted with the robot and both OPTs.

Author Keywords. Human Robot Interaction, Autism Spectrum Disorders, Playware.

1. Introduction

Emotional skills are paramount for a successful human-human communication. Individuals with Autism Spectrum Disorder (ASD) are characterized by having deficits in social communication and social interaction. Moreover, due to the diversity and specificities of symptoms, professionals have found some difficulties in developing effective support methods. Robots have been used to facilitate support processes with children with ASD, with robots acting as a mediator between the child and the game partner (Tapus et al. 2012). Research has found that interacting with the robots draws these children into a range of new social behaviours (Tapus et al. 2012; Dautenhahn and Werry 2004). Although with promising results from the children's point-of-view, the majority of the systems are controlled using the Wizard-of-Oz (WOZ) method, meaning that in reality the robot does not adapt its behaviour to the children's actions. Analogous to the use of robots, researchers have been employing Objects with Playware Technology (OPT) to interact with children with ASD. The term "playware" is suggested as a combination of intelligent play and playful experiences among users (Lund, Klitbo, and Jessen 2005).

Following this trend, the present work proposes a novel supervised behavioural system architecture using a hybrid approach (robot + OPT) to allow the detection of the child behaviours and consequently adapt the robot actions, enabling a more natural interaction and lighten up the cognitive burden on the human operator. The OPT is to be used as an add-on to the human-robot interaction with children with ASD in emotion recognition activities.

The present paper is organized as follow: Section 2 presents the materials and methods of the presented approach, the results concerning the performance of the action recognition model, and the two pilot studies conducted with children with ASD are reported in Section 3.

2. Materials and Methods

The proposed system, depicted in [Figure 1](#), consists of a humanoid robot (ZECA – Zeno Engaging Children with Autism) capable of displaying facial cues, a computer, two OPT devices, and a 3D sensor. The PlayCube (with a 1.5-inch OLED RGB display) and PlayBrick (with a 5.0-inch touch display), shares the same internal components: an Inertial Measurement Unit (IMU), a small development board (ESP32) that already has built-in Bluetooth and Wi-Fi communication, an RGB LED ring, a Linear Resonant Actuator (LRA), and a Li-Po battery.

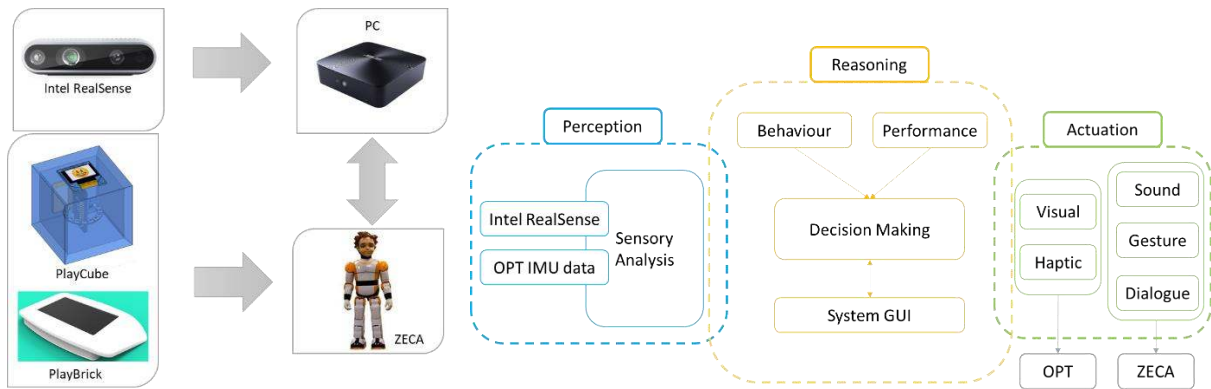

Figure 1: On the left: the proposed system. On the right, the behavioural architecture is depicted – the perception (blue), Reasoning (yellow), and Actuation (green) layers (Vinicius Silva et al. 2019).

The Intel RealSense is a USB-powered device that contains a conventional RGB full HD camera, an infrared laser projector, and a pair of depth cameras. The Intel RealSense model D435 along with the Intel RealSense SDK and Nitrack SDK are used to track the user joints, as well as, for face tracking and head orientation.

Concerning the software architecture (Figure 1), it consists of three main layers (Vinicius Silva et al. 2019). The perception layer is responsible for sensing and processing of the data received from the sensors. The reasoning layer is influenced by the child behaviour and performance. It takes into account the outputs of the perception layer (which does face tracking for computing head motion, skeleton tracking for action recognition, and the IMU data) and the performance data in order to adapt the support session. The action recognition, Figure 2, is done by transforming the tracking data into an image representation that is used as input to a deep learning model (Vinicius Silva et al. 2020). The final output is the classification of 9 non-verbal behaviours (3 stereotypical and 6 typical behaviours), Table 1. The output of the reasoning layer will influence the dynamics of the next layer, the Action layer. Therefore, the robot actions and the OPT feedback will be influenced by the interaction flow of the session.

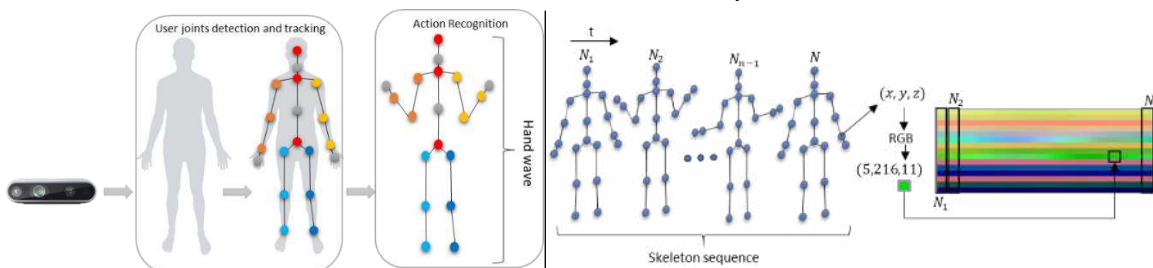

Figure 2: The overall pipeline concerning the detection of the user actions. On the right, it shows the joints encoding to colour space, where N is the number of frames.

The activities played are focused on emotion recognition. Two games were developed: Recognize, where ZECA performs a facial expression and its associated gestures, representing one of the five emotions (anger, fear, happiness, sadness, and surprised), and the child has to choose the correct facial expressions by selecting it from the OPT screen and storytelling, where the robot randomly tells a story, and the child has to identify the correct affective state of the main character. In parallel, a visual cue of the story is shown on the PlayBrick device.

3. Results and Final Remarks

Table 1 shows the average accuracy per class of the action recognitions model. The model achieved an average test accuracy of $92.5 \pm 0.5\%$. The model achieved a Matthews Correlation Coefficient of $91.6 \pm 0.6\%$. The present method is able to run in real-time at about 31 FPS on a

quad-core CPU, being fast enough for most real-time applications. Additionally, the model achieved better performance when compared to other approaches on the state of the art on the detection of stereotyped behaviours – ‘Hand_Wave’, ‘Cover_Ears’, and ‘Rocking’ (Vinicius Silva et al. 2020).

<u>IDLE</u>	<u>STANDING</u>	<u>CLAP</u>	<u>HAND_WAVE</u>	<u>HAND_RAISE</u>	<u>POINTING</u>	<u>COVER_EARS</u>	<u>TURN</u>	<u>ROCKING</u>
83±2.0%	97±2.2%	92±2.6%	96±1.2%	100±1.2%	100±1.2%	88±3.1%	86±3.2%	93±2.1%

Table 1: Average accuracy per class with the standard deviation.

Two pilot studies were conducted focusing on evaluating the systems constraints with the recognize and storytelling activities – one with the PlayCube (3 children) and another with the PlayBrick (4 children) – at a school setting with children with ASD aged between 6 and 9 years old during 4 sessions. By analysing the results of the pilot studies, it is possible to conclude that the children understood the mechanics of the games and successfully interacted with both OPTs. Moreover, they reacted positively to the activity which might indicate that the developed approach allowed the children to interact in a comfortable and natural way with the system. Additionally, there was a combined attention of the child towards the robot and OPT, indicating that both components were successful in captivating the children interest. In general, the children were keen to participate in the activities. They were also attentive to the OPTs feedbacks – lights, haptic, as well as the images for correct and incorrect answers displayed on the screen. As future work, a study will be conducted with a larger sample of children with ASD, aiming to understand if and how the presented hybrid approach can be used as a valuable tool to develop skills of emotional labelling by children with ASD.

References

- Dautenhahn, Kerstin, and Iain Werry. 2004. “Towards Interactive Robots in Autism Therapy: Background, Motivation and Challenges.” *Pragmatics & Cognition* 12 (1): 1–35. <https://doi.org/10.1075/pc.12.1.03dau>.
- Lund, Henrik Hautop, Thomas Klitbo, and Carsten Jessen. 2005. “Playware Technology for Physically Activating Play.” *Artificial Life and Robotics* 9 (4): 165–74. <https://doi.org/10.1007/s10015-005-0350-z>.
- Silva, Vinicius, Sandra Queirós, Filomena Soares, João Sena Esteves, and Demétrio Matos. 2019. “A Supervised Autonomous Approach for Robot Intervention with Children with Autism Spectrum Disorder.” In *ICINCO 2019 - Proceedings of the 16th International Conference on Informatics in Control, Automation and Robotics*, 2:497–503. <https://doi.org/10.5220/0007958004970503>.
- Silva, Vinicius, Filomena Soares, Joao Sena Esteves, and Gianni Vercelli. 2020. “Human Action Recognition Using an Image-Based Temporal and Spatial Representation.” In *International Congress on Ultra Modern Telecommunications and Control Systems and Workshops*, 2020-Octob:41–46. <https://doi.org/10.1109/ICUMT51630.2020.9222408>.
- Tapus, Adriana, Andreea Peca, Amir Aly, Cristina Pop, Lavinia Jisa, Sebastian Pintea, Alina S Rusu, and Daniel O David. 2012. “Children with Autism Social Engagement in Interaction with Nao, an Imitative Robot.” *Interaction Studies* 13 (3): 315–47.

Acknowledgments

This work has been supported by FCT – Fundação para a Ciência e Tecnologia within the R&D Units Project Scope: UIDB/00319/2020. Vinicius Silva thanks FCT for the PhD scholarship SFRH/BD/SFRH/BD/133314/2017.

Preliminary Simulation-based Feasibility Study for Breast Tumour Diagnosis Using Machine Learning

Raquel A. Martins¹, João M. Felício^{1,2}, Jorge R. Costa^{1,3}, Ana Fred¹,
Carlos A. Fernandes¹

¹Instituto de Telecomunicações, IST, Universidade de Lisboa, Lisboa, Portugal

²Centro de Investigação Naval (CINAV), Escola Naval, Almada, Portugal

³ISCTE-Instituto Universitário de Lisboa (ISCTE-IUL), Lisboa, Portugal

Abstract

Recently, Microwave (MW) based systems have been explored as a complement to conventional breast mass screening methods due to potential high sensitivity, non-ionizing nature, allowing non-invasive and affordable exams. Although MW imaging can be used for detection of breast tumours, it does not promote enough resolution to identify their malignancy. To overcome this drawback, Machine Learning (ML) algorithms have been introduced to support breast tumour diagnosis. Using pattern recognition algorithms on MW signals, may help determining if a breast tumour is benign or malignant. This short-paper presents a preliminary numerical study, based on data of tumour responses generated in-house, using full-wave electromagnetic simulators, exploring most promising ML algorithms and techniques identified in state-of-the-art literature on breast tumour diagnosis.

Author Keywords. Microwave, Backscatter Signals, Machine Learning, Breast Cancer Diagnosis.

1. Introduction

Microwave Imaging (MWI) arose as a complement to the conventional imaging mechanisms for monitoring and detection of breast cancer. This new technique is based on the contrast of dielectric properties between tissues, and it is non-invasive, non-ionizing, and potentially low-cost and compatible with automation (Felício et al. 2020).

The microwave (MW) radiation may be used in a radar-type configuration i.e. electromagnetic signals are transmitted from an array of antennas distributed surrounding the breast and then, are scattered at the inhomogeneities of the dielectric tissues, returning to the same or other antennas. Using the received backscatter signals and inverse scattering algorithms, it is possible to reconstruct an image of the breast (Felício et al. 2020).

However, in respect to breast lesion properties, it is acknowledged that all types of tumours (benign or malignant), present high concentrations of water, caused by intense vascularization (Lazebnik et al. 2007), having approximately the same dielectric properties. Also, although tumours can be distinguishable by their architectural features – a tumour with well-defined margin and round, or macro-lobulated is considered benign; one with an ill-defined margin, spicules or micro-lobulated is considered malignant (Stavros et al. 1995) – MW imaging offers low resolution, which hinders the differentiation of these two types of tumours visually. To address this problem, this study focuses on the impact of morphologic features of tumours in the actual microwave signals, using machine learning (ML) algorithms. It is a preliminary study, based on tumour response signals obtained by full-wave simulation.

The rest of the paper is structured as follows: Section 2 presents the methods and algorithms used to build the in-house data and used in the machine learning process; Section 3 shows the main results; and finally, Section 4 draws main conclusions and presents future work.

2. Methods and Algorithms

The goal of this work was to analyse some of the ML techniques presented in the literature to characterize the level of tumour malignancy. This can be performed since backscatter signals keep a specific signature of the tumour depending on its architectural features, as shape and size. The first stage of this work is to construct a database of backscatter signals. The second phase is the analysis with ML.

2.1. Construction of Database

The authors started by creating a MATLAB code implementing the Gaussian Random Sphere (GRS) model (Sisternes et al. 2015), to generate 3D tumours with different shapes and sizes mimicking real ones. Figure 1 depicts an example of four generated tumours, with the same size but different shape.

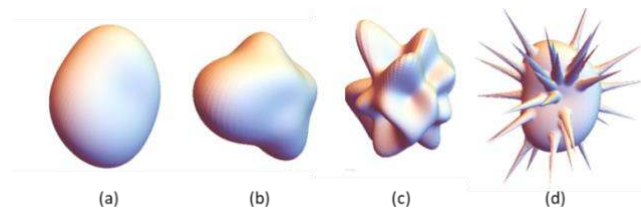

Figure 1: Tumours obtained from the GRS model with different shapes: (a) smooth, (b) macro-lobulated, (c) micro-lobulated, and (d) spiculated

The study considers tumours of four sizes (2.5, 5, 7.5 and 10 mm in radius) and four shapes (smooth, macro-lobulated, micro-lobulated and spiculated), representing a total database of 160 tumours (10 random tumours were generated for each size and shape).

Then, as depicted in Figure 2, using the CST (Computer Simulation Technology) full-wave electromagnetic program, the generated tumours were illuminated successively by two types of antennas: a crossed exponentially tapered slot antenna (XETS) and a balanced antipodal Vivaldi antenna (BAVA). The dielectric properties of the tumours were adjusted to the ones presented in the literature. Being a first study, the least complex environment possible was considered i.e. the tumour is in air, and not embedded in a breast medium. However, to mimic a practical MW setup, the antennas were moved around the tumour and data was collected every 30° . Only monostatic signals were collected, i.e., only those received at the same transmitting antenna. After all simulations, 1920 (160 tumours times 12 readings) backscatter signals formed the total dataset for each antenna.

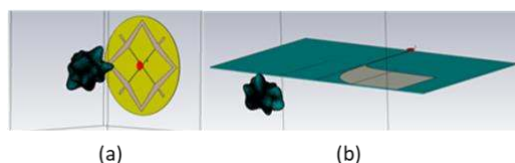

Figure 2: Example of CST environment for simulations with a micro-lobulated tumour and a XETS (a) and BAVA (b) antenna

2.2. ML Processing

The second stage of this work consists of applying ML algorithms to the data for the binary class problem: benign vs malignant tumours. The authors used Principal Component Analysis (PCA) for feature extraction from the signals, and reduction of dimensionality of data representation, and tested several classifiers – K-Nearest Neighbour (KNN), Linear Discriminant Analysis (LDA) and Support Vector Machines (SVM) – trained and evaluated using a 10-fold cross-validation (Falch 2012).

3. Results

A combination of diverse classifier-specific models and associated hyper-parameters ranges, with the number of features were systematically evaluated. Table 1 presents the best accuracy results obtained for each classifier type, for each antenna. Promising results were obtained, with an SVM, with Gaussian kernel leading to the best accuracy with the XETS antenna, while a 12NN, using the Manhattan distance, outperformed the other ML algorithms with the BAVA antenna.

Classifier	XETS [%]	BAVA [%]
KNN	88.23	90.00
LDA	86.25	86.93
SVM	89.27	87.71

Table 1: Performance Accuracy for shape classification

4. Conclusions

This paper is focused on a new approach for breast tumour diagnosis which entails the combination of ML algorithms with MW signals. The authors created tumours of different shapes and sizes, and tested them by full-wave simulation in a simplified scenario using MW signals from two types of antennas (XETS and BAVA). Different ML algorithms were used to determine the level of malignancy (benign or malignant) of those tumours. A feature extraction method (PCA) and three classifiers (KNN, LDA and SVM) were used in this study. The XETS antenna obtained a maximum performance of 89.27%, while the BAVA antenna acquired 90.00% of performance accuracy.

Future studies must address anthropomorphic breasts and a higher variety of tumour sizes and shapes, to investigate how the models would behave in a real clinical setting. Moreover, they should address how the type of antenna influences the accuracy of ML algorithms.

References

- Felicio, Joao M., Jose M. Bioucas-Dias, Jorge R. Costa, and Carlos A. Fernandes. 2020. "Microwave Breast Imaging Using a Dry Setup." *IEEE Transactions on Computational Imaging* 6: 167–80. <https://doi.org/10.1109/tci.2019.2931079>.
- Flach, Peter A. 2012. *Machine Learning : The Art and Science of Algorithms That Make Sense of Data*. Cambridge: Cambridge University Press.
- Lazebnik, Mariya, Dijana Popovic, Leah McCartney, Cynthia B Watkins, Mary J Lindstrom, Josephine Harter, Sarah Sewall, et al. 2007. "A Large-Scale Study of the Ultrawideband Microwave Dielectric Properties of Normal, Benign and Malignant Breast Tissues Obtained from Cancer Surgeries." *Physics in Medicine and Biology* 52 (20): 6093–6115. <https://doi.org/10.1088/0031-9155/52/20/002>.
- Sisternes, Luis de, Jovan G. Brankov, Adam M. Zysk, Robert A. Schmidt, Robert M. Nishikawa, and Miles N. Wernick. 2015. "A Computational Model to Generate Simulated Three-Dimensional Breast Masses." *Medical Physics* 42 (2): 1098–1118. <https://doi.org/10.1118/1.4905232>.
- Stavros, A T, D Thickman, C L Rapp, M A Dennis, S H Parker, and G A Sisney. 1995. "Solid Breast Nodules: Use of Sonography to Distinguish between Benign and Malignant Lesions." *Radiology* 196 (1): 123–34. <https://doi.org/10.1148/radiology.196.1.7784555>.

Acknowledgments

This work was funded by Fundação para a Ciência e Tecnologia (FCT) under the national project UIDB/50008/2020 and the PhD scholarship number SFRH/BD/144961/2019.

Instrumented Suit For Clothing Design And Performance Improvement In Cycling

Miguel Velhote¹, Waldri Oliveira²

¹INESCTEC/FEUP, University of Porto, Portugal – mcorreia@fe.up.pt

²INESCTEC/FEUP, University of Porto, Portugal – waldri.oliveira@fe.up.pt

Abstract

This paper describes the design of a suit equipped with several types of sensors, capable of monitoring the elastic stresses of the fabric, temperature, humidity, and movements of the user, and a mobile application capable of collecting and managing this data set. These data, once combined, will assist the designers in the selection of materials and a more precise definition of cuts and molds for the composition of garments. To reduce losses and speed up the process manufactory.

Author Keywords. Athlete clothes, Biomedical, Sensor, Mobile App.

1. Introduction

To support the development of products and suits for cycling athletes, a task was carried out on specific measures for each user. Currently, this process is practically subjective and manual, and throughout the creation, generating several test models, which are discarded, until reaching the ideal dimensions of the product, resulting in many material losses and hours of work. The productive process of the textile and clothing industry, comprises the elaboration of the molds of the models to be made. Firstly, the model designed according to body measurements and customer specifications. This process is currently manual and subjective, and throughout the creation and design, several proof garment models are generated and discarded, until reaching the final product with the desired dimensions and characteristics, resulting in the losses of large quantities of raw materials and hours of work. This waste, which is even more undesirable in garments with expensive raw materials, such as those intended for high-performance sports. In order to support the development of garments and suits for cycling athletes, to reduce losses and speed up the process, one of the sub-projects of TexBoost was to research and develop a sports suit equipped with several types of sensors, capable of monitoring the elastic strains of the fabric, as well as the temperature, humidity and movements of the user.

The main objective was to develop a tool for textile companies to support product development, namely sport garments. This tool consists of an instrumented suit (underwear type) and a mobile application (app). A second objective is to provide data to optimize the performance of cyclist.

2. Devices and sensors.

Several electronic components are integrated into the suit (Figure 1), namely: are two processing modules consisting of a micro-controller, with wired communication, wireless communication, power regulator, rechargeable battery, and a 9 degree-of-freedom inertial motion sensor. 10 motion sensors composed of 9-axis inertial modules (3 accelerometers, gyroscopes, and magnetometers). 14 flexible strain sensors consisting resistive strain gauges made with conductive paste, and 5 temperature and humidity sensors.

The power supply and the communication between modules and sensors is carried out, by conductive threads with four lines incorporated in the textile meshes (Figure 2 (a)). The strain sensors are bond to the fabric. The central and inertial, temperature, and humidity modules are encapsulated in the garment in watertight bags. A rechargeable battery is located next to each central module to supply power to the entire system. The battery provides enough power for a full training day of at least 8 hours.

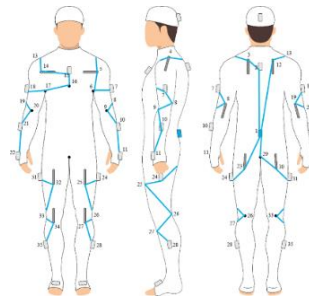

Figure 1 – Devices and Sensor locations.

The processing modules concentrate all data in direct communication with the sensors. This is carried out with a wired connection using the serial communication I2C (Inter-Integrated Circuit) protocol and performs wireless communication with the tablet or smartphone via wireless communication. All sensors are synchronized to the same “real-time clock”. Signal samples are acquired with a “timestamp” so that the acquired data is reliable and with a temporal resolution of 1ms. Each sensor sends the raw data to the central module, which must be converted after being captured, the mobile application, convert this data, into a measuring unity. Applying specific formulas, for instance, the thermometer (1), where 2^{16} directly connected with the resolution bits of the sensor.

$$C = \left(\frac{TEMP_{Raw}}{2^{16}} \right) * 165 - 40 \quad (1)$$

The sensor to measure the elastic stresses applied to the suit was developed as a whole, from its materials to electronics in the laboratory Figure 2 (a). All sensors are installed in strategic positions with conductive chemical welding Figure 2 (b).

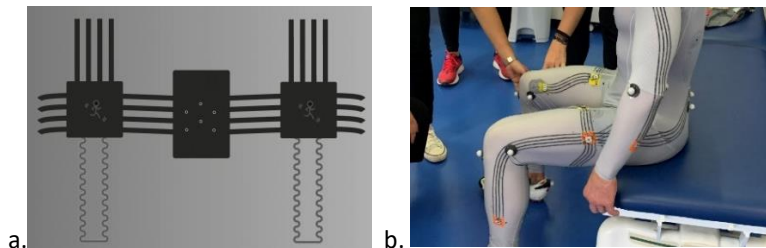

Figure 2 – The extender sensor (a) / instrumented suit (b).

3. Functionalities of app

The functions of the mobile application are I) to collect, store, and export the data sent by the central unit of the suit; II) to organize the stored data, making it possible to manage several users and tests; III) to perform visual processing (by graphics) that helps the user during the training collection task. In hybrid development, pagination is not done file by file since all screens are loaded from a single HTML document. Screen navigation (Figure 3) is done by managing variables, allowing you to display a specific screen. This strategy is also applied for multi-language support, each text has an alternative, for each supported language.

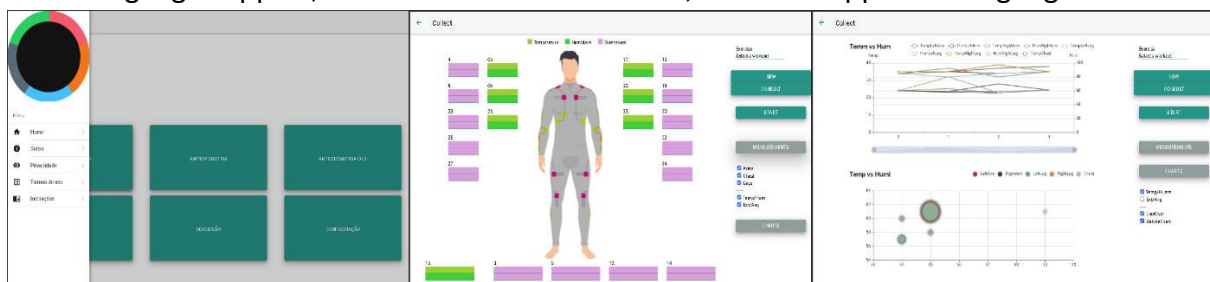

Figure 3 – screens of app <increase>

4. The technology app development

In recent years, a new concept has emerged for the rapid programming of mobile applications, hybrid development. Which uses HTML5 as a programming language, became an easy job to transplant the code from the website to the mobile phone (Que, et. al., 2016). The technology adopted to develop the mobile application was the Apache Cordova environment. Apache Cordova makes it possible to generate the application on multiple platforms, Android, IOS, or Windows, an open-source mobile development framework. It also has the possibility of rapid assimilation of functionality by partner codes, called plugins. Guaranteed access/requests for different types of hardware. The necessary environment for Cordova to function properly is Node.js, an asynchronous JavaScript interpreter with open event-oriented code, focused on migrating the client's JavaScript programming to the servers. A set of tools and frameworks have been incorporated, plugins: for Bluetooth communication provided by PLUX circuits; SQLite, a database previously developed in C (program language), with a syntax compatible with MySQL. Also, JavaScript frameworks facilitated the user's visual experience, such as Framework7, for managing screen navigation and transition effects, including EChart, an intuitive and responsive graphics generation library (ECharts, 2021).

The application was fully developed, using a full-stack methodology, passing the steps of I) requirements gathering, II) mockups elaboration and validation by teams III) back-end and front-end coding; IV) real tests. Views are responsive, adjusting to various screen sizes and formats. The functions were grouped in "JS" files classified by types for: database management, registration manipulation, animations, navigation, Bluetooth communication, creation of detailed graphics. During the connection with the devices of the suit, in order not to overload the database with requests, programmed memory dumps are grouped, which also prevents data loss. Concepts such as instances, class, attributes, and others typical in UML data modeling were essential, to deal elements controlling database events.

5. Conclusions

The initial objectives were achieved and satisfactory. It was possible to collect and manage the data sent by the suit. Much of the information that does not require major processing, extensions, temperatures, and humidity, is easily converted into knowledge for the production process, in the context of adjusting cutting clearances, material selection. For future work, it is observed that it requires more robust processing (impossible with mobile devices) of the angles, speeds, and directions performed by the user, to obtain more detailed information for the production chain.

References

- D'Addio, Giovanni, et al. "Development of a prototype e-textile sock." *2019 41st Annual International Conference of the IEEE Engineering in Medicine and Biology Society (EMBC)*. IEEE, 2019.
- Morteza Amjadi, Ki-Uk Kyung, Inkyu Park, and Metin Sitti. Stretchable, skinmountable, and wearable strain sensors and their potential applications: a review. *Advanced Functional Materials*, 26(11):1678–1698, 2016.
- Que, Peixin, Xiao Guo, and Maokun Zhu. "A comprehensive comparison between hybrid and native app paradigms." *2016 8th International Conference on Computational Intelligence and Communication Networks*. IEEE, 2016.
- ECharts. "Apache ECharts". Available in: <https://echarts.apache.org/en/feature.html>. Accessed in 18 May 2021.

Acknowledgements

The research project, arose from the partnership with research institutions Institute of Systems and Computers Engineering, Technology and Science (INESC TEC), the University of Porto, and companies in the textile sector P&R Têxteis, LMA, and PLUX technology.

Circuit Traces on Plastic Surfaces: Laser direct structuring allows selective metallization for sensors development and integration

Luciano Rietter^{1,2,*}, Ricardo Freitas¹, Filipa Carneiro¹

¹ PIEP - Innovation in Polymer Engineering (Portugal); ² PDEEC University of Minho (Portugal);

* lucianorietter@gmail.com

Abstract

The sensor market is growing and is expected to expand significantly over the next years. The flexibility to incorporate them in different locations and devices, exposed to sometimes harsh environments are pushing new requirements. Laser Direct Structuring (LDS) allows selective metallization for circuit traces and electrodes directly into plastic surfaces. By replacing conventional Printed Circuit Boards (PCBs), LDS reduces complexity, weight, processes and, therefore, costs of components and devices. Besides, this technology presents an increase in design freedom for creation of circuit traces and sensors. This work presents the evaluation of designed circuit traces with different lengths and thickness using LDS technology. Profile and resistance were obtained and compared. The results show that thicker traces with parallel structuring results in lower resistance values.

Author Keywords. sensor design, sensor, circuit traces, laser direct structuring, polymer processing.

1. Introduction

The sensor market is projected to reach \$345.77 billion by 2028 (Kundan, Patil and Kumar 2021) and the flexibility to incorporate them to different locations and devices is needed. Three-dimension molded interconnect devices (3D-MID) integrate electrical and mechanical functions onto the surface of plastic components (Franke 2014). Commonly used in mobile industry and for automotive applications, 3D-MID reduce the complexity of the device and allow weight and costs reductions. One of the best-established approaches to create these 3D-MID devices is called Laser Direct Structuring (LDS) and comprehend to use an injection molded plastic with metallic additives that will be subsequently activated by a laser. After the laser activation, the piece or component is metallized using electroless plating and the structured pattern becomes conductive. By creating these electronic circuits, LDS allows creation of circuit traces and capacitive sensors and its integration without the need of PCBs, all directly on plastic surfaces. This work presents the results obtained from research focused on traces developed with LDS technology. It focuses on the comparison of different methods for structuring the traces and geometries.

2. Materials and Methods

Nd:YAG laser with 1064 nm wavelength (LPKF, LPKF Fusin3D 1100) was used to structure injected samples (Engel 45T HL ES200) with 60 mm diameter and 2 mm thick. The material used was Liquid Crystal Polymer (LCP) Vectra 840i from Celanese[®]. After the injection process, traces with length of 15, 30 and 45 mm and thickness of 300, 400, 500 and 600 μm were structured with LDS. Structuring was performed in parallel and perpendicular directions to the traces and using two different parameters: 5 W and 175 kHz and 4,5 W and 190 kHz, represented by A and B, respectively. After the structuring process, profile measurement was conducted in 3D optical microscope (Alicona, InfiniteFocus SL). The samples proceeded to electroless bath for copper deposition at 46 °C during 2 hours and 10 minutes. The profiles were again measured for direct comparison and obtention of approximate copper layer. Then, the resistance of traces was obtained (QuadTech 1920 Precision LCR Meter). The results are presented in the following section.

3. Discussion

Perpendicular structuring, in contrast to parallel structuring, in addition to take longer time during the structuring phase, it also worsens the quality of traces. The results obtained show that the amount of copper deposited is visibly lower (Figure 1). Same trace length (45 mm), thickness (600 μm) and parameter (A – 5 W, 175 kHz) were used in this comparison. Table 1 provides resistance measurements in which the overall value for perpendicular structuring (R_{PERP}) is about 40-50% larger than parallel structuring (R_{PAR}).

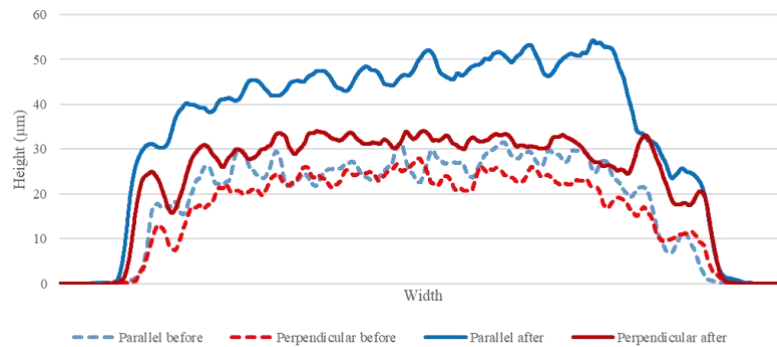

Figure 1 - Difference of metallization regarding the direction of structuring with LDS. Dotted lines represent the pre-metallization profile measurement and uniform lines after metallization measurement.

Structuring Parameter	Structuring Direction	Trace length [mm]	Mean [Ω]	R trace [Ω/mm]	Mean R trace [Ω/mm]	$R_{\text{PERP}} / R_{\text{PAR}}$
A	PARALLEL	15	3,0632E-02	2,0421E-03	2,0558E-03	155%
		30	6,1692E-02	2,0564E-03		
		45	9,3095E-02	2,0688E-03		
	PERPENDICULAR	15	5,4249E-02	3,6166E-03	3,1848E-03	
		30	8,7815E-02	2,9272E-03		
		45	1,3548E-01	3,0107E-03		
B	PARALLEL	15	3,7090E-02	2,4727E-03	2,4369E-03	141%
		30	7,2504E-02	2,4168E-03		
		45	1,0895E-01	2,4212E-03		
	PERPENDICULAR	15	4,9843E-02	3,3229E-03	3,4297E-03	
		30	1,0610E-01	3,5368E-03		
		45	1,5433E-01	3,4295E-03		

Table 1 - Resistance values measured for traces with different structuring directions: parallel and perpendicular to the direction of traces. Mean given by three identical measurements.

When it comes to the thickness of traces and its corresponding resistance, traces with 300 and 600 μm thick were compared, represented by R_{300} and R_{600} respectively. It was found that the resistance of thinner traces corresponds to higher resistance values than the thicker, since its cross-sectional area is lower. Table 2 presents the values obtained from measurements. These vary from 2,3 to almost 3 times more when in theory it should be double. This behavior is aligned with expected by the electrical resistance formula (1).

$$R = \frac{\rho \cdot L}{A} \quad (1)$$

As the conductive material (ρ) is the same and the values of length (L) were normalized – given in Ohm/mm –, the only variable is the area A. Greater the area, lower the resistance. Figure 2

shows the approximate profile and the visible greater copper area in 600 μm thick trace. Same trace length (15 mm) and structuring parameters (parallel, A) were used in this comparison.

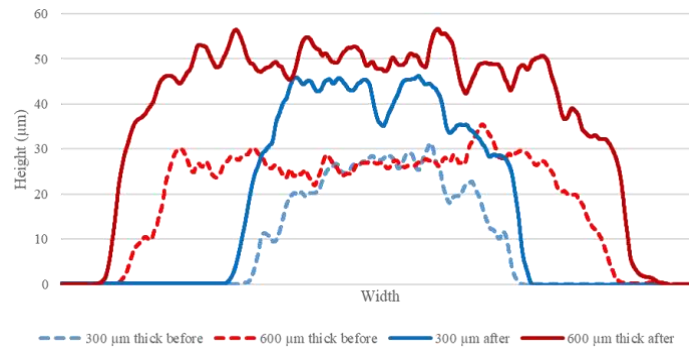

Figure 2 - Structuring and metallization for different thickness traces. Dotted lines represent the pre-metallization profile measurement and uniform lines after metallization measurement.

Structuring Parameter	Trace thickness [μm]	Trace length [mm]	Mean [Ω]	R trace [Ω/mm]	Mean R trace	R_{300} / R_{600}
A	300	15	6,5510E-02	4,3674E-03	4,6735E-03	227%
		30	1,3369E-01	4,4562E-03		
		45	2,3386E-01	5,1969E-03		
	600	15	3,0632E-02	2,0421E-03	2,0558E-03	
		30	6,1692E-02	2,0564E-03		
		45	9,3095E-02	2,0688E-03		
B	300	15	7,6725E-02	5,1150E-03	7,0789E-03	290%
		30	2,0911E-01	6,9704E-03		
		45	4,1181E-01	9,1513E-03		
	600	15	3,7090E-02	2,4727E-03	2,4369E-03	
		30	7,2504E-02	2,4168E-03		
		45	1,0895E-01	2,4212E-03		

Table 2 - Resistance values measured for traces with different thickness: 300 and 600 μm . Mean given by three identical measurements.

4. Conclusions

In this work, investigations about the behavior of LDS technology in the development of electronic circuits directly on the surface of polymeric parts were presented. The results of the study indicate that parallel structuring and thicker traces tend to obtain lower resistance values. For some specific applications thinner traces must be developed so future work should be dedicated to develop methods to obtain lower resistance values. Also, the evaluation of the behavior of electrodes aiming at the development of capacitive sensors and other integration processes should be studied.

References

- Franke, J. 2014. *Three-Dimensional Molded Interconnect Devices (3D-MID): Materials, Manufacturing, Assembly, and Applications for Injection Molded Circuit Carriers*. Hanser Publishers.
- Kundan, N N, Asavari Patil, and Vineet Kumar. 2021. "Sensor Market Outlook – 2028." Allied Market Research. 2021. <https://www.alliedmarketresearch.com/sensor-market>.

Ka-band low loss and cost MMIC-integration in standard QFN-package.

H. Safdary, H. M. Salgado

FEUP - Faculty of Engineering, University of Porto, Porto, Portugal

up201802210@fe.up.pt, hsalgado@fe.up.pt

Abstract

This paper presents a Ka-band transmitter MMIC-integration (Monolithic Microwave Integrated Circuit) in low-cost plastic molded surface-mount Quad Flat Non-leaded package (QFN). The laminate design inside the package uses the copper pillar bump technique (Cu-pillar) for flip-chip integration and thermal power dissipation. A standard process modification of the package is described that leads to the extension of its operating frequency range. The MMIC-integration, package modeling, and simulation results show an estimated increase in the bandwidth of 100% compared to the original QFN-package. The bandwidth improvement was verified with measurement results for the frequency range of 22-32 GHz. The package exhibits a flat loss below 0.6 dB, input, -and output return loss below 7.5 dB for ka- band MMIC system-in-package (SIP) applications.

Author Keywords. MMIC-integration and packaging, EM-simulations, QFN-package, laminate design, CPW-interconnection.

1. Introduction

Demand for high data rate, low time latency, small size, and spectral efficiency are the driving forces behind moving towards microwave and millimeter-wave spectrum where allocated available bandwidth satisfies the requirement for more channel capacity. The evolution of today's SATCOM-communication systems in the 5G-ecosystem are responding to an increased need for a global data rate transfer capacity and lower time latency by allocating operating frequency bands towards the Ka-band (Rangan 2014). The cost-effective silicon-based processes can address MMIC- design including the required digital part for control, data processing, and digital interface in SIP applications. However, this requires packaging miniaturization, low cost, and reliable manufacturing techniques to close the gap between concept and time-to-market as well as Size, Weight and Power (SWaP) demands needed for a system such as phased array antenna used in future SATCOM application (Benson 2019).

2. Background

The choice of the packaging technology is crucial to overcome performance degradation due to the package parasitic effects to ensures that MMIC application requirements are fulfilled and introducing a cost-effective product to the market is guaranteed. Packaging sets the bidirectional interface to the outside world, and vice-versa, of the module inside the package concerning electrical, mechanical, and thermal properties. Increasing operating frequency leads to reduce package size, which can adversely affect package reliability and performance. Additionally, for a small package, the process tolerances are more pronounced and can cause electrical performance and yield degradation (Wein 1995). The wire-bond technology has been applied for power amplifier MMIC-packaging only at module level up to ka-band (Bessemoulin et al. 2006; Lin et al. 2012). However, increasing operation frequency imposes a challenge in MMIC performance due to inductive and coupling parasitic effects associated with the wire-bond connection. Furthermore, wire-bond performs poorly to distribute heat flow and to provide cooling mechanisms. In SIP-Integration, Cu-pillar techniques provide a superior solution for reducing performance degradation

and improving thermal management, as Cu-pillars can be placed where excess local heat arises, and thermal pads were allocated on-chip (Wen 1999).

3. Design

Reduced chip size in the advanced silicon-based process requires integration techniques for mass production using low-cost assembly setup and materials, such as commercially available QFN-package. The flip-chip integration utilizes the Cu-pillar bump technique for attaching the die to the laminate to facilitate fanout of signals. The suggested MMIC-integration, combining two processes, provides a model using full EM simulation for interconnections such as coplanar waveguide (CPW), identified required Cu-pillar bump size, and vias, distance for the frequency range of operation. The frequency band limitation imposed by parasitic effects of the standard package was alleviated by fusing GND-pads of RF-interface connections to metalized paddle area on the bottom in QFN-package, resulting in reduced round-return current paths. Further, the resonance due to the eigenfrequency mode of the rectangular cavity was prevented by increasing vias density in the design (Szymanowski and Safavi-Naeini 2000; Dhar et al. 2011).

3.1. Results and discussion

Fig. 1 shows the electromagnetic model, including the flipped chip attached to the laminate using Cu-pillar, CPW- interconnection configuration using vias connected to the leads of the QFN-package. Fig. 2 represents simulation results of the insertion loss (S_{21}) of the modified package (pink) compared to the standard QFN-package (red). Results indicate an achievement of frequency bandwidth extension in the modified OFN-package up to 38 GHz, an increase of 23 GHz, combined with a flat loss of 1.024 dB. MMIC integration was evaluated by designing back-to-back test structures of the flip-chip interface to package (Fig.1) using a 2.5 mm long transmission line (TL) on silicon with an on-wafer measured loss of 1.7 dB. The designed package was mounted on an evaluation board and connected to connectors to perform measurement using the vector analyzer. Fig. 2 illustrated the assembled device under test (DUT), de-embedded reference plan for data post-processing, and depicted the measurement results of the test structure. The maximal de-embedded loss of 2.65 dB was measured for the back-to-back test package including TL-loss for the frequency range of operation. The mismatch loss in the evaluation board was further reduced using Co-simulation of the package interface and board connection in PCB design. The measurement results of the designed package show a low loss of 0.5 dB and a return loss better than 7.5 dB for Ka-band MMIC- integration.

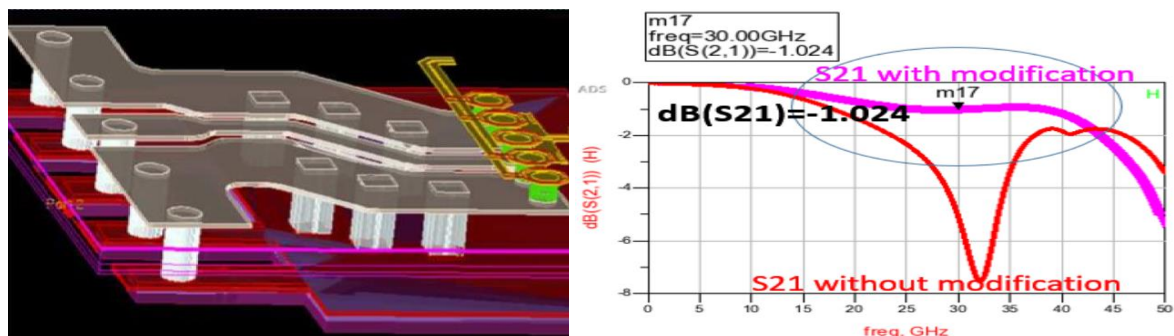

Fig. 1. EM-model of RF-interface (left) and EM-simulation results for modified package compared to original (right).

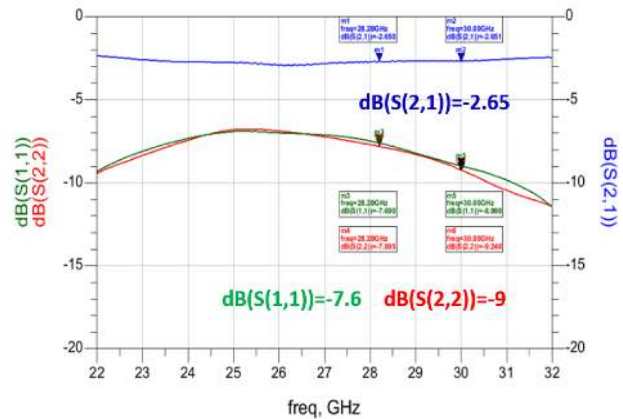
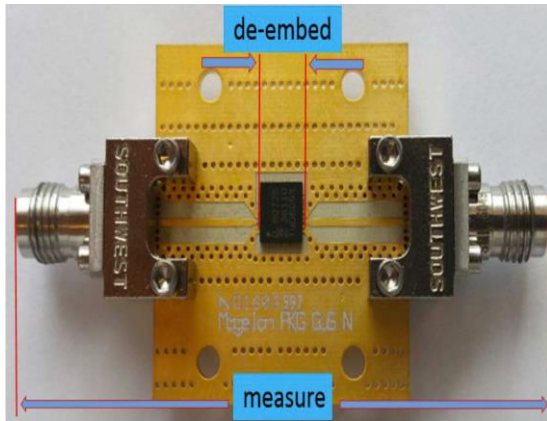

Fig. 2. Mounted 5mm x 5mm QFN-package on PCB (left) and de-embedded measurement results of back-to-back test structure connected with 2.5 mm-TL for modified package (right).

4. Conclusions

Some of keys critical criteria for successful mass production of packaged SIP for MMIC are the low cost, reliability, low loss, and small footprint for roll-off in the market. In this paper, we propose a modification of the standard process applied to a low-cost QFN- package that is sufficient to operate at the microwave frequency ranges. Since the designed package performs in a broad frequency range, it can easily accommodate various chipsets using the same process, thereby eliminating overhead cost. Fully EM-simulation of the modified QFN-package and measurements for Ka-band MMIC-integration was carried out that indicates a reduction of loss and bandwidth expansion in packaging. The package loss for a single RF interface was assessed to be 0.5 dB and 0.45 dB at 28.2 GHz-30 GHz, respectively. The package maintains a return loss below 7.5 dB for the operating frequency band.

References

- Benson, K. 2019. "Phased array beamforming ICs simplify antenna design." *Analog Dialogue* 53.
- Bessemoulin, A, YH Suh, D Richardson, SJ Mahon, and JT Harvey. 2006. "A Compact 500-mW Ku-band Power Amplifier MMIC in 3×3-mm 2 Quad Flat (QFN) Packages." 2006 European Microwave Integrated Circuits Conference.
- Dhar, Jolly, Raj Kumar Arora, A Dasgupta, and SS Rana. 2011. "Enclosure effect on microwave power amplifier." *Progress In Electromagnetics Research C* 19: 163-177.
- Lin, Yi-Chieh, Yu-Chih Lin, Tzyy-Sheng Horng, Lih-Tyng Hwang, Chi-Tsung Chiu, and Chih-Pin Hung. 2012. "Low cost QFN package design for millimeter-wave applications." 2012 IEEE 62nd Electronic Components and Technology Conference.
- Rangan. 2014. "Millimeter-wave cellular wireless networks: Potentials and challenges." *Proceedings of the IEEE* 102 (3): 366-385.
- Szymanowski, Margaret, and S Safavi-Naeini. 2000. "Characterization of a flip-chip interconnect at frequencies up to 30 GHz." 2000 Canadian Conference on Electrical and Computer Engineering. Conference Proceedings. Navigating to a New Era (Cat. No. 00TH8492).
- Wein, Deborah S. 1995. "Advanced ceramic packaging for microwave and millimeter wave applications." *IEEE Transactions on Antennas and Propagation* 43 (9): 940-948.
- Wen, Sihua. 1999. "Thermal and thermo-mechanical analyses of wire bond vs. three-dimensionally packaged power electronics modules." Virginia Tech.

Acknowledgements

The author would like to thank Nicolae Cazana (NXP) for PCB design and measurements.

Sustainability Analysis of Complex Multi-Lane Intelligent Signalized Intersections

Radha Reddy^{1,2,3}, Luis Almeida^{1,3}, Miguel Gaitan^{1,2,3},
Pedro Santos^{1,2,3}, Eduardo Tovar^{1,2}

¹CISTER Research Center, Alfredo Allen 535, 4200-135 Porto, Portugal.

²ISEP, R. Dr. Antonio Bernardino de Almeida 431, 4200-072 Porto, Portugal.

³FEUP, R. Dr. Roberto Frias, 4200-465 Porto, Portugal.

Abstract

Multi-lane road intersections are complex intersections with multiple-inflow/outflow lanes that are either dedicated or shared. Intelligent intersection management (IIM) strategies play a vital role in sustainable transportation by mitigating traffic congestion and reducing waiting times and associated fuel wastage. In this work, we carry out a sustainability analysis of three state-of-the-art IIMs quantitatively for mixed autonomous and human-driven vehicles. Simulation results achieved with SUMO show that the synchronous framework outperforms all the counterparts with the lowest average waiting time and average fuel consumption.

Author Keywords. Intelligent transportation systems, intelligent intersection management, urban traffic management.

1. Overview

Intersections are fundamental elements of urban traffic management (UTM) and are identified as bottlenecks. Intelligent intersection management (IIM) approaches significantly reduce traffic congestion and associated fuel wastage. In this context, we consider complex multi-lane road intersections with several inflows and outflows some of which can use dedicated and shared lanes. In particular, we look at a typical four-way two-lane road intersection considering a dedicated lane for turning left and a shared lane to turn right and straight crossing. We do not consider a dedicated right-turning since it is suggested for a one-way road to a one-way road or for high-speed road lanes, only (Chandler et al., 2013). [Figure 1](#) illustrates such intersection, with the dedicated and shared lanes also indicating all possible outflow lanes coming from all possible inflow lanes, highlighting the diverging, crossing, and merging conflicts. The crossing conflicts, as explained further on, are used by one of the IIM protocols that we analyze to decide the admission of vehicles into the intersection.

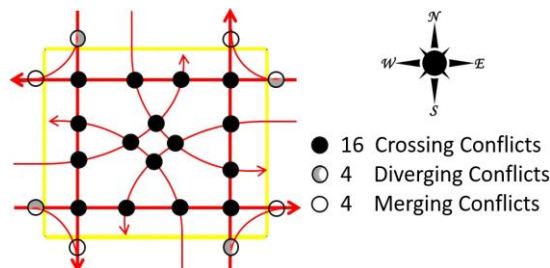

Figure 1: Potential conflicts among all possible crossings in the considered type of intersection.

2. Intelligent Intersection Management Strategies

This paper compares three state-of-the-art IIM policies in terms of sustainability when applied to complex multi-lane road intersections with two inflow and two outflow lanes per road. By sustainability we refer the determination of the respective saturation points in traffic throughput. One of these IIM policies is the synchronous intersection management

protocol (SIMP), which was originally presented in (Reddy et al. 2021). The other two are the intelligent traffic light control (ITLC) policy (Younes et al. 2014) and the Q-learning-based traffic light control (QTLC) policy (Abdulhai et al. 2003), all applied to the same intersection as shown in [Figure 1](#).

SIMP was initially proposed within an intelligent intersection management architecture (IIMA) to provide smoother vehicles behavior considering a mix of both human-driven vehicles (HVs) and autonomous vehicles (AVs) at an isolated simple single-lane road intersection (Reddy et al., 2019). IIMA uses roadside units (RSUs) equipped with multiple sensors, e.g., magnetic loops and cameras, to detect HVs presence and intersection crossing direction. An RSU is employed at each road for information collection and communication with the traffic lights controller (TLC). The SIMP protocol is implemented in the TLC unit. Once vehicles approach the intersection, the TLC will use their directions and consult a Conflicting Directions Matrix (CDM) to decide whether they can enter or have to wait. The CDM plays a significant role in SIMP decision-making by providing conflict-free movement of vehicles within the intersection in cycles. At each cycle, multiple vehicles from multiple lanes are allowed to access the intersection if their directions do not conflict, according to the CDM. The outcome of TLC decision-making is sent to AVs as data messages and to non-communicating HVs using physical traffic light signals, only. IIMA/SIMP was initially extended for multi-lane intersections in (Reddy et al., 2021).

The Intelligent Traffic Light Controlling (ITLC) policy was proposed to reduce waiting time by increasing traffic fluidity. Similarly, to SIMP, ITLC employs sensory information for determining traffic light phases, order, and length (time) of execution using the information of individual traffic flows, such as queue length, vehicle speed, and acceleration. The lane with the longest queue gets the highest priority in the allocation of green phases. The vehicle speed and distance to the intersection are employed to determine the queue's traversal time, and the largest traversal time is utilized for allocating green phase timing up to a limit of 60s, followed by a 3s yellow phase. The ITLC was implemented on the same four-way two-lane intersection as SIMP.

The Q-learning-based traffic light control (QTLC) policy was introduced for reducing time delays based on multi-agent systems. QTLC utilizes queue-length and elapsed phase time for TLC decision-making, which decides whether to continue with the current phase or switch to another phase at a penalty for total vehicle delays. In QTLC, the minimum TLC cycle length is fixed to 20s, with an arbitrary limit of 10s at the beginning and 10s at the end of the cycle, accompanied by a 4s yellow phase while the other lanes are blocked with red phases. Like the other two protocols, QTLC was also implemented on the same four-way two-lane intersection.

3. Performance Evaluation

We used the SUMO v1.6.0 simulator to implement and simulate IM strategies targeting an isolated intersection in a low-speed urban flat-road environment with a 30Km/h speed limit. The traffic is 50% HVs and 50% AVs of identical dimensions arriving randomly at the intersection. The rest of the relevant simulation parameter values are taken from (Reddy et al., 2021). In this work, different traffic arrival rates are used (0.05veh/s, 0.067veh/s, 0.1veh/s, 0.133veh/s, 0.2veh/s, 0.3veh/s, and 0.4veh/s). Moreover, the performance is evaluated in terms of average waiting time and associated average fuel consumption for 1000 mixed vehicles. The results are shown in [Figure 2](#). Note that each data point is an average of five simulation runs with different random seeds.

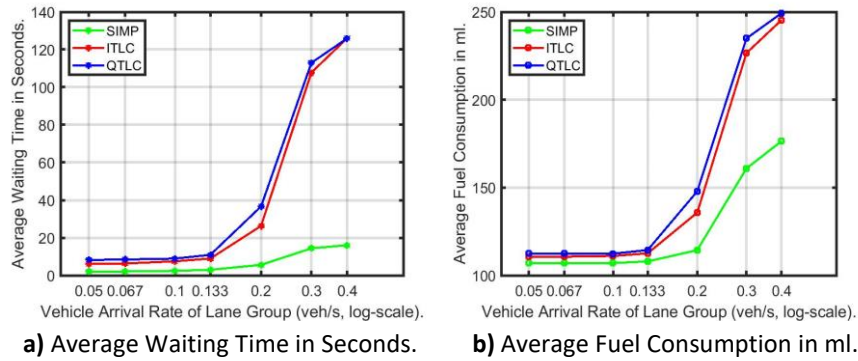

Figure 2: Comparison of waiting time and fuel consumption averaged for 1000 mixed vehicles.

The average waiting time results presented in Figure 2a show the dominance of the synchronous approach (SIMP) against the other two approaches, exhibiting the lowest average waiting time values. Notably, this behavior is observed up to saturation conditions, i.e., around 0.4veh/s. At this arrival rate, SIMP managed to reduce 100s of waiting time when compared to ITLC and QTLC. Likewise, average fuel consumption results shown in Figure 2b also exhibit a clear advantage of using the synchronous framework, with the lowest values when compared to the counterparts, i.e., around less 70ml for the total route at 0.4veh/s. This results from the smoother velocity pattern induced by the synchronous behavior of mixed vehicles at the intersection, at the expense of more complex sensing mechanisms to handle non-communicating HVs.

4. Summary

This work compared the average waiting time and associated average fuel consumption of three state-of-the-art IIM approaches for an isolated multi-lane road intersection under mixed traffic conditions. Simulation results with SUMO show the advantages of employing a synchronous protocol against common approaches based on sequential phases. In the future, we will analyze the applicability of these IIM policies for mixed traffic with respect to vehicle size, e.g., a mixture of light-duty vehicles and heavy-duty transportation trucks.

References

- Abdulhai, B., Pringle, R. and Karakoulas, G.J., 2003. Reinforcement learning for true adaptive traffic signal control. *Journal of Transportation Engineering*, 129(3), pp.278-285.
- Chandler, B.E., Myers, M., et al. 2013. *Signalized Intersections Informational Guide* (No. FHWA-SA-13-027). United States. Federal Highway Administration. Office of Safety.
- Reddy, R., Almeida, L. and Tovar, E., 2019, December. Work-in-Progress: Synchronous Intersection Management Protocol for Mixed Traffic Flows. In *2019 IEEE Real-Time Systems Symposium (RTSS)*, pp.576-579.
- Reddy, R., Almeida, L., Gaitan, M., Santos, P.M. and Tovar, E., 2021. Synchronous Framework Extended for Complex Intersections. Accepted in 24th EURO Working Group on Transportation Meeting (EWGT2021).
- Younes, M.B. and Boukerche, A., 2014, September. An intelligent traffic light scheduling algorithm through VANETs. In *39th Annual IEEE Conference on Local Computer Networks Workshops*, pp.637-642.

Acknowledgments

This work was partially supported by National Funds through FCT/MCTES (Portuguese Foundation for Science and Technology), within the CISTER Research Unit (UIDB-UIDP/04234/2020).

AUTHORS INDEX

Almeida, Luís	24, 50
Arora, Jatin	30
Azevedo, Eduardo	18
Braña, Luis	15
Carneiro, Filipa	44
Costa, António	21
Costa, Artur	15
Costa, Jorge R.	38
Dujovne, Diego	24
Felício, João M.	38
Fernades, Carlos A.	38
Fernandes, Manuel C. R. M.	14
Figueroa, Alejandro	24
Fontes, Fernando A. C. C.	13, 14
Fred, Ana	38
Freitas, Ricardo	44
Gaitán, Miguel	24, 50
Koubâa, Anis	27
Lopes, Ricardo	15
Macedo, Joaquim	20

Maia, Cláudio	30
Martins, Raquel A.	38
Oliveira, Waldri	18, 41
Paiva, Luís Tiago	13, 14
Pereira, David	33
Proença, José	33
Rashid, Syed Aftab	30
Reddy, Radha	50
Rietter, Luciano	44
Safdary, Hassan	47
Salgado, Henrique M.	47
Santos, Pedro	50
Sena Esteves, João	35
Severino, Ricardo	27
Silva, Elidio	13
Silva, Vinicius	21
Soares, Filomena	35
Spilere Nandi, Giann	33
Tovar, Eduardo	27, 30, 33, 50
Vasconcelos Filho, Enio	27
Velhote Correia, Miguel	41
Vinha, Sergio	13

ISBN: 978-972-752-276-7



🏠 www.fe.up.pt/dce21

✉ dce@fe.up.pt