

N74-10802

**NASA CONTRACTOR  
REPORT**

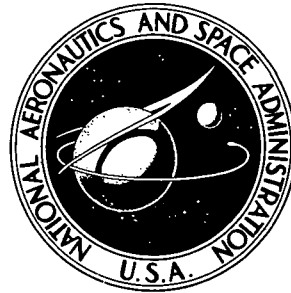

NASA CR-2196

NASA CR-2196

**CASE FILE  
COPY**

**DECOMPOSITION-AGGREGATION  
STABILITY ANALYSIS**

*by D. D. Siljak, S. Weissenberger, and S. M. Cuk*

*Prepared by*

UNIVERSITY OF SANTA CLARA

Santa Clara, Calif. 95053

*for George C. Marshall Space Flight Center*

NATIONAL AERONAUTICS AND SPACE ADMINISTRATION • WASHINGTON, D. C. • NOVEMBER 1973

1. REPORT NO. NASA CR-2196	2. GOVERNMENT ACCESSION NO.	3. RECIPIENT'S CATALOG NO.	
4. TITLE AND SUBTITLE DECOMPOSITION-AGGREGATION STABILITY ANALYSIS		5. REPORT DATE November 1973	
		6. PERFORMING ORGANIZATION CODE M221	
7. AUTHOR(S) D. D. Siljak, S. Weissenberger, S. M. Cuk		8. PERFORMING ORGANIZATION REPORT #	
9. PERFORMING ORGANIZATION NAME AND ADDRESS University of Santa Clara Santa Clara, CA 95053		10. WORK UNIT NO.	
		11. CONTRACT OR GRANT NO. NAS 8-27799	
12. SPONSORING AGENCY NAME AND ADDRESS National Aeronautics and Space Administration Washington, D. C. 20546		13. TYPE OF REPORT & PERIOD COVERED Contractor April-72 April-73 Final Report	
		14. SPONSORING AGENCY CODE	
15. SUPPLEMENTARY NOTES			
16. ABSTRACT  <p>This report presents the development and description of the decomposition aggregation approach to stability investigation approach to stability investigations of high dimension mathematical models of dynamic systems. The high dimension vector differential equation describing a large dynamic system is decomposed into a number of lower dimension vector differential equations which represent interconnected subsystems. Then a method is described by which the stability properties of each subsystem are aggregated into a single vector Liapunov function, representing the aggregate system model, consisting of subsystem Liapunov functions as components. A linear vector differential inequality is then formed in terms of the vector Liapunov function. The matrix of the model, which reflects the stability properties of the subsystems and the nature of their interconnections, is analyzed to conclude over-all system stability characteristics. The technique is applied in detail to investigate the stability characteristics of a dynamic model of a hypothetical spinning Skylab.</p>			
17. KEY WORDS  Stability, dynamics, control systems		18. DISTRIBUTION STATEMENT  31	
19. SECURITY CLASSIF. (of this report)  Unclassified	20. SECURITY CLASSIF. (of this page)  Unclassified	21. NO. OF PAGES  91	22. PRICE  NTIS

CONTENT

1. Introduction. . . . . 1

PART I: THEORY

2. Decomposition . . . . . 5  
3. Aggregation . . . . . 11  
4. Stability . . . . . 17

PART II: APPLICATION

5. Skylab model. . . . . 27  
6. Passive Control . . . . . 33  
7. Active Control. . . . . 44

CONCLUSION . . . . . 56

REFERENCES . . . . . 58

APPENDIX: COMPUTER PROGRAMS

## 1. INTRODUCTION

The purpose of this work is to investigate stability of the spinning Skylab control system [1, 2] by the modern decomposition-aggregation methods [3, 4]. Such an investigation is motivated by the fact that the mathematical model of the system is of high dimension and a straightforward analysis would become bogged down in the welter of detail requiring an excessive computer storage and time to complete the investigation. The multi-level decomposition-aggregation approach offers to solve the stability problems "piece-by-piece" and not only make more economical the computer use, but also reduce the liability of the errors in the analysis. Furthermore, by decomposing the system into parts that have important physical meaning, the decomposition-aggregation approach yields significant structural information about the behavior of the system, which is not generally available in a straightforward stability investigation.

The outline of the work is divided into two parts: Theory and Application. The part on *theory* presents the mathematical basis of the decomposition-aggregation approach - the concept of vector Liapunov functions [3, 4]. In Section 2, it is shown how a vector differential equation of high dimension, which describes a large dynamic system, can be decomposed into a number of vector differential equations of lower dimensions, which represent interconnected subsystems. Then, in Section 3, a method is outlined by which the stability properties of each subsystem are aggregated into a single Liapunov function. The vector Liapunov function is formed which has subsystem Liapunov functions as components. A linear vector differential inequality is then formed in terms of the vector Liapunov function, which represents the aggregate system model. The matrix of the model, which reflects both the stability properties of the subsystems and the nature of their interconnection is analyzed in Section 4 to conclude stability of the over-all system.

The *application* part of the outline presents an application of the decomposition-aggregation method to determine stability of the spinning Skylab control system. In Section 5, equations of motion [1, 2] of the system are given which include both the passive stabilization by extendable booms with tip masses and the active stabilization by control torques about the body fixed axes. Stability analysis of the passive control in Section 6, starts by decomposing the equations of motion into two sets of equations which describe the wobble motion and the in-plane motion. Then two sets of equations are treated as subsystems which makes the coordinates of the tip masses to appear explicitly in the interconnections as structurally important coupling parameters. The decomposition-aggregation method is then used to determine stability of the over-all system as a function of the coupling parameters. The entire stability procedure can be conveniently programmed on the digital computer. The programs and their description is given in the Appendix. In Section 7 the decomposition-aggregation method is used to determine stability of the Skylab control systems when control torques are used. The torques are considered as linear functions of the states and are applied about the corresponding body fixed axes. The unspecified parameters of the linear functions provide a considerable freedom which can be used in the stabilization of the vehicle on the subsystem level. The task of establishing stability of the entire vehicle is, therefore, increasingly easier than that in passive control. However, how to intelligently use the available freedom in the control of the subsystems and produce a higher stability degree of the over-all system, is not yet satisfactorily resolved. A solution to this problem represents one of the major goals of the future efforts in development and application of the decomposition-aggregation methods for stability analysis of complex attitude control systems.

**PART I.**

**THEORY**

## 2. DECOMPOSITION

Decomposition of dynamic systems can be used to overcome the "large size" of the stability problems. A "large" problem is considered as constituted of coupled "smaller" problems which can be (when isolated) solved efficiently in sequence. Then, the solutions of the "smaller" problems are combined together with the constraints on couplings into an aggregated model which is relatively simple to solve. Decomposition algorithms produce considerable saving in both computer storage and the time required to complete the solution of the original problem. Furthermore, if decomposition is performed so that the "small" problems can be physically interpreted (e.g. motion in the pitch plane), a decomposition analysis may produce important structural information about the "large" over-all problem [1, 2].

Let us consider a continuous dynamic system  $S$  described by the vector differential equation\*

$$\dot{x} = f(t, x) , \quad (2.1)$$

where  $x(t) \in \mathbb{R}^n$  is the state of the system  $S$ . The function  $f: T \times \mathbb{R}^n \rightarrow \mathbb{R}^n$  satisfies a global Lipschitz condition so that the solutions  $x(t; t_0, x_0)$  of (2.1) exist and are unique and continuous for all initial conditions  $(t_0, x_0) \in T \times \mathbb{R}^n$  and  $t \in T_0$ . The symbol  $T$  stands for the time interval  $(\tau, +\infty)$ , where  $\tau$  is a number or the symbol  $-\infty$ , and  $T_0$  is the semi-infinite time interval  $[t_0, +\infty)$ .

---

\* With some obvious exceptions, lower case Roman letters denote vectors; capital Roman letters denote matrices, and Greek letters denote scalars.

We assume that the function  $f(t, x)$  in (2.1) satisfies the condition

$$f(t, 0) = 0, \quad \forall t \in T \quad (2.2)$$

and that the origin  $x = 0$  of the state space  $R^n$  is the unique equilibrium state of the system  $S$ . In the following development, the emphasis will be on global stability of the equilibrium  $x = 0$  and the uniqueness of the equilibrium causes no reduction of generality in the results.

A crucial assumption in the following stability analysis is that the dynamic system  $S$  can be (conveniently) decomposed into  $s$  dynamic subsystems  $S_i$  and described by the vector differential equations

$$\dot{x}_i = g_i(t, x_i) + h_i(t, x), \quad i = 1, 2, \dots, s. \quad (2.3)$$

The free (uncoupled) dynamic systems  $S_i$  are described by

$$\dot{x}_i = g_i(t, x_i), \quad i = 1, 2, \dots, s \quad (2.4)$$

where  $x_i(t) \in R^{n_i}$  is the state of  $S_i$ . Therefore (2.3) describes the motion of the interconnected (forced) subsystems  $S_i$ , where the function  $g_i: T \times R^{n_i} \rightarrow R^{n_i}$  corresponds to the subsystem  $S_i$  itself, and the function  $h_i: T \times R^n \rightarrow R^{n_i}$  represents the action of the composite system  $S$  on the subsystem  $S_i$ . We assume again that

$$g_i(t, 0) = 0, \quad \forall t \in T, \quad \forall i = 1, 2, \dots, s \quad (2.5)$$

and  $x_i = 0$  is the unique equilibrium state of the subsystem  $S_i$ .

From (2.3) and (2.4), it is clear that the state  $x_i(t) \in R^{n_i}$  of the subsystem  $S_i$  is the  $i$ -th vector component of the state  $x(t)$  of the over-all system  $S$ . That is,  $x(t)$  can be written as



$$x(t) = [x_1^T(t) \ x_2^T(t) \ \dots \ x_s^T(t)]^T, \quad (2.6)$$

and the state space  $R^n$  of the system  $S$  can be represented by the Cartesian product

$$R^n = R^{n_1} \times R^{n_2} \times \dots \times R^{n_s}. \quad (2.7)$$

Furthermore, each state  $x_i(t)$  of the subsystem  $S_i$  can be written as

$$x_i(t) = [x_{i1}(t) \ x_{i2}(t) \ \dots \ x_{in_i}(t)], \quad (2.8)$$

where  $x_{i1}, x_{i2}, \dots, x_{in_i}$  are scalar components of the vector  $x_i(t)$ .

To illustrate the decomposition formulated above, let us consider the motion of a disk fixed to a rotating shaft as shown on Fig. 2.1. The system is regarded as a massless elastic shaft with a mass particle attached at the center. Friction is assumed to be internal to the shaft. If  $\rho$  and  $\mu$  represent deflections of the mass particle in a coordinate system rotating at the angular velocity  $\omega$  of the shaft then the linearized equations of motion are\*

$$\begin{aligned} m\ddot{\rho} + b\dot{\rho} + (c - m\omega^2)\rho - 2m\omega\dot{\mu} &= 0 \\ m\ddot{\mu} + b\dot{\mu} + (c - m\omega^2)\mu + 2m\omega\dot{\rho} &= 0, \end{aligned} \quad (2.9)$$

where  $m$  is the mass,  $b$  is the damping coefficient, and  $c$  is the stiffness coefficient of the shaft.

Equations (2.9) describing the system  $S$  of Fig. 2.1, can be given in the state form as

\* Ziegler, H., "Principles of Structural Stability", Blaisdell, Waltham, Mass., 1968.

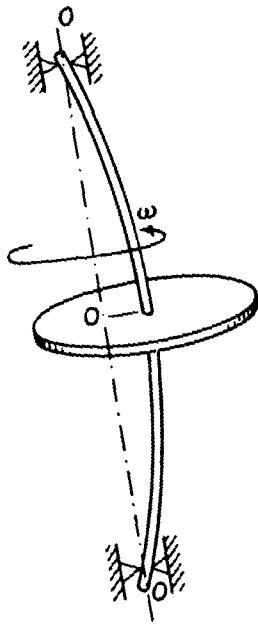

Fig. 2.1

$$\begin{aligned} \dot{x}_{11} &= x_{12} \\ \dot{x}_{12} &= -\left(\frac{c}{m} - \omega^2\right) x_{11} - \frac{b}{m} x_{12} + 2\omega \dot{x}_{22} \end{aligned}$$

(2.10)

$$\begin{aligned} \dot{x}_{21} &= x_{22} \\ \dot{x}_{22} &= -\left(\frac{c}{m} - \omega^2\right) x_{21} - \frac{b}{m} x_{22} - 2\omega x_{12} \end{aligned}$$

where  $x_{11} = \rho$ ,  $x_{12} = \dot{\rho}$ ,  $x_{21} = \mu$ ,  $x_{22} = \dot{\mu}$  are the states of the system  
 $S$  decomposed into the two subsystems

$$\begin{aligned}
S_1: \dot{x}_1 &= \begin{bmatrix} 0 & 1 \\ -(\frac{c}{m} - \omega^2) & -\frac{b}{m} \end{bmatrix} x_1 + \begin{bmatrix} 0 & 0 \\ 0 & 2\omega \end{bmatrix} x_2 \\
S_2: \dot{x}_2 &= \begin{bmatrix} 0 & 1 \\ -(\frac{c}{m} - \omega^2) & -\frac{b}{m} \end{bmatrix} x_2 - \begin{bmatrix} 0 & 0 \\ 0 & 2\omega \end{bmatrix} x_1 .
\end{aligned} \tag{2.11}$$

In (2.11),

$$x_1(t) = [x_{11}(t) \ x_{12}(t)]^T, \quad x_2(t) = [x_{21}(t) \ x_{22}(t)]^T \tag{2.12}$$

are the states of the two subsystems  $S_1$  and  $S_2$ , which are (vector) components of the state vector

$$x(t) = [x_{11}(t) \ x_{12}(t) \ x_{21}(t) \ x_{22}(t)]^T = [x_1^T(t) \ x_2^T(t)] \tag{2.13}$$

for the entire system  $S$ .

By comparing equations (2.11) with equations (2.3), we see that the free subsystems are described by

$$\begin{aligned}
S_1: \dot{x}_1 &= \begin{bmatrix} 0 & 1 \\ -(\frac{c}{m} - \omega^2) & -\frac{b}{m} \end{bmatrix} x_1 \\
S_2: \dot{x}_2 &= \begin{bmatrix} 0 & 1 \\ -(\frac{c}{m} - \omega^2) & -\frac{b}{m} \end{bmatrix} x_2 .
\end{aligned} \tag{2.14}$$

Interactions among the subsystems are represented by the functions

$$h_1(t, x) = \begin{bmatrix} 0 & 0 \\ 0 & 2\omega \end{bmatrix} x_2 \quad h_2(t, x) = - \begin{bmatrix} 0 & 0 \\ 0 & 2\omega \end{bmatrix} x_1 \tag{2.15}$$

Since the system  $S$  is decomposed into two subsystems  $S_1$  and  $S_2$  with apparent physical interpretation, a subsequent stability analysis can yield structural information about the system.

### 3. AGGREGATION

The Liapunov direct method can be viewed as a process by which the stability properties of the motion in the vector space are aggregated into a single scalar function - the Liapunov function. The aggregation procedure, therefore, produces an essential reduction in dimensionality of stability problems at the price of a reduced accuracy in the results. It is also true that generation of appropriate Liapunov functions can seldom be automatic and becomes increasingly difficult for systems of high-dimension. Consequently, in stability analysis of large-scale systems, a straightforward attack by a single Liapunov function becomes cumbersome and another level of aggregation is desirable.

After a large-scale system is decomposed into a number of interconnected subsystems, a Liapunov function is assigned to each isolated subsystem. The subsystem Liapunov functions are then used as components of a vector Liapunov function to construct the aggregate model of the over-all system. The aggregate model is a linear (vector) differential inequality written in terms of the vector Liapunov function, which can be effectively examined for stability by known methods.

Since the subsystems are of relatively low order and often with similar characteristics, the generation of appropriate subsystem Liapunov functions is not exceedingly complex. Moreover, the decomposition of the system may be directed towards producing the subsystems for which Liapunov functions with desired properties are available.

It is, however, true that the necessary properties of subsystem Liapunov functions for construction of the aggregate model, require stability of the subsystems which constrains the decomposition-aggregation stability analysis. Furthermore, in forming the aggregate model, approximations are involved which increase the conservativeness of the over-all results beyond the extent intro-

duced on the subsystem level.

Stability properties of the subsystems are aggregated by scalar functions  $v_i: T \times R^{n_i} \rightarrow R_+^1$  such that  $v_i(t, x_i) \in C^{(1,1)}(T \times R^{n_i})$ , which have the following "linear" estimates:

$$\begin{aligned} \eta_{i1} \|x_i\| &\leq v_i \leq \eta_{i2} \|x_i\| \\ \dot{v}_i &\leq -\eta_{i3} \|x_i\| \\ \|\text{grad } v_i\| &\leq \eta_{i4} \end{aligned} \quad (3.1)$$

where  $\eta_{i1}$ ,  $\eta_{i2}$ ,  $\eta_{i3}$ ,  $\eta_{i4}$  are positive numbers and  $\|x_i\| = (x_i^T x_i)^{1/2}$  is the Euclidean norm of the vector  $x_i$ . In (3.1),  $\dot{v}_i$  is the total time derivative of the function  $v_i(t, x_i)$  along the motion of the free subsystem  $S_i$  described by (2.4), that is

$$\dot{v}_i = \frac{\partial}{\partial t} v_i + (\text{grad } v_i)^T g_i \quad (3.2)$$

Liapunov functions  $v_i(t, x_i)$  with estimates (3.1) are available for large classes of dynamic systems. For example, consider the class of systems with linear, time-invariant subsystems, with

$$g_i(t, x_i) = P_i x_i \quad (3.3)$$

where the  $P_i$ 's are constant-coefficient,  $n_i \times n_i$  matrices. Then, for each subsystem there exists a Liapunov function of the form [3]

$$v_i = (x_i^T H_i x_i)^{1/2} \quad (3.4)$$

whose time derivative on the trajectories of the uncoupled subsystem is given by

$$\dot{v}_i = - (1/2) v_i^{-1/2} x_i^T G_i x_i \quad (3.5)$$

$$\text{where } -G_i = H_i P_i + P_i^T H_i, \quad G_i > 0. \quad (3.6)$$

Direct calculations give

$$\begin{aligned} \eta_{i1} &= \lambda^{1/2}(H_i) \\ \eta_{i2} &= \Lambda^{1/2}(H_i) \\ \eta_{i3} &= \frac{1}{2} \lambda(G_i) \Lambda^{-1/2}(H_i) \\ \eta_{i4} &= \lambda^{-1/2}(H_i) \Lambda(H_i), \end{aligned} \quad (3.7)$$

where  $\lambda$  and  $\Lambda$  denote the minimum and maximum eigenvalues of the indicated matrices, respectively.

In the following Section 4, we will establish the fact that the existence of a Liapunov function with estimates (3.1) implies and is implied by the exponential stability property of the corresponding dynamic system.

*Interactions among the subsystems* are assumed to satisfy the following "conical" constraints

$$\|h_i(t, x)\| \leq \sum_{j=1}^S \xi_{ij} \|x_j\| \quad (3.8)$$

where  $\xi_{ij}$  are nonnegative numbers. For example, if the interactions are linear, time invariant and of the form

$$h_i(t, x) = \sum_{j=1}^S Q_{ij} x_j, \quad (3.9)$$

where the matrices  $Q_{ij}$  are  $n_i \times n_j$  constant-coefficient matrices, then the numbers  $\xi_{ij}$  can be taken as

$$\xi_{ij} = [\Lambda(Q_{ij}^T Q_{ij})]^{1/2}. \quad (3.10)$$

To form the *aggregate model* of the system  $S$  using Liapunov functions  $v_i(t, x_i)$  with estimates (3.1) and interaction constraints (3.8), we take the total time derivative of  $v_i(t, x_i)$  along the motion of the interconnected subsystem  $S_i$  described by (2.3), that is,

$$\dot{v}_i = \dot{v}_i + (\text{grad } v_i)^T h_i(t, x), \quad i = 1, 2, \dots, s. \quad (3.11)$$

By applying inequalities (3.1) and (3.8), we can rewrite (3.11) as

$$\dot{v}_i \leq -\eta_{i2}^{-1} \eta_{i3} v_i + \eta_{i4} \sum_{j=1}^s \xi_{ij} \eta_{j1}^{-1} v_j, \quad i = 1, 2, \dots, s. \quad (3.12)$$

Now, we can define an  $s$  vector  $v$  function  $v: T \times R^n \rightarrow R_+^s$  using (3.5),

$$v = (v_1 \ v_2 \ \dots \ v_s)^T \quad (3.13)$$

which has as components the Liapunov functions  $v_i$  related to each subsystem  $S_i$ . The vector function  $v(t, x)$ , is called the *vector Liapunov function* [1, 2]. With the notation (3.13), scalar inequalities (3.12) can be rewritten in a vector form as

$$\dot{v} \leq Av \quad (3.14)$$

where the  $s \times s$  matrix  $A = (a_{ij})$  has the elements  $a_{ij}$  specified by

$$a_{ij} = -\delta_{ij} \eta_{i2}^{-1} \eta_{i3} + \xi_{ij} \eta_{j1}^{-1} \eta_{i4}, \quad (3.15)$$

where  $\delta_{ij}$  is the Kronecker delta.

Inequality (3.14) is a vector differential inequality and is referred to as the *aggregate model* of the system  $S$ . The matrix  $A$  is called the *aggregate*



matrix.

The aggregate model contains the necessary information about the stability properties of the system  $S$ . The dimension of the model is  $s$  which is less, or at most equal to the dimension  $n$  of the original system. This produces the desired reduction of dimensionality in the stability problems associated with large-scale systems.

For the example, taking  $\frac{c}{m} = \frac{b}{m} = 1$  and  $\omega = 0.04$  we have

$$\begin{aligned}
 P_i &= \begin{bmatrix} 0 & 0 \\ -1.0 & 1.0 \end{bmatrix}, \quad i = 1, 2, \\
 Q_{12} &= \begin{bmatrix} 0 & 0 \\ 0 & 0.08 \end{bmatrix}, \\
 Q_{21} &= \begin{bmatrix} 0 & 0 \\ 0 & -0.08 \end{bmatrix}.
 \end{aligned} \tag{3.16}$$

Then, the choice

$$G_i = \begin{bmatrix} 1 & 0 \\ 0 & 1 \end{bmatrix}, \quad i = 1, 2 \tag{3.17}$$

gives, through the application of (3.7)

$$\begin{aligned}
 n_{i1} &= 1.17 \\
 n_{i2} &= 1.90 \\
 n_{i3} &= 0.26 \\
 n_{i4} &= 1.63, \quad i = 1, 2.
 \end{aligned} \tag{3.18}$$

From (3.10) the numbers  $\xi_{ij}$  are found to be

$$\xi_{12} = \xi_{21} = 0.08 \quad . \quad (3.19)$$

Using (3.15), the elements of  $A$  are calculated as

$$\begin{aligned} a_{11} &= a_{22} = -0.14 \\ a_{12} &= a_{21} = 0.11 \quad , \end{aligned} \quad (3.20)$$

and the aggregate model (3.14) becomes

$$\dot{\mathbf{v}} \leq \begin{bmatrix} -0.14 & 0.11 \\ 0.11 & -0.14 \end{bmatrix} \mathbf{v} \quad (3.21)$$

How the aggregate model (3.21) can be used to conclude (exponential) stability of the original system (2.10), will be explained in the following section.

#### 4. STABILITY

The purpose of this section is to show how stability of a large-scale system can be determined from the stability of the subsystems and the nature of their interactions. On the subsystem level, we first conclude that Liapunov function estimates (3.1) imply and are implied by exponential stability of the subsystems. Then, we establish the same kind of stability for the over-all system by demonstrating stability of the comparison (linear) system.

Let us consider a free dynamic system described by the differential equation

$$\dot{x}_i = g_i(t, x_i) , \quad (4.1)$$

which represents one of the subsystems  $S_i$  of Section 2.

We use the following standard definition of exponential stability [ ]:

Definition 4.1. The equilibrium state  $x_i = 0$  of the free subsystem  $S_i$  is globally exponentially stable if and only if there exist two positive numbers  $\alpha_i$  and  $\beta_i$  independent of the initial conditions  $(t_0, x_0)$  such that

$$\|x_i(t; t_0, x_0)\| \leq \alpha_i \|x_{i0}\| \exp[-\beta_i(t - t_0)] ,$$

$$\forall t \in T_0 , \forall (t_0, x_{i0}) \in T \times R^{n_i} \quad (4.2)$$

Exponential stability can be established by the following modification [ 4 ] of the well-known Krassovskij [ 5 ] result:

Theorem 4.1. The equilibrium state  $x_i = 0$  of the free subsystem  $S_i$  is globally exponentially stable if and only if there exists a function  $v_i(t, x_i)$  on  $T \times R^{n_i}$  with estimates (3.1).

This Theorem follows directly from Krassovskij's result when one con-

siders  $v_i^{1/2}$  instead of  $v_i$ . This modification, however, allows a simple construction of the aggregate model as shown in the preceding Section 3.

Let us prove the sufficiency part (the "if" part) of Theorem 4.1. From the estimates (3.1), it is easy to write the following scalar differential inequality

$$\dot{v}_i \leq -\eta_{i2}^{-1} \eta_{i3} v_i. \quad (4.3)$$

Inequality (4.3) can be integrated to yield

$$v_i[t, x_i(t; t_0, x_{i0})] \leq v_i[t_0, x_{i0}] \exp[-\eta_{i2}^{-1} \eta_{i3}(t-t_0)] \\ \forall t \in T_0, \forall (t_0, x_{i0}) \in T \times R^{n_i}. \quad (4.4)$$

By applying again estimates (3.1), we can rewrite (4.4) in terms of  $\|x_i\|$  as

$$\|x_i(t; t_0, x_{i0})\| \leq \eta_{i1}^{-1} \eta_{i2} \|x_{i0}\| \exp[-\eta_{i2}^{-1} \eta_{i3}(t-t_0)] \\ \forall t \in T_0, \forall (t_0, x_{i0}) \in T \times R^{n_i}. \quad (4.5)$$

Comparing (4.5) with (4.2), we get the positive numbers  $\alpha$  and  $\beta$  as

$$\alpha_i = \eta_{i1}^{-1} \eta_{i2}, \quad \beta_i = \eta_{i2}^{-1} \eta_{i3} \quad (4.6)$$

which are independent of initial conditions  $(t_0, x_{i0})$ . This proves the sufficiency part of Theorem 4.1.

Let us now consider the system  $S$  described by (2.1) and its aggregate model given by (3.7). We prove the following:

Theorem 4.2. *The equilibrium state  $x = 0$  of the system  $S$  is globally exponentially stable if the  $s \times s$  aggregate matrix  $A = (a_{ij})$  satisfies the inequalities*

$$a_{11} < 0, \begin{vmatrix} a_{11} & a_{12} \\ a_{21} & a_{22} \end{vmatrix} > 0, \dots, (-1)^s \begin{vmatrix} a_{11} & a_{12} & \dots & a_{1s} \\ a_{21} & a_{22} & \dots & a_{2s} \\ \dots & \dots & \dots & \dots \\ a_{s1} & a_{s2} & \dots & a_{ss} \end{vmatrix} > 0 \quad (4.7)$$

Proof. According to Definition 4.1, we should prove that inequalities (4.7) represent sufficient conditions for the existence of two positive numbers  $\alpha$  and  $\beta$  independent of the initial conditions  $(t_0, x_0)$ , such that the solution  $x(t; t_0, x_0)$  of equation (2.1) satisfies the following inequality:

$$\|x(t; t_0, x_0)\| \leq \alpha \|x_0\| \exp[-\beta(t-t_0)], \quad \forall t \in T_0 \quad (4.8)$$

for all  $(t_0, x_0) \in T \times R^n$ .

Let us consider a decrescent, positive definite, and radially unbounded function  $v: R^s \rightarrow R_+^1$ ,

$$v(v) = b^T v, \quad (4.9)$$

where  $b > 0$  is a constant s-vector, as a candidate for Liapunov's function [9] for the system S.

Taking the total time derivative along the solutions  $x(t; t_0, x_0)$  of (2.1), we get

$$\dot{v}(v) = b^T \dot{v}[x(t; t_0, x_0)] \quad (4.10)$$

Premultiplying inequality (3.7) by  $b^T > 0$ , we obtain

$$\dot{v} \leq b^T Av. \quad (4.11)$$

Let us rewrite (4.11) as

$$\begin{aligned}
\dot{v} &\leq \sum_{i=1}^s b_i \sum_{j=1}^s a_{ij} v_j \\
&\leq \sum_{j=1}^s v_j \sum_{i=1}^s b_i a_{ij} \\
&\leq -\sum_{j=1}^s v_j b_j |a_{jj}| + \sum_{j=1}^s v_j \sum_{\substack{i=1 \\ i \neq j}}^s b_i a_{ij}
\end{aligned} \tag{4.12}$$

From the definition (3.15) of coefficients  $a_{ij}$  in the matrix  $A$ , we conclude that

$$a_{ij} \begin{cases} < 0 & i = j \\ \geq 0 & i \neq j, \end{cases} \tag{4.13}$$

that is, the matrix  $A$  has nonnegative off-diagonal elements. This special structure of  $A$  makes the conditions (4.7) necessary and sufficient [6] for the existence of a vector  $b > 0$  ( $b_i > 0$ ,  $\forall i = 1, 2, \dots, s$ ) and a number  $\beta > 0$  such that

$$|a_{jj}| - b_j^{-1} \sum_{\substack{i=1 \\ i \neq j}}^s b_i a_{ij} \geq \beta, \quad \forall j = 1, 2, \dots, s \tag{4.14}$$

From (4.12) and (4.14), we get

$$\dot{v} \leq \beta v, \quad \forall t \in T_0, \quad \forall v \in \mathbb{R}_+^1. \tag{4.15}$$

Integrating inequality (4.15), we obtain

$$v[x(t; t_0, x_0)] \leq v(x_0) \exp[-\beta(t-t_0)], \quad \forall t \in T_0, \quad \forall v \in \mathbb{R}_+^1. \tag{4.16}$$

It is left to show that inequality (4.16) implies inequality (4.8) and, thus, global exponential stability of  $S$ . The left-hand side of inequality

(4.16) can be developed as

$$\begin{aligned}
 v[x(t; t_0, x_0)] &= \sum_{i=1}^S b_i v_i \\
 &\leq b_m n_{m1} \sum_{i=1}^S \|x_i\| \\
 &\leq b_m n_{m1} \|x(t; t_0, x_0)\| ,
 \end{aligned} \tag{4.17}$$

where

$$b_m = \min_i b_i , \quad n_{m1} = \min_i n_{i1} . \tag{4.18}$$

In developing (4.17), use is made of the estimates (3.1) and the fact that

$$\sum_{i=1}^S \|x_i\| \leq \sum_{i=1}^S \|x_i\|^2 = \|x\|^2 .$$

The right-hand side of (4.16) can be re-written on the basis of the following derivation

$$\begin{aligned}
 v[x_0] &= \sum_{i=1}^S b_i v_i \\
 &= \sum_{i=1}^S b_i |v_i| \\
 &\leq b_M \sum_{i=1}^S |v_i| \\
 &\leq s^{1/2} b_M \|v\| \\
 &\leq s^{1/2} b_M n_{M2} \|x_0\| ,
 \end{aligned} \tag{4.19}$$

where

$$b_M = \max_i b_i , \quad n_{M2} = \max_i n_{i2} . \tag{4.20}$$

In derivation (4.19), again the estimates (3.1) are used and the well-known

relationship concerning the Euclidean norm and the absolute value norm,

$$s^{1/2} \|v\| \geq |v| .$$

By using (4.16) and (4.18), we can rewrite inequality (4.15) as inequality (4.8) with

$$\alpha = s^{1/2} b_m b_m^{-1} n_{M2} n_{m1}^{-1} \quad (4.21)$$

and  $\beta$  defined in (4.13). This proves Theorem 4.2.

To calculate  $\alpha$  and  $\beta$  in (4.8), we need first to determine a vector  $b > 0$  in (4.9),

$$v = b^T v , \quad (4.9)$$

and (4.11) which we can rewrite as

$$\dot{v} \leq -c^T v \quad (4.22)$$

where the vector  $c$  is defined as

$$c^T = -b^T A . \quad (4.23)$$

Since the coefficients  $a_{ij}$  satisfy (4.11), conditions (4.7) are necessary and sufficient [6] for existence of a positive vector  $b$  for any positive vector  $b$  for any positive vector  $c$ . Consequently, one can calculate a vector  $b$  from

$$b^T = -c^T A^{-1} . \quad (4.24)$$

Now, the constant  $\alpha$  is calculated from (4.21) and the constant  $\beta$  is calculated from

$$\beta = \min \{ |a_{jj}| - b_j^{-1} \sum_{\substack{i=1 \\ i \neq j}}^s b_i a_{ij} \} \quad (4.25)$$



which is equivalent to (4.14).

Let us consider again the specific example of Section 3. First, to conclude global exponential stability of the system, we verify that the aggregate matrix

$$A = \begin{bmatrix} -0.14 & 0.11 \\ 0.11 & -0.14 \end{bmatrix} \quad (4.26)$$

of (3.21) satisfies conditions (4.7).

By choosing

$$c^T = [1 \quad 1] , \quad (4.27)$$

and using (4.24), we calculate

$$b^T = -33.4 [1 \quad 1] . \quad (4.28)$$

With this  $b$ , we compute  $\alpha$  and  $\beta$  from (4.21) and (4.25) as

$$\alpha = 2.30 , \quad \beta = 0.03 . \quad (4.29)$$

PART II

APPLICATIONS

## 5. SKYLAB MODEL

The Skylab [ 1 ] as an earth-orbiting manned space station, which is designed for prolonged space flights, may be required to provide artificial gravity environment. Therefore, Marshall Space Flight Center of NASA initiated the feasibility of spinning the Skylab about a principal axis of intermediate moment of inertia and producing the artificial gravity effect [ 1 ]. Since such spin cannot be achieved without stabilization, it was hoped that passive stability could be established by deploying masses either on cables or extendable booms as shown on Fig. 5.1. Such configuration has the principal axis of maximum moment of inertia pointing (in the same direction as the solar panels) to the sun.

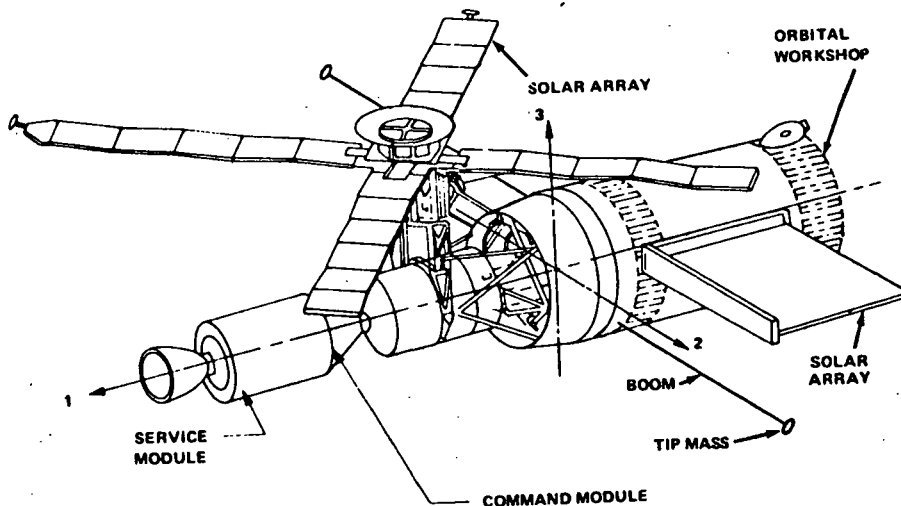

Fig. 5.1

A simplified model [ 1 ] of the spinning Skylab consists of a core mass with two tip masses connected to it by flexible massless beams lying in two different planes as shown on Fig. 5.2.

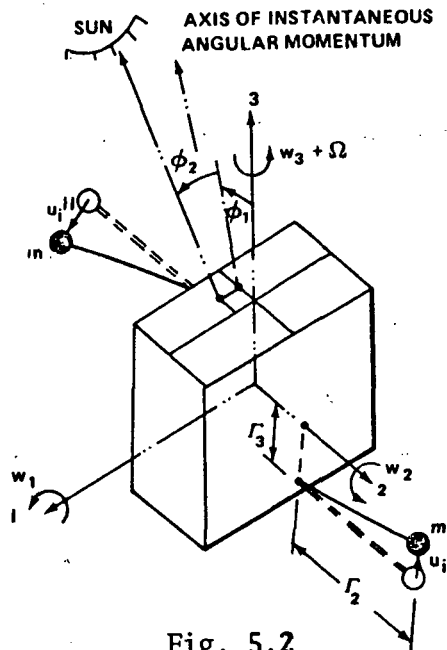

Fig. 5.2

The angular velocity vector of the vehicle may be written in body-fixed coordinates 1, 2, 3, as

$$[w_1 \quad w_2 \quad w_3 + \Omega]^T, \quad (5.1)$$

where  $|w_i| \ll 1$  ( $i = 1, 2, 3$ ) represent small perturbations about the steady state velocity  $\Omega$ . Small displacements of the two tip masses  $m$  from the steady state are denoted by  $u_i^k$  ( $i = 1, 2, 3; k = 1, 2$ ). The rotational dynamics of the Skylab may be represented by a set of nine differential equations written in terms of  $w_i$  and  $u_i^k$ . It is possible to reduce the set of nine equations to six equations by using the substitution

$$u_i = u_i^1 - u_i^2 \quad (5.2)$$

where  $u_i$  now represents the skew symmetric mode of the elastic deformation

and hence causes angular motion about the vehicle's steady-state attitude.

Since stability of rotational motion will be of interest, only the skew symmetric mode is considered.

The linearized equations of motion are

$$\text{wobble motion} \left\{ \begin{array}{l} I_1 \dot{w}_1 + (I_3 - I_2) \Omega w_2 + m \Gamma_2 (\ddot{u}_3 + \Omega^2 u_3) \\ - m \Gamma_3 (2 \Omega \dot{u}_1 + \ddot{u}_2 - \Omega^2 u_2) = T_1 \\ (I_1 - I_3) \Omega w_1 + I_2 \dot{w}_2 + m \Gamma_3 (\ddot{u}_1 - \Omega^2 u_1 - 2 \Omega \dot{u}_2) = T_2 \\ 2 m \Gamma_2 (\dot{w}_1 + \Omega w_2) + m \ddot{u}_3 + d_3 \dot{u}_3 + (k_3 + m \Omega^2) u_3 = 0 \end{array} \right. \quad (5.3)$$

$$\text{spin motion} \left\{ \begin{array}{l} I_3 \dot{w}_3 - m \Gamma_2 (\ddot{u}_1 - 2 \Omega \dot{u}_2) = T_3 \\ 2 m \Gamma_3 (\Omega w_1 + \dot{w}_2) - 2 m \Gamma_2 \dot{w}_3 + m \ddot{u}_1 \\ + d_1 \dot{u}_1 + k_1 u_1 - 2 m \Omega \dot{u}_2 = 0 \\ 2 m \Gamma_3 (-\dot{w}_1 + \Omega w_2) - 4 m \Gamma_2 \Omega w_3 + 2 m \Omega \dot{u}_1 + m \ddot{u}_2 \\ + d_2 \dot{u}_2 + (k_2 - m \Omega^2) u_2 = 0, \end{array} \right. \quad (5.4)$$

where:  $I_1, I_2, I_3$  are the principal moments of inertia in the steady state ( $I_1 < I_2 < I_3$ );  $k_i$  are the stiffness coefficients of the nonrotating booms;  $m \Omega^2$  is the geometric stiffness introduced by spin (the overall boom stiffness in the 1, 2, 3 directions is, therefore,  $k_1 + m \Omega^2, k_2, k_3 + m \Omega^2$ , respectively);  $d_i$  ( $i = 1, 2, 3$ ) are damping coefficients relating the structural damping to elastic deformation velocities;  $\Gamma_i, -\Gamma_i$  ( $i = 1, 2, 3$ ) are the coordinates of the two tip masses at the equilibrium, respectively; and  $T_i$  ( $i = 1, 2, 3$ ) are the applied torques about the body-fixed axes.

Stability analysis of the Skylab model (5.3) will be performed separately for two controls, namely, *passive control* when all the torques are identically zero  $T_i \equiv 0$  ( $i = 1, 2, 3$ ), and *active control*, when the torques are linear functions of the states of the Skylab.

In stability analysis, the following Nomenclature and Physical Characteristics of the Skylab are used:

Nomenclature

$I_1, I_2, I_3$	= principal moment of inertia of body about $i$ coordinate $I_1^* + 2m\Gamma_2^2, I_2^*, I_3^* + 2m\Gamma_2^2$ , respectively
$I_i^*$	= principal moment of inertia of rigid core body about $i$ body - fixed coordinate
$k_i$	= stiffness coefficient characterizing nonrotating boom stiffness
$m$	= tip mass of boom
$T_i$	= applied torque about $i$ coordinate
$t$	= time
$\dot{(\ )} = d/dt$	= differentiation with respect to real time $t$
$u_i = u_i^1 - u_i^2$	= skew symmetric mode of elastic deformations
$u_i^m$	= displacement of $m$ tip mass from spinning steady state in $i$ direction ( $m = 1, 2$ )
$w_i$	= perturbation (about spinning steady state) velocity about $i$ coordinate

$\Gamma_2$	= steady-state boom dimension in 2-axis direction from center of mass to tip mass
$\Gamma_3$	= the asymmetry in the setting of the booms
$K_1, K_2$	= ratios of inertia $(I_2 - I_3)/I_1$ and $(I_3 - I_1)/I_2$ respectively
$\alpha = \frac{1 + K_1}{1 - K_2} = \frac{I_2}{I_1}$	= ratio of inertia $\frac{I_2}{I_1}$
$\gamma = 2m\Gamma_2^2/I_1$	= dimensionless inertia ratio
$\Delta_i = d_i/m\Omega$	= dimensionless damping ratio
$\mu_i = u_i/2\Gamma_2$	= general skew symmetric coordinate
$\sigma_i^2 = k_i/m\Omega^2$	= dimensionless natural frequency coefficient of boom
$\xi = \frac{\Gamma_3}{\Gamma_2}$	= dimensionless length ratio
$\tau = \Omega t$	= dimensionless time
$\Omega$	= steady-state spin rate about 3 axis
$\nu_i = \frac{w_i}{\Omega}$	= dimensionless wobble ratio ( $i = 1, 2, 3$ )
$(\dot{\quad}) = d/d\tau$	= differentiation with respect to $\tau$
subscript $i$	= index referring to three body-fixed coordinates ( $i = 1, 2, 3$ )

$$\gamma_3 = 2mr_2^2/I_3 = \text{dimensionless inertia ratio}$$

$$\beta = \frac{I_3}{I_1} = \text{dimensionless inertia ratio}$$

### Physical Characteristics

$$I_1 = 1.25 \times 10^6 \text{ kg m}^2$$

$$I_2 = 6.90 \times 10^6 \text{ kg m}^2$$

$$I_3 = 7.10 \times 10^6 \text{ kg m}^2$$

$$\Gamma_1 = 0$$

$$\Gamma_2 = 23.3\text{m}$$

$$\Gamma_3 = -1.53\text{m}$$

$$m = 227 \text{ kg}$$

$$k_1 = k_3 = 146 \text{ N/m}$$

$$k_2 = 7.4 \times 10^4 \text{ N/m}$$

$$d_1 = d_3 = 0.04 (k_3 m)^{1/2}$$

$$d_2 = 0.04 (k_2 m)^{1/2}$$

$$\Omega = 0.6\text{s}^{-1}$$



## 6. PASSIVE CONTROL

By adding the extendable booms with tip masses to the Skylab (Fig. 5.1), the spinning vehicle meets the condition

$$I_1 < I_2 < I_3, \quad (6.1)$$

and can be stably spun about the 3-axis. It is of interest in this section, to study the stability properties of the system model (5.3) when the active control is not present, that is,

$$T_i \equiv 0, \quad i = 1, 2, 3. \quad (6.2)$$

In addition, the spin velocity and its perturbation  $w_3$  are controlled separately and are not considered here. Consequently, we assume that

$$w_3 \equiv \dot{w}_3 \equiv 0. \quad (6.3)$$

With assumptions (6.2) and (6.3), the "passive model" is obtained from (5.3) as

$$\text{wobble motion} \left\{ \begin{array}{l} I_1 \dot{w}_1 + (I_3 - I_2) \Omega w_2 + m\Gamma_2 (\ddot{u}_3 + \Omega^2 u_3) \\ -m\Gamma_3 (2\Omega \dot{u}_1 + \ddot{u}_2 - \Omega^2 u_2) = 0 \\ (I_1 - I_3) \Omega w_1 + I_2 \dot{w}_2 + m\Gamma_3 (\ddot{u}_1 - \Omega^2 u_1 - 2\Omega \dot{u}_2) = 0 \\ 2m\Gamma_2 (\dot{w}_1 + \Omega w_2) + m\ddot{u}_3 + d_3 \dot{u}_3 + (k_3 + m\Omega^2) u_3 = 0 \end{array} \right. \quad (6.4)$$

$$\text{spin motion} \left\{ \begin{array}{l} 2m\Gamma_3 (\Omega w_1 + \dot{w}_2) + m\ddot{u}_1 \\ + d_1 \dot{u}_1 + k_1 u_1 - 2m\Omega \dot{u}_2 = 0 \\ 2m\Gamma_3 (-\dot{w}_1 + \Omega w_2) + 2m\Omega \dot{u}_1 + m\ddot{u}_2 \\ + d_2 \dot{u}_2 + (k_2 - m\Omega^2) u_2 = 0, \end{array} \right. \quad (6.5)$$

An important feature of equations (5.3-4) and (6.4-5) is that when  $\Gamma_3 = 0$ , they become uncoupled into two sets of equations: the wobble motion ( $w_1, w_2, u_3$ ) described by (5.3) or (6.4); and spin motion ( $w_3, u_1, u_2$ ) described by (5.4) or (6.5). This suggests that the influence of the asymmetry in the arrangements of the booms ( $\Gamma_3 \neq 0$ ) can be treated as the coupling parameter between the two motions. In the decomposition-aggregation analysis, each motion represents a subsystem.

Passive control equations (6.4-5) can be rewritten as follows:

$$\begin{aligned} v_1' - K_1 v_2 + \gamma(\mu_3'' + \mu_3) - \xi\gamma(2\mu_1' + \mu_2'' - \mu_2) &= 0 \\ -K_2 \alpha v_1 + \alpha v_2' + \xi\gamma(\mu_1'' - \mu_1 - 2\mu_2') &= 0 \\ v_1' + v_2 + \mu_3'' + \Delta_3 \mu_3' + (\sigma_3^2 + 1) \mu_3 &= 0 \end{aligned} \quad (6.6)$$

$$\begin{aligned} \xi(v_1 + v_2') + \mu_1'' + \Delta_1 \mu_1' + \sigma_1^2 \mu_1 - 2\mu_2' &= 0 \\ \xi(-v_1' + v_2) + 2\mu_1' + \mu_2'' + \Delta_2 2\mu_2' + (\sigma_2^2 - 1) \mu_2 &= 0, \end{aligned} \quad (6.7)$$

where the notation is introduced as in the Nomenclature. The dimensionless parameter  $\xi = \Gamma_3/\Gamma_2$  is the coupling parameter between the two sets of equations (6.6) and (6.7).

The state space representation of the over-all system  $S$  described by (6.6-7), is obtained as

$$S: \dot{x}'(\tau) = P x(\tau), \quad (6.8)$$

where the state 8-vector  $x(\tau)$  is chosen as

$$x(\tau) = (v_1 \ v_2 \ \mu_3 \ \mu_3' \ \mu_1 \ \mu_1' \ \mu_2 \ \mu_2')^T, \quad (6.9)$$

and the  $8 \times 8$  matrix  $P$  is given in Fig. 6.1.

In order to obtain the state equations (6.8), it is necessary to write equations (6.6-7) in the vector form

$$Bx'(\tau) + Cx(\tau) = 0 \quad (6.10)$$

where  $x(\tau)$  is the state vector (6.9), and the  $8 \times 8$  matrices  $B$  and  $C$  are given by

$$B = \begin{bmatrix} 1 & 0 & 0 & \gamma & 0 & 0 & 0 & -\xi\gamma \\ 0 & \alpha & 0 & 0 & 0 & \xi\gamma & 0 & 0 \\ 0 & 0 & 1 & 0 & 0 & 0 & 0 & 0 \\ 1 & 0 & 0 & 1 & 0 & 0 & 0 & 0 \\ 0 & 0 & 0 & 0 & 1 & 0 & 0 & 0 \\ 0 & \xi & 0 & 0 & 0 & 1 & 0 & 0 \\ 0 & 0 & 0 & 0 & 0 & 0 & 1 & 0 \\ 0 & 0 & 0 & 0 & 0 & 0 & 0 & 1 \end{bmatrix}$$

$$C = \begin{bmatrix} 0 & -K_1 & \gamma & 0 & 0 & -2\xi\gamma & \xi\gamma & 0 \\ -K_2 & 0 & 0 & 0 & -\xi\gamma & 0 & 0 & -2\xi\gamma \\ 0 & 0 & 0 & -1 & 0 & 0 & 0 & 0 \\ 0 & 1 & \sigma_3^2+1 & \Delta_3 & 0 & 0 & 0 & 0 \\ 0 & 0 & 0 & 0 & 0 & -1 & 0 & 0 \\ \xi & 0 & 0 & 0 & \sigma_1^2 & \Delta_1 & 0 & -2 \\ 0 & 0 & 0 & 0 & 0 & 0 & 0 & -1 \\ -\xi & \xi & 0 & 0 & 0 & 2 & \sigma_2^2-1 & \Delta_2 \end{bmatrix} \quad (6.11)$$

The matrix  $P$  of (6.8) and Fig. 6.1 is obtained from (6.10) as

$$P = -B^{-1}C \quad (6.12)$$

The system  $S$  of equation (6.8) can be decomposed into two interconnected

$$\begin{bmatrix} v_1 \\ v_2 \\ v_3 \\ v_3' \\ v_1 \\ v_1' \\ v_2 \\ v_2' \end{bmatrix} = \begin{bmatrix} 0 & \frac{K_1 \gamma}{1-\gamma} + \frac{\xi^2 \gamma (2\gamma + K_1 - 1)}{(1-\gamma)(1-\gamma-\xi\gamma)} & \frac{\gamma \sigma_3^2}{1-\gamma} + \frac{\xi^2 \gamma \sigma_3^2}{(1-\gamma)(1-\gamma-\xi\gamma)} & \frac{\Delta_3 \gamma}{1-\gamma} + \frac{\xi^2 \gamma \Delta_3}{(1-\gamma)(1-\gamma-\xi\gamma)} & 0 & \frac{2\xi\gamma}{1-\gamma-\xi\gamma} & -\frac{\xi\gamma}{1-\gamma-\xi\gamma} & 0 \\ \xi^2 \gamma \frac{(K_2+1)}{\alpha-\xi\gamma} & 0 & 0 & 0 & \frac{\xi\gamma(\sigma_1^2+1)}{\alpha-\xi\gamma} & \frac{\xi\gamma\delta_1}{\alpha-\xi\gamma} & 0 & 0 \\ 0 & 0 & 0 & 1 & 0 & 0 & 0 & 0 \\ 0 & -\frac{1+K_1}{1-\gamma} \frac{\xi^2 \gamma (2\gamma + K_1 - 1)}{(1-\gamma)(1-\gamma-\xi\gamma)} & -\frac{\sigma_3^2 + 1 - \gamma}{1-\gamma} \frac{\xi^2 \gamma \sigma_3^2}{(1-\gamma)(1-\gamma-\xi\gamma)} & \frac{\Delta_3}{1-\gamma} \frac{\xi^2 \gamma \Delta_3}{(1-\gamma)(1-\gamma-\xi\gamma)} & 0 & -\frac{2\xi\gamma}{1-\gamma-\xi\gamma} & -\frac{\xi\gamma}{1-\gamma-\xi\gamma} & 0 \\ 0 & 0 & 0 & 0 & 0 & 1 & 0 & 0 \\ \frac{\xi\alpha(1+K_2)}{\alpha-\xi\gamma} & 0 & 0 & 0 & -\sigma_1^2 - \frac{\xi^2 \gamma (\sigma_1^2 + 1)}{\alpha-\xi\gamma} & -\delta_1 - \frac{\xi^2 \gamma \delta_1}{\alpha-\xi\gamma} & 0 & 2 \\ 0 & 0 & 0 & 0 & 0 & 0 & 0 & 1 \\ 0 & \frac{\xi\gamma(2\gamma + K_1 - 1)}{1-\gamma-\xi\gamma} & \frac{\xi\gamma \sigma_3^2}{1-\gamma-\xi\gamma} & \frac{\xi\gamma \delta_3}{1-\gamma-\xi\gamma} & 0 & -2 + \frac{2\xi^2 \gamma}{1-\gamma-\xi\gamma} & -(\sigma_2^2 - 1) \frac{\xi^2 \gamma}{1-\gamma-\xi\gamma} & -\delta_2 \end{bmatrix}$$

Fig. 6.1

subsystems described by

$$\begin{array}{l} \text{wobble} \\ \text{motion} \end{array} \quad S_1: \dot{x}_1(\tau) = P_1 x_1(\tau) + \xi^2 Q_{11}(\xi) x_1(\tau) + \xi Q_{12}(\xi) x_2(\tau) \quad (6.13)$$

$$\begin{array}{l} \text{spin} \\ \text{motion} \end{array} \quad S_2: \dot{x}_2(\tau) = P_2 x_2(\tau) + \xi Q_{21}(\xi) x_1(\tau) + \xi^2 Q_{22}(\xi) x_2(\tau) \quad (6.14)$$

where the state vectors  $x(\tau)$ ,  $x_1(\tau)$ ,  $x_2(\tau)$  of the system  $S$  and the two subsystems  $S_1$  and  $S_2$  are

$$x(\tau) = \begin{bmatrix} x_1(\tau) \\ x_2(\tau) \end{bmatrix}; \quad \begin{array}{l} x_1(\tau) = (v_1 \ v_2 \ \mu_3 \ \mu_3')^T \\ x_2(\tau) = (\mu_1 \ \mu_1' \ \mu_2 \ \mu_2')^T \end{array}, \quad (6.15)$$

In (6.13-14), the  $4 \times 4$  matrices  $P_1$  and  $P_2$  correspond to the subsystems  $S_1$  and  $S_2$ , and the  $4 \times 4$  matrices  $Q_{11}(\xi)$ ,  $Q_{12}(\xi)$ ,  $Q_{22}(\xi)$ ,  $Q_{21}(\xi)$  represent the interconnections between the two subsystems:

$$P_1 = \begin{bmatrix} 0 & p_{12}^1 & p_{13}^1 & p_{14}^1 \\ p_{21}^1 & 0 & 0 & 0 \\ 0 & 0 & 0 & 1 \\ 0 & p_{42}^1 & p_{43}^1 & p_{44}^1 \end{bmatrix} \quad \begin{array}{l} p_{12}^1 = -p_{42}^1 = (K_1 + \gamma)/(1 - \gamma) \\ p_{13}^1 = \gamma \sigma_3^2/(1 - \gamma) \\ p_{14}^1 = \Delta_3 \gamma/(1 - \gamma) \\ p_{21}^1 = K_2 \\ p_{43}^1 = -(\sigma_3^2 + 1 - \gamma)/(1 - \gamma) \\ p_{44}^1 = -\Delta_3/(1 - \gamma) \end{array}$$

$$P_2 = \begin{bmatrix} 0 & 1 & 0 & 0 \\ p_{21}^2 & p_{22}^2 & 0 & p_{24}^2 \\ 0 & 0 & 0 & 1 \\ 0 & p_{42}^2 & p_{43}^2 & p_{44}^2 \end{bmatrix} \quad \begin{array}{l} p_{21}^2 = -\sigma_1^2 \\ p_{22}^2 = -\Delta_1 \\ p_{24}^2 = 2 \\ p_{42}^2 = -2 \\ p_{43}^2 = -(\sigma_2^2 - 1) \\ p_{44}^2 = -\Delta_2 \end{array}$$

$$Q_{11}(\xi) = \begin{bmatrix} 0 & q_{12}^{11} & q_{13}^{11} & q_{14}^{11} \\ q_{21}^{11} & 0 & 0 & 0 \\ 0 & 0 & 0 & 0 \\ 0 & q_{42}^{11} & q_{43}^{11} & q_{44}^{11} \end{bmatrix}$$

$$q_{12}^{11} = -q_{42}^{11} = \frac{(2\gamma + K_1 - 1)}{(1-\gamma)(1-\gamma-\xi^2\gamma)}$$

$$q_{13}^{11} = -q_{43}^{11} = \frac{\gamma^2 \sigma_3^2}{(1-\gamma)(1-\gamma-\xi^2\gamma)}$$

$$q_{14}^{11} = -q_{44}^{11} = \frac{\gamma^2 \Delta_3}{(1-\gamma)(1-\gamma-\xi^2\gamma)}$$

$$q_{21}^{11} = \frac{(K_2 + 1)}{\alpha - \xi^2\gamma}$$

$$Q_{12}(\xi) = \begin{bmatrix} 0 & q_{12}^{12} & q_{13}^{12} & 0 \\ q_{21}^{12} & q_{22}^{12} & 0 & 0 \\ 0 & 0 & 0 & 0 \\ 0 & q_{12}^{12} & q_{13}^{12} & 0 \end{bmatrix}$$

$$q_{12}^{12} = -q_{42}^{12} = 2\gamma/(1-\gamma-\xi^2\gamma)$$

$$q_{13}^{12} = -q_{43}^{12} = -\gamma/(1-\gamma-\xi^2\gamma)$$

$$q_{21}^{12} = \gamma(\sigma_1^2 + 1)/(\alpha - \xi^2\gamma)$$

$$q_{22}^{12} = \gamma\Delta_1/(\alpha - \xi^2\gamma)$$

$$Q_{22}(\xi) = \begin{bmatrix} 0 & 0 & 0 & 0 \\ q_{21}^{22} & q_{22}^{22} & 0 & 0 \\ 0 & 0 & 0 & 0 \\ 0 & q_{42}^{22} & q_{43}^{22} & 0 \end{bmatrix}$$

$$q_{21}^{22} = -\gamma(\sigma_1^2 + 1)/(\alpha - \xi^2\gamma)$$

$$q_{22}^{22} = -\gamma\Delta_1/(\alpha - \xi^2\gamma)$$

$$q_{42}^{22} = 2\gamma/(1-\gamma-\xi^2\gamma)$$

$$q_{43}^{22} = -\gamma/(1-\gamma-\xi^2\gamma)$$

$$Q_{21}(\xi) = \begin{bmatrix} 0 & 0 & 0 & 0 \\ q_{21}^{21} & 0 & 0 & 0 \\ 0 & 0 & 0 & 0 \\ 0 & q_{42}^{21} & q_{43}^{21} & q_{44}^{21} \end{bmatrix} \quad \begin{aligned} q_{21}^{21} &= - (1 + K_2)\alpha / (\alpha - \xi^2\gamma) \\ q_{42}^{11} &= (2\alpha + K_1 - 1) / (1 - \gamma - \xi^2\gamma) \\ q_{43}^{21} &= \gamma\sigma_3^2 / (1 - \gamma - \xi^2\gamma) \\ q_{44}^{21} &= \gamma\Delta_3 / (1 - \gamma - \xi^2\gamma) \end{aligned} \quad (6.16)$$

In order to extract the subsystem matrices  $P_1$  and  $P_2$  independent of the coupling parameter  $\xi$  and obtain the decomposition of (6.8) into (6.13-6.14) it is necessary to use the following identities:

$$\begin{aligned} \frac{1}{\alpha - \xi^2\gamma} &\equiv \frac{1}{\alpha} + \frac{\xi^2\gamma}{\alpha(\alpha - \xi^2\gamma)} \\ \frac{1}{\gamma - 1 + \xi^2\gamma} &\equiv \frac{1}{\gamma - 1} + \frac{\xi^2\gamma}{(1 - \gamma)(\gamma - 1 + \xi^2\gamma)} \end{aligned} \quad (6.17)$$

The structural configuration of the system  $S$  as composed of the two subsystems  $S_1$  and  $S_2$  and the interconnections between them through the coupling parameter  $\xi$  can then be depicted as in Fig. 2.

It is obvious that the system of Fig. 2 becomes that of Fig. 3 when  $\xi = 0$ .

On the basis of the physical characteristics of the Skylab given in Section 5, the matrices  $Q_{ij}(\xi)$  ( $i, j = 1, 2$ ) of (6.16) can be made independent of  $\xi$  and denoted by  $Q_{ij}$ . That is accomplished by neglecting the term

$$\xi^2\gamma = 8.5 \times 10^{-4} \quad (6.18)$$

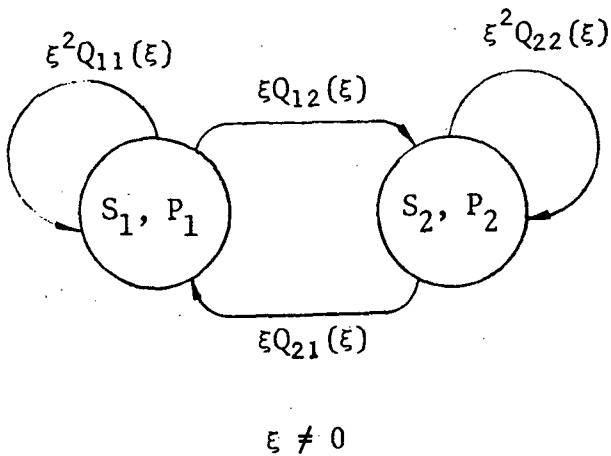

Fig. 6. 2

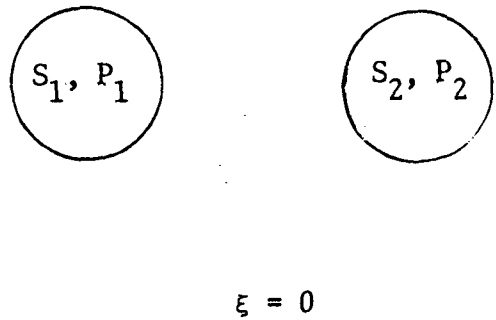

Fig. 6. 3

in (6.16), with respect to the terms

$$1 - \gamma = 0.803 \quad \text{and} \quad \alpha = 5.52 . \quad (6.19)$$

After this simplification, the numbers  $\bar{\xi}_{ij}$  ( $i = 1, 2$ ) of the norm of the coupling matrices  $Q_{ij}$  can be computed using

$$\bar{\xi}_{ij} = [\Lambda(Q_{ij}^T Q_{ij})]^{1/2}, \quad i, j = 1, 2 \quad (6.20)$$

and the aggregation matrix  $A = (a_{ij})$  defined by (3.15), becomes a function of the coupling parameter  $\xi$  only.

The Computer Program given in the Appendix, is used to find:



- a. Subsystem Liapunov functions  $v_i = (x_i^T H x_i)^{1/2}$ ,  $i = 1, 2$ , of (3.4);
- b. Numbers  $\eta_{ij}$ ,  $i = 1, 2$ ;  $j = 1, 2, 3, 4$ , of (3.7);
- c. Numbers  $\tilde{\xi}_{ij}$ ,  $i, j = 1, 2$ , of (6.20);
- d. Aggregation matrix  $A$  of (3.14) as a function of the coupling parameter  $\xi$ ; and
- e. Solution of the stability inequalities (4.7) in terms of the maximum value  $\xi_m$  of  $\xi$ .

Subsystem Liapunov's functions  $v_i$ ,  $i = 1, 2$ , are obtained by solving the Liapunov matrix equations

$$P_i^T H_i + H_i P_i = -G_i, \quad i = 1, 2. \quad (6.21)$$

using the direct method of solution as described in the Appendix.

The choice of the  $4 \times 4$  symmetric matrices  $G_i = I$ ,  $i = 1, 2$ , where  $I$  is the  $4 \times 4$  identity matrix, yields the positive definite  $4 \times 4$  symmetric matrices  $H_i$ ,  $i = 1, 2$ , and establishes global asymptotic stability of the subsystems  $S_i$ ,  $i = 1, 2$ .

Then, to construct the aggregation matrix  $A$ , the following numbers are computed:

$$\lambda(H_1) = 10.0811, \quad \Lambda(H_1) = 5162.7539, \quad \lambda(G_1) = 1$$

$$\lambda(H_2) = 0.4176, \quad \Lambda(H_2) = 436.3635, \quad \lambda(G_2) = 1$$

$$\eta_{11} = 3.1750, \quad \eta_{21} = 0.6462$$

$$\eta_{12} = 71.8523, \quad \eta_{22} = 20.8893$$

$$\begin{aligned}
\eta_{13} &= 0.0069 & \eta_{23} &= 0.0239 \\
\eta_{14} &= 1626.0258 & \eta_{24} &= 675.2502 \\
\varepsilon_{11} &= 0.3646\varepsilon^2 & \varepsilon_{12} &= 0.7766\varepsilon \\
\varepsilon_{21} &= 1.8478\varepsilon & \varepsilon_{22} &= 0.5491\varepsilon^2
\end{aligned} \tag{6.22}$$

Finally, the aggregation matrix  $A$  is obtained as

$$A = \begin{bmatrix} -0.96 \times 10^{-4} + 186.75\varepsilon^2 & 1954.26\varepsilon \\ 392.98\varepsilon & -11.45 \times 10^{-4} + 573.86\varepsilon^2 \end{bmatrix} \tag{6.23}$$

The stability inequalities

$$-0.96 \times 10^{-4} + 186.75\varepsilon^2 < 0$$

$$\begin{vmatrix} -0.96 \times 10^{-4} + 186.75\varepsilon^2 & 1954.26\varepsilon \\ 392.98\varepsilon & -11.45 \times 10^{-4} + 573.86\varepsilon^2 \end{vmatrix} > 0 \tag{6.24}$$

are satisfied for all  $\varepsilon$  such that

$$0 \leq \varepsilon \leq \varepsilon_m = 0.38 \times 10^{-6} \tag{6.25}$$

The obtained range (6.25) of the coupling parameter  $\varepsilon$  is small due to the conservativeness of the stability procedure. However, the estimate  $\varepsilon_m$  could be considerably increased by a proper choice of the matrices  $G_i$ ,  $i = 1, 2$ , in (6.21). A meaningful optimization problem can be formulated as

the maximization of  $\xi_m$  over all matrices  $G_i$ . Future effort should be directed toward a solution of this optimization problem, which can provide important information about the trade-off that exists between the degrees of the subsystem and the over-all system stability.

## 7. ACTIVE CONTROL

A mission requirement of the spinning Skylab is that the 3-axis be pointed at the sun. In order to inertially fix the 3-axis in presence of disturbance torques, attitude control torques must be applied to the vehicle [1, 12]. The control torques depend on error signals that are proportional to the angle between the 3-axis and the solar vector. Sun sensors and rate gyros on the present Skylab can readily provide the control signals  $\phi_1, \phi_2, w_1$  and  $w_2$  shown on Fig. 5.2.

The linear control is postulated [12] as

$$T = \alpha\phi + \beta\omega \quad (7.1)$$

where  $T = [T_1 \ T_2 \ T_3]^T$  is the vector of control torques;  $\phi = [\phi_1 \ \phi_2 \ \phi_3]^T$  is the vector of angular rotations;  $\omega = [w_1 \ w_2 \ w_3 + \Omega]^T$  is the vector of angular velocities;  $\alpha, \beta$  are  $3 \times 3$  matrices

$$\alpha = \begin{bmatrix} \alpha_{11} & \alpha_{12} & 0 \\ \alpha_{21} & \alpha_{22} & 0 \\ 0 & 0 & 0 \end{bmatrix}, \quad \beta = \begin{bmatrix} \beta_{11} & \beta_{12} & 0 \\ \beta_{21} & \beta_{22} & 0 \\ 0 & 0 & \beta_{33} \end{bmatrix}; \quad (7.2)$$

and kinematic relationships are

$$\omega = \begin{bmatrix} -1 & 0 & 0 \\ 0 & -1 & 0 \\ 0 & 0 & -1 \end{bmatrix} \phi + \begin{bmatrix} 0 & \Omega & 0 \\ -\Omega & 0 & 0 \\ 0 & 0 & 0 \end{bmatrix} \phi. \quad (7.3)$$

The control law in this study is chosen as

$$\alpha_{12} = I_1 \Omega^2, \quad \text{all other } \alpha_{ij} = 0$$

$$\beta_{11} = I_1 \Omega \delta, \quad \beta_{33} = -I_1 \Omega \rho, \quad \text{all other } \beta_{ij} = 0 \quad (7.4)$$

so that the normalized control torques  $v = [v_1 \ v_2 \ v_3]^T = [T_1/I_1 \Omega^2 \ T_2/I_1 \Omega^2 \ T_3/I_1 \Omega^2]^T$  are

$$v_1 = (\varepsilon + \delta)\phi_2 - \delta \phi_1'$$

$$v_2 = 0$$

$$v_3 = \rho \phi_3' \quad (7.5)$$

Referring to equations (5.3) and (5.4), the control torque  $T_1$  is used to stabilize the subsystem  $S_1$  (wobble motion), and the torque  $T_3$  is used to stabilize the subsystem  $S_2$  (spin motion).

In (7.5),  $\varepsilon$ ,  $\delta$ ,  $\rho$  are control parameters to be selected in the stabilization process.

Upon introducing these transformations the linearized equations of motion become:

$$\phi_1'' - (1+K_1)\phi_2' - K_1\phi_1 - \gamma(\mu_3'' + \mu_3) + \varepsilon\gamma(2\mu_1' + \mu_2'' - \mu_2) + (\varepsilon + \delta)\phi_2 - \delta\phi_1' = 0$$

wobble motion  $(1+K_1)\phi_1' + K_2\alpha\phi_2 + \alpha\phi_2'' - \varepsilon\gamma(\mu_1'' - \mu_1 - 2\mu_2') = 0$

$$-\phi_1'' - \phi_1 + \mu_3'' + \Delta_3\mu_3' + (\sigma_3^2 + 1)\mu_3 = 0 \quad (7.6)$$

$$\beta\phi_3'' + \gamma(\mu_1'' - 2\mu_2') + \rho\phi_3' = 0$$

spin  
motion

$$-2\xi\phi_1' - \xi\phi_2'' + \phi_3'' + \mu_1'' + \Delta_1\mu_1' + \sigma_1^2\mu_1 - 2\mu_2' + \xi\phi_2 = 0$$

$$\xi\phi_1'' - 2\xi\phi_2' - \xi\phi_1 + 2\phi_3' + 2\mu_1' + \mu_2'' + \Delta_2\mu_2' + (\sigma_2^2 - 1)\mu_2 = 0 \quad (7.7)$$

The state space representation of the overall system  $S$  described by (7.6-7), is obtained using the same method as in the Passive Control case and is:

$$S: \dot{x}(\tau) = P x(\tau) \quad , \quad (7.8)$$

where the state 11-vector  $x(\tau)$  is chosen as

$$x(\tau) = (\phi_1, \phi_2, \mu_3, \phi_1', \phi_2', \mu_3', \phi_3', \mu_1, \mu_1', \mu_2, \mu_2')^T \quad (7.9)$$

and the  $11 \times 11$  matrix  $P$  is given in Fig. 7.1.

The system  $S$  of equation (7.8) can be decomposed into two interconnected subsystems described by:

wobble  
motion

$$S_1: \dot{x}_1(\tau) = P_1 x_1(\tau) + \xi^2 Q_{11}(\xi)x_1(\tau) + \xi Q_{12}(\xi)x_2(\tau) \quad (7.10)$$

spin  
motion

$$S_2: \dot{x}_2(\tau) = P_2 x_2(\tau) + \xi Q_{21}(\xi)x_1(\tau) + \xi^2 Q_{22}(\xi)x_2(\tau) \quad (7.11)$$

$\varphi_1$	0	0	1	0	0	0
$\varphi_2$	0	0	0	0	1	0
$\mu_3$	0	0	0	0	0	1
$\varphi_1$	$\frac{K_1 + \gamma - \varepsilon^2 \gamma}{1 - \gamma - \varepsilon \gamma}$	$-\frac{\varepsilon + \delta}{1 - \gamma - \varepsilon \gamma}$	$-\frac{\gamma \sigma_3^2}{1 - \gamma - \varepsilon \gamma}$	$\frac{\delta}{1 - \gamma - \varepsilon \gamma}$	$\frac{1 + K_1 - 2\varepsilon^2 \gamma}{1 - \gamma - \varepsilon \gamma}$	$-\frac{\gamma \Delta_3}{1 - \gamma - \varepsilon \gamma}$
$\varphi_2$	0	$-\frac{(1 - \gamma_3) K_2 \alpha + \varepsilon^2 \gamma}{\alpha(1 - \gamma_3) - \varepsilon^2 \gamma}$	0	$-\frac{(1 - \gamma_3)(1 + K_1) + 2\varepsilon^2 \gamma}{\alpha(1 - \gamma_3) - \varepsilon^2 \gamma}$	0	0
$\mu_3$	$1 + \frac{K_1 + \gamma - \varepsilon^2 \gamma}{1 - \gamma - \varepsilon \gamma}$	$-\frac{\varepsilon + \delta}{1 - \gamma - \varepsilon \gamma}$	$-(\sigma_3^2 + 1) - \frac{\gamma \sigma_3^2}{1 - \gamma - \varepsilon \gamma}$	$\frac{\delta}{1 - \gamma - \varepsilon \gamma}$	$\frac{1 + K_1 - 2\varepsilon^2 \gamma}{1 - \gamma - \varepsilon \gamma}$	$-\frac{\gamma \Delta_3}{1 - \gamma - \varepsilon \gamma} - \Delta_3$
$\varphi_3$	0	$\frac{\varepsilon \gamma_3 \alpha (K_2 + 1)}{\alpha(1 - \gamma_3) - \varepsilon^2 \gamma}$	0	$-\frac{\varepsilon \gamma_3 (2\alpha - 1 - K_1)}{\alpha(1 - \gamma_3) - \varepsilon^2 \gamma}$	0	0
$\mu_1$	0	0	0	0	0	0
$\mu_1$	0	$-\frac{\varepsilon \alpha (K_2 + 1)}{\alpha(1 - \gamma_3) - \varepsilon^2 \gamma}$	0	$\frac{\varepsilon (2\alpha - 1 - K_1)}{\alpha(1 - \gamma_3) - \varepsilon^2 \gamma}$	0	0
$\mu_2$	0	0	0	0	0	0
$\mu_2$	$\frac{\varepsilon (1 - K_1 - 2\gamma)}{1 - \gamma - \varepsilon \gamma}$	$\frac{\varepsilon (\varepsilon + \delta)}{1 - \gamma - \varepsilon \gamma}$	$\frac{\varepsilon \gamma \sigma_3^2}{1 - \gamma - \varepsilon \gamma}$	$-\frac{\varepsilon \delta}{1 - \gamma - \varepsilon \gamma}$	$\frac{\varepsilon (1 - K_1 - 2\gamma)}{1 - \gamma - \varepsilon \gamma}$	$\frac{\varepsilon \gamma \Delta_3}{1 - \gamma - \varepsilon \gamma}$

Fig. 7. 1

$\psi_1$	0	0	0	0	0	0	0	0	$\frac{2\xi\gamma}{1-\gamma-\xi\gamma}$	$\frac{\xi\gamma\sigma_1^2}{\beta[\alpha(1-\gamma_3)-\xi\gamma]}$	$\frac{\xi\gamma(1-\gamma_3+\sigma_1^2)}{\alpha(1-\gamma_3)-\xi\gamma}$	0	0	0	0	$\frac{2\xi\gamma}{1-\gamma-\xi\gamma}$	$\frac{\xi\gamma\sigma_2^2}{1-\gamma-\xi\gamma}$	$\frac{\xi\gamma\Delta_1}{\alpha(1-\gamma_3)-\xi\gamma}$	0	0	$\frac{\xi\gamma\Delta_2}{1-\gamma-\xi\gamma}$	$\psi_1$
$\psi_2$	0	0	0	0	0	0	0	0	0	0	0	0	0	0	0	0	0	0	0	0	0	$\psi_2$
$\mu_3$	0	0	0	0	0	0	0	0	0	0	0	0	0	0	0	0	0	0	0	0	0	$\mu_3$
$\psi_1$	$\frac{2\xi\gamma}{1-\gamma-\xi\gamma}$	0	0	0	0	0	0	0	0	0	0	0	0	0	0	0	0	0	0	0	0	$\psi_1$
$\psi_2$	$\frac{\xi\gamma\sigma_1^2}{\beta[\alpha(1-\gamma_3)-\xi\gamma]}$	$\frac{\xi\gamma(1-\gamma_3+\sigma_1^2)}{\alpha(1-\gamma_3)-\xi\gamma}$	0	0	0	0	0	0	0	0	0	0	0	0	0	0	0	0	0	0	0	$\psi_2$
$\mu_3$	$\frac{2\xi\gamma}{1-\gamma-\xi\gamma}$	0	0	0	0	0	0	0	0	0	0	0	0	0	0	0	0	0	0	0	0	$\mu_3$
$\psi_3$	$\frac{\alpha\gamma_3}{\beta[\alpha(1-\gamma_3)-\xi\gamma]}$	$\frac{\gamma_3(\sigma_1^2+\xi\gamma)}{\alpha(1-\gamma_3)-\xi\gamma}$	$\frac{\alpha\gamma_3\Delta_1}{\alpha(1-\gamma_3)-\xi\gamma}$	0	0	0	0	0	0	0	0	0	0	0	0	0	0	0	0	0	0	$\psi_3$
$\mu_1$	0	0	0	0	0	0	0	0	0	0	0	0	0	0	0	0	0	0	0	0	0	$\mu_1$
$\mu_1$	$\frac{\alpha\gamma}{\beta[\alpha(1-\gamma_3)-\xi\gamma]}$	$\frac{\sigma_1^2+\xi\gamma}{\alpha(1-\gamma_3)-\xi\gamma}$	$\frac{\alpha\Delta_1}{\alpha(1-\gamma_3)-\xi\gamma}$	0	0	0	0	0	0	0	0	0	0	0	0	0	0	0	0	0	0	$\mu_1$
$\mu_2$	0	0	0	0	0	0	0	0	0	0	0	0	0	0	0	0	0	0	0	0	0	$\mu_2$
$\mu_2$	$\frac{2(1-\gamma)}{1-\gamma-\xi\gamma}$	0	-2	0	0	0	0	0	0	0	0	0	0	0	0	0	0	0	0	0	0	$\mu_2$

Fig. 7. 1



using the same procedure outlined in the previous section.

The state vectors  $x(\tau)$ ,  $x_1(\tau)$ ,  $x_2(\tau)$  of the system  $S$  and two subsystems  $S_1$  and  $S_2$  are

$$x(\tau) = \begin{bmatrix} x_1(\tau) \\ x_2(\tau) \end{bmatrix}; \quad \begin{aligned} x_1(\tau) &= (\phi_1 \ \phi_2 \ \mu_3 \ \phi_1' \ \phi_2' \ \mu_3') \\ x_2(\tau) &= (\phi_3' \ \mu_1' \ \mu_1' \ \mu_2' \ \mu_2') \end{aligned} \quad (7.12)$$

In (7.10-11) the  $6 \times 6$  and  $5 \times 5$  matrices  $P_1, P_2$  correspond to the subsystems  $S_1$  and  $S_2$  and  $6 \times 6, 6 \times 5, 5 \times 6$  and  $5 \times 5$  matrices  $Q_{11}(\xi), Q_{12}(\xi), Q_{21}(\xi), Q_{22}(\xi)$  represent the interconnections between the two subsystems:

$$P_1 = \begin{bmatrix} 0 & 0 & 0 & 1 & 0 & 0 \\ 0 & 0 & 0 & 0 & 1 & 0 \\ 0 & 0 & 0 & 0 & 0 & 1 \\ p_{41}^1 & p_{42}^1 & p_{43}^1 & p_{44}^1 & p_{45}^1 & p_{46}^1 \\ 0 & p_{52}^1 & 0 & p_{54}^1 & 0 & 0 \\ p_{61}^1 & p_{62}^1 & p_{63}^1 & p_{64}^1 & p_{65}^1 & p_{66}^1 \end{bmatrix}$$

$$p_{41}^1 = (K_1 + \gamma) / (1 - \gamma)$$

$$p_{52}^1 = -K_2$$

$$p_{42}^1 = p_{62}^1 = -(\epsilon + \delta) / (1 - \gamma)$$

$$p_{54}^1 = K_2 - 1$$

$$p_{43}^1 = -\gamma \sigma_3^2 / (1 - \gamma)$$

$$p_{61}^1 = (1 + K_1) / (1 - \gamma)$$

$$p_{44}^1 = p_{64}^1 = \delta / (1 - \gamma)$$

$$p_{63}^1 = -(\sigma_3^2 + 1 - \gamma) / (1 - \gamma)$$

$$p_{45}^1 = p_{65}^1 = (1 + K_1) / (1 - \gamma)$$

$$p_{46}^1 = p_{66}^1 = -\gamma \Delta_3 / (1 - \gamma)$$

$$P_2 = \begin{bmatrix} p_{11}^2 & p_{12}^2 & p_{13}^2 & 0 & 0 \\ 0 & 0 & 1 & 0 & 0 \\ p_{31}^2 & p_{32}^2 & p_{33}^2 & 0 & 2 \\ 0 & 0 & 0 & 0 & 1 \\ -2 & 0 & -2 & p_{54}^2 & p_{55}^2 \end{bmatrix}$$

$$p_{11}^2 = -\rho/(\beta-\gamma)$$

$$p_{32}^2 = -\beta\sigma_1^2/(\beta-\gamma)$$

$$p_{12}^2 = \gamma\sigma_1^2/(\beta-\gamma)$$

$$p_{33}^2 = -\beta\Delta_1/(\beta-\gamma)$$

$$p_{13}^2 = \gamma\Delta_1/(\beta-\gamma)$$

$$p_{54}^2 = -(\sigma_2^2-1)$$

$$p_{31}^2 = \rho/(\beta-\gamma)$$

$$p_{55}^2 = -\Delta_2$$

$$Q_{11}(\xi) = \begin{bmatrix} 0 & 0 & 0 & 0 & 0 & 0 \\ 0 & 0 & 0 & 0 & 0 & 0 \\ 0 & 0 & 0 & 0 & 0 & 0 \\ q_{41}^{11} & q_{42}^{11} & q_{43}^{11} & q_{44}^{11} & q_{45}^{11} & q_{46}^{11} \\ 0 & q_{52}^{11} & 0 & q_{54}^{11} & 0 & 0 \\ q_{61}^{11} & q_{62}^{11} & q_{63}^{11} & q_{64}^{11} & q_{65}^{11} & q_{66}^{11} \end{bmatrix}$$

$$q_{41}^{11} = q_{61}^{11} = \frac{\gamma(K_1+2\gamma-1)}{(1-\gamma)(1-\gamma-\xi^2\gamma)}$$

$$q_{45}^{11} = q_{65}^{11} = \frac{(K_1+2\gamma-1)\gamma}{(1-\gamma)(1-\gamma-\xi^2\gamma)}$$

$$q_{42}^{11} = q_{62}^{11} = -\frac{\gamma(\varepsilon+\delta)}{(1-\gamma)(1-\gamma-\xi^2\gamma)}$$

$$q_{46}^{11} = q_{66}^{11} = -\frac{\gamma^2\Delta_3}{(1-\gamma)(1-\gamma-\xi^2\gamma)}$$

$$q_{43}^{11} = q_{63}^{11} = -\frac{\gamma^2 \sigma_3^2}{(1-\gamma)(1-\gamma-\xi^2\gamma)}$$

$$q_{52}^{11} = -\frac{\gamma(K_2+1)}{\alpha(1-\gamma_3)-\xi^2\gamma}$$

$$q_{44}^{11} = q_{54}^{11} = \frac{\gamma\delta}{(1-\gamma)(1-\gamma-\xi^2\gamma)}$$

$$q_{54}^{11} = -\frac{\gamma(3-K_2)}{\alpha(1-\gamma_3)-\xi^2\gamma}$$

$$Q_{12}(\xi) = \begin{bmatrix} 0 & 0 & 0 & 0 & 0 \\ 0 & 0 & 0 & 0 & 0 \\ 0 & 0 & 0 & 0 & 0 \\ q_{41}^{12} & 0 & 0 & q_{44}^{12} & q_{45}^{12} \\ q_{51}^{12} & q_{52}^{12} & q_{53}^{12} & 0 & 0 \\ q_{61}^{12} & 0 & 0 & q_{64}^{12} & q_{65}^{12} \end{bmatrix}$$

$$q_{41}^{12} = q_{61}^{12} = \frac{2\gamma}{1-\gamma-\xi^2\gamma}$$

$$q_{51}^{12} = \frac{\gamma_3^0}{\alpha(1-\gamma_3)-\xi^2\gamma}$$

$$q_{44}^{12} = q_{64}^{12} = \frac{\gamma\sigma_2^2}{1-\gamma-\xi^2\gamma}$$

$$q_{52}^{12} = -\frac{\gamma(1-\gamma_3+\sigma_1^2)}{\alpha(1-\gamma_3)-\xi^2\gamma}$$

$$q_{45}^{12} = q_{65}^{12} = \frac{\gamma\Delta_2}{1-\gamma-\xi^2\gamma}$$

$$q_{53}^{12} = -\frac{\gamma\Delta_1}{\alpha(1-\gamma_3)-\xi^2\gamma}$$

$$Q_{22}(\xi) = \begin{bmatrix} q_{11}^{22} & q_{12}^{22} & q_{13}^{22} & 0 & 0 \\ 0 & 0 & 0 & 0 & 0 \\ q_{31}^{22} & q_{32}^{22} & q_{33}^{22} & 0 & 0 \\ 0 & 0 & 0 & 0 & 0 \\ q_{51}^{22} & 0 & 0 & q_{54}^{22} & q_{55}^{22} \end{bmatrix}$$

$$q_{11}^{22} = - \frac{\rho\gamma_3^2}{(1-\gamma_3)[\alpha(1-\gamma_3)-\xi^2\gamma]}$$

$$q_{12}^{22} = \frac{\gamma\gamma_3(\sigma_1^2+1-\gamma_3)}{(1-\gamma_3)[\alpha(1-\gamma_3)-\xi^2\gamma]}$$

$$q_{13}^{22} = \frac{\gamma\gamma_3\Delta_1}{(1-\gamma_3)[\alpha(1-\gamma_3)-\xi^2\gamma]}$$

$$q_{31}^{22} = \frac{\rho\gamma}{\beta(1-\gamma_3)[\alpha(1-\gamma_3)-\xi^2\gamma]}$$

$$q_{32}^{22} = \frac{\gamma(\sigma_1^2+1-\gamma_3)}{(1-\gamma_3)[\alpha(1-\gamma_3)-\xi^2\gamma]}$$

$$q_{33}^{22} = - \frac{\gamma\Delta_1}{(1-\gamma_3)[\alpha(1-\gamma_3)-\xi^2\gamma]}$$

$$q_{51}^{22} = - \frac{2\gamma}{1-\gamma-\xi^2\gamma}$$

$$q_{54}^{22} = - \frac{\gamma\sigma_2^2}{(1-\gamma-\xi^2\gamma)}$$

$$q_{55}^{22} = - \frac{\gamma\Delta_2}{1-\gamma-\xi^2\gamma}$$

$$Q_{21}(\xi) = \begin{bmatrix} 0 & q_{12}^{21} & 0 & q_{14}^{21} & 0 & 0 \\ 0 & 0 & 0 & 0 & 0 & 0 \\ 0 & q_{32}^{21} & 0 & q_{34}^{21} & 0 & 0 \\ 0 & 0 & 0 & 0 & 0 & 0 \\ q_{51}^{21} & q_{52}^{21} & q_{53}^{21} & q_{54}^{21} & q_{55}^{21} & q_{56}^{21} \end{bmatrix}$$

$$q_{12}^{21} = \frac{\gamma_3\alpha(K_2+1)}{(1-\gamma_3)-\xi^2\gamma}$$

$$q_{14}^{21} = \frac{\gamma_3(2\alpha-1+K_1)}{\alpha(1-\gamma_3)-\xi^2\gamma}$$

$$q_{32}^{21} = \frac{\alpha(K_2+1)}{\alpha(1-\gamma_3)-\xi^2\gamma}$$

$$q_{34}^{21} = \frac{2\alpha-K_1-1}{\alpha(1-\gamma_3)-\xi^2\gamma}$$

$$q_{51}^{21} = \frac{1-K_1-2\gamma}{1-\gamma-\xi^2\gamma}$$

$$q_{52}^{21} = \frac{\xi+\delta}{1-\gamma-\xi^2\gamma}$$

$$q_{53}^{21} = \frac{\gamma\sigma_3^2}{1-\gamma-\xi^2\gamma}$$

$$q_{54}^{21} = - \frac{\delta}{1-\gamma-\xi^2\gamma}$$

$$q_{55}^{21} = \frac{1-K_1-2\gamma}{1-\gamma-\xi^2\gamma}$$

$$q_{56}^{21} = \frac{\gamma\Delta_3}{1-\gamma-\xi^2\gamma}$$

(7.13)

The following identity relationships were used in order to get the subsystem matrices  $P_1$  and  $P_2$  independent of the coupling parameter  $\xi$  :

$$\frac{1}{\alpha(1-\gamma_3)-\xi^2\gamma} \equiv \frac{1}{\alpha(1-\gamma_3)} + \frac{\xi^2\gamma}{\alpha(1-\gamma_3)[\alpha(1-\gamma_3)-\xi^2\gamma]}$$

$$\frac{1}{1-\gamma-\xi^2\gamma} \equiv \frac{1}{1-\gamma} + \frac{\xi^2\gamma}{(1-\gamma)(1-\gamma-\xi^2\gamma)} \quad (7.14)$$

The graphical interpretation of the interconnected subsystems  $S_1$  and  $S_2$  is the same as in Fig. 2 and 3 of the previous section.

Again, on the basis of the physical characteristic of the Skylab given in Section 5, the matrices  $Q_{ij}(\xi)$  ( $i, j = 1, 2$ ) of (7.13) can be made independent of  $\xi$  and denoted by  $Q_{ij}$ . This is obtained by neglecting the term  $\xi^2\gamma = 8.5 \times 10^{-4}$  with respect to the terms

$$1-\gamma = 0.803 \quad \text{and} \quad \alpha(1-\gamma_3) = 5.33 \quad (7.15)$$

Using the following specific values of the control parameters  $\epsilon, \delta, \rho$ :

$$\epsilon = 2.0 \quad \delta = -1.0 \quad \rho = 1.0 \quad (7.16)$$

the same computational algorithm as in the Passive Control case is applied and the computer results are shown in the Appendix.

The choice of the  $6 \times 6$  and  $5 \times 5$  identity matrices for the  $G$  matrices of the first and second subsystem results in  $6 \times 6$  and  $5 \times 5$  positive definite matrices  $H_1, H_2$  and establishes the global asymptotic stability of the subsystems.

In order to construct the aggregation matrix  $A$ , the following numbers are computed:

$$\lambda(H_1) = 0.4947 \quad , \quad \Lambda(H_1) = 44.2273 \quad , \quad \lambda(G_1) = 1$$

$$\lambda(H_2) = 0.4176 \quad , \quad \Lambda(H_2) = 427.5991 \quad , \quad \lambda(G_2) = 1$$

$$\eta_{11} = 0.7034$$

$$\eta_{21} = 0.6462$$

$$\eta_{12} = 6.6503$$

$$\eta_{22} = 20.6784$$

$$\eta_{13} = 0.0751$$

$$\eta_{23} = 0.0241$$

$$\eta_{14} = 62.8749$$

$$\eta_{24} = 661.6879$$

$$\xi_{11} = 0.7897\xi^2$$

$$\xi_{12} = 314.5269\xi$$

$$\xi_{21} = 2.7088\xi$$

$$\xi_{22} = 222.4041\xi^2$$

(7.17)

The aggregation matrix A is obtained as

$$A = \begin{bmatrix} -11.29 \times 10^{-3} + 70.59\xi^2 & 30603.29\xi \\ 2543.19\xi & -1.16 \times 10^{-3} + 227734.68\xi^2 \end{bmatrix}$$

(7.18)

The stability inequalities

$$-11.29 \times 10^{-3} + 70.59\xi^2 < 0$$

$$\begin{vmatrix} -11.29 \times 10^{-3} + 70.59\xi^2 & 30603.29\xi \\ 2543.19\xi & -1.16 \times 10^{-3} + 227734.68\xi^2 \end{vmatrix} > 0$$

(7.19)

are satisfied for all  $\xi$  such that

$$0 \leq \xi \leq \xi_m = 0.41 \times 10^{-6}$$

(7.20)

The obtained interval (7.20) of the coupling parameter  $\xi$  for which the overall system is globally exponentially stable is relatively small due to the following reasons:

1. The inherent conservativeness of the stability analysis;
2. The choice of the matrices  $G_i$ ,  $i = 1, 2$ , is not the "best" regarding the value of  $\xi_m$ ; and
3. The freedom in the choice of the control parameters  $\varepsilon$ ,  $\delta$ ,  $\rho$  is not used to the full extent.

Future research should elaborate on the points 2 and 3 and formulate an optimization problem: Maximization of  $\xi_m$  over the elements of the matrices  $G_i$ ,  $i = 1, 2$ , and the control parameters  $\varepsilon$ ,  $\delta$ ,  $\rho$ . Nonsystematic numerical experimentation with parameter values indicated a possibility of considerable improvements in the value of  $\xi_m$ .

## CONCLUSION

A decomposition-aggregation method is outlined for stability analysis of large-scale dynamic systems. The method takes advantage of special structural features of the complex systems to reduce the memory and computational time requirements when the stability analysis is carried out by machine calculations. By utilizing the system structure in the decomposition procedure, the decomposition-aggregation method makes explicit important structural properties of the system. Furthermore, the method is suitable for accommodation of nonlinearities either in the subsystems or in their interconnections. However, the method is inherently conservative since a series of approximations are involved in establishing the sufficient conditions for stability. Therefore the success of the method should be judged satisfactory to the extent that the conservativeness of the results is outweighed by the computability of the method and the insight that the method provides into the structural properties of complex dynamic systems.

The decomposition-aggregation method is applied to the dynamic model of a spinning Skylab. After the model is decomposed into the wobble and spin subsystems, both the passive and the active control are considered. Such decomposition made an important structural parameter to appear as an interconnection parameter of the two subsystems. Subsequent stability analysis was aimed at estimating the interval of the parameter for global exponential stability. The obtained estimates turned out to be relatively conservative since the flexibility of the decomposition aggregation method was not used to the full extent. Moreover, several physical constraints of the control should have been removed in order to increase the degree of stability of the subsystems and achieve a higher degree of stability on the over-all system level. Since the outlined



decomposition-aggregation analysis is completely computerized, the proposed improvements can be readily incorporated in the present analysis scheme to yield a flexible and powerful method for stability analysis of large-scale linear and nonlinear dynamic systems.

## REFERENCES

1. Seltzer, S. M., J. S. Patel, D. W. Justice, and G. Schweitzer, "Stabilizing a Spinning Skylab", Proc. 5th IFAC Congr., Paris, June 12-17, 1972, pp. 17-2: 1-7.
2. Seltzer, S. M., "Passive Stability of a Spinning Skylab", J. Spacecraft and Rockets, Vol. 9, No. 9, Sept. 1972, pp. 651-655.
3. Šiljak, D. D., "Stability of Large-Scale Systems", Proc. 5th IFAC Congr., Paris, June 12-17, 1972, pp. C-32:1-11.
4. Šiljak, D. D., "Stability of Large-Scale Systems Under Structural Perturbations", IEEE Trans., Vol. SMC-2, No. 5, Nov. 1972, pp. 657-663.
5. Krassovskij, N. N., "Some Problems of the Theory of Stability of Motion" (in Russian), Fizmatgiz, Moscow, 1959. Transl. "Stability of Motion", Stanford Univ. Press, Stanford, Calif., 1963.
6. Fiedler, M., and V. Pták, "On Matrices with Nonpositive Off-Diagonal Elements and Positive Minors", Czech. Math. J., Vol. 12, 1962, pp. 382-400.
7. Chen, C. F., and L. S. Shieh, "A Note on Expanding  $PA + A^T P = -Q$ ", IEEE Trans., Vol. AC-13, No. 1, Feb. 1968, pp. 122-123.
8. Bingulac, S. P., "An Alternate Approach to Expanding  $PA + A^T P = -Q$ ", IEEE Trans., Vol. AC-15, No. 1, Feb. 1970, pp. 135-137.
9. Grujić, Lj. T., and D. D. Šiljak, "Asymptotic Stability and Instability of Large-Scale Systems" (to be published in IEEE Trans. on Auto. Control).
10. Šiljak, D. D., "On Stability of Large-Scale Systems Under Structural Perturbations" (to be published in IEEE Trans. on Systems, Man and Cybernetics).
11. Weissenberger, S., "Stability Regions of Large-Scale Systems" (to be published in Automatica).
12. Seltzer, S. M., G. Schweitzer, B. Asner, Jr., "Attitude Control of a Spinning Skylab", AIAA Guidance Control Conference, paper No. 72-889, Stanford, California, Aug. 14-16, 1972.

APPENDIX

COMPUTER PROGRAMS

## DESCRIPTION OF THE COMPUTER PROGRAM

The program for analyzing the passive stability of the Skylab using decomposition-aggregation method and vector Liapunov functions is realized on the IBM 1130 computer (16 K memory) in FORTRAN language.

In the following description the subroutines: LOC, MSTR, EIGEN, SIMQ and MATA are IBM supplied subroutines (from IBM 1130 Scientific Subroutine Package). Storage compression feature was used for handling the arrays in these subroutines. The three modes of storage are termed general, symmetric, and diagonal. General mode is one in which all elements of the matrix are in storage. Symmetric mode is one in which only the upper triangular portion of the matrix is retained columnwise in sequential locations in storage. (The assumption is made that the corresponding elements in the lower triangle have the same value). Diagonal mode is one in which only the diagonal elements of the matrix are retained in sequential locations in storage. (The off diagonal elements are assumed to be zero). This capability has been implemented using vector storage approach.

The names of the variables in the mainline program were chosen such that they either completely match to the notation throughout the text, or in cases where it was impossible to strongly indicate what was meant (e.g.,  $\eta_{11}$  and ETA 1(1)).

The flowchart, description of the subroutines and the computer programs are included.

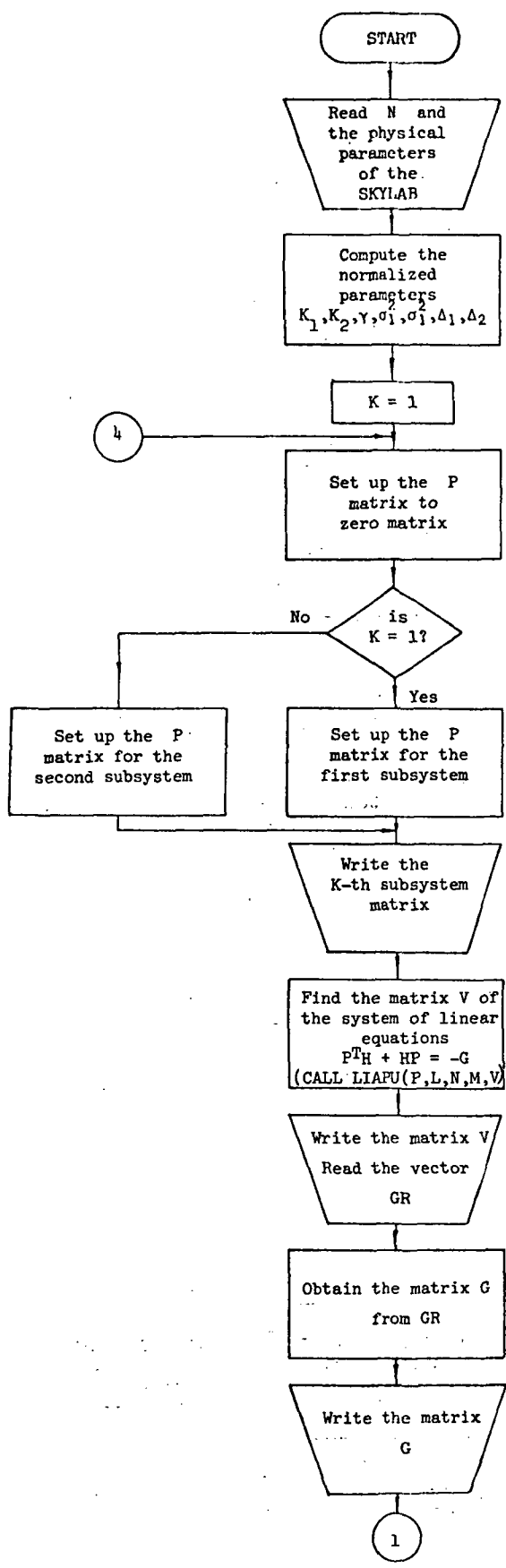

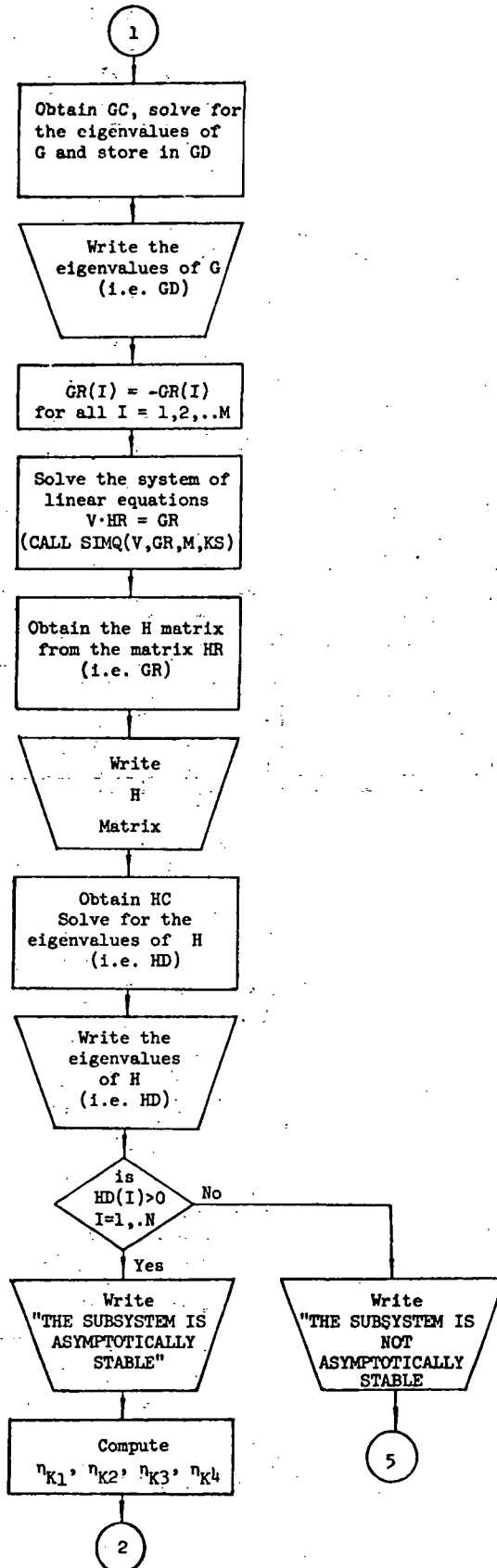

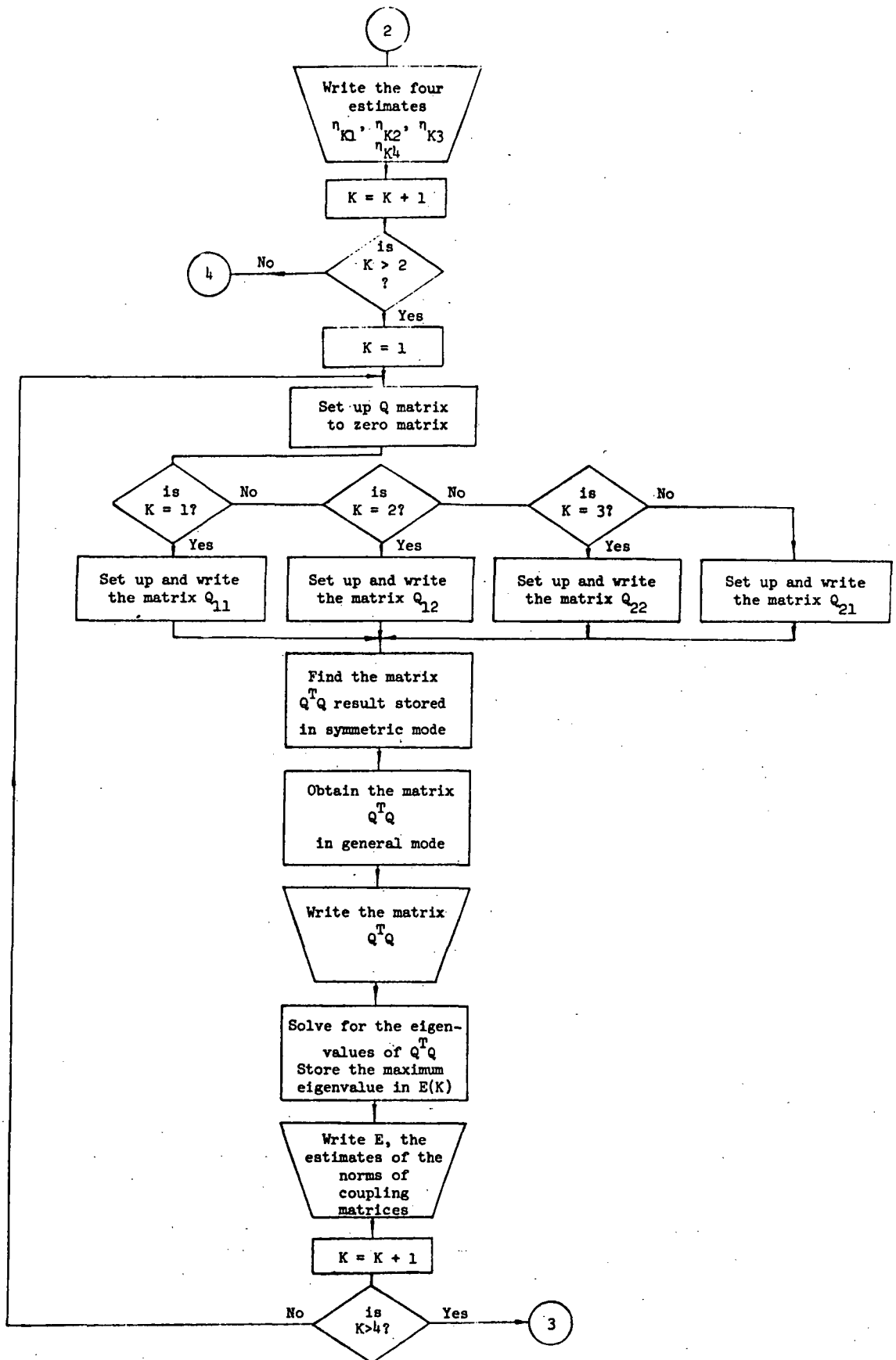

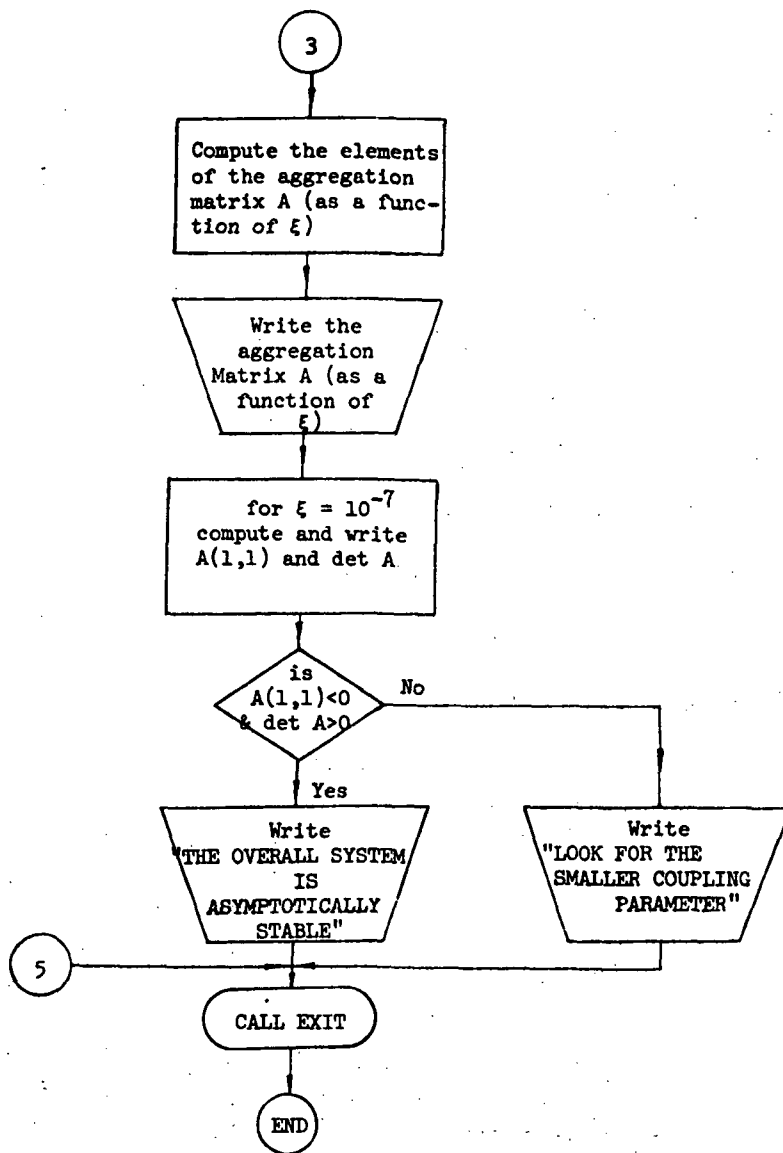



### Subroutine LOC

**Purpose:** Compute a vector subscript for an element in a matrix of specified storage mode.

**Usage:** CALL LOC (I, J, IR, N, M, MS)

#### Description of parameters:

- I - Row number of element
- J - Column number of element
- IR - Resultant vector subscript
- N - Number of rows in matrix
- M - Number of columns in matrix
- MS - One digit number for storage mode of matrix:  
0 - general , 1 - symmetric , 2 - diagonal

#### Method:

- MS = 0 Subscript is computed for a matrix with  $N*M$  elements in storage (general matrix)
- MS = 1 Subscript is computed for a matrix with  $N*(N+1)/2$  in storage (upper triangle of symmetric matrix). If element is in lower triangular portion, subscript is corresponding element in upper triangle.
- MS = 2 Subscript is computed for a matrix with  $N$  elements in storage (diagonal elements of diagonal matrix). If element is not on diagonal (and therefore not in storage) IR is set to zero.

### Subroutine MSTR

**Purpose:** Change storage mode of a matrix

**Usage:** CALL MSTR(A, R, N, MSA, MSR)

#### Description of parameters:

- A - Name of input matrix
- R - Name of output matrix
- N - Number of rows and columns in A and R

MSA - One digit number for storage mode of matrix A

0 - general , 1 - symmetric , 2 - diagonal

Remarks: Matrix R cannot be in the same location as matrix A . Matrix A must be a square matrix.

Subroutine and function subprograms required: LOC

Method: Matrix A is restructured to form matrix R .

MSA	MSR	
0	0	Matrix A is moved to matrix R
0	1	The upper triangle elements of a general matrix are used to form a symmetric matrix
0	2	The diagonal elements of a general matrix are used to form a diagonal matrix
1	0	A symmetric matrix is expanded to form a general matrix
1	1	Matrix A is moved to matrix R
1	2	The diagonal elements of a symmetric matrix are used to form a diagonal matrix
2	0	A diagonal matrix is expanded by inserting missing zero elements to form a general matrix
2	1	A diagonal matrix is expanded by inserting missing zero elements to form a symmetric matrix
2	2	Matrix A is moved to matrix R

#### Subroutine LOCI

The same as subroutine LOC except that the symmetric mode is to be considered one in which only the upper triangular portion of the matrix is retained but *row-wise* in sequential locations in storage.

#### Subroutine MSTR1

The same as subroutine MSTR with the same remark about symmetric mode

### Subroutine EIGEN

**Purpose:** Compute eigenvalues and eigenvectors of a real symmetric matrix

**Usage:** CALL EIGEN (A, R, N, MV)

#### Description of parameters:

- A - Original matrix (symmetric) destroyed in computation. Resultant eigenvalues are developed in diagonal of matrix A in descending order
- R - Resultant matrix of eigenvectors (stored columnwise, in same sequence as eigenvalues)
- N - Order of matrices A and R
- MV - Input code:
  - 0 - Compute eigenvalues and eigenvectors
  - 1 - Compute eigenvalues only (R need not be dimensioned but must still appear in calling sequence)

**Remarks:** Original matrix A must be real symmetric (storage mode = 1). Matrix A cannot be in the same location as matrix R.

**Method:** Diagonalization method originated by Jacobi and adapted by von Neumann for large computers.

### Subroutine SIMQ

**Purpose:** Obtain solution of a set of simultaneous linear equations,  $AX = B$ .

**Usage:** CALL SIMQ (A, B, N, KS)

#### Description of parameters:

- A - Matrix of coefficients stored columnwise. These are destroyed in the computation. Matrix is N by N.
- B - Vector of original constants (length N). These are replaced by final solution values, vector X.
- N - Number of equations and variables. N must be greater than 1.
- KS - Output digit:
  - 0 - For a normal solution
  - 1 - For a singular set of equations

Remarks: Matrix A must be general. If matrix is singular, solution values are meaningless.

Method: Method of solution is by elimination using largest pivotal divisor.

### Subroutine MATA

Purpose: Premultiply a matrix by its transpose to form a symmetric matrix.

Usage: CALL MATA (A, R, N, M, MS)

### Description of parameters:

A - Name of input matrix

R - Name of output matrix

N - Number of rows in A

M - Number of columns in A . Also number of rows and number of columns of R

MS - One digit number for storage mode of matrix A

0 - general , 1 - symmetric , 2 - diagonal

Remarks: Matrix R cannot be in the same location as matrix A . Matrix R is always a symmetric matrix with a storage mode = 1.

Subroutine and function subprogram required: LOC

Method: Calculation of  $(A \text{ transpose } A)$  results in a symmetric matrix regardless of the storage mode of the input matrix. The elements of matrix A are not changed.

### Subroutine LIAPU

Purpose: Expanding the Liapunov matrix equation  $P^T H + H P = -G$  into a system of linear algebraic equations.

Usage: CALL LIAPU (P, L, N, M, V)

### Description of parameters:

P - Name of input matrix

L - Auxiliary matrix consisting of integers and used to construct the matrix V of the corresponding system of linear equations

N - Order of matrices P and L

M - Order of the system of linear equations, that is, order of matrix V. Also equal to  $N(N+1)/2$

V - Name of output matrix of transformed system of linear equations

Remarks: The transformed system of M linear equations is  $V \cdot HR = -GR$ , where:

GR - Vector formed from symmetric matrix G using the upper triangular elements of the matrix G stored *row-wise*

HR - Vector of unknowns formed from unknown symmetric matrix H using the upper triangular elements of H stored *row-wise*

Method: Expansion of the matrix equation  $P^T H + HP = -G$  into  $N*(N+1)/2$  simultaneous equations, using the method developed in [7] and refined in [8]

// JOB T

```
LOG DRIVE    CART SPEC    CART AVAIL    PHY DRIVE
  0000        0001        0001          0000
```

V2 M10 ACTUAL 16K CONFIG 16K

// \*

// \* PASSIVE STABILITY OF THE SPINNING SKYLAB

// \*

// FOR

\*ONE WORD INTEGERS

\*LIST SOURCE PROGRAM

SUBROUTINE LOC1(I,J,IR,N,M,MS)

IX=I

JX=J

IF(MS-1) 10,20,30

10 IRX=N\*(JX-1)+IX

GO TO 36

20 IF(IX-JX) 22,24,24

22 IRX=J+(I-1)\*(2\*N-1)/2

GO TO 36

24 IRX=I+(J-1)\*(2\*N-J)/2

GO TO 36

30 IRX=0

IF(IX-JX) 36,32,36

32 IRX=IX

36 IR=IRX

RETURN

END

FEATURES SUPPORTED

ONE WORD INTEGERS

CORE REQUIREMENTS FOR LOC1

COMMON 0 VARIABLES 6 PROGRAM 130

RELATIVE ENTRY POINT ADDRESS IS 0009 (HEX)

END OF COMPILATION

// DUP

\*STORE WS UA LOC1

CART ID 0001 DB ADDR 501F DB CNT 0009

// EJECT

04/24/73

```
// FOR
*ONE WORD INTEGERS
*LIST SOURCE PROGRAM
  SUBROUTINE MSTR1(A,R,N,MSA,MSR)
  DIMENSION A(1),R(1)
  DO 20 I=1,N
  DO 20 J=1,N
  IF(MSR) 5,10,5
  5 IF(I-J) 10,10,20
  10 CALL LOC1(I,J,IR,N,N,MSR)
  IF(IR) 20,20,15
  15 R(IR)=0.0
  CALL LOC1(I,J,IA,N,N,MSA)
  IF(IA) 20,20,18
  18 R(IR)=A(IA)
  20 CONTINUE
  RETURN
  END
```

FEATURES SUPPORTED  
ONE WORD INTEGERS

CORE REQUIREMENTS FOR MSTR1  
COMMON            0   VARIABLES            6   PROGRAM            110

RELATIVE ENTRY POINT ADDRESS IS 0009 (HEX)

END OF COMPILATION

// DUP

\*STORE            WS   UA   MSTR1  
CART ID 0001    DB ADDR 5028    DB CNT    0008

// EJECT

04/24/73

// FOR

\* LIST SOURCE PROGRAM

\*ONE WORD INTEGERS

```
SUBROUTINE LIAPU(P,L,N,M,V)
DIMENSION L(4,4),P(4,4),V(10,10)
M=N*(N+1)/2
K=0
DO 10 I=1,N
DO 10 J=I,N
K=K+1
L(I,J)=K
10 L(J,I)=K
DO 11 I=1,M
DO 11 J=1,M
11 V(I,J)=0.
DO 12 I=1,N
DO 12 J=1,N
DO 12 K=1,N
II=L(I,K)
IJ=L(J,K)
12 V(II,IJ)=P(J,I)+V(II,IJ)
DO 13 I=1,N
DO 13 J=1,M
IL=L(I,I)
13 V(IL,J)=2.*V(IL,J)
RETURN
END
```

FEATURES SUPPORTED  
ONE WORD INTEGERS

CORE REQUIREMENTS FOR LIAPU

COMMON            0   VARIABLES            10   PROGRAM            280

RELATIVE ENTRY POINT ADDRESS IS 0011 (HEX)

END OF COMPILATION

// DUP

\*STORE            WS   UA   LIAPU  
CART ID 0001      DB ADDR 5030      DB CNT 0012

// EJECT



04/24/73

// FOR

\*\* PASSIVE STABILITY OF THE SPINNING SKYLAB

\*ONE WORD INTEGERS

\*LIST SOURCE PROGRAM

\*IOCS(CARD, 1403 PRINTER

```

REAL I1,I2,I3,MASS,K1,K2
DIMENSION L(4,4),P(4,4),Q(4,4),G(4,4),H(4,4),GC(10),HC(10),GR(10)
DIMENSION V(10,10),GD(4),HD(4),E(4)
DIMENSION ETA1(2),ETA2(2),ETA3(2),ETA4(2),A(2,2)
EQUIVALENCE (P(1,1),Q(1,1),G(1,1),H(1,1)),(GC(1),HC(1))
100 FORMAT(I2)
101 FORMAT(/)
102 FORMAT(//)
103 FORMAT(10F12.4)
C READ N - THE ORDER OF THE SUBSYSTEM
READ(2,100) N
C READ THE PHYSICAL PARAMETERS OF THE SKYLAB
READ(2,50) I1,I2,I3,G2,MASS,EK1,EK2,OMEGA
50 FORMAT(8F10.0)
C COMPUTE THE NORMALIZED PARAMETERS
K1=(I2-I3)/I1
K2=(I3-I1)/I2
ALPHA=(1.0+K1)/(1.0-K2)
GAMA=(2.*MASS*G2*G2)/I1
SIGS1=EK1/(MASS*OMEGA*OMEGA)
SIGS2=EK2/(MASS*OMEGA*OMEGA)
SIGM1=SQRT(SIGS1)
SIGM2=SQRT(SIGS2)
DEL1=0.04*SIGM1
DEL2=0.04*SIGM2
GAMA1=1.0-GAMA
GAMA2=GAMA1*GAMA1
WRITE(5,301)
301 FORMAT('1',10X,'STABILITY ANALYSIS OF LARGE SCALE SYSTEM USING DEC
10 COMPOSITION METHOD AND LIAPUNOV FUNCTIONS',//)
C
C SUBSYSTEM ANALYSIS
C
DO 9 K=1,2
DO 5 I=1,N
DO 5 J=1,N
5 P(I,J)=0.0
IF(K-1) 7,6,7
6 WRITE(5,302)
302 FORMAT(' THE FIRST SUBSYSTEM MATRIX P IS',/)
C COMPUTE THE ELEMENTS OF THE FIRST SUBSYSTEM MATRIX P1
P(1,2)=(K1+GAMA)/GAMA1
P(1,3)=(GAMA*SIGS1)/GAMA1
P(1,4)=(GAMA*DEL1)/GAMA1
P(2,1)=K2
P(3,4)=1.0
P(4,2)=- (K1+1.0)/GAMA1
P(4,3)=(GAMA-SIGS1-1.0)/GAMA1
P(4,4)=-DEL1/GAMA1
GO TO 8
7 WRITE(5,303)
303 FORMAT('1THE SECOND SUBSYSTEM MATRIX P IS',/)
C COMPUTE THE ELEMENTS OF THE SECOND SUBSYSTEM MATRIX P2
P(1,2)=1.0
P(2,1)=-SIGS1
P(2,2)=-DEL1
P(2,4)=2.0
P(3,4)=1.0

```

```

P(4,2)=-2.0
P(4,3)=1.0-SIGS2
P(4,4)=-DEL2
C WRITE THE CORRESPONDING SUBSYSTEM MATRIX
8 DO 16 I=1,N
16 WRITE(5,103) (P(I,J),J=1,N)
WRITE(5,101)
C FROM THE MATRIX P AND THE MATRIX EQUATION PTRANSPOSE*H + H*P = -G
C COMPUTE THE MATRIX V OF THE TRANSFORMED SYSTEM OF LINEAR EQUATIONS
CALL LIAPU(P,L,N,M,V)
WRITE(5,304)
304 FORMAT(' THE MATRIX V OF THE CORRESPONDING SYSTEM OF LINEAR EQUATI
IONS IS')
WRITE(5,101)
C WRITE V MATRIX
DO 14 I=1,M
14 WRITE(5,103) (V(I,J),J=1,M)
WRITE(5,101)
C READ GR - VECTOR CONSISTING OF UPPER TRIANGULAR ELEMENTS
C OF MATRIX G STORED ROWISE
READ(2,104) GR
104 FORMAT(16F5.0)
C OBTAIN THE GENERAL MATRIX G (STORAGE MODE 0)
CALL MSTR1(GR,G,N,1,0)
WRITE(5,109)
109 FORMAT(' THE POSITIVE DEFINITE SYMMETRIC MATRIX G IS',/)
DO 19 I=1,N
19 WRITE(5,103) (G(I,J),J=1,N)
C OBTAIN GC - VECTOR CONSISTING OF THE UPPER TRIANGULAR ELEMENTS
C OF THE MATRIX G STORED COLUMNWISE
CALL MSTR(G,GC,N,0,1)
C SOLVE FOR THE EIGENVALUES OF THE MATRIX G
CALL EIGEN(GC,D,N,1)
C STORE THE EIGENVALUES OF THE MATRIX G IN THE VECTOR GD
CALL MSTR(GC,GD,N,1,2)
WRITE(5,101)
WRITE(5,201)
201 FORMAT(' THE EIGENVALUES OF THE SYMMETRIC MATRIX G ARRANGED IN DEC
REASING ORDER ARE',/)
C WRITE THE EIGENVALUES OF THE MATRIX G
WRITE(5,103) GD
WRITE(5,102)
C SOLVE THE SYSTEM OF LINEAR EQUATIONS V*HR=GR, RESULT IS IN GR
DO 17 I=1,M
17 GR(I)=-GR(I)
CALL SIMQ(V,GR,M,KS)
IF(KS-1) 30,20,30
20 WRITE(5,105)
105 FORMAT(' SINGULAR CASE')
GO TO 15
C FORM GENERAL MATRIX H FROM GR
30 CALL MSTR1(GR,H,N,1,0)
WRITE(5,110)
110 FORMAT(' THE LIAPUNOV MATRIX H FOR THE SUBSYSTEM IS',/)
DO 21 I=1,N
21 WRITE(5,103) (H(I,J),J=1,N)
C OBTAIN HC - VECTOR CONSISTING OF THE UPPER TRIANGULAR ELEMENTS
C OF THE MATRIX H STORED COLUMNWISE

```

```

CALL MSTR(H,HC,N,0,1)
C SOLVE FOR THE EIGENVALUES OF THE MATRIX H
CALL EIGEN(HC,D,N,1)
C STORE THE EIGENVALUES OF H IN HD
CALL MSTR(HC,HD,N,1,2)
WRITE(5,101)
WRITE(5,202)
202 FORMAT(' THE EIGENVALUES OF THE SYMMETRIC MATRIX H ARRANGED IN DEC
1 REASING ORDER ARE',/)
C WRITE THE EIGENVALUES OF THE MATRIX H
WRITE(5,103) HD
WRITE(5,101)
C CHECK IF ALL EIGENVALUES ARE POSITIVE
DO 22 I=1,N
IF(HD(I)) 23,23,24
22 CONTINUE
23 WRITE(5,203)
203 FORMAT(' THE SUBSYSTEM IS NOT ASYMPTOTICALLY STABLE SINCE H MATRIX
1 IS NOT POSITIVE DEFINITE')
GO TO 15
24 WRITE(5,204)
204 FORMAT(' ALL THE EIGENVALUES OF H MATRIX ARE POSITIVE AND THE SUBS
1 YSTEM IS ASYMPTOTICALLY STABLE')
WRITE(5,101)
C COMPUTE THE FOUR ESTIMATES FOR THE SUBSYSTEM
ETA1(K)=SQRT(HD(N))
ETA2(K)=SQRT(HD(1))
ETA3(K)=0.5*GD(N)/ETA2(K)
ETA4(K)=HD(1)/ETA1(K)
WRITE(5,205)
205 FORMAT(' THE FOUR ESTIMATES FOR THE SUBSYSTEM ARE',/)
WRITE(5,103) ETA1(K),ETA2(K),ETA3(K),ETA4(K)
9 CONTINUE
C
C FINDING THE NORMS OF THE COUPLING MATRICES
C
WRITE(5,206)
206 FORMAT('1',10X,'ESTIMATING THE NORMS OF THE INTERCONNECTING MATRIC
1 ES')
WRITE(5,102)
DO 52 K=1,4
DO 42 I=1,N
DO 42 J=1,N
42 Q(I,J)=0.0
IF(K-1) 44,43,44
43 WRITE(5,207)
207 FORMAT (' THE SELF-COUPLING MATRIX Q11 IS',/)
C COMPUTE THE SELF-COUPLING MATRIX Q11
Q(1,2)=GAMA*(2.0*GAMA+K1-1.0)/GAMA2
Q(1,3)=SIGS1*GAMA*GAMA/GAMA2
Q(1,4)=(DEL1*GAMA*GAMA)/GAMA2
Q(2,1)=GAMA*(K2+1.0)/ALPHA
Q(4,2)=-Q(1,2)
Q(4,3)=-Q(1,3)
Q(4,4)=-Q(1,4)
GO TO 49
44 IF(K-2) 46,45,46
45 WRITE(5,208)

```

```

208 FORMAT(//////,' THE INTERCOUPLING MATRIX Q12 IS',/)
C   COMPUTE THE INTER-COUPLING MATRIX Q12
      Q(1,2)=2.0*GAMA/GAMA1
      Q(1,3)=-GAMA/GAMA1
      Q(2,1)=GAMA*(SIGS1+1.0)/ALPHA
      Q(2,2)=GAMA*DEL1/ALPHA
      Q(4,2)=-Q(1,2)
      Q(4,3)=-Q(1,3)
      GO TO 49
46  IF(K-3) 48,47,48
47  WRITE(5,210)
210 FORMAT('1THE SELFCOUPLING MATRIX Q22 IS',/)
C   COMPUTE THE SELF-COUPLING MATRIX Q22
      Q(2,1)=-GAMA*(SIGS1+1.0)/ALPHA
      Q(2,2)=-GAMA*DEL1/ALPHA
      Q(4,2)=2.0*GAMA/GAMA1
      Q(4,3)=-GAMA/GAMA1
      GO TO 49
48  WRITE(5,211)
211 FORMAT(//////,' THE INTERCOUPLING MATRIX Q21 IS',/)
C   COMPUTE THE INTER-COUPLING MATRIX Q21
      Q(2,1)=- (1.0+K2)
      Q(4,2)=(2.0*GAMA+K1-1.0)/GAMA1
      Q(4,3)=GAMA*SIGS1/GAMA1
      Q(4,4)=GAMA*DEL1/GAMA1
C   WRITE THE CORRESPONDING COUPLING MATRIX
49  DO 53 I=1,N
53  WRITE(5,103) (Q(I,J),J=1,N)
C   COMPUTE THE MATRIX QTRANSPOSE*Q
      CALL MATA(Q,GC,N,N,0)
C   GET THE GENERAL STORAGE MODE FOR QTRANSPOSE*Q
      CALL MSTR(GC,Q,N,1,0)
      WRITE(5,101)
      WRITE(5,212)
212 FORMAT(' Q TRANSPOSE Q IS',/)
C   WRITE QTRANSPOSE*Q
      DO 51 I=1,N
51  WRITE(5,103) (Q(I,J),J=1,N)
      WRITE(5,101)
C   COMPUTE THE EIGENVALUES OF QTRANSPOSE*Q
      CALL EIGEN(GC,D,N,1)
C   COMPUTE THE ESTIMATE OF THE NORM OF THE MATRIX Q
      E(K)=SQRT(GC(1))
      WRITE(5,214) E(K)
214 FORMAT (' THE ESTIMATE OF THE NORM OF THE MATRIX IS',F8.4)
52  CONTINUE
C
C   A G G R E G A T I O N
C
      WRITE(5,215)
215 FORMAT('1THE AGGREGATION MATRIX A AS A FUNCTION OF COUPLING PARAME
1TAR ZETA IS',/)
      A11=-ETA3(1)/ETA2(1)
      A1=E(1)*ETA4(1)/ETA1(1)
      A12=E(2)*ETA4(1)/ETA1(2)
      A21=E(4)*ETA4(2)/ETA1(1)
      A22=-ETA3(2)/ETA2(2)
      A2=E(3)*ETA4(2)/ETA1(2)

```

04/24/73

PASSIVE STABILITY OF THE SPINNING SKYLAB

```
WRITE(5,106) A11,A1,A12
106 FORMAT(F12.6,' +',F8.2,'*ZETA*ZETA',20X,F8.2,'*ZETA')
WRITE(5,101)
WRITE(5,107) A21,A22,A2
107 FORMAT(F8.2,'*ZETA',20X,F12.6,' +',F8.2,'*ZETA*ZETA')
ZETA=1.0E-7
A(1,1)=A11+ZETA*ZETA*A1
A(1,2)=A12*ZETA
A(2,1)=A21*ZETA
A(2,2)=A22+ZETA*ZETA*A2
DETA=A(1,1)*A(2,2)-A(1,2)*A(2,1)
WRITE (5,102)
WRITE (5,220) ZETA
220 FORMAT(' THE AGGREGATION MATRIX A FOR ZETA=',E10.4,' IS',//)
DO 60 I=1,2
 60 WRITE(5,221) (A(I,J),J=1,2)
221 FORMAT(E12.4,10X,E12.4,/)
WRITE(5,102)
WRITE(5,222) A(1,1),DETA
222 FORMAT(' A(1,1) IS ',E12.4,' AND DETERMINANT OF A IS ',E10.4,//)
IF(A(1,1)) 61,62,62
 61 IF(DETA) 62,62,64
 64 WRITE(5,223)
223 FORMAT(' THE OVERALL SYSTEM IS ASYMPTOTICALLY STABLE')
GO TO 15
 62 WRITE(5,224)
224 FORMAT(' LOOK FOR SMALLER VALUE OF THE COUPLING PARAMETAR ZETA')
15 CALL EXIT
END
```

FEATURES SUPPORTED  
ONE WORD INTEGERS  
IOCS

CORE REQUIREMENTS FOR  
COMMON 0 VARIABLES 410 PROGRAM 2238

END OF COMPILATION

// XEQ

STABILITY ANALYSIS OF LARGE SCALE SYSTEM USING DECOMPOSITION METHOD AND LIAPUNOV FUNCTIONS

THE FIRST SUBSYSTEM MATRIX P IS

0.0000	0.0463	0.4387	0.0131
0.8478	0.0000	0.0000	0.0000
0.0000	0.0000	1.0000	1.0000
0.0000	-1.0463	-3.2253	-0.0665

THE MATRIX V OF THE CORRESPONDING SYSTEM OF LINEAR EQUATIONS IS

0.0000	1.6956	0.0000	0.0000	0.0000	0.0000	0.0000	0.0000	0.0000	0.0000	0.0000	0.0000	0.0000	0.0000
0.0463	0.0000	0.0000	-1.0463	0.8478	0.0000	0.0000	0.0000	0.0000	0.0000	0.0000	0.0000	0.0000	0.0000
0.4387	0.0000	0.0000	-3.2253	0.0000	0.8478	0.0000	0.0000	0.0000	0.0000	0.0000	0.0000	0.0000	0.0000
0.0131	0.0000	1.0000	-0.0665	0.0000	0.0000	0.0000	0.0000	0.0000	0.0000	0.0000	0.0000	0.0000	0.0000
0.0000	0.0926	0.0000	0.0000	0.0000	0.0000	0.0000	0.0000	-2.0926	0.0000	0.0000	0.0000	0.0000	0.0000
0.0000	0.4387	0.0463	0.0000	0.0000	0.0000	0.0000	0.0000	-0.0665	0.0000	0.0000	0.0000	-1.0463	0.0000
0.0000	0.0131	0.0000	0.0463	0.0000	1.0000	0.0000	0.0000	-3.2253	0.0000	0.0000	0.0000	0.0000	-1.0463
0.0000	0.0000	0.8775	0.0000	0.0000	0.0000	0.0000	0.0000	0.0000	0.0000	0.0000	0.0000	-6.4507	0.0000
0.0000	0.0000	0.0131	0.4387	0.0000	0.0000	0.0000	0.0000	0.0000	0.0000	0.0000	1.0000	-0.0665	0.0000
0.0000	0.0000	0.0000	0.0262	0.0000	0.0000	0.0000	0.0000	0.0000	0.0000	0.0000	0.0000	0.0000	2.0000

THE POSITIVE DEFINITE SYMPEMIC MATRIX G IS

1.0000	0.0000	0.0000	0.0000
0.0000	1.0000	0.0000	0.0000
0.0000	0.0000	1.0000	0.0000
0.0000	0.0000	0.0000	1.0000

THE EIGENVALUES OF THE SYMPEMIC MATRIX G ARRANGED IN DECREASING ORDER ARE

1.0000	1.0000	1.0000	1.0000
--------	--------	--------	--------

THE LIAPUNOV MATRIX H FOR THE SUBSYSTEM IS

5062.8125	-0.5897	-19.5562	710.3724
-0.5897	600.1429	82.1886	0.4517
-19.5562	82.1886	43.0296	-2.5055
710.3724	0.4517	-2.5055	109.9554

THE EIGENVALUES OF THE SYMPEMIC MATRIX H ARRANGED IN DECREASING ORDER ARE

5162.7539	612.0120	31.0852	10.0811
-----------	----------	---------	---------

ALL THE EIGENVALUES OF H MATRIX ARE POSITIVE AND THE SUBSYSTEM IS ASYMPTOTICALLY STABLE

THE FOUR ESTIMATES FOR THE SUBSYSTEM ARE

3.1750	71.8523	0.0069	1626.0258
--------	---------	--------	-----------

THE SECOND SUBSYSTEM MATRIX P IS

0.0000	1.0000	0.0000	0.0000
-1.7865	-0.0534	0.0000	2.0000
0.0000	0.0000	0.0000	1.0000
0.0000	-2.0000	-904.5314	-1.2036

THE MATRIX V OF THE CORRESPONDING SYSTEM OF LINEAR EQUATIONS IS

0.0000	-3.5731	0.0000	0.0000	0.0000	0.0000	0.0000	0.0000
1.0000	-0.0534	0.0000	-2.0000	0.0000	0.0000	0.0000	0.0000
0.0000	0.0000	0.0000	-904.5314	-1.7865	0.0000	0.0000	0.0000
0.0000	2.0000	1.0000	-1.2036	0.0000	0.0000	0.0000	0.0000
0.0000	2.0000	2.0000	0.0000	0.0000	-0.1069	0.0000	0.0000
0.0000	0.0000	1.0000	0.0000	0.0000	0.0000	-0.0534	0.0000
0.0000	0.0000	0.0000	1.0000	0.0000	2.0000	-1.2571	0.0000
0.0000	0.0000	0.0000	0.0000	0.0000	0.0000	0.0000	-2.0000
0.0000	0.0000	0.0000	0.0000	0.0000	0.0000	0.0000	0.0000
0.0000	0.0000	0.0000	0.0000	0.0000	0.0000	0.0000	0.0000
0.0000	0.0000	0.0000	0.0000	0.0000	0.0000	0.0000	0.0000

THE POSITIVE DEFINITE SYMMETRIC MATRIX G IS

1.0000	0.0000	0.0000	0.0000
0.0000	1.0000	0.0000	0.0000
0.0000	0.0000	1.0000	0.0000
0.0000	0.0000	0.0000	1.0000

THE EIGENVALUES OF THE SYMMETRIC MATRIX G ARRANGED IN DECREASING ORDER ARE

1.0000	1.0000	1.0000	1.0000
--------	--------	--------	--------

THE LIAPUNOV MATRIX H FOR THE SUBSYSTEM IS

26.1110	0.2798	-0.4904	0.0559
0.2798	14.5440	-28.3071	0.0011
-0.4904	-28.3071	434.5635	0.0005
0.0559	0.0011	0.0005	0.4177

THE EIGENVALUES OF THE SYMMETRIC MATRIX H ARRANGED IN DECREASING ORDER ARE

436.3635	26.1150	12.6399	0.4176
----------	---------	---------	--------

ALL THE EIGENVALUES OF H MATRIX ARE POSITIVE AND THE SUBSYSTEM IS ASYMPTOTICALLY STABLE

THE FOUR ESTIMATES FOR THE SUBSYSTEM ARE

0.6462	20.8893	0.0239	675.2502
--------	---------	--------	----------



ESTIMATING THE NORMS OF THE INTERCONNECTING MATRICES

THE SELF-COUPPLING MATRIX Q11 IS

0.0000	-0.2342	0.1077	0.0032
0.0660	0.0000	0.0000	0.0000
0.0000	0.0000	0.0000	0.0000
0.0000	0.2342	-0.1077	-0.0032

Q TRANSPOSE Q IS

0.0043	0.0000	0.0000	0.0000
0.0000	0.1047	-0.0504	-0.0015
0.0000	-0.0504	-0.0232	0.0006
0.0000	-0.0015	0.0006	0.0000

THE ESTIMATE OF THE NORM OF THE MATRIX IS 0.3646

THE INTERCOUPLING MATRIX Q12 IS

0.0000	0.4912	-0.2456	0.0000
0.0995	0.0019	0.0000	0.0000
0.0000	0.0000	0.0000	0.0000
0.0000	-0.4912	0.2456	0.0000

Q TRANSPOSE Q IS

0.0099	0.0001	0.0000	0.0000
0.0001	0.4825	-0.2412	0.0000
0.0000	-0.2412	-0.1206	0.0000
0.0000	-0.0000	0.0000	0.0000

THE ESTIMATE OF THE NORM OF THE MATRIX IS 0.7766

THE SELF-COUPPLING MATRIX Q22 IS

0.0000	0.0000	0.0000	0.0000
-0.0995	-0.0019	0.0000	0.0000
0.0000	0.0000	0.0000	0.0000
0.0000	0.4912	-0.2456	0.0000

Q TRANSPOSE Q IS

0.0099	0.0001	0.0000	0.0000
0.0001	0.2412	-0.1206	0.0000
0.0000	-0.1206	0.0603	0.0000
0.0000	0.0000	0.0000	0.0000

THE ESTIMATE OF THE NORM OF THE MATRIX IS 0.5491

THE INTERCOUPLING MATRIX Q21 IS

0.0000	0.0000	0.0000	0.0000
-1.8478	0.0000	0.0000	0.0000
0.0000	0.0000	0.0000	0.0000
0.0000	-0.9536	0.4387	0.0131

Q TRANSPOSE Q IS

3.4144	0.0000	0.0000	0.0000
0.0000	0.9095	-0.4184	-0.0125
0.0000	-0.4184	0.1925	0.0057
0.0000	-0.0125	0.0057	0.0001

THE ESTIMATE OF THE NORM OF THE MATRIX IS 1.8478

THE AGGREGATION MATRIX A AS A FUNCTION OF COUPLING PARAMETER ZETA IS

$$\begin{aligned} & -0.000096 + 186.75 * ZETA * ZETA & 1954.26 * ZETA \\ & 392.98 * ZETA & -0.001145 + 573.86 * ZETA * ZETA \end{aligned}$$

THE AGGREGATION MATRIX A FOR ZETA=0.1000E-06 IS

$$\begin{aligned} & -0.9684E-04 & 0.1954E-03 \\ & 0.3929E-04 & -0.1145E-02 \end{aligned}$$

A(1,1) IS -0.9684E-04 AND DETERMINANT OF A IS 0.1032E-06

THE OVERALL SYSTEM IS ASYMPTOTICALLY STABLE

STABILITY ANALYSIS OF LARGE SCALE SYSTEM USING DECOMPOSITION METHOD AND LIAPUNOV FUNCTIONS

ACTIVE CONTROL

THE FIRST SUBSYSTEM MATRIX P IS

0.0000	0.0000	0.0000	1.0000	0.0000	0.0000	0.0000	0.0000
0.0000	0.0000	0.0000	0.0000	0.0000	1.0000	0.0000	0.0000
0.0000	0.0000	0.0000	0.0000	0.0000	0.0000	0.0000	1.0000
0.0463	-1.2456	-0.4387	-1.2456	1.0463	-0.0131	0.0000	0.0000
0.0000	-0.8478	0.0000	-0.1521	0.0000	0.0000	0.0000	0.0000
1.0463	-1.2456	-3.2253	-1.2456	1.0463	-0.0665	0.0000	0.0000

THE POSITIVE DEFINITE SYMMETRIC MATRIX G IS

1.0000	0.0000	0.0000	0.0000	0.0000	0.0000	0.0000	0.0000
0.0000	1.0000	0.0000	0.0000	0.0000	0.0000	0.0000	0.0000
0.0000	0.0000	1.0000	0.0000	0.0000	0.0000	0.0000	0.0000
0.0000	0.0000	0.0000	1.0000	0.0000	0.0000	0.0000	0.0000
0.0000	0.0000	0.0000	0.0000	1.0000	0.0000	0.0000	0.0000
0.0000	0.0000	0.0000	0.0000	0.0000	1.0000	0.0000	0.0000
0.0000	0.0000	0.0000	0.0000	0.0000	0.0000	1.0000	0.0000

THE EIGENVALUES OF THE SYMMETRIC MATRIX G ARRANGED IN DECREASING ORDER ARE

1.0000	1.0000	1.0000	1.0000	1.0000	1.0000	1.0000	1.0000
--------	--------	--------	--------	--------	--------	--------	--------

THE LIAPUNOV MATRIX H FOR THE SUBSYSTEM IS

7.7480	-7.9362	-5.0655	4.8721	-6.3627	-0.6935	0.0000	0.0000
-7.9362	21.1622	4.8267	-5.0113	7.8927	0.0405	0.0000	0.0000
-5.0655	4.8267	14.5729	2.7193	-1.2401	-0.2149	0.0000	0.0000
4.8721	-5.0113	2.7193	9.5523	-11.9568	-3.7787	0.0000	0.0000
-6.3627	7.8927	-1.2401	-11.9568	30.6107	3.9355	0.0000	0.0000
-0.6935	0.0405	-0.2149	-3.7787	3.9355	5.0256	0.0000	0.0000

THE EIGENVALUES OF THE SYMMETRIC MATRIX H ARRANGED IN DECREASING ORDER ARE

44.2273	23.1180	11.1139	6.2348	3.4824	0.4947	0.0000	0.0000
---------	---------	---------	--------	--------	--------	--------	--------

ALL THE EIGENVALUES OF H MATRIX ARE POSITIVE AND THE SUBSYSTEM IS ASYMPTOTICALLY STABLE

THE FOUR ESTIMATES FOR THE SUBSYSTEM ARE

0.7034	6.6503	0.0751	62.8749
--------	--------	--------	---------

THE SECOND SUBSYSTEM MATRIX P IS

-0.1823	0.0642	0.0019	0.0000	0.0000
0.0000	0.0000	1.0000	0.0000	0.0000
0.1823	-1.8508	-0.0553	0.0000	2.0000
0.0000	0.0000	0.0000	0.0000	1.0000
-2.0000	0.0000	-2.0000	-904.5314	-1.2036

THE POSITIVE DEFINITE SYMMETRIC MATRIX G IS

1.0000	0.0000	0.0000	0.0000	0.0000
0.0000	1.0000	0.0000	0.0000	0.0000
0.0000	0.0000	1.0000	0.0000	0.0000
0.0000	0.0000	0.0000	1.0000	0.0000
0.0000	0.0000	0.0000	0.0000	1.0000

THE EIGENVALUES OF THE SYMMETRIC MATRIX G ARRANGED IN DECREASING ORDER ARE

1.0000	1.0000	1.0000	1.0000	1.0000
--------	--------	--------	--------	--------

THE LIAPUNOV MATRIX H FOR THE SUBSYSTEM IS

3.0869	-2.2208	0.2915	0.2452	-0.0049
-2.2208	23.1979	0.1930	-0.3241	0.0494
0.2915	0.1930	12.4822	-24.1772	0.0011
0.2452	-0.3241	-24.1772	426.1911	0.0005
-0.0049	0.0494	0.0011	0.0005	0.4177

THE EIGENVALUES OF THE SYMMETRIC MATRIX H ARRANGED IN DECREASING ORDER ARE

427.5991	23.4415	11.0851	2.8319	0.4176
----------	---------	---------	--------	--------

ALL THE EIGENVALUES OF H MATRIX ARE POSITIVE AND THE SUBSYSTEM IS ASYMPTOTICALLY STABLE

THE FOUR ESTIMATES FOR THE SUBSYSTEM ARE

0.6462	20.6784	0.0241	661.6879
--------	---------	--------	----------

ESTIMATING THE NORMS OF THE INTERCONNECTING MATRICES

THE SELF-COUPLING MATRIX Q11 IS

0.0000	0.0000	0.0000	0.0000	0.0000	0.0000	0.0000	0.0000
0.0000	0.0000	0.0000	0.0000	0.0000	0.0000	0.0000	0.0000
0.0000	0.0000	0.0000	0.0000	0.0000	0.0000	0.0000	0.0000
-0.2342	-0.3059	-0.1077	-0.3059	-0.2342	-0.0032	-0.0032	-0.0032
0.0000	-0.0683	0.0000	-0.0796	0.0000	0.0000	0.0000	0.0000
-0.2342	-0.3059	-0.1077	-0.3059	-0.2342	-0.0032	-0.0032	-0.0032

Q TRANSPOSE Q IS

0.1097	0.1433	0.0504	0.1433	0.1097	0.0015	0.0015	0.0015
0.1433	0.1918	0.0659	0.1926	0.1433	0.0019	0.0019	0.0019
0.0504	0.0659	0.0232	0.0659	0.0504	0.0006	0.0006	0.0006
0.1433	0.1926	0.0659	0.1935	0.1433	0.0019	0.0019	0.0019
0.1097	0.1433	0.0504	0.1433	0.1097	0.0015	0.0015	0.0015
0.0015	0.0019	0.0006	0.0019	0.0015	0.0000	0.0000	0.0000

THE ESTIMATE OF THE NORM OF THE MATRIX IS 0.7897

THE INTERCOUPLING MATRIX Q12 IS

0.0000	0.0000	0.0000	0.0000	0.0000	0.0000	0.0000	0.0000
0.0000	0.0000	0.0000	0.0000	0.0000	0.0000	0.0000	0.0000
0.0000	0.0000	0.0000	0.0000	0.0000	0.0000	0.0000	0.0000
0.4912	0.0000	0.0000	222.6035	0.2956	0.2956	0.2956	0.2956
0.0065	-0.1018	-0.0019	0.0000	0.0000	0.0000	0.0000	0.0000
0.4912	0.0000	0.0000	222.6035	0.2956	0.2956	0.2956	0.2956

Q TRANSPOSE Q IS

0.4826	-0.0006	-0.0000	218.4941	0.2904	0.2904	0.2904	0.2904
-0.0006	0.0103	0.0002	0.0000	0.0000	0.0000	0.0000	0.0000
-0.0000	0.0002	0.0000	0.0000	0.0000	0.0000	0.0000	0.0000
218.4941	0.0000	0.0000	98926.6408	131.4986	131.4986	131.4986	131.4986
0.2904	0.0000	0.0000	131.4986	0.1747	0.1747	0.1747	0.1747

THE ESTIMATE OF THE NORM OF THE MATRIX IS 314.5269

THE SELF-COUPLING MATRIX Q22 IS

-0.0002	0.0036	0.0000	0.0000	0.0000
0.0000	0.0000	0.0000	0.0000	0.0000
0.0067	-0.1034	-0.0020	0.0000	0.0000
0.0000	0.0000	0.0000	0.0000	0.0000
-0.4912	0.0000	0.0000	-222.4035	-0.2956

Q TRANSPOSE Q IS

0.2413	-0.0007	-0.0000	109.2470	0.1452
-0.0007	0.0111	0.0002	0.0000	0.0000
-0.0000	0.0002	0.0000	0.0000	0.0000
109.2470	0.0000	0.0000	49463.3204	65.7493
0.1452	0.0000	0.0000	65.7493	0.0873

THE ESTIMATE OF THE NORM OF THE MATRIX IS 222.4041

88

THE INTERCOUPLING MATRIX Q21 IS

0.0000	0.0664	0.0000	-0.0664	0.0000
0.0000	0.0000	0.0000	0.0000	0.0000
0.0000	-1.9142	0.0000	1.9142	0.0000
0.0000	0.0000	0.0000	0.0000	0.0000
0.9536	1.2456	0.4387	1.2456	0.9536
				0.0131

Q TRANSPOSE Q IS

0.9095	1.1879	0.4184	1.1879	0.9095
1.1879	5.2204	0.5465	-2.1173	1.1879
0.4184	0.5465	0.1925	0.5465	0.4184
1.1879	-2.1173	0.5465	5.2204	1.1879
0.9095	1.1879	0.4184	1.1879	0.9095
0.0125	0.0163	0.0057	0.0163	0.0125
				0.0001

THE ESTIMATE OF THE NORM OF THE MATRIX IS 2.7088

THE AGGREGATION MATRIX A AS A FUNCTION OF COUPLING PARAMETER ZETA IS

$$-0.011292 + 70.597\text{ZETA} * \text{ZETA} \quad 30603.29 * \text{ZETA}$$

$$2548.19 * \text{ZETA} \quad -0.001165 + 227734.68 * \text{ZETA} * \text{ZETA}$$

THE AGGREGATION MATRIX A FOR ZETA=0.1000E-06 IS

$$-0.1129\text{E}-01 \quad 0.3060\text{E}-02$$

$$0.2548\text{E}-03 \quad -0.1165\text{E}-02$$

A(1,1) IS -0.1129E-01 AND DETERMINANT OF A IS 0.1238E-04

THE OVERALL SYSTEM IS ASYMPTOTICALLY STABLE





POSTMASTER : If Undeliverable (Section 158  
Postal Manual) Do Not Return

*"The aeronautical and space activities of the United States shall be conducted so as to contribute . . . to the expansion of human knowledge of phenomena in the atmosphere and space. The Administration shall provide for the widest practicable and appropriate dissemination of information concerning its activities and the results thereof."*

—NATIONAL AERONAUTICS AND SPACE ACT OF 1958

## NASA SCIENTIFIC AND TECHNICAL PUBLICATIONS

**TECHNICAL REPORTS:** Scientific and technical information considered important, complete, and a lasting contribution to existing knowledge.

**TECHNICAL NOTES:** Information less broad in scope but nevertheless of importance as a contribution to existing knowledge.

**TECHNICAL MEMORANDUMS:** Information receiving limited distribution because of preliminary data, security classification, or other reasons. Also includes conference proceedings with either limited or unlimited distribution.

**CONTRACTOR REPORTS:** Scientific and technical information generated under a NASA contract or grant and considered an important contribution to existing knowledge.

**TECHNICAL TRANSLATIONS:** Information published in a foreign language considered to merit NASA distribution in English.

**SPECIAL PUBLICATIONS:** Information derived from or of value to NASA activities. Publications include final reports of major projects, monographs, data compilations, handbooks, sourcebooks, and special bibliographies.

**TECHNOLOGY UTILIZATION PUBLICATIONS:** Information on technology used by NASA that may be of particular interest in commercial and other non-aerospace applications. Publications include Tech Briefs, Technology Utilization Reports and Technology Surveys.

*Details on the availability of these publications may be obtained from:*

**SCIENTIFIC AND TECHNICAL INFORMATION OFFICE**

**NATIONAL AERONAUTICS AND SPACE ADMINISTRATION**

**Washington, D.C. 20546**