

У процесі досліджень встановлено, що будь-який системний процес може бути представлений у вигляді глобальної моделі операції. Зміна будь-якого базового показника глобальної операції призводить до зміни значення її ефективності. Обґрунтовано внутрішню структуру показника ефективності. Визначено властивості, які притаманні даному показнику. Дано визначення ефективності. Визначено основну функцію показника ефективності як критерію оптимізації

Ключові слова: показник ефективності, критерій оптимізації, критерій порівняння, ефективність використання ресурсів

В процессе исследований установлено, что любой системный процесс может быть представлен в виде глобальной модели операции. Изменение любого базового показателя глобальной операции приводит к изменению значения её эффективности. Обоснована внутренняя структура показателя эффективности. Определены свойства, которыми должен обладать данный показатель. Дано определение эффективности. Определена основная функция показателя эффективности как критерия оптимизации

Ключевые слова: показатель эффективности, критерий оптимизации, критерий сравнения, эффективность использования ресурсов

UDC 001.4

DOI: 10.15587/1729-4061.2016.85453

DEFINITION OF EFFICIENCY INDICATOR AND STUDY OF ITS MAIN FUNCTION AS AN OPTIMIZATION CRITERION

I. Lutsenko

Doctor of Technical Sciences, Professor
Department of Electronic Devices
Kremenchuk Mykhailo Ostrohradskyi
National University
Pershotravneva str., 20,
Kremenchuk, Ukraine, 39600
E-mail: delo-do@i.ua

1. Introduction

Increase of business development's rates is closely connected with a possibility of the perceived and objective choice of the best way of a scenario among many possible alternatives [1–3]. A necessary condition of such development is value increase of operational process output products in relation to the input products value.

However, the condition of added value obtaining only imposes the restriction on converting process. The desire to maximize the added value does not ensure the maximum benefit from the converting process because it is necessary to consider what resources are needed for added value and what the process duration degree of such transformation is.

The operational process general characteristic that determines its competitiveness level is defined by the "efficiency" concept.

It is obvious that such issues as optimum control, acceptance of operational, tactical and strategic decisions can be solved only if the indicator which really indicates the best way of development of events is used as optimization criterion.

It is intuitively clear that there can't be many such indicators.

Nevertheless, now a large number of indicators have been developed and continues to be developed. These indicators are offered by the developers in use as a criterion for the best solutions [4–7].

The established practice of using possibility decision about the selected or developed indicator as an optimization criterion hasn't been justified [4–8].

Most often an indicator that is defined as "efficiency indicator" is offered to use as an optimization criterion. At the same time, the most various individual indicators have been already used in different systems as an efficiency indicator.

Considering that the need for the best decision making exists in different systems, the issue of identification possibility of the one cross-disciplinary efficiency indicator which can be used as optimization criterion is urgent.

2. Literature review and problem statement

As researches results show the most various indicators are attempted to use as the efficiency criterion.

They can be "cost" [8], "energy product" [9], "critical load" [10], "reliability" [11], "filling criterion" in the structural optimization problems [4], "constant energy of sampling error" [12], "minimum deviation" [13] etc. Whether it is possible to use the indicator as an optimization criterion if it characterizes only one of the operation parameters? There is no such question in the works and the made decision isn't proved.

There is the "Pareto optimality" concept and it is actively used in the task of finding the most effective choice [14]. This approach is based on the postulate according to which the value improvement of one of the partial indicators should not cause deterioration of other partial indicators.

In the research course of this concept it is impossible, for example, to answer the question: "Why is it impossible to worsen the "cost" indicator, for example, by 1 % if the income at the same time grows by 10 % at invariable operation time?"

The attempt to develop the general approach for receiving a possibility of making the best decision from a lot of alternatives has led to the creation of a method that is defined as “the multi-criteria optimization method” [15].

In such method, the weighting coefficient is established in compliance with each individual criterion. After that many indicators will be united into one expression that is determined by the concept “convolution”.

At the same time the procedure of determination of weighting coefficients is subjective, and the resultant indicator can have an unpredictable measure unit.

An alternative approach in relation to multi-criteria optimization is creation of the combined indicators [16]. In this case the unit of technical indicator measure is given by means of scaling coefficient to an indicator that is chosen as basic. Usually basic indicator is the economic criterion, for example the profit. The problem is that the scaling coefficient is chosen by the same ways that are used for indicator creation in multi-criteria optimization.

A common problem of the use of one-criterion approach is that initially developed criteria aren’t tested for their adequacy in efficiency assessment.

At the same time, it is obvious, that approach to system operations comparison has to rely on their parameters which don’t depend on physical and chemical properties.

Thus, identification of an efficiency indicator and definition of its opportunities as optimization criterion is an important scientific task.

3. Purpose and objectives of research

The purpose of the work is definition of characteristics and properties of “efficiency” category for study of a possibility of its use as systemically reasonable optimization criterion.

To achieve this goal the following objectives were set:

- creation of global operation model;
- determination of characteristics, properties and opportunities of efficiency indicator;
- proving of the use of the efficiency indicator as optimization criterion.

4. Cybernetic system operation model

For making decision for the choice of the best alternative (the best option, the best decision), it is necessary to compare operations of the most various executive systems.

It means that the indicator that is used for such comparison has to have sensitivity to all important factors.

On the other hand, research object has to belong to a certain class of complete objects [17]. Any complete object provides a possibility of input products receiving from complete objects – transmitters, and provides transfer of the output products to complete objects – to receivers. That is, the complete objects feature is that they directly don’t influence qualitative parameters of each other.

Any cybernetic executive system (system object) is a complete object. On any system object’s input the action directed product(s) (ADP) and the energy products (EP) move. At the output of system object the finished (consumer) products (FP) are generated (Fig. 1).

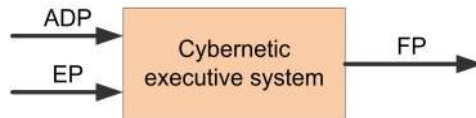

Fig. 1. Cybernetic system conceptual model

Based on this system object cybernetic model, you can proceed to the product operation cybernetic model.

Product operation model – the model of such operation input and output products of which can be presented in the form the relevant quantitative values.

A feature of the product operation model is that the system mechanism which influences the ADP is itself exposed to the same influence from the ADP. Therefore, concerning the operation cybernetic model, the system object is the same product as the ADP, energy products or consumer products.

Thus, a system object can be determined as a technical product (TP). The output technical product (TP_OUT) differs from an input technical product (TP_IN) in the rate of system mechanisms wear.

Based on the system object cybernetic model and the concept of equivalent interaction of system operation subjects, it is possible to define operation cybernetic product model (Fig. 2).

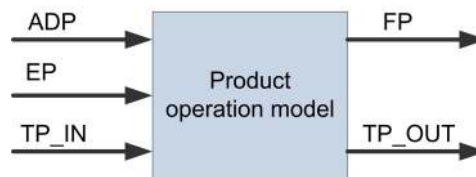

Fig. 2. Conceptual product operation model: ADP – action directed product; EP –energy product; TP_IN – input technical product; TP_OUT – output technical product; FP – finished product

To use the cybernetic product operation model possibilities, for the solution of the estimation task, it is necessary to provide the comparison possibility of operation’s input and output.

The need of such comparison is connected with the fact that operations are performed to increase the value of output products, in relation to input products.

If to scale the quantitative parameters of input $r_{qi}(t)$ and output $p_{qj}(t)$ operation products in comparable values on input $r_{si}(t)$ and output $p_{sj}(t)$ expert(cost) evaluations, it is possible to obtain the general (global) information about the research object in the form of the input $r_e(t)$ and output $p_e(t)$ reduced functions (Fig. 3).

That is, any system operation can be presented in the form of input and output reduced functions. Any change of control leads to a change in the parameters of these functions [18]. Consequently, the generalized input and output functions contain all the necessary information for the resources efficiency (rational) comparative evaluation of such operations. Integration of the $r_e(t)$ and $p_e(t)$ functions on an interval of the operation allows to receive integrated operation comparable estimates on input and output. The model of operation of the type $[r_e(t), p_e(t)]$ is defined as “global model of operation”.

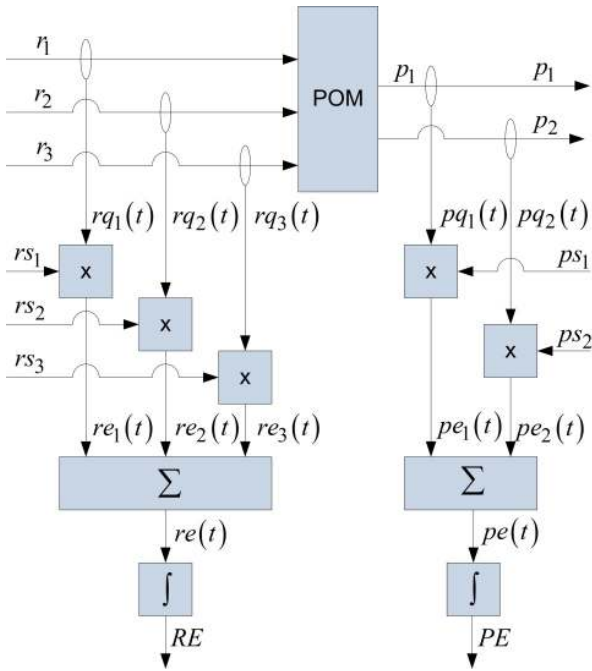

Fig. 3. Principle of product operation model formation: POM – product operation model

Also, by using integrated functions values

$$RE = \int_{t_s}^{t_f} re(t)dt, \quad PE = \int_{t_s}^{t_f} pe(t)dt$$

and the “operation time” concept ($T_{op}=t_f-t_s$), any operation can be presented in the form of global model of simple operation by the three (RE, T_{op}, PE) (Fig. 4). Here t_s – start operation time, and t_f – end operation time

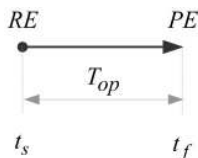

Fig. 4. Graphic global simple operation model

As global models include also physical (quantity, quality) and cybernetic (expert evaluations) operation products parameters, such models can represent a basis for one assessment criterion development.

Cybernetic models of the type $[re(t), pe(t)]$ or $[RE, T_{op}, PE]$ have identical structure and provide all data completeness needed for the optimization problem solution. So:

- Any operation can be presented in the form of global model of the type $[re(t), pe(t)]$;
- Any operation can be presented in the form of simple global model of the type $[RE, T_{op}, PE]$;
- Data of global model display operation results concerning an input and output including a temporary factor.

5. Factors which the efficiency indicator has to include

The functional connectivity between the efficiency indicator structure (E) and the operation global model basic

objects is generally evident. For example, we can write that $E=f[re(t), pe(t)]$. But, formally, such connectivity needs to be proved. And it is better to carry out such justification, based on simple operation model. In this case, not the global operation model in the form of functions with the distributed $re(t)$ and $pe(t)$ parameters, but the operation model in the form of the three $[RE, T_{op}, PE]$ is investigated. Here the time factor is presented in the form of an independent indicator.

The functional connectivity between efficiency value and operation global model objects ($re(t), pe(t)$ or RE, T_{op}, PE) comes down to justification of including all or part of operation global model objects in efficiency formula.

In Fig. 5 three models of global simple operations are represented. As operations time and expert assessment of output products ($T_{op}=\text{const}, PE=\text{const}$) don't change, more effective is the operation the input operation products expert assessment of which has the lowest value.

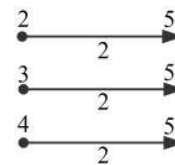

Fig. 5. Global simple operations models the input operation products expert assessment of which is changed ($T_{op}=\text{const}, PE=\text{const}$)

Based on the comparative assessment of these operations set research it is possible to make a number of conclusions:

1. The most effective is the first operation and so on in ascending order.
2. The input products expert assessment (RE) is the efficiency criterion if the conditions $T_{op}=\text{const}$ and $PE=\text{const}$ are performed.
3. Input products expert assessment is an important factor and so it has to be included in the general efficiency formula.

In Fig. 6 three models of simple operations are represented. As operations time and input products expert assessment don't change ($T_{op}=\text{const}, RE=\text{const}$) – the operation with the highest output products expert assessment value is the most effective.

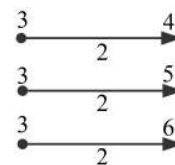

Fig. 6. Simple operations global models the output operation products expert assessment of which is changed ($T_{op}=\text{const}, RE=\text{const}$)

Having investigated these operations set, it is possible to draw the following conclusions:

1. The most effective is the last operation and so on by upside-down decrease.
2. Output products expert assessment (PE) is the efficiency criterion when the conditions of $T_{op}=\text{const}$ and $RE=\text{const}$ are performed.
3. Output products expert assessment is an important factor and has to be included in the general efficiency formula.

In Fig. 7 three models of simple operations are also represented. As input products, expert assessment and output products expert assessment don't change ($RE=const$, $PE=const$) – that operation, which has the shortest operation time is the most effective.

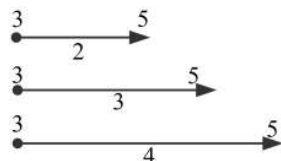

Fig. 7. Global simple operations models that have different operation time ($RE=const$, $PE=const$)

This research of simple operations set allows making conclusions as follows:

1. The most effective is the first operation and so on, in ascending order.
2. Operation time (T_{op}) is the efficiency criterion when conditions of $RE=const$ and $PE=const$ is performed.
3. Operation time is an important factor and so the time as an important factor has to be included in the general efficiency formula.

Thus, as efficiency criterion of simple operations it is possible to use one of the basic indicators if the values of other basic indicators are invariant.

As $RE=f(re(t))$, $PE=f(pe(t))$, and $T_{op}=f(re(t), pe(t))$ the efficiency formula has to rely on the reduced input and output function ($E=f(re(t), pe(t))$). In turn, the efficiency formula of simple global operation is the function of the three $E=f(RE, T_{op}, PE)$.

6. The relative nature of the overall efficiency indicator for choosing the best operation

The added value (AV) is the operation cybernetic product. That is, the field of admissible controls (decisions) is defined by the condition $(AV=PE-RE)>0$.

If to assume that operations input products expert estimates are different, and added values and operations time are identical, it is possible to carry out the choice of the most efficient operation by the relative indicator values comparison that is determined by the concept “added value coefficient” (R). Such indicator is calculated by the relation of the operation added value to the operation input products expert assessment ($R=AV/RE$, $T_{op}=const$) (Fig. 8).

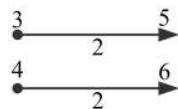

Fig. 8. Global simple operations models the input and output operation products expert evaluation of which is changed with the given step at the same time ($T_{op}=const$)

As for the definition of more efficient operation a relative index is necessary, so it is logical to assume that the overall efficiency indicator must also be a relative one (Fig. 8).

The similar index is defined in the economy as “profitability”. However economic profitability is not an indicator for operations identification. It is bound to the fact that

profitability calculation is performed within a certain time (period) by data processing results of operations set.

Besides, profitability is defined as the ratio of profit (added value) to expenses (cost). The expert assessment of input operation products (RE) is not expenses.

7. Efficiency indicator prognostic character

Based on the conducted researches, it is possible to make prognostic assessment of what basic indexes or functions have to be included in the efficiency indicator. Here two options are possible: $E=f(re(t), pe(t))$ and $E=(RE, T_{op}, PE)$. Also, it is clear that such index has to be dimensionless owing to the fact that it is the relative one.

Another feature of the “efficiency” index is that its main area of use is not the actual results checking of object functioning, but what result will be got in the future, in case of making a certain control and taking into account the most effective use of available resources, which will be received by the use of the control results.

To show a difference between a support on actual data and prognostic estimates data, we will consider two processes, each of which is presented by its own standard operation (Fig. 9).

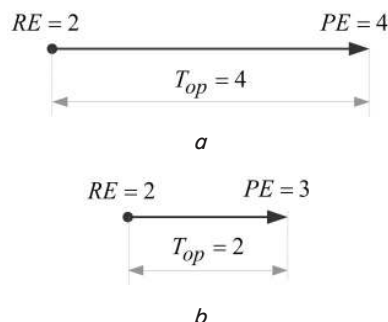

Fig. 9. Two types of standard operations: a – type 1; b – type 2

Operational process represents a consecutive performance of standard operations (Fig. 10).

Input products expert estimates, which are necessary for the start of processes, are identical, and operation performance time of the second type is a multiple of two, in relation to the first type operation performance time. Therefore, if to consider the actual results of operational processes on the t_1-t_3 interval, their assessment can be made, based only on the indicator “added value”. In open economic systems for such purposes the indicator “profit” is used.

So, on the interval (t_1-t_3) by results of functioning of the first operational process the added value of $ADD_1=PE_{1,1}-RE_{1,1}=4-2=2$ un. will be received.

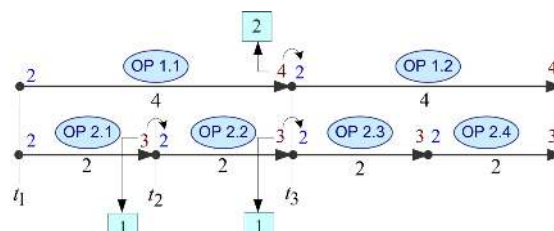

Fig. 10. Operational processes that is based on two types of operations

For the second operational process we will receive $AD_2 = (PE_{2.1} - RE_{2.1}) + (PE_{2.2} - RE_{2.2}) = (3 - 2) + (3 - 2) = 2$ un.

That is, both processes provide the identical added value on the time interval $(t_1 - t_3)$.

However, potential resources efficiency of the second process is higher (Fig. 11). It is connected with the fact that the added value or a more valuable product upon completion of the operation OP 2.1 from the time moment t_2 can be used in the additionally created operational process OP 3.

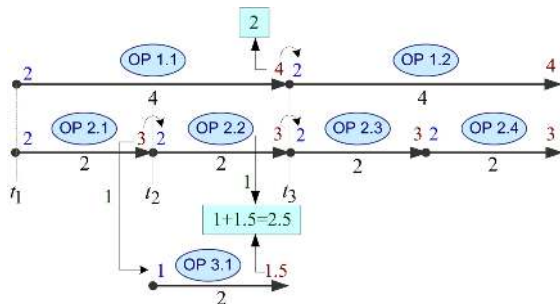

Fig. 11. Operations research with use of predictive assessment

At the same time the resources general expert assessment that can be received as a result of resources effective use is defined from the expression $ADD_{2+} = (PE_{2.1} - RE_{2.1}) + (PE_{2.2} - RE_{2.2}) - (PE_{2.2} - RE_{2.2}) + PE_{3.1} = 2,5$. Here the ADD_{2+} is the indicator for determining the absolute added predictive value of the second operational process on the time interval $(t_1 - t_3)$ [19].

Apparently, predictive assessment of the second operational process results is higher than the one of the first process. However, such conclusions can be made with the use of absolute indicators of a new class in case if the predictive estimates from future operating activities are considered. That is, the use of such absolute indicators for comparative assessment is possible only if to satisfy special conditions.

Such conditions in this example were: presentation of the studied operational processes in the form of simple operations; equality of expert estimates of input operational processes; multiple time of the shorter operation; the assumption that the operational process generated from the shorter operation will be completed within the studied period.

However, the received results have already given the chance to draw a conclusion that the efficiency indicator has to be a predictive indicator. It means that it has to give a higher assessment of the operation of the second type, in relation to the operation of the first type.

Predictive character of the «efficiency» indicator essentially distinguishes this indicator from all other classes of estimated cybernetic indicators. This is the key factor that allows full optimization or selection of the best solutions. Without a prognostic factor that cannot be done.

8. Possibility of efficiency criteria verification

The operations classes of Fig. 5–9 presented in the work give opportunities for verification of the criteria that are used as an efficiency indicator for simple operations at least.

So, the types of the reference operations models presented in Fig. 5–7 make it possible to know how sensitive the offered criteria are to changes of basic indicators.

The class of reference operations models (Fig. 8) with the parameters $T_{op} = \text{const}$, $AE = \text{const}$, allows to estimate a possibility of an indicator to consider a ratio between a cybernetic operation product (AE) and the integrated value of expert assessment of input operation products (RE).

The class of the models presented in Fig. 9 allows estimating predictive capabilities of indicators that have been proposed to use as an efficiency criterion.

So, for example, the indicator $Q = \frac{PE - RE}{T}$ [20] has sensitivity to all basic parameters of the simple operation global model. At the same time, it isn't a relative indicator, and, therefore, does not adequately estimate a class of test operations (Fig. 8). Also, this indicator does not adequately estimate a class of global models of the simple operations directed to testing the predictive opportunities of an indicator (Fig. 9).

9. Efficiency formula

Despite a large number of publications, for example [1–16, 20] which are devoted to efficiency or optimization criteria development, indicators that are based on all objects of the full global operation model are practically absent.

One of exceptions is the work [20] the indicator of which relies on all basic model parameters of simple global operation.

In the works [21–23] the indicator (EL) which relies on the input and output function has been developed

$$EL = \frac{\int_{t_a}^{t_d} \left(\int_{t_a}^t \left[\int_{t_0}^t pe(t) dt - \int_{t_0}^t re(t) dt \right] dt \right) dt}{\int_{t_0}^{t_a} \left[\int_{t_0}^t \left(\int_{t_0}^t |re(t)| dt \right) dt - \int_{t_0}^t \left(\int_{t_0}^t pe(t) dt \right) dt \right] dt}, t \in [0, t_a].$$

Here is t_a t_a – the moment of the actual time of operation end, $t_d = t_a + 1$ – time of completion of operation potential effect determination [21, 23]. At the same time, it adequately estimates models of simple global operations that are used for testing relative (Fig. 8) and predictive indicator possibilities (Fig. 9).

The indicator

$$EL = \frac{(PE - RE)^2 \cdot T_p^2}{RE \cdot PE \cdot T_{op}^2}$$

is based on the three of basic indicators and is received as a special case of this integrated expression. Here

$$T_p = t_d - t_a = 1.$$

Conceptually this indicator was defined as the proportion of absolute potential effect of the studied operation (A) to its resource intensity ($EL = A/R$).

10. Definition of the concepts “efficiency” and “efficiency indicator”

The essence of efficiency is that its use allows to establish a conventional attitude between a subject (supersystem) which seeks to achieve goals (a maximum of opportunities),

and the choice of the operational process which as much as possible corresponds to the aspirations of the subject. Such compliance is reached at the choice of the operational process having an efficiency maximum.

For example, the second process (Fig. 11) is more favorable to supersystem as provides it with great opportunities.

The value of an indicator of efficiency is the unambiguous operation identifier that provides a formalistic approach to its identification and serves as the index for the choice of optimum operational process.

Definition 1. *Efficiency* (resources use) is a qualitative cybernetic category that is intended for use of an opportunity to express interrelation between idea of the purpose of supersystem and opinion about comparative assessment of the executive system operational process with some standard by way of logical judgment formation as follows: “effective”, “ineffective”, “more effective” and “less effective”.

Definition 2. *The efficiency indicator* is the relative quantitative predictive index defining the ratio of the operation potential effect to its resource intensity that is based on basic objects of the operation global model and is intended for their quantitative identification, followed by the best operation choice problem solution from the point of view of optimal resources use.

Use of efficiency indicator as optimization criterion provides a possibility of the maximum coherence level of the subject (supersystem) and control (decision) goal, providing the most favorable operational process for supersystem that uses the executive system operational process results for the goals achievement – to increase its own opportunities.

11. Practice of use of the efficiency indicator as an optimization criterion

Possibilities of EL indicator as optimization criterion were used in the course of the problem solution of the best control choice taking in the process of portion liquid heating to the set temperature [18]. As not operational processes of different systems, but operational processes of one system were compared, so wear of the electric heater was used as input technical product.

Thus, input operation products of heating are: cold liquid (R_{CL}), electric power (R_{kWh}) and wear of the electric heater (R_W).

The output product is already heated liquid (P_{HL}). In Fig. 12 charts of change of these products quantitative parameters are represented. Control was changed by changing the power that had been given out by the heater.

In Fig. 13 the chart of time change of liquid heating up to the set temperature is represented.

Input and output product transformation according to the technology shown in Fig. 3 has allowed us to receive basic indicators (RE , PE , T_{op}) change diagram depending on control (Fig. 14).

Definition of efficiency of operational process depending on control (Fig. 15) shows (the top diagram) that optimum control corresponds to the power of 0.24 kW (the cost of unit of kilowatt-hour is 0.07 mon. unit). At the same time the optimum point

is to the right from the input products expert assessment minimum point.

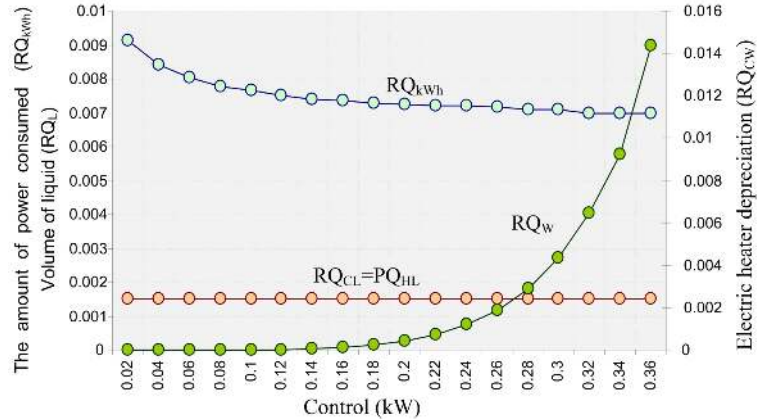

Fig. 12. Change of quantitative parameters of input and output products depending on control

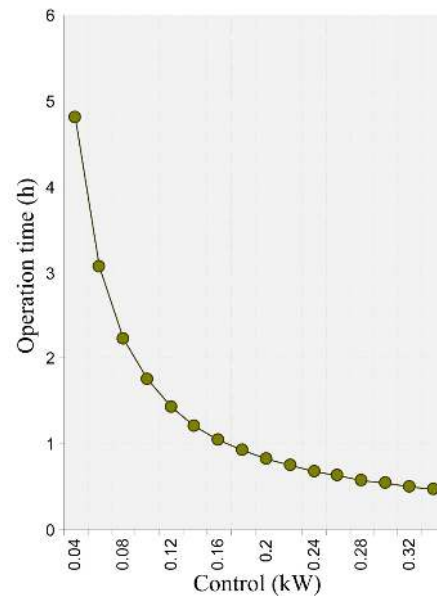

Fig. 13. Change of heating operation time from temperature depending on control

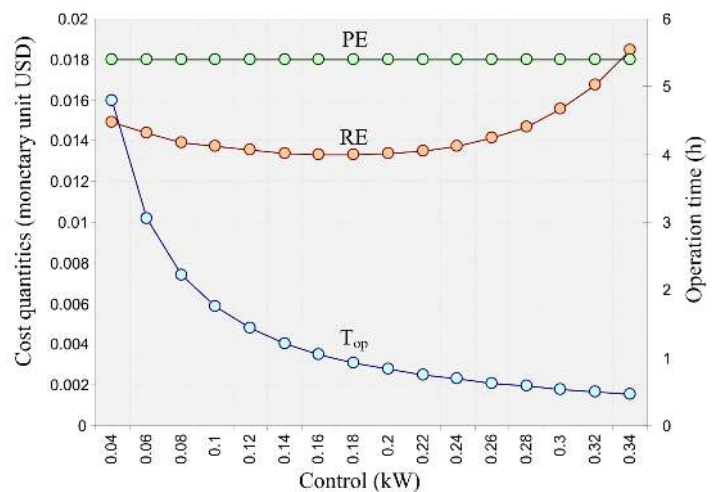

Fig. 14. Changes in the basic parameters of the simple operation model depending on control

Cost increase of kilowatt-hour up to 0.078 mon. unit (the lower diagram, Fig. 15), leads to efficiency maximum decrease and shift of the optimum point to the left.

That is, if the power product cost increases the efficiency maximum tends to the minimum of input products cost assessment. By reducing the electricity cost the maximum efficiency corresponds to the higher performance.

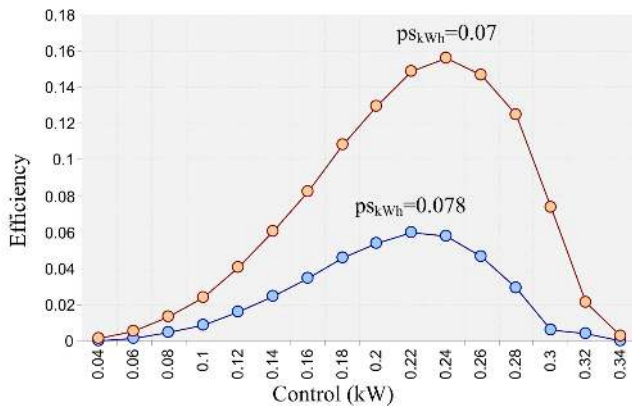

Fig. 15. Change of the liquid heating process efficiency at different energy product unit valuation

The similar picture is observed at output product cost increase (already heated liquid). In this case, the maximum efficiency tends to the right (Fig. 16).

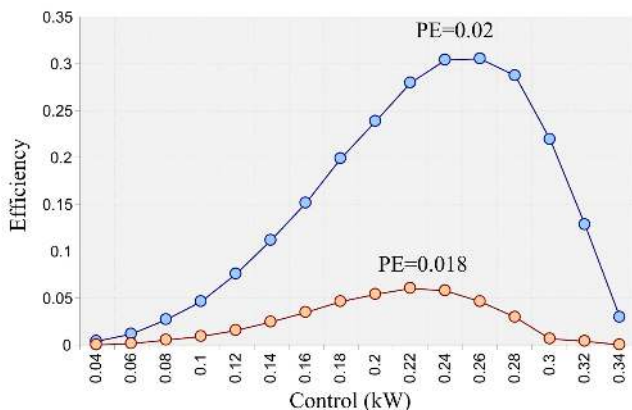

Fig. 16. Change of liquid heating process efficiency at different already heated liquid portion cost estimates

The reason of such shift is connected with the fact that an essential decrease in operation time corresponds to a rather small increase in input products cost assessment (after passing the minimum point).

The optimum point corresponds to such mode of heating system functioning at which increase in productivity is proved.

Besides, it is clear that the efficiency indicator sensitively reacts to any changes, both on the input and at the output of global operation model.

12. Discussion of researches results connected with efficiency indicator definition

Despite the wide use of the concept “efficiency”, the systematically informed determination of this major cyber-

netic category is absent hitherto. For example, in scientific literature the difference of the concepts “Effectiveness” and “Efficiency” is still discussed [24].

In this work, based on the use of operation global model objects the attempt to comprehensively characterize this category was made. External signs to which the efficiency indicator has to satisfy and its property are defined. It is shown that one of the properties which essentially differs the efficiency indicator from other performance indicators is its predictive ability.

The disadvantages of the study include the fact that for the verification the global models of simple operations were used. The need of creation of reference test operations models class with the distributed parameters is obvious. This task also is primary in further researches.

The major limiting factor of efficiency indicator use in optimization problems is imperfection of architectural concepts of automatic productions. It is connected with the fact that automation issues of technological processes have undergone a long historical process. During this process, as a result of structural optimization, automatic productions have taken a form within which each subsequent technological operation is rigidly connected with the previous one.

Such approach has led to the fact that the attempt to optimize one technological operation leads to automatic parameters change of the entire chain of rigidly connected processes. At the same time, the local optimum set the number of which, as a rule, is equal to the total number of technological operations of the automatic transfer line is formed. An attempt to optimize or solve the regulation issues in such interconnected chains of different objects very often results to in the need to suppress self-oscillations.

An alternative approach provides the design of automatic productions in the form of online interacting autonomous systems [25]. Such approach is connected with large capital investments, but this opens opportunities for the issue solution about full optimization.

This work is a continuation of researches, connected with the cybernetic models, cybernetic indicators and test operations models design [17–19, 21–23, 25].

13. Conclusions

1. Presented in the work building technology of operation global model in the form of the two (re(t), pe(t)) or the three (RE, T_{op}, PE), displays a creation possibility of cybernetic indicators class, in particular, the efficiency indicator.

2. It is established that efficiency of globally simple operation is significantly influenced by all its basic indicators (RE, T_{op}, PE), and, owing to functional dependence of RE=f(re(t)), PE=f(pe(t)), T_{op}=f(re(t), pe(t)), the efficiency of global operation, generally, is defined by the two (re(t), pe(t)).

The research of simple operations class with constant time and size of the added value has shown that for efficiency calculation of operation generally, the structure of an indicator has to have relative character.

It is established that for realization of direct methods of operation efficiency assessment it is necessary to consider the data that can't be received through direct measurement or operation parameters assessment. Such data are research result of both actual data and data of predictive character.

These researches of efficiency properties open opportunities for the creation of a formal method of testing of indicators which are planned to be used as an efficiency indicator or optimization criterion.

3. Definition of the concept “efficiency” as the qualitative category expressing interrelation concerning the idea of the purpose of supersystem and opinion on comparative assessment of operational process with some standard as the logical statement.

The concept “efficiency indicator” as the category providing a possibility of identification of global operation model in the form of the quantitative assessment corresponding to it is also defined. The maximum value of efficiency indica-

tor provides the maximum coherence of the supersystem goal with results of operating activities of its executive system.

4. The research of opportunities of EL indicator, as optimization criterion, has shown its advantages in relation to indicators, each of which characterizes the separate party of the studied operational process.

It is possible to note the use possibility of such optimization indicator for any operational process, the data of one class, which have the corresponding expert (cost) estimates, are necessary for its definition. Also, the indicator of such class provides reaction to the change of any influencing factors which, eventually, are shown by means of the change of energy consumption, change of wear and time of operation.

References

1. Healey, C. M. Efficient comparison of constrained systems using dormancy [Text] / C. M. Healey, S. Andradóttir, S.-H. Kim // *European Journal of Operational Research* – 2013. – Vol. 224, Issue 2. – P. 340–352. doi: 10.1016/j.ejor.2012.08.012
2. Syntetos, A. A. The effects of integrating management judgement into OUT levels: In or out of context? [Text] / A. A. Syntetos, I. Kholidasari, M. M. Naim // *European Journal of Operational Research*. – 2013. – Vol. 249, Issue 3. – P. 853–863. doi: 10.1016/j.ejor.2015.07.021
3. Singh, R. TOPSIS Based Multi-Criteria Decision Making of Feature Selection Techniques for Network Traffic Dataset [Text] / R. Singh, H. Kumar, R. K. Singla // *International Journal of Engineering and Technology (IJET)*. – 2014. – Vol. 5, Issue 6. – P. 4598–4604.
4. Miskowicz, M. Efficiency of Event-Based Sampling According to Error Energy Criterion [Text] / M. Miskowicz // *Sensors*. – 2010. – Vol. 10, Issue 3. – P. 2242–2261. doi: 10.3390/s100302242
5. Anishchenka, U. V. Optimization of the structure of multifunctional information systems according to the criterion of a required value of the efficiency ratio [Text] / U. V. Anishchenka A. N. Kryuchkov, L. I. Kul'bak, T. S. Martinovich // *Automatic Control and Computer Sciences*. – 2008. – Vol. 42, Issue 4. – P. 203–209. doi: 10.3103/s0146411608040068
6. Zhao, Q. A Layout Optimization Method of Composite Wing Structures Based on Carrying Efficiency Criterion [Text] / Q. Zhao, Y. Ding, H. Jin // *Chinese Journal of Aeronautics*. – 2011. – Vol. 24, Issue 4. – P. 425–433. doi: 10.1016/s1000-9361(11)60050-2
7. Vasilyev, E. S. Optimization of the architecture of a charge pump device on the basis of the energy efficiency criterion [Text] / E. S. Vasilyev // *Journal of Communications Technology and Electronics*. – 2013. – Vol. 58, Issue 1. – P. 95–99. doi: 10.1134/s1064226913010099
8. Harchenko, V. P. Optimization of network information air navigation facilities by the generalized criterion of efficiency [Text] / V. P. Harchenko, D. G. Babeychuk, O. S. Slyunyaev // *Proceedings of National Aviation University*. – 2009. – Vol. 38, Issue 1. – P. 3–5. doi: 10.18372/2306-1472.38.1650
9. Vasilyev, E. S. Optimization of the architecture of a charge pump device on the basis of the energy efficiency criterion [Text] / E. S. Vasilyev // *Journal of Communications Technology and Electronics*. – 2013. – Vol. 58, Issue 1. – P. 95–99. doi: 10.1134/s1064226913010099
10. Wu, Y. Henig efficiency of a multi-criterion supply-demand network equilibrium model [Text] / Y. Wu, T. C. E. Cheng // *Journal of Industrial and Management Optimization*. – 2006. – Vol. 2, issue 3. – P. 269–286. doi: 10.3934/jimo.2006.2.269
11. Anishchenka, U. V. Optimization of the structure of multifunctional information systems according to the criterion of a required value of the efficiency ratio [Text] / U. V. Anishchenka, L. I. Kul'bak, A. N. Kryuchkov, T. S. Martinovich // *Automatic Control and Computer Sciences*. – 2008. – Vol. 42, Issue 4. – P. 203–209. doi: 10.3103/s0146411608040068
12. Xu, Q. Adaptive surrogate-based design optimization with expected improvement used as infill criterion [Text] / Q. Xu, E. Wehrle, H. Baier // *A Journal of Mathematical Programming and Operations Research*. – 2012. – Vol. 61, Issue 6. – P. 661–684. doi: 10.1080/02331934.2011.644286
13. Xia, L. Optimization of Markov decision processes under the variance criterion [Text] / L. Xia // *Automatica*. – 2016. – Vol. 73. – P. 269–278. doi: 10.1016/j.automatica.2016.06.018
14. Mansour, R. M. Integrating Hierarchical Clustering and Pareto-Efficiency to Preventive Controls Selection in Voltage Stability Assessment [Text] / R. M. Mansour, C. B. Delbem, F. C. Alberto, R. A. Ramos // *Lecture Notes in Computer Science*. – 2015. – P. 487–497. doi: 10.1007/978-3-319-15892-1_33
15. Shorikov, A. F. Multi-criterion optimization of production range generation by an enterprise [Text] / A. F. Shorikov, E. S. Rassadina // *Economy of Region*. – 2010. – Vol. 2. – P. 189–196. doi: 10.17059/2010-2-18
16. Savchuk, T. O. Development of cloud application efficiency evaluation criterion [Text] / T. O. Savchuk, A. V. Kozachuk // *Eastern-European Journal of Enterprise Technologies*. – 2015. – Vol. 5, Issue 2 (77). – P. 20–26. doi: 10.15587/1729-4061.2015.50950
17. Lutsenko, I. Development of system operations models hierarchy on the aggregating sign of system mechanisms [Text] / I. Lutsenko, E. Fomovskaya, E. Vihrova, O. Serdiuk // *Eastern-European Journal of Enterprise Technologies*. – 2016. – Vol. 3, Issue 2 (81). – P. 39–46. doi: 10.15587/1729-4061.2016.71494

18. Lutsenko, I. Identification of target system operations. The practice of determining the optimal control [Text] / I. Lutsenko, E. Fomovskaya // Eastern-European Journal of Enterprise Technologies. – 2015. – Vol. 6, Issue 2 (78). – P. 30–36. doi: 10.15587/1729-4061.2015.54432
19. Lutsenko, I. Development of the method for testing of efficiency criterion of models of simple target operations [Text] / I. Lutsenko, E. Vihrova, E. Fomovskaya, O. Serduik // Eastern-European Journal of Enterprise Technologies. – 2016. – Vol. 2, Issue 4 (80). – P. 42–50. doi: 10.15587/1729-4061.2016.66307
20. Cirlin, A. M. Optimal'noe upravlenie tehnologicheskimi processami [Text] / A. M. Cirlin. – Jenergoatomizdat, 1986. – 400 p.
21. Lutsenko, I. Identification of target system operations. 1. Determination of the time of the actual completion of the target operation [Text] / I. Lutsenko // Eastern-European Journal of Enterprise Technologies. – 2014. – Vol. 6, Issue 2 (72). – P. 42–47. doi: 10.15587/1729-4061.2014.28040
22. Lutsenko, I. Identification of target system operations. 2. Determination of the value of the complex costs of the target operation [Text] / I. Lutsenko // Eastern-European Journal of Enterprise Technologies. – 2015. – Vol. 1, Issue 2 (73). – P. 31–36. doi: 10.15587/1729-4061.2015.35950
23. Lutsenko, I. Identification of target system operations. Development of global efficiency criterion of target operations [Text] / I. Lutsenko // Eastern-European Journal of Enterprise Technologies. – 2015. – Vol. 2, Issue 2 (74). – P. 35–40. doi: 10.15587/1729-4061.2015.38963
24. Bartuševičienė, I. Organizational Assessment: Effectiveness VS. Efficiency [Electronic resource] / I. Bartuševičienė, E. Šakalytė. – 2013. – Available at: <http://stics.mruni.eu/wp-content/uploads/2013/06/45-53.pdf>
25. Lutsenko, I. Principles of cybernetic systems interaction, their definition and classification [Text] / I. Lutsenko // Eastern-European Journal of Enterprise Technologies. – 2016. – Vol. 5, Issue 2 (83). – P. 37–44. doi: 10.15587/1729-4061.2016.79356

Досліджено концепції побудови існуючих систем моніторингу кластерних суперкомп'ютерів. Встановлено недоліки в системах моніторингу, що призводять не тільки до зниження ефективності обчислювальних кластерів, а й до порушення їх безпеки. Запропоновано підхід до створення системи моніторингу аномальних подій в суперкомп'ютерах з використанням нейронної мережі. Розроблено і описана формальна модель виявлення аномалій

Ключові слова: суперкомп'ютер, система моніторингу, виявлення аномалій, обчислювальні системи, багатоагентний підхід

Исследованы концепции построения существующих систем мониторинга кластерных суперкомпьютеров. Установлены недостатки в системах мониторинга, приводящие не только к понижению эффективности вычислительных кластеров, но и к нарушению их безопасности. Предложен подход к созданию системы мониторинга аномальных событий в суперкомпьютерах с использованием нейронной сети. Разработана и описана формальная модель обнаружения аномалий

Ключевые слова: суперкомпьютер, система мониторинга, обнаружение аномалий, вычислительные системы, многоагентный подход

UDC 004.056.2

DOI: 10.15587/1729-4061.2016.85433

DESIGNING A MONITORING MODEL FOR CLUSTER SUPER-COMPUTERS

I. Ruban

Doctor of Technical Sciences,
Professor, Head of Department
Department of Electronic Computers*
E-mail: ruban_i@ukr.net

V. Martovitsky

Postgraduate student
Department of Information Technology Security*
E-mail: martovytskyi@gmail.com

N. Lukova-Chuiko

PhD, Associate Professor
Department of Cybersecurity and
Information Protection
Taras Shevchenko National University of Kyiv
Volodymyrska str., 64/13, Kyiv, Ukraine, 01601
E-mail: lukova@ukr.net

*Kharkiv National University of Radioelectronics
Nauka ave., 14, Kharkiv, Ukraine, 61000

1. Introduction

At present, super-computer technologies solve the problems not only of scientific and technical activity but are also used in all fields of human activity. These technologies develop rapidly and have a large potential.

Current increase in computational equipment and methods of mathematical modeling provides for the possibility for the industrial and scientific research activity to reach higher level of development. Simulation of sophisticated structures, mathematical description and reproduction of natural processes, multiparametric optimization – all this is real today.