

DOCUMENT RESUME

ED 057 576

EM 009 416

AUTHOR Newman, Burton A.; And Others
TITLE Design of a 12-GHz Multicarrier Earth-Terminal for
Satellite-CATV Interconnection.
INSTITUTION Washington Univ., St. Louis, Mo.
SPONS AGENCY National Aeronautics and Space Administration,
Washington, D.C.
REPORT NO M-71-8
PUB DATE Nov 71
NOTE 69p.
EDRS PRICE MF-\$0.65 HC-\$3.29
DESCRIPTORS *Communication Satellites; *Educational
Specifications; Educational Television;
*Electromechanical Technology; Instructional
Television; *Systems Analysis; Telecommunication;
Televised Instruction

ABSTRACT

If a satellite-based educational networking and delivery system is to find wide acceptance in the United States and is to be economically viable, it must be capable of interconnecting many headends or nodes on the ground and of delivering quantities of diverse program material. A large number of TV-equivalent bandwidth channels will be required to meet even the most modest educational needs. A basic problem in all communication engineering is to obtain the proper balance between investment in the link itself and investment in the terminal equipment. A systems analysis of the 12 GHz multicarrier earth-terminal which attempts to achieve that balance is presented. The analysis considers baseband signal, picture quality, downlink frequency plan and receiver system. The technical aspects of a multi-carrier receiver are described in some detail. Special attention is given to the down converter design, with respect to mixer design, microstrip filters, local oscillator, 1GHz IF amplifier, branching network, and second mixer and local oscillator.
(JY)

ED057576

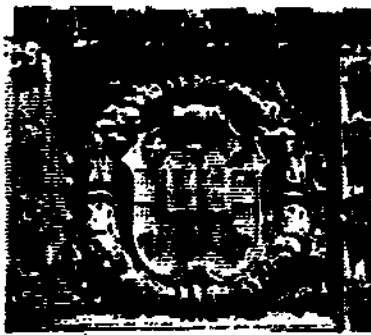

WASHINGTON UNIVERSITY

Memorandum No. 71-8

November, 1971

Design Of A 12-GHz Multicarrier Earth-Terminal For Satellite-CATV Interconnection

Burton A. Newman
Jai P. Singh
Fred J. Rosenbaum

ED057576

PROGRAM ON APPLICATION OF COMMUNICATIONS SATELLITES
TO EDUCATIONAL DEVELOPMENT

WASHINGTON UNIVERSITY

Memorandum No. 71/8

U.S. DEPARTMENT OF HEALTH,
EDUCATION & WELFARE
OFFICE OF EDUCATION
THIS DOCUMENT HAS BEEN REPRO-
DUCED EXACTLY AS RECEIVED FROM
THE PERSON OR ORGANIZATION ORIG-
INATING IT. POINTS OF VIEW OR OPIN-
IONS STATED DO NOT NECESSARILY
REPRESENT OFFICIAL OFFICE OF EDU-
CATION POSITION OR POLICY.

November, 1971

DESIGN OF A 12-GHZ MULTICARRIER EARTH TERMINAL
FOR SATELLITE-CATV INTERCONNECTION

Burton A. Newman
Jai P. Singh
Fred J. Rosenbaum

This research is supported by the National Aeronautics and Space Administration under Grant No. Y/NGL-26-008-054. This memorandum is primarily for internal distribution and does not necessarily represent the views of either the research team as a whole or the National Aeronautics and Space Administration.

TABLE OF CONTENTS

No.		Page
1.	Introduction	1
2.	System Considerations	7
2.1	Introduction	7
2.2	Baseband Signal.	8
2.3	Picture Quality.	12
2.4	Downlink Frequency Plan	17
2.5	Receiver System	28
3.	Implementation of Multi-carrier Receiver.	37
3.1	Introduction	37
3.2	Down-Converter Design.	39
3.2.1	Mixer Design.	42
3.2.2	Microstrip Filters.	45
3.2.3	Local Oscillator.	47
3.2.4	1 GHz IF Amplifier.	51
3.2.5	Branching Network	53
3.2.6	Second Mixer and Local Oscillator	54
4.	Future Work and Proposed Research Areas	59
5.	References	61

LIST OF FIGURES

No.		Page
1.	Constitution of the Baseband Signal	13
2.	Rain Attenuation Probabilities in New Jersey.	18
3.	Video [S/N] _{p,w} Probabilities	19
4a.	Adjacent Channel Spacing.	25
4b.	Alternate Channel Spacing	25
5.	Earth Terminal Block Diagram.	33
6.	Front-end Mixer Schematic	41
7.	Down-Converter Package.	43
8.	Photograph of Traveling Wave Directional Filter Mask. The Design Frequency is 10 GHz	46
9.	Photograph of Low Pass Filters. The Upper Filter has its Cutoff Frequency at 4 GHz, the Lower One at 10 GHz.	48
10.	Photograph of Rejection Filter Masks. Although both Designed for 10 GHz the Right One Should Exhibit Greater Rejection at 10 GHz at the Expense of Slightly Higher Signal Attenuation.	49
11.	Experimental FM Noise Performance of Gunn Diode Local Oscillator	50
12.	Spectral Output of Gunn Diode.	52
13.	Branching Network.	55

LIST OF TABLES

No.		Page
1.	Down-Converter Specification	3
2.	Performance Characteristics of Developmental X-Band Single Channel Receivers.	6
3.	Summary of the Bandwidth and CNR Requirements for Digital Modulation Techniques for a Probability of Error of 10^{-6}	21
4.	Satellite-to-Earth Power Budget.	31
5.	Satellite Ground-Terminal Characteristics.	36
6.	Possible Frequency Plan.	57

DESIGN OF A 12 GHz MULTI-CARRIER EARTH-TERMINAL
FOR SATELLITE-CATV INTERCONNECTION

B. A. Newman, J. P. Singh, and F. J. Rosenbaum

1. INTRODUCTION

If a satellite-based educational networking and delivery system is to find wide acceptance in the United States and is to be economically viable, it must be capable of interconnecting many headends or nodes on the ground and of delivering quantities of diverse program material. A large number of TV-equivalent bandwidth channels will be required to meet even the most modest educational needs.¹ On the ground commercial as well as institutional cable systems provide an attractive method for program delivery to and interconnection of educational subscribers. There are not enough broadcast channels available to disseminate the large amounts of rather specialized program material that need to be delivered. Further, broadcast channels are not capable of handling interactive situations which cable systems could readily incorporate.

A basic problem in all communication engineering is to obtain a proper balance between investment in the link itself on the one hand and investment in the terminal equipment on the other, in order to obtain maximum overall economy. As the number of earth terminals that are to be interconnected via a satellite increases, and particularly in systems where a satellite is used for wide-area coverage and program delivery, the balance for the interconnection link moves increasingly towards the space segment to allow higher effective radiated power (ERP) and lower earth-terminal sensitivities to minimize the overall system cost.

There are two basic system options available to the system designer concerned with satellite-CATV interconnection using moderately priced earth-terminals: (1) A single carrier system in which all program channels are Frequency-Division-Multiplexed (FDM) together and used to modulate a single wideband carrier which is relayed via the satellite to individual cable headends; and (2) A multiple carrier system which uses a separate RF carrier for each TV channel. The single carrier system, where an entire block of FD multiplexed AM-VSB TV channels is translated to a certain carrier frequency, has been the favorite of many terrestrial point-to-point cable interconnection systems due to the relative ease in which the channels could be converted to a format suitable for CATV transmission without using additional remodulating equipment. The disadvantage in its adoption for satellite-based interconnection lies in the fact that it requires all channels to be originated at a single point.

We have opted for the multi-carrier system because it allows individual TV channels to be originated from different programming centers simultaneously and due to its advantage of permitting channelization of the satellite-borne transponder design so that certain failures in the transponder will affect only individual channels. This advantage is important because a satellite is not accessible for servicing at any time. As far as transmission of narrowband signals is concerned, such as those encountered in stereophonic radio, facsimile, etc., we have decided to multiplex them together so that the multiplexed signals occupy the normal TV basebandwidth and then transmit them on a single carrier.

We have begun the design and development of the front-end of such an earth-terminal in order to better understand the technical problems involved and to attempt their solution. The specifications towards which we are working are shown in Table 1. They have resulted from a detailed systems analysis

TABLE 1

DOWN-CONVERTER SPECIFICATION

Center Frequency	11.950 GHz
Bandwidth	500 MHz
Individual RF Carrier Bandwidth (per TV Channel)	36 MHz
Modulation	FM
Guard Band	4 MHz
No. of Channels	12
Mixer Noise Figure	11 dB
Conversion Loss	-6 dB
L.O. Frequency	11 GHz
L.O. Type	Low Noise Gunn Oscillator
Signal/L.O. Input	X-band Waveguide
IF Output	OSM
IF Frequency	1 GHz
IF Bandwidth	500 MHz

reported in Section 2. The choice of the frequency band 11.7-12.2 GHz is based upon a study of Singh.² The use of this latter band for high-volume program delivery to CATV headend allows: (1) high antenna gains for a given aperture dimension compared with lower frequency bands; (2) use of relatively small earth-terminals in view of the absence of any power-flux density restrictions on this band; and (3) easy collocation of the earth-terminals with the CATV headends and therefore, elimination of additional investment in the interconnection of the earth-terminal with the CATV headend.

Our developmental 12 GHz-12 carrier down-converter uses waveguide, coaxial, and microstrip transmission line elements in its implementation. A low-noise Gunn diode is used to provide the local oscillator power. Mixing is accomplished in a single ended coaxial mixer employing a field-replacable cartridge-style diode. These choices, their justification and the current state of our efforts are discussed in Section 3. In order to provide a background for this work, we briefly discuss some of the recent work reported on single-carrier X-band receivers.

Lugignan et al.,³ describe a waveguide balanced-mixer low-cost receiver with a design goal of 9 dB noise figure. The receiver bandwidth is 40 MHz. The suggested local oscillator is a cavity mounted Gunn diode. A 100 KHz video guard band would be required if the L.O. is operated without phase locking. No AFC loop was described in this report. The balanced mixer is proposed to eliminate the expected large AM noise component from the Gunn diode. Our experience with Gunn diode oscillators at Washington University⁴⁻⁹ indicates that they should be very good L.O.'s with lower AM noise than even "low noise" klystrons.

General Electric has also reported on a single channel 40 MHz bandwidth X-band receiver.¹⁰ The balanced mixer was implemented in stripline and used ultrasonically bonded beam-lead

diodes. The input bandpass filters had a midband insertion loss of 3 dB. A noise figure of 11.0 ± 0.1 dB was measured (including the IF amplifier) with an L.O. power of 5 dBm. A Varian VSX-9001 Gunn oscillator yielded an uncompensated frequency stability of about 200 KHz/°C. Addition of a temperature compensating alumina probe reduced the drift to less than 20 KHz/°C. A 15 dB gain transistor IF amplifier was used. It had a 150 MHz bandwidth and a 3 dB noise figure.

An X-band microstrip mixer using GaAs Schottky Barrier Diodes (SBD) which used a 500 MHz thin film IF preamplifier was reported by K.M. Johnson.¹¹ The balanced mixer used filters to terminate the image frequency in a short circuit at the diode. The thin film IF amp had a 2.2 dB noise figure. The total mixer noise figure was 6.7 dB.

RCA Laboratories¹² developed a low noise (6.4 db) X-band receiver with a total signal gain of 39 dB. The 500 MHz IF amplifier had a 540 MHz bandwidth and a 3 dB noise figure.

Oxley¹³ has described an X-band receiver using planar GaAs SBD's in a balanced mixer. A 6 dB noise figure was obtained.

Most recently Westinghouse¹⁴ described some exciting results at 9.5 GHz using a single ended mixer and a 1 GHz IF. A conversion loss of 4 dB was achieved using a GaAs chip diode and careful sum and image frequency recovery techniques.

A summary of the performance of these various receivers is given in Table 2.

TABLE 2
PERFORMANCE CHARACTERISTICS OF DEVELOPMENTAL
X-BAND SINGLE CHANNEL RECEIVERS

Company	Frequency (GHz)	Bandwidth (MHz)	Mixer	IF (MHz)	Image and Sum Termination	IF Noise Figure (dB)	IF Gain dB	System Noise Fig. (dB)
(11) Texas Inst.	X - Band		GaAs Chip SBD	500	I	2.2	24.5	6.7
(14) Westinghouse	9.5	450	GaAs Chip SBD	1000	Σ and I			
(12) RCA	9.0	540	SBD	500		3	10	6.4
(13) G.E.C. Semiconductors	9.375	20	GaAs Chip SBD	45		2	20	6.0

2. SYSTEM CONSIDERATIONS

2.1 Introduction

The specifications or design objectives for the 12-GHz receive only small earth-terminal for satellite-based CATV headend inter-connection would have to be expressed in terms of the system sensitivity or the figure of merit $[G/T, \text{dB}/^\circ\text{K}]$ computed as the ratio of the terminal antenna gain (expressed in dBs over an isotropic antenna) and the system noise temperature ($^\circ\text{K}$), downlink frequency plan (polarization, channel spacing and bandwidth), modulation, the downlink channel signal-to-noise ratio, and the terminal's share of the permissible intermodulation noise and differential phase and differential gain distortions of the NTSC color signal. In this section we would attempt to establish a set of specifications that we deem as desirable for satellite-based CATV headend interconnection. However, at this stage these specifications are merely a first cut and we are open to any reasonable suggestion for changes in them.

The design parameters for the earth-terminal rest heavily on the design parameters of the satellite(s) with which they would be used. As stated previously a basic problem in all communication engineering is to obtain a proper balance between the investment in the link itself on the one hand and investment in the terminal equipment on the other, in order to give the maximum economy. When a large number of CATV headends (over 2500 today) are to be interconnected via a single (or perhaps two) satellite(s), the maximum economy lies somewhere in the region where a relatively powerful satellite serves simple and low-cost terminals and not in a situation where a low powered satellite(s) serves complex and very expensive earth-stations.

For the purposes of taking a first cut at the design parameters, we have assumed an effective radiated power in

the range of 55-60 dBW over each 35-40 MHz satellite RF channel and a channelized repeater so that there are no backoffs involved due to multicarrier operation. At 12-GHz this kind of e.i.r.p. is not beyond the current state-of-the-art. Assuming a 4.5 foot diameter antenna on the spacecraft that provides a 1.5° beamwidth and a gain of 38 dB at 12-GHz, the actual power per RF channel to achieve 55-60 dBW e.i.r.p. is of the order of 17-22 dBW or 55-180 watts. As we will see later in this section, this kind of e.i.r.p. is needed if a proper grade of service with adequate reliability is to be provided (with FM modulation) at 12-GHz which suffers from deep fades during localized high-intensity rains and where the use of large non-tracking antennas is not possible due to the satellite motion and the narrow antenna beamwidths.

2.2 Baseband Signal

The ultimate objective for the earth-terminal is to be able to receive multiple TV channels from the satellite for further distribution to subscribers terminals via local CATV distribution plant. The television signal, distributed via the satellite, will be NTSC color signal--the compatible color system adopted in the United States. It is a 60 fields/second, 525 line/frame, 2 fields/frame system that has a nominal bandwidth of 4.2 MHz. The NTSC color television signal contains a chrominance signal superimposed on a luminance signal. Simply speaking, the chrominance signal consists of a subcarrier situated near the upper limit of the video band (at 3.579545 MHz, an odd multiple of the half-line sweep frequency of 7867 Hz) and modulated in both amplitude and phase. The amplitude of this subcarrier signal represents color saturation and the phase determines the hue of the reproduced color in the television picture. Any transmission system that has non-linear phase and gain characteristics over the pass band (either the baseband in the case of baseband transmission or the RF and IF bands in the case of modulated

carrier television distorts the original amplitude and phase relationships and thus results in a change in saturation or hue of the reproduced color.

The distortions in amplitude and gain relationships are often discussed in terms of differential gain (DG) and differential phase (DP) respectively and are closely related to the envelope delay distortion; envelope delay is the rate of change of the phase over the passband ($d\phi(\omega)/d\omega$) and often has a linear as well as a parabolic component.^{15,16}

The requirements for holding picture impairments to acceptable levels are often given in terms of coarse structure and fine structure deviations particularly in Bell System papers. Coarse structure deviations have low periodicity where fine structure deviations have high periodicity. The crossover frequency, as arbitrarily defined by Fagot and Magne¹⁷ is 555 KHz.

Streaking in the video display is caused by distortions below 300 KHz, while smearing results from non-linearities at higher frequencies. At very low video frequencies (<5 KHz) phase and amplitude distortions are not critical. Ringing and overshoot result from transmission through a system having a marked irregularity in the phase and/or gain characteristics.

The "Engineering Report No. 55---Television Network Transmission Objectives", issued by the Network Transmission Committee (NTC) in 1968, states a tentative Differential Phase (DP) and Differential Gain (DG) objective of 5° and 1.4 dB. A recent study¹⁸ has shown that for a 5° DP, 81 percent of the test subjects rated the effect just perceptible whereas approximately 100 percent called it a non-objectionable or better on a 7 point scale. With both levels of impairments occurring together (1.4 dB DG and 5° DP), the study showed that subjective reaction was just perceptible or better for 76 percent of the people and not objectionable for definite impairment or

better for approximately 100 percent of the people. We have decided to take 1.4 dB DG and 5° DP as the overall system (space + terrestrial reception and redistribution) requirement. The following is a reasonable allocation of the overall specs to the various parts of the system:

	<u>Differential Gain (DG)</u>	<u>Differential Phase (DP)</u>
Central Distributing Facility	0.2 dB	1.0 degrees
Satellite Link	1.0 dB	3.0 degrees
CATV Distribution System	0.2 dB	1.0 degrees

In FM transmission systems (earth-to-satellite and satellite-to-earth links), the differential phase and gain distortions are produced by the non-linearities in both RF and baseband equipment.¹⁵ It becomes necessary to equalize the signal at both IF and baseband stages in the receiver. Without equalization it would be impossible to meet the DP and DG requirements.

For transmission of television modulated carriers through the terrestrial network, both the International Radio Consultative Committee (CCIR) and the American Telephone and Telegraph Company (AT&T) have their own standards. For NTSC color TV signal, CCIR requirements for envelope delay are ± 18.5 ns to 3 MHz and ± 36.5 ns to 4 MHz with slightly reduced tolerances at 3.58 ± 0.5 MHz (color subcarrier location), maximum DG ≤ 0.7 dB and maximum DP $\leq 2.3^\circ$. Bell System requirements (overall--user to user) are ± 25 ns of envelope delay in the coarse structure, between 7875 Hz and the upper frequency cut-off, a DG ≤ 2 dB and DP $\leq 5^\circ$. International Communications Satellite Committee (ICSC) has prescribed the following Envelope Delay Distortion requirements based on already proved terrestrial standards: a coarse structure delay (maximum) of ± 25 ns, a fine structure phase of ± 0.80 , a DG of 1.2 dB and a DP of 3° .³⁷

We have decided to conform to ICSC coarse structure delay, fine structure phase and DP requirements but a slightly tighter D requirement of 1.0 dB as opposed to 1.2 dB of ICSC.

Another important consideration related to the baseband signal is the placement of the audio and orderwire channels. In certain cases, such as for the channels required for Public Broadcasting Service, stereophonic sound and a 3 KHz orderwire channel have been stated as a requirement.¹⁹ Following are the ways in which audio and orderwire channels could be accommodated in the baseband:

- (1) Frequency Division Multiplexing of FM/AM, Aural/Orderwire Subcarriers with the Baseband RV signal.
- (2) Time Division Multiplexing of width-modulated aural/orderwire signal in the line-blanking interval as in the case of TV distribution via Russian Molniya.²⁰
- (3) Time Division Multiplexing of multiple Time-Compressed Audio Signals during the vertical sync interval as proposed by Gassman.²¹

FDM placement of subcarriers is a method advocated in the TRW report on Television Broadcast Satellite²² and a comprehensive study by Sachdev.²³ It is simple to implement but needs additional RF space as opposed to the other two methods. For one 15-KHz aural subcarrier, the RF bandwidth requirement is 1.06 times that required by standard 4.2 MHz video baseband, all other conditions being the same; for 4 15-KHz aural channels the RF bandwidth is increased by 30%. Methods [2] and [3] are also attractive from the viewpoint of changing the standard Sync-tip spectral distribution. However, we have decided in favor of Frequency Division Multiplexed subcarriers as they allow cheaper earth-terminals.

The subcarrier frequencies are chosen such as that none of the subcarrier bands coincide with the third order products

of intermodulation between the subcarriers themselves and between any of the sound subcarriers and the color subcarrier. Even when FM subcarrier modulation is used, the standard vision-aural carrier frequency should be avoided in the choice of subcarrier frequencies to simplify filter requirements at the sound channel selection units at the earth-terminals. Uneven subcarrier spacing is suggested because equally spaced subcarrier frequencies always lead to in-band third order products [$2f_r \pm f_k$ and $f_r \pm f_k \pm f_M$; where $r, k, M = 1, 2, 3, \dots, N$, and $r \neq k \neq M$] which could, in general, coincide with one of the subcarrier frequencies. We suggest that with each vision signal two 15-KHz aural channels be provided for stereophonic sound capability and the aural subcarriers be located at 4.7 MHz and 5.5 MHz. The orderwire facility, which could either be a low grade voice channel (3-3.5 KHz) or a teletype (100 bits/second), could be accommodated in the vertical flyback interval of the sync waveform. Figure 1 shows the constitution of the baseband signal (baseband video + two aural subcarriers) that will be used to frequency modulate the main carrier.

2.3 Picture Quality

Adequate data on the correlation between the subjectively experienced picture quality and Signal-To-Noise Ratio (SNR) are not available for FM transmission. For Amplitude Modulation - Vestigial Sideband Modulation (AM-VSB) transmission, Television Allocations Study Organization (TASO) has correlated Carrier-To-Noise Ratio with the subjectively experienced picture quality. TASO used a six-point scale with the highest grade of service referred to as "Excellent" that corresponds to 46 dB Carrier-To-Noise Ratio at the receiver input. Next Grade (Grade 2) has been named as "Fine" and requires a CNR of 38 dB. In Grade 1, interference is not at all visible whereas in Grade 2, interference is just perceptible but picture provides enjoyable viewing. In the past, in many studies

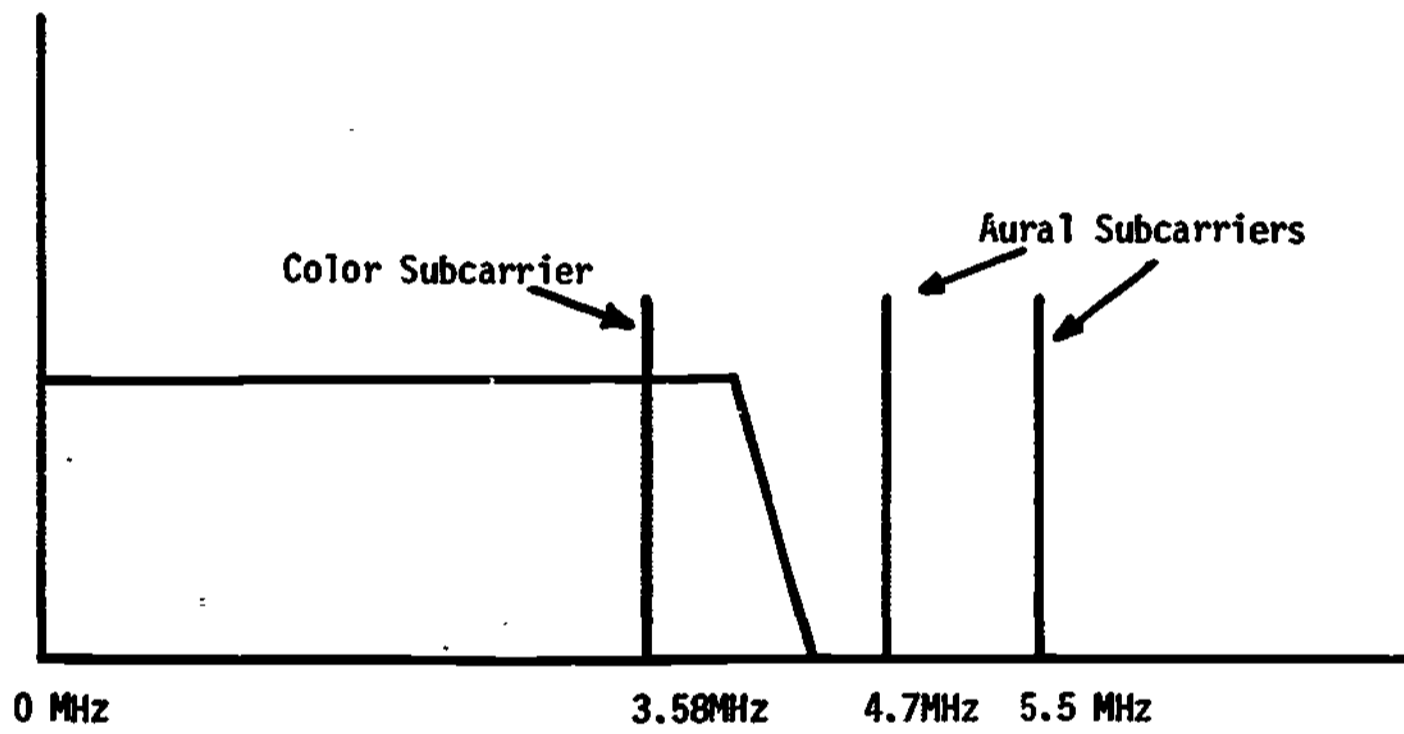

Fig. 1 - Constitution of the Baseband Signal

and designs, the picture quality objective for broadcast satellites (including those meant for community reception) has been stated as one equivalent to TASO Grade 2. We do not think that such an objective would be acceptable to the CATV operators as well as many viewers in the United States. In our opinion, the picture quality objective should be equivalent TASO Grade 1. The system (Central distributing facility + Satellite up- and down-links + CATV distribution facility) should be designed with a transmission quality that provides an equivalent of TASO Grade 1 quality when viewed with a high quality home receiver. Of course, many of the system subscribers (TV households, schools, etc.) would not have the quality reception equipment needed to translate the incoming signal to picture without adding excessive noise of their own making, but that is a separate matter.

Now our problem is to translate the requirement of 46 dB Carrier-to-Noise Ratio in the case of VSB-AM transmission to a number meaningful for FM transmission. In the case of FM transmission of video signals, perhaps the best way of stating the signal quality is in the terms of the ratio of the peak signal power to the weighted r.m.s. noise power ($[S/N]_{p,w}$). It has been shown elsewhere^{22,24} that

$$[S/N]_{p,w} = [C/N]_{TASO} + 0.9 \text{ dB} \quad (1)$$

However, at this point it should be noted that the TASO figures do not account for the camera noise; the values of CNR stated by TASO relate to the controlled RF noise injected at the test receiver input in a closed circuit situation where the test pictures were generated using a high quality flying spot generator generating pictures with a SNR of some 48 dB. However, in practical situations, camera tubes are seldom capable of producing pictures with better than 45-46 dB SNR.²⁵ Using this and equation (1), one finds that transmission Noise objective for the FM channel for TASO Grade 1 picture quality

corresponds to 49.5 dB. In many cases, where poor recordings are transmitted via the satellite or programs are originated with average quality cameras (SNR 45dB) it would not be possible to meet TASO Grade 1 noise objectives. However, the limiting factor would be the pickup tubes or playback equipment and not the channel itself.

TASO reports that color television requirements in terms of CNR are slightly lower than monochrome television for equal subjective quality.²⁶ This result defies common sense as one expects the opposite results since the color subcarrier detection process translates noise with the color subcarrier channel to low video frequencies, where the attenuation in the weighting factor is less than near the color subcarrier frequency. This has been confirmed in a study by Barstow and Christopher²⁷ published in 1962 which states, as one would expect, that equal magnitudes of noise near the color subcarrier are noticeably more interfering in color pictures than in monochrome pictures. This observation is also reflected in a hump (approximately 2 dB) in the EIA/BELL noise weighting curve at the color subcarrier frequency, leading to a lower weighting factor for color pictures than for monochrome pictures.²⁴ These results are of special significance to the FM transmission which has a quadratic noise power spectrum. TRW calculations²² based on CCIR recommendations for 625-line system with 5.5 MHz video bandwidth (as none exist for 525-line system) show that for FM transmission, a noise level corresponding to the luminance channel requirements results in a noise level in the chrominance channel some 4.6 dB less than required. Similar results could be expected for 525-line system.

We are of the opinion that a transmission noise objective of 49.5 dB peak signal power to weighted rms noise ratio is adequate for color pictures too. A higher objective would be very taxing from the viewpoint of the satellite power and would

also result in the overdesign of the system as any increase in the transmission noise objectives would not result in a better picture to the viewers--the limiting factor would be the program origination equipment which are rarely capable of producing video signals with a SNR higher than 43-46 dB. If the program is being originated through a VTR, i.e., it is a recording, the video signal has a SNR some 1-2 dB poorer than that produced by a live pick up.

The peak-to-peak weighted SNR of 49.5 dB presents an overall transmission noise requirement--satellite up- and down-links and CATV distribution facility combined. The requirement on a component video system, such as the satellite up- and down-links and CATV distribution facility, is considerably more stringent, of course. The following is what we take as a reasonable $[S/N]_{p,w}$ distribution over the various video systems. A satellite transponder noise figure of 8 dB for 13/12 GHz operation has been assumed along with the fact that satellite transmit and receive earth terminals are co-located with the central distribution and CATV headends, respectively and no interconnection link is needed.

	<u>$[S/N]_{p,w}$</u>
Satellite Uplink	67 dB
Satellite Downlink	53 dB
<u>CATV facility</u>	<u>53 dB</u>
Overall Performance	49 dB [TASO Grade 1]

An important system performance consideration related with the question of the picture quality is the percentage of time that quality is available. For 12-GHz satellite downlink it would be unrealistic to state 53 dB $[S/N]_{p,w}$ for 100 percent of the time. Rain attenuation is a major factor to be considered at 12-GHz. It becomes a serious matter if service requirements must be met for all but a very

small percentage of time, as the ratio of relative attenuation increases almost exponentially under such conditions. Figure 2 shows the rain attenuation probabilities in New Jersey; it is obvious as the percentage time requirement for maintaining certain $[S/N]_{p,w}$ or $[C/N]$ increases, that the link margin requirements are increased drastically. For 99.90 percent link reliability, the estimated link margin for New Jersey areas (a typical case) at 12-GHz is approximately 7 dB, 8.5 dB for 99.95 percent reliability, and 18 dB for 99.99 percent reliability. For satellite TV broadcasting to community TV installations/CATV headends, we have decided in favor of a 5.26 dB link margin which ensures that for 99.8 percent of the time, the overall transmission system would be capable of providing a TASO Grade 1 picture or better and for 99.9 percent of the time, a picture quality better than TASO Grade 2. (See Figure 3 and Table 4.)

2.4 Downlink Frequency Plan

Frequency planning for the downlink needs consideration regarding the modulation method, RF channel bandwidth, channel spacing, the sense of polarization, and the number of individual RF channels/beam. In this subsection, we first make certain assumptions regarding modulation method, polarization, and use of orthogonal polarizations to double the information carrying capacity of the frequency band, and then we attempt to establish system parameters in terms of channel bandwidth and spacing.

Frequency modulation is the obvious choice for the system from the viewpoint of the satellite output RF power--the major limiting factor in the satellite interconnection. For a comparable performance, the satellite e.i.r.p. requirements for AM-VSB transmission is of the order of 88-95 dBW. Digital modulation techniques, particularly 4- ϕ Coherent as well as noncoherent Phase Shift keying (4- ϕ CPSK and NCPSK), compare favorably, in both the bandwidth occupancy as well as

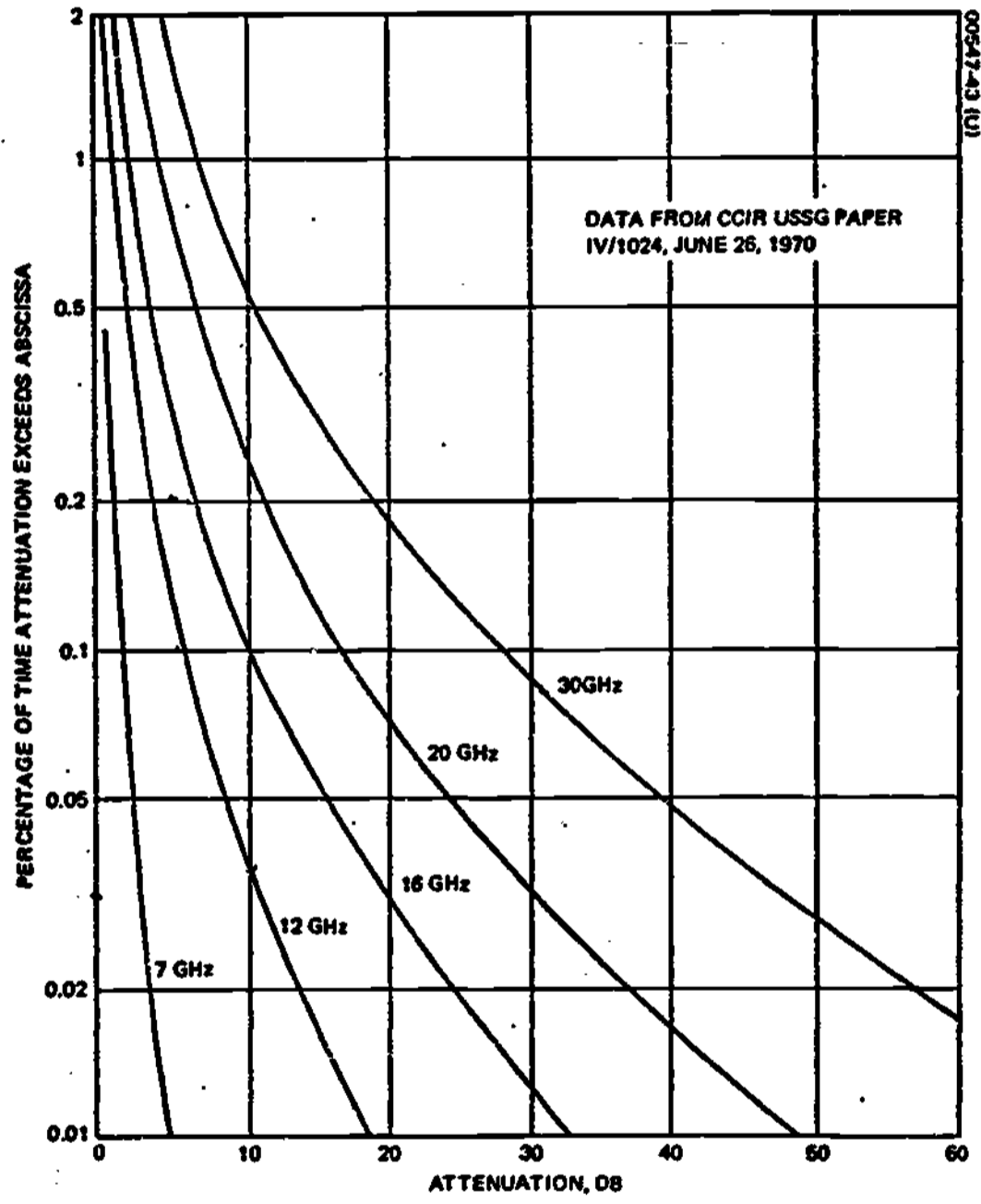
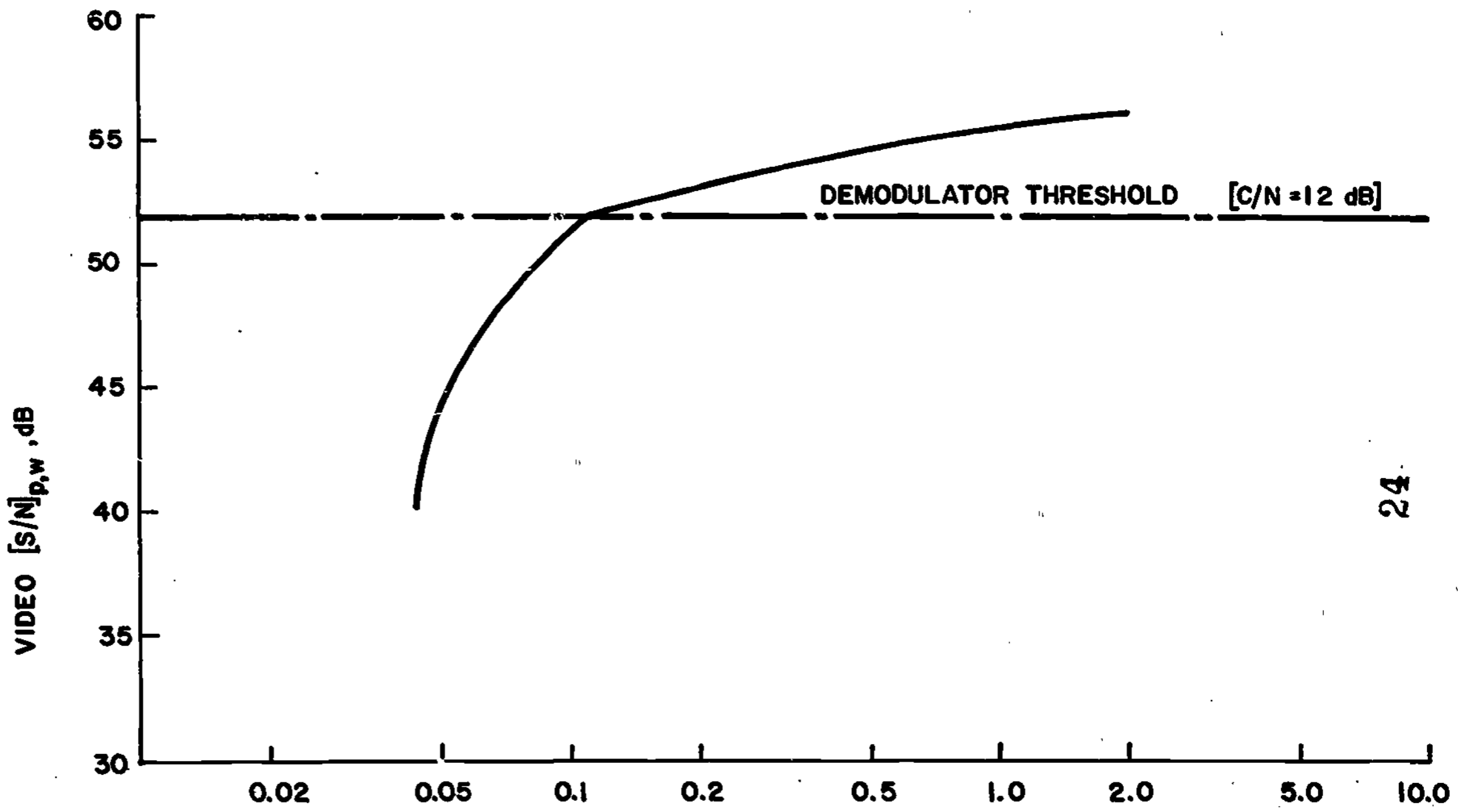

Fig. 2 - Rain Attenuation Probabilities in New Jersey



PERCENT OF TIME [S/N]_{p,w} IS BELOW ORDINATE
(FOR A LINK MARGIN OF 5.3 dB ABOVE THRESHOLD, B_{RF}/B_V = 7.15, AND B_{RF} = 30 MHz)

Fig. 3 - Video [S/N]_{p,w} Probabilities



the power requirements, with FM. However, for the near-term future their implementation is expected to remain costlier than that of the FM technique. Table 3 shows the bandwidth, and Carrier-to-Noise Ratio requirements for various digital modulation techniques for an error probability of 1 in 10^6 . An error probability of 1 in 10^6 represents a very high performance comparable to that represented by a 53 dB SNR in the case of analog methods. For the purposes of performance calculation a sampling frequency of 10 MHz and an eight-bit quantization is assumed giving a baseband bit rate of 80 Mb/sec. Calculations are also shown for the COMSAT's 2:1 digital color TV transmission scheme²⁸ that samples the TV waveform at rates less than that prescribed by Nyquist and uses the periodicity of the TV waveform to achieve smaller baseband bit-rate -- almost half (40 Mb/s) of the one with standard sampling. Eight-bit quantization was assumed because it provides a more desirable signal-to-quantization noise ratio (49.8 dB).

In case of Frequency Modulation (FM), the Radio Frequency (RF) bandwidth is defined by (when the modulating signal is a TV signal):

$$B_{rf} = 2 [B_v + \alpha \cdot \beta (\Delta f)] \quad (2)$$

where, B_v = Baseband Video Bandwidth (4.2 MHz for 525-line/30 frame system)

α = Sync peak-to-peak Video Voltage/Blanking-to-White Voltage (1.0/0.701 = 1.42)

β = Ratio of change in peak-to-peak frequency deviation ($2\Delta f$) of composite video modulation due to pre-emphasis.

The Signal-to-Noise Ratio (peak signal voltage to rms Noise) with the weighted noise $[S/N]_{p,w}$ is given by:

$$[S/N]_{p,w} = 3 [C/kTB_v] [2\Delta f/B]^2 \cdot W \cdot I \quad (3)$$

TABLE 3
SUMMARY OF THE BANDWIDTH AND CNR REQUIREMENTS FOR
DIGITAL MODULATION TECHNIQUES FOR A PROBABILITY OF ERROR OF 10^{-6}

	m-ary digital modulation method	W [Bandwidth] in MHz	E/N ₀ * (dB/Hz/bit)	[C/N] ₀ [†] dB	[C/T] ₀ ^{**} (dBW/°K)
Sampling Rate = 10 MHz 8-bit Coding R _b = 80 Mb/s	CPSK (m=2)	80	10.5	10.5	-139.1
	NCPSK (m=2)	80	11.3	11.3	-138.3
	CFSK (m=2)	120	13.8	12.0	-135.8
	NCFSK (m=2)	160	14.3	11.3	-135.3
	CPSK (m=4)	40	14.6	17.6	-135.0
	NCPSK (m=4)	40	16.4	19.4	-132.2
	CFSK (m=4)	100	14.4	13.4	-135.2
	CPSK (m=8)	27	18.8	23.6	-130.7
COMSAT 2:1 Digital TV Transmission System R _b = 40 Mb/s	CPSK (m=2)	40	10.5	10.5	-142.1
	NCPSK (m=2)	40	11.3	11.3	-141.3
	CFSK (m=2)	60	13.8	12.0	-138.8
	NCFSK (m=2)	80	14.3	11.3	-138.3
	CPSK (m=4)	20	14.6	17.6	-138.0
	NCPSK (m=4)	20	16.4	19.4	-136.2
	CFSK (m=4)	50	14.4	13.4	-137.2
	CPSK (m=8)	13.5	18.8	23.6	-133.7

*E/N₀ = Ratio of Wanted Energy per bit (E) to one sided Noise Spectral density (N₀). Determined by the desired error probability.

†[C/N]₀ = Downlink Carrier-to-Noise Ratio

$$= [E/N_0] \cdot [R_b/W]$$

where, R_b = Baseband Bit Rate (Bits/sec.), and

W = RF bandwidth, and

$$W/R_b = \begin{cases} r/\log_2 m & \text{for PSK} \\ (m-1+r)/\log_2 m & \text{for NCFSK} \\ 0.5 (m-1+2r)/\log_2 m & \text{for CFSK} \end{cases}$$

where, m stands for the level of modulation and r is the effect of pulse shape on the bandwidth. Theoretically, r=1 whereas in engineering practice r has a range of 1.5 < r < 2.0. For our calculations we have taken r=1. [See Ref. 13].

$$**[C/T]_0 = [C/N]_{dB} + k_{(in\ dB)} + W_{dB}$$

where, k = Boltzman Constant (-228.6 dB)

W = RF bandwidth (in Hz)

$$W \cdot I = [1/3 \cdot B_V^3] / \int_0^{B_V} f_V^2 [W(f_V)/p(f)] df_V \quad (4)$$

- where, C = Received Carrier Power
 k = Boltzmann's Constant
 W = Weighting Factor (For 525-line/30 frame system, the noise weighting factor has been designated as 7 dB for color signal and 10 dB for monochrome -- for FM modulation)
 I = Ratio of increase in weighted SNR by pre-emphasis
 f_V = Video Frequency
 $W(f_V)$ = Power transfer function of noise weighting network
 $p(f_V)$ = Pre-emphasis

The Carrier-to-noise ratio [C/N] at the receiver input is defined as:

$$[C/N] = C/kTB_{rf} \quad (5)$$

Combining (2), (3), and (4), we get:

$$[S/N]_{p,w} = [C/N] \cdot [W/\alpha^2]_{dB} \cdot [I/\beta^2] \cdot 3 \cdot [B_{rf}/B_V] \cdot [B_{rf}/B_V - 2]^2 \quad (6)$$

Writing everything in db's we get:

$$\begin{aligned} (S/N)_{p,w} \text{ (in dB)} &= [D/N]_{dB} + [W/\alpha^2]_{dB} + \\ &[I/\beta^2]_{dB} + 4.77 + [B_{rf}/B_V]_{dB} + 20 \log_{10} \\ &[B_{rf}/B_V - 2] \end{aligned} \quad (7)$$

We already know that $W = 7$ dB and $\alpha^2 = 3.05$ dB; hence $W/\alpha = 3.95$ dB. From the TRW report,²² we know that

$1/\beta^2 = 8.4 \text{ dB.}^*$ Hence, we could reduce (7) to:

$$[S/N]_{p,w} \text{ (in dB)} = [C/N]_{dB} + 17.12 + 10 \log_{10} [B_{rf}/B_v] + 20 \log_{10} [B_{rf}/B_v - 2] \quad (8)$$

where, $17.12 + 10 \log_{10} (B_{rf}/B_v) + 20 \log_{10} (B_{rf}/B_v - 2)$ is known as the FM improvement.

The following table shows the FM improvements for various B_{rf}/B_v 's.

B_{rf}	B_{rf}/B_v	$[S/N]_{p,w}$ in db
20 MHz	4.77	$[C/N]_{dB} + 32.74 \text{ dB}$
25 MHz	5.95	$[C/N]_{dB} + 36.78 \text{ dB}$
30 MHz	7.15	$[C/N]_{dB} + 39.9 \text{ dB}$
34 MHz	8.1	$[C/N]_{dB} + 41.9 \text{ dB}$
36 MHz	8.85	$[C/N]_{dB} + 42.82 \text{ dB}$

We have decided to choose a B_{rf} of 30 MHz as it provides an adequate FM improvement to meet the 53 dB SNR objective with a CNR of 13.1 dB. A lower B_{rf} would not provide enough FM improvement and would require a high CNR (16-17 dB) to meet the SNR objective whereas a higher B_{rf} would result in a waste of the rf spectrum -- an overdesigned system.

When the two aural subcarriers placed at 4.7 MHz and 5.5 MHz are also taken into consideration, the B_{rf} requirement is increased by a factor of 1.2 approximately. Thus a

* This accounts for the effect of pre-emphasis on the reduction in peak-to-peak frequency deviation by a factor of 1/2 as compared with frequency deviation caused by a non-pre-emphasized modulating TV signal as well as the increase in weighted SNR due to combined pre-emphasis-de-emphasis action.

30 MHz B_{rf} needed for transmitting a 4.2 MHz baseband with certain quality would have to be about 36 MHz to accommodate the two aural subcarriers.

Once the RF channel bandwidth occupancy has been decided (36 MHz per TV channel), the next question concerns the positioning of the individual RF carriers in the available RF spectrum (11.7 - 12.2 GHz). Positioning of the carriers or 36 MHz channels is dependent upon the branching filter-selectivity (trade-offs with respect to the filter cost and increased Envelope Delay at the band edges when small guard-bands are contemplated), the polarization scheme employed (single polarization transmission or the use of orthogonal polarizations to achieve increased communication capacity per MHz of the spectrum space--orthogonal polarization transmission in the same band either from the same satellite or from two adjacent low-capacity satellites), and the number of RF channels that are required. Carriers could either be placed adjacent to each other with some 40 MHz spacing or could be used to fill alternate 36 MHz slots (see Figure 4). Alternate spacing (Figure 4b) allows simpler branching networks whereas the adjacent placement (Figure 4a) demands a more elaborate branching network due to the finite bandwidth of microwave filters which must be designed for an envelope delay response which can be easily equalized at IF. At the IF a 3 dB hybrid is used to split the incoming 1000 MHz signal into two arms. The branching of contiguous carriers are allocated to separate arms. Adjacent positioning of RF carriers provides almost double the number of channels provided by the alternate spacing technique: 12 versus 7, assuming a 4-MHz spacing between channels in the case of adjacent spacing of the carriers.

Theoretically there is no difference in the communication capacity of the 11.7 - 12.2 GHz band with either technique;

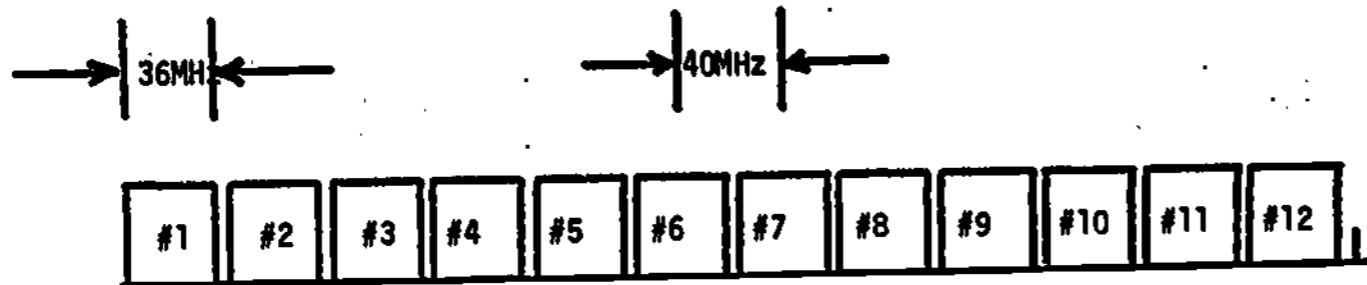

Fig. 4a - Adjacent Channel Spacing

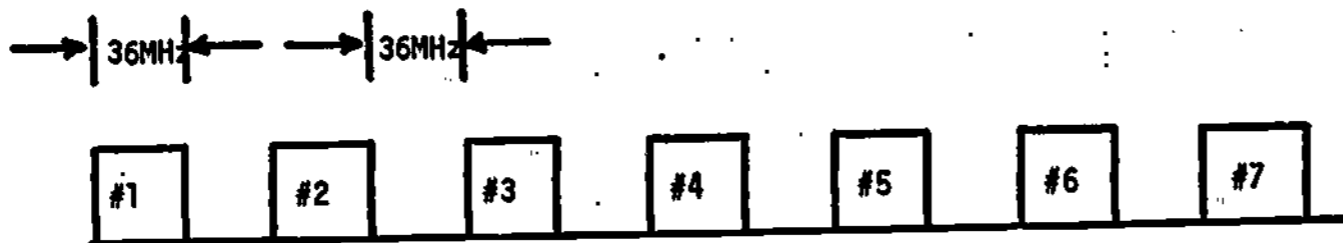
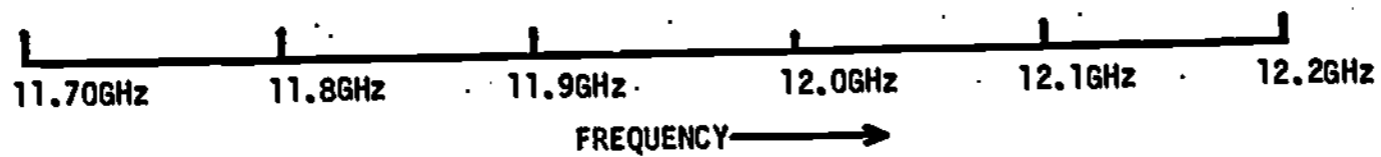

Fig. 4b - Alternate Channel Spacing



30

suitable combinations of satellites in the orbit, orthogonal polarizations and carrier staggering could be used in either case to provide the same communication capacity for the spectrum space. However, we have decided that the earth-terminal be designed for the case where RF carriers are placed 40 MHz apart, i.e., a 4 MHz guard band is provided between individual channels. The reasons for our choice were simple--CATV-Satellite interconnection would certainly require distribution of more than 7 TV program channels to the CATV headend when commercial and noncommercial requirements are viewed jointly, and reception of two 7-channel beams (same 500 MHz wide 11.7 - 12.2 GHz frequency band used by orthogonal polarization) would require two separate receive chains whereas with the technique we have opted (adjacent spacing of 12 TV program channels on a single 500 MHz wide beam) a chain of 12 TV programs could be received by a single receiver. However, to receive more than 12 TV program channels and up to 24, a second receive chain would be needed irrespective of whether the second beam is obtained through the use of orthogonal polarization, or a narrow beam antenna oriented towards a second satellite and providing enough discrimination against the co-channel signal from the first satellite, or through the use of another frequency band.

An important consideration in the downlink frequency planning is the choice of polarization--linear (horizontal and/or vertical), circular (clockwise and/or anticlockwise), or elliptical.³⁰⁻³² We have opted for linear polarization as it is cheaper to implement than either circular or elliptical. Circular polarization is created by combining equal magnitudes of vertically and horizontally polarized waves, with the phase of one exactly 90° ahead or behind the other. At 12-GHz, the rotation in the plane of the polarization caused by transmission through the ionosphere (known as Faraday rotation) is negligible and linear-linear polarization

combination (linear polarizations at the spacecraft transmitter as well as the earth-terminal) could be safely employed without any undue penalties in terms of power loss. In addition, the earth-terminals are of the receive-only type. One of the basic advantages of using circular polarization is that circulatory polarized radiation emitted from adjacent transmitters or back-scattered from reflecting layers in the atmosphere (rain, fog, clouds) is rejected.

At this point we would like to point out some of the implications of the use of orthogonal polarization on the design of the earth-terminal. There is little doubt that in the future orthogonal polarizations will be used to double the effective spectrum available, i.e., using the same spectrum twice over the same geographic region to carry two different sets of intelligence. Already some of the major domestic satellite applicants have proposed the use of orthogonal linear polarizations and have based link calculations on a typical 30-35 db isolation between the two orthogonally polarized beams. However, some recent exploratory experimental work at the Universities of Bradford and Essex on the effect of precipitation on mutual interference between linear cross-polarized radio channels and parabolic antennae at 11-GHz have brought some new problems to the attention of system designers--certain aspects that were either ignored or not carefully scrutinized so far.³³⁻³⁵ Watson et. al.^{33,34} have reported a 40 dB isolation between the co- and cross-polar signals under ideal conditions (dry weather, dry feed-aperture, and dry dish). However, a severe drop in the co- and cross-polar isolation due to water on antenna primary-feed apertures have been encountered (22 dB drop in isolation in the worst case). The depolarizing effect is more prominent when the feed is wet than when only the dish is wet; water on the parabolic reflector has little depolarizing effect (1 dB).

These results point out the fact that a radome would be needed to eliminate the depolarizing contribution from wet feed and dish; nothing could be done to reduce or eliminate the depolarizing contributions from falling snow which appears to constitute a significant--if not major--contribution to the depolarizing effect. This necessitates that the design of a suitable radome be an integral part of the ground-terminal design program and that extensive tests be carried out at 12-GHz to evaluate depolarization effects due to rain, snow, radome material, and multipath propagation.

Another aspect that needs investigation is the relationship between the antennae alignment (the arrival of waves at an angle to the principal axis of the receiving antenna) and crosspolarization. Watson et. al.³⁴ suspect significant crosspolarization even due to small misalignments. If the crosspolarization is really sensitive to the antenna misalignment and is appreciably large at even small angles (0.5-1.0°), it could have severe implications for the design of the satellite station-keeping sub-system and/or the ground/terminals at 12 GHz as steerable antennae may be needed to maintain proper alignment and compensate for the satellite motion.

2.5 Receiver System

In the previous three sub-sections we discussed the design parameters for the ground-terminal. In this sub-section we would attempt to translate the design parameters or requirements into a ground-terminal system.

We decided upon 36 MHz bandwidth per RF channel and a Carrier-to-Noise Ratio of 17.26 dB (or a Signal-to-Noise Ratio of 53 dB at the receiver output 99.8 percent of the time). As $[C/T]_D = [C/N]_D + k + B$ (in Hz), the CNR requirement and B_{rf} could be converted into $[C/T]_D$, the ratio of the received carrier power to the system noise temperature ratio. Accordingly, $[C/T]_D = -135.8$ dBW/°K, where subscript D denotes

downlink. The value of $[C/T]_D$ shows the trade-off between the satellite output power and the ground-terminal system noise temperature, for a given set of free - space path loss, polarization mismatch loss, circuit losses, and ground-terminal antenna gain. In turn, the receive-only ground terminal's noise performance could be related to the satellite weight (which determines its orbital placement cost) and cost. The following expressions provide a rough estimate (in linear terms) of the complex relationship^{*} between satellite weight and cost and power requirements:

$$SAT_{WT} = 440 + 245 \text{ lbs/kw}$$

$$SAT_{\text{Development Cost}} = 43 \text{ million} + 3 \text{ million/kw } \$$$

$$SAT_{\text{Unit Production Cost}} = 8.5 \text{ million} + 1 \text{ million/kw } \$$$

After carefully studying the tradeoffs for a 12-channel satellite interconnecting some 2,500 - 4,000 CATV headends, we conclude that a 1,400°K (approximate) system noise temperature is a near-optimal compromise between the satellite cost and the ground terminal costs. The selection of 1,400°K system noise temperature was also dependent upon the choice of a 10-ft. diameter antenna. A larger antenna would have a beamwidth narrower than the 0.5° beamwidth of the 10-ft. dish and would result in a tighter station-keeping requirement for the satellite in addition to disturbing the balance between the satellite and ground-terminal costs. It should be noted that a 10-ft. antenna and a 1,400°K noise temperature only indicate the near-optimal region in which the choice should be confined and not the final choice. We shall take these now as tentative system parameters and would revise them as new knowledge requires.

* Conversation with Dr. A. M. Greg Andrus, NASA Headquarters (April 1971).

Table 4 presents the satellite-to-earth power budget in view of the system requirements discussed above and in Sections 2.2 - 2.4. The spacecraft e.i.r.p. has been determined as 57.5 dBW assuming circuit losses in the spaceborne transmitter of the order of 1.5 dB, and polarization mismatch losses of 0.5 dB. Assuming a 4.5 ft diameter antenna on the spacecraft that provides a 1.5° beamwidth and a gain of 38 dB at 12 GHz, and e.i.r.p. of 57.5 dBW would require approximately 90 watts of RF power over 36 MHz bandwidth. For near-term systems (1974-76), these values are not impractical. NASA has already conducted two major studies regarding multiple-beam antenna pattern shaping and steering^{36,37} for high power transmissions from space that have shown the feasibility of narrow- and multi-beam antennae at 12.2 GHz for transmissions in the range of 1 kw per channel. A 200 watt tube would eventually be developed for the joint Canada-U.S. Applications Technology Satellite program that is scheduled for the same period. Hughes Aircraft Company has already developed a periodic permanent magnet (PPM) focused, CW (continuous wave), X-band TWT (759H) that provides 600 watts of power over a 150 MHz bandwidth. In brief, neither the antenna nor the channelized repeater with 90 watts per channel output RF power pose any unmanageable technical problems. Assuming 40 percent transponder efficiency (based on 50 percent TWT efficiency), the total DC raw power requirement for 12 channel operation is of the order of 2.7 kw. However, this amount of DC power requirement is achievable through the use of sun-oriented flexible solar cell arrays. MCI-Lockheed Satellite Corporation has already proposed the use of a 4.4 kW solar cell array for its satellite for the domestic system.

The next task is to devise a ground-terminal to meet the 1,400°K system noise and sensitivity requirements. Figure 5 shows the way we propose to realize it. The gain, loss, and noise figure value for the various system components

TABLE 4
SATELLITE-TO-EARTH POWER BUDGET

Spacecraft e.i.r.p.	+ 57.5 dBW
Circuit Losses	- 1.5 dB
	+ 56 dBW
e.i.r.p. at the Beam-Edge	+ 53 dBW
Free Space Path Loss	- 205.8 dB
Polarization Mismatch Losses	- 0.5 dB
Receiver Antenna Gain [10-ft dish; 54% efficiency]	+ 48.98 dB
Total Signal Power	- 104.32 dBW
Power-Flux density reaching Earth at beam edges	- 109.1 dBW/m ²
Boltzmann's Constant	- 228.6 dBW
Bandwidth (36 MHz)	+ 75.5 dB
Receiver Noise Temperature [T _{System} = 1400°K]	+ 31.46 dB
Total Noise Power	- 121.58 dBW
Received Signal-to-Noise Ratio	+ 17.26 dB
dB's above FM threshold	+ 5.26 dB

represent current state of the art. The mixer realization is proposed with a microstrip single ended mixer (an 11 dB noise figure at 12 GHz). However, it seems that orthomode "T" waveguide balanced mixer can provide a significantly lower noise figure (6.5 - 7 dB). We propose to experiment with it along with our work on the microstrip mixer. If said performance (6.5 - 7 dB) is achieved for the orthomode "T" mixer, the satellite RF output power requirement could be reduced by a factor of 0.57 dB or to 75 watts per 36 MHz channel. The next section will discuss various subsystem/component options in detail.

Out of the 1,400°K system noise temperature, 200°K has been allocated to the antenna [T_A] and 1,200°K to the receive chain [T_R]. A 200°K antenna temperature allocation is for the worst case (at almost horizontal elevation). Using the well known expression for the noise temperature of networks in cascade, the receive chain noise temperature contribution is given by (for the performance given in Figure 5):

$$\begin{aligned}
 T_{\text{Receiver}} &= [T_1 + \frac{T_2}{G_1} + \frac{T_3}{G_1 G_2} + \frac{T_4}{G_1 G_2 G_3} + \frac{T_5}{G_1 G_2 G_3 G_4} \\
 &\quad + \dots] \\
 &= [13.6 + 640/0.95 + 3500/14.12 \times 0.955 \\
 &\quad + 640/14.12 \times 0.955 \times 0.25 \times 14.12 + \\
 &\quad \dots] \\
 &\approx 1200^\circ\text{K}
 \end{aligned}$$

$$\begin{aligned}
 T_{\text{System}} &= T_{\text{Antenna}} + T_{\text{Receiver}} \\
 &\approx 200^\circ\text{K} + 1,200^\circ\text{K} \approx 1,400^\circ\text{K}
 \end{aligned}$$

These calculations show the need for low-level (15 dB or so) RF preamplification before the mixer stage. Without an RF preamp, the line losses (line connecting the feed and the mixer) and the mixer noise figure dominate the receiver

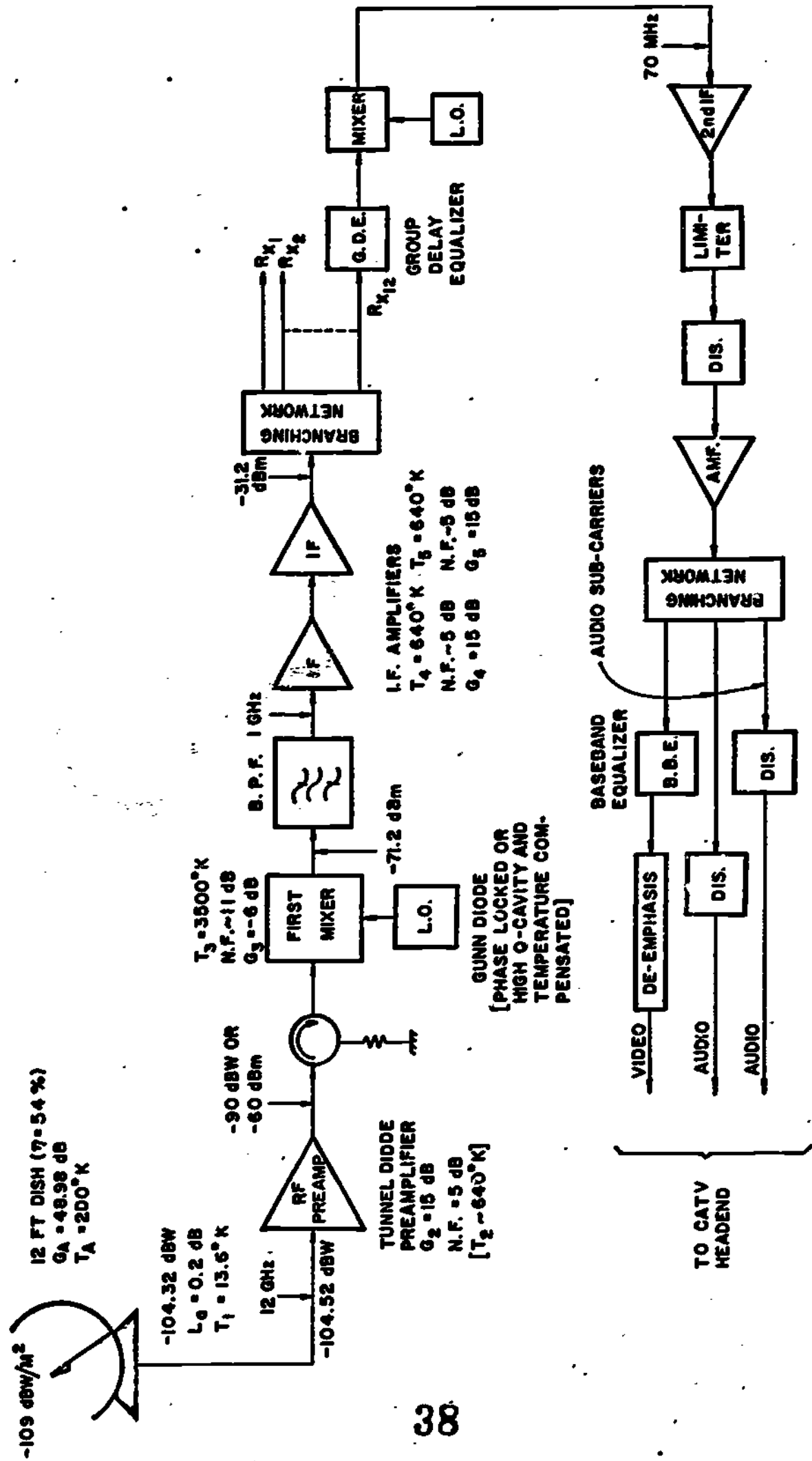

Fig. 5 - Earth-Terminal Block Diagram



noise contribution and a 1,200°K noise figure realization becomes extremely difficult. We are contemplating a single tunnel diode preamp before the mixer stage with 15 dB gain and 640°K noise temperature--even a small (15 dB) amplification nullifies some of the severe restraints of the line loss and a high mixer noise figure.

We are proposing a double conversion receive chain--first conversion to 1 GHz and the second to 70 MHz. Single conversion, direct to 70 MHz IF, has been the standard practice in terrestrial radio-links. Here the disadvantage lies in the fact that due to the 500 MHz wide Frequency Division Multiplexed spectrum that is to be received, the channel branching would have to be achieved before the conversion--something which is a difficult problem as at 12 GHz, 40 MHz wide filters would be extremely difficult to design with delay distortions that could be equalized easily and cheaply prior to demodulation. The filters would have to have a narrow pass band (0.33 percent bandwidth-- W/f_c) and must possess a large loss at this separation. At 1 GHz, the percentage bandwidth of channel separation filters would be something like 4 percent. In addition, with a dual conversion scheme and the branching network where adjacent channels are separated in two different and isolated arms, the passband band-edge attenuation requirements for 1 GHz channel separation filters could be eased and the necessary discrimination against adjacent channel contributions could be realized with 70 MHz IF filters with ease and less cost.

Another important consideration in the receive chain design is related to the stability of the local oscillator. For AM-VSB color signals, the overall tuning stability of the order of 100-200 kHz is needed. However, for a wideband FM system, and particularly one with a common local oscillator in the first conversion for all incoming channels, the L.O.

stability is not that critical and it seems that an overall channel stability of ± 0.750 MHz would not cause any impairments. Of this, one could allocate some ± 100 kHz to the second L.O. operating at approximately 1 GHz and the remaining to the first L.O. operating at approximately 11 GHz. This means a stability of some 1 part in 10^4 for both oscillators. However, the first L.O. should be capable of delivering only a few milliwatts of power to the converter and yet meet the stability criterion of ± 650 kHz; for a large input to the converter there will be serious intermodulation as the first mixer handles 12 FDM 36 MHz wide channels simultaneously. These are conflicting requirements and the options to meet them are yet to be completely explored. In the past, people have devised intricate schemes for maintaining adequate stability of the local oscillator, particularly the one at 11 GHz, such as locking it to a separately transmitted pilot carrier in the case of 18 GHz Amplitude Modulated Links (AML).³⁸ It seems that Gunn Diodes, with a high-Q factor cavity and temperature compensation, would probably satisfy our requirements. In case they fall short of it, we propose to use a novel phase-locked Automatic Frequency Control (AFC) technique that has been implemented and tested successfully at our facilities⁸ and that will be described in detail in a forthcoming section.

Table 5 gives the design parameters for the earth station discussed in this section.

TABLE 5

SATELLITE GROUND-TERMINAL CHARACTERISTICS

Ground Terminal Type	Receive Only
Antenna	10-ft parabolic dish. Limited manual steering
Antenna Gain	48.98 dB at 12-GHz 54 percent efficiency.
Antenna Polarization	Linear
Antenna Noise Temperature [T_A]	200°K (Maximum)
Low Noise Receiver	Tunnel Diode Preamplifier followed by a mixer (micro- strip or orthomode "T"). Double Conversion - First IF at 1 GHz and the second at 70 MHz Channel Separation after 1st IF.
Receiver Noise Temperature [T_R]	1,200°K (Maximum)
Receiver Bandwidth	11.700 - 12.200 GHz
Individual RF Carrier Bandwidth (per TV Channel)	36 MHz
Modulation	Frequency Modulation
Demodulator	Discriminator (12 dB Threshold)
Receiving System Noise Temperature [$T_S = T_A + T_R$]	1,400°K
Receiving System [G/T] [Antenna Gain to System Noise Temperature Ratio]	17.52 dB/°K
<u>Downlink Channel Requirements</u>	
Differential Gain (Baseband)	1.0 dB
Differential Phase (Baseband)	3.0 degrees
Envelope Delay Distortion	
Coarse Structure Delay	± 25 ns
Fine Structure Phase	± 0.8°

3. IMPLEMENTATION OF MULTI-CARRIER RECEIVER

3.1 Introduction

Design and development of the 12 carrier 12 GHz receiver diagrammed in Fig. 5 is now proceeding. Currently the effort has centered around the realization of the front end which includes the mixer, the local oscillator and required filtering. Subsection 3.2 will detail results to date in this area. Design approaches for the branching network, the second mixer and the second L.O. also will be described.

The ultimate performance of a receiver is completely specified by its noise figure or, equivalently its noise temperature.³⁹ The noise figure is defined as

$$F = \frac{\frac{S_{ia}}{N_{ia}}}{\frac{S_{oa}}{N_{oa}}} = \frac{1}{G_a} \frac{N_{oa}}{N_{ia}}$$

$$\text{and } G_a = \frac{S_{oa}}{S_{ia}}$$

where G_a is the available power gain of the network, S_{oa} , S_{ia} are the available output and input signal powers, respectively, and

$$N_{oa} = kT_1 B$$

$$N_{ia} = kT_0 B$$

are the available output and input noise powers, respectively with

k = Boltzmann's constant

B = effective Bandwidth

T_0 = 290°K, standard noise temperature

T_1 = noise temperature of output resistor of network

The noise figure of an attenuator operating at 290°K is equal to its loss L. At any other temperature its noise figure is

$$F_L = L \frac{T}{T_0}$$

Since a mixer is not a passive device, its effective noise temperature is usually different from that of the surrounding environment. Thus, if L_c is the conversion loss of the mixer, i.e., the ratio of the signal power at the down converted frequency to the incident signal power, then the mixer noise figure is

$$F_M = L_c N_R$$

Here N_R is the ratio of the mixer effective noise temperature to the standard noise temperature. It is called the noise ratio.

The total noise figure of a network is given by

$$F = F_1 + \frac{F_2^{-1}}{G_1} + \frac{F_3^{-1}}{G_1 G_2} + \dots + \frac{F_n^{-1}}{\prod_{i=1}^{n-1} G_i}$$

where F_n is the noise figure of the n^{th} stage and G_n its gain. The noise figure for our down converter is

$$F = L_{RF} + \frac{L_c N_R^{-1}}{\frac{1}{L_{RF}}} + \frac{F_{if}^{-1}}{\frac{1}{L_{RF} L_c}}$$

$$= L_{RF} L_c (N_R + F_{if} - 1)$$

L_{RF} = input RF losses

F_{if} = noise figure of IF amplifier

Because the signal source is a satellite the effective antenna temperature is quite low. For this reason the receiver noise temperature is a more reliable measure of receiver performance than is its noise figure. Once the noise figure is known, the receiver noise temperature is found from

$$T_e = (F-1) T_o$$

This expression is valid for single frequency reception. However, in a wideband receiver F may well be a function of frequency.

Before the down converter is described in detail we list the definitions used throughout this report.

$$\omega_s = 2\pi f_s \text{ signal radian frequency}$$

$$\omega_{LO} = \text{local oscillator frequency}$$

$$\omega_{IF} \left\{ \begin{array}{l} = \omega_s - \omega_{LO} \\ = \omega_{LO} - \omega_I \\ = \omega_\Sigma - 2\omega_{LO} \end{array} \right\} = \text{intermediate frequency}$$

$$\omega_\Sigma = \omega_s + \omega_{LO} = \text{sum frequency}$$

$$\omega_I = 2\omega_{LO} - \omega_s = \text{image frequency}$$

3.2 Down Converter Design

The purpose of the down converter is to receive the incoming signal spectrum, a comb of 12 microwave carriers centered near 12 GHz and separated by 40 MHz, and to translate this comb to a 1 GHz center frequency. This is accomplished using the classical superheterodyne technique of mixing the

incoming spectrum with a local oscillator (L.O.) in order to develop difference frequencies ($\omega_s - \omega_{LO}$) in the required low frequency band. The efficiency at which this conversion may be accomplished depends on the noise figure and conversion loss of the mixer diode and its related filter networks.

Figure 6 shows a schematic diagram of the overall front end. The signal and local oscillator frequencies are introduced to the mixer via waveguide inputs. Waveguide was chosen in order to be compatible with the concept of connecting the down converter close to or at the receive antenna to avoid transmission losses in the low level input signal. In addition, the high pass filter characteristics of waveguide provide some measure of spurious frequency rejection. A commercial waveguide tunnel diode amplifier was identified in case additional microwave gain was found to be required. The down converter could then be conveniently cascaded with the tunnel diode amplifier output port.

Past experience with Gunn effect local oscillators has shown that for a highly stable, low noise output the oscillator must be implemented with a high Q resonator⁸. At X-band frequencies a waveguide cavity oscillator represents the appropriate choice. Thus the L.O. input is also in waveguide.

It was decided to realize the signal distribution and filtering requirements in a planar microwave waveguide, namely microstrip. It was felt that a significant reduction in the size of the down converter could be accomplished in this way as well as a potential cost advantage in volume production once it is optimized. Rectangular waveguide-to coaxial waveguide-to microstrip-transitions were designed and fabricated. These transitions exhibited a return loss of better than 18 db (VSWR = 1.3) over the band 11.3 GHz to 12.4 GHz. The insertion loss of each transition is approximately 0.25 db.

46

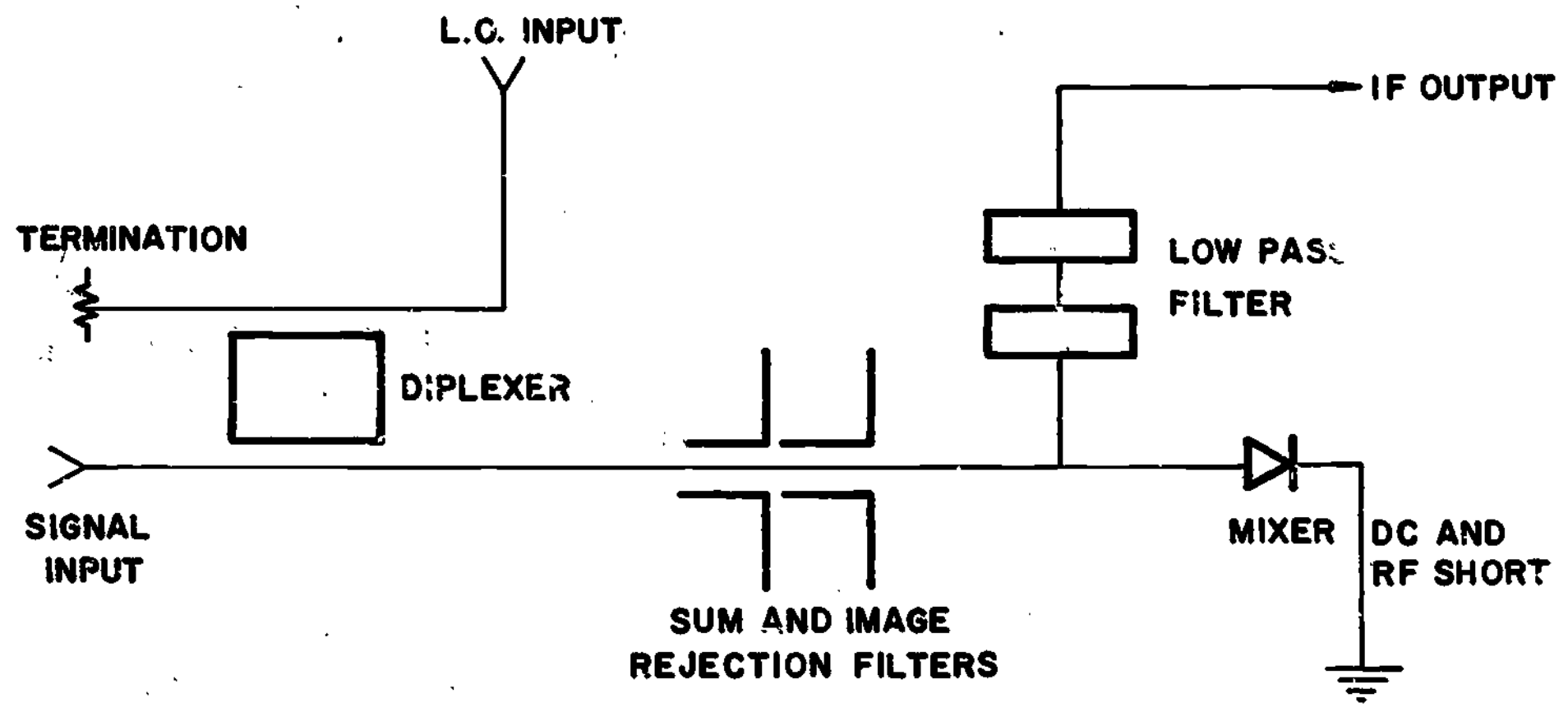

Fig. 6 Front-end Mixer Schematic

A photograph of the down converter package is shown in Figure 7. The microstrip mixer network is located in the well visible in the center of the package.

Returning to Fig. 6, the local oscillator power is coupled through a traveling wave directional filter⁴⁰ onto the signal input transmission line. A sampling port is available at the local oscillator to allow its frequency and power level to be measured and to provide an L.O. signal in the event that an Automatic Frequency Control (AFC) loop is found to be necessary to stabilize the local oscillator. This will be discussed further in subsection 3.2.3.

Another significant design feature is the use of a field replaceable mixer diode. We feel that if this type of down converter is to find wide application in its intended market it must be highly reliable. Repairs, particularly diode replacement, must be quickly achieved, with as little down time as possible. Furthermore beam leaded diodes permanently bonded to the microstrip board such as those used in sophisticated mixers cannot be replaced easily, and certainly not without expensive equipment and highly trained personnel. On the other hand, cartridge type mixer diodes could be replaced quickly and inexpensively by the head end operator. It is not expected that this will be a frequent occurrence, but it should not be overlooked altogether.

The detailed design of the down converter and results to date are described in the following subsections.

3.2.1 Mixer Design

A single ended (single diode) mixer was chosen as the first cut design as a result of the following considerations. Firstly, to ease the signal branching network design a low microwave IF frequency appeared desirable (~ 1 GHz). Thus the $\frac{1}{f}$ noise of the crystal is not particularly significant.



Fig. 7 - Down Converter Package

Secondly the AM noise of commercial Gunn effect local oscillators is sufficiently low that no obvious advantage is gained by going to a balanced mixer configuration. In this way the front end design might be simplified.

For development purposes a cartridge type silicon point contact mixed diode, Microwave Associates 1N23E was chosen. Its advertised performance in the high X-band is: Maximum Noise Figure, 7.5 dB, Maximum Conversion Loss, 5.0 dB; Maximum VSWR, 1.3:1. A 50 Ω coaxial mount was designed for this diode. The mount was tested and it was found that additional microwave impedance matching was required to obtain adequate performance over the band 10.4 GHz to 12.4 GHz. A return loss of about 10 dB (VSWR = 2:1) was obtained when tuning screws were added to the mount.

The design was reevaluated and some changes made which have been implemented in the down converter package but not yet tested. In this package the diode is both dc and RF grounded to the case. In the coaxial test mount the diode was dc grounded with a fine wire leading from the center conductor to the outer conductor. RF bypassing was accomplished by using 0.005" mylar tape on a washer in pressure contact with one terminal of the diode. This proved to be inadequate since changes in the pressure affected both the input match and the amount of RF feeding through.

The noise figure and conversion loss for a 1N23E Silicon mixer diode were measured in the coaxial test mount. Preliminary measurements indicate a conversion loss of 5.7 db and noise ratio of 4 db at 30 MHz. These quantities could not be measured at the IF frequency of interest (1 GHz) since no amplifier is currently available to us in this band. It will be necessary for us to upgrade both our techniques and our apparatus in this IF band as the work progresses.

A relatively low cost Schottky Barrier mixer diode has been identified which will be evaluated in the down converter

package. It is the MA-40071E with the following advertised performance: Max Noise Figure, 7.5 dB; Conversion Loss, 6.0 dB; Max VSWR 1.5:1.

One problem area yet to be investigated is to provide the mixer diode with the appropriate IF impedance for optimum noise figure. The manufacturer's suggested IF impedance is in the range 335-465 Ω . However our microstrip transmission system is 50 Ω as is the input impedance to the wide band transistor amplifiers being considered as the first IF amplifier. One approach may be to locate the IF output low pass filter close to the diode and design it for an input impedance in the required range. Our first attempt, however will be to measure the performance in a 50 Ω system.

3.2.2 Microstrip Filters

The microstrip circuit must provide the following functions. Firstly, the signal and the L.O. must be diplexed and brought to the single ended mixer. Secondly, the sum and image frequencies must be properly terminated to recover their energy in order to enhance the mixer noise figure. Finally, the IF signal must be properly terminated and coupled to the first IF amplifier.

For the diplexing function a traveling wave directional filter⁴⁰ was chosen. Figure 8 shows a photograph of a photolithographic mask used to fabricate a test filter. The loop is a high impedance structure one wavelength long at the L.O. frequency (11 GHz). The local oscillator signal should suffer a -7 dB insertion loss with a 20 db directivity when measured on the coupled arm. The signal frequency (\approx 12 GHz) is not coupled strongly into the L.O. arm.

An experimental diplexer was built and tested. The design included an attempt to match gradually into the high impedance lines with tapered sections. This resulted in a

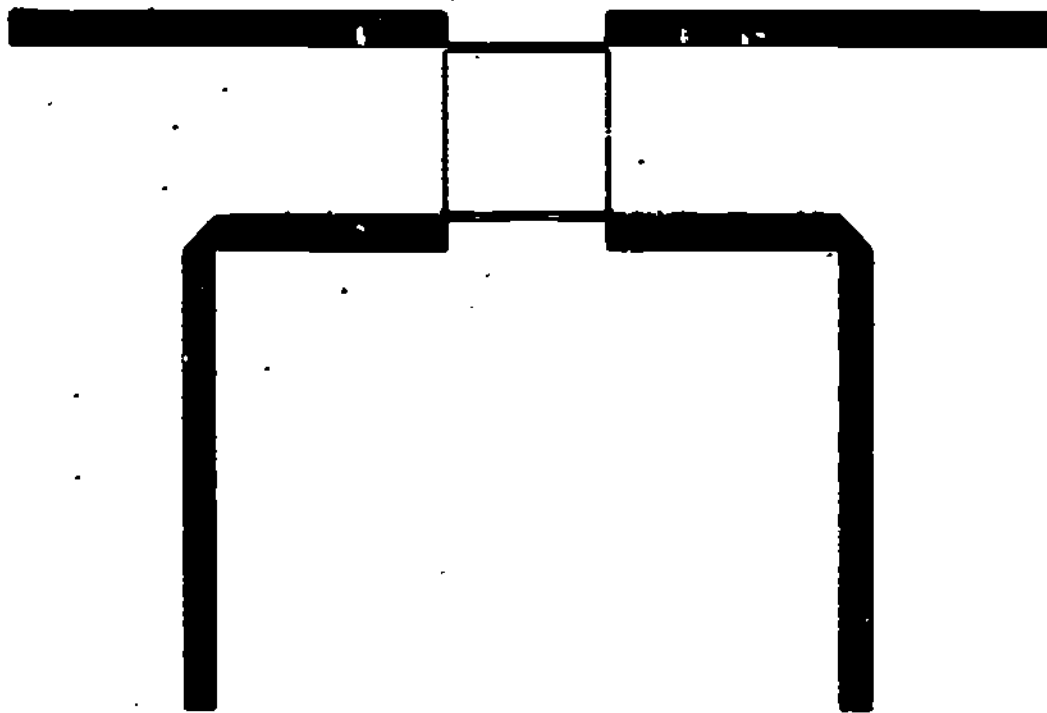

Fig. 8 Photograph of Traveling Wave Directional Filter Mask.
The Design Frequency is 10 GHz.

low directivity coupler and so was abandoned. The diplexer was redesigned and is now undergoing test.

Several low pass filters were evaluated and a design chosen. Two are shown in Fig. 9. The cutoff frequencies of the filters were chosen at $f=4$ and 10 GHz, respectively. At the signal and L.O. frequencies we desire an insertion loss of about -20 dB. Test circuits have been fabricated and are now being measured. A dc block will most likely be incorporated in this filter to dc isolate the IF amplifier from the mixer diode.

Two versions of the sum and image rejection filters have been designed. These filters are principally half-wavelength open circuited resonators coupled for a quarter wave length along the signal transmission line. (See Fig. 10) The placement of this filter relative to the input of the mixer diode is an important consideration since the reflected sum and image signals must be returned to the diode in the appropriate phase to be down converted and to add their energy to the IF signal. We intend to evaluate the mixer and down converter without this filtering in our first cut effort.

Computer programs have been developed to aid in the analysis of our experimental filters. When the prototypes have been finalized it is our intention to model the entire signal network to obtain the optimum theoretical response.

3.2.3 Local Oscillator

A commercial Gunn effect waveguide cavity oscillator was selected as the L.O. (Monsanto VX 14145). The unit is mechanically tunable from 11.5 GHz to 15.5 GHz and delivers about 25 mW over this band. The bias requirements are about 10 volts dc, at about 700 mA. The FM and AM noise characteristics of this oscillator are quite good. Figure 11 shows the RMS frequency deviation in a 100 Hz bandwidth as a function



Fig. 9 - Photograph of Low Pass Filters. The Upper Filter Has Its Cutoff Frequency at 4 GHz, the Lower One at 10 GHz.

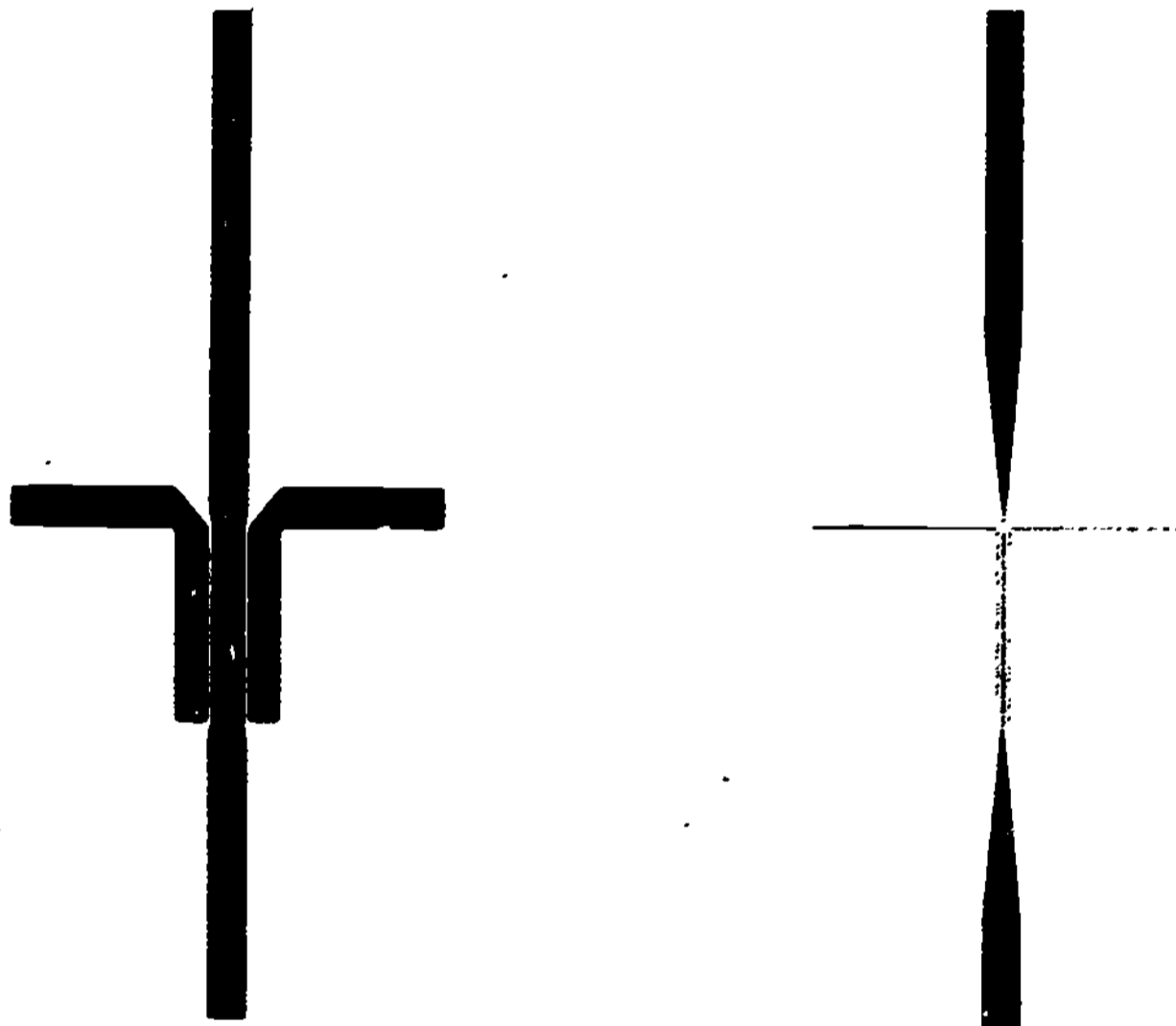

Fig. 10 Photograph of Rejection Filter Masks. Although Both Designed for 10 GHz the Right One Should Exhibit Greater Rejection at 10 GHz at the Expense of Slightly Higher Signal Attenuation.

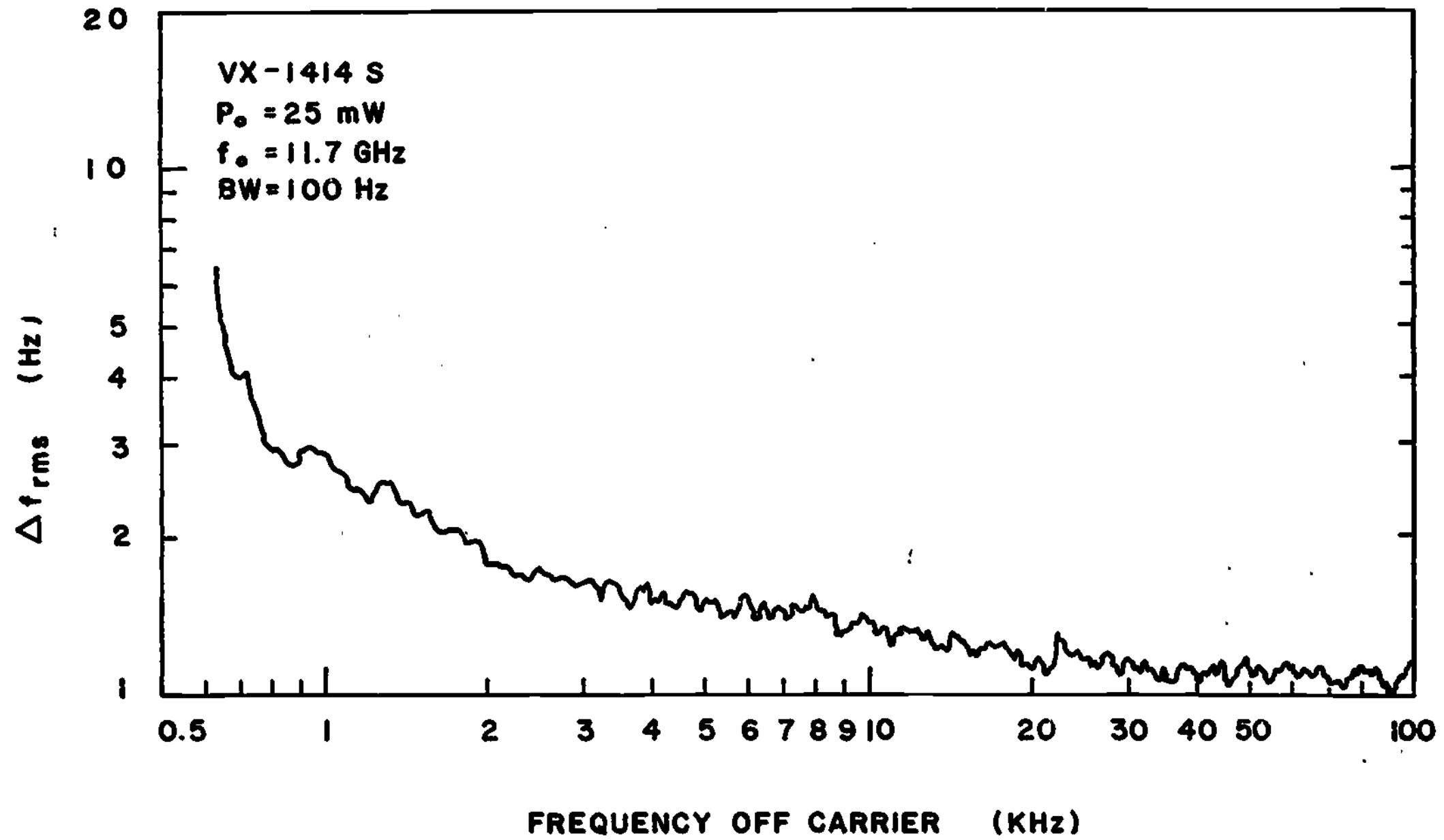

Fig. 11 Experimental FM Noise Performance of Gunn Diode Local Oscillator.

of frequency deviation from the carrier. This experimental result was supplied by the vendor. Notice that as close as 700 Hz to the carrier $\Delta f_{\text{rms}} \leq 4 \text{ Hz}$.

The long term stability of the oscillator has not been measured carefully, but a preliminary measurement using a spectrum analyzer has been made. Fig. 12 shows the oscillator spectrum at a center frequency of 13.2 GHz. The horizontal scale is 20 KHz/div. The temperature drift of this class of oscillator is about 300 KHz/°C. Once the oscillator achieves its stable operating temperature it is expected that the short term stability should be at least 5 parts in 10^6 . This is not expected to be a major source of phase error in the system.

In the event that greater stability is required it is possible to make use of the frequency sensitivity of the Gunn diode to bias voltage to achieve AFC. This technique has been demonstrated in this laboratory.⁸ When frequency locked to an external 5 MHz crystal controlled oscillator the stability of a test cavity oscillator was better than 1 part of 10^7 , namely the stability of the crystal controlled source.

3.2.4 1 GHz IF Amplifier

After being down converted, the 500 MHz band of information, centered around 1 GHz, must be reamplified. We anticipate a signal level at the input to this amplifier of about -71 dbm. The branching network will have to split the 12 channels and distribute each channel to the appropriate second IF stage. In order to accommodate the power division and transmission losses of the branching network approximately 30 to 40 db of IF gain is needed.

Two commercial broadband amplifiers are available which could be used for this purpose. One is Hewlett Packard's Wideband Preamplifier, Model 35007A, with a bandwidth of 900 MHz, center frequency of 850 MHz, noise figure 5-6 db and 20

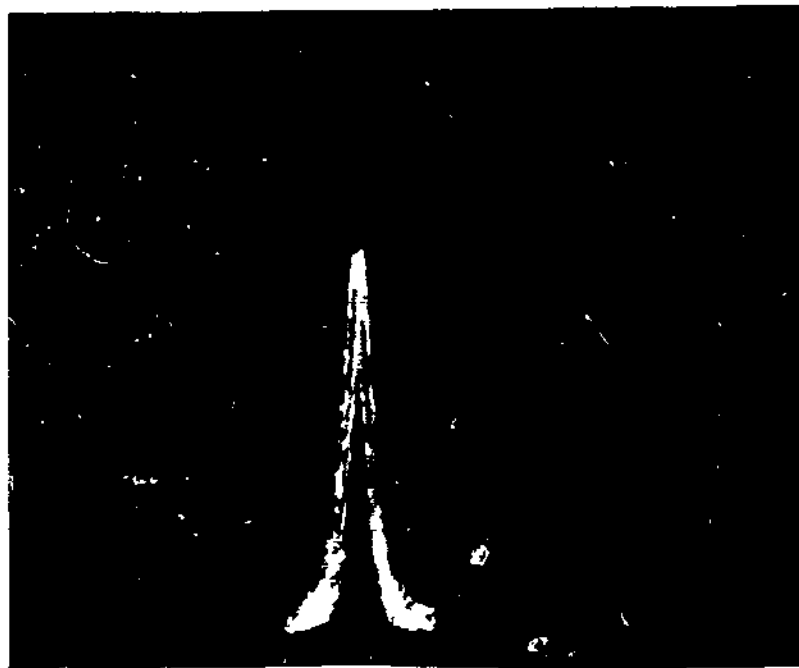

Fig. 12 - Center Frequency 13.2 GHz
Horizontal Scale 20 KHz/Div.
Exposure Time 1/15 Sec.

db of gain. Avantek's Thin Film Amplifier series AMT-2000 has a bandwidth of 1900 MHz centered at 950 MHz with a noise figure of 6 db and gain up to 50 db. The main advantage of the Avantek unit is that high gains are obtained in a single package with a lower overall noise figure than that which would be obtained by cascading two HP amplifiers. An exact determination of the IF gain requirement depends on the design of the branching network and the second IF.

We expect to utilize some of the experience and results of the UHF work underway at NASA Goddard under the direction of Mr. J. Miller. It is possible that some of their designs at 860 MHz can be adapted directly, particularly to the second mixer and L.O. work suggested in Section 3.3.6.

3.2.5 Branching Network

The purpose of the branching network is to separate the comb of 12 individual signals into independent channels and to distribute these to the appropriate second mixer and IF amplifier. A candidate design⁴¹ for this branching network is shown in Fig. 13. The first IF is split into two equal amplitude signals by a wideband 3 dB hybrid. Each of these signals is again divided by identical 3 dB hybrids. The signal level in each path has now been reduced by 6 dB. Notice that only three individual channels are dropped on each line. In this way the design of the band pass filtering required to reject any unwanted signals from the second mixer is greatly simplified.

These filters will probably be implemented in microstrip or stripline on low dielectric constant substrates. They may take the form of traveling wave resonator directional filters⁴⁰ or more conventional bandpass filters (For example see Matthai, Young, and Jones, Chapter 8, Ref. 40). Filter characteristics with 3 dB bandwidths of 36 MHz centered between 750 MHz and

1.250 MHz appear to be achievable, although at the cost of some considerable insertion loss, perhaps as much as 3 dB. Thus a reasonable estimate of the transmission loss of the branching network is about -10 dB per channel.

The advantage in using a branching network of the type indicated in Fig. 13 lies in the fact that for wideband FM the high frequency components near the edge of the passband can be distorted without losing the analog information. Since the roll off of the filter characteristic will in general not be sharp enough to reject information from the adjacent channels this rejection must be accomplished in the second mixer and its final IF amplifier. It is anticipated that this second IF will be chosen at 70 MHz. Additional filtering will likely be required around the second IF to keep the spurious signals at an acceptable level.

Ferrite isolators and circulators in the L-Band will be required to distribute the signals and to isolate the other channels from mismatch at the individual mixers, second L.O. leakage, and spurious signal sidebands generated at the mixers.

The branching network design and development constitutes a major engineering effort in the total project. It is expected that about one man year of effort would be needed to establish design alternatives, to test them, to finalize the design and to build and test a 12 channel version. If it is determined that our down converter design effort should be extended to include the branching network most likely we would attempt a three or four carrier feasibility model, rather than the entire 12 channel ground terminal.

3.2.6 Second Mixer and Local Oscillator

After branching, the 12 individual channels are available at the inputs to the second mixers. An example of a possible frequency plan is shown in Table 6. Most likely the mixers

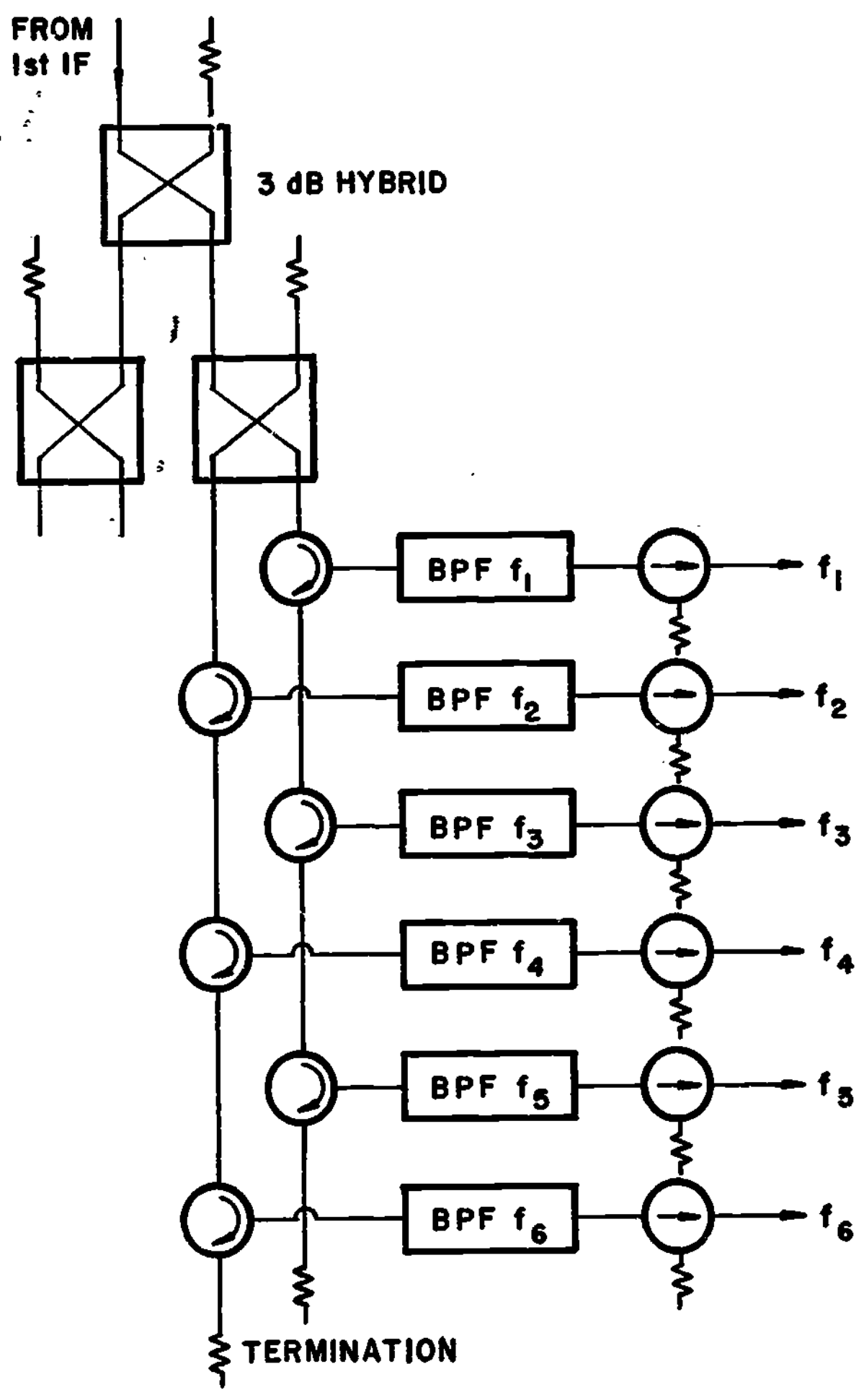

Fig. 13 Branching Network

will be implemented in microstrip or stripline since the signal frequencies are between 750 MHz and 1.190 MHz. It is expected that the design and development of the 12 mixers will proceed without unusual difficulty. Since the signal levels are now somewhat more advantageous (-41 dBm) it is not felt that extremely low noise mixers with sum and image enhancement will not be needed and that conventional techniques should suffice.

The development of the required comb of local oscillator frequencies, however, provides an interesting engineering challenge. At least four distinct alternatives present themselves to develop the milliwatt power level needed at each of the second L.O. frequencies shown in Table 6. These are:

- a) direct multiplication from a fixed frequency crystal controlled oscillator.
- b) multiplication and mixing.
- c) comb generator using snap-off diodes and narrow band RF amplifiers as required.
- d) direct generation using transistor oscillators.

Each approach has some feature in its favor. For example, direct multiplication gives a frequency comb which is phase locked to the low frequency crystal oscillator whose stability can be made extremely high by controlling its temperature. However since our downlink employs wideband FM there is no need to maintain any phase coherency between individual channels. Moreover such an approach would probably be quite costly. (Similar comments apply for approach b.)

In a continuing program we would evaluate paper designs of these four approaches and appropriate combinations to identify the cost-effective solution. A feasibility model would be fabricated and tested.

TABLE 6
POSSIBLE FREQUENCY PLAN

<u>Carrier No.</u>	<u>Frequency in GHz</u>	<u>First IF (L.O. 11 GHz) in GHz</u>	<u>Second L.O. For 70 MHz IF in GHz</u>
1	11.750	0.750	0.680
2	11.790	0.790	0.720
3	11.830	0.830	0.760
4	11.870	0.870	0.800
5	11.910	0.910	0.840
6	11.950	0.950	0.880
7	11.990	0.990	0.920
8	12.030	1.030	0.960
9	12.070	1.070	1.000
10	12.110	1.110	1.040
11	12.150	1.150	1.080
12	12.190	1.190	1.120

A cursory examination of the alternatives indicates that a common broadband mixer design could be used for each channel as well as an identical second IF amplifier, limiter, discriminator, video detector chain. The IF amplifier would need a center frequency of 70 MHz and a bandwidth of about 40 MHz.

4. FUTURE WORK AND PROPOSED RESEARCH AREAS

The intent of the current effort was to explore existing microwave techniques which might be useful in developing the multi-carrier down converter package. It is providing us with a learning experience as well as giving us the tools to evaluate the receiver. The down converter package also gives us a test vehicle to answer some of the following questions.

- a) How much intermodulation (IM) distortion will result from the simultaneous mixing of many wide-band FM carriers in a single mixer?
- b) How much IM is tolerable?
- c) What are the local oscillator stability and noise requirements in a multi-carrier system?
- d) Can a fundamental frequency LO meet these requirements?
- e) What is the temperature performance of the down converter?
- f) Is a single ended mixer adequate?

There are several other research and development problems to be considered before a complete ground terminal can be designed. We would like to implement and test a waveguide version of the down converter using an Orthomode Tee* as the balanced mixer. The sum and image enhancement filters could be fabricated as part of the mixer. The local oscillator now on hand would be used, as well as the 1 GHz IF amplifier, branching network etc. The only new component that would need to be developed would be a broadband (750 MHz-1.25 GHz) Balun or power combiner to combine the two IF signals generated by each crystal in the balanced mixer into a single ended input to drive the IF amplifier.

The development of the branching network and the synthesis of the 12 local oscillator frequencies represents a major

*Patented 6 port Junction sold by Microwave Associates

engineering effort. The successful completion of these two items will require a significant increase in the level of our effort (perhaps adding two additional students) and more substantial funding.

Two other more fundamental problem areas have become apparent in this work. The first involves the study of the effect and measurement of noise in wideband communication systems. The concept of the noise figure of a mixer is in reality a single frequency notion. The excess noise produced by the mixer is measured by introducing an external known noise power and down converting it by mixing with a coherent L.O. frequency and detecting it with a low frequency, narrowband IF strip. This may be done at many L.O. frequencies and the narrowband noise characteristics of the mixer determined over any frequency range. The question we raise is does the narrow band noise characteristic of the mixer adequately describe the performance of a system with a 500 MHz instantaneous bandwidth which is detecting coherent inputs distributed across the band? We wish to better understand the nature of noise and its effect on this system.

The second fundamental question involves the delay distortion that will be experienced by color TV signals in this receiver. To adequately measure the amount of delay distortion, its effect on signal quality, and how to compensate for it, will require us to upgrade both our knowledge and instrumentation in this area. We consider this to be another major task, should we proceed in the development of the ground terminal.

REFERENCES

1. R. P. Morgan, J. P. Singh, et al., "Progress Report: A Program On Application of Communications Satellites to Educational Development", submitted to NASA, Washington University, Saint Louis, Missouri, November, 1971.
2. J. P. Singh, "Operating Frequencies for Educational Satellite Services", Memorandum 71-10, Washington University-NASA Program on Application of Communications Satellites to Educational Development, Washington University, Saint Louis, Missouri, November, 1971.
3. B. B. Lusignan, et al., "The Design and Development of a Low-Cost Microwave Adapter Suitable for Television Reception from High-Power Communications Satellites", NASA Technical Report No. 3682-1, pp. 153-156, October, 1970.
4. F. J. Rosenbaum and W. C. Tsai, "Gunn Effect Swept Frequency Oscillator", Proc. IEEE (Letters), vol. 56, pp. 2164-2165, December, 1968.
5. W. C. Tsai and F. J. Rosenbaum, "Bias Circuit Oscillations in Gunn Devices", IEEE Trans. on Electron Devices, vol. ED-16, pp. 196-202, February, 1969.
6. F. J. Rosenbaum, "Microwave Circuit Design for Wide-Band Tunable Gunn Effect Oscillators", Proceedings of the National Electronics Conference, vol. 25, pp. 176-180, December, 1969, Chicago, Illinois.
7. W. C. Tsai, F. J. Rosenbaum, and L. A. MacKenzie, "Circuit Analysis of Waveguide-Cavity Gunn-Effect Oscillator", IEEE Trans. on Microwave Theory and Techniques, vol. MTT-18, pp. 808-817, November, 1970.
8. W. C. Tsai and F. J. Rosenbaum, "Amplitude and Frequency Modulation of a Waveguide Cavity CW Gunn Oscillator", IEEE Trans. on Microwave Theory and Techniques, op. cit., pp. 877-844.
9. F. J. Rosenbaum, "Gunn Device Applications", Digest, IEEE 71 International Convention, pp. 522-523, March, 1971, IEEE Cat. No. 71C8.
10. E. F. Miller, (Prog. Tech. Mgr.), "Ground Signal Processing System, Summary Reports on Analysis, Design and Cost Estimating", Contract NAS-3-11520, pp. 5-6, June, 1970.

11. K. M. Johnson, "X-Band Integrated Circuit Mixer with Reactively Terminated Image", IEEE Trans. on Microwave Theory and Techniques, vol. MTT-16, pp. 388-397, July, 1968.
12. L. Napoli and J. Hughes, "Low-Noise Integrated X-Band Receiver", Microwave Journal, vol. 11, pp. 37-42, July, 1968.
13. T. H. Oxley, "X-Band Integrated Circuit Receiver", Microwave Journal, vol. 13, pp. 52-55, 1970.
14. J. E. Degenford, et al., "An Integrated X-Band Image and Sum Frequency Enhanced Mixer with 1 GHz IF", 1971 International Microwave Symposium Digest, pp. 16-17.
15. Transmission Deviations in PM and FM Systems, Chapter 21 in Transmission Systems for Communications, Bell Telephone Laboratories, Inc., 1965.
16. L. H. Wilson, "Phase Distortion in FM Satellite Communication Systems", IEEE Transaction on Communications Technology, vol. COM-17, No. 1, February, 1969.
17. J. Fagot and P. Magne, Frequency Modulation Theory, Pergamon Press, New York 1961.
18. J. R. Cavanaugh, et al., "Subjective Effects of Differential Distortions in NTSC Color Television Pictures", J. SMPTE, August, 1971.
19. J. P. Singh and R. P. Morgan, "Educational Electronic Information Dissemination and Broadcast Services", Memorandum 71-3, Washington University Program on Application of Communications Satellites to Educational Development, Saint Louis, August, 1971.
20. L. A. Seval'nev, et al., "SECAM Color Television and Sound Transmission via the Molniya-1 Satellite", Telecommunications, vol. 24, No. 5, 1970.
21. G. G. Gassmann, "Twelve Sound Channels During the Vertical Sync Interval of the Television Signal", IEEE Transaction on Broadcast Receivers, December, 1970.
22. J. Jansen, et al., TRW Broadcast Satellite Study, TRW Systems Group, NASA CR-72510, October, 1969.
23. D. K. Sachdev, "Multiple Sound Channel Tradeoffs for Satellite TV Broadcast Systems", IEEE Trans. on Broadcasting, vol. BC-16, No. 2, June, 1970.

24. L. D. Collins, "Signal-to-Noise Ratios for Television Transmission", Tech. Note 1969/12, Lincoln Laboratory, MIT, March, 1969.
25. K. Sadashige, "Study of Noise in Television Broadcast Equipment", Journal of SMPTE, vol. 78, December, 1969.
26. "Engineering Aspects of Television Allocations", Report of the Television Allocations Study Organization to the Federal Communications Commission, March 16, 1959.
27. J. M. Barstow and H. N. Christopher, "The Measurement of Random Video Interference to Monochrome and Color Television", AIEE Trans. on Com. and Electronics, No. 63, November, 1962.
28. L. Golding, "A 15 to 25 MHz Digital Television System for Transmission of Commercial Color Television", Technical Memorandum CL-8-67, COMSAT Corporation, Washington, December, 1967.
29. E. E. Rinehart, "Radio Relay System Performance in an Interference Environment", Memorandum RM-5786-NASA, The Rand Corporation, Santa Monica, Calif., October, 1968.
30. J. J. Hult, et al., "The Technology Potentials for Satellite Spacing and Frequency Sharing", Memorandum RM-5785-NASA, The Rand Corporation, Santa Monica, Calif. October, 1968
31. S. J. Dudzinsky, "Polarization Discrimination for Satellite Communications", Paper P-4176, The Rand Corporation, Santa Monica, Calif. February, 1968.
32. "Introduction to Satellite Communications", U.S. Army Strategic Communications Command, Fort Huachuca, Arizona, February, 1968.
33. P. A. Watson and S. I. Ghobrial, "Cross Polarizing Effects of a Water Film on a Parabolic Reflector at Microwave Frequencies", Report No. 71, Postgraduate School of Electrical and Electronic Engineering, University of Bradford, Bradford 7, Yorks, England, July, 1971.
34. P. A. Watson and F. Goodall, "The Mutual Interference Between Orthogonally Polarized Radio Channels at 11-GHz", Report No. 68,
35. B. G. Evans, et al., "Investigation of the Effects of Precipitation on Parabolic Antennae Employing Linear Orthogonal Polarization at 11 GHz", Electronics Letters, vol. 7, No. 13, July 1, 1971.

36. J. Savides, "Antenna Pattern Shaping, Sensing and Steering Study", Philco-Ford Corporation (WDL), NASA CR-72629, Palo Alto, Calif., July, 1970.
37. D. W. Power, "Antenna Pattern Shaping, Sensing and Steering Study", Sylvania Electronic Systems, NASA CR-72628, Needham Heights, Mass., April, 1970.
38. H. J. Schlafly, "18 GHz Wideband Distribution System Propagation Tests", IEEE International Convention Record, 1967, Vol. 15, p. 118.
39. H. A. Watson, (ed.), Microwave Semiconductor Devices, and Their Circuit Application, McGraw-Hill Book Company, New York, pp. 386-388, 1969.
40. G. L. Matthaei, et al., Microwave Filters, Impedance-Matching Networks, and Coupling Structures, McGraw-Hill Book Company, New York, Ch. 14, 1964.
41. Donovan, Chitre, et al., "Microwave Branching Networks for Surface and Space Communication Systems", IEEE Symp. on Communications, Montreal, 1966.