

# UC San Diego

## UC San Diego Previously Published Works

### Title

Deterministic multiuser carrier-frequency offset estimation for interleaved OFDMA uplink

### Permalink

<https://escholarship.org/uc/item/2qw1n874>

### Journal

IEEE Transactions on Communications, 52(9)

### ISSN

0090-6778

### Authors

Cao, Zhongren R

Tureli, U

Yao, Y D

### Publication Date

2004-09-01

Peer reviewed

# Deterministic Multiuser Carrier Frequency Offset Estimation for Interleaved OFDMA Uplink

Zhongren Cao, *Student Member, IEEE*, Ufuk Tureli, *Member, IEEE*, Yu-Dong Yao, *Senior Member, IEEE*

**Abstract**—In orthogonal frequency division multiple access (OFDMA), closely spaced multiple subcarriers are assigned to different users for parallel signal transmission. An interleaved subcarrier assignment scheme is preferred because it provides maximum frequency diversity and increases the capacity in frequency selective fading channels. The subcarriers are overlapping but orthogonal to each other such that there is no inter-carrier interference. Carrier frequency offsets between the transmitter and the receiver destroy the orthogonality and introduces inter-carrier interference resulting in multiple access interference. This paper exploits the inner structure of the signals for carrier frequency offsets estimation in the uplink of interleaved OFDMA systems. A new uplink signal model is presented and an estimation algorithm based on the signal structure is proposed for estimating the carrier frequency offsets of all users using only one OFDMA block. Diversity schemes are also presented to improve the estimation performance. Simulation results illustrate the high accuracy and efficiency of the proposed algorithm.

**Index Terms**—Orthogonal frequency division multiplex (OFDM), multiple access, carrier frequency offset (CFO), parameter estimation, matrix decomposition.

## I. INTRODUCTION

Orthogonal frequency division multiplexing (OFDM) [1] has been selected as the physical layer technology for a number of wireless applications, such as digital audio broadcasting (DAB) [2] and terrestrial digital video broadcasting (DVB) [3]. It has also been adopted by IEEE 802.11a [4] and HIPERLAN/2 [5] for high data rate wireless packet transmissions. In OFDM, a set of equally spaced subcarriers are used for parallel data transmissions. To increase the frequency efficiency, these subcarriers are overlapping in the frequency domain but orthogonal to each other such that there is no inter-carrier interference (ICI). The most important feature of OFDM is the capability of mitigating frequency-dependent distortion across the channel band and simplifying the equalization in a multipath fading environment.

Recently, orthogonal frequency division multiple access (OFDMA) was proposed for broadband wireless multiple access systems in IEEE 802.16a [6]. In OFDMA, closely spaced and overlapped subcarriers are divided into groups and assigned to multiple user for simultaneous transmissions. Unlike traditional frequency division multiple access (FDMA), where any overlapping of the frequency spectrum of different users introduces multiple access interference (MAI), the

orthogonality of subcarriers guarantees that there is no inter-carrier interference (ICI), which prevents MAI among users in OFDMA systems.

OFDMA inherits from OFDM the weakness of being sensitive to inaccurate frequency references [7]. Carrier frequency offset (CFO) between the transmitter and the receiver causes the loss of orthogonality among subcarriers and introduces ICI. In OFDMA, CFO will further cause MAI, which degrades the system performance [8]. CFO estimation for OFDM has been extensively studied in recent years [9]–[14]. In OFDMA, CFO estimation is relatively simple in the broadcast link (downlink), where different users' signals are multiplexed by the same transmitter, and the orthogonality among all subcarriers is maintained. Each user can perform the frequency synchronization by estimating a single CFO, which is the one between itself and the transmitter, and compensate accordingly. Many CFO estimation algorithms proposed for OFDM are applicable for the OFDMA downlink. The real challenge exists in the uplink of OFDMA, where a number of users share the total number of subcarriers and each user has its own CFO. CFO estimation in this case becomes a multiple-parameter estimation problem.

CFO estimation in the OFDMA uplink is closely related to the subcarrier assignment scheme adopted by the system. There are two major subcarrier assignment schemes [8], sub-band based and interleaved. The former, sub-band based subcarrier assignment, divides the whole bandwidth into small continuous sub-bands and each user is assigned to one or several sub-bands similar to traditional FDMA. In the latter, interleaved subcarrier assignment, subcarriers assigned to different users are interleaved over the whole bandwidth.

CFO estimation in the uplink of sub-band based OFDMA systems has been investigated and reported recently in [15]–[17], where a frequency guard band was used between sub-bands so that signals from different users can be separated by filter banks. Existing CFO estimation algorithms that were proposed for OFDM are applied on each single user after its signal is isolated.

Sub-band based OFDMA systems are vulnerable to frequency selective fading. In channels with a large coherent bandwidth, several consecutive subcarriers may be subject to deep fading at the same time and the data transmitted over a whole sub-band may not be recovered even with coding and interleaving. On the contrary, the interleaved subcarrier assignment scheme provides maximum separation among the subcarriers assigned to the same user, which maximizes the frequency diversity for each user. However, the interleaved scheme complicates CFO estimation in the OFDMA uplink,

The authors are with the Department of Electrical and Computer Engineering, Stevens Institute of Technology, Hoboken, NJ, 07030 USA (email: zcao@stevens.edu; utureli@stevens.edu; yyao@stevens.edu).

since it minimizes the distances between subcarriers assigned to different users. When there are frequency synchronization errors, the signals from different users are overlapping in the time domain by the nature of OFDMA and interfering each other in the frequency domain due to the loss of orthogonality. In order to separate multiple users' signals and suppress MAI, advanced signal processing algorithms have to be applied at the uplink receiver, as shown in [18]. These techniques rely on the correct estimation of each user's CFO. Therefore, CFO estimation is a major task in designing OFDMA receivers.

CFO estimation in the interleaved uplink of OFDMA was studied and a statistics based CFO estimation algorithm was proposed for the OFDMA, which is applicable to both sub-band based uplink and interleaved uplink [19]. However, the algorithm in [19] requires collecting signal samples of many OFDMA blocks to compute unknown parameters on the order of the number of subcarriers and results in a biased estimator. When the number of subcarriers is large, such as 2048 as in IEEE 802.16, the algorithm is computationally prohibitive.

The originality of this paper is that it investigates the CFO estimation in the interleaved uplink of OFDMA based on the deterministic structure of the signals. In an interleaved OFDMA system, signal from each user has a special periodic structure within an OFDMA block, which can be exploited by arranging the received signals into a matrix form to reduce the number of unknown frequencies to the number of users. A high resolution signal processing technique [20] is used to estimate the CFO's of all involving users deterministically using only one OFDMA block instead of a large number of blocks as in [19]. Since the number of unknown parameters equals the number of users, the algorithm is practical for OFDMA systems with large number of subcarriers.

This paper is organized as follows. The signal model of OFDMA is presented in Section II. The periodic signal structure of the interleaved OFDMA uplink is introduced in Section III. In Section IV, the CFO estimation problem is stated and the proposed estimation algorithm is derived. Simulation results are reported in Section V and conclusions are drawn in Section VI.

## II. OFDM-BASED MULTIPLE ACCESS – OFDMA

In this section, we introduce the uplink signal model of OFDMA. Consider an OFDMA system consisting of  $N$  subcarriers and  $K$  users. The  $N$  subcarriers include all available subcarriers and virtual subcarriers in the guard band [21]. All subcarriers are sequentially indexed with  $\{n\}$ ,  $n = 0, 1, \dots, N - 1$ . Among the  $N$  subcarriers, the  $k$ th user is assigned to a subset of  $P^{(k)}$  subcarriers with the index set  $\{c_0^{(k)}, c_1^{(k)}, \dots, c_{P^{(k)}-1}^{(k)}\}$ . The superscript  $(\cdot)^{(k)}$  denotes the  $k$ th user.

An OFDMA block is the signal generated by one inverse fast fourier transform (IFFT) operation including the cyclic prefix (CP). Let  $[X_{g,0}^{(k)}, X_{g,1}^{(k)}, \dots, X_{g,P^{(k)}-1}^{(k)}]$  be the  $P^{(k)}$  modulation symbols the  $k$ th user will transmit during the  $g$ th OFDMA block. For data bearing subcarriers, the modulation symbols are data symbols, such as phase shift keying (PSK) or quadrature amplitude modulation (QAM). For virtual subcarriers, the modulation symbols are effectively padded zeros in

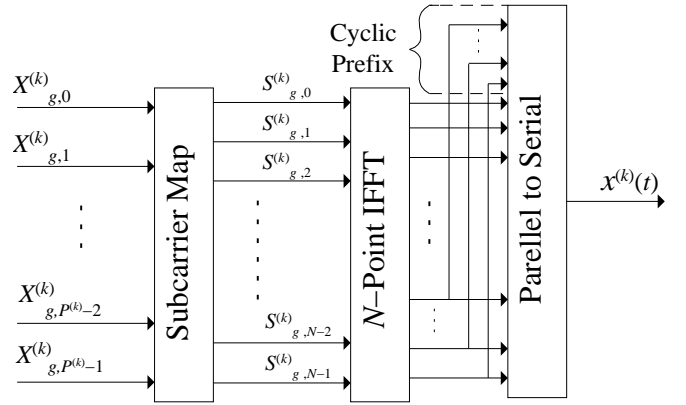

Fig. 1. Uplink OFDMA transmitter structure.

IFFT. For pilot subcarriers, the modulation symbols are pilot symbols or training symbols for estimating the channels.

Fig. 1 illustrates the signal generation and transmission of the  $k$ th user. The  $P^{(k)}$  modulation symbols are first mapped into a set of  $N$  modulation symbols,  $S_{g,i}^{(k)}$ ,  $i = 0, 1, \dots, N-1$ , according to

$$S_{g,i}^{(k)} = \begin{cases} X_{g,p}^{(k)}, & \text{if } i = c_p^{(k)}; \\ 0, & \text{otherwise.} \end{cases} \quad (1)$$

for  $p = 0, 1, \dots, P^{(k)} - 1$ . The  $N$  symbols,  $\{S_{g,i}^{(k)}\}_{i=0}^{N-1}$ , are modulated onto the  $N$  subcarriers via an  $N$ -point IFFT. The CP is also added to avoid inter-block interference (IBI) caused by multipath fading. As a result, the baseband signal transmitted from the  $k$ th user can be represented as

$$\begin{aligned} x^{(k)}(t) &= \sum_{g=-\infty}^{\infty} \sum_{i=0}^{N-1} S_{g,i}^{(k)} F_{g,i}(t) \\ &= \sum_{g=-\infty}^{\infty} \sum_{p=0}^{P^{(k)}-1} X_{g,p}^{(k)} F_{g,c_p^{(k)}}(t). \end{aligned} \quad (2)$$

Note  $F_{g,i}(t)$  is given by

$$F_{g,i}(t) = \begin{cases} e^{j2\pi(i\Delta f)(t-T_{cp}-gT_b)}, & gT_b \leq t < (g+1)T_b; \\ 0, & \text{otherwise,} \end{cases} \quad (3)$$

where  $\Delta f$  is the subcarrier spacing,  $T_{cp}$  is the length of CP and  $T_b = T + T_{cp}$  is the duration of one OFDMA block,  $T = 1/\Delta f$ .

The signals are transmitted through slowly time-variant multipath fading channels, i.e. fading coefficients are assumed to be constant during one OFDMA block. The channel between the  $k$ th user and the uplink receiver is characterized by

$$h^{(k)}(\tau, t) = \sum_{l=1}^{L^{(k)}} \alpha_l^{(k)}(t) \delta(\tau - \tau_l^{(k)}), \quad (4)$$

where  $L^{(k)}$  is the total number of paths,  $\alpha_l^{(k)}$  and  $\tau_l^{(k)}$  are the complex gain and time delay of the  $l$ th path.

At the uplink receiver, the signal of one OFDMA block is the superposition of signals from all  $K$  involved users. Assume

all  $K$  users are synchronized in time, the received sampled signal in the absence of noise can be written as

$$\Upsilon(nT_s) = \sum_{k=1}^K \sum_{l=1}^{L^{(k)}} \alpha_l^{(k)}(nT_s) x^{(k)}(nT_s - \tau_l^{(k)}), \quad (5)$$

where  $T_s = T/N$  is the sampling interval. As we will focus on the signal of one OFDMA block, the index  $g$  in the following is neglected for convenience. Let  $H_p^{(k)}$  denote the channel frequency response on the  $c_p^{(k)}$ th subcarrier of the  $k$ th user's channel during one OFDMA block. We have

$$H_p^{(k)} = \sum_{l=1}^{L^{(k)}} \alpha_l^{(k)} e^{-j2\pi c_p^{(k)} \Delta f \tau_l^{(k)}}. \quad (6)$$

From (2)-(6), after the removal of CP, the remaining  $N$  signal samples of one OFDMA block at the uplink receiver are given by

$$\begin{aligned} \Upsilon(n) &= \sum_{k=0}^{K-1} \sum_{p=0}^{P^{(k)}-1} H_p^{(k)} X_p^{(k)} e^{j2\pi(c_p^{(k)} \Delta f)nT_s} \\ &= \sum_{k=0}^{K-1} \sum_{p=0}^{P^{(k)}-1} H_p^{(k)} X_p^{(k)} e^{j(2\pi/N)n c_p^{(k)}}, \end{aligned} \quad (7)$$

where  $n = 0, 1, \dots, N-1$ .

Let  $\Delta f^{(k)}$  denote the CFO between the  $k$ th user and the uplink receiver. For practical purposes, the absolute value of  $\Delta f^{(k)}$  is assumed to be less than the half of OFDMA subcarrier spacing. Following [14], the presence of  $\{\Delta f^{(k)}\}_{k=1}^K$  changes the signal model of (7) to

$$\Upsilon(n) = \sum_{k=1}^K \sum_{p=0}^{P^{(k)}-1} H_p^{(k)} X_p^{(k)} e^{j(2\pi/N)n(c_p^{(k)} + \xi^{(k)})}, \quad (8)$$

where  $\xi^{(k)} \in (-0.5, 0.5)$  is given by

$$\xi^{(k)} = \frac{\Delta f^{(k)}}{\Delta f} \quad (9)$$

and it is defined as the *normalized CFO* of the  $k$ th user.

### III. SIGNAL STRUCTURE IN THE UPLINK OF INTERLEAVED OFDMA SYSTEM

In this section, the signal structure at the interleaved OFDMA uplink is presented, which will be utilized for CFO estimation later. Suppose the  $N$  subcarriers are divided into  $Q$  sub-channels and each sub-channel has  $P = N/Q$  subcarriers. For interleaved subcarrier assignment, sub-channel  $\{q\}$  is composed of subcarriers with index set  $\{q, Q+q, \dots, (P-1)Q+q\}$ ,  $q = 0, 1, \dots, Q-1$ .

#### A. Single User Signal Structure and Effective CFO

For the purpose of derivation, consider the system has only one user,  $k$ , which is assigned to sub-channel  $\{q\}$ . After the

removal of CP, the received  $N$  signal samples of the OFDMA block from the  $k$ th user can be written as

$$\begin{aligned} \Upsilon^{(k)}(n) &= \sum_{p=0}^{P-1} H_p^{(k)} X_p^{(k)} e^{j\frac{2\pi}{N}(pQ+q+\xi^{(k)})n} \\ &= e^{j\frac{2\pi}{N}(q+\xi^{(k)})n} \sum_{p=0}^{P-1} H_p^{(k)} X_p^{(k)} e^{j\frac{2\pi}{P}pn}, \end{aligned} \quad (10)$$

where  $n = 0, 1, \dots, N-1$ . It is important to note that

$$\Upsilon^{(k)}(n+P) = e^{j2\pi(q+\xi^{(k)})/Q} \Upsilon^{(k)}(n). \quad (11)$$

Furthermore, we have

$$\Upsilon^{(k)}(n+\nu P) = e^{j2\pi\nu(q+\xi^{(k)})/Q} \Upsilon^{(k)}(n), \quad (12)$$

where  $\nu$  is an integer. Eq. (11) and (12) indicate that the received  $N$  signal samples of one OFDMA block from the  $k$ th user,  $\{\Upsilon^{(k)}(n)\}_{n=0}^{N-1}$ , have a special periodic structure with every  $P$  samples. Let  $R$  denote the number of periods within the  $N$  signal samples. We have  $R = N/P = Q$ . The number of periods is the number of sub-channels.  $\{\Upsilon^{(k)}(n)\}_{n=0}^{N-1}$  can thus be arranged into a  $R \times P$  matrix

$$\mathbf{A}^{(k)} = \begin{bmatrix} \Upsilon^{(k)}(0) & \dots & \Upsilon^{(k)}(P-1) \\ \Upsilon^{(k)}(P) & \dots & \Upsilon^{(k)}(2P-1) \\ \vdots & \ddots & \vdots \\ \Upsilon^{(k)}(N-P) & \dots & \Upsilon^{(k)}(N-1) \end{bmatrix}_{R \times P}. \quad (13)$$

And (10) can be expressed concisely as

$$\mathbf{A}^{(k)} = \mathbf{v}^{(k)} \{\mathbf{u}^{(k)} \odot (\mathbf{b}^{(k)} \mathbf{W})\}. \quad (14)$$

In (14),  $\odot$  represents Schur product [22], or element by element product.  $\mathbf{W}$  is a  $P \times P$  IFFT matrix given as

$$\mathbf{W} = \begin{bmatrix} 1 & 1 & \dots & 1 \\ 1 & e^{j\frac{2\pi}{P}} & \dots & e^{j\frac{2\pi(P-1)}{P}} \\ \vdots & \vdots & \ddots & \vdots \\ 1 & e^{j\frac{2\pi(P-1)}{P}} & \dots & e^{j\frac{2\pi(P-1)(P-1)}{P}} \end{bmatrix}$$

and

$$\mathbf{b}^{(k)} = [H_1^{(k)} X_1^{(k)} \quad H_2^{(k)} X_2^{(k)} \quad \dots \quad H_P^{(k)} X_P^{(k)}].$$

Also,

$$\mathbf{v}^{(k)} = [1 \quad e^{j2\pi\theta^{(k)}} \quad \dots \quad e^{j2\pi(Q-1)\theta^{(k)}}]^T$$

and

$$\mathbf{u}^{(k)} = [1 \quad e^{j2\pi\theta^{(k)}/P} \quad \dots \quad e^{j2\pi(P-1)\theta^{(k)}/P}],$$

where the superscript  $(\cdot)^T$  denotes transpose and  $\theta^{(k)}$  is

$$\theta^{(k)} = \frac{q + \xi^{(k)}}{Q}. \quad (15)$$

We further define  $\theta^{(k)}$  as *effective CFO* of the  $k$ th user. As will be shown later, the proposed algorithm estimates the effective CFO rather than the normalized CFO directly.

Effective CFO has one important property. Different users have distinct effective CFO's. From its definition, we can show that if one user occupies sub-channel  $\{q\}$ , the range of its effective CFO is  $(\frac{q-0.5}{Q}, \frac{q+0.5}{Q})$ , since the range of  $\xi^{(k)}$  is  $(-0.5, 0.5)$ . Because different users occupy different sub-channels, their effective CFO's fall in non-overlapping ranges.

### B. Multiple User Signal Structure

From (8), at the uplink receiver, the remaining  $N$  superposed signal samples of one OFDMA block after the removal of CP are given by

$$\Upsilon(n) = \sum_{k=1}^K \sum_{p=0}^{P^{(k)}-1} H_p^{(k)} X_p^{(k)} e^{j(2\pi/N)(pQ+q^{(k)}+\xi^{(k)})n}, \quad (16)$$

where the  $k$ th user is assigned to sub-channel  $\{q^{(k)}\}$ . In (16), we assume signals from different users are synchronized in time at the uplink receiver. The issue of time offsets among different users will be discussed in Section V(C).

$\{\Upsilon(n)\}_{n=0}^{N-1}$  can also be arranged into a  $R \times P$  matrix,  $\mathbf{A}$ , in the same fashion as (13). From (14) and (16), the following relationship holds

$$\mathbf{A} = \sum_{k=1}^K \mathbf{A}^{(k)} = \mathbf{V}\mathbf{S} = \mathbf{V}\{\mathbf{U} \odot (\mathbf{B}\mathbf{W})\}, \quad (17)$$

where  $\mathbf{S} = \mathbf{U} \odot (\mathbf{B}\mathbf{W})$ .  $\mathbf{W}$  is the same as in (14),

$$\mathbf{U} = \begin{bmatrix} \mathbf{u}^{(1)} \\ \mathbf{u}^{(2)} \\ \vdots \\ \mathbf{u}^{(K)} \end{bmatrix}_{K \times P} \quad \text{and} \quad \mathbf{B} = \begin{bmatrix} \mathbf{b}^{(1)} \\ \mathbf{b}^{(2)} \\ \vdots \\ \mathbf{b}^{(K)} \end{bmatrix}_{K \times P}.$$

$\mathbf{V} = [\mathbf{v}^{(1)}, \mathbf{v}^{(2)}, \dots, \mathbf{v}^{(K)}]$  is a Vandermonde matrix with the following format

$$\begin{bmatrix} 1 & 1 & \dots & 1 \\ e^{j2\pi\theta^{(1)}} & e^{j2\pi\theta^{(2)}} & \dots & e^{j2\pi\theta^{(K)}} \\ \vdots & \vdots & \ddots & \vdots \\ e^{j2\pi(R-1)\theta^{(1)}} & e^{j2\pi(R-1)\theta^{(2)}} & \dots & e^{j2\pi(R-1)\theta^{(K)}} \end{bmatrix}_{R \times K}. \quad (18)$$

Finally,  $\mathbf{S}$  is a  $K \times P$  matrix and its  $k$ th row is  $[\Upsilon^{(k)}(0), \Upsilon^{(k)}(1), \dots, \Upsilon^{(k)}(P-1)]$ .

## IV. CARRIER FREQUENCY OFFSET ESTIMATION ALGORITHM

In this section, we estimate the CFO's of all involved users from the received signal samples of one OFDMA block based on (17). There are two requirements in determining the CFO for each user:

- Find  $K$  estimates  $\Delta \hat{f}^{(k)}$ ,  $k = 1, 2, \dots, K$ , for  $\Delta f^{(k)}$
- Match each  $\Delta \hat{f}^{(k)}$  with the user it belongs to

Due to the property of effective CFO, if sub-channel  $\{q\}$  is occupied by one user, there will be one and only one effective CFO which falls into the range of  $(\frac{q-0.5}{Q}, \frac{q+0.5}{Q})$ . It is thus a simple mapping to match the estimated effective CFO's with their corresponding users. We assume that the uplink receiver knows the number of users,  $K$ , and how the sub-channels are distributed among all users. Based on (15), the estimate of the CFO between the uplink receiver and the user assigned to sub-channel  $\{q\}$  is derived by

$$\Delta \hat{f}^{(k)} = \hat{\xi}^{(k)} \Delta f = (Q\hat{\theta}^{(k)} - q)\Delta f, \quad (19)$$

where  $\Delta \hat{f}^{(k)}$ ,  $\hat{\xi}^{(k)}$  and  $\hat{\theta}^{(k)}$  are the estimates of  $\Delta f^{(k)}$ ,  $\xi^{(k)}$  and  $\theta^{(k)}$ , respectively. In the following, we propose a structure based blind algorithm to estimate the effective CFO's of all  $K$  involved users simultaneously.

### A. A Structure Based Estimation Algorithm

A matrix form representation of an OFDMA block observed in noise is given by

$$\mathbf{Y} = \mathbf{A} + \mathbf{Z} = \mathbf{V}\mathbf{S} + \mathbf{Z} \quad (20)$$

where  $\mathbf{Z}$  is a  $R \times P$  additive white Gaussian noise matrix. Each element of  $\mathbf{Z}$  is a Gaussian random variable with zero mean and variance  $\sigma^2$ .

Let  $\mathbf{y}_l$ ,  $\mathbf{s}_l$  and  $\mathbf{z}_l$  denote the  $l$ th column of  $\mathbf{Y}$ ,  $\mathbf{S}$  and  $\mathbf{Z}$ ,  $l = 1, 2, \dots, P$ . We have  $\mathbf{y}_l = \mathbf{V}\mathbf{s}_l + \mathbf{z}_l$ . The covariance matrix of  $\mathbf{y}_l$  is given by

$$\mathbf{\Psi} = \mathbb{E}[\mathbf{y}_l \mathbf{y}_l^{\mathcal{H}}] = \mathbf{V}\mathbf{\Phi}\mathbf{V}^{\mathcal{H}} + \sigma^2 \mathbf{I} \quad (21)$$

where  $(\cdot)^{\mathcal{H}}$  represents hermitian operation and  $\mathbb{E}[\cdot]$  means the expectation value. In (21),  $\mathbf{\Phi} = \mathbb{E}[\mathbf{s}_l \mathbf{s}_l^{\mathcal{H}}]$  is the covariance matrix of  $\mathbf{s}_l$  and  $\mathbf{I}$  is a  $R \times R$  identity matrix.

From the definition,  $\mathbf{\Psi}$  is a Hermitian matrix so that its eigenvalues are all positive real numbers [22]. Let  $\lambda_1 \geq \lambda_2 \geq \dots \geq \lambda_R$  denote the  $R$  eigenvalues of  $\mathbf{\Psi}$  in descending order. Let  $K < R$ , we thus have  $\lambda_{K+1} = \lambda_{K+2} = \dots = \lambda_R = \sigma^2$  (see R5 of the Appendix in [20]). Singular value decomposition (SVD) of  $\mathbf{\Psi}$  is

$$\mathbf{\Psi} = [\mathbf{U}_s \quad \mathbf{U}_z] \begin{bmatrix} \mathbf{\Sigma}_s & \mathbf{0} \\ \mathbf{0} & \mathbf{\Sigma}_z \end{bmatrix} \begin{bmatrix} \mathbf{U}_s^{\mathcal{H}} \\ \mathbf{U}_z^{\mathcal{H}} \end{bmatrix} \quad (22)$$

where  $\mathbf{\Sigma}_s = \text{Diag}[\lambda_1, \dots, \lambda_K]$  and  $\mathbf{\Sigma}_z = \text{Diag}[\lambda_{K+1}, \dots, \lambda_R]$ .  $\mathbf{U}_s$  is a  $R \times K$  matrix composed of  $K$  eigenvectors corresponding to  $\lambda_1, \lambda_2, \dots, \lambda_K$  and  $\mathbf{U}_z$  is a  $R \times (R-K)$  matrix composed of  $R-K$  eigenvectors corresponding to  $\lambda_{K+1}, \dots, \lambda_R$ .

Since  $\mathbf{U}_s$  and  $\mathbf{U}_z$  are both unitary matrices,  $\mathbf{U}_s \mathbf{U}_s^{\mathcal{H}} = \mathbf{U}_z \mathbf{U}_z^{\mathcal{H}} = \mathbf{I}$ . Let  $\mathcal{S}$  denote the subspace spanned by  $\mathbf{U}_s$  ( $\mathcal{S} = \text{span}(\mathbf{U}_s)$ ) and  $\mathcal{Z}$  denote the subspace spanned by  $\mathbf{U}_z$  ( $\mathcal{Z} = \text{span}(\mathbf{U}_z)$ ).  $\mathcal{S}$  is the signal subspace of  $\mathbf{\Psi}$  and  $\mathcal{Z}$  is the noise subspace.  $\mathcal{S}$  and  $\mathcal{Z}$  are orthogonal to each other and  $\mathbf{U}_s \mathbf{U}_z^{\mathcal{H}} = \mathbf{0}$ . From (22), we have

$$\mathbf{\Psi} = \mathbf{U}_s \mathbf{\Sigma}_s \mathbf{U}_s^{\mathcal{H}} + \sigma^2 \mathbf{U}_z \mathbf{U}_z^{\mathcal{H}}. \quad (23)$$

Multiplying (21) and (23) by  $\mathbf{U}_z$ , respectively,

$$\begin{aligned} \mathbf{\Psi} \mathbf{U}_z &= \mathbf{V}\mathbf{\Phi}\mathbf{V}^{\mathcal{H}} \mathbf{U}_z + \sigma^2 \mathbf{U}_z, \\ \mathbf{\Psi} \mathbf{U}_z &= \sigma^2 \mathbf{U}_z, \end{aligned} \quad (24)$$

we find  $\mathbf{V}\mathbf{\Phi}\mathbf{V}^{\mathcal{H}} \mathbf{U}_z = \mathbf{0}$ . Vandermonde matrix  $\mathbf{V}$  is full rank [20]. We assume users are independent and signals are generated independently so that covariance matrix  $\mathbf{\Phi}$  is also full rank. Hence,  $\mathbf{V}\mathbf{\Phi}$  is full rank and  $\mathbf{V}^{\mathcal{H}} \mathbf{U}_z = \mathbf{0}$ . For each column of  $\mathbf{V}$ ,  $\mathbf{v}_k$ , where  $k = 1, \dots, K$ , we have  $\mathbf{U}_z^{\mathcal{H}} \mathbf{v}_k = 0$  and thus  $\{\theta^{(k)}\}_{k=1}^K$  correspond to the largest  $K$  local maximum of

$$\frac{1}{\|\mathbf{a}^{\mathcal{H}}(\theta) \mathbf{U}_z \mathbf{U}_z^{\mathcal{H}} \mathbf{a}(\theta)\|^2} \quad (25)$$

where  $\mathbf{a}(\theta) = [1, e^{j2\pi\theta}, \dots, e^{j2\pi(R-1)\theta}]^T$ .

In (20),  $\mathbf{Y}$  is a  $R \times P$  matrix, where  $P$  is the number of subcarriers in one sub channel. In an OFDMA system with 2048 subcarriers, if there are 16 sub-channels,  $P = 128$ ; if there are 32 sub-channels,  $P = 64$ . In Section IV(B), diversity schemes will be introduced where the number of columns in  $\mathbf{Y}$  is the multiples of  $P$ . With a large number of columns in  $\mathbf{Y}$ , the covariance matrix  $\Psi$  can be estimated by

$$\hat{\Psi} = \frac{1}{P} \mathbf{Y} \mathbf{Y}^H = \frac{1}{P} \sum_{l=1}^P \mathbf{y}_l \mathbf{y}_l^H. \quad (26)$$

And the estimation of  $U_s$  and  $U_z$ ,  $\hat{U}_s$  and  $\hat{U}_z$  can be derived by introducing SVD to  $\hat{\Psi}$ .

In summary, the CFO's of all  $K$  users are estimated using the signal samples of one OFDMA block as following:

*Step 1:* Formulate the received signal samples into matrix form  $\mathbf{Y}$

*Step 2:* Introduce SVD to  $\hat{\Psi} = \mathbf{Y} \mathbf{Y}^H / P$  to find  $\hat{U}_z$

*Step 3:* Find the largest  $K$  peaks of (25) to estimate  $\{\theta^{(k)}\}_{k=1}^K$

*Step 4:* Calculate  $\Delta f^{(k)}$  using (19)

Neither the channel knowledge nor the transmitted training symbols are required in the proposed structure based algorithm. In this sense, the proposed algorithm is a *blind* method for the estimation problem in concern.

From (25), the rank of the noise subspace  $\mathcal{Z}$  is required to be at least 1. In other words, we assume  $R > K$ . There are two methods for satisfying this requirement. In the first method, the maximum number of supported users in one OFDMA block,  $K_{\max}$ , is set to be  $K_{\max} = Q - 1 < Q$ . For an OFDMA system with  $Q$  sub-channels,  $R$  equals  $Q$ . Hence,  $R > K$  is satisfied. In the second method, we let  $K_{\max} = Q$  and extend the length of CP to  $N_{cp} + \mu P$ , where  $\mu$  is a positive integer. The first  $N_{cp}$  samples are the original CP and used to accommodate both channel delay spreads and timing offsets among multiple users [23]. The following  $\mu P$  samples are not contaminated by inter-block interference (IBI) from previous OFDMA block and used by the structure based algorithm with the remaining  $N$  samples for estimation such that  $R = (N + \mu P) / P = Q + \mu > K_{\max}$ .

In terms of the subspace based analysis, the proposed algorithm is similar to the methods used in multiple signal classification (MUSIC) [24] and estimation of signal parameters by rotational invariance techniques (ESPRIT) [25]. In [19], MUSIC and ESPRIT were used in a statistics based algorithm to estimate the CFO's in the uplink of OFDMA in which the number of unknown parameters is equal to the number of subcarriers in the system. Therefore, its application is confined to OFDMA with a limited number of subcarriers. Furthermore, since one user occupies a set of subcarriers, the statistics based algorithm will give an estimate of its CFO per subcarrier. Combining of the estimates from the subcarriers is inevitable for each user to give the final estimation and the optimal combining method requires additional knowledge such as channel information or modulation symbols [26].

Unlike the statistics based algorithm, the structure based algorithm proposed in this paper takes advantage of the inner

algebraic structure of interleaved OFDMA signals in one OFDMA block, i.e., the periodic property of each user's signal, such that it only estimates one CFO for each user regardless the number of subcarriers one user occupies. It is computationally efficient for OFDMA systems with large subcarrier size. Secondly, it is applicable to the environment where system parameters or channel conditions are changing from block to block in which the statistics based algorithm is not feasible. In Section V, we will show the accuracy of the structure based algorithm is also better than that of the statistics based algorithm in [19].

### B. Estimation with Diversity

In the above, only one OFDMA block is used in the structure based algorithm. Under moderate or high signal-to-noise ratio (SNR), the signal samples of one OFDMA block are sufficient for accurate CFO estimation as will be shown later in simulation results. However, due to the limited samples, the covariance matrix of the sampled noise is not ideally diagonal. Under low SNR conditions, this will degrade the performance of the proposed estimation algorithm.

Diversity schemes can be applied to increase the amount of signal samples as well as the amount of noise samples for estimation purposes. If the diversity scheme is selected such that all noise samples are uncorrelated, the effect of the noise is more close to that of ideal white noise and the performance of the structure based estimation algorithm is thus improved. Estimation using multiple OFDMA blocks [27] and multiple receive antennas [28] are two feasible diversity schemes. Oversampling is not appropriate since it samples the received signals using a rate higher than the Nyquist rate and introduces correlation among noise samples. This leads to colored noise. In fact, subspace based methods perform poorly when the noise is not white [20].

Let  $\{m\}_{m=1}^M$  denotes the index of received OFDMA blocks. In the multiple OFDMA block diversity scheme,  $\{\mathbf{Y}_m\}_{m=1}^M$  are the consecutive OFDMA blocks received by the uplink receiver. In the multiple receive antenna diversity scheme,  $\mathbf{Y}_m$  denotes the signal matrix of the OFDMA block received from the  $m$ th antenna. We have

$$\mathbf{Y}_m = \mathbf{V} \mathbf{S}_m + \mathbf{Z}_m, \quad (27)$$

where  $\mathbf{S}_m$  is the same as the  $\mathbf{S}$  defined in (17), except that the subscript  $(\cdot)_m$  is the index of the OFDMA block, and  $\mathbf{Z}_m$  is the noise matrix sampled in the  $m$ th OFDMA block. Define  $\tilde{\mathbf{Y}} = [\mathbf{Y}_1 \ \mathbf{Y}_2 \ \dots \ \mathbf{Y}_M]$ . We have

$$\tilde{\mathbf{Y}} = \tilde{\mathbf{V}} \tilde{\mathbf{S}} + \tilde{\mathbf{Z}}, \quad (28)$$

where  $\tilde{\mathbf{S}} = [\mathbf{S}_1 \ \mathbf{S}_2 \ \dots \ \mathbf{S}_M]$  and  $\tilde{\mathbf{Z}} = [\mathbf{Z}_1 \ \mathbf{Z}_2 \ \dots \ \mathbf{Z}_M]$ .

Let  $\tilde{\Psi} = \tilde{\mathbf{Y}} \tilde{\mathbf{Y}}^H / P$ . Applying the proposed algorithm to  $\tilde{\Psi}$ , we will show the improvement of the estimation performance through simulation in Section V.

### C. Estimation in the Presence of Time Offset

In the above we assume that all users are time synchronized. In practical wireless environment, OFDMA blocks from distinct users are offset with each other when they arrive at the

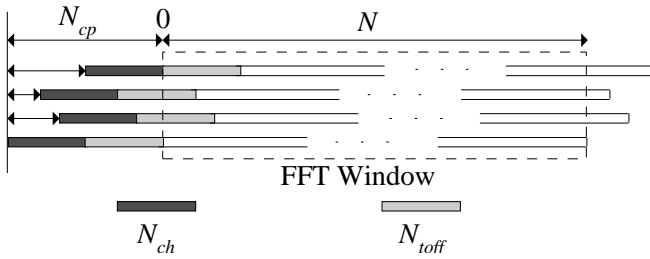

Fig. 2. Cyclic prefix and uplink receiver FFT window.

uplink receiver due to their different propagation delays. The time offsets among users will introduce IBI and degrade the performance of OFDMA.

A common way to compensate for the time offsets among users is to select the length of the CP to accommodate both the maximum channel delay spread and the maximum time offset [23]. This is shown in Fig. 2. The CP is composed of two parts, as  $N_{cp} = N_{ch} + N_{toff}$ , where  $N_{ch}$  is the portion of the CP for accommodating channel delay spreads, while the additional  $N_{toff}$  samples are intended for accommodating different time offsets among users. The vertical line on the left of Fig. 2 is the starting point of an OFDMA block at the uplink receiver. OFDMA blocks from distinct users arrive at the receiver with different delays. If  $N_{toff}$  is selected to be the maximum possible delay among all users and the uplink receiver FFT demodulation window starts from 0 position as in Fig. 2, the  $N$  superposed signal samples that in the window are immune to IBI. An approach in which  $N_{toff}$  is shorter than the maximum time delay was introduced in [29] to increase the efficiency and minimize the residual interference.

Based on the aforementioned technique, we assume that the  $N$  superposed signal samples that the uplink receiver used for FFT demodulation,  $\{\Upsilon(n)\}_{n=0}^{N-1}$ , are not contaminated by IBI. Let  $d^{(k)}$  denote the delay time between the  $k$ th user and the uplink receiver in terms of the number of signal samples and  $\{\Upsilon^{(k)}(n)\}_{n=0}^{N-1}$  denote the  $N$  signal samples from the  $k$ th user that contribute to  $\{\Upsilon(n)\}_{n=0}^{N-1}$ . We have

$$\begin{aligned} \Upsilon^{(k)}(n) &= \sum_{p=0}^{P-1} H_p^{(k)} X_p^{(k)} e^{j\frac{2\pi}{N}(pQ+q)(n-d^{(k)})} e^{j\frac{2\pi}{N}\xi^{(k)}n} \\ &= e^{j(2\pi/N)\xi^{(k)}d^{(k)}} \Upsilon^{(k)}(n-d^{(k)}) \end{aligned} \quad (29)$$

where  $n = 0, 1, \dots, N-1$  and  $\Upsilon^{(k)}(n)$  is defined in (10). Similar to (11) and (12), through simple derivations we have  $\Upsilon^{(k)}(n + \nu P) = e^{j2\pi\nu\theta^{(k)}} \Upsilon^{(k)}(n)$ , which means the periodic structure still exists in  $\{\Upsilon^{(k)}(n)\}_{n=0}^{N-1}$ . Therefore, the proposed structure based algorithm is applicable when signals from different users arrive at the uplink receiver asynchronously.

## V. SIMULATION RESULTS

In this section, we provide the simulation results of the proposed structure based estimation algorithm.

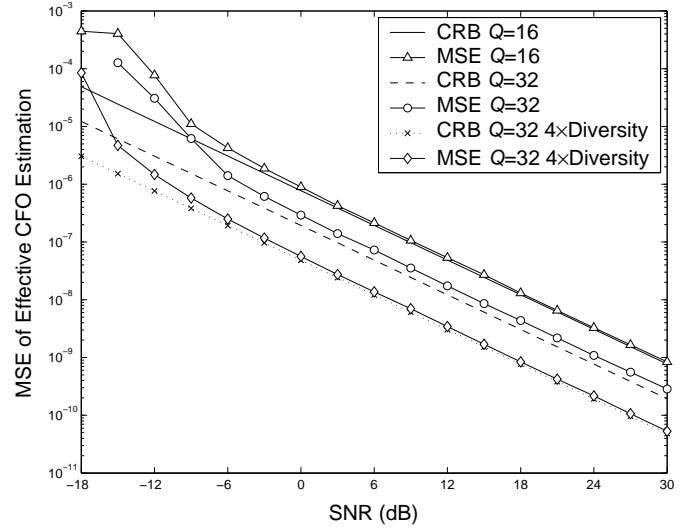

Fig. 3. The mean square error performance of effective CFO estimation compared with the Cramér-Rao bound.

### A. System Scenario and Channel Model

The transmission parameters of the OFDMA system in our simulation are selected from IEEE 802.16a [6]. The uplink bandwidth (BW) is 20 MHz and the FFT size is  $N = 2048$ . The sampling frequency  $F_s$  is determined by  $F_s = \text{BW} \cdot 8/7$ , hence the subcarrier spacing,  $\Delta f$ , is 11.16 KHz and  $T = 89.6 \mu\text{s}$ . Within the 2048 subcarriers, there are 176 virtual subcarriers on the left side band and 175 on the right. The length of a period within one OFDMA block is determined by the configuration of sub-channels. If the 2048 subcarriers are divided into 16 sub-channels, the length of a period is  $5.6 \mu\text{s}$ ; for 32 sub-channels, it is  $2.8 \mu\text{s}$ . The CP is composed of 256 samples, where the first 128 samples are the original CP portion for mitigating the channel delay spreads and the time offsets among users. The remaining 128 samples are used by the proposed CFO estimation algorithm such that  $R > K_{\max}$  and  $K_{\max} = Q$  in the following simulations.

The time-varying multipath channel in the simulation is described in (4). The probability distribution for the delay lags is

$$f(\tau_i) = \begin{cases} 1/D, & \text{if } \tau_i \in [0, D]; \\ 0, & \text{otherwise,} \end{cases}$$

where  $D$  is the maximum path delay in terms of sample intervals and  $\tau_i$  can be a non-integer value. The power-delay profile of  $\alpha_i$  is [30]

$$\eta_\tau = C e^{-\tau/\tau_{rms}},$$

where  $C$  is the average power of the first path.

In the simulations, the maximum number of fading paths for each user is 6. In each Monte Carlo test,  $L^{(k)}$  is a randomly generated integer between [1, 6] for each user.  $C$  is set to be 1 and  $\tau_{rms}$  is  $1.4 \mu\text{s}$ . The simulated channels also included the effect of the pulse shaping filters at both the transmitter and the receiver, which are square root raised cosine filters. The combination of the maximum channel length and the

maximum time offset among users is no longer than 128 sample intervals.

### B. Algorithm Performance

The performance of the effective CFO estimation determines the accuracy of the CFO estimation. In Fig. 3, we show the mean square error (MSE) performance of the effective CFO estimation in three different cases, and compare them to the corresponding Cramér-Rao bounds (CRB). The multiuser CRB of the estimation algorithm is given in ([31], Eq. 4.6). Each user's CRB depends on its CFO and sub-channel allocation, the total number of users and the CFO of its neighboring users. For illustration purpose, we assume the systems are fully loaded ( $K = Q$ ) in all three cases shown in Fig. 3 and each user has the same amount of CFO, which is set as  $\xi = 0.2$ . Thus, the CRB of each user are the same. The MSE of the effective CFO estimation is determined by

$$\frac{1}{K\Pi} \sum_{\rho=1}^{\Pi} \sum_{k=1}^K [\hat{\theta}_{\rho}^{(k)} - \theta^{(k)}]^2, \quad (30)$$

where  $\hat{\theta}_{\rho}^{(k)}$  is the estimation of effective CFO of the  $k$ th user at the  $\rho$ th Monte Carlo simulation and  $\Pi$  is the total number of Monte Carlo tests. From the figure, when  $Q = 16$ , the estimation is optimal even without diversity schemes; while for  $Q = 32$ , 4 times diversity case outperforms the no diversity case since its MSE curve is much closer to the CRB. For all three cases, the MSE curves of the effective CFO estimation approach their best performance for SNR greater than  $-6$  dB.

To quantify the performance of the CFO estimation, the normalized root mean square error (RMSE) of the estimates is used and it is defined as

$$\text{Normalized RMSE} = \sqrt{\frac{1}{K\Pi} \sum_{\rho=1}^{\Pi} \sum_{k=1}^K [\hat{\xi}_{\rho}^{(k)} - \xi_{\rho}^{(k)}]^2}, \quad (31)$$

where  $K$  is the number of users,  $\Pi$  is the total number of Monte Carlo tests and  $\hat{\xi}_{\rho}^{(k)}$  is the estimate of  $\xi_{\rho}^{(k)}$ . The subscript  $(\cdot)_{\rho}$  denotes the index of the Monte Carlo test. In each Monte Carlo test, we randomly generate a CFO and a multipath channel for each user. The normalized RMSE is computed after averaging over all participated users for 400 independent Monte Carlo tests. All user data symbols were independent QPSK symbols. The SNR of the  $k$ th user is defined as  $\text{SNR}^{(k)} = E[|\Upsilon^{(k)}(n)|^2]/\sigma^2$ .

#### Example 1

In this example, we applied the proposed structure based algorithm using the signal samples of one OFDMA block. All  $\text{SNR}^{(k)}$ ,  $k = 1, 2, \dots, K$ , are assumed to be same at the uplink receiver and each user only occupies one sub-channel in one OFDMA block. First, we divided the 2048 subcarriers into 16 sub-channels and calculated the normalized RMSE of the estimation algorithm for  $K = 4, 8, 12$ , respectively. The results are presented in Fig. 4(a). In Fig. 4(b), the 2048 subcarriers were divided into 32 sub-channels and the normalized RMSE is plotted for  $K = 16, 20, 24$ , respectively.

We observe that the normalized RMSE of the proposed algorithm increases when the number of users in one OFDMA

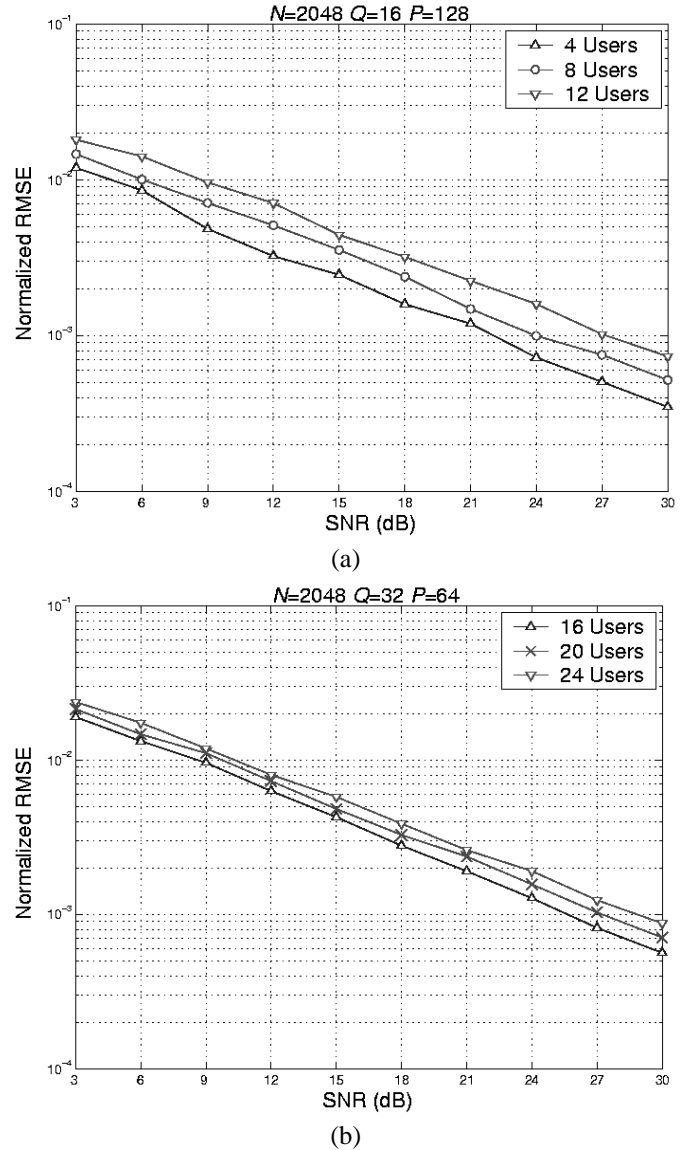

Fig. 4. The normalized RMSE vs. SNR when different number of users present in one OFDMA block. (a) 16 sub-channels, each sub-channel has 128 subcarriers. (b) 32 sub-channels, each sub-channel has 64 subcarriers.

block increases. If the OFDMA system is operating in moderate or high SNR (10 dB or higher), the normalized RMSE of the proposed algorithm is less than 1% of the subcarrier spacing. If the uplink receiver SNR is low such as 3 dB, the normalized RMSE is only around 2% of the subcarrier spacing. The sensitivity of the OFDMA system to CFO depends on SNR. The system performance degradation is more serious under high SNR than low SNR when the same amount of normalized CFO is presented [8] [14]. In fact, when the receiver SNR of the OFDMA system is lower than 10 dB, the system degradation caused by CFO smaller than 5% is less than 1 dB in output SNR [8].

The estimation error for a single user,  $\epsilon^{(k)} = \hat{\xi}^{(k)} - \xi^{(k)}$ , in each simulation test is also recorded and its distribution in different cases are presented in Fig. 5. It is possible that, in one simulation test, the estimates for a few users may have



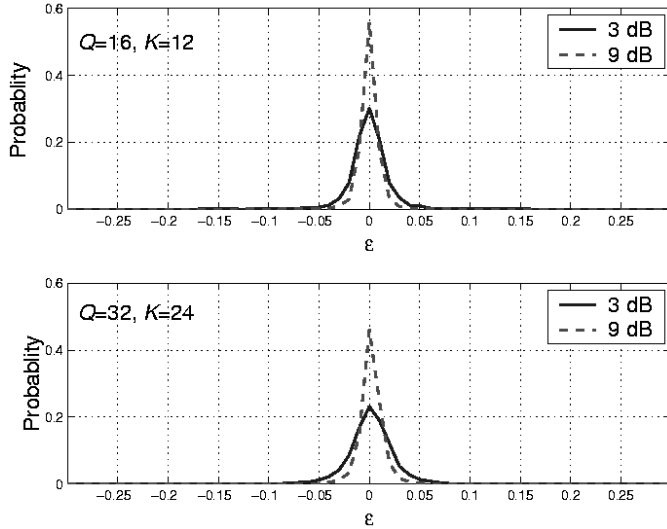

Fig. 5. The distribution of  $\epsilon^{(k)} = \hat{\xi}^{(k)} - \xi^{(k)}$ . Upper: 16 sub-channels and 12 users; lower: 32 sub-channels and 24 users.

large errors such as 10% of the subcarrier spacing while the estimation errors for the other users in the same OFDMA block are less than 1% of the subcarrier spacing. From Fig. 5, we observed that when the receiver SNR increases, the distribution of estimation error,  $\epsilon$ , is more centralized.

Particularly, the estimated effective CFO of a user at sub-channel  $\{q\}$  may exceed the range of  $(\frac{q-0.5}{Q}, \frac{q+0.5}{Q})$  under low SNR. This kind of estimation error is defined as mismatch. In Table I, we collected the probability of mismatch observed from the simulation. Notice that, when 24 users are simultaneously transmitting signals in an OFDMA system with 32 sub-channels, the mismatch probability is relatively high if the SNR is low. This can be alleviated by incorporating diversity schemes as shown below.

#### Example 2

In this example, we investigate the performance of the proposed algorithm when diversity schemes are deployed at the uplink receiver. Multiple receive antennas are applied. The estimations are carried out using 2 receive antennas (4096 signal samples, diversity order 2) and 4 receiver antennas (8192 signal samples, diversity order 4). The normalized RMSE are plotted in Fig. 6(a) for 12 users in a 16 sub-channels setup and in Fig. 6(b) for 24 users in a 32 sub-channels setup. The normalized RMSE without diversity scheme (2048 signal samples) are also plotted in each case for comparison.

As expected, the mismatch probability of the proposed algorithm decreases when diversity schemes are adopted and the results are also listed in Table I. Note that in the case of 32 sub-channels and 24 users the mismatch probability decreases to 0.96% when 4-branch diversity is adopted under 3 dB SNR. This indicates that the proposed algorithm is applicable for low SNR.

#### Example 3

In Fig. 7, we show the change of the normalized RMSE performance of the CFO estimation according to the variation of the system load. The system load is defined here as the

TABLE I  
MISMATCH PROBABILITY

$Q, K$		Mismatch Probability		
No Diversity		SNR=3 dB	SNR=6 dB	SNR=9 dB
$Q = 16$	$K = 8$	0.67%	0.27%	0.16%
	$K = 12$	1.27%	0.92%	0.32%
$Q = 32$	$K = 20$	4.86%	4.31%	0.91%
	$K = 24$	6.66%	4.48%	3.37%
With Diversity (SNR=3 dB)		No diversity	2× diversity	4× diversity
$Q = 16$	$K = 12$	1.27%	0.63%	0.42%
$Q = 32$	$K = 24$	6.66%	1.92%	0.96%

ratio of the number of concurrent active users in one OFDMA block versus the maximum number of users supported by one block. In this simulation, it is given by  $\eta = K/K_{\max}$  and expressed in percentage values. From Fig. 7, the normalized RMSE is a monotonically increasing function of  $\eta$ , hence the less the number of users in one OFDMA block, the better the performance. The slope of the curves illustrate how fast the performance is decreasing with the increasing of system load. It is observed from Fig. 7 that the normalized RMSE performance of the system with  $Q = 16$  declines faster than the system with  $Q = 32$ .

#### Example 4

In this example, we illustrate the usefulness of the estimation algorithm in terms of the receiver BER performance improvement. Based on the estimated CFO, we adopted the minimum mean square error (MMSE) synchronization algorithm proposed in [18] to restore the orthogonality among all users. The simulation results are given in Fig. 8. In order to show the performance improvement solely resulted from the CFO estimation and the frequency synchronization, we select the uncoded BER as the measurement. The channel knowledge is assumed to be perfectly known. For comparison purpose, we also plotted the uncoded BER if there is no synchronization effort. It is shown that, without synchronization effort, the uncoded BER has an error floor bounded around 0.2. With the MMSE synchronization algorithm based on the estimation of CFO, the BER curves manifest a significant improvement. Applying diversity schemes to get more accurate estimates of CFO, the BER performance is superior than that without diversity schemes, as expected.

#### C. Comparison

In this part, we compare the performance of the proposed structure based estimation algorithm with that of the statistics based algorithm proposed in [19] in an AWGN environment.

The simulated OFDMA system has 64 subcarriers and 8 users. Each user occupies 8 subcarriers in an interleaved fashion. CP is 24, in which the first 16 samples are intended for eliminating the effect of channel delay spread. The last 8 signal samples of CP and the remaining 64 signal samples of the OFDMA compose a  $9 \times 8$  signal matrix for the structure based algorithm.

The statistics required by the algorithm in [19] are calculated over 32 consecutive OFDMA blocks including CP. We simulate the structure based algorithm by using the first 8,

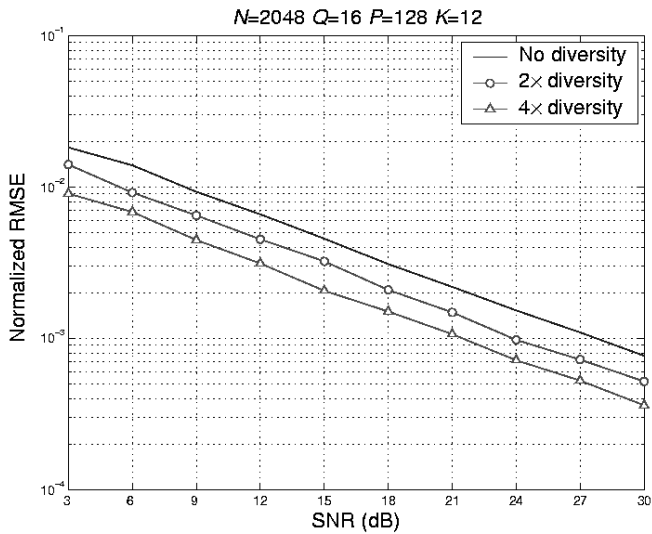

(a)

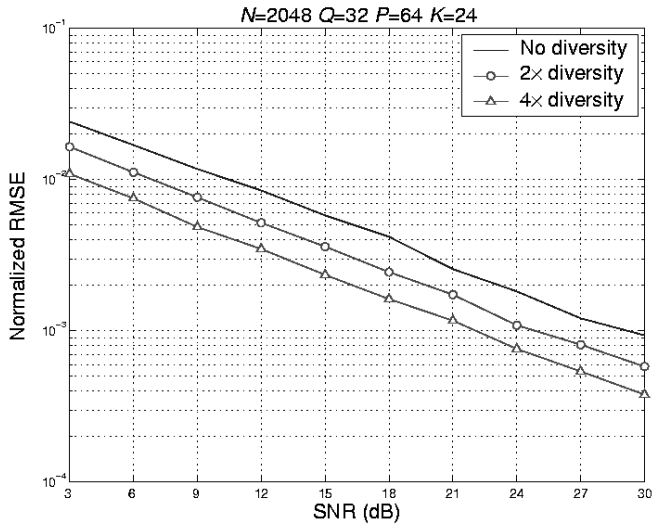

(b)

Fig. 6. The normalized RMSE vs. SNR when diversity schemes are adopted at the uplink receiver. No diversity, 2× diversity and 4× diversity are compared. (a) 16 sub-channels and 12 users. (b) 32 sub-channels and 24 users.

16, 24 and all 32 OFDMA blocks, respectively. The resulted normalized RMSE are shown in Fig. 9.

Due to the presence of bias, the normalized RMSE resulted from the statistics based algorithm is around 3 and more or less independent of SNR. Note that the simulation results presented in [19] is the mean square error (MSE) of the estimated CFO. For fair comparison, we presented the normalized RMSE for both algorithms, which is the square root of the MSE multiplying the number of subcarriers  $N$ . From Fig. 9, the structure based algorithm proposed in this paper outperforms the statistics based algorithm.

### VI. CONCLUSION

A signal structure based deterministic estimation algorithm is proposed in this paper for estimating the carrier frequency offsets of all users simultaneously in the uplink of OFDMA

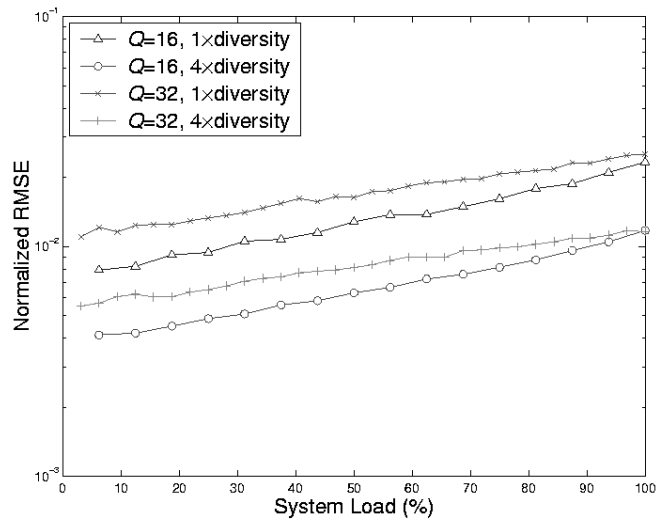

Fig. 7. The normalized RMSE performance versus the system load (SNR=5 dB). The system load is defined as the ratio of the current active users in one OFDMA block and the maximum number of supported users in a block.

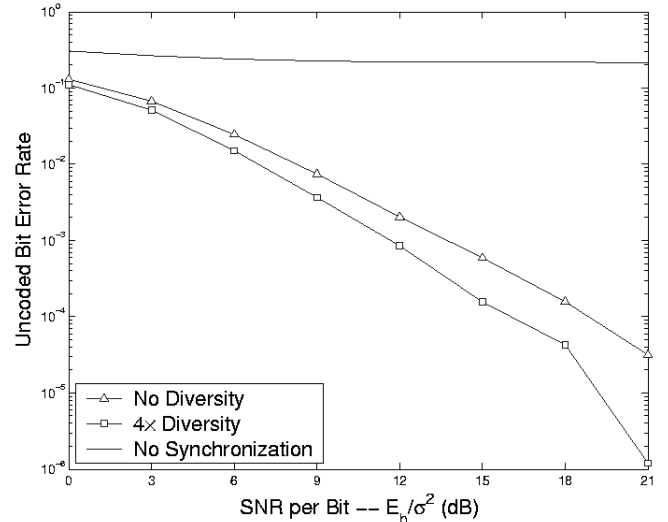

Fig. 8. The uncoded bit error rate performance versus the per-bit signal-to-noise ratio.  $Q = 32$  and  $K = 24$ .

systems with the interleaved subcarrier assignment. The inner algebraic structure of the signals at the uplink receiver is exploited for CFO estimation. The algorithm is computationally efficient in that it only requires signal samples of one OFDMA block. Simulation results indicate that it preforms well even under low SNR with diversity schemes. The algorithm presented here shows great potential for OFDMA systems using the interleaved subcarrier assignment in the uplink to reap diversity gains in frequency selective fading channels.

### ACKNOWLEDGEMENT

The authors would like to thank the reviewers and the paper editor for their valuable comments and suggestions.

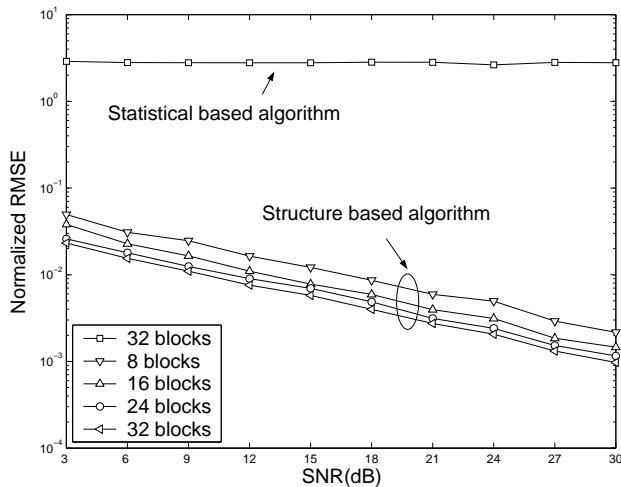

Fig. 9. Comparison between the proposed structure based algorithm and the statistical based algorithm in [19]

## REFERENCES

- [1] J. Bingham, "Multicarrier modulation for data transmission: an idea whose time has come," *IEEE Commun. Mag.*, vol. 28, no. 5, pp. 5–14, May 1990.
- [2] *Digital Audio Broadcasting (DAB) to mobile, portable and fixed receiver*, ETSI Std. ETS 300 401, May 2001.
- [3] *Digital video broadcasting (DVB-T): Frame structure, channel coding, and modulation for digital terrestrial television*, ETSI Std. ETS 300 744, Dec. 2001.
- [4] *Supplement to IEEE Std. 802.11, Wireless LAN media access control (MAC) and physical layer (PHY) specifications: high-speed physical layer in the 5GHz band*, IEEE Std. 802.11a, 2001.
- [5] *Broadband radio access network (BRAN): HIPERLAN type 2 functional specification Part 1 – Physical layer*, ETSI Std. ETS/BRAN 030 003-1, Jun. 1999.
- [6] *Air Interface for Fixed Broadband Wireless Access Systems—Amendment 2: Medium Access Control Modifications and Additional Physical Layer Specifications for 2-11 GHz*, IEEE Std. 802.16a, 2003.
- [7] T. Pollet, M. V. Bladel, and M. Moeneclaey, "BER sensitivity of OFDM systems to carrier frequency offset and Wiener phase noise," *IEEE Trans. Commun.*, vol. 43, pp. 191–193, February/March/April 1995.
- [8] A. M. Tonello, N. Laurenti, and S. Pupolin, "Analysis of the uplink of an asynchronous multi-user DMT OFDMA system impaired by time offsets, frequency offsets, and multi-path fading," in *VTC Conference Record*, vol. 3, October 2000 Fall, pp. 1094–1099.
- [9] J. Li, G. Liu, and G. B. Giannakis, "Carrier frequency offset estimation for OFDM-base WLANs," *IEEE Signal Process. Lett.*, vol. 8, no. 3, pp. 80–82, Mar 2001.
- [10] U. Tureli, H. Liu, and M. D. Zoltowski, "OFDM blink carrier offset estimation: ESPRIT," *IEEE Trans. Commun.*, vol. 48, no. 9, pp. 1459–1461, September 2001.
- [11] H. Liu and U. Tureli, "A high-efficiency carrier estimator for OFDM communication," *IEEE Commun. Lett.*, vol. 2, no. 4, pp. 104–106, April 1998.
- [12] T. M. Schmidl and D. C. Cox, "Blind synchronization for OFDM," *Electronics Letters*, vol. 33, no. 2, pp. 113–114, February 1997.
- [13] M. Luise and R. Reggiannini, "Carrier frequency acquisition and tracking for OFDM systems," *IEEE Trans. Commun.*, vol. 44, no. 11, pp. 1590–1598, November 1996.
- [14] P. H. Moose, "A technique for orthogonal frequency division multiplexing frequency offset correction," *IEEE Trans. Commun.*, vol. 42, no. 10, pp. 2908–2914, October 1994.
- [15] J. J. Beek, P. O. Börjesson, M. L. Boucheret, D. Landström, J. Arenas, P. Ödling, C. Östberg, M. Mahlvist, and S. K. Wilson, "A time and frequency synchronization scheme for multiuser OFDM," *IEEE J. Select. Areas Commun.*, vol. 17, no. 11, pp. 1900–1914, November 1999.
- [16] J. Choi, C. Lee, H. W. Jung, and Y. H. Lee, "Carrier frequency offset compensation for uplink of OFDM-FDMA systems," *IEEE Commun. Lett.*, vol. 4, no. 12, pp. 414–416, December 2000.
- [17] S. Barbarossa, M. Pompili, and G. B. Giannakis, "Channel-independent synchronization of orthogonal frequency division multiple access systems," *IEEE J. Select. Areas Commun.*, vol. 20, no. 2, pp. 474–486, February 2002.
- [18] Z. Cao, U. Tureli, and Y. D. Yao, "Analysis of two receiver schemes for interleaved OFDMA uplink," in *IEEE 36th Asilomar Conference on Signals, Systems, and Computers*. IEEE, November 2002.
- [19] H. Bölcskei, "Blind high-resolution uplink synchronization of OFDM-based multiple access schemes," in *Proc. 2nd IEEE Workshop on Signal Processing Advances in Wireless Communications*. IEEE, 1999, pp. 166–169.
- [20] P. Stoica and R. Moses, *Introduction to spectral analysis*. Prentice-Hall, 1997.
- [21] U. Tureli, D. Kivanc, and H. Liu, "Experimental and analytical studies on a high resolution OFDM carrier frequency offset estimator," *IEEE Trans. Vehic. Technol.*, vol. 50, no. 2, pp. 629–643, March 2001.
- [22] J. M. Ortega, *Matrix theory*. Plenum Press, 1987.
- [23] S. Kapoor, D. J. Marchok, and Y.-F. Huang, "Adaptive interference suppression in multiuser wireless OFDM systems using antenna arrays," *IEEE Trans. Signal Processing*, vol. 47, no. 12, pp. 3381–3391, December 1999.
- [24] R. O. Schmidt, "Multiple emitter location and signal parameter estimation," in *Proc. RADC Spectral Estimation Workshop*. Griffiss AFB, NY, 1979, pp. 243–258.
- [25] R. Roy, A. Paulraj, and T. Kailath, "ESPRIT—a subspace rotation approach to estimation of parameters of cisoids in noise," *IEEE Trans. on Acoust., Speech, Signal Processing*, vol. ASSP-34, pp. 1340–1342, February 1986.
- [26] H. Li, P. Stoica, and J. Li, "Computationally efficient parameter estimation for harmonic sinusoidal signals," *Signal Processing*, vol. 80, no. 11, pp. 1937–1944, 2000.
- [27] B. Chen and H. Wang, "Maximum likelihood estimation of OFDM carrier frequency offset," in *Proceedings of the IEEE International Conference on Communications*, vol. 1, May 2002, pp. 49–53.
- [28] U. Tureli, D. Kivanc, and H. Liu, "Multicarrier synchronization with diversity," in *VTC Conference Record*, vol. 2, October 2001 Fall, pp. 146–155.
- [29] S. Kaiser and W. A. Krzymien, "Performance effects of the uplink asynchronism in a spread spectrum multi-carrier multiple access system," *European Transaction on Communications*, vol. 10, no. 4, pp. 399–406, July-August 1999.
- [30] O. Edfors, M. Sandell, J.-J. Beek, S. K. Wilson, and P. O. Börjesson, "OFDM channel estimation by singular value decomposition," *IEEE Trans. Commun.*, vol. 46, no. 7, pp. 931–939, July 1998.
- [31] P. Stoica and A. Nehorai, "MUSIC, maximum likelihood, and cramer-rao bound," *IEEE Trans. on Acoust., Speech, Signal Processing*, vol. 37, no. 5, pp. 720–741, May 1989.



**Zhongren Cao** (S'01) received the B.Eng. degree from Xi'an JiaoTong University, Xi'an, China, in 1997, and the M.Eng. degree from Shanghai Jiao-Tong University, Shanghai, China, in 2000, both in electrical engineering. He is currently working towards the Ph.D. degree in the Department of Electrical and Computer Engineering, Stevens Institute of Technology.

His research interests are in the areas of communications, signal processing, networking and software defined radio based system prototype. Recently, his research focuses on broadband multicarrier systems for wireless local area network (WLAN), wireless metropolitan area network (WMAN) and ultra-wideband (UWB) systems, including multiple access issues, frequency synchronization, channel estimation, MIMO antenna array and system prototype.

He served as reviewer for various IEEE Journals and Conferences, including IEEE Transactions on Communications, IEEE Transactions on Wireless Communication, IEEE Transactions on Signal Processing, ICC, Globecom, VTC, WCNC, etc.



**Ufuk Tureli** (S'97-M'01) received the B.S. degree in 1994 from Bogazici University, Istanbul, Turkey, and the M.S. and Ph.D. degrees in 1998 and 2000 respectively from the University of Virginia, Charlottesville all in electrical engineering.

Dr. Tureli is currently an assistant professor at the Department of Electrical and Computer Engineering, Stevens Institute of Technology, Hoboken, New Jersey. His research interests include diversity and multiplexing for MIMO systems, multiuser communications and synchronization. He has published

numerous journal and conference articles for scalable, adaptive and robust broadband wireless communications applications.

Dr. Tureli's activities for the IEEE include reviewer duties for the IEEE Transactions on Communications and numerous other IEEE journals and conferences. He has served as a chair or on the organizing and technical committees for numerous international conferences. He is a member of the IEEE Communications Society.



**Yu-Dong Yao** (S'88-M'88-SM'94) received the B.Eng. and M.Eng. degrees from Nanjing University of Posts and Telecommunications, Nanjing, China, in 1982 and 1985, respectively, and the Ph.D. degree from Southeast University, Nanjing, in 1988, all in electrical engineering. Between 1989 and 1990, he was at Carleton University, Ottawa, as a research associate working on mobile radio communications.

He was with Spar Aerospace Ltd., Montreal, between 1990 and 1994, where he was involved in research on satellite communications. He was

with Qualcomm Inc., San Diego, from 1994 to 2000, where he participated in research and development in wireless CDMA systems. Dr. Yao joined Stevens Institute of Technology, Hoboken, New Jersey, in 2000. He is an associate professor in the Department of Electrical and Computer Engineering and a director of Wireless Information Systems Engineering Laboratory (WISELAB).

Dr. Yao holds one Chinese patent and seven U.S. patents. He is an associate editor of IEEE Communications Letters and IEEE Transactions on Vehicular Technology, and an editor of IEEE Transactions on Wireless Communications. He is a guest editor for a special issue on wireless networks for International Journal of Communication Systems. His research interests include wireless communications and networks, spread spectrum and CDMA, and DSP for wireless systems.