

**An-Najah National University
Faculty of Graduate Studies**

**Developing a Computer Program for Analysis and
Design of Reinforced Concrete Sections; AD RCS**

**By
Ibrahim Muhammad Ahmad Mahmood**

**Supervisor
Dr. Abdul Razaq Touqan**

**Submitted in Partial Fulfillment of the Requirements for the Degree of Master of
Science in Structural Engineering, Faculty of Graduate Studies, at An-Najah
National University, Nablus, Palestine.**

2004

**Developing a Computer Program for Analysis and Design of
Reinforced Concrete Sections; AD RCS**

By
Ibrahim Muhammad Ahmad Mahmood

This Thesis was defended successfully on 22/6/2004 and approved by:

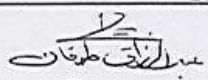
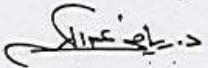
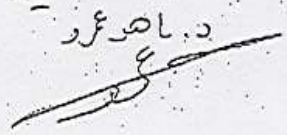
<u>Committee Members</u>	<u>Signature</u>
1. Dr. Abdul Razaq Touqan	
2. Dr. Riyad Abdul Kareem	
3. Dr. Mahir Amr	

To My Parents, Wife and Children

Acknowledgements

I wish to express my appreciation and grateful acknowledgments to my supervisor, Dr. Abdul Razaq Touqan for his hard work and encouragement in this thesis. Grateful acknowledgement is also made to the Department of Civil Engineering at An-Najah National University.

Special grateful acknowledgement is made to my family for their help and encouragement, especially my wife.

Table of Contents

ID	Subject	Page
-----------	----------------	-------------

	Chapter One: Introduction	1
1.1	Computer Programs and the Structural Engineering	1
1.2	Arabic Structural Engineering Programs	4
1.3	Available Computer Programs for Analyzing and Designing of Reinforced Concrete Sections	4
1.4	The Importance of the Program	5
1.5	Programming Language and Style	6
1.6	The Thesis Composition	7
	Chapter Two: Theory of Analysis and Design of Reinforced Concrete Sections	8
2.1	Introduction	8
2.2	Analysis and Design of Reinforced Concrete Sections for flexure	8
2.2.1	Analysis of Singly Reinforced Rectangular Beam Section for Flexure	9
2.2.2	Analysis of Doubly Reinforced Rectangular Beam Section for Flexure	13
2.2.3	Design of Rectangular Beam Section for Flexure	17
2.2.4	Analysis of T and L Beam Sections for Flexure	23
2.2.5	Design of Flanged Beam Section for Flexure	32
2.3	Analysis and Design for Shear and Torsion	37
2.3.1	Determining Concrete Shear Capacity	37
2.3.2	Determining Required Shear Reinforcement	38
2.3.3	Section Analysis for Shear	40
2.3.4	Design for Shear and Torsion	42
2.4	Analysis and Design of Column Section for Combined Bending and Axial Forces	54
2.4.1	Section Analysis	55
2.4.2	Uniaxial Bending Moment-Axial Force interaction Diagram	58
2.4.3	Moment Magnification	61
2.4.3.1	Non-sway Columns	61
2.4.3.2	Sway Columns	63
2.4.4	Load Contour Method	70
2.4.5	Column Design Shear Force	71
2.5	Analysis and Design of Single Footing	82
2.5.1	Single Footing Analysis	82
2.5.1.1	Computing Soil Resisting Force	82
2.5.1.2	Computing Flexural Resisting Force	83
2.5.1.3	Computing Wide Beam Shear Resisting Force	83

2.5.1.4	Computing Punching Shear Resisting Force	83
2.5.2	Single Footing Design	84
2.5.2.1	Computing Footing Area	84
2.5.2.2	Computing Footing Depth from Wide Beam Shear	85
2.5.2.3	Computing Footing Depth from Punching Shear	86
2.5.2.4	Computing Flexural Reinforcement	86
	Chapter Three: The Program Composition	97
3.1	General	97
3.2	Language and Units	97
3.3	The Program Main Menu	98
3.4	The File Menu	100
3.4.1	The New Project Submenu	100
3.5	The Edit Menu	100
3.6	The Define Menu	101
3.6.1	The Materials Submenu	101
3.6.2	The Sections Submenu	102
3.6.3	The Design Load Combinations Submenu	106
3.7	The Select Menu	107
3.8	The Assign Menu	107
3.8.1	The Sections Submenu	107
3.8.2	The Reinforcement Submenu	107
3.8.3	The Forces Submenu	111
3.8.4	The Reinforcement Design Options Submenu	113
3.9	The Analyze Menu	115
3.9.1	The Start Analyze/ Show Results Submenu	115
3.10	The Design Menu	144
3.10.1	The Redefine Element Design Data Submenu	144
3.10.2	Start Design Show Results Submenu	146
3.11	The Display Menu	204
3.11.1	The Show Sections Submenu	204
3.11.2	The Show Input Section Forces Submenu	204
3.11.3	The Show Input Sections Reinforcement Submenu	205
3.12	The Options Menu	206
3.12.1	The Preferences Submenu	206
3.13	The Help Menu	207
	Chapter Four: Quick Tutorials	209
4.1	Tutorial one	209
4.2	Tutorial two	222
	Chapter Five: Getting Started with the Program	233
5.1	Evaluating (Analyzing) Reinforced Concrete Sections	233
5.2	Designing Reinforced Concrete Sections	234

5.3	Getting Started with the Program	236
5.3.1	Language and Units	236
5.3.2	Starting a New Project	236
5.3.3	The Define Menu	236
5.3.3.1	The Materials Submenu	237
5.3.3.2	The Sections Submenu	237
5.3.3.3	The Design Load Combinations Submenu	238
5.3.4	The Assign Menu	238
5.3.4.1	The Sections Submenu	238
5.3.4.2	The Forces Submenu	238
5.3.4.3	The Reinforcement Submenu	239
5.3.4.4	The Reinforcement Design Options Submenu	240
5.3.5	The Analyze Menu	241
5.3.6	The Design Menu	242
5.3.6.1	The Start Design Show Results Submenu	242
5.3.6.2	The Redefine Element Design Data Submenu	243
5.3.7	The Options Menu	244
8.3.8	The Help Menu	244
5.3.9	Saving and Opening Files	244
5.3.10	Printer Setup	244
5.4	Brief Steps in Using AD RCS	245
5.5	The Programming Language	246
	Chapter Six: Problems Verification	247
6.1	Problem One: Design of Rectangular Beam Section for Bending, Shear and Torsion	247
6.2	Problem Two: Design of a long column with various loads	253
6.3	Problem Three: Design of a Single Footing	261
	Chapter Seven: Remarks and Recommended Future Works	265
	Bibliography	266
	中區(株)ニカツ	≠

List of Figures

Figure		Page
Figure 1.1	The design_ analysis cycle	2
Figure 2.1	Stress and strain distribution across beam section	9
Figure 2.2	Flowchart to calculate ρ_{\min} , subroutine Rho_Min	11
Figure 2.3	Flowchart to find the value of β_1 , subroutine Beta_1	12
Figure 2.4	Flowchart to calculate ρ_{\max} , subroutine Rho_Max_ Rectangle	12
Figure 2.5	Doubly reinforced beam section	13
Figure 2.6	Flowchart for analysis of rectangular beam section for flexure, subroutine Rectangular_Beam_Analysis	15
Figure 2.7	Flowchart to calculate a and a_{\max} , subroutine Compression_Block_Depth	20
Figure 2.8	Flowchart to calculate A_s in rectangular section, subroutine rectangular_Beam_Design	21
Figure 2.9	Flowchart to set final value of A_s , subroutine steel_Area	22
Figure 2.10	Flowchart to design rectangular section for bending, Subroutine Rectangular_Section_Design	23
Figure 2.11	T-beam section with neutral axis within the flange	24
Figure 2.12	Stress and strain in flanged section	25
Figure 2.13	Flowchart for analysis of flanged beam, subroutine Flanged_Beam_Analysis	28
Figure 2.14	Flowchart to calculate maximum steel ratio in flanged section, subroutine RhoMax_FlangedSection	32
Figure 2.15	Flowchart for design of flanged section for bending moment, subroutine Flanged_Beam_Design	36
Figure 2.16	Flowchart for calculating V_c , subroutine Concrete_Shear_Capacity	39
Figure 2.17	Flowchart to find shear S_{\max} , subroutine Shear_Maximum_Spacing	41
Figure 2.18	Flowchart to compute capacity of shear reinforcement, subroutine ShearReinforcement_Capacity_Vs	43
Figure 2.19	Flowchart to compute maximum allowed shear capacity of reinforcement, subroutine Shear_Vsmax	43
Figure 2.20	Flowchart to compute A_v/s and A_t/s variables, subroutine Shear_AvOverS_AtOverS	43
Figure 2.21	Flowchart to calculate shear capacity for given shear reinforcement, subroutine Section_Design	44

	Shear Capacity	
Figure 2.22	Flowchart to calculate V_n and V_d , subroutine Shear_Vn_Vs	45
Figure 2.23	Flowchart to calculate V_s for shear design, subroutine Shear_Vs_ForDesign	48
Figure 2.24	Flowchart for design of shear force, subroutine Shear_Design1	49
Figure 2.25	Flowchart to calculate section properties for torsion computations, subroutine Torsion_Section_Properties	50
Figure 2.26	Flowchart to calculate T_{min} , subroutine Torsion_Tmin	50
Figure 2.27	Flowchart to check section adequacy for torsion, subroutine Torsion_Shear_Section_Adequacy	50
Figure 2.28	Flowchart to find the maximum allowed spacing of stirrups for torsion, subroutine Torsion_Stirrups_MaximumSpacing	51
Figure 2.29	Flowchart to calculate the longitudinal steel for torsion, subroutine Torsion_LongitudinalSteel	51
Figure 2.30	Flowchart for shear and torsion design, subroutine Shear_Torsion_Design	52
Figure 2.31	Stress and strain distribution in column section	55
Figure 2.32	Flowchart to calculate force and moment developed in rows of reinforcement, subroutine reinforcementRow_Force_Moment	56
Figure 2.33	Flowchart to calculate the force and the moment at the balanced section, subroutine column_Balanced_Condition	59
Figure 2.34	Flowchart to calculate ϕ , subroutine Phi_Column	59
Figure 2.35	Flowchart to calculate C_m , subroutine Column_Cm	65
Figure 2.36	Flowchart to calculate P_{cr} , subroutine Column_Pcr	66
Figure 2.37	Flowchart to calculate radius of gyration, r , subroutine Column_Rg	66
Figure 2.38	Flowchart to calculate kl_u/r , subroutine KLRfactor	66
Figure 2.39	Flowchart for checking kl/r for sway and nonsway columns, subroutine Column_CheckKLRfactor	67
Figure 2.40	Flowchart to calculate δ_{ns} , subroutine Column_DeltaNs	68
Figure 2.41	Flowchart to determine final value of δ_{ns} , subroutine Column_DeltaNs1	68
Figure 2.42	Flowchart to calculate the design moment at a point,	69

	M_u , subroutine Column_Mu	
Figure 2.43	Flowchart to calculate the column section axial capacity, subroutine Ultimate_Axial_Capacity	72
Figure 2.44	Flowchart to calculate the column tension capacity, subroutine Tension_Axial_Capacity	72
Figure 2.45	Flowchart to calculate the value $0.1f_cA_g$, subroutine Column_Pmin	72
Figure 2.46	Flowchart to calculate pure bending moment capacity, Subroutine Column_Pure_Moment	73
Figure 2.47	Flowchart to calculate bending moment capacity at axial force equals $0.1f_cA_g$, subroutine column_Moment_OnetenthFcAg	74
Figure 2.48	Flowchart to calculate bending moment capacity at axial force equal 0.8 the maximum axial capacity, subroutine Column_Moment_EightyPercent	75
Figure 2.49	Flowchart to find column P_M interaction points (2 points) at axial loads between 0.8 the maximum axial capacity and the balanced axial capacity, subroutine InteractionPoints_BalEightyPercent	76
Figure 2.50	Flowchart to calculate the biaxial factor, subroutine Column_Biaxial_Factor	76
Figure 2.51	Flowchart to calculate bending moment capacity at a given axial force, subroutine Column_Mo	77
Figure 2.52	Flowchart for construction of axial force_bending moment interaction diagram, subroutine Column_PM_Diagram	78
Figure 2.53	Flowchart to determine minimum bars in column section, subroutine Column_MinBars	78
Figure 2.54	Flowchart to calculate total no. of bars and total steel area for given bars arrangement, subroutine column_BarsNo_AstTotal	79
Figure 2.55	Flowchart to find A_s and d for reinforcement rows, subroutine Column_Reinforcement_Area_Depth	79
Figure 2.56	Flowchart to calculate the no. of bars and bar area for given bars arrangement for a steel ratio, subroutine Column_Design_Given_BarsArrangement	80
Figure 2.57	Flowchart to calculate BarsH and BarsB from given bar diameter for a steel ratio, subroutine column_Design_Given_BarDiam	81
Figure 2.58	Flowchart to calculate P_u from soil capacity. Subroutine Footing_PuBearingCapacity	88

Figure 2.59	Flowchart to calculate Pu from wide beam shear capacity, subroutine Footing_PuWide	88
Figure 2.60	Flowchart to calculate shear capacity, subroutine Shear_Capacity_WithoutAxial_Vc	89
Figure 2.61	Flowchart to calculate Pu from punching shear resistance, subroutine Footing_PuPunching	90
Figure 2.62	Flowchart to calculate the allowable punching stresses, subroutine Footing_Punching_Vcp	91
Figure 2.63	Flowchart to calculate β_c : ratio of longer to shorter Dimensions of column, subroutine footing_Punching_BetaC	91
Figure 2.64	Flowchart to calculate the area for punching shear computations, subroutine Footing_Punching_Area	92
Figure 2.65	Flowchart to calculate minimum steel area in footing section, subroutine Footing_MinSteel	92
Figure 2.66	Flowchart to calculate Pu from flexural reinforcement capacity, subroutine Footing_PuBending	93
Figure 2.67	Flowchart to calculate soil stress, Qu, subroutine Footing_Qu	93
Figure 2.68	Flowchart to calculate the bending moment, Mu at face of column due to Qu, subroutine Footing_Mu	94
Figure 2.69	Flowchart to calculate the shear force, Vu at face of column, subroutine Footing_Vu	94
Figure 2.70	Flowchart to compute footing dimensions, subroutine Footing_Design_Area	94
Figure 2.71	Flowchart to calculate footing effective depth from wide beam shear, subroutine Footing_WideShear_Df	95
Figure 2.72	Flowchart to calculate footing effective depth from punching shear, subroutine footing_Punching_Df	95
Figure 2.73	Flowchart to calculate the net axial load on the footing, subroutine Footing_Punet	96
Figure 2.74	Flowchart to calculate areas of steel in short direction of footing, subroutine Footing_Rectangle_Reinforcement_ShortDirection	96
Figure 3.1	Language and units dialog box	98
Figure 3.2a	Program screen (English)	99
Figure 3.2b	Program screen (Arabic)	99
Figure 3.3	New Project dialog box	100
Figure 3.4	Add dialog box	101

Figure 3.5	Insert dialog box	101
Figure 3.6	Modify dialog box	101
Figure 3.7	Define Materials dialog box	102
Figure 3.8	Material Property Data dialog box	102
Figure 3.9	Define Sections dialog box	103
Figure 3.10	Show Section dialog box	103
Figure 3.11	Beam Data dialog	104
Figure 3.12	Column Data dialog	104
Figure 3.13	Define Footing dialog	104
Figure 3.14	Define Load Combinations dialog	106
Figure 3.15	Assign Beam Reinforcement dialog	108
Figure 3.16	Assign Column Reinforcement dialog	108
Figure 3.17	Assign Footing Dimensions and Reinforcement for Analysis dialog	109
Figure 3.18	Assign Beam Forces dialog	111
Figure 3.19	Assign Column Forces dialog	111
Figure 3.20	Assign Beam Reinforcement dialog	113
Figure 3.21	Assign Column Reinforcement / Bars layout dialog	113
Figure 3.22	Assign Column Reinforcement / Bars diameter dialog	114
Figure 3.23	Show Analysis Output dialog	116
Figure 3.24	Flowchart for the subroutine of Start Analysis/ how Results submenu	116
Figure 3.25a	Flowchart for beam section column analysis, subroutine Element_Analysis (J1)	119
Figure 3.25b	Flowchart for column section analysis, subroutine Element_Analysis (J1)	125
Figure 3.26	Show Footing Analysis dialog	129
Figure 3.27	Flowchart for footing analysis	130
Figure 3.28a	Axial force-shear force interaction diagram	137
Figure 3.28b	Interaction points of axial force_ shear interaction diagram	137
Figure 3.29a	Axial force_ bending moment interaction diagram in the major direction	138
Figure 3.29b	Interaction points of the axial force_ bending moment interaction diagram	138
Figure 3.29c	Calculating moment value at a certain axial force	139
Figure 3.30	Flowchart of the subroutine that calculates points of the axial force_ bending moment interaction diagram in column major direction	141
Figure 3.31	Flowchart of the subroutine that calculates points of	142

	the axial force_bending moment interaction diagram in column minor direction	
Figure 3.32	Redefine Element Design Data dialog	144
Figure 3.33	Show Design Output dialog	146
Figure 3.34	Flowchart for Start Design/ Show Results subroutine	147
Figure 3.35a	Flowchart of the subroutine Element_Design (I1)	156
Figure 3.35b	Flowchart of the subroutine Element_Design (I1), column design for axial and bending	165
Figure 3.35c	Flowchart of the subroutine Element_Design (I1), design for shear and torsion	183
Figure 3.36	Show Bars Layout dialog	194
Figure 3.37	Change Bars Diameters dialog	195
Figure 3.38	Show Design Output dialog for output results of load combinations	195
Figure 3.39	Show Column Section Design dialog	196
Figure 3.40	Show Footing Design dialog	196
Figure 3.41	Show Bars Layout dialog/ Footing	197
Figure 3.42	Change Bars Diameters dialog/ Footing	197
Figure 3.43	Flowchart for footing design	199
Figure 3.44	Show Design Sections dialog	204
Figure 3.45	Show Design Forces dialog	204
Figure 3.46	Show Reinforcement dialog	205
Figure 3.47	Show Section Shear Reinforcement dialog	205
Figure 3.48	Show Footing Dimensions and Reinforcement dialog	206
Figure 3.49	Preferences dialog	206
Figure 3.50a	A sample of English help	207
Figure 3.50b	A sample of Arabic help	208
Figure 4.1	Analysis and Design of Reinforced Concrete dialog box	210
Figure 4.2	Define Materials dialog box	210
Figure 4.3	Beam Data dialog box	213
Figure 4.4	Show Rectangular Section dialog box for section2	213
Figure 4.5	Assign FRSEC2 to ELSection2 element section	214
Figure 4.6	Assign Beam Reinforcement dialog box	215
Figure 4.7	Assign Column Reinforcement dialog box	216
Figure 4.8	Show Analysis Output dialog box	216
Figure 4.9	P-V2 Beam Interaction Diagram dialog box	217
Figure 4.10	Display Interaction Points of Beam 1 P-V2 dialog box	217

Figure 4.11	Show Beam Section Analysis dialog box	218
Figure 4.12	P-M3 column Interaction Diagram dialog box	219
Figure 4.13	Display Interaction Points of Column 2 P-M3 dialog box	220
Figure 4.14	Calculating Interaction Points dialog box	221
Figure 4.15	Show Column Section Analysis dialog box	221
Figure 4.16	Define Load Combinations dialog box	226
Figure 4.17	Assign Beam Forces dialog box	227
Figure 4.18	Assign Column Loads dialog box	227
Figure 4.19	Assign Beam Reinforcement dialog box	228
Figure 4.20	Assign Column Reinforcement dialog box	229
Figure 4.21	Show Design Output dialog box	229
Figure 4.22	Show Bars Layout dialog box for the beam section	230
Figure 4.23	Load combinations design output for the beam section	230
Figure 4.24	Show bars Layout dialog box for the column section	231

**Developing a Computer Program for Analysis and Design of Reinforced
Concrete Sections; AD RCS**

By

Ibrahim Muhammad Ahmad Mahmood

Supervisor

Dr. Abdul Razaq Touqan

Abstract

A need for a computer program to analyze and design reinforced concrete sections for both academic education and engineering offices' services is beyond doubt. Also, a need for having programs in Arabic language to help in communication of engineers graduated from all over the world is becoming increasingly important.

This thesis presents a computer program that tries to fulfill previous needs based on ACI code and presented in both Arabic and English languages, and uses local and international units.

The computer program; **Analysis and Design of Reinforced Concrete Sections; AD RCS**; is constructed using Visual Basic 6 programming language. The input and output data are performed using dialog boxes in windows environment.

The program has the ability of analyzing reinforced concrete sections of beams, columns and single footings and also design them for flexure, shear, axial and torsion. It also introduces capacity interaction diagrams and section reinforcement details.

The command buttons Column P_M3 Diagram and Column P_M2 diagram in the Show Design Results dialog in Figure 3.33, calculate the interaction points of the axial force-bending moment in the major and minor directions of the column respectively and then convert these points to drawings. The flowcharts of these command buttons were discussed in section 3.9.1 in the Start Analysis/Show Results submenu.

The command button Bars Layout displays reinforcement details for the section as shown in Figure 3.36 (**form name: BarsLayout, file: BarsLayout.frm**).

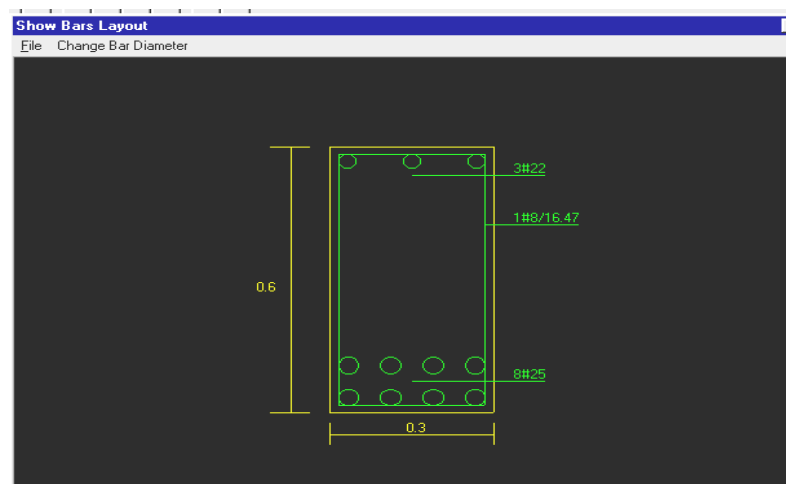

Figure 3.36 Show Bars Layout dialog

The bars diameters can be modified using the Change Bars Diameters dialog as shown in Figure 3.37 (**from name: ChangeBarDiameter, file: ChangeBarDiameter.frm**).

The command button Load Combinations displays the load combinations design results in the Show Design Output dialog as shown in Figure 3.38 (**form name: CombinationsOut, file: CombinationsOut**).



The dialog box titled "Change Bars Diameters" contains the following fields:

- Top Bars Diameter: 22
- Middle Bars Diameter (mm): 22
- Bottom Bars Diameter (mm): 25
- Stirrups Diameter (mm): 8
- No. of Stirrups in a Section: 1

Buttons: OK, Cancel

Figure 3.37 Change Bars Diameters dialog

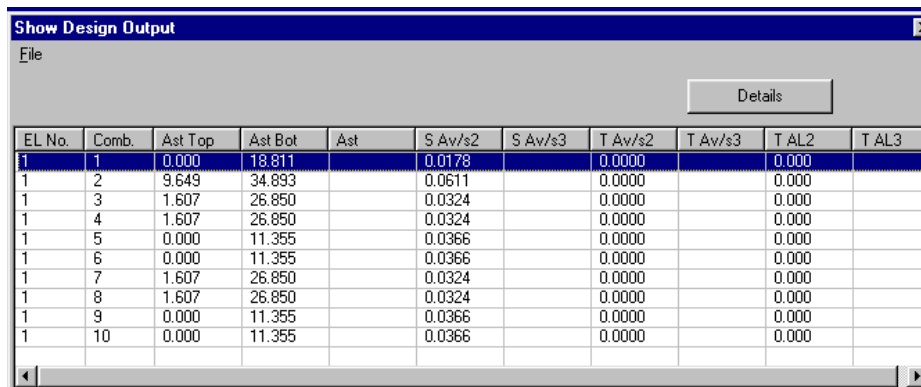

The dialog box titled "Show Design Output" displays a table of design results. A "Details" button is located in the top right corner.

EL No.	Comb.	Ast Top	Ast Bot	Ast	S Av/s2	S Av/s3	T Av/s2	T Av/s3	T AL2	T AL3
1	1	0.000	18.811		0.0178		0.0000		0.000	
1	2	9.649	34.893		0.0611		0.0000		0.000	
1	3	1.607	26.850		0.0324		0.0000		0.000	
1	4	1.607	26.850		0.0324		0.0000		0.000	
1	5	0.000	11.355		0.0366		0.0000		0.000	
1	6	0.000	11.355		0.0366		0.0000		0.000	
1	7	1.607	26.850		0.0324		0.0000		0.000	
1	8	1.607	26.850		0.0324		0.0000		0.000	
1	9	0.000	11.355		0.0366		0.0000		0.000	
1	10	0.000	11.355		0.0366		0.0000		0.000	

Figure 3.38 Show Design Output dialg for output results of load combinations

The details for each load combination is displayed by clicking on the command button Details in the Show Beam Section design dialog as shown in Figure 3.39 (**form name: Details, file: DesignDetails**).

The command button Footing Design runs a subroutine for footing design, then the design results are displayed in the Show Footing Design dialog as shown in Figure 3.40 (**form name: Details, file: DesignDetails**).

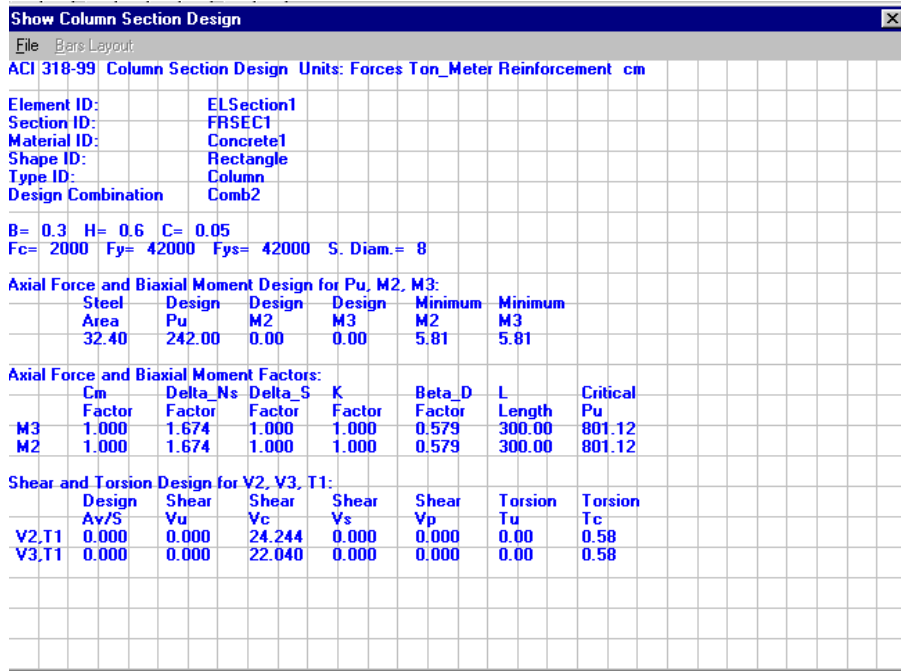

Figure 3.39 Show Column Section Design dialog

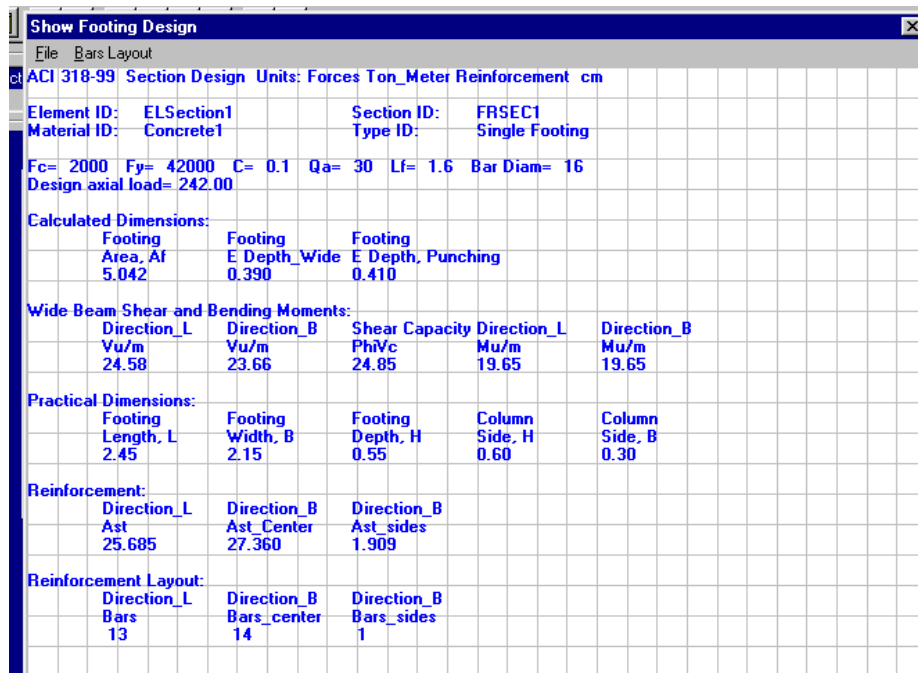

Figure 3.40 Show Footing Design dialog

The footing reinforcement details are displayed by clicking on the menu Bars Layout. Figure 3.41 shows the Show Bars Layout dialog (**form name: BarsLayout, file: BarsLayout**). The bars diameters can be modified by displaying the Change Bar Diameters dialog as shown in Figure 3.42 (**form name: ChangeBarDiameter, file: ChangeBarDiameter**).

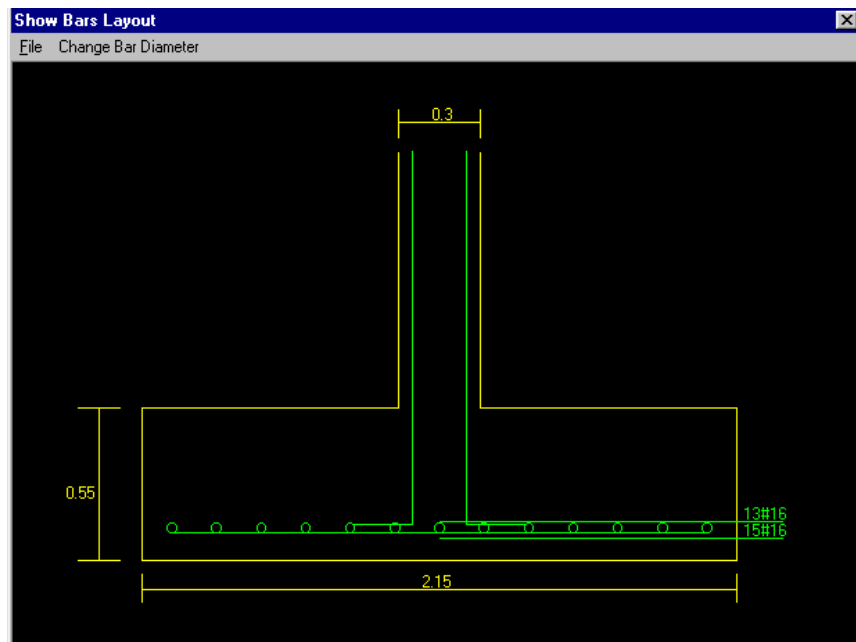

Figure 3.41 Show Bars Layout dialog/ Footing

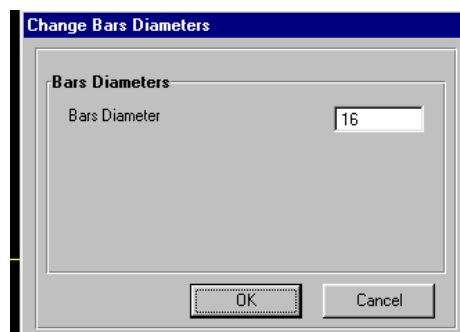

Figure 3.42 Change Bars Diameters dialog/ Footing

The Footing Design command button runs a subroutine for footing design. The flowchart of this subroutine is shown in Figure 3.43.

The variables in this flowchart are defined as follows:

Element_Footing_Load(SL1)= the ultimate load on the footing for design

FootingID1(SL1)= identifier for the footing load if it is tension or not. 1: footing load is tension, 0: footing load is compression

FootingVuL(SL1)= shear force at distance d from face of column in direction L

FootingPhiVc(SL1)= concrete shear capacity of footing section

FootingEDepth(SL1)= footing effective depth

FootingMuL(SL1)= bending moment at face of column in direction L

FotTmin= minimum footing thickness

FootingMuB(SL1)= bending moment at face of column in direction B

Df_Punching= footing effective depth due to punching

FootingAstB(SL1)= design area of steel in footing section in direction B

FootingLength(SL1)= design footing length

FootingWidth(SL1)= design footing width

FootingHeight(SL1)= design footing thickness

FootingEdepthWide(SL1)= footing effective depth due to wide beam shear

FootingEdepthPunching(SL1)= footing effective depth due to punching

AstShort= area of steel in direction B

Beta= ratio of footing length, L to footing width, B

FootingVuB(SL1)= shear force at face of column in direction B

FootingAstBC(SL1)= area of steel in short direction at center

FootingAstBS(SL1)= area of steel in short direction outside the center

FootingBarsL(SL1)= number of bars in direction L

FootingBarsBC(SL1)= number of bars in short direction, B at the center

FootingBarsBS(SL1)= number of bars in short direction, B outside the center

FootingsB(SL1)= total number of bars in direction B

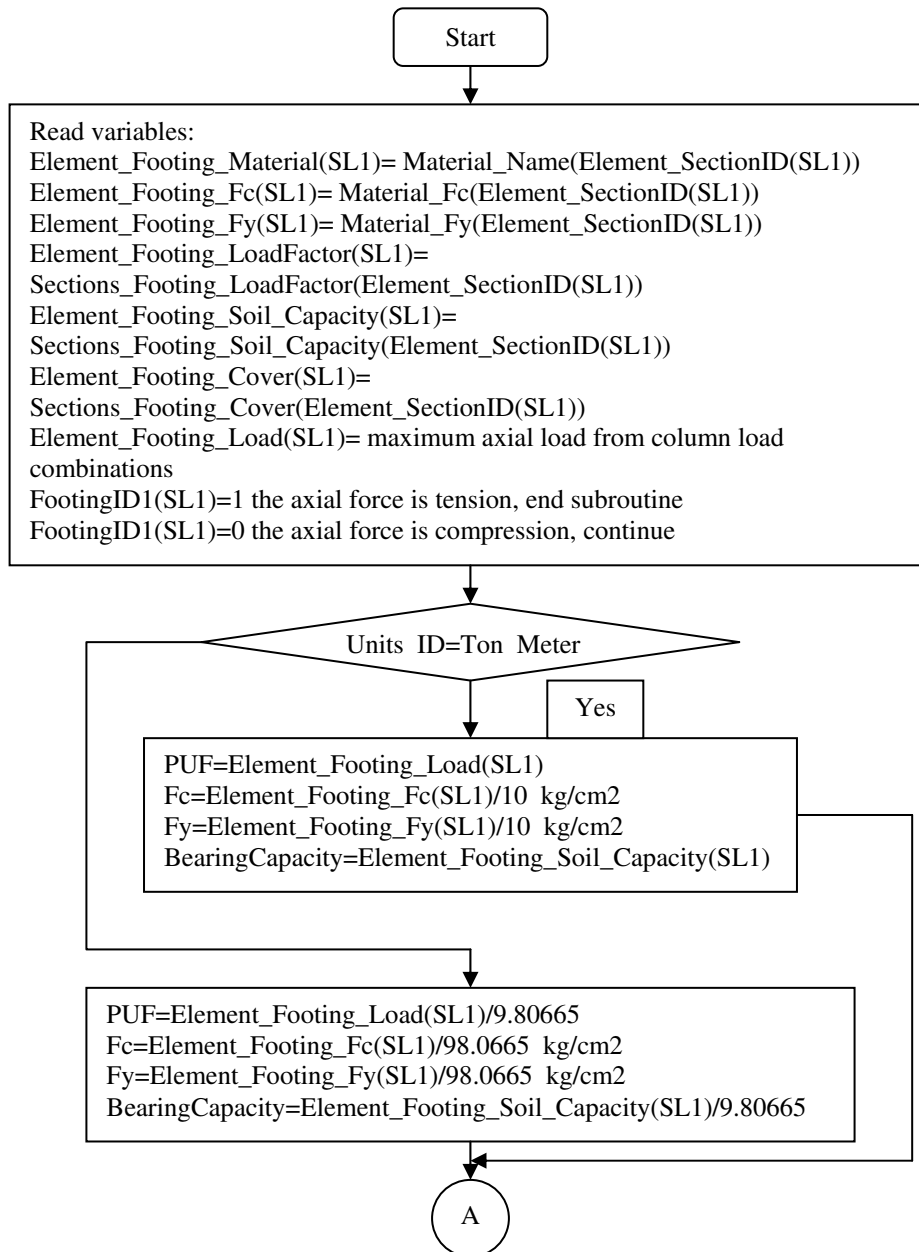
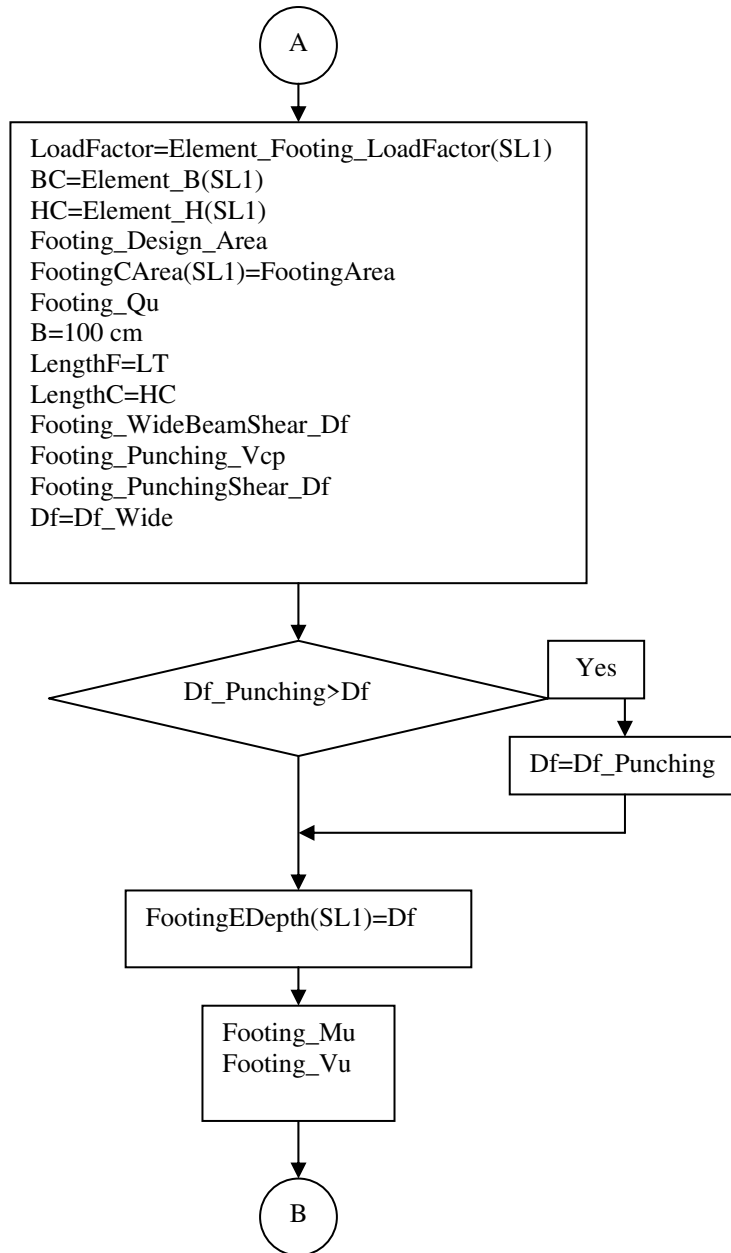

Figure 3.43 Flowchart for footing design

**Figure 3.43** continued

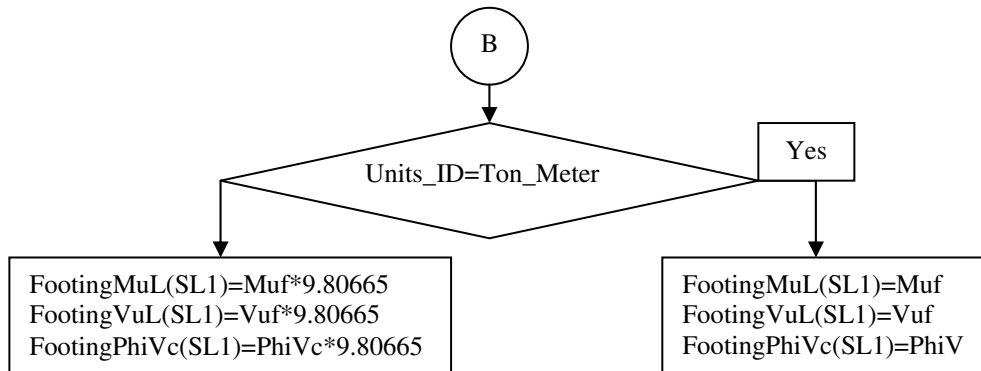

Figure 3.43 continued

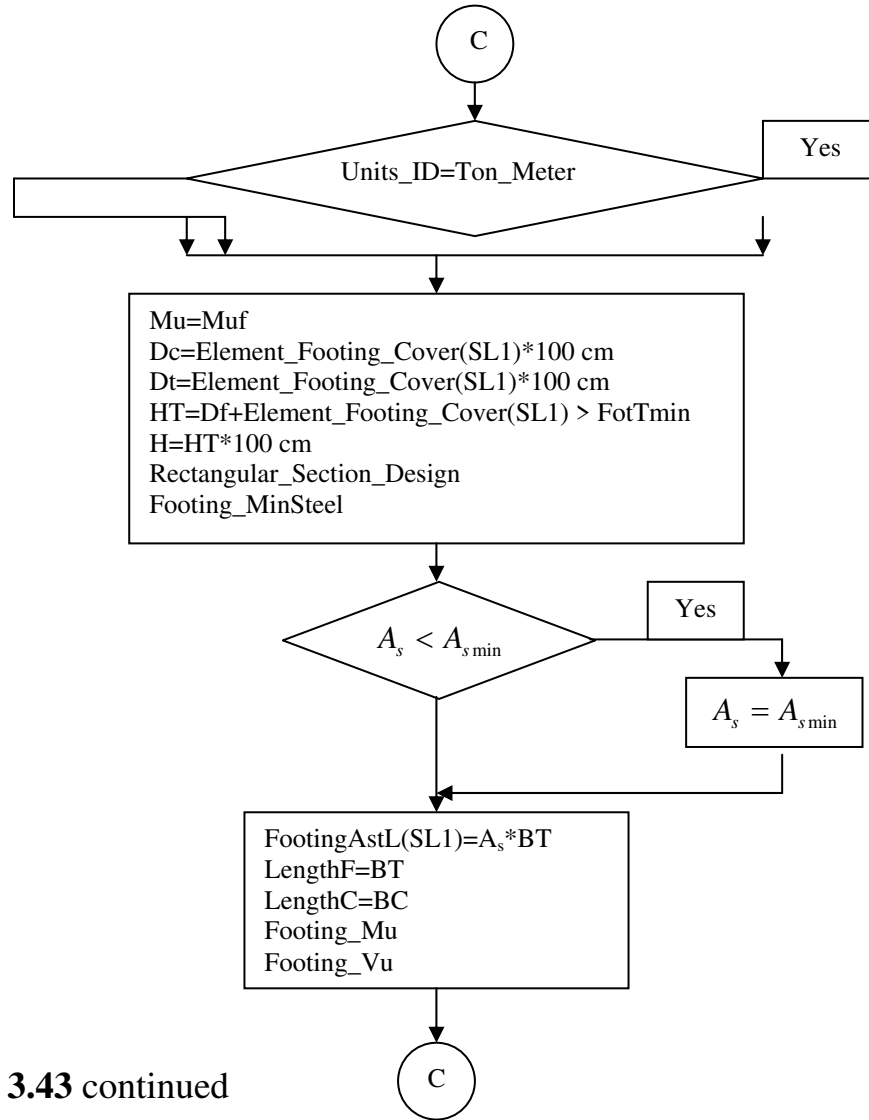
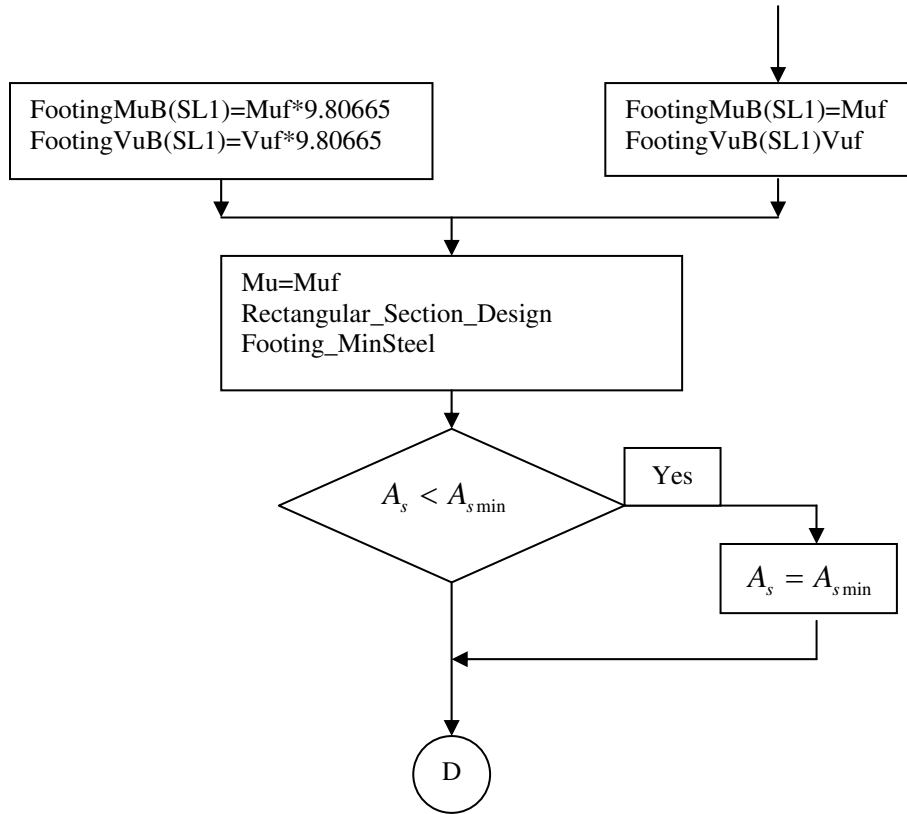
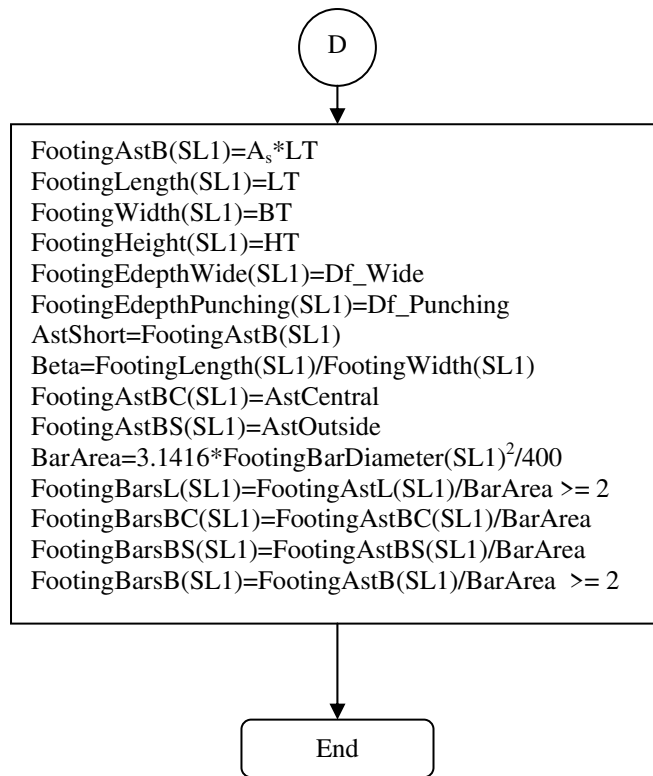

Figure 3.43 continued



**Figure 3.43** continued

3.11 The Display Menu:

This menu is used to display input data.

3.11.1 The Show Sections Submenu:

This submenu display the Show Design Sections or Show Analysis Sections dialog as shown in Figure 3.44 (**form name: ShowDesignSections, file: ShowSections**).

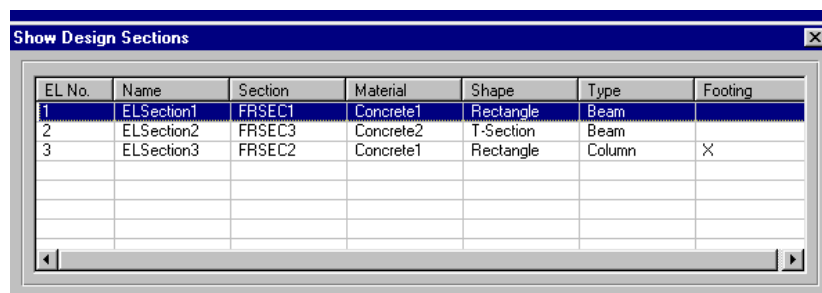

EL No.	Name	Section	Material	Shape	Type	Footing
1	ELSection1	FRSEC1	Concrete1	Rectangle	Beam	
2	ELSection2	FRSEC3	Concrete2	T-Section	Beam	
3	ELSection3	FRSEC2	Concrete1	Rectangle	Column	X

Figure 3.44 Show Design Sections dialog

3.11.2 The Show Input Section Forces Submenu:

This submenu is used to display the design forces in the Show Design Forces dialog as shown in Figure 3.45 (**form name: ShowDesignForces, file: ShowForces**).

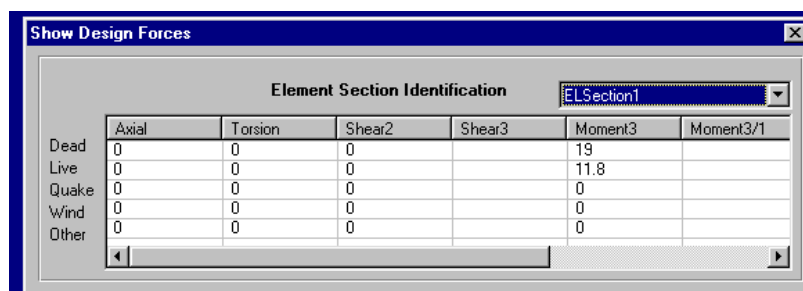

Element Section Identification		ELSection1					
	Axial	Torsion	Shear2	Shear3	Moment3	Moment3/1	
Dead	0	0	0		19		
Live	0	0	0		11.8		
Quake	0	0	0		0		
Wind	0	0	0		0		
Other	0	0	0		0		

Figure 3.45 Show Design Forces dialog

3.11.3 The Show Input Sections Reinforcement Submenu

This submenu is used to display the reinforcement data of elements for analysis as shown in Figure 3.46 (**form name: ShowAnReinforcement, file: ShowAnRei.frm**).

Beam										Column			
E.No	T.Bars	T.Di...	B.Bars	B.Di...	M.B...	M.Di...	T.Ar...	B.Ar...	M.Ar...	Bars...	Bars...	B.Di...	B.Ar...
1	3	16	6	16	0	0							

Figure 3.46 Show reinforcement dialog

Figure 3.47 shows the section shear reinforcement (**form name: ShowShearReinforcement, file: ShowShear.frm**) and Figure 3.48 shows the Show Footing Dimensions and Reinforcement dialog (**form name: ShowFootingData, file: Check.frm**).

Identification	
Element Section ID	1
Name	ELSection1
Reinforcement	
No. of Bars	1
Bar Diameter(mm)	8
Bars Spacing	20
Av/S	

Figure 3.47 Show Section Shear Reinforcement dialog

Show Footing Dimensions and Reinforcement

Identification
 Element Section ID: 1 Name: ELSection1

Dimensions
 BT: 2 HT: 2 Depth: 0.5

Reinforcement
 Reinforcement along HT :
 Bars: 10 Diam. (mm): 16 Area (cm2):
 Reinforcement along B :
 Bars: 10 Diam. (mm): 16 Area (cm2):

Figure 3.48 Show Footing Dimensions and Reinforcement dialog

3.12 The Options Menu:

This menu is used to display analysis and design options.

3.12.1 The Preferences Submenu:

This submenu displays the Preferences dialog as shown in Figure 3.49 (form name: Preferences, file: Preferences).

Preferences

Concrete Design Code: ACI 318-99

Strength Reduction Factors
 Bending/Tension: 0.9 Shear: 0.85
 Compression: 0.7 Torsion: 0.85

Column
 Minimum Steel Ratio: 0.01
 Maximum Steel Ratio: 0.08
 Reduction Factor for Minimum Eccentricity: 0.8

Footing
 Minimum Footing Thickness: 0.3

OK Cancel

Figure 3.49 Preferences dialog

The variables that are read from this dialog are defined as follows:

PhiMoment = the strength reduction factor for bending moment. The default value is 0.9

PhiTension = the strength reduction factor for pure tension. The default value is 0.9

PhiCompression = the strength reduction factor for compression of rectangular column section. The default value is 0.7

PhiShear = the strength reduction factor for shear. The default value is 0.85

PhiTorsion = the strength reduction factor for torsion. The default value is 0.85

ColRmin = minimum steel ratio in column section. The default value is 0.01

ColRmax = maximum steel ratio in column section. The default value is 0.08

ColReduction = strength reduction factor for column minimum eccentricity. The default value is 0.8

FotTmin = minimum depth of footing

3.13 The Help Menu:

The program is supported by Arabic and English help files. The help subject can be displayed by pressing the F1 key. A sample is shown in Figure 3.50.

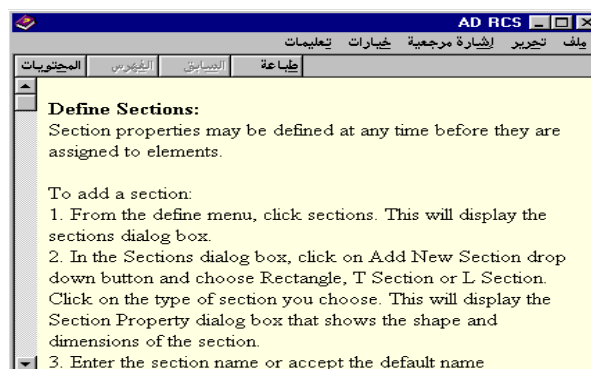

Figure 3.50a A sample of English help

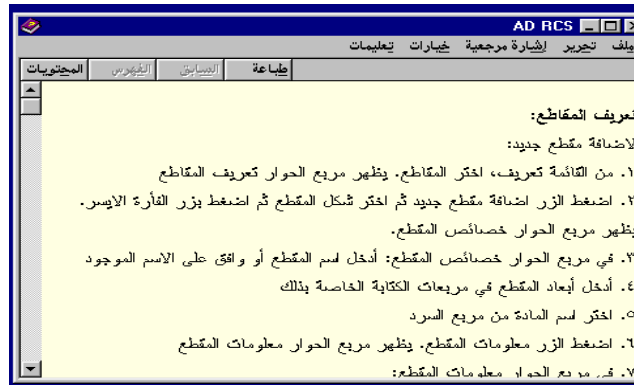

Figure 3.50b A sample of Arabic help

Chapter Two

Theory of Analysis and Design of Reinforced Concrete Sections

2.1 Introduction

This chapter will illustrate the theoretical basic principles for analysis and design of reinforced concrete sections according to ACI318-99. Also, these theoretical steps will be illustrated in flowcharts that will be transformed to subroutines in the program source code.

2.2 Analysis and Design of Reinforced Concrete Sections for Flexure:

In this section, the principles of analysis and design of reinforced concrete sections using the ultimate strength method will be shown. In analysis, the beam section dimensions, material properties and reinforcement are given and the moment capacity will be calculated. The section dimensions are the section width b and the section height h . The material properties are the concrete cylinder compressive strength at 28 days f_c' , the steel yield strength f_y and the shear steel yield strength f_{ys} . The reinforcement quantities are the area of tension steel A_s and the area of compression steel A_s' . In design, the trial beam section dimensions, material properties and bending moments are given and the required reinforcement will be calculated.

Sections 2.2.1 and 2.2.2 will cover the analysis of rectangular reinforced concrete sections for singly and doubly reinforcement respectively. Section 2.2.3 will cover the design principles of rectangular beam. Section 2.2.4 will cover the analysis of T and L beam sections. Section 2.2.5 will cover the design of flanged beam section.

2.2.1 Analysis of Singly Reinforced Rectangular Beam Section for Flexure:

A singly reinforced section is a section that has tension steel only (it has no compression steel) as shown in Figure 2.1. The depth of the compression block, a is given by:

$$a = \frac{A_s f_y}{0.85 f_c' b} \quad (2.1)$$

The design moment of the beam section, M_d will be given by:

$$M_d = \phi 0.85 f_c' b a \left(d - \frac{a}{2} \right) \quad (2.2)$$

where

Φ = strength reduction factor for flexure which equals to 0.9

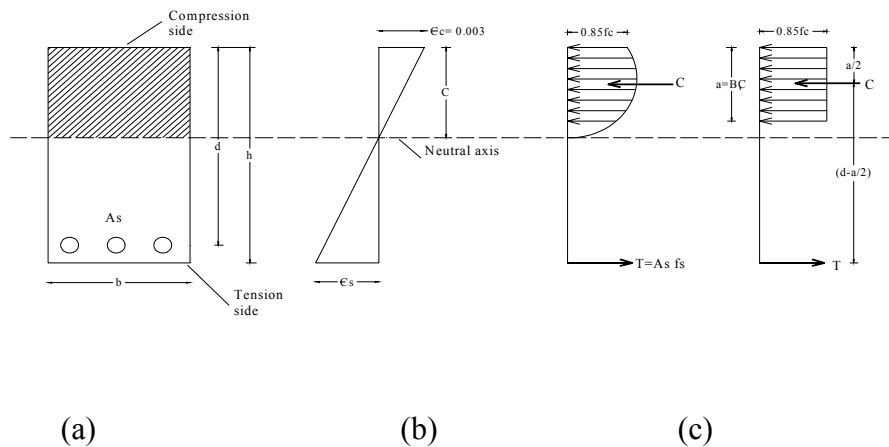

Figure 2.1 Stress and strain distribution across beam section: (a) beam cross-section; (b) strains; (c) actual stress block; (d) assumed equivalent stress block

The steel ratio, ρ is given by:

$$\rho = \frac{A_s}{bd} \quad (2.3)$$

This steel ratio should be larger than a minimum value specified by the code. The code states the minimum area of steel as (b is the width of the web of the section):

$$A_{s\min} \geq \frac{0.8\sqrt{f_c'}}{f_y} bd \geq \frac{14}{f_y} bd \quad (2.4)$$

Also, the tension steel ratio should be less than a maximum value:

$$\rho \leq 0.75\rho_b \quad (2.5)$$

Where ρ_b is the steel ratio at the balanced condition. The balanced condition in a beam section in flexure is achieved when the steel starts yielding at the same time when the concrete just reaches its ultimate strain capacity and commences to crush. ρ_b is given by:

$$\rho_b = \beta_1 \frac{0.85f_c'}{f_y} \frac{6120}{6120 + f_y} \quad (2.6)$$

Where β_1 is a factor depends on the concrete compressive strength that is given by:

$$\beta_1 = 0.65 \quad \text{for } f_c' \geq 560\text{kg/cm}^2 \quad (2.7a)$$

$$\beta_1 = 0.85 - 0.05\left(\frac{f_c' - 280}{70}\right) \quad \text{for } 560\text{kg/cm}^2 > f_c' > 280\text{kg/cm}^2 \quad (2.7b)$$

$$\beta_1 \geq 0.65 \quad \text{for } f_c' \geq 560\text{kg/cm}^2 \quad (2.7c)$$

The previous equations for calculating the minimum steel ratio, β_1 and the maximum steel ratio are shown in the flowcharts in Figures 2.2, 2.3 and 2.4

respectively. These flowcharts are transformed to the subroutines Rho_Min, Beta_1 and RhoMax_Rectangle.

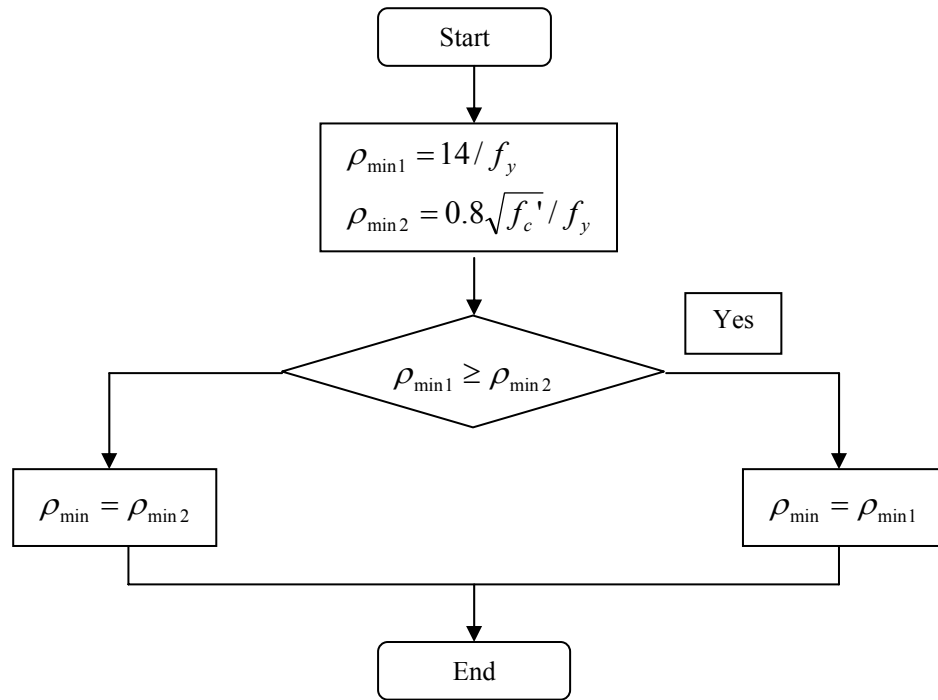
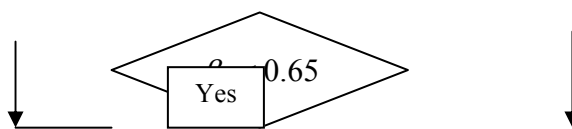

Figure 2.2 Flowchart to calculate ρ_{\min} , subroutine Rho_Min



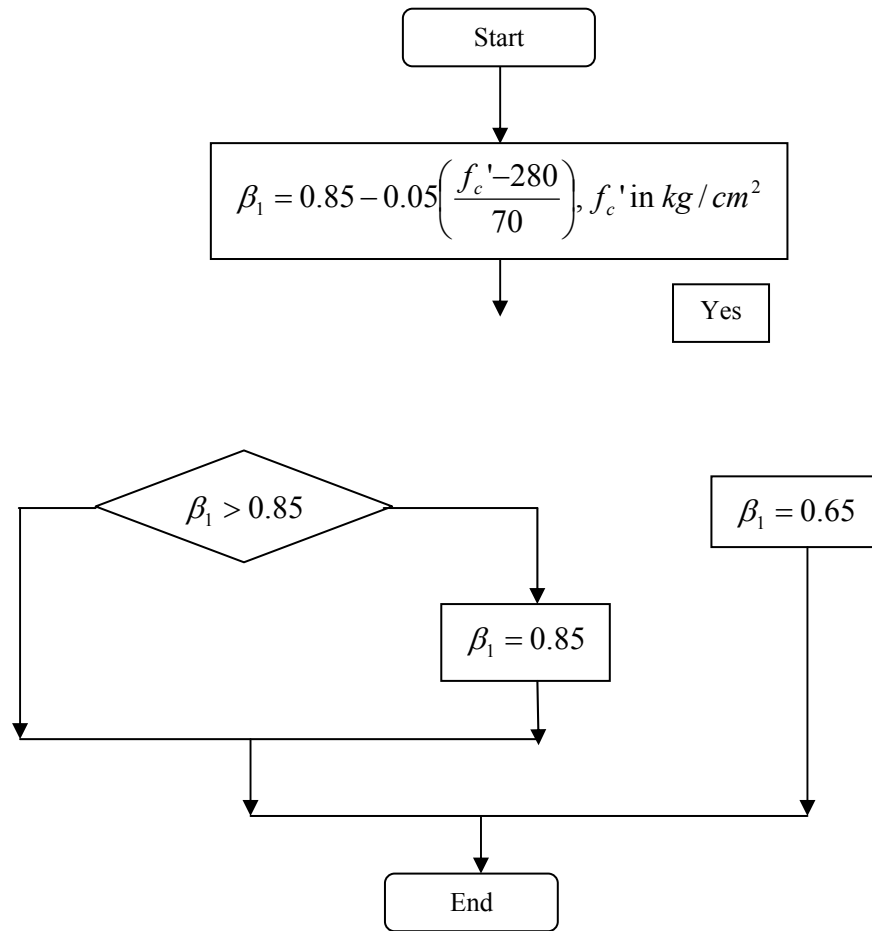

Figure 2.3 Flowchart to find the value of β_1 , subroutine Beta_1

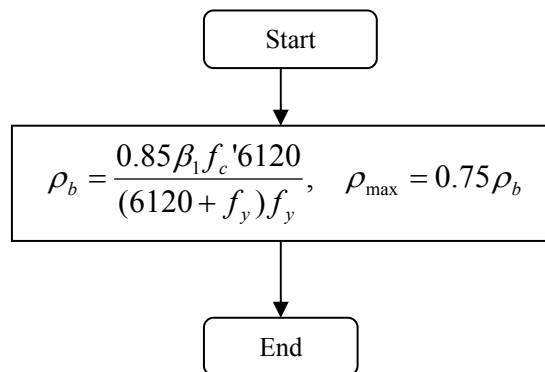

Figure 2.4 Flowchart to calculate ρ_{\max} , subroutine RhoMax_Rectangle

2.2.2 Analysis of Doubly Reinforced Rectangular Beam Section for Flexure:

Doubly reinforced concrete sections contain reinforcement both at tension and at compression faces or at top and bottom of section as shown in Figure 2.5. Compression steel becomes necessary when the dimensions of the section are restricted due to architectural limitations.

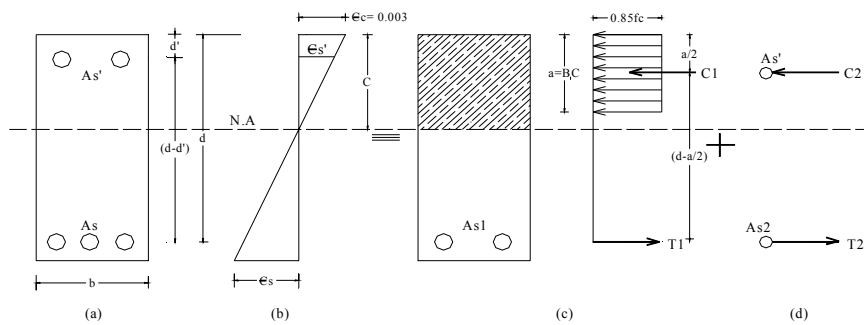

Figure 2.5 Doubly reinforced beam section: (a) cross-section; (b) strains; (c) part 1, singly reinforced part; (d) part 2, contribution of compression steel

In analysis and design of beam sections with compression and tension reinforcement, the analysis is so divided into two parts: (1) the singly reinforced part involving the equivalent rectangular block as discussed before with the area of tension reinforcement being ($A_{s1} = A_s - A_s'$); and (2) the two areas of equivalent steel $A_{s2} = A_s'$ at both the tension and compression sides to form a couple. The bending moment, M_d that is formed from the two parts is given by:

$$M_d = M_{d1} + M_{d2} = \phi \left\{ (A_s f_y - A_s' f_s) \left(d - \frac{a}{2} \right) + A_s' f_s (d - d') \right\} \quad (2.8)$$

Where a is given by:

$$a = \frac{(A_s f_y - A_s' f_s)}{0.85 f_c' b} \quad (2.9)$$

Where f_s is the stress in the compression steel that is given by:

$$f_s = 6120 \left[1 - \frac{0.85 \beta_1 f_c' d'}{(\rho - \rho') d f_y} \right] \leq f_y \quad (2.10)$$

Where ρ' is the ratio of the compression steel. It is always necessary to verify that the strains across the depth of the section follow the linear distribution shown in Figure 2.5. In other words, a check is necessary to ensure that strains are compatible across the depth at the strength design levels. Such verification is called a strain-compatibility check. The compression steel yield if:

$$\rho - \rho' \geq \frac{0.85 \beta_1 f_c' d'}{f_y d} \frac{6120}{6120 - f_y} \quad (2.11)$$

The tension steel ratio, ρ should be less than the maximum that is:

$$\rho \leq 0.75 \rho_b + \rho' f_s / f_y \quad (2.12)$$

The previous procedure and equations are shown in the flowchart in Figure 2.6 that illustrates a complete procedure for analysis of beam section. This flowchart is transformed to the subroutine `Rectangular_Beam_Analysis`.

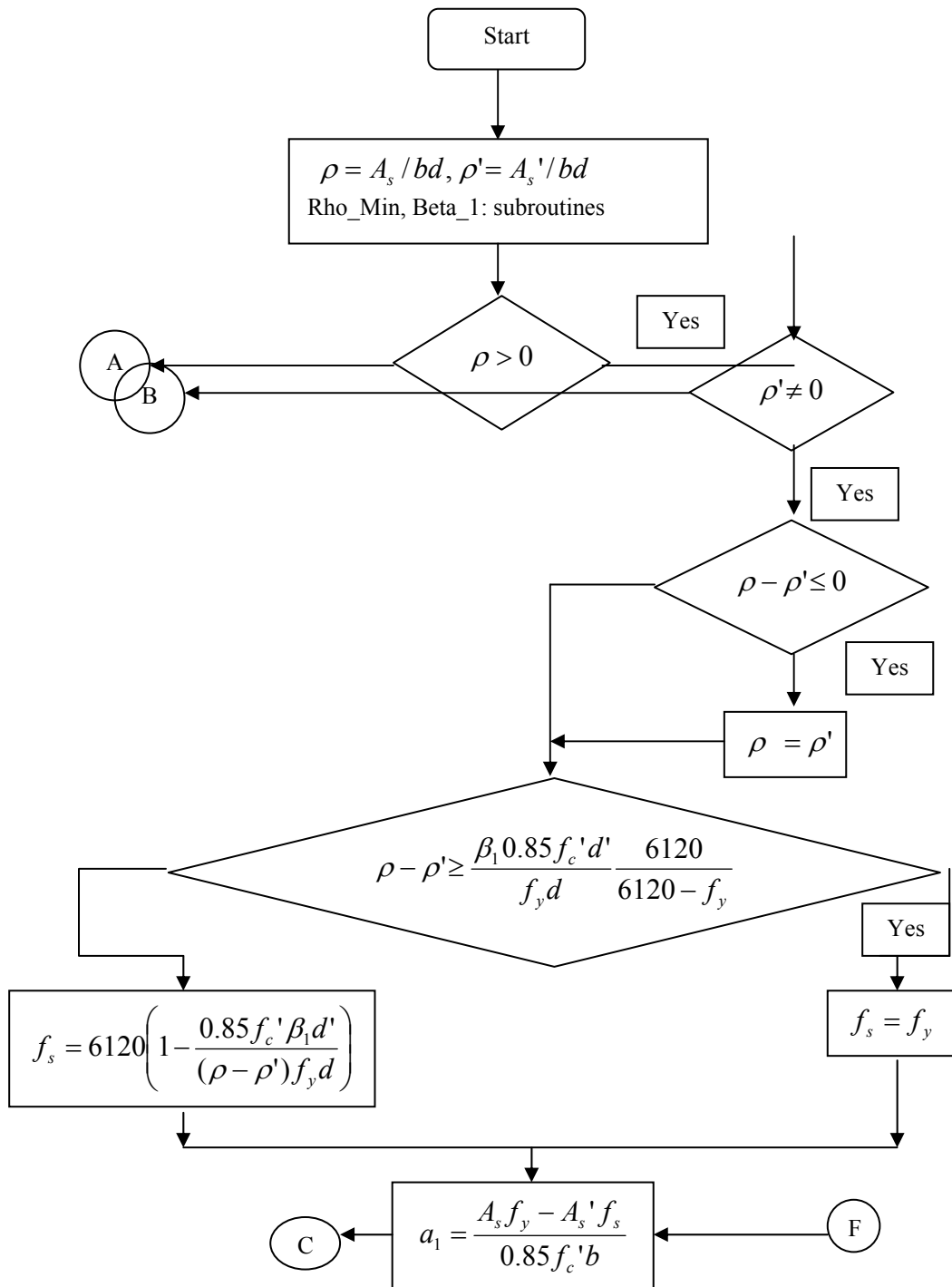

Figure 2.6 Flowchart for analysis of rectangular beam section for flexure, subroutine Rectangular_Beam_Analysis

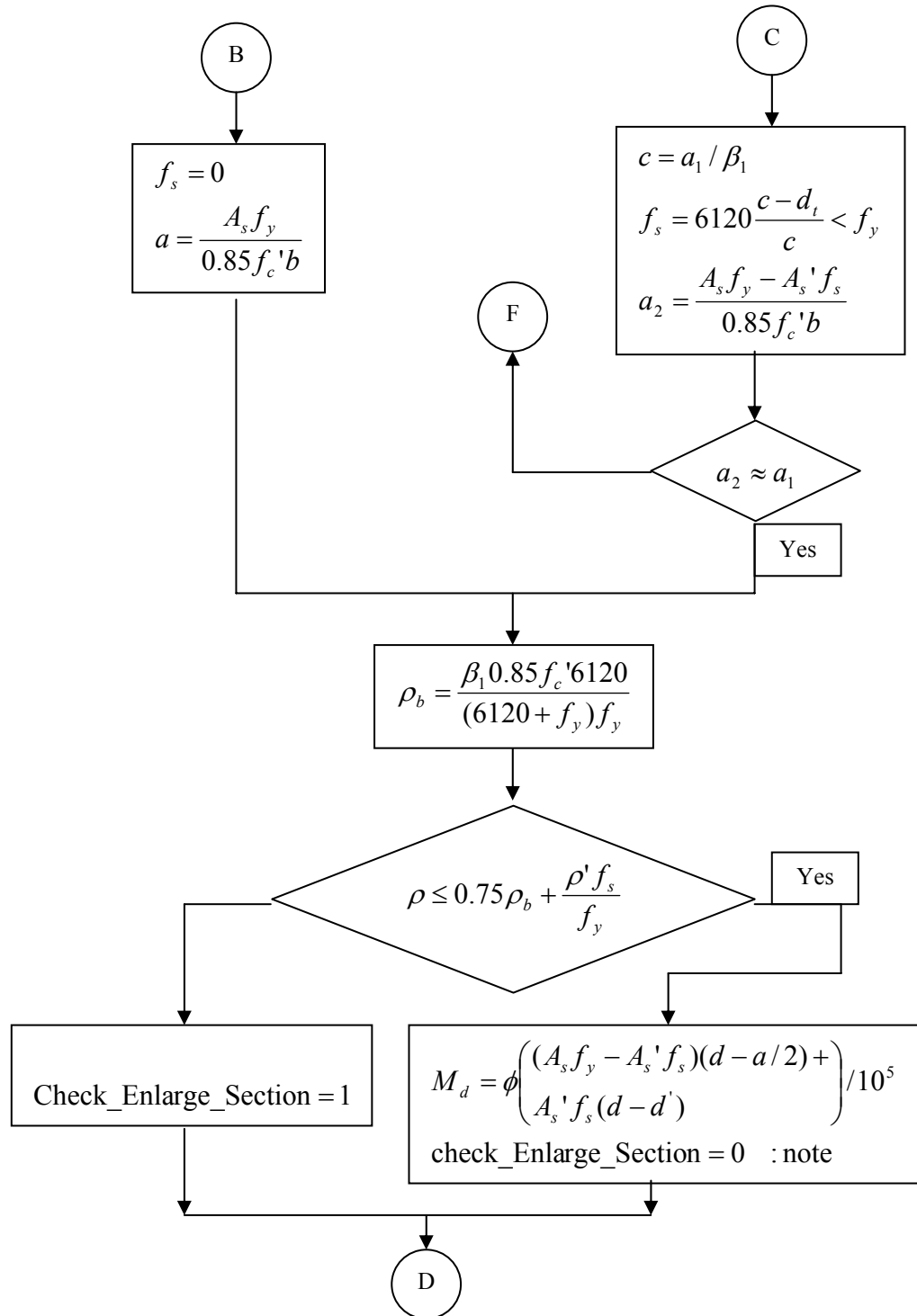

Figure 2.6 continued

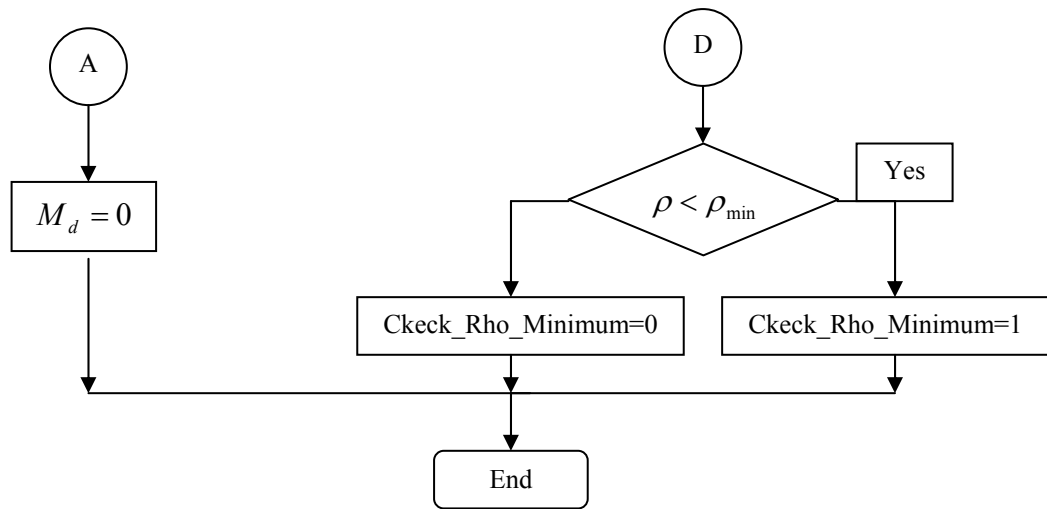

Figure 2.6 continued

2.2.3 Design of Rectangular Beam Section for Flexure:

In designing for a factored negative or positive bending moment, M_u (i.e. designing top or bottom steel) the depth of the compression block is given by a in cm where,

$$a = d - \sqrt{d^2 - \frac{2 \times 10^5 M_u}{0.85 f_c' \phi}} \quad (2.13)$$

where M_u is in ton-meter, d and b in cm and f_c' in kg/cm^2 . The maximum allowed depth of the compression block is given by

$$a_{\max} = 0.75 \beta_1 c_b \quad (2.14)$$

The procedure for calculating β_1 was mentioned before. The depth to neutral axis c_b at the balanced condition is given by

$$c_b = \frac{6120}{6120 + f_y} d \quad (2.15)$$

If $a \leq a_{\max}$, the area of tensile steel reinforcement A_s in cm^2 is given by

$$A_s = \frac{M_u}{\phi f_y \left(d - \frac{a}{2}\right)} \quad (2.16)$$

This steel is to be placed at the bottom if M_u is positive, or at the top if M_u is negative.

If $a > a_{\max}$, compression reinforcement is required and is calculated as follows:

1. The compressive force developed in concrete alone is given by

$$C_c = 0.85 f_c' b a_{\max} \quad (2.17)$$

and the moment resisted by concrete compression and tensile steel is

$$M_{uc} = C_c \left(d - \frac{a_{\max}}{2} \right) \phi \quad (2.18)$$

2. The moment resisted by compression steel and tensile steel is

$$M_{us} = M_u - M_{uc} \quad (2.19)$$

3. The required compression steel is given by

$$A_s' = \frac{M_{us}}{f_s(d-d')\phi} \quad (2.20)$$

where

$$f_s = 6120 \left(\frac{c-d'}{c} \right) \quad (2.21)$$

4. The required tensile steel for balancing the compression in concrete

$$A_{s1} = \frac{M_{uc}}{f_y \left(d - \frac{a_{\max}}{2} \right)} \quad (2.22)$$

is

The tensile steel for balancing the compression in steel is given by

$$A_{s2} = \frac{M_{us}}{f_y(d-d')\phi} \quad (2.23)$$

5. The total tensile reinforcement, $A_s = A_{s1} + A_{s2}$, and the total compression reinforcement is A_s' . A_s is to be placed at bottom and A_s' is to be placed at top if M_u is positive, and vice versa if M_u is negative.

The provided tensile steel should be larger than the minimum given in Eq. 2.4 or 4/3 the calculated tensile steel area.

The above steps are summarized in the flowcharts in Figures 2.7, 2.8, 2.9 and 2.10. These flowcharts are transformed to subroutines

Compression_Block_Depth, Rectangular_Beam_Design, Steel_Area and Rectangular_Section_Design respectively.

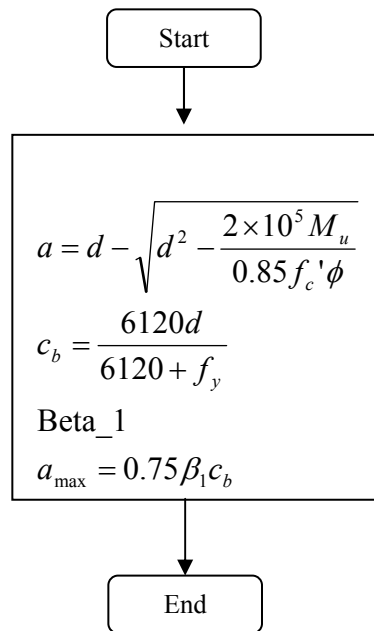

Figure 2.7 Flowchart to calculate a and a_{\max} , subroutine Compression_Block_Depth

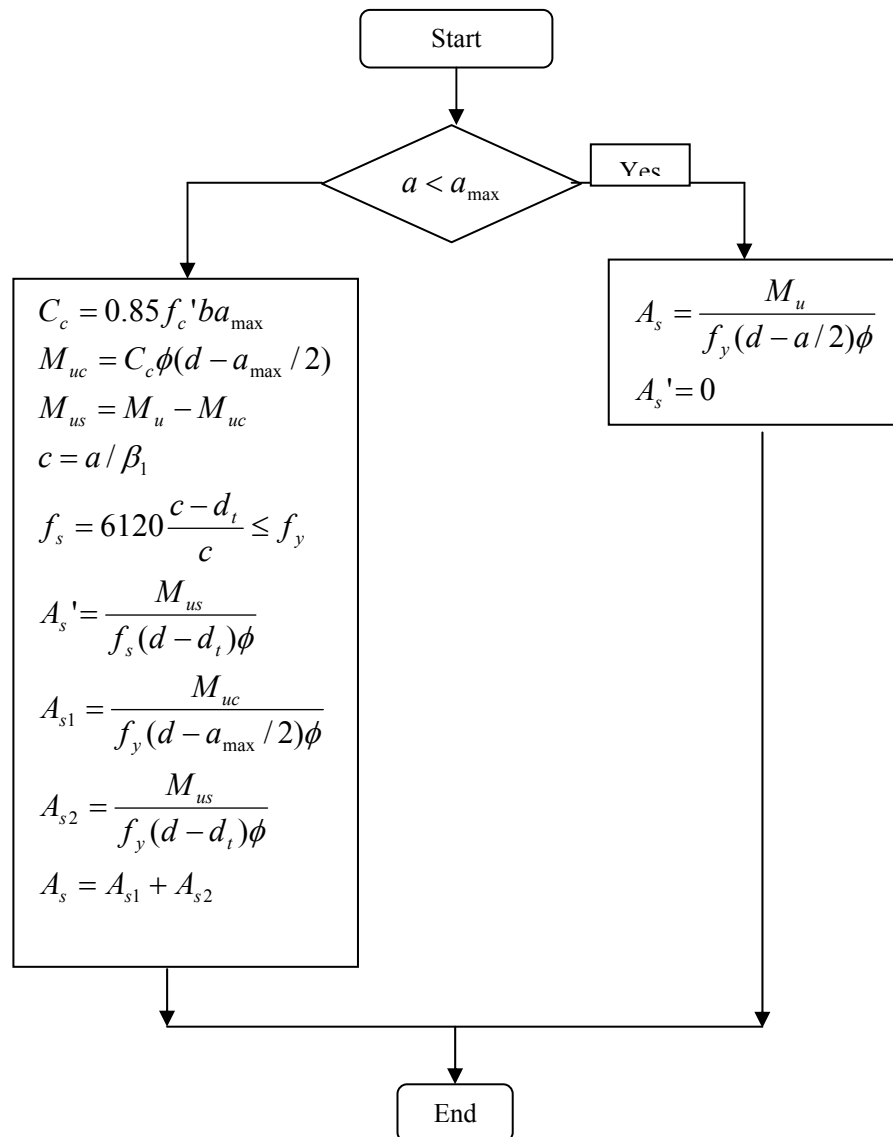

Figure 2.8 Flowchart to calculate A_s in rectangular section, subroutine Rectangular_Beam_Design

Start

Yes

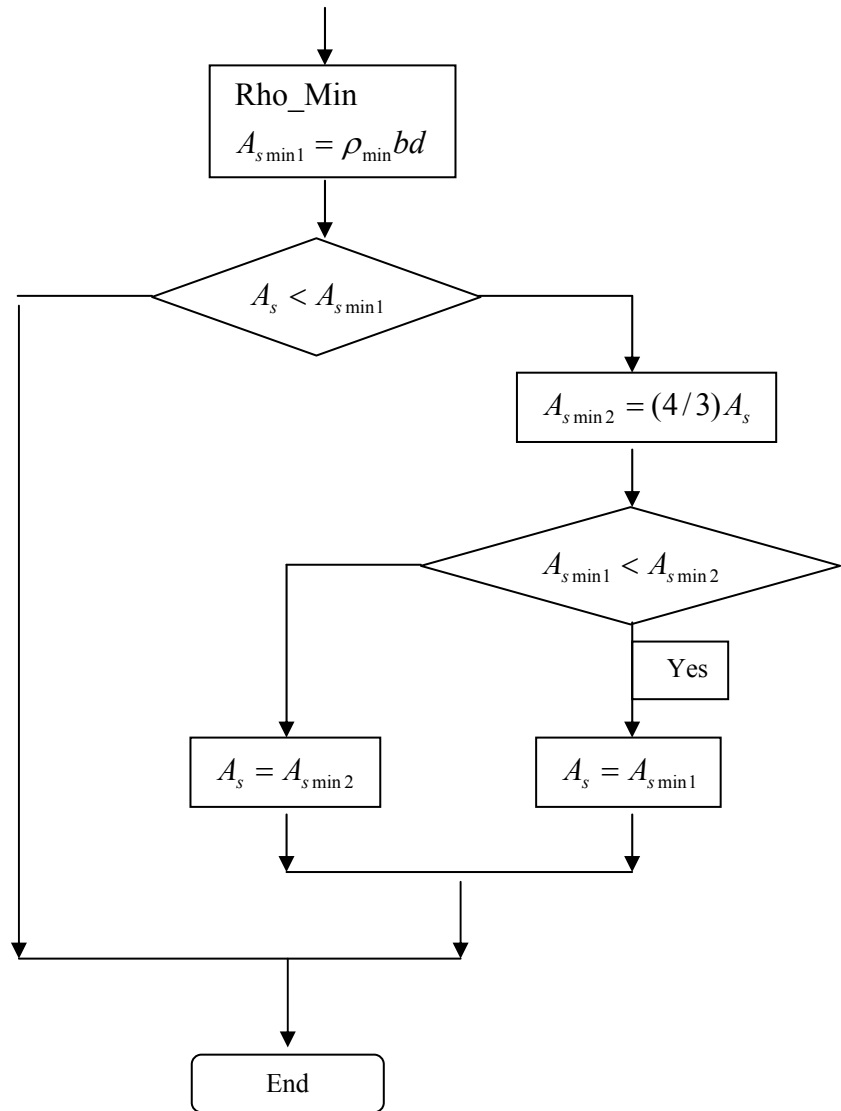

Figure 2.9 Flowchart to set final value of A_s , subroutine Steel_Area

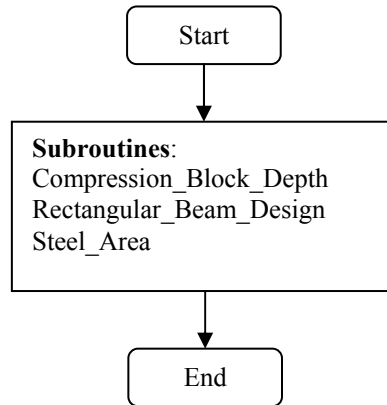

Figure 2.10 Flowchart to design rectangular section for bending, subroutine Rectangular_Section_Design

2.2.4 Analysis of T and L Beam Sections for Flexure:

The basic principles used for analysis and design of rectangular beams are also valid for the flanged beams. The major difference between the rectangular and the flanged sections is in the calculation of the compressive force C_c . Depending on the depth of the neutral axis, C , the following cases can be identified:

Case 1: depth of neutral axis, C is less than flanged thickness h_f (Figure 2.11):

This case can be treated similarly to the standard rectangular section provided that the depth a of the equivalent rectangular block is less than the flange thickness. The flange width b_f of the compression side should be used as the beam width in the analysis. Equations 2.1 and 2.2 are applied.

Case 2: Depth of neutral axis is larger than flange thickness h_f (Figure 2.12):

In this case if the depth of the equivalent rectangular stress block, a is larger than the flange thickness, thus the section is considered as a flanged section. This section could be treated in the same manner as for a doubly reinforced rectangular section. The contribution of the flange overhang compressive force is considered analogous to the contribution of imaginary compression reinforcement, this compressive force, C' is equal to the average concrete strength f_c' multiplied by the cross-sectional area of the flange overhangs. Thus C' is given by:

$$C' = 0.85f_c'(b_f - b)h_f \quad (2.24)$$

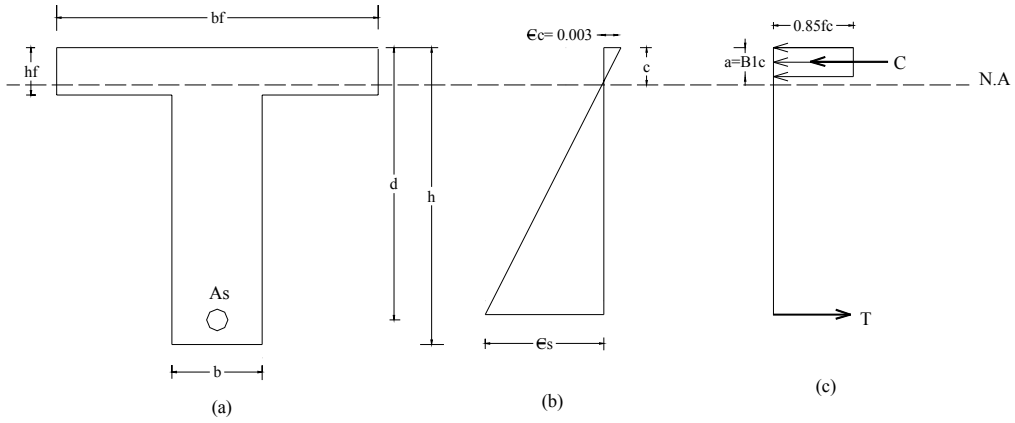

Figure 2.11 T-beam section with neutral axis within the flange ($a < h_f$): (a) cross section; (b) strains; (c) stresses

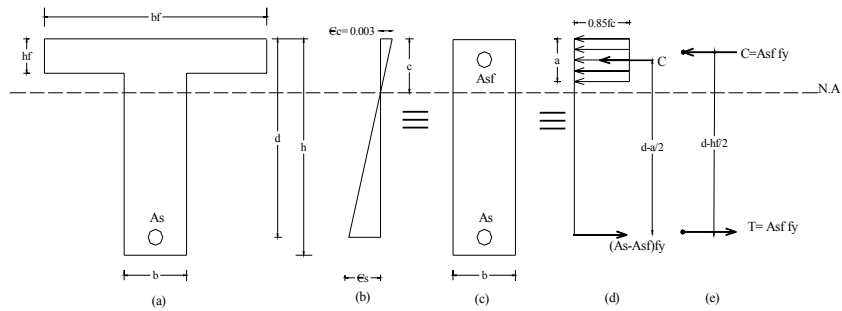

Figure 2.12 Stress and strain in flanged section: (a) cross-section; (b) strains; (c) transformed section; (d) part 1 forces; (e) part 2 forces

For a beam section to be considered as a real T-beam, the tension force $A_s f_y$ generated by the steel should be greater than the compression force capacity of the total flange area $0.85 f_c' b h_f$. Hence

$$a = \frac{A_s f_y}{0.85 f_c' b_f} > h_f \quad (2.25)$$

The percentage for the balanced condition in a T-beam section can be written as

$$\rho_b = \frac{b}{b_f} (\bar{\rho}_b + \rho_f) \quad (2.26)$$

where

$$\bar{\rho}_b = \frac{0.85 \beta_1 f_c'}{f_y} \frac{6120}{6120 + f_y} \quad (2.27)$$

The reinforcement ratio for tension steel area necessary to develop the compressive strength of the overhanging flanges, ρ_f is given by:

$$\rho_f = \frac{0.85 f_c' (b_f - b) h_f}{f_y b d} \quad (2.28)$$

To satisfy the requirement of minimum reinforcement, for positive moment, the web reinforcement should not have steel less than given in Equation 2.4.

As in the case of analysis and design of doubly reinforced sections, the reinforcement at tension side is considered to be composed of two areas:

$$M_d = \phi \left[(A_s - A_{sf}) f_y \left(d - \frac{a}{2} \right) + A_{sf} f_y \left(d - \frac{h_f}{2} \right) \right] \quad (2.29)$$

A_{s1} to balance the rectangular block compressive force on area ba , and A_{s2} to balance the imaginary steel area A_{sf} . Consequently, the total design moment strength for parts 1 and 2 of the solution is

If having compression steel in the flange, modifications should be made as follows:

- The stress in compression steel will be found using the same procedure used for analysis of doubly reinforced rectangular section
- The depth of the compression block in concrete, a will be given by:

$$a = \frac{A_s f_y - A_s' f_s}{0.85 f_c' b_f} \quad (2.30)$$

- If a is less than flange thickness h_f , the section should be analyzed as doubly reinforced rectangular section with width of b_f .
- If a is larger than h_f , a will be given by

$$a = \frac{(A_s - A_{sf}) f_y - A_s' f_s}{0.85 f_c' b} \quad (2.31)$$

In this case the design bending M_d will be calculated as

$$M_n = M_{n1} + M_{n2} + M_{n3} \quad (2.32a)$$

$$M_{n1} = [(A_s - A_{sf}) f_y - A_s' f_s] \left(d - \frac{a}{2} \right) \quad (2.32b)$$

$$M_{n2} = A_{sf} f_y \left(d - \frac{h_f}{2} \right) \quad (2.32c)$$

where

M_{n1} = is the nominal moment developed by the tension steel balancing the concrete compressive strength in the web

M_{n2} = is the nominal moment developed by the force in tension steel and the force capacity of the overhangs

M_{n3} = is the nominal moment developed by the forces in the tension and the compression steel as a couple force multiplied by the arm $d-d'$.

The design moment, M_d equals the nominal moment M_n multiplied by the strength reduction factor for flexure $\Phi = 0.9$.

Figure 2.13 illustrates flowchart shows the procedure followed in analysis of flanged beam section for flexure. The maximum steel ratio calculations are illustrated in the flowchart shown in Figure 2.14. These flowcharts are transformed to the subroutines `Flanged_Beam_analysis` and `RhoMax_FlangedSection` respectively.

$$\begin{aligned}
 d &= h - d_c, \rho_1 = A_s / b_f d \\
 \rho &= A_s / bd, \rho' = A_s' / bd \\
 \rho_f &= \frac{0.85 f_c (b_f - b) h_f}{f_y bd} \\
 &\text{Rho_Min, Beta_1}
 \end{aligned}$$

Figure 2.13 Flowchart for analysis of flanged beam, subroutine `Flanged_Beam_Analysis`

30

Start

A

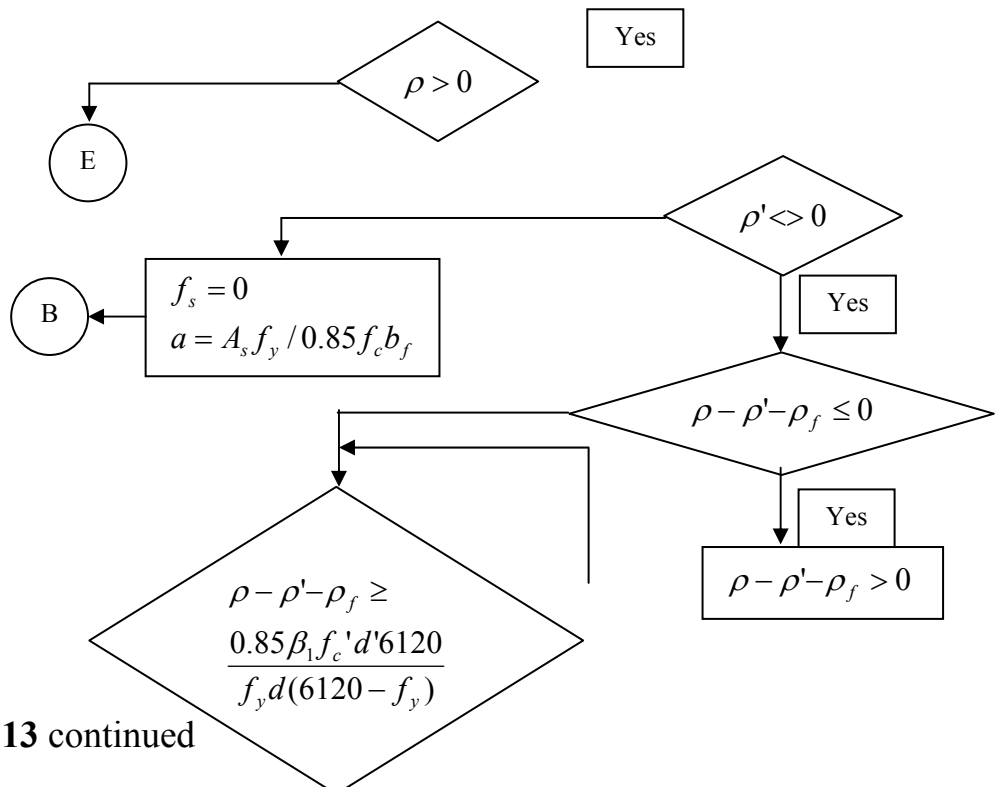
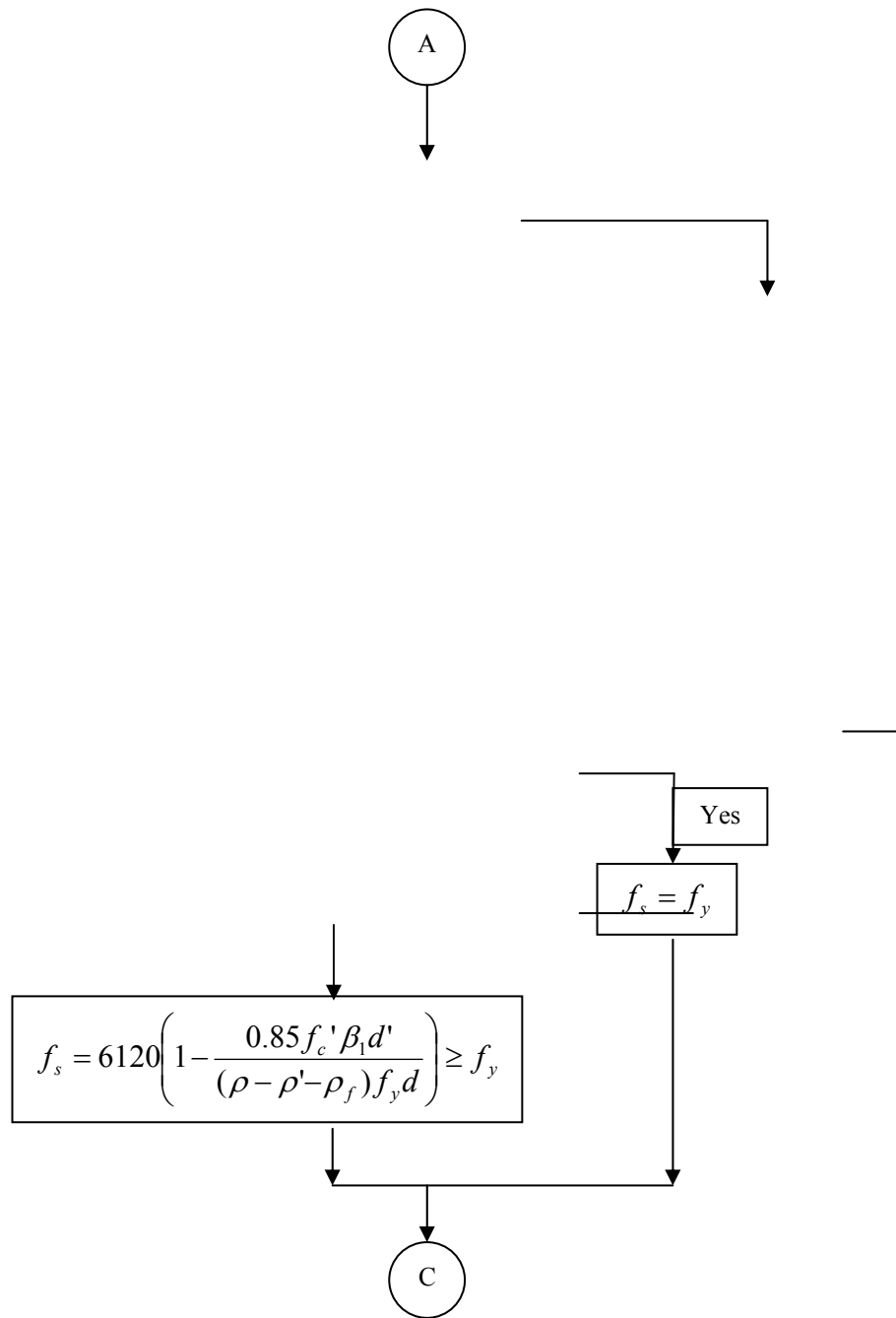

Figure 2.13 continued



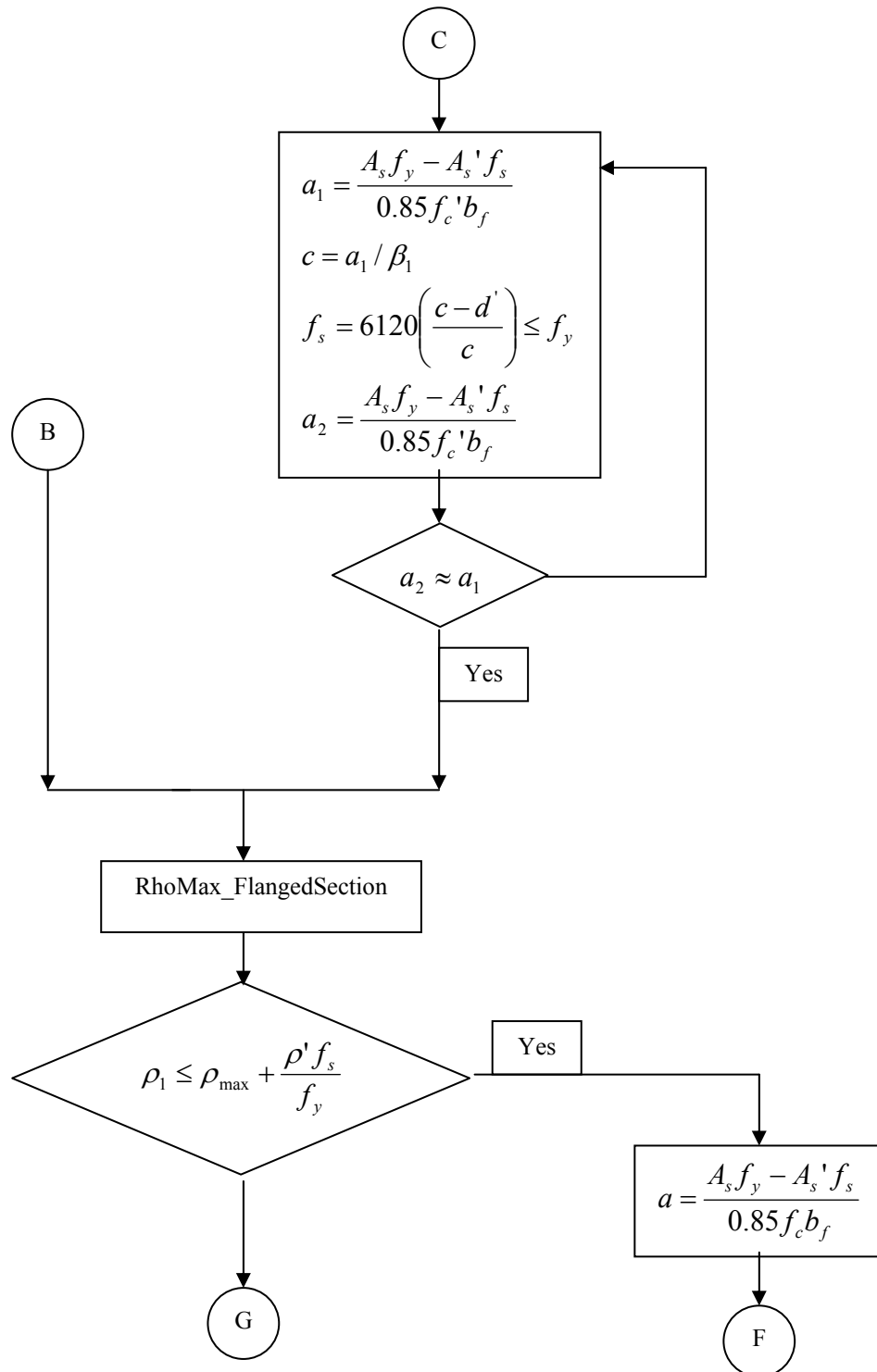
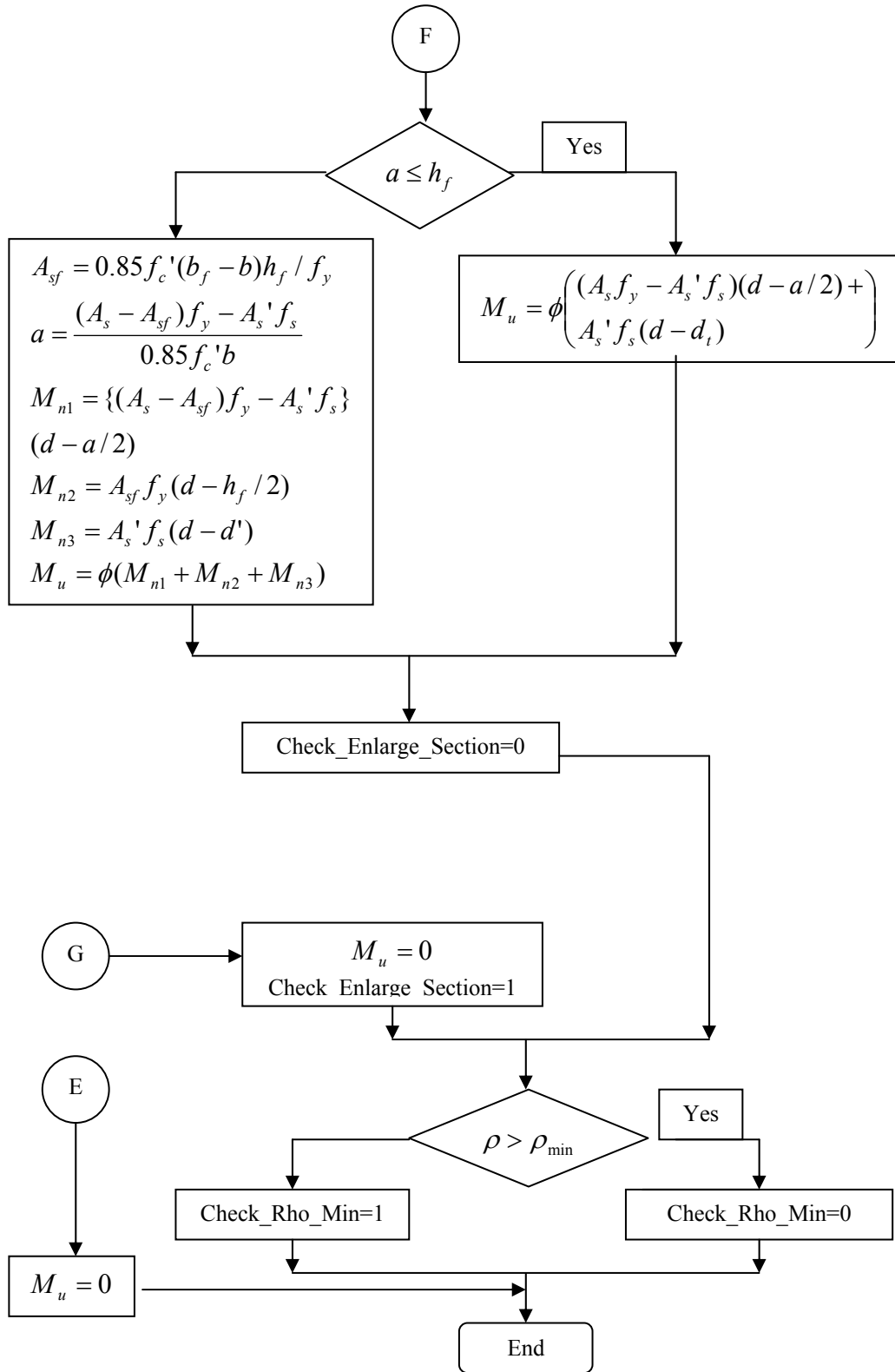

Figure 2.13 continued

Figure 2.13 continued



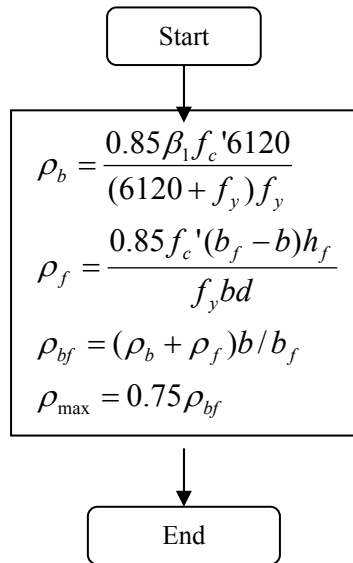

Figure 2.14 Flowchart to calculate maximum steel ration in flanged section, subroutine RhoMax_FlangedSection

2.2.5 Design of Flanged Beam Section for Flexure:

In designing for a factored negative moment, the calculation of the steel area is exactly as rectangular beam section, no flanged beam section data is to be used. For the positive moment, the depth of the compression block is given by(M_u in ton.m, a, d and b_f in cm and f_c' in kg/cm^2):

$$a = d - \sqrt{d^2 - \frac{2 \times 10^5 M_u}{0.85 f_c' \phi b_f}}$$

The maximum allowed depth of compression block is given by

$$a = 0.75 \beta_1 c_b$$

If $a \leq h_f$, the subsequent calculations for A_s are exactly the same as previously defined for the rectangular section design. However, in case the width of the compression flange is taken as the width of the beam. Whether compression reinforcement is required depends on whether $a > a_{max}$.

If $a > h_f$, calculation for A_s is done in two parts. The first part is for balancing the compressive force from the flange, C_f , and the second is for balancing the compressive force from the web, C_w . C_f is given by

$$C_f = 0.85f_c'(b_f - b)h_f \quad (2.33)$$

Therefore, $A_{s1} = C_f/f_y$ and the portion of M_u that is resisted by the flange is given by

$$M_{uf} = C_f \left(d - \frac{h_f}{2} \right) \phi \quad (2.34)$$

The value of Φ is 0.9. Therefore, the balanced of the moment, M_u to be carried by the web is given by

$$M_{uw} = M_u - M_{uf} \quad (2.35)$$

The web is a rectangular section with dimensions b and d , for which the design depth of the compression block is recalculated as

$$a_1 = d - \sqrt{d^2 - \frac{2 \times 10^5 M_{uw}}{0.85f_c' \phi}} \quad (2.36)$$

If $a_1 > a_{\max}$, compression reinforcement is required and is calculated as follows:

The compressive force in web concrete alone is given by

$$C_c = 0.85f_c'ba_{\max} \quad (2.37)$$

Therefore the moment resisted by concrete web and tensile steel is

$$M_{uc} = C_c \left(d - \frac{a_{\max}}{2} \right) \quad (2.38)$$

the moment resisted by compression steel and tensile steel is

$$M_{us} = M_{uw} - M_{uc} \quad (2.39)$$

The compression steel is computed as

$$A_s' = \frac{M_{us}}{f_s(d-d')\phi} \quad (2.40)$$

$$f_s = 6120 \left(\frac{c-d'}{c} \right) \quad (2.41)$$

The tensile steel for balancing the compression in web concrete is

$$A_{s2} = \frac{M_{uc}}{f_y \left(d - \frac{a_{\max}}{2} \right) \phi} \quad (2.42)$$

The tensile steel for balancing compression steel is

$$A_{s3} = \frac{M_{us}}{f_y(d-d')\phi} \quad (2.43)$$

The total tensile reinforcement, $A_s = A_{s1} + A_{s2} + A_{s3}$, and the total compression reinforcement is A_s' . A_s is to be placed at bottom and A_s' is to be placed at top.

The above procedure is shown in the flowchart in Figure 2.15. This flowchart is transformed to the subroutine `Flanged_Beam_Design`.

Figure 2.15 Flowchart for design of flanged section for bending moment, subroutine Flanged_Beam_Design

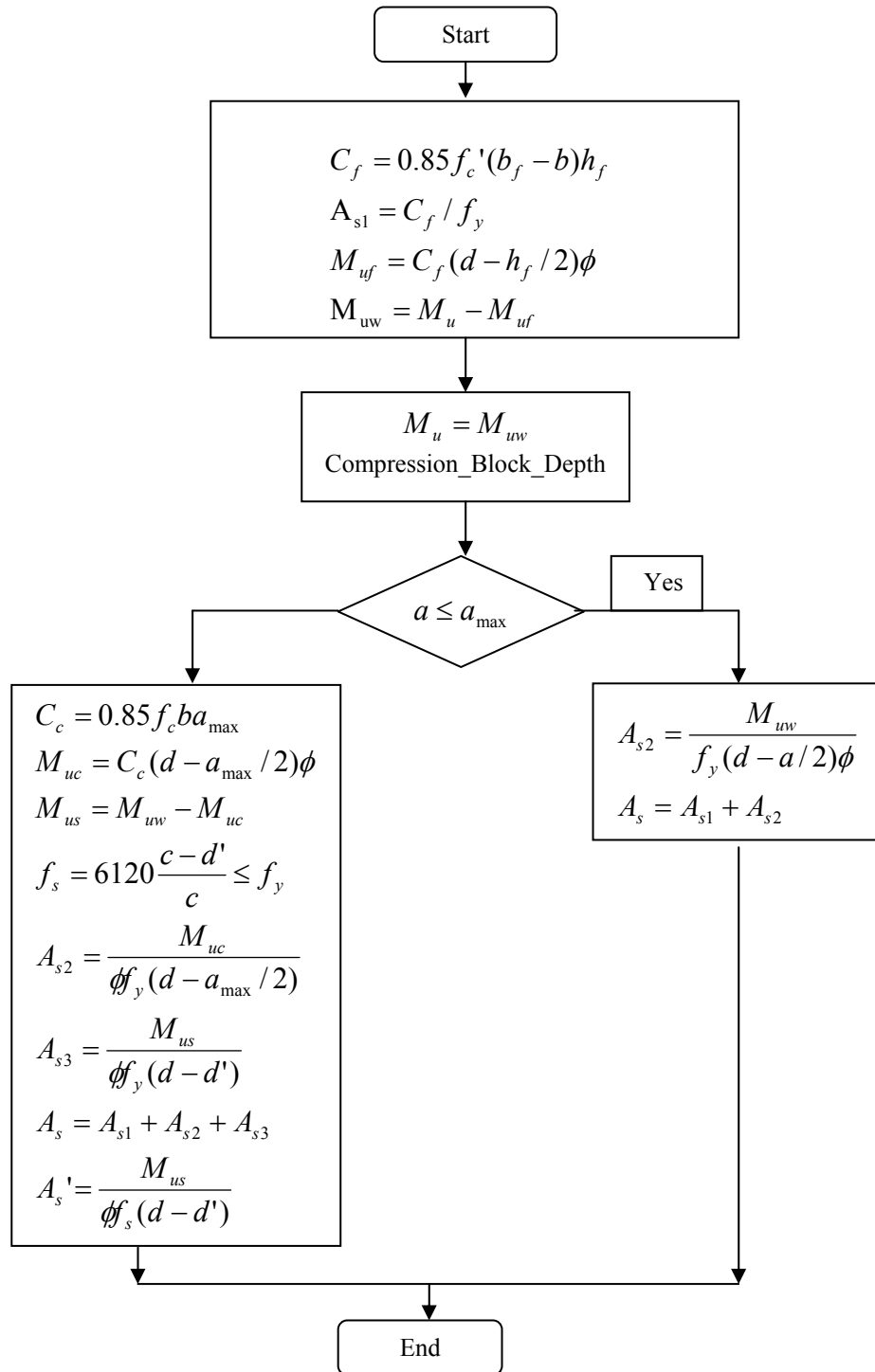

2.3 Analysis and Design for Shear and Torsion:

The shear reinforcement is designed in the major direction of the beam section (parallel to the direction of the load that causes deflection to the beam element), and in the major and minor directions of the column section (in both directions of column section). The beam in this program is designed for uniaxial bending moment, major direction shear and torsion. The axial force, P_u on the section affects the shear capacity of the section. The axial load applied on the beam is restricted to $0.1 f_c' A_g$ (A_g : gross section area).

The main steps in the design of a beam or a column section for shear are as follows:

1. Determine the shear force capacity, V_c that can be resisted by the concrete alone. The applied axial force affects this value.
2. Calculate the reinforcement steel required to carry the applied shear force considering vertical stirrups only.

2.3.1 Determining Concrete Shear Capacity:

Given the design forces P_u and V_u , the shear force carried by the concrete, V_c , is calculated as follows:

1. If the section is subjected to axial compression (P_u is positive):

$$V_c = 0.53\sqrt{f_c'}\left(1 + \frac{P_u}{140A_g}\right)A_c \quad (2.44)$$

where

A_g = gross section of the member in cm^2

f_c' = concrete compressive strength in kg/cm^2

P_u = applied axial force in kg

A_c = area of concrete used to determine shear stress in cm^2

V_c = shear force resisted by concrete in kg

$$\sqrt{f_c'} \leq 70 \text{ kg} / \text{cm}^2$$

and

$$V_c \leq 0.926 \sqrt{f_c'} \sqrt{1 + \frac{P_u}{35 A_g}} A_c \quad (2.45)$$

2. If the section is subjected to axial tension (P_u is negative):

$$V_c = 0.53 \sqrt{f_c'} \left(1 + \frac{P_u}{35 A_g} \right) A_c \quad (2.46)$$

The procedure of calculating V_c is shown in the flowchart in Figure 2.16.

This flowchart is transformed to the subroutine Concrete_Shear_Capacity.

2.3.2 Determining Required Shear Reinforcement:

Given V_u and V_c , the nominal shear force is given by

$$V_n = V_u / \phi \quad (2.47)$$

Where $\Phi = 0.85$ for shear design. Then the nominal shear force, V_n is compared with section shear capacity, V_c as follows:

- if $V_n \leq V_c/2$, no shear reinforcement is required
- if $V_c \geq V_n > V_c/2$, minimum shear reinforcement should be used except in the following cases:

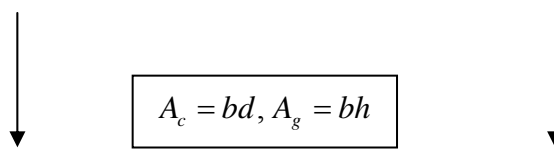

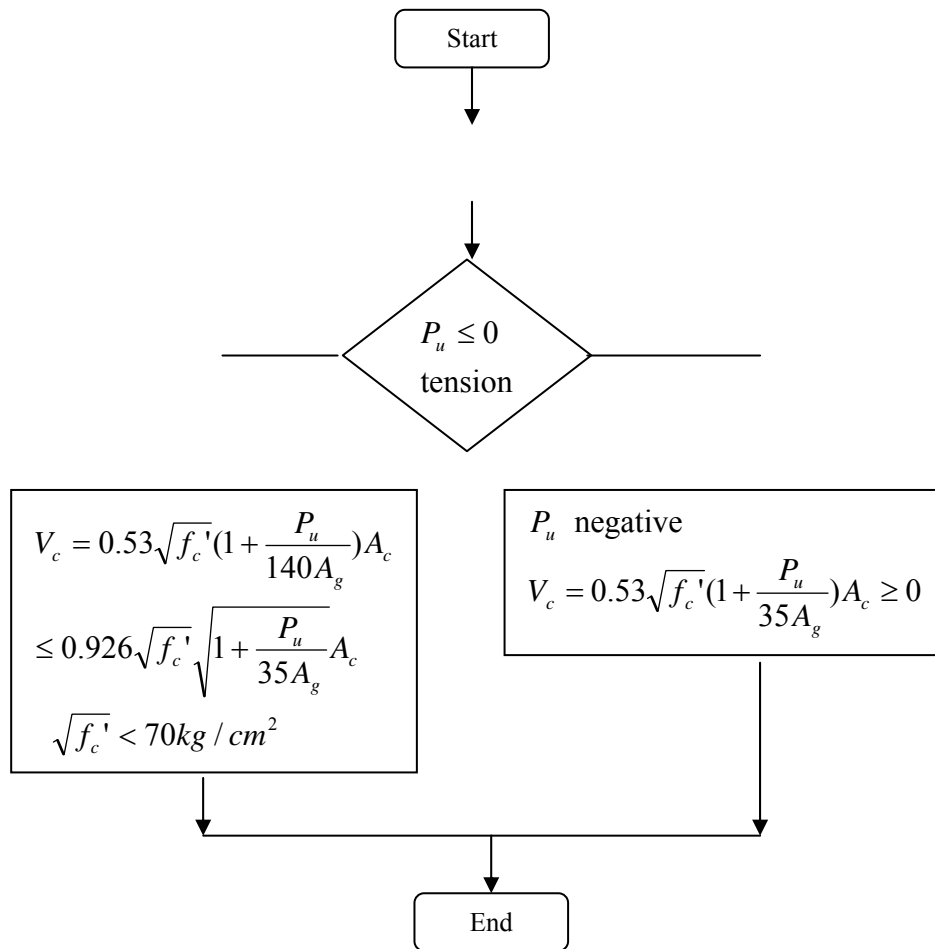

Figure 2.16 Flowchart for calculating, V_c , subroutine Concrete_Shear_Capacity

1. Slabs and footings
2. Concrete joist construction
3. Beams with total depth not greater than 25 cm, 2.5 times thickness of flange, or $\frac{1}{2}$ the width of web, which is the greatest.

The minimum shear reinforcement A_v/s is given by:

$$\frac{A_v}{s} = 3.5 \frac{b}{f_y} \quad (2.48)$$

Where A_v is the area of stirrup legs in a section.

□ if $V_n > V_c$, the shear value that will be resisted by shear

$$V_s = V_n - V_c \quad (2.49)$$

reinforcement, V_s will be:

$$V_s \leq 2.117\sqrt{f_c'}A_c \quad (2.50)$$

Otherwise, the section is not adequate and it needs enlargement.

The shear reinforcement A_v/s will be given as

$$\frac{A_v}{s} = \frac{V_s}{f_y d} \quad (2.51)$$

The stirrups spacing are limited to

$$V_s \leq \sqrt{f_c'}bd \quad s = \text{minimum}(d/2, 60 \text{ cm}) \quad (2.52a)$$

$$V_s > \sqrt{f_c'}bd \quad s = \text{minimum}(d/4, 30 \text{ cm}) \quad (2.52b)$$

The procedure for finding the maximum stirrups spacing of shear reinforcement is illustrated in the flowchart in Figure 2.17

2.3.3 Section Analysis for Shear:

The program calculates the design shear force for a given section dimensions and shear reinforcement. The shear force resisted by the shear reinforcement is given by

$$V_s = \frac{A_v}{s} f_y d \quad (2.53)$$

The stirrups spacing defined in Equation 2.52 limits the shear resisted by shear reinforcement, V_s . Then the design shear capacity is given by

$$V_d = \phi(V_s + V_c) \quad (2.54)$$

Figure 2.17 Flowchart to find shear S_{max} , flowchart
Shear_Maximum_Spacing

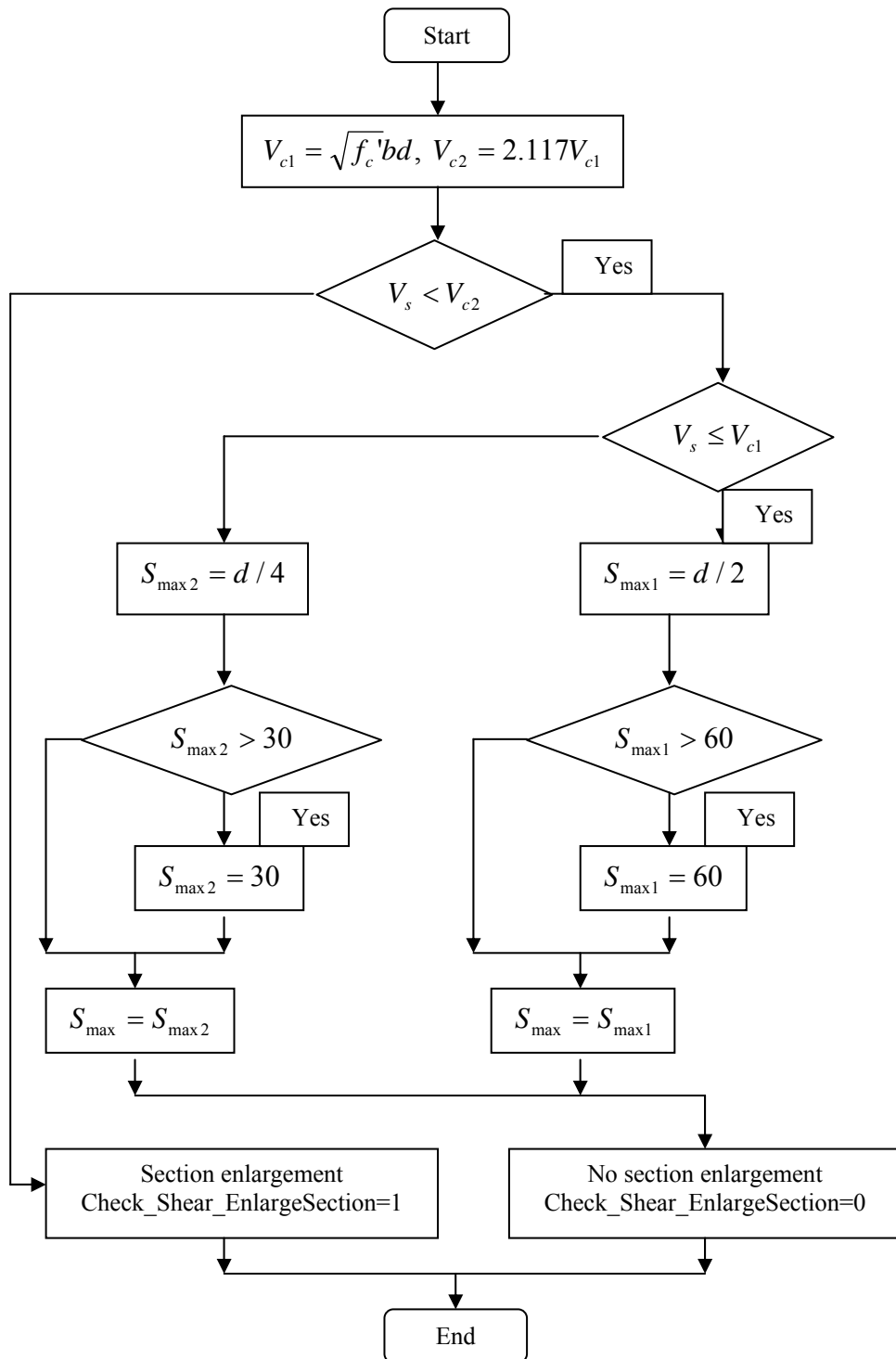

The concrete shear capacity is affected by applied axial force on the section. The program introduces a diagram that relates the axial load and the shear capacity of the section in both directions of column section and in

the major direction of a beam section. The analysis steps for shear force capacity of a section for a given reinforcement are illustrated in the flowcharts in Figures 2.18 to 2.22. These flowcharts are transformed to the subroutines `ShearReinforcement_Capacity_Vs`, `Shear_VsMax`, `Shear_AvOverS_AtOverS`, `Section-Design_Shear_Capacity` and `Shear_Vn_Vs` respectively.

2.3.4 Design for Shear and Torsion:

The ultimate torsion, T_u on a section is the value of torsion at distance d from face of support. The applied shear and torsion forces made surface stresses on the section. The shear force, V_u is resisted usually by the vertical legs of the stirrups in a beam section or ties or spirals in a column section. The torsion force is usually resisted by stirrups or ties in addition to longitudinal reinforcement along the member especially at the corners. The design steps for combined shear and torsion are as follows:

1. Calculate the section torsional moment capacity, T_{uc} . If the applied torsion T_u is less than the section torsional moment capacity, the torsional moment is neglected and the design will be performed for shear only. T_{uc} is given by:

$$T_{uc} = T_{min} = 0.265\phi\sqrt{f_c'} \frac{A_{cp}^2}{P_{cp}} \quad (2.55)$$

$$A_{cp} = b h \quad (2.56)$$

$$P_{cp} = 2(b + h) \quad (2.57)$$

Figure 2.18 Flowchart to compute capacity of shear reinforcement, subroutine `ShearReinforcement_Capacity_Vs`

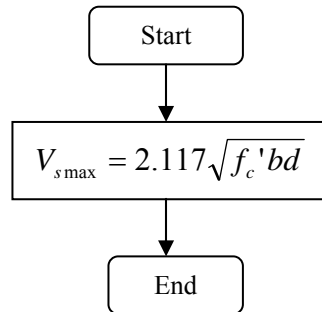
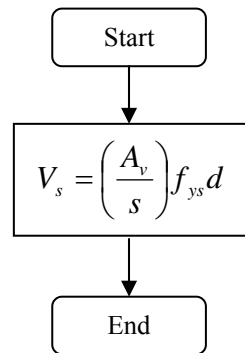

Figure 2.19 Flowchart to compute maximum allowed shear capacity of reinforcement, subroutine Shear_Vsmax

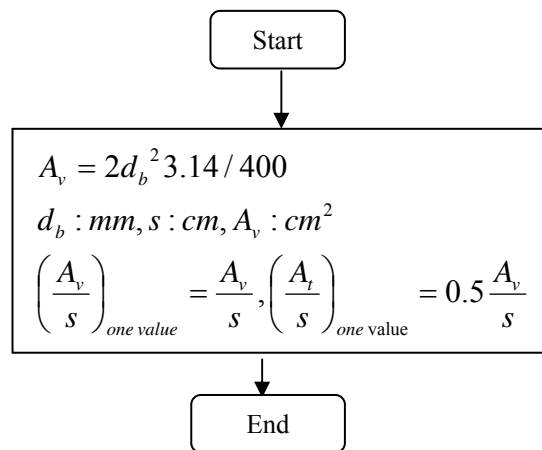

Figure 2.20 Flowchart to compute A_v/s and A_t/s variables, subroutine Shear_AvOverS_AtOverS

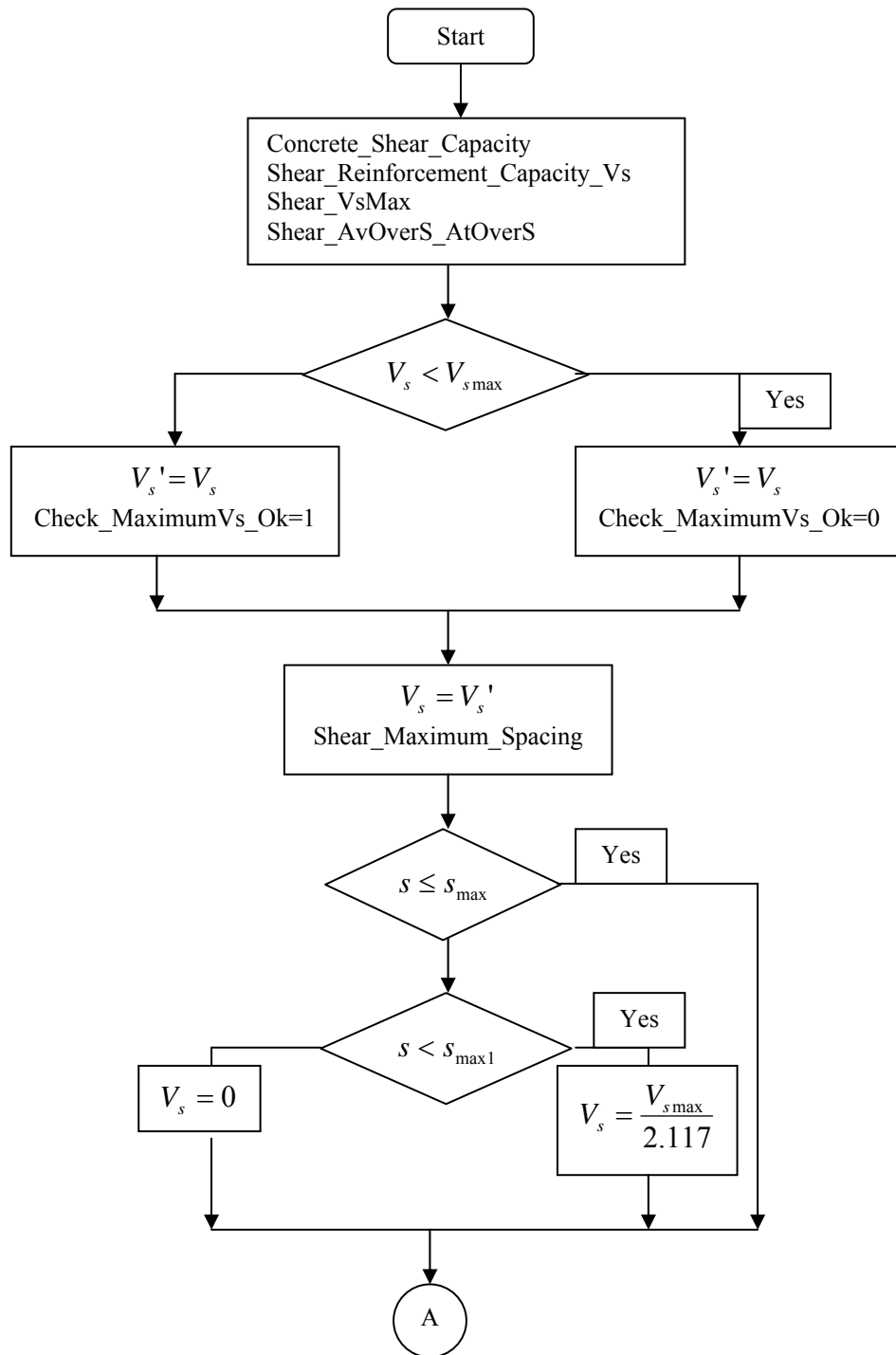

Figure 2.21 Flowchart to calculate shear capacity for given shear reinforcement, subroutine Section_Design_Shear_Capacity

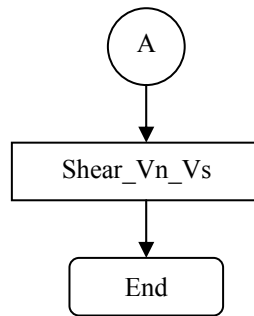

Figure 2.21 continued

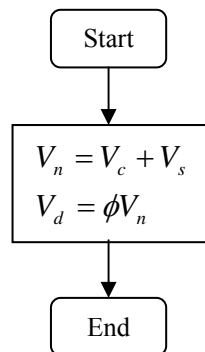

Figure 2.22 Flowchart to calculate V_n and V_d , subroutine Shear_Vn_Vs

where

A_{cp} = area enclosed by outside perimeter of concrete cross section

P_{cp} = outside perimeter of concrete cross section

2. Check section adequacy. The section should satisfy the following equation:

$$\sqrt{\left(\frac{V_u}{bd}\right)^2 + \left(\frac{T_u P_h}{1.7 A_{oh}^2}\right)^2} \leq \phi \left\{ \frac{V_c}{bd} + 2.117 \sqrt{f'_c} \right\} \quad (2.58)$$

If not, the section should be enlarged.

where

V_u = the applied shear force in kg

T_u = the applied torsional moment in kg.cm

b = section web width in cm

d = section effective depth in cm

f_c' = concrete compressive strength in kg/cm²

A_{oh} = area enclosed by the centerline of the outmost closed transverse torsional reinforcement; stirrups in cm²

P_h = perimeter of centerline of outmost closed transverse torsional reinforcement; stirrups in cm.

V_c = concrete compressive strength, this value is affected by the applied axial force

Φ = strength reduction factor for shear which equals 0.85

3. Calculate the required torsional transverse reinforcement such that

$$\frac{A_t}{s} = \frac{T_n}{2A_o f_{ys}} \quad (2.59)$$

where

A_t = area of one leg of the torsional transverse reinforcement; stirrups in cm²

s = torsional transverse reinforcement spacing in cm

T_n = nominal applied torsional moment in kg.cm

f_{ys} = yield strength of torsional transverse reinforcement in kg/cm²

A_o = gross area enclosed by the shear flow, which equals in a rectangular section to $0.85A_{oh}$ in cm^2

4. Calculate the required shear reinforcement A_v/s as discussed in previous sections.

$$V_s = V_n - V_c$$

$$V_s \leq 2.117\sqrt{f_c'}A_c$$

If not enlarge section.

$$\frac{A_v}{s} = \frac{V_s}{f_y d}$$

5. Calculate total transverse reinforcement as the sum of the torsional transverse reinforcement and the shear transverse reinforcement as follows

$$\frac{A_{vt}}{s} = \frac{2A_t}{s} + \frac{A_v}{s} \quad (2.60)$$

Then s is found by dividing the area assuming two legs of the stirrup by A_{vt}/s . The maximum allowable spacing of stirrups, s is the smaller of $P_h/8$ and 30cm. Also, the requirements for maximum spacing for shear alone should be satisfied. A_{vt}/s should be larger than $3.5b/f_y$.

6. Calculate the required torsional longitudinal reinforcement A_l , and A_l should be larger than a minimum value A_{lmin} as follows:

$$A_l = \frac{A_t}{s} \frac{P_h f_{ys}}{f_y} \quad (2.61)$$

$$A_{lmin} = 1.323 \frac{\sqrt{f_c'} A_{cp}}{f_y} - \frac{A_t}{s} \frac{P_h f_{ys}}{f_y} \quad (2.62)$$

$$\text{In } A_{lmin}, \frac{A_t}{s} \geq 1.75 \frac{b}{f_{ys}}$$

7. Arrange the longitudinal reinforcement such as at least one bar should be placed at each corner of the stirrup. The spacing between the longitudinal bars should not be larger than 30cm. The program calculates the required longitudinal reinforcement for the applied torsion. This steel is added to the required flexural steel. The torsional longitudinal reinforcement will be distributed as follows: one fourth the area of steel is placed at top of section, one half of the area is placed at middle of the section and one fourth of the area is placed at bottom of the section.

The previous steps of shear and torsion design are translated to flowcharts in Figures 2.23 to 2.30. These flowcharts are transformed to the subroutines Shear_Vs_ForDesign, Shear_Design1, Torsion_Section_properties, Torsion_Tmin, Torsion_Shear_Section_Adequacy, Torsion_Stirrups_MaximumSpacing, Torsion_LongitudinalSteel, and Shear_Torsion_Design respectively.

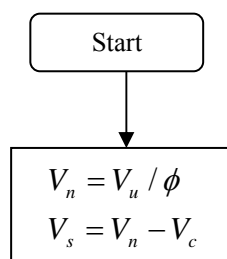

Figure 2.23 Flowchart to calculate V_s for shear design, subroutine Shear_Vs_ForDesign

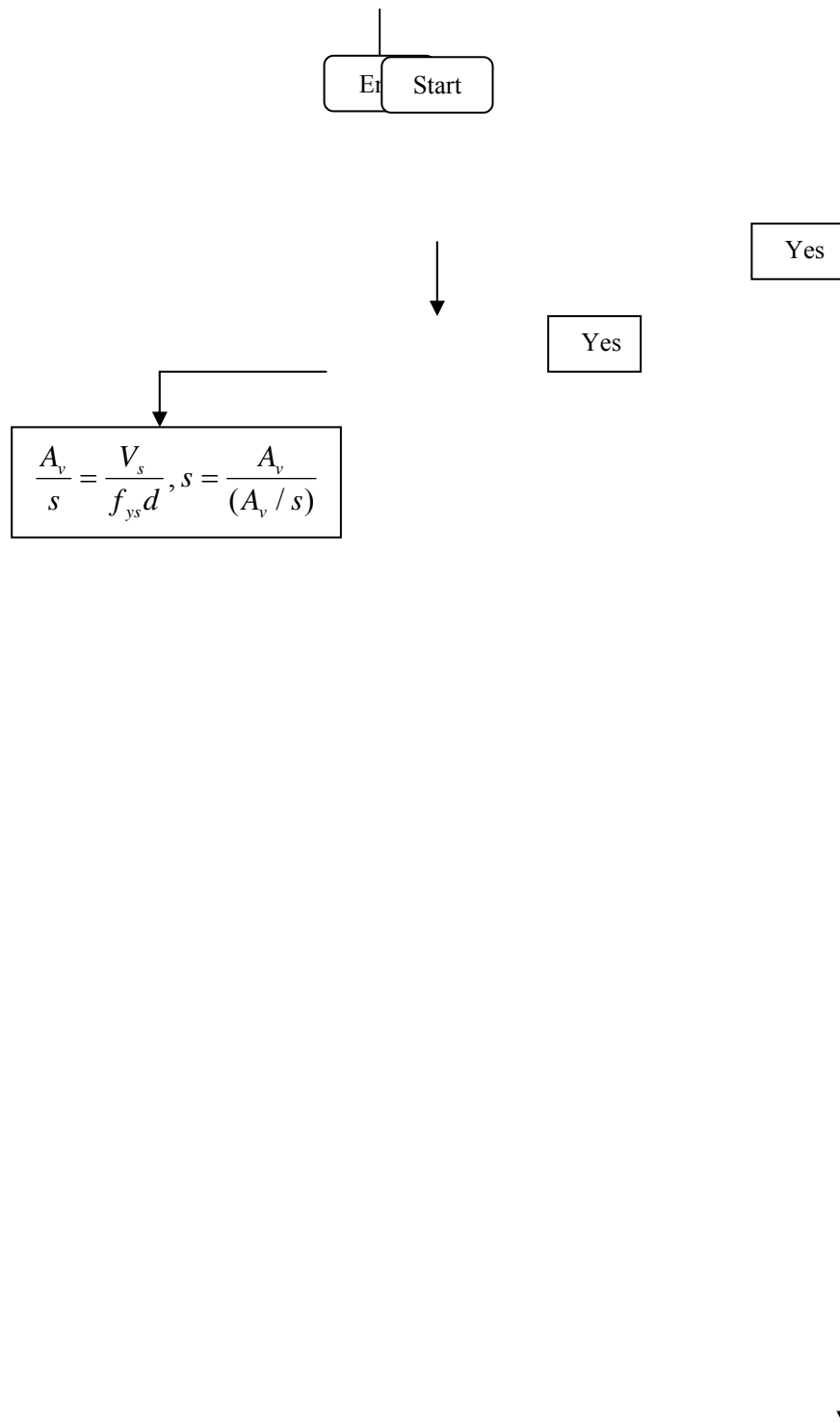
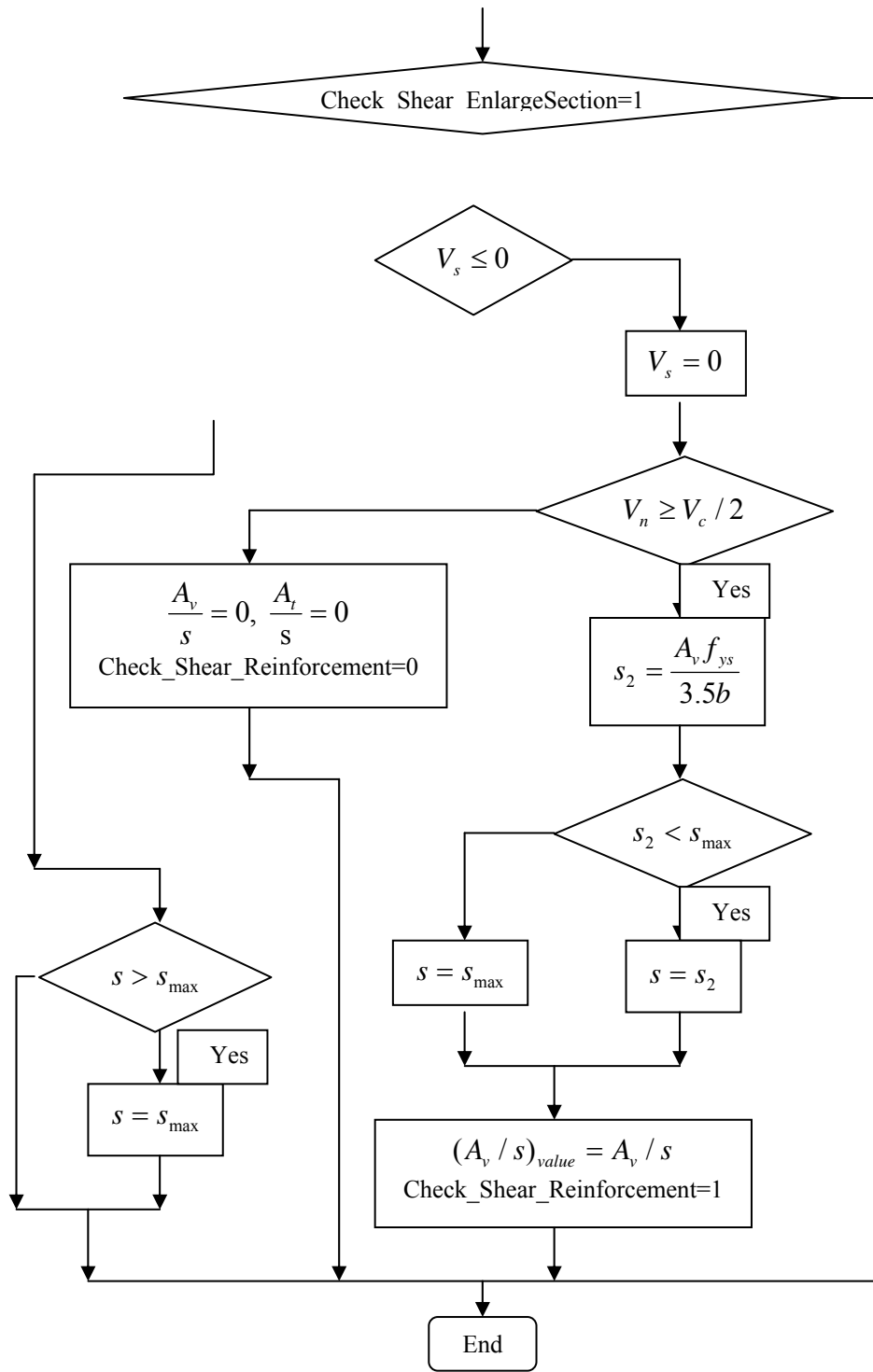

Figure 2.24 Flowchart for design of shear force, subroutine Shear_Design1



Start

$$A_{cp} = bh, P_{cp} = 2(b + h)$$

$$x_1 = b - 2d_s, y_1 = h - 2d'$$

$$A_{oh} = x_1 y_1, A_o = 0.85 A_{oh}$$

$$P_h = 2(x_1 + y_1)$$

Figure 2.25 Flowchart
 Figure 2.27 Flowchart
 subroutine Torsion_She

equation for
 cy for torsion,

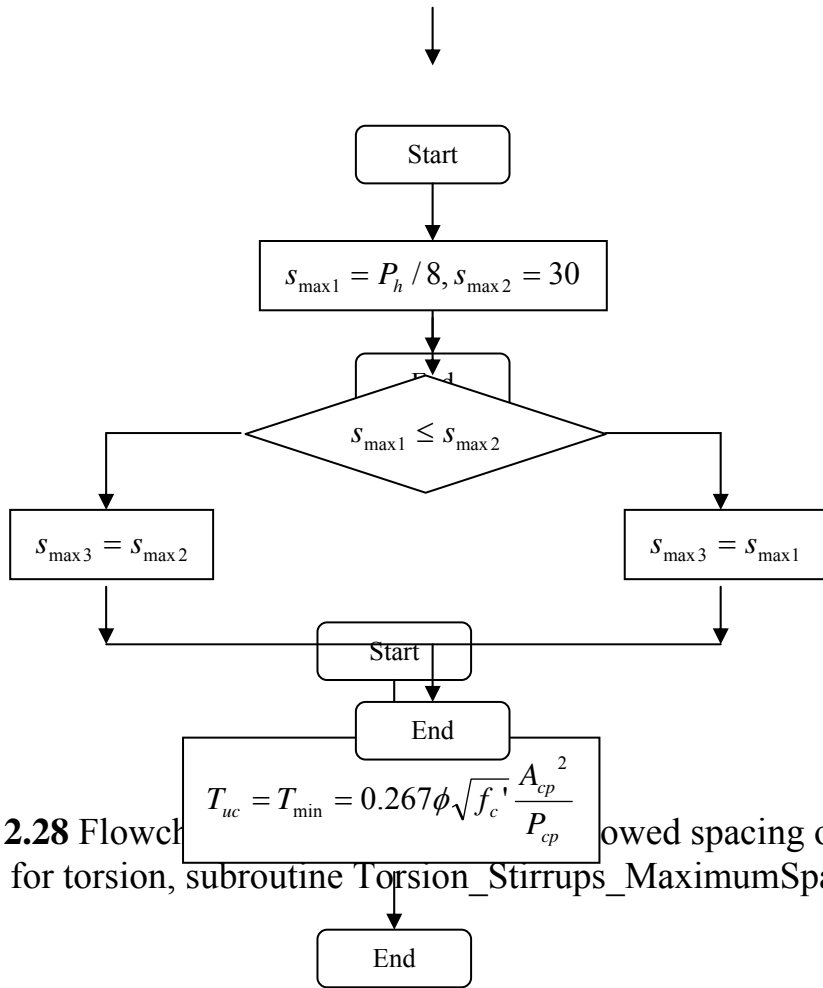

Figure 2.28 Flowchart for determining the maximum spacing of stirrups for torsion, subroutine Torsion_Stirrups_MaximumSpacing

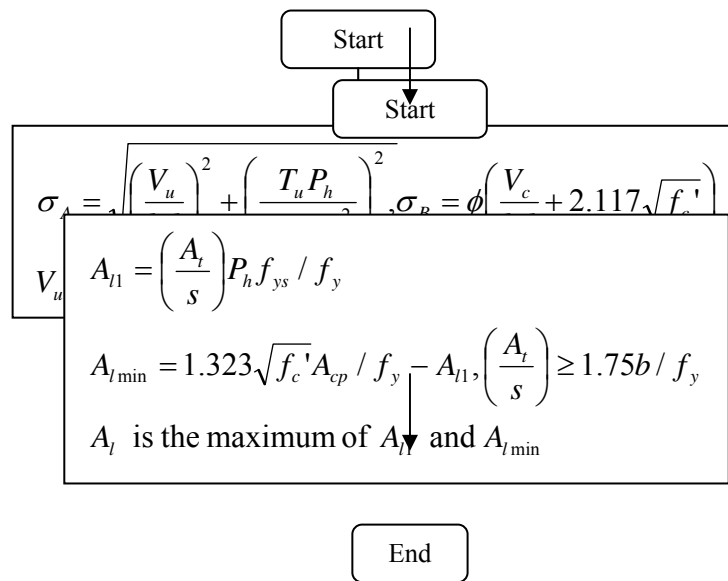

Figure 2.29 Flowchart to calculate the longitudinal steel for torsion, subroutine Torsion_LongitudinalSteel

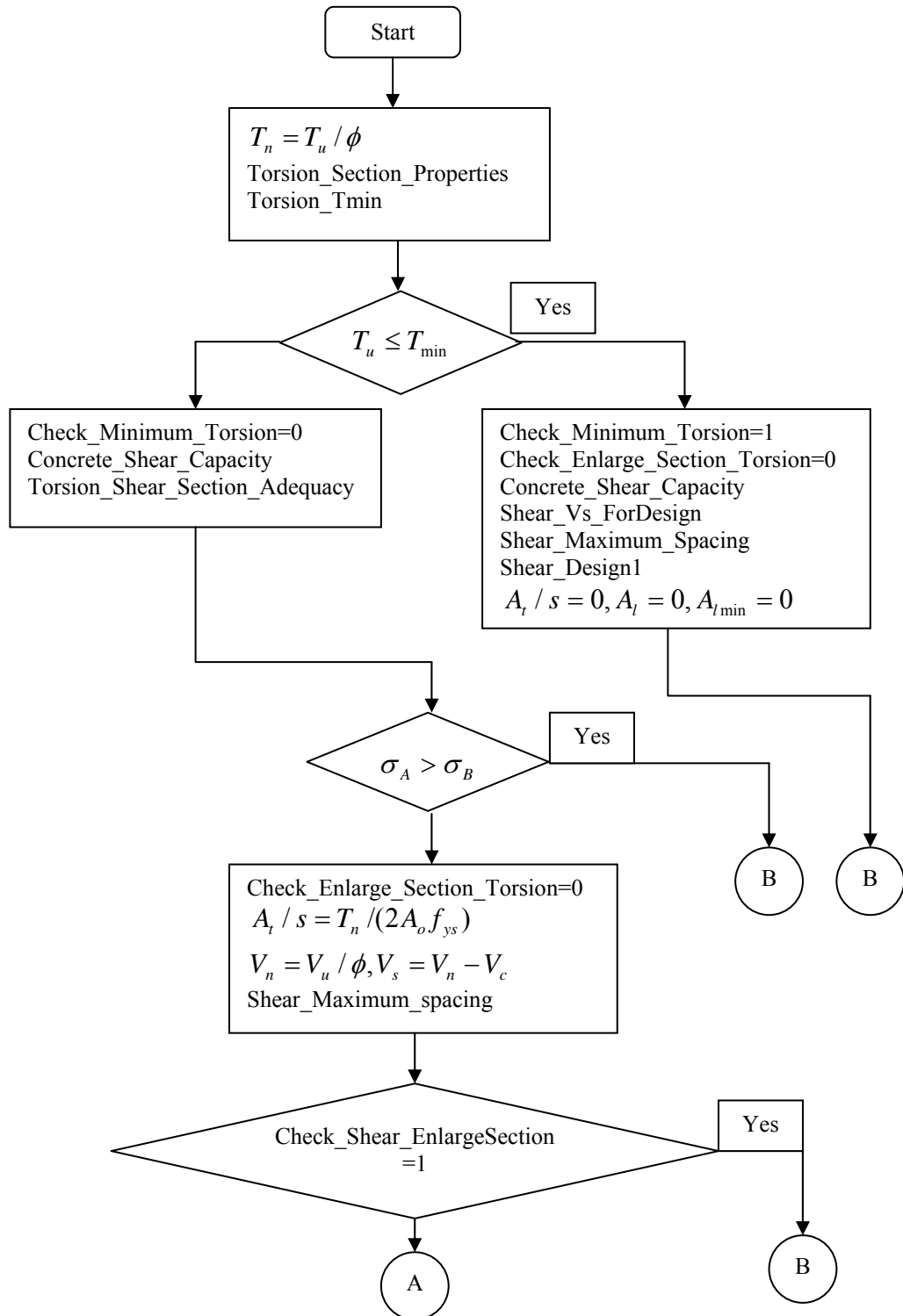

Figure 2.30 Flowchart for shear and torsion design, subroutine Shear_Torsion_Design

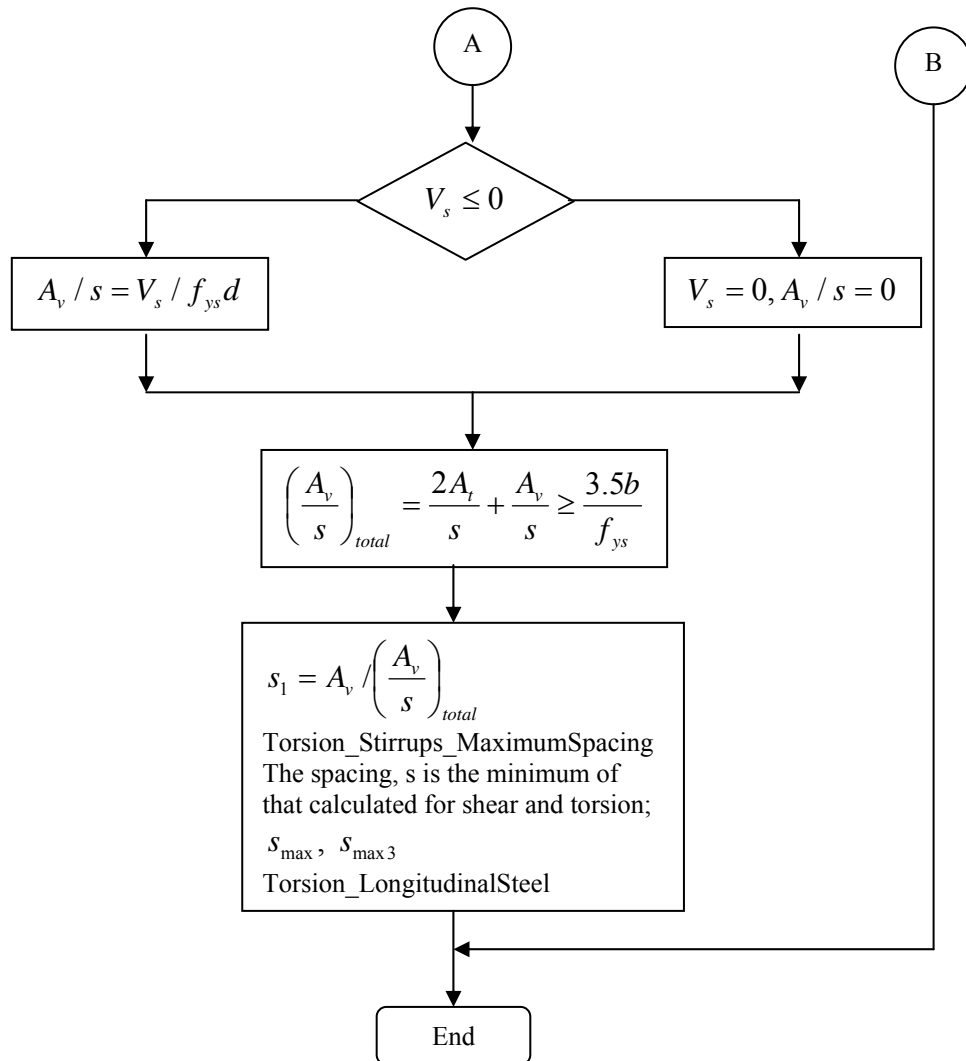

Figure 2.30 continued

2.4 Analysis and Design of Rectangular Column Section for Combined Bending and Axial Forces:

In column analysis, the user specifies the reinforcement configuration; bars locations and areas. The program gives the bending-axial interaction diagram in each direction of the column section.

In column design, the user specifies the applied forces and reinforcement locations or one bar diameter for the given section dimensions. The program gives the required area of steel for the given reinforcement location or the reinforcement location for the given bar area. Also, the program gives the bending-axial interaction diagram in each direction of column section.

The major steps in the design of a column section for combined bending and axial load are:

1. Determine the moment magnification factors for the given bending moments in each direction depending on the type of column; sway or non-sway and the column length and so the final design moments.
2. Introduce a reinforcement bar configuration and then analyze the section. The column section capacity factor (the ratio of the applied column loads to the column capacity) for biaxial bending and axial load is calculated. This factor is calculated according to the contour method, and this factor should be less than one. The reinforcement area is increased from a minimum ratio to a maximum ratio, which are specified by the user, for a specified bar location. This operation is repeated until the section capacity factor becomes less than one.
3. Calculating points of bending-axial interaction diagram.

The major step in column section analysis is calculating points of the interaction diagram.

2.4.1 Section Analysis:

The same principles concerning the stress distribution and the equivalent rectangular stress block applied to beams will be used for column section analysis. Figure 2.31 shows a typical rectangular column cross-section with stress, strain and force distribution. The depth of the neutral axis, C determines the strength of the column. From Figure 2.31, the nominal axial resisting force P_n at failure is:

$$P_n = C_c + C_s - T \quad (2.63)$$

The nominal bending moment is given by:

$$M_n = C_c(h/2 - a/2) + C_s(h/2 - d') + T(d - h/2) \quad (3.64)$$

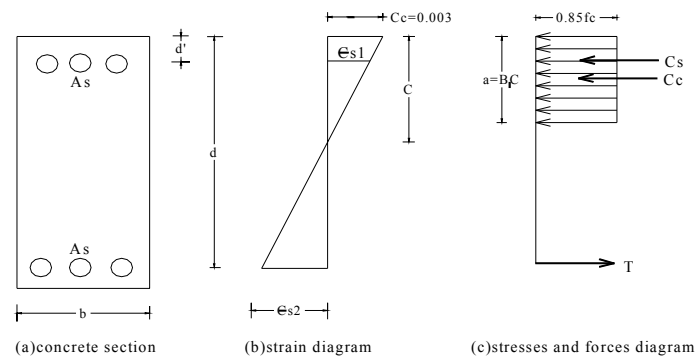

Figure 2.31 Stress and strain distribution in column section

Where

$$C_c = 0.85 f_c' b a \quad (2.65a)$$

$$C_s = A_s f_{s1} \quad (2.65b)$$

$$T = A_s f_{s2} \quad (2.65c)$$

$$f_{s1} = E_s \frac{0.003(c - d')}{c} \leq f_y \quad (2.65d)$$

$$f_{s2} = E_s \frac{0.003(d - c)}{c} \leq f_y \quad (2.65e)$$

This procedure of calculating P_n and M_n is repeated for each row of reinforcement bars using the value of the neutral axis depth, C . Figure 2.32 shows the flowchart for calculating P_n and M_n for rows of reinforcement.

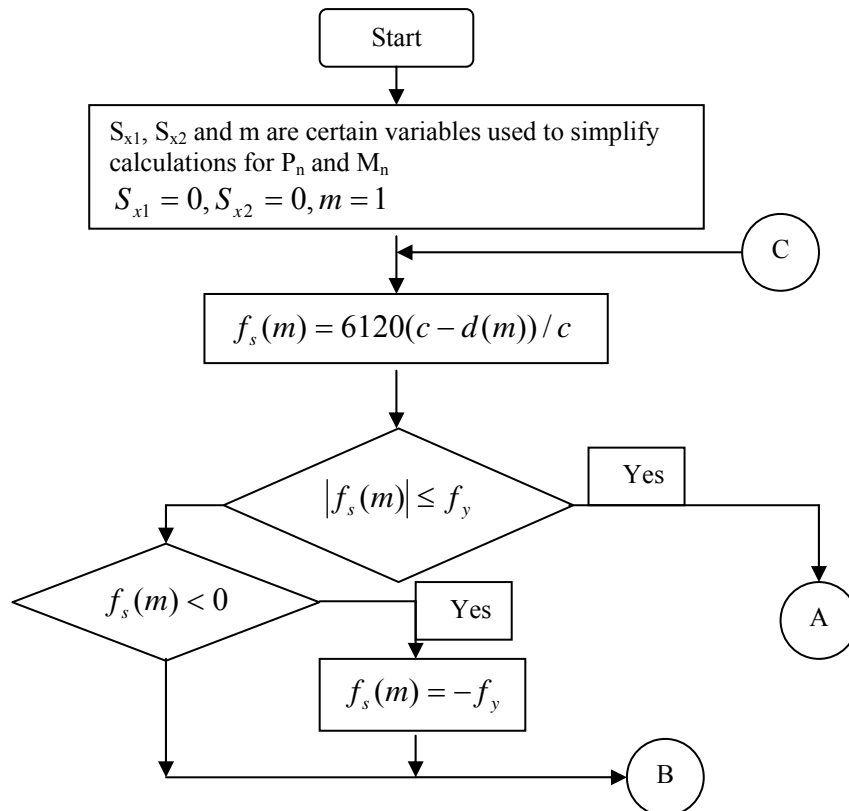
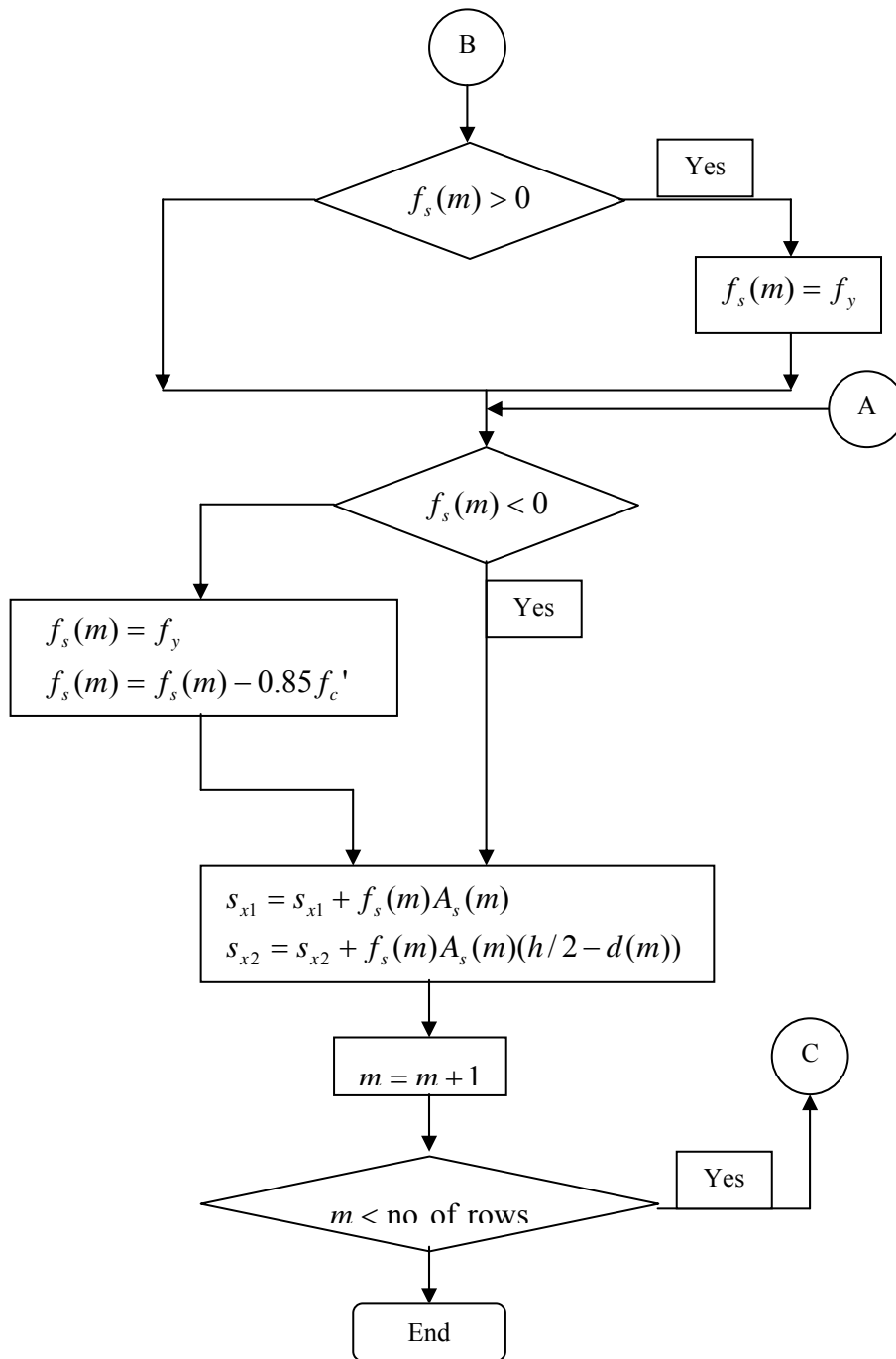

Figure 2.32 Flowchart to calculate force and moment developed in rows of reinforcement, subroutine ReinforcementRow_Force_Moment

Figure 2.32 continued



2.4.2 Uniaxial Bending Moment-Axial Force Interaction Diagram:

The maximum nominal axial load capacity of column section is given by:

$$P_{n(\max)} = \Psi \{ 0.85 f_c' (A_g - A_s) + f_y A_s \} \quad (2.66)$$

Where Ψ is a reduction factor for considering minimum eccentricity and equals 0.8. The maximum design axial load is given by:

$$P_{d(\max)} = P_{u(\max)} = \Phi P_{n(\max)} \quad (2.67)$$

The value of Φ used in the interaction diagram varies from strength reduction factor for compression to strength reduction factor for flexure. The default values are 0.7 and 0.9 respectively. This variation is based on the axial load. For low values of axial loads, Φ is increased linearly from 0.7 to 0.9 as the axial load decreases from the smaller of P_b or $0.1f_c'A_g$ to zero, where P_b is the axial force at the balanced condition. In cases involving axial tension, Φ is always 0.9. Figure 2.33 shows a flowchart for calculation of P_{nb} and M_{nb} and Figure 2.34 shows a flowchart illustrating the steps of computing the strength reduction factor Φ when ΦP_n is smaller than the smaller of $0.1f_c'A_g$ and ΦP_{nb} .

To draw the moment-axial loads interaction diagram, the points of P and M are calculated for different values of rectangular compressive block, c. The major points of the interaction diagram are:

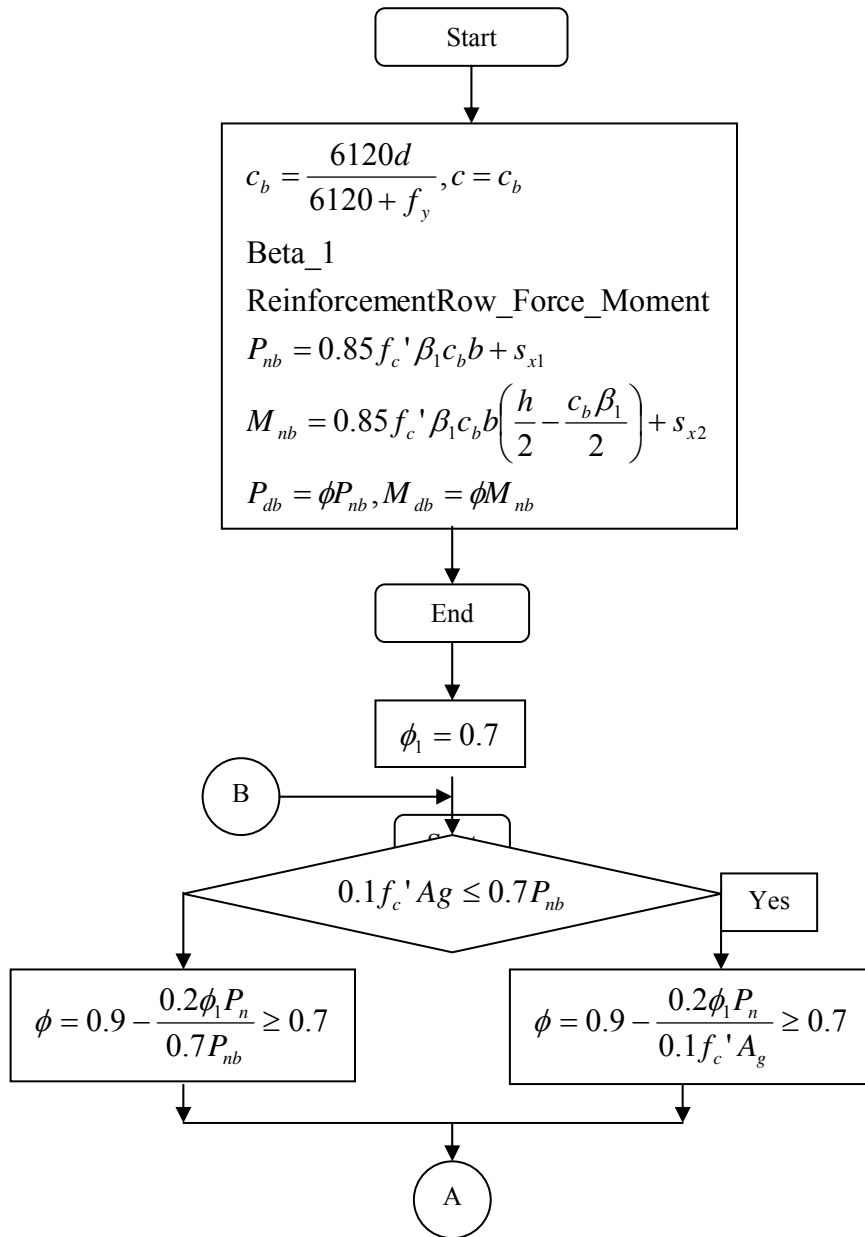

Figure 2.34 Flowchart to calculate sub-routine Phi_Column

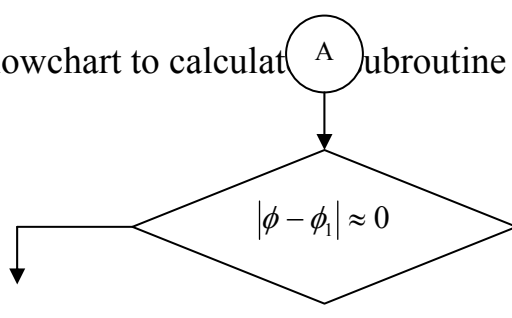
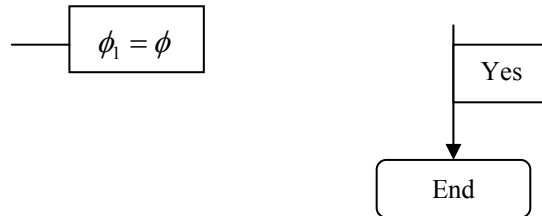

Figure 2.34 continued

1. Pure maximum axial load: as indicated in Equations 2.66 and 2.67
2. Points at the balanced condition: the values of the balanced axial force and bending moment are computed at a value of c_b as shown by the



flowchart in Figure 2.33.

3. Points at axial load equals $0.1f_c'A_g$
4. Pure maximum bending moment at zero axial load
5. Pure tension capacity at zero moment: the tension capacity is given by:

$$P_m = A_{st}f_y \quad (2.68a)$$

$$P_{td} = 0.9P_m \quad (2.68b)$$

The previous discussion is translated to flowcharts that are transformed to computer subroutines. The flowcharts show the steps of calculating the points of the interaction diagram and computations dealing with the bars arrangement in the column section. These flowcharts are introduced in Figures 2.43 to 2.55.

2.4.3 Moment Magnification:

The moment magnification factors are calculated separately for sway, δ_s and for non-sway, δ_{ns} . Also, the moment magnification factors are calculated in both directions depending whether the column is in a sway or non-sway frame.

2.4.3.1 Non-sway Columns:

The slenderness effects are disregarded if

$$\frac{kl_u}{r} \leq 34 - 12 \frac{M_1}{M_2} \quad (2.69)$$

Where

k = equivalent effective length factor

l_u = unbraced column length

r = radius of gyration which equals the square root of the moment of inertia divided by the gross area of the section.

M_1 = the smaller non sway end moment at column ends

M_2 = the larger non sway end moment at column ends

M_1/M_2 is positive for single curvature bent and is negative for double curvature bent.

The moment to be designed will be ($M_u = M_2$)

$$M_c = \delta_{ns} M_2 \quad (2.70)$$

And

$$\delta_{ns} = \frac{C_m}{1 - (P_u / 0.75P_c)} \geq 1.0 \quad (2.71a)$$

$$P_c = \frac{\pi^2 EI_e}{(kl_u)^2} \quad (2.71b)$$

$$I_e = \frac{0.4I_g}{1 + \beta_d} \quad (2.71c)$$

$$C_m = 0.6 + 0.4 \frac{M_1}{M_2} \geq 0.4 \quad (2.71d)$$

Where:

P_c = the critical Euler buckling load for pin-ended columns

P_u = applied factored axial compression

I_e = section effective moment of inertia in the direction of M_2

I_g = section gross moment of inertia in the direction of M_2

E = modulus of elasticity of concrete and it is equal to

$$E = 15100\sqrt{f'_c} \quad (2.72)$$

In equation 2.72, E and f'_c are in kg/cm^2 .

β_d = maximum factored sustained axial load divided by the total factored axial load

C_m = a factor relating the actual moment diagram to an equivalent uniform diagram.

The minimum allowed value of M_2 is

$$M_{2,\min} = P_u(0.015 + 0.03h) \quad (2.73)$$

Where, h is the side length of the column section in the direction of bending in meter.

In equation 2.71d, if M_1 is zero, C_m will be 0.6. If M_1 and M_2 are zeros, C_m will be 1.0.

The above expression of C_m is valid if there is no transverse load applied between the supports. If transverse load is present on the span, C_m will be one.

The magnification factor, δ_{ns} , must be positive number and greater than one. Therefore, P_u must be less than $0.75P_c$. If P_u is found to be greater than or equal to $0.75P_c$, a failure condition is declared.

2.4.3.2 Sway Columns:

For compression members in sway frames, the slenderness effects are neglected if

$$\frac{kl_u}{r} \leq 22 \quad (2.74)$$

The end moments M_1 and M_2 are magnified as follows with the non-sway moments unmagnified, provided that

$$\frac{l_u}{r} \leq \frac{35}{\sqrt{\frac{P_u}{f_c' A_g}}}$$

$$M_1 = M_{1ns} + \delta_s M_{1s} \quad (2.75a)$$

$$M_2 = M_{2ns} + \delta_s M_{2s} \quad (2.75b)$$

On the assumption that $M_2 > M_1$, the design moment, M_c is

$$M_c = M_{2ns} + \delta_s M_{2s} \quad (2.76)$$

Where

M_{1s} = smaller sway end moment (from earthquake, wind and other forces)

M_{2s} = larger sway end moment (from earthquake, wind and other forces)

M_{1ns} = smaller non-sway end moment (from dead and live forces)

M_{2ns} = larger non-sway end moment (from dead and live forces)

The sway moment magnification factor, δ_s is given by

$$2.5 \geq \delta_s = \frac{1}{1 - (\sum P_u / 0.75 \sum P_c)} \geq 1 \quad (2.77)$$

Where,

$\sum P_u$ = the summation for all vertical loads in a story

$\sum P_c$ = the summation of the Euler buckling loads, P_c , for pin-ended columns for all sway resisting columns in a story considering β_d as the ratio of the maximum factored sustained shear within a story to the factored shear in that story which is usually equals to zero except for lateral earth pressure. The user of the program enters the value of δ_s .

In cases where

$$\frac{l_u}{r} > \frac{35}{\sqrt{\frac{P_u}{f_c' A_g}}}$$

The design moment will be the maximum of :

$$M_1 = \delta_{ns} (M_{1ns} + \delta_s M_{1s}) \quad (2.78a)$$

$$M_2 = \delta_{ns} (M_{2ns} + \delta_s M_{2s}) \quad (2.78b)$$

The moment magnification method is developed for prismatic members with kl_u/r not exceeding 100.

The previous equations for calculating C_m , δ_{ns} , P_{cr} , kl/r checks, and the design moment M_c are shown in the flowcharts in Figure 2.35 to 2.42. These flowcharts are transformed to subroutines `Column_Cm`, `Column_Pcr`, `Column_Rg`, `Column_KLRfactor`, `Column_CheckKLRfactor`, `Column_DeltaNs`, `Column_DeltaNs1` and `Column_Mc`.

Figure 2.35 Flowchart to calculate C_m , subroutine `Column_Cm`

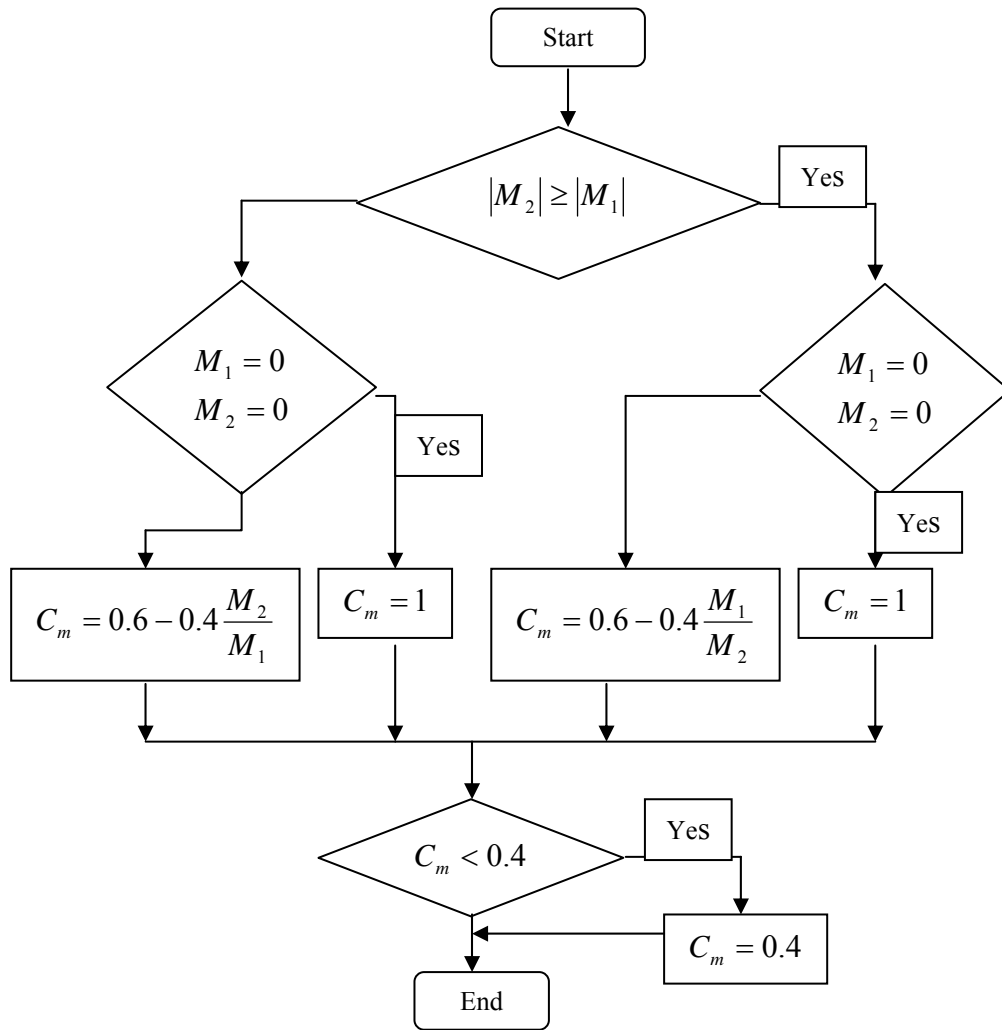

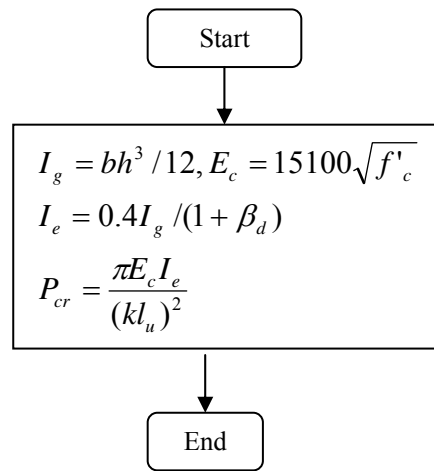

Figure 2.36 Flowchart to calculate P_{cr} , subroutine Column_Pcr

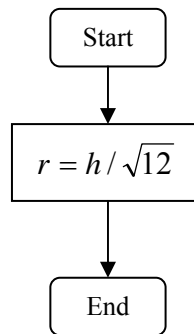

Figure 2.37 Flowchart to calculate radius of gyration, r , subroutine Column_Rg

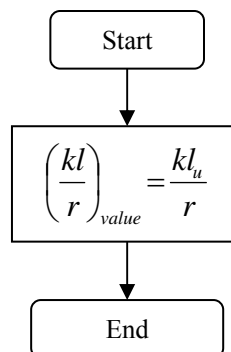

Figure 3.38 Flowchart to calculate Klu/r , subroutine Column_KLRfactor

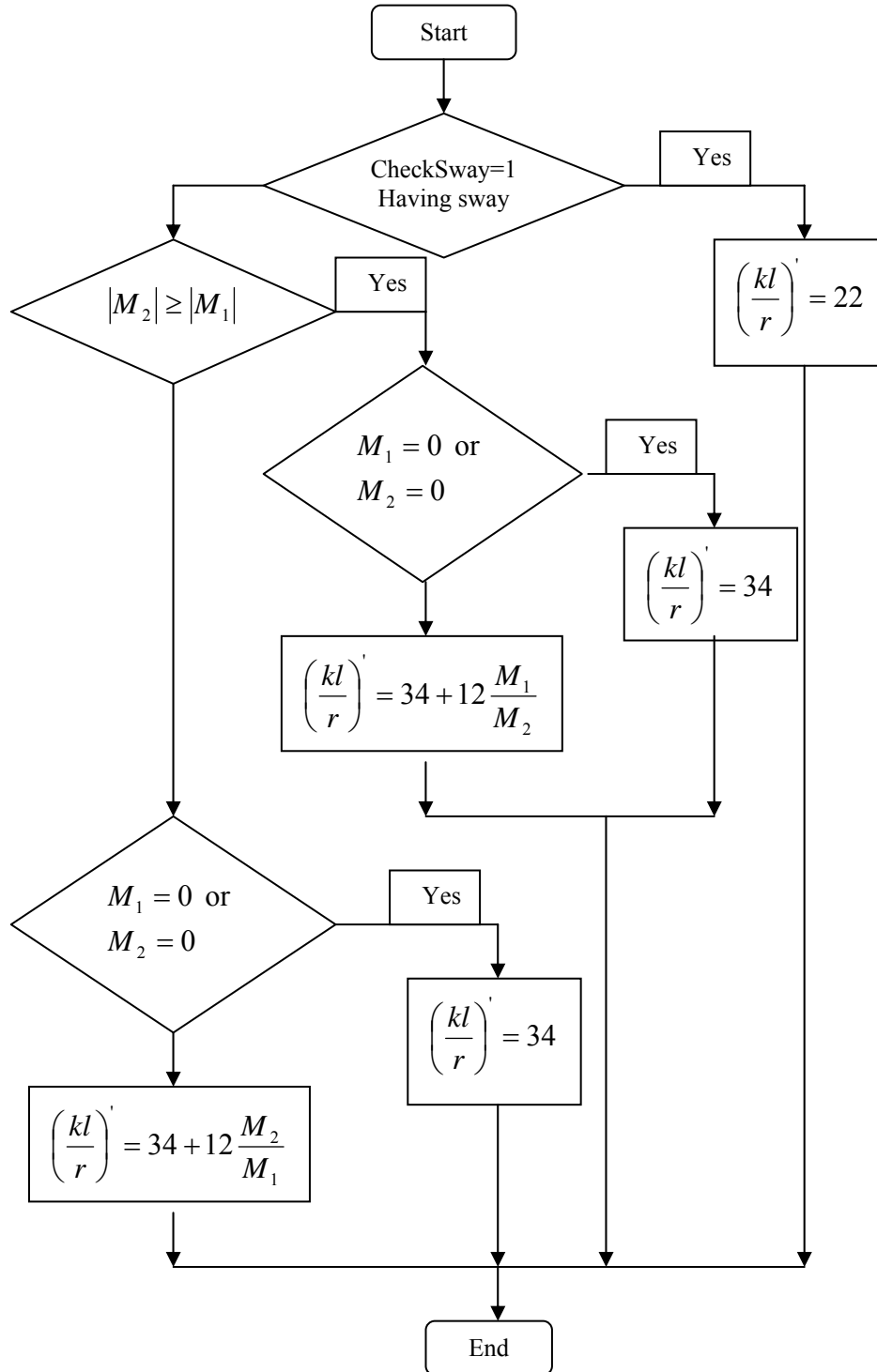

Figure 2.39 Flowchart for checking kl/r for sway and nonsway columns, subroutine `Column_CheckKLRfactor`

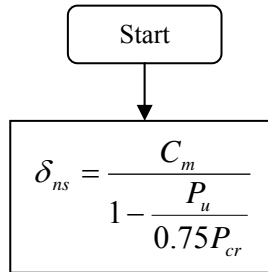

Figure 2.40 Flowchart to calculate δ_{ns} , subroutine Column_DelatNs

Figure 2.41 Flowchart to determine final value of δ_{ns} , subroutine Column_DeltaNs1

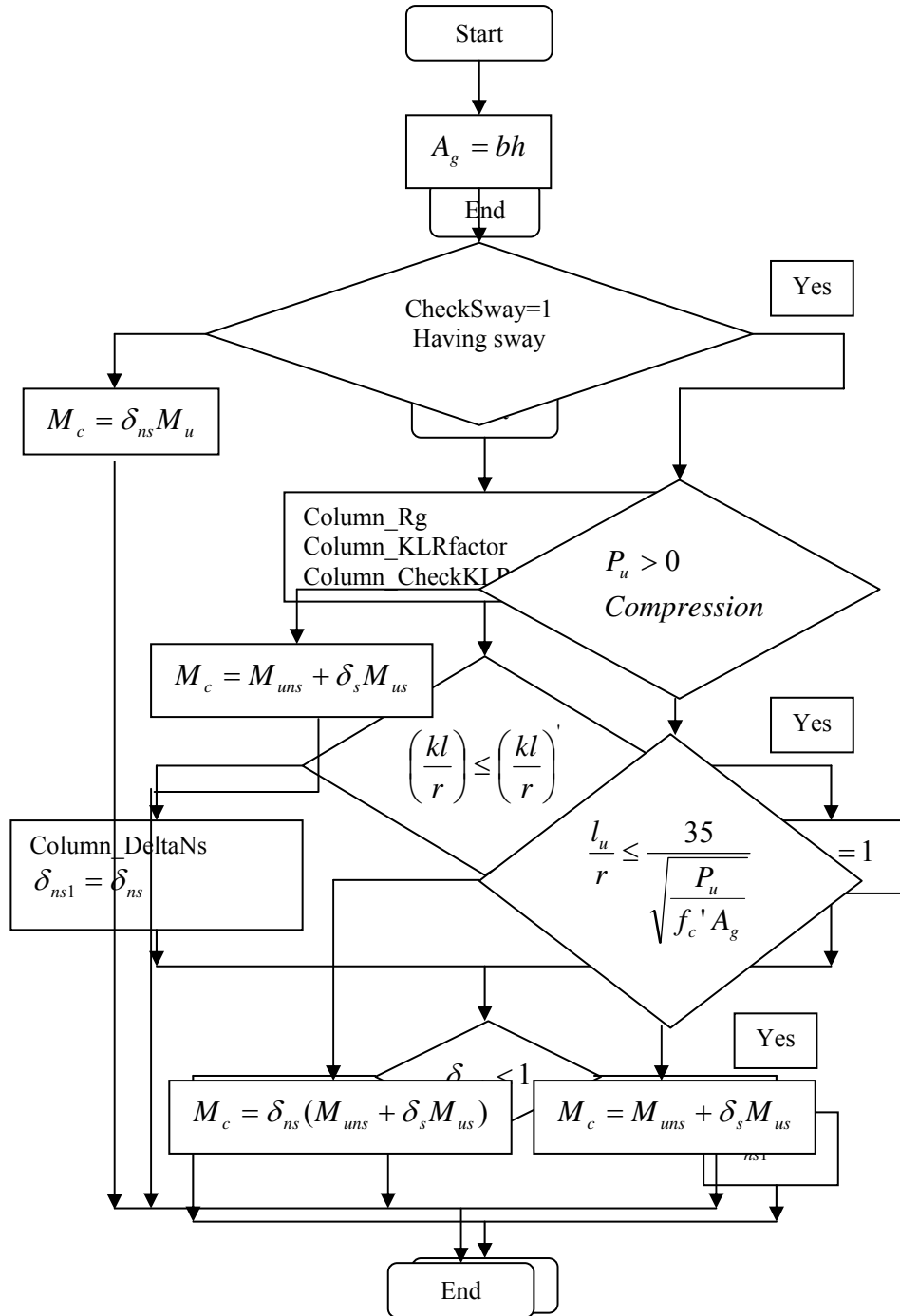

Figure 2.42 Flowchart to calculate the design moment at a point, M_u , subroutine Column_Mu

2.4.4 Load Contour Method:

There are many methods for determining the capacity or designing the column section for biaxial bending. The contour method is the simplest one and can be programmed practically. In this method, the bending moment capacities M_{ox} and M_{oy} are calculated at the given axial load. And then the following equation is applied:

$$\left(\frac{M_{nx}}{M_{ox}}\right)^\alpha + \left(\frac{M_{ny}}{M_{oy}}\right)^\alpha = 1.0 \quad (2.79)$$

Where:

M_{nx} , M_{ny} = applied ultimate bending moments about the x and y axes.

M_{ox} , M_{oy} = ultimate bending moment capacities about the x and y axes at the given nominal axial load, P_u . These values are found using the general case in Figure 2.19 for a trial value of c .

α = exponent depending on the cross section geometry, steel percentage, and its location and material strengths f_c' and f_y . The value of α is given by:

$$\alpha = \frac{\log(0.5)}{\log(\beta)} \quad (2.80)$$

There are charts that relates the value of β to reinforcement configuration, f_c' , f_y , axial load and steel ratio found in some references. These charts do not have specified equations as they were derived from experimental studies. From these charts, the value of β ranges from 0.52 to 0.9. Predominantly, the value of β ranges up to 0.65. The corresponding values of α ranges from 1.05 to 1.6. For design, it is recommended to use a value

of α equals to 1.5 for rectangular sections (reference 5 page 513). Equation 2.80 is used for a value of $\alpha = 1.5$ or $\beta = 0.63$ in this program. For given bending moments and axial load and for a reinforcement configuration, equation 80 is applied. If the section capacity ratio (value of equation 2.79) is greater than 1, an increasing value of bars areas is indicated until the section capacity ratio reaches the value of 1.0 or less.

2.4.5 Column Design Shear Force:

The shear reinforcement is designed for each loading in the two dimensions of column. The column is located in an ordinary, intermediate or special moment resisting frame. The design shear force is calculated as follows:

- In the design of shear reinforcement of an ordinary moment resisting frame (no seismic considerations), the design shear force is found as it is given or calculated from load combination.
- In the shear design of Special moment resisting frame (seismic design), the design shear force is the maximum of the calculated shear force from load combination or the value of V_p calculated from the moment capacities of the section:

$$V_p = \frac{M_{pr1} + M_{pr2}}{h} \quad (2.81)$$

Where M_{pr1} and M_{pr2} are the probable moment strength at the ends of the column based on steel reinforcement tensile strength of $1.25f_y$ and strength reduction factor of one at the given ultimate axial load, P_u and h is the clear height of column. Equation 2.81 is used, as the column does not have transverse loading as the usual case of column condition.

- For intermediate moment resisting frames (seismic design), the design shear force is the minimum of the calculated shear force with the earthquake load factors is doubled and V_p in Equation 2.81 but using steel tensile strength of f_y .

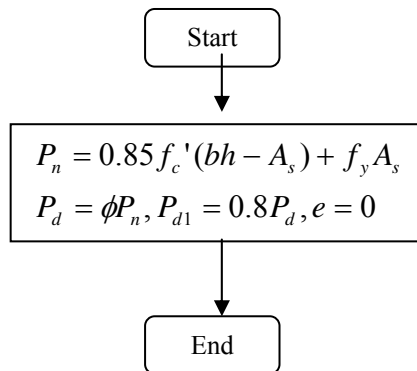

Figure 2.43 Flowchart to calculate the column section axial capacity, subroutine Ultimate_Axial_Capacity

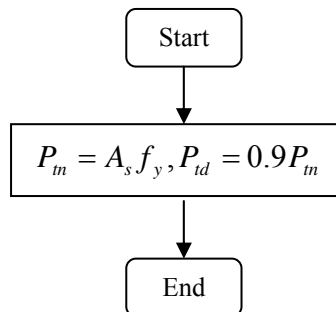

Figure 2.44 Flowchart to calculate the column tension capacity, subroutine Tension_AxialCapacity

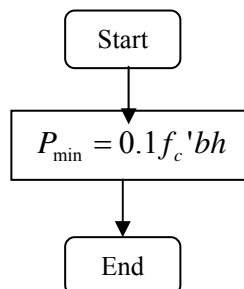

Figure 4.45 Flowchart to calculate the value $0.1 f_c A_g$, subroutine Column_Pmin

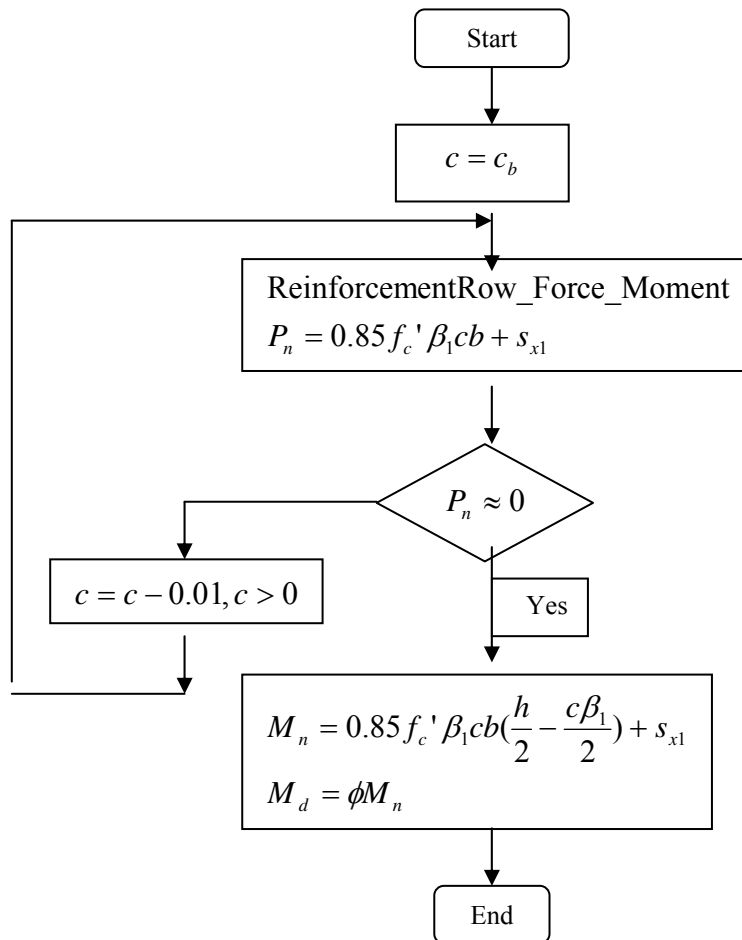

Figure 2.46 Flowchart to calculate pure bending moment capacity, subroutine Column_Pure_Moment

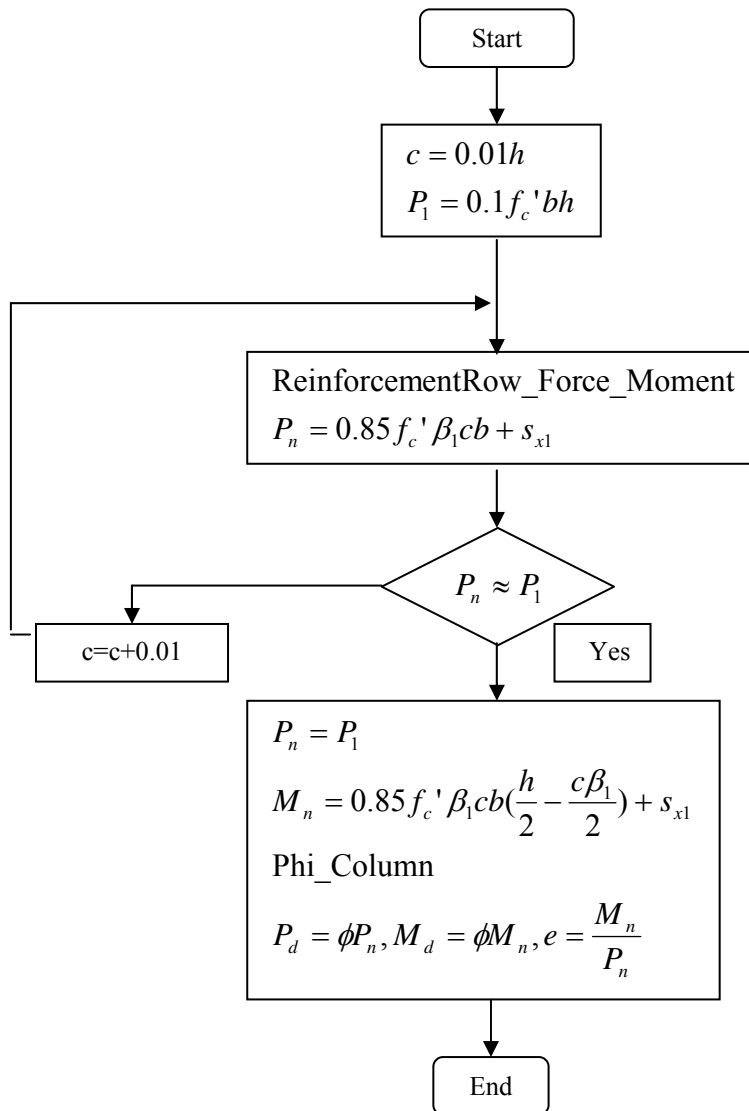

Figure 2.47 Flowchart to calculate bending moment capacity at axial force equals $0.1f_c'A_g$, subroutine Column_Moment_OnetenthFcAg

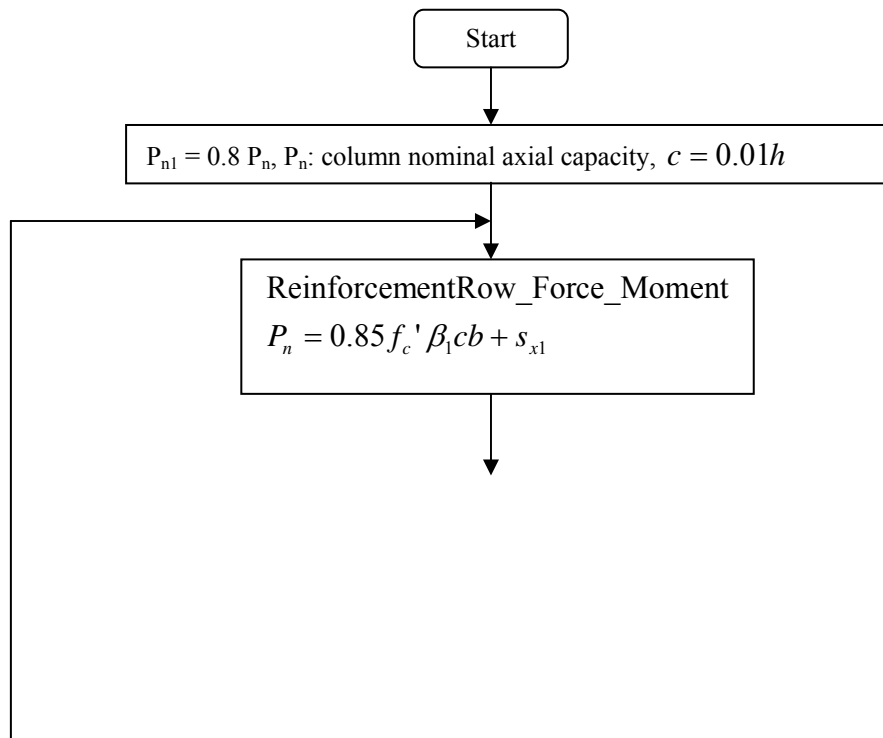

Figure 2.48 Flowchart to calculate bending moment capacity at axial force equals 0.8 the maximum axial capacity, subroutine Column_Moment_EightyPercent

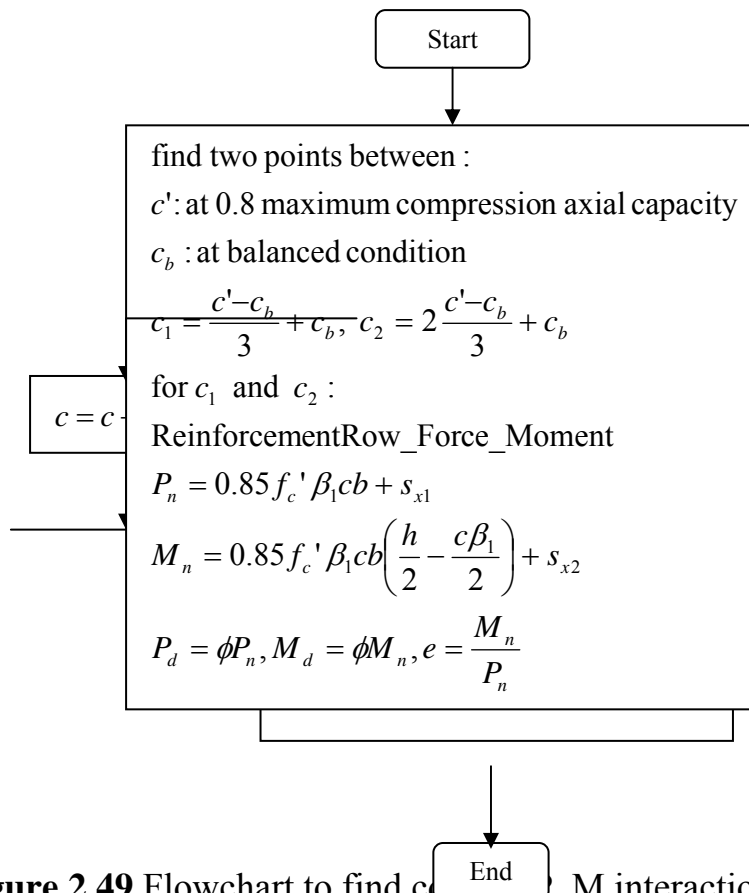

Figure 2.49 Flowchart to find c - M interaction points (2 points) at axial loads between 0.8 the compression maximum axial capacity and the balanced axial capacity, subroutine InteractionPoints_BalEightyPercent

Figure 2.50 Flowchart to calculate the biaxial factor, subroutine Column_Biaxial_Factor

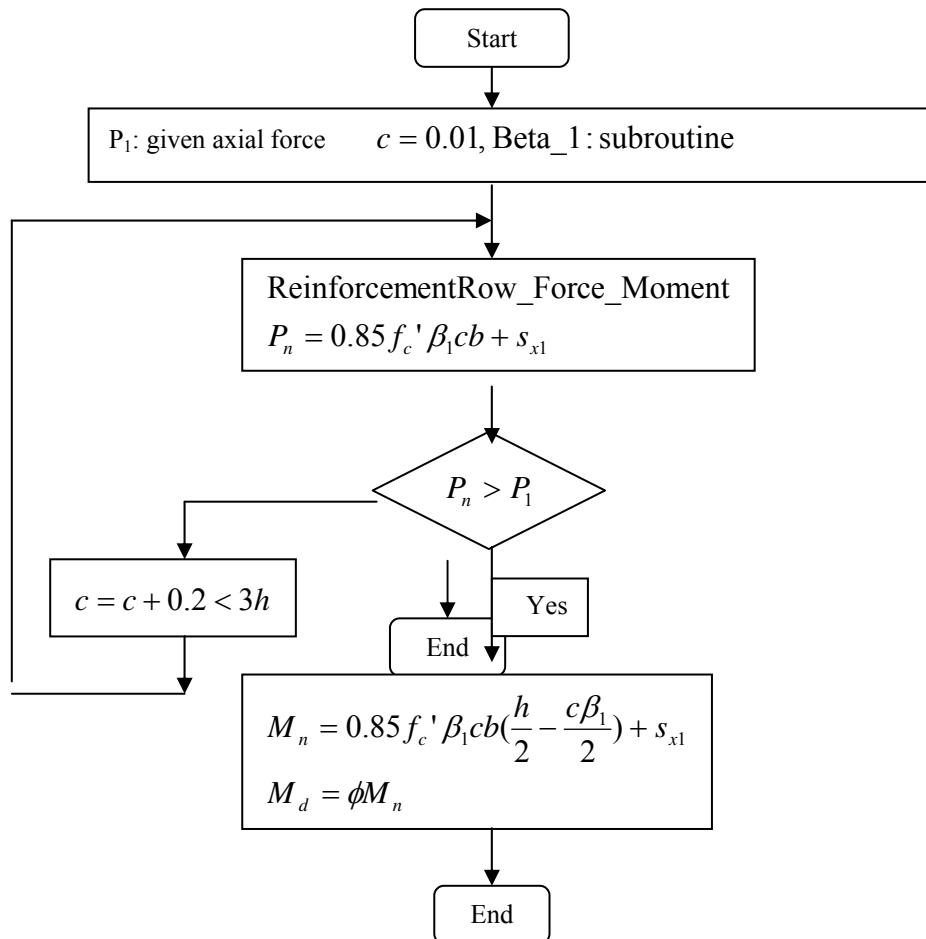
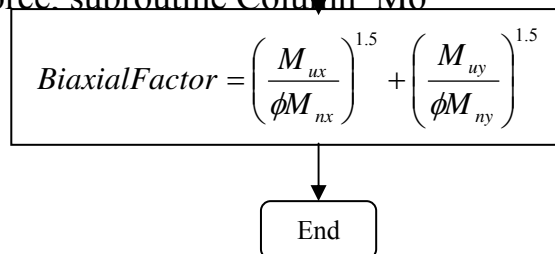

Figure 2.51 Flowchart to calculate bending moment capacity at a given axial force. subroutine Column Mo



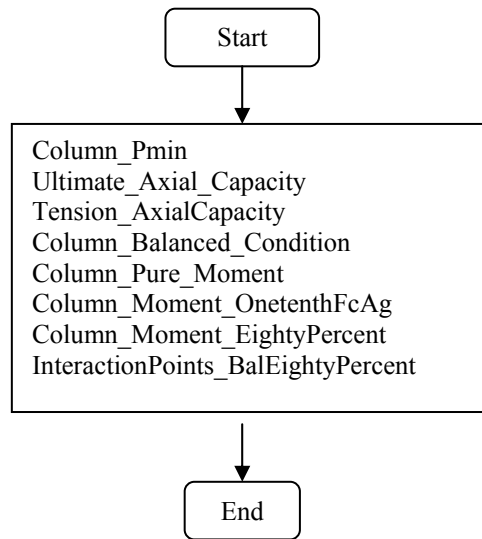

Figure 2.52 Flowchart for construction of axial force_bending moment interaction diagram, subroutine Column_PM_Diagram

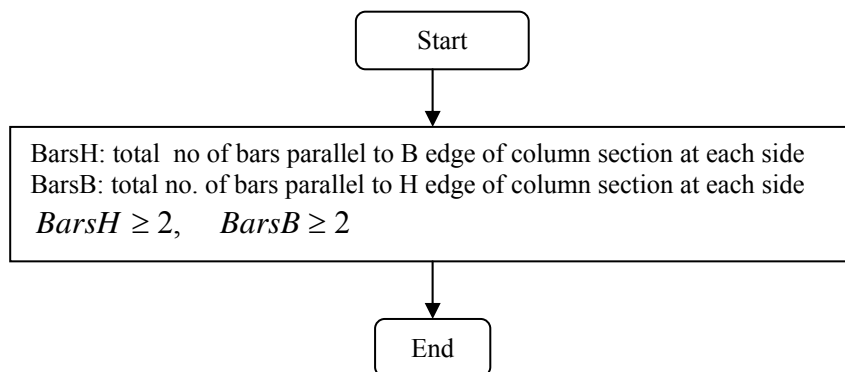

Figure 2.53 Flowchart to determine minimum bars in column section, subroutine Column_MinBars

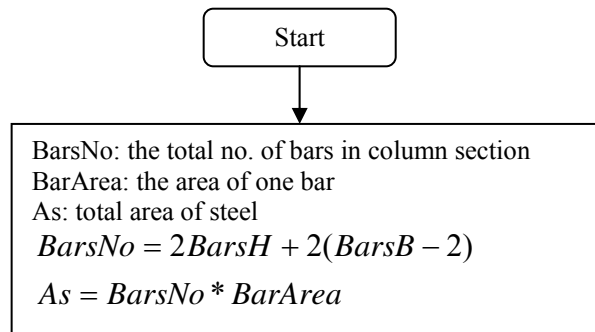

Figure 2.54 Flowchart to calculate total no. of bars and total steel area for given bars arrangement, subroutine Column_BarsNo_AstTotal

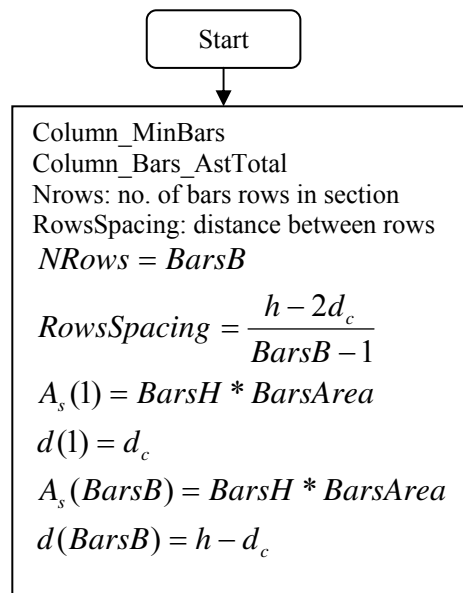

Figure 2.55 Flowchart to find A_s and d for reinforcement rows, subroutine Column_Reinforcement_Area_Depth

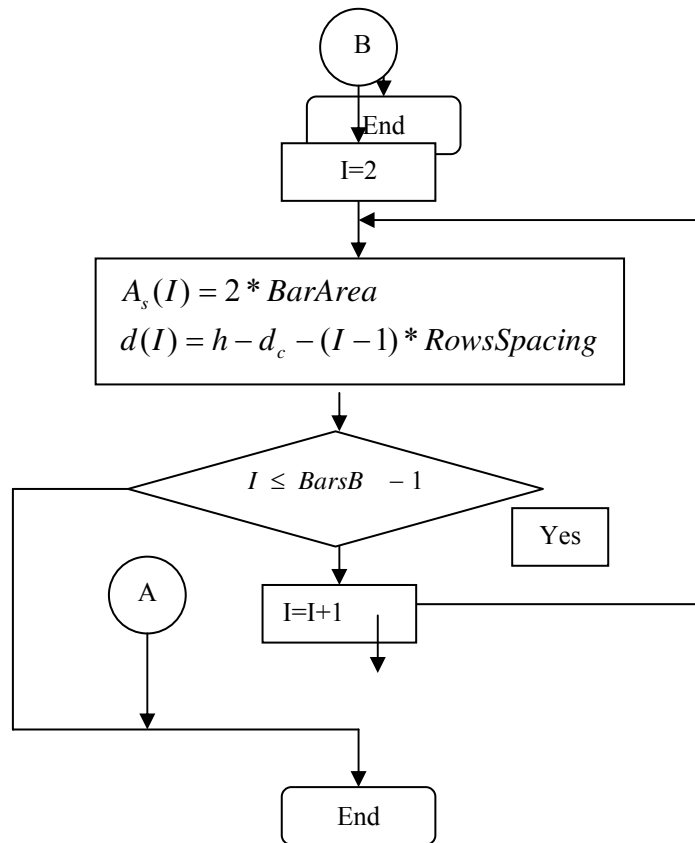

Figure 2.55 continued

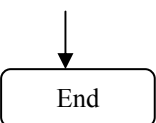
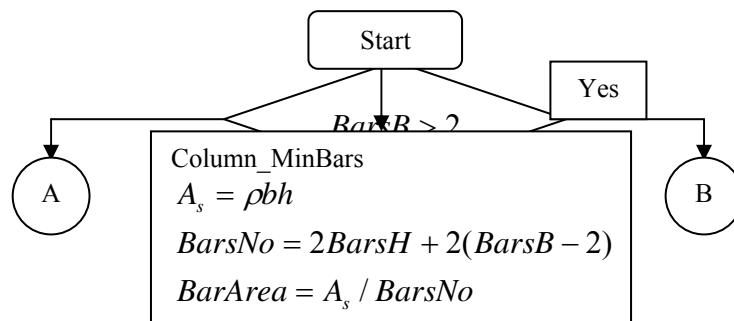

Figure 2.56 Flowchart to calculate the no. of bars and bar area for given bars arrangement for a steel ratio, subroutine Column_Design_Given_BarsArrangement

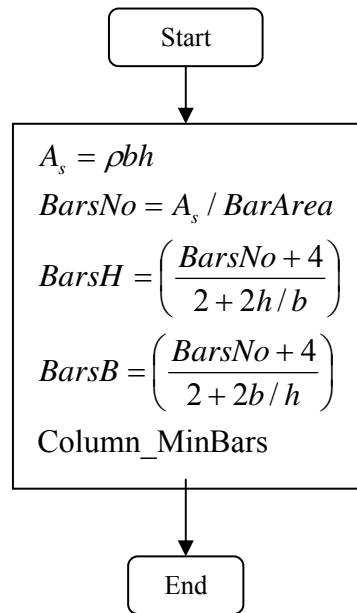

Figure 2.57 Flowchart to calculate BarsH and BarsB from given bar diameter for a steel ratio, subroutine Column_Design_Given_BarDiam

2.5 Analysis and Design of Single Footing

The program has the ability of analysis and design of single footing. In analysis the user specifies the footing dimensions and reinforcement and the program gives the footing design axial load. In design, the user specifies the ultimate load and the program gives the footing dimensions and reinforcement.

2.5.1 Single Footing Analysis:

The major steps of footing analysis are:

1. Compute the resisting force by the soil bearing capacity.
2. Compute the resisting force by reinforced concrete flexural strength.
3. Compute the resisting force by reinforced concrete shear strength.
4. Compute the resisting force by concrete punching shear strength.

The design force will be the smallest of the all-resisting forces.

2.5.1.1 Computing Soil Resisting Force:

The force resisted by soil, $P_{u(soil)}$ is found by multiplying the area of footing by the ultimate soil capacity as follows:

$$P_{u(soil)} = A_{footing} Q_{a(soil)} F \quad (2.82)$$

where:

$A_{footing}$ = area of footing, m^2

$Q_{a(soil)}$ = allowable soil capacity, t/m^2

F = ultimate load factor, usually between 1.5 and 1.6

2.5.1.2 Computing Flexural Resisting Force:

From the given section dimensions and reinforcement, the bending moment capacity, M_d is computed using the same principles of beam section analysis. The design moment, M_d is then made equal the ultimate bending moment, M_u developed by a stress under the footing $Q_{u(\text{flexure})}$. The ultimate force resisted by reinforced concrete, $P_{u(\text{flexure})}$ can be found using the following equations:

$$M_d = M_u = Q_{u(\text{flexure})} a^2 / 2 \quad (2.83a)$$

$$P_{u(\text{flexure})} = Q_{u(\text{flexure})} A_{\text{footing}} \quad (2.83b)$$

Where a is the larger clear distance between the face of column and the edge of footing.

2.5.1.3 Computing Wide Beam Shear Resisting Force:

From the given section dimensions, the section shear capacity, V_d is found using the same principles in beam section shear analysis. Then, V_d is made equal the ultimate shear force, V_u developed by the soil stress $Q_{u(\text{shear})}$. The shear resisting force, $P_{u(\text{shear})}$ is computed as follows:

$$V_d = V_u = Q_{u(\text{shear})} (a - d) \quad (2.84a)$$

$$P_{u(\text{shear})} = Q_{u(\text{shear})} A_{\text{footing}} \quad (2.84b)$$

Where d is the effective depth of footing section.

2.5.1.4 Computing Punching Shear Resisting Force:

The resisting punching shear strength, $P_{u(\text{punching})}$ is computed by multiplying the critical shear area by the concrete stress capacity, V_{cp} which is given by:

$$\phi V_{cp} \leq \phi 1.06 \sqrt{f_c'} \quad (2.85a)$$

$$\phi V_{cp} \leq \phi 0.53 \left(1 + \frac{2}{\beta_c}\right) \sqrt{f_c'} \quad (2.85b)$$

$$\phi V_{cp} \leq \phi 0.53 \left(\frac{\alpha_s d}{4(b+h+2d)} + 1 \right) \sqrt{f_c'} \quad (2.85c)$$

$$P_{d(\text{punching})} = \phi V_{cp} A_{cr} \quad (2.85d)$$

$$A_{cr} = \{2(b+d) + 2(h+d)\}d \quad (2.85e)$$

$$P_{u(\text{punching})} = P_{d(\text{punching})} + Q_{a(\text{soil})} F(b+d)(h+d) \quad (2.85f)$$

Where:

Φ = shear strength reduction factor, the default value is 0.85

β_c = the ratio of long side to short side of column

α_s = value depends on column location. It equals 40 for interior columns, 30 for edge columns and 20 for corner columns.

b, h = column dimensions

Equations 2.85a and 2.85b are used in punching shear calculations in the program.

2.5.2 Single Footing Design:

The major steps in design of footing are:

1. Compute footing area
2. Compute footing depth from wide beam shear and punching shear
3. Compute flexural reinforcement in each direction of footing

2.5.2.1 Computing Footing Area:

The footing area is computed using the following equation:

$$A = \frac{P_u}{Q_a F} \quad (2.86)$$

The dimensions of the base of the footing L and B are computed depending on the column dimensions; the clear distance between the face of column and the edge of the footing is equal in both directions. The footing effective depth is computed using the minimum value calculated in the following two sections.

2.5.2.2 Computing Footing Depth from Wide Beam Shear:

The ultimate stress under the footing is computed using the following equation:

$$Q_u = \frac{P_u}{LB} \quad (2.87)$$

The ultimate shear force is

$$V_u = Q_u(a - d) \quad (2.88)$$

Where a is the clear distance between the face of column and the edge of the footing.

The section shear strength is

$$V_d = \phi V_c = 0.85(0.53)\sqrt{f'_c}'100d \quad (2.89)$$

From Equations 2.88 and 2.89, the footing effective depth is computed considering V_u in equation 2.88 equals V_d in equation 2.89.

2.5.2.3 Computing Footing Depth from Punching Shear:

The concrete punching strength, V_{cp} is found using Equations 2.85. The footing effective depth, d is found by making the applied ultimate load, P_u is to be equal to $P_{u(\text{punching})}$ in Equation 2.85f.

2.5.2.4 Computing Flexural Reinforcement:

As the clear distance from column face to footing edge, a is equal in both footing directions, the bending moments and the areas of steel will be the same in both directions. The bending moment at column face will be

$$M_u = Q_u a^2 / 2 \quad (2.90)$$

Then the area of steel is computed. The area of steel should be larger than the minimum value required for temperature and shrinkage: $A_s = 0.0018bh$ for sections reinforced with grade 4200kg/cm² and 0.002bh with grade less than 4200kg/cm². b is the footing width and h is the footing thickness. Also, the computed area of steel should not exceed the maximum value for single reinforcement.

After computing the areas of steel, the size and spacing of bars are determined in the long and short directions:

- a. The steel is uniformly distributed across the width of footing in the long direction.
- b. The portion A_{s1} of the total steel area A_s determined for short direction is to be uniformly distributed over the central band:

$$A_{s1} = \frac{2}{\beta + 1} A_s \quad (2.91)$$

Where β is the ratio of long side to short side of the footing. The remainder of the reinforcement ($A_s - A_{s1}$) is to be uniformly distributed outside the central band of the footing. The central band width is equal to the footing short side dimension.

The previous discussion of analysis and design of footing is illustrated in the flowcharts in Figures 2.58 to 2.74. The flowcharts are transformed to the subroutines Footing_PuBearingCapacity, Footing_PuWide, Shear_Capacity_WithoutAxial_Vc, Footing_PuPunching, Footing_Punching_BetaC, Footing_Punching_Area, Footing_MinSteel, Footing_PuBending, Footing_Qu, Footing_Mu, Footing_Vu, Footing_Design_Area, Footing_WideShear_Df, Footing_Punching_Df, Footing_Punet and Footing_Rectangle_reinforcement_ShortDirection.

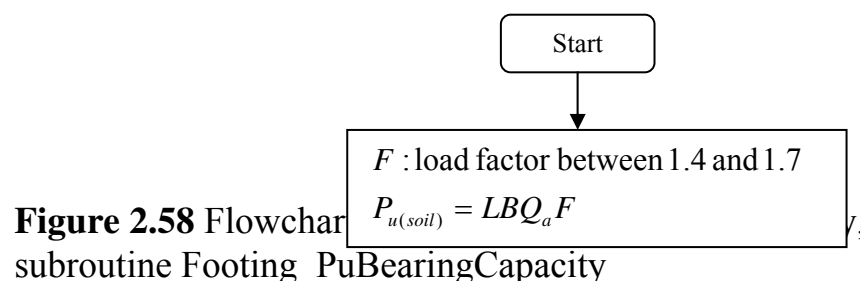

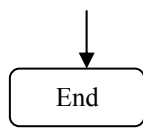

Figure 2.59 Flowchart to calculate wide beam shear capacity, subroutine Footing_PuWide

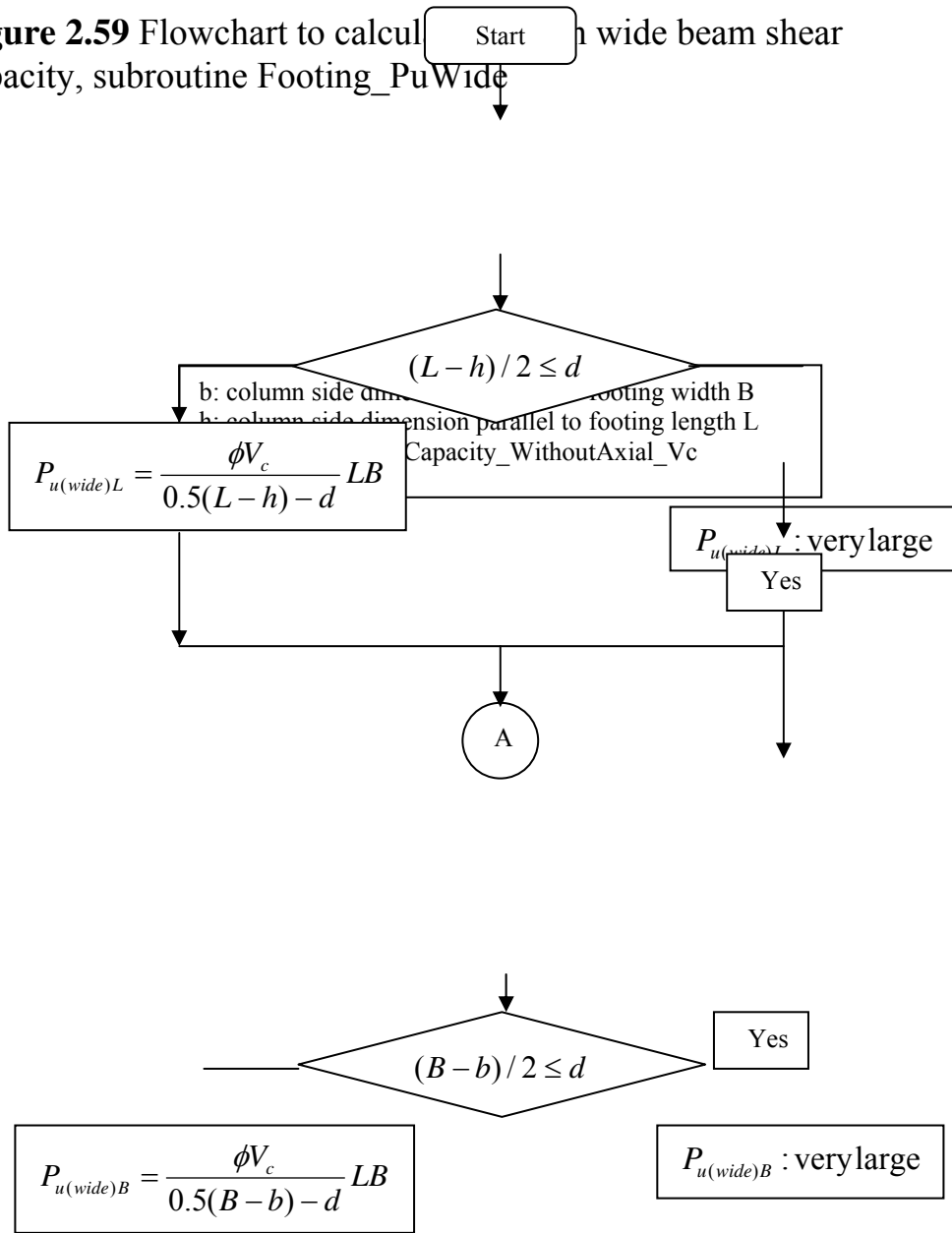

Figure 2.59 continued

A

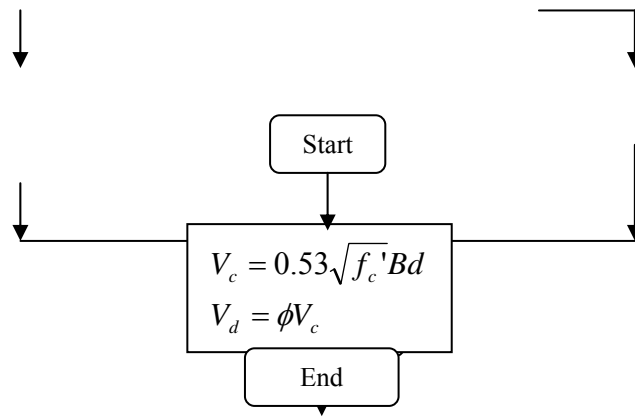

Figure 2.60 Flowchart to calculate shear capacity, subroutine Shear_Capacity_WithoutAxial_Vc

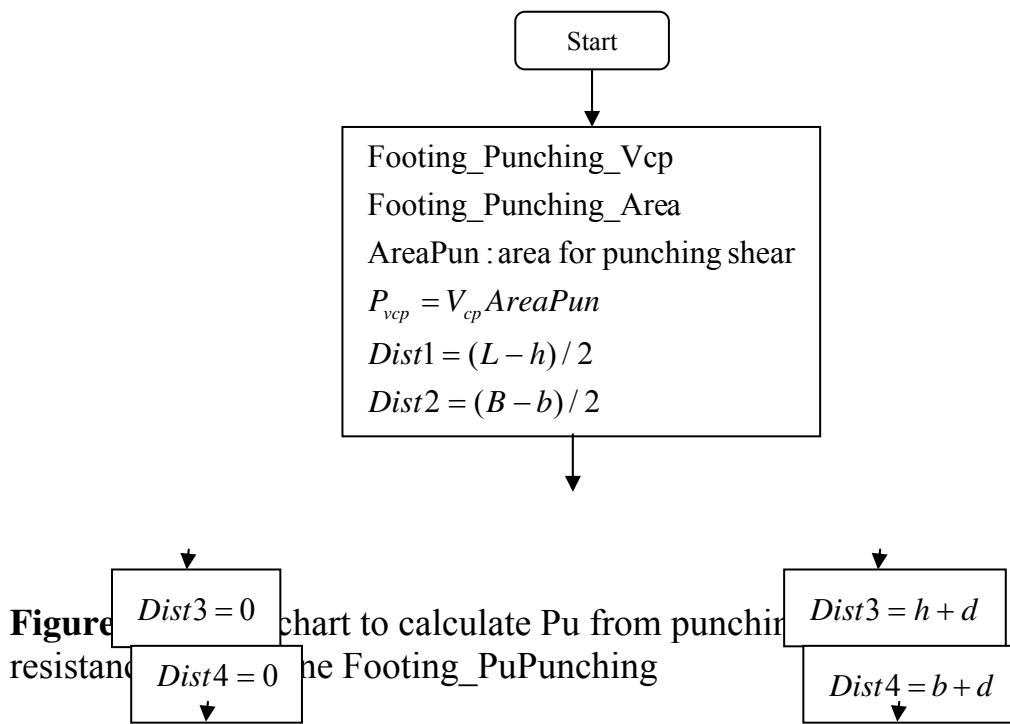

Figure chart to calculate Pu from punching resistance of the Footing_PuPunching

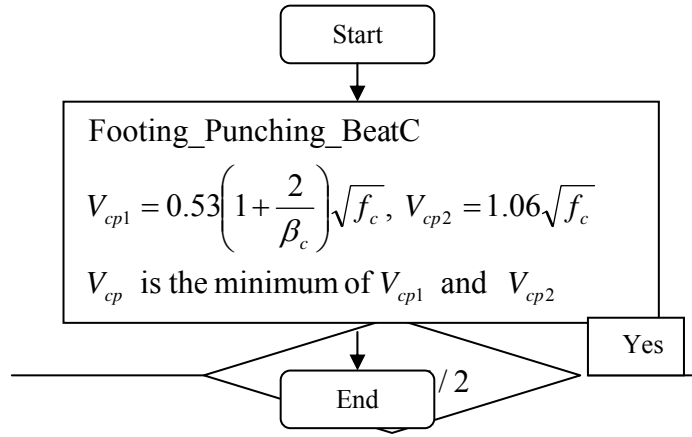
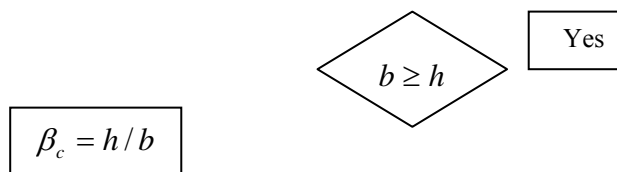
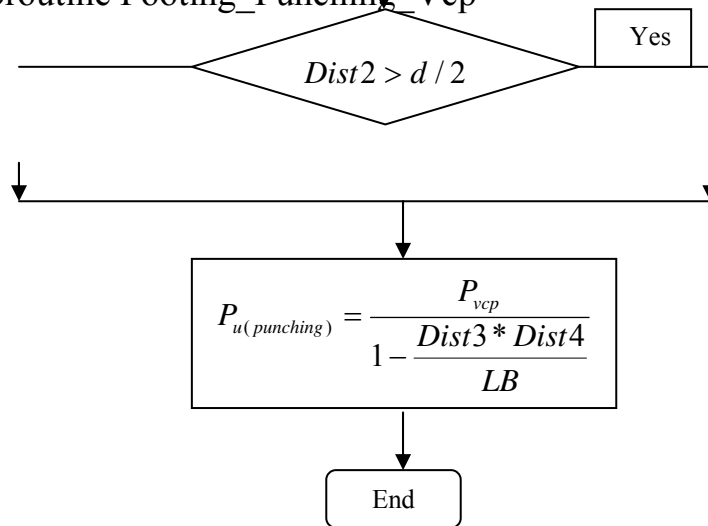

Figure 2.62 Flowchart to calculate the allowable punching stresses, subroutine Footing_Punching_Vcp



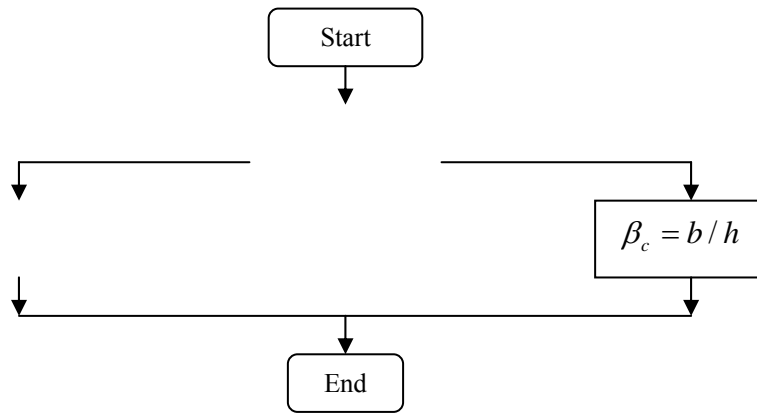

Figure 2.63 Flowchart to calculate β_c : the ratio of longer to shorter dimensions of column, subroutine Footing_Punching_BetaC

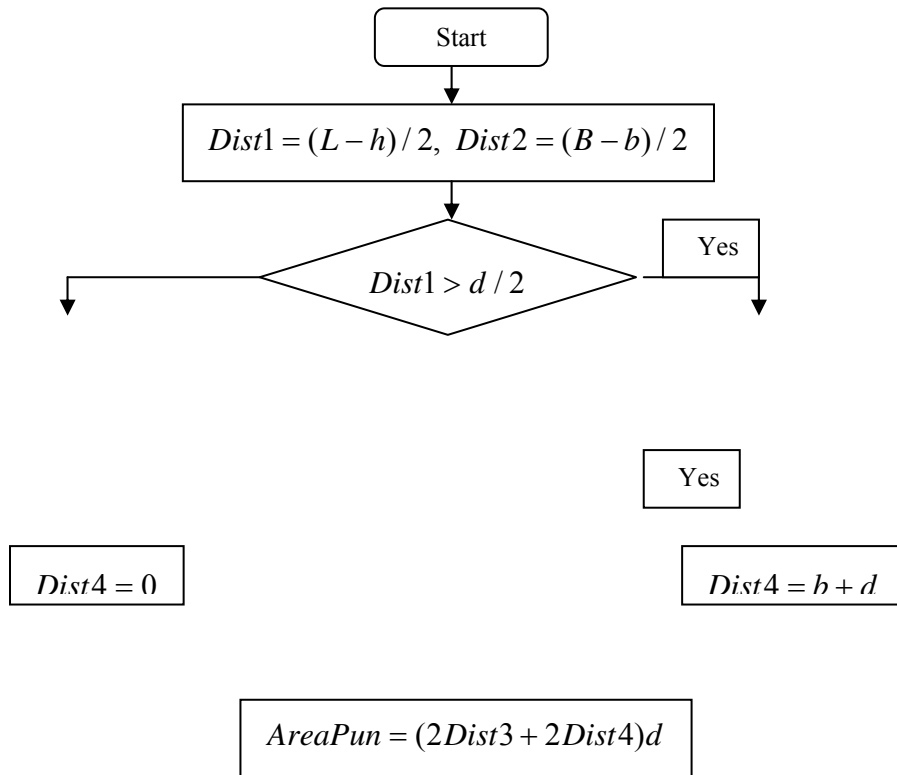

Figure 2.64 Flowchart to calculate $AreaPun$ for punching shear computations, subroutine Footing_Punching_Area

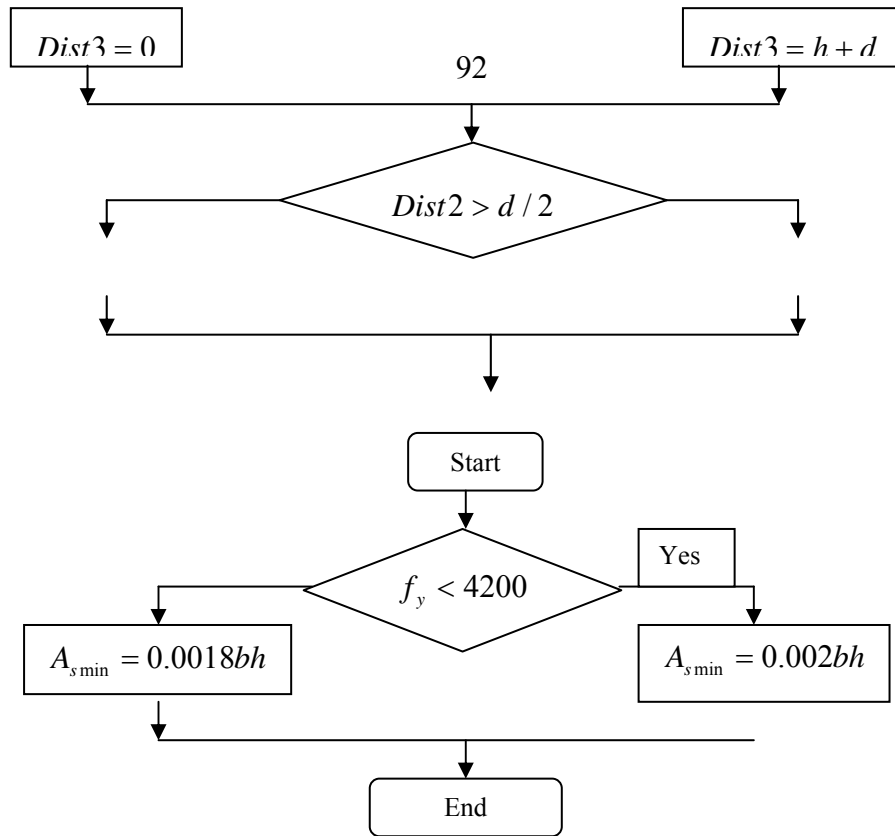
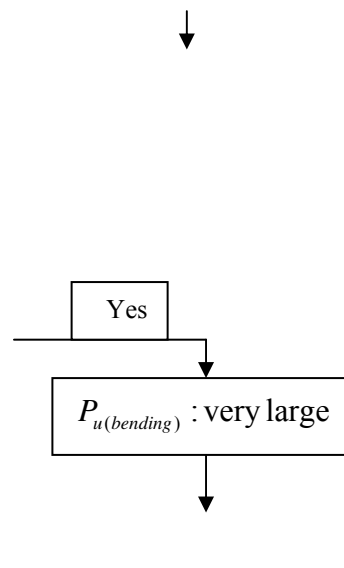

Figure 2.65 Flowchart to calculate minimum steel area in footing section, subroutine Footing_MinSteel



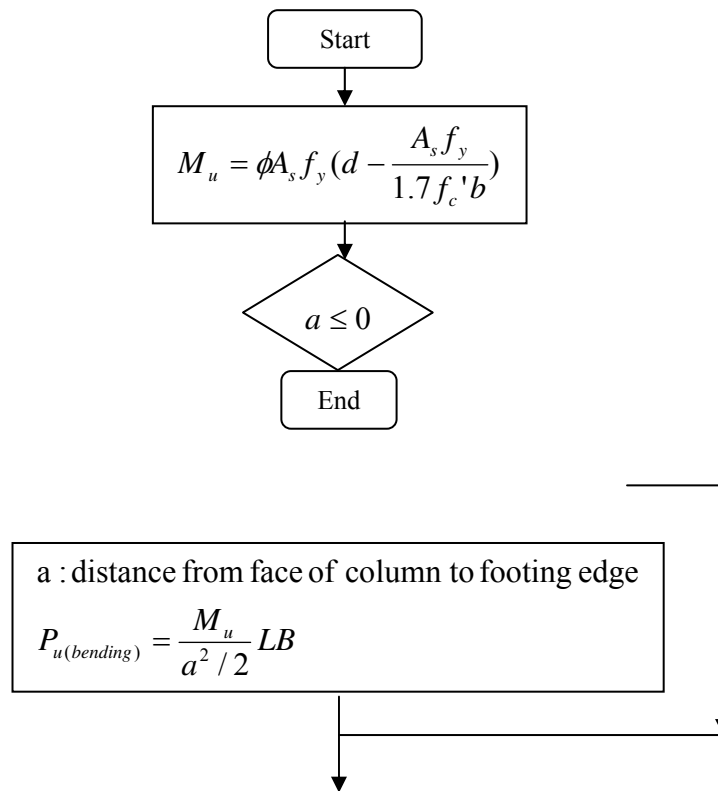

Figure 2.66 Flowchart to calculate Pu from flexure reinforcement capacity, subroutine Footing_PuBending

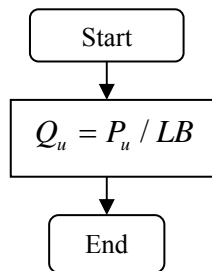

Figure 2.67 Flowchart to calculate soil stress, Qu, subroutine Footing_Qu

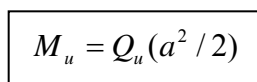

Figure 2.68 Flowchart to calculate the bending moment, Mu at face of column due to Qu, subroutine Footing_Mu

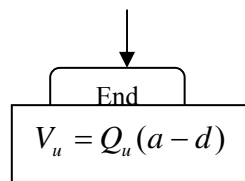
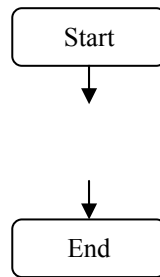

Figure 2.69 Flowchart to calculate the shear force, V_u at face of column, subroutine Footing_Vu

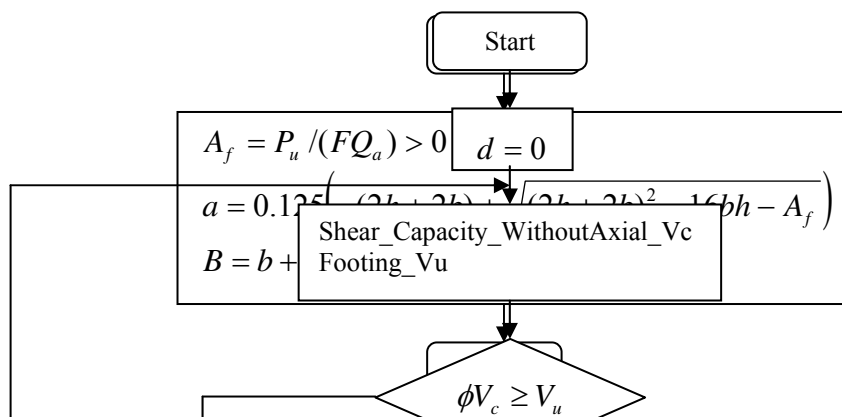
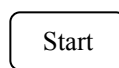

Figure 2.70 Flowchart to compute remaining dimensions, subroutine Footing_Vu

Figure 2.71 Flowchart to calculate footing effective depth from wide beam shear, subroutine Footing_WideShear_Df



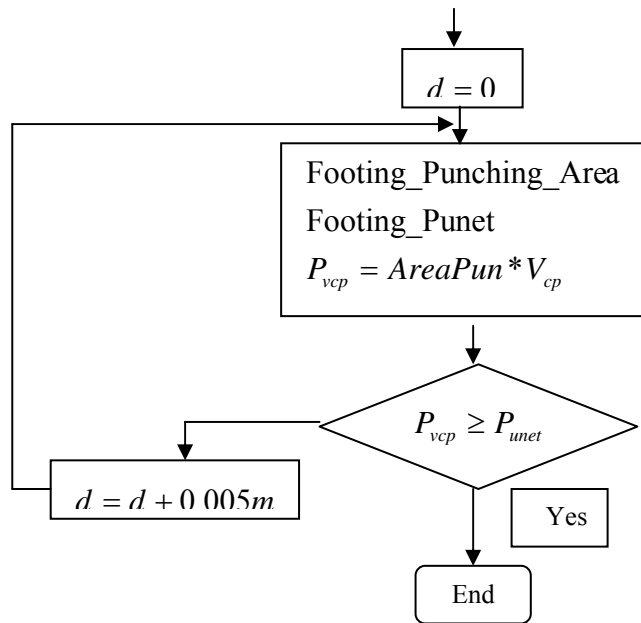
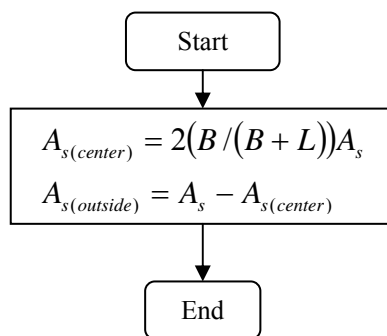
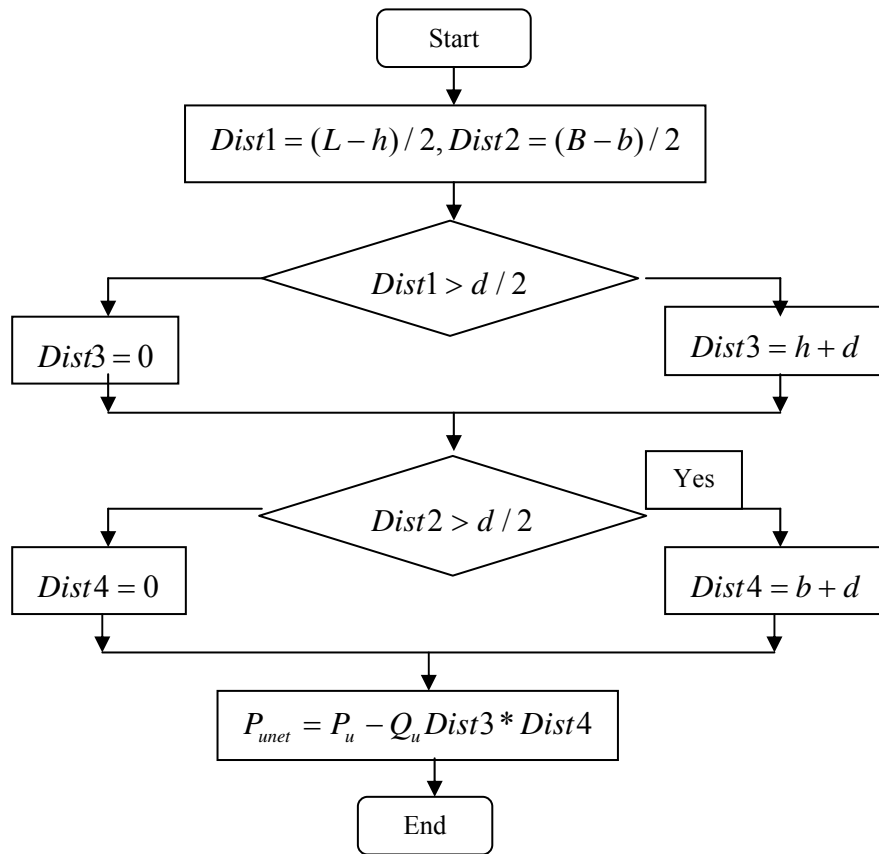

Figure 2.72 Flowchart to calculate footing effective depth from punching shear, subroutine Footing_Punching_Df

Yes

Figure 2.73 Flowchart to calculate the net axial load on
Figure 2.74 Flowchart to calculate areas of steel in short direction of
 the footing, subroutine Footing_Rectangle_reinforcement_ShortDirection



Chapter Three

The program Composition

3.1 General

The program is composed of the main screen or form that has the main menu. Each menu contains submenus. Each submenu displays a dialog box that contains input and or output data. Also, a tool bar that contains buttons to run the most important submenus supports the main screen.

In this chapter, the subroutines that are executed by the submenus will be introduced by flowcharts. These flowcharts use the basic subroutines discussed in chapter two for the analysis and design of the reinforced concrete section. All the variables in the flowcharts will be defined. Also, the shape of the input dialog box will be shown and its input variables are to be defined.

3.2 Language and Units:

The program deals with the Arabic and English languages and the metric (ton, meter) and the SI (kilonewton, meter) units. As the program starts, a dialog box will ask the user for the language and units. The dialog box is shown in Figure 3.1 (**form name: First, file: First.frm**). The variables that are read by this dialog are:

Language_ID: identifier for the language. It takes Arabic or English values

Units_ID: identifier for the units. It takes Ton_Meter or Kilonewton_Meter values.

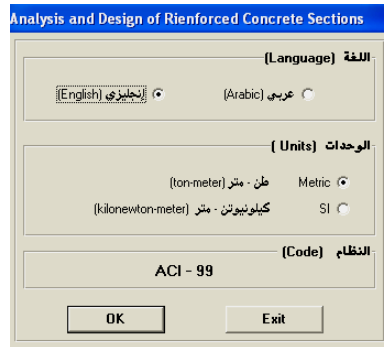

Figure 3.1 Language and units dialog box.

3.3 The Program Main Menu:

The program is composed of ten menus as shown in Figure 3.2a in English and in Figure 3.2b in Arabic (**form name: MainForm, file: MDIForm.frm**). Each menu contains submenus. Table 3.1 shows the names of the menus and submenus. Each menu will be detailed in the following sections.

Table 3.1 the program menus

Main Menu	Submenus
File	New Project, Open, Save, Print Setup, Exit
Edit	Add, Insert, Modify, Delete, Delete All
Define	Materials, Sections, Design Load Combinations
Select	Select All, Clear Selection
Assign	Sections, Reinforcement, Forces, Reinforcement Design Options
Analyze	Start Analysis/ Show Results
Design	Start Design/ Show Results, Redefine Element Design Data
Display	Show Sections, Show Input Section Forces
Options	Preferences
Help	

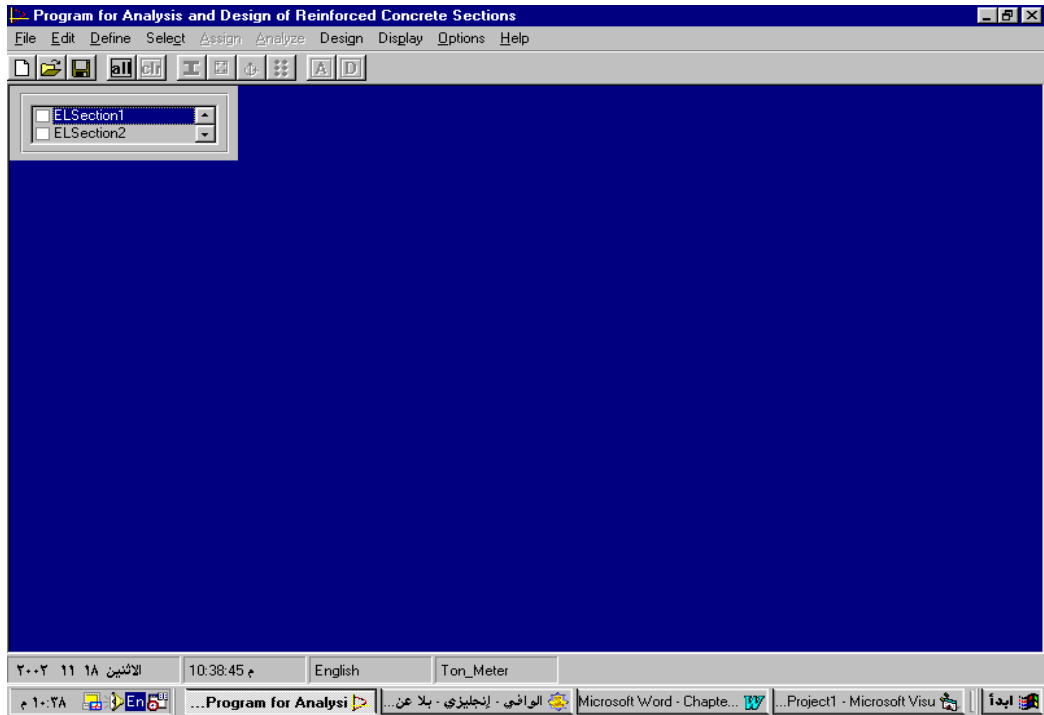

Figure 3.2a Program screen (English)

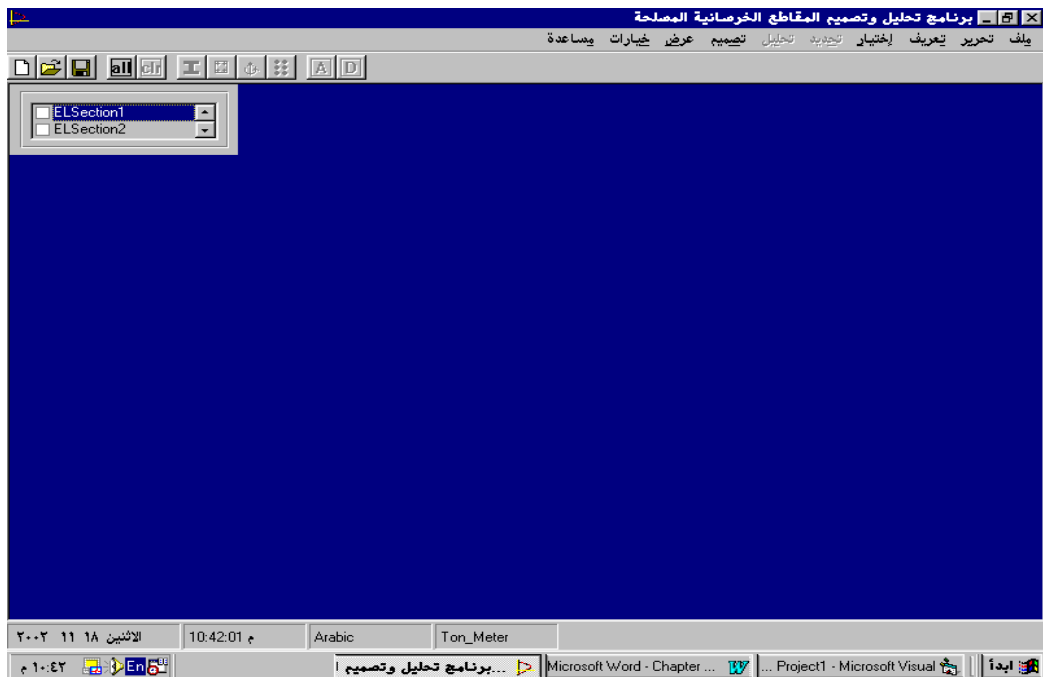

Figure 3.2b Program screen(Arabic)

3.4 The File Menu:

This menu deals with the file operations as shown in table 3.1

3.4.1 The New Project Submenu:

This submenu is used to enter the name of the project, the run mode and the number of sections to be run. The New Project dialog box is shown in Figure 3.3 (**form name: NewProject, file:NewProject.frm**).

Figure 3.3 New Project dialog box

The variables that are read by this dialog are:

ProjectName: the project name

Run_ID: the analysis or design options. It takes Analysis or Design values

Elements_Count: the number of sections to be analyzed or designed. It is limited to 50.

Clicking on the OK button will display the list of elements (**form name: ElementSections, file: ElementSections.frm**), see Figure 3.2.

3.5 The Edit Menu

This menu is used to modify the element names or arrangements in the element list. The element names can be added, inserted, deleted or changed. The Add submenu displays the Add dialog box (**form name: AddElement, file: AddElem.frm**), the Insert submenu displays the Insert dialog box

(**form name: InsertElement, file: InElem.frm**) and the Modify submenu displays the Modify dialog box (**form name: ModifyElements, file: ChElem.frm**).

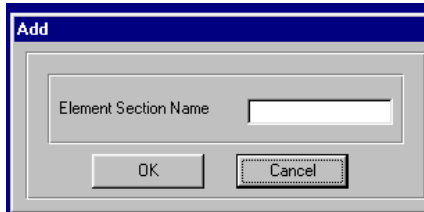

Figure 3.4 Add dialog box

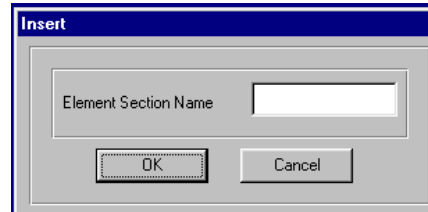

Figure 3.5 Insert dialog box

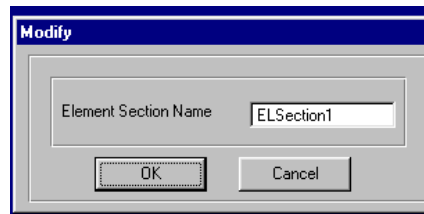

Figure 3.6 Modify dialog box

3.6 The Define Menu:

This menu is used to enter the materials properties, sections and load combinations.

3.6.1 The Materials Submenu:

This submenu is used to enter the materials names and properties. Figure 3.7 shows the Define Materials dialog (**form name: DefineMaterials, file: DefineMaterials.frm**). The properties of each material is entered using the Material Property Data dialog box as shown in Figure 3.8 (**form name: ShowMaterial, file: ShowMaterial.frm**).

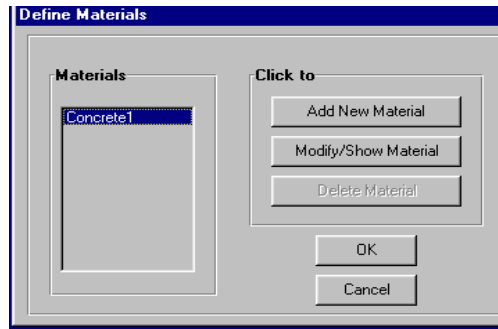

Figure 3.7 Define Materials dialog box

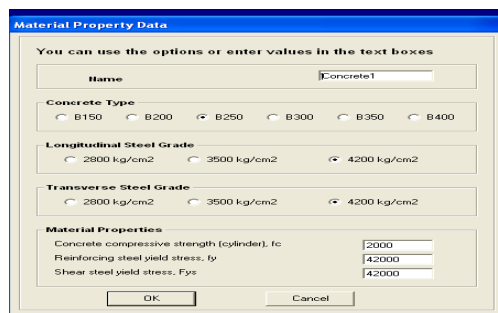

Figure 3.8 Material Property Data dialog box

The variables that are read by these dialogs are:

Material_Name(): material name

Material_Fc(): the compressive strength of concrete

Material_Fy(): the yield strength of the flexural reinforcing steel

Material_Fys(): the yield strength of the shear reinforcing steel

Material_ID(): identifier for the material name (number)

3.6.2 The Sections Submenu:

This submenu is used to define the sections names and properties. It will display the Define Sections dialog as shown in Figure 3.9 (**form name: DefineFrameSections, file: DefineSections.frm**). The section material, name and dimensions are entered using the Show Section dialog as shown in Figure 3.10 (**form name: ShowFrameSections, file: ShowSection.frm**). Also, this submenu specifies the section as beam or

column. The beam section properties are entered using the Beam Data dialog as shown in Figure 3.11, while the column properties are entered using the Column Data dialog as shown in Figure 3.12 (**form name: ColumnData, file: ColumnDta.frm**). The footing properties are defined using the Define Footing dialog as shown in Figure 3.13 (**form name: DefineFooting, file:DefineFooting.frm**).

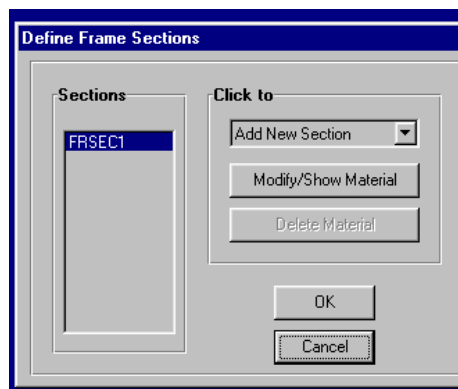

Figure 3.9 Define Sections dialog

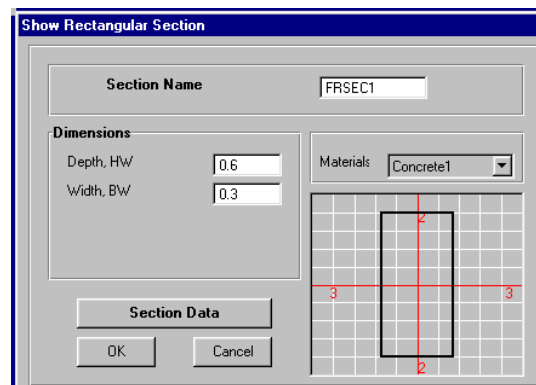

Figure 3.10 Show Section dialog

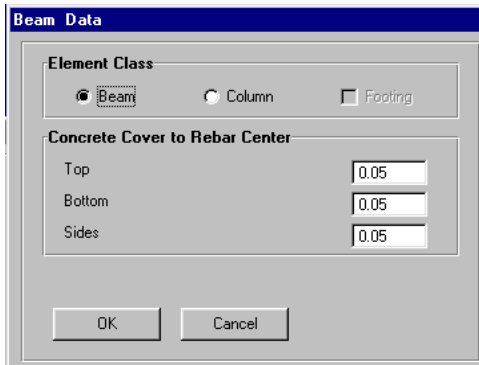

Figure 3.11 Beam Data dialog

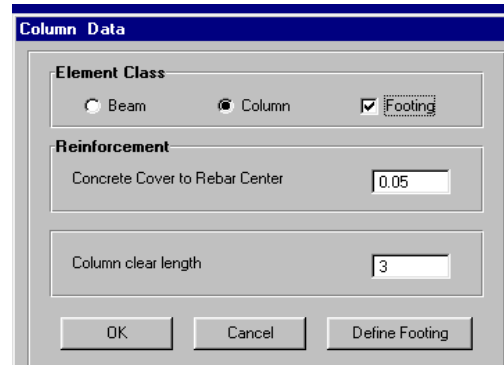

Figure 3.12 Column Data dialog

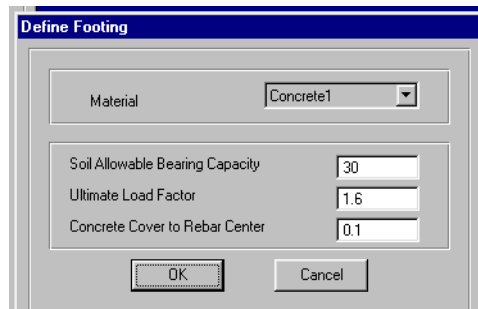

Figure 3.13 Define Footing dialog

The variables that are read by these dialogs are defined as follows:

Sections_Name(): the name of the section

Sections_ID(): identifier for the section

Sections_Material(): the name of the material to the specified section

Sections_MaterialID(): identifier for the section material

Sections_Type(): the type of the section beam or column

Sections_Shape(): the shape of the section rectangle, T_Section or L_Section

Sections_Footing_ID(): identifier to the column section that has a footing to analyze or design or not

Sections_H(): the height of the section; the major dimension

Sections_B(): the width of the section; the minor dimension

Sections_BF(): the width of the flange in flanged section

Sections_HF(): the thickness of the flange in flanged section

Beam section:

Sections_Beam_Tcover(): the beam section reinforcement top cover to center of bars

Sections_Beam_Bcover(): the beam section reinforcement bottom cover to center of bars

Sections_Beam_Scover(): the beam section reinforcement sides cover to center of bars

Column section:

Sections_Column_Cover(): the column section reinforcement cover to center of bars

Sections_Column_Length(): the column length (height)

Footing:

Sections_Footing_Material(): the material for footing

Sections_Footing_MaterialID(): identifier for the footing material (number)

Sections_Footing_LoadFactor(): the dead and live loads average load factor

Sections_Footing_Cover(): footing section reinforcement cover to center of bars

Sections_Footing_Soil_Capacity(): the soil allowable bearing capacity

3.6.3 The Design Load Combinations Submenu:

The program introduces eleven load combinations that are specified by the ACI code. This submenu is active only in the design mode. Figure 3.14 shows the Define Load Combinations dialog (**form name: DefineLoadCom, file: AssignLoadComb.frm**). The user can select the appropriate load combinations and can change the load factors. The default load factors are that specified by the ACI code. The load combinations are very important for the section design. The program considers that dead and live loads cause no sidesway and wind, quake and other loads cause sidesway. This system is very important in the column design.

Combination	Factor	Load 1	Load 2	Load 3	Load 4
<input checked="" type="checkbox"/> Comb1	1.4	Dead			
<input checked="" type="checkbox"/> Comb2	1.4	Dead+	1.7	Live	
<input checked="" type="checkbox"/> Comb3	1.05	Dead+	1.275	Live+	1.4025 Quake
<input checked="" type="checkbox"/> Comb4	1.05	Dead+	1.275	Live	-1.4025 Quake
<input checked="" type="checkbox"/> Comb5	0.9	Dead+	1.43	Quake	
<input checked="" type="checkbox"/> Comb6	0.9	Dead-	-1.43	Quake	
<input checked="" type="checkbox"/> Comb7	1.05	Dead+	1.275	Live+	1.275 Wind
<input checked="" type="checkbox"/> Comb8	1.05	Dead+	1.275	Live+	-1.275 Wind
<input checked="" type="checkbox"/> Comb9	0.9	Dead+	1.3	Wind	
<input checked="" type="checkbox"/> Comb10	0.9	Dead+	-1.3	Wind	
<input type="checkbox"/> Comb11	1	Other			

Figure 3.14 Define Load Combinations dialog

The variables that are read by this dialog are defined as follows:

Load_Combinations_Factors(n,m): the load combination factors. The variable n is varied from one to eleven that equals the number of the load combinations. The variable m is varied from one to five that equals the number of loads.

Check1(): identifier that equals 1 if the load combination is selected and it equals 0 if the load combination is not selected.

3.7 The Select Menu:

This menu is used for selection of elements in the element list.

3.8 The Assign Menu:

This menu is used to assign each element in the element list; after selection; to its specified section, reinforcement (analysis), forces (design) and reinforcement design options (design).

3.8.1 The Sections Submenu:

This menu is used to assign a section to element or elements. This submenu displays the Define Frame Section dialog shown in Figure 3.9 (shown previously). The assignment is achieved by selecting the section name and then clicking the OK button. In this stage, the section properties can be modified.

The only variable that is read by this dialog in the assign menu is **Element_SectionID()**, which it is a number that specifies the section name to the element. From this variable all the section and material properties of the element are defined.

3.8.2 The Reinforcement Submenu:

This submenu is used to assign the existing reinforcing steel to the section for analysis. This submenu displays the Assign Reinforcement dialog box. The variables in this dialog depend on the section type (beam or column). Figure 3.15 shows the Assign Beam Reinforcement dialog (**form name: Reinforcement, file: Reinforcement.frm**), Figure 3.16 shows the Assign Column Reinforcement dialog and Figure 3.17 shows the Assign Footing Dimensions and Reinforcement for Analysis dialog (**form name: AssignFootingData, file: AnFooting.frm**).

Assign Beam Reinforcement

Element Class
 Beam Column

Reinforcement Type
 Bars Area

Main Reinforcement

Top Steel :
 No. of Bars
 Bar Diameter (mm)

Bottom Steel :
 No. of Bars
 Bar Diameter (mm)

Middle Steel :
 No. of Bars
 Bar Diameter (mm)

Shear Reinforcement
 No. of Bars
 Bar Diameter (mm)
 Bars Spacing

Figure 3.15 Assign Beam Reinforcement dialog

Assign Column Reinforcement

Element Class
 Beam Column

Reinforcement Type
 Bars Area

Main Reinforcement

No. of Rebars in Direction 3-3
 No. of Rebars in direction 2-2
 Bar Diameter (mm)

Shear Reinforcement
 No. of Bars
 Bar Diameter (mm)
 Bars Spacing

Figure 3.16 Assign Column Reinforcement dialog

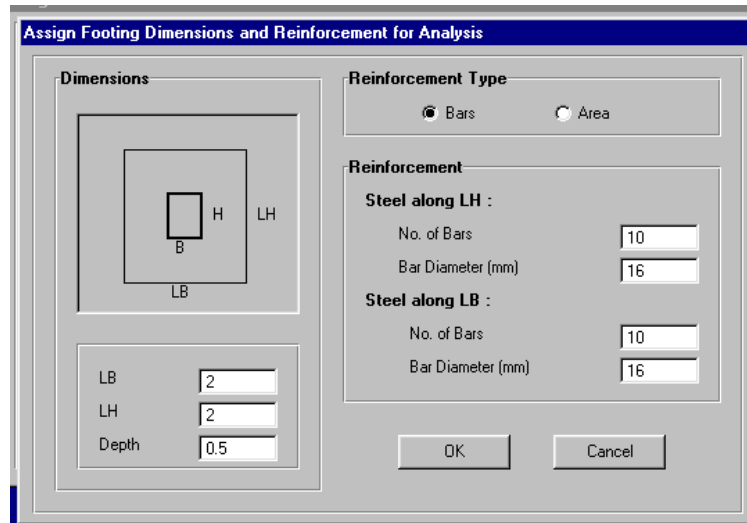

Figure 3.17 Assign Footing Dimensions and Reinforcement for Analysis dialog

The variables that are read by these subroutines are defined as follows:

Beam section:

Element_Reinforcement_Type(): option for reinforcement type, bars or area

Element_NoTBars(): number of top bars

Element_Tdiam(): diameter of top bars in mm

Element_NoBBars(): number of bottom bars

Element_BDiam(): diameter of bottom bars

Element_AnStirrups_No(): number of stirrups in the section

Element_AnStirrups_Diam(): stirrups diameter

Element_AnStirrups_Spacing(): stirrups spacing

Element_AnStirrups_Avs(): shear reinforcement A_v/s

Element_TArea(): area of top steel (cm^2)

Element_Barea(): area of bottom steel (cm^2)

Column section:

Element_AnColBars22(): number of bars at each side of column section parallel to its height, h

Element_AnColBars33(): number of bars at each side of column section parallel to its width, b

Element_AnColBarDiam(): column bar diameter

Element_AnColBarArea(): column bar area

The stirrups variables are as for beam section and so the type of reinforcement variable.

Footings:

Element_Footing_AnBT(): side length of footing parallel to width of column, b

Element_Footing_AnHT(): side length of footing parallel to length of column, h

Element_Footing_AnDepth(): total depth of footing

Element_Reinforcement_Type(): option for reinforcement type, bars or area

Element_Footing_NoBarsHT(): number of reinforcement bars in direction h

Element_Footing_BarsHTDiam(): diameter of bars in direction h

Element_Footing_NoBarsBT(): number of reinforcement bars in direction b

Element_Footing_BarsBTDiam(): diameter of bars in direction b

Element_Footing_AstHT(): area of steel in direction h

Element_Footing_AstBT(): area of steel in direction b

3.8.3 The Forces Submenu

This submenu is used to assign the design forces to the element section. This submenu displays the Assign Beam Forces dialog for a beam section type as shown in Figure 3.18, and displays the Assign Column Forces dialog for a column section as shown in Figure 3.19 (**form name: AssignDesignForces, file: AssignColumnForces.frm**).

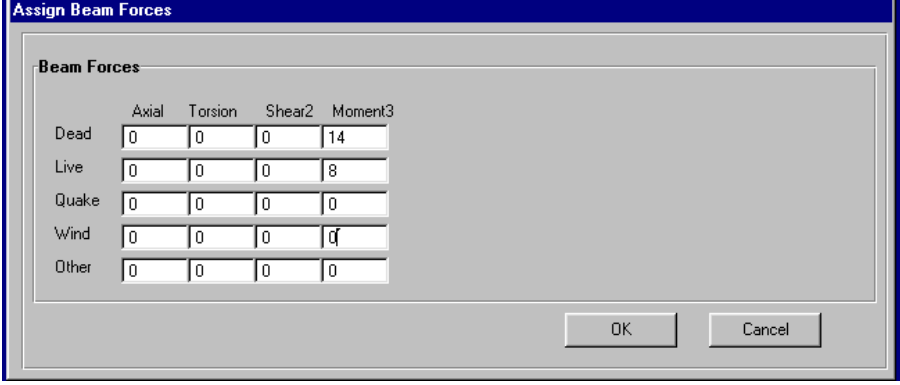

The 'Assign Beam Forces' dialog box contains a table for defining forces for different load types. The table has four columns: Axial, Torsion, Shear2, and Moment3. The rows represent different load types: Dead, Live, Quake, Wind, and Other.

	Axial	Torsion	Shear2	Moment3
Dead	0	0	0	14
Live	0	0	0	8
Quake	0	0	0	0
Wind	0	0	0	0
Other	0	0	0	0

Buttons: OK, Cancel

Figure 3.18 Assign Beam Forces dialog

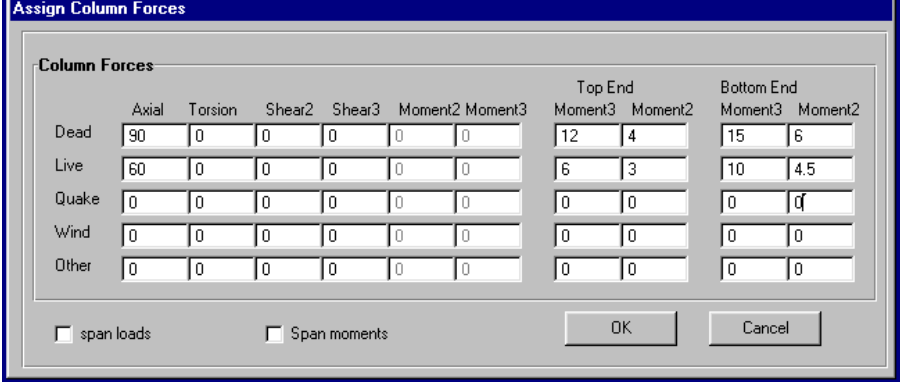

The 'Assign Column Forces' dialog box contains a table for defining forces for different load types. The table has seven columns: Axial, Torsion, Shear2, Shear3, Moment2, Moment3, and two columns for Top End (Moment3, Moment2) and Bottom End (Moment3, Moment2). The rows represent different load types: Dead, Live, Quake, Wind, and Other. There are also checkboxes for 'span loads' and 'Span moments'.

	Axial	Torsion	Shear2	Shear3	Moment2	Moment3	Top End Moment3	Top End Moment2	Bottom End Moment3	Bottom End Moment2
Dead	90	0	0	0	0	0	12	4	15	6
Live	60	0	0	0	0	0	6	3	10	4.5
Quake	0	0	0	0	0	0	0	0	0	0
Wind	0	0	0	0	0	0	0	0	0	0
Other	0	0	0	0	0	0	0	0	0	0

checkboxes: span loads, Span moments

Buttons: OK, Cancel

Figure 3.19 Assign Column Forces dialog

The variables that are read from these dialogs are:

Beam section:

Element_Beam_F11(n,m): the axial forces

Element_Beam_T11(n,m): the torsional moments

Element_Beam_V22(n,m): the shear forces in the major direction; parallel to h

Element_Beam_M33(n,m): the bending moments in major direction

The variable n is equal to the element number and m ranges from one to five, which is the number of load.

Column section:

Element_Column_F11(n,m): the axial forces

Element_Column_T11(n,m): the torsional moments

Element_Column_V22(n,m): the shear forces in the major direction; parallel to h

Element_Column_V33(n,m): the shear forces in the minor direction; parallel to b

Element_Column_M33(n,m): the bending moments in the major direction at the specified section

Element_Column_M22(n,m): the bending moments in the minor direction at the specified section

Element_Column_TopM33(n,m): the bending moments in the major direction at top end of column

Element_Column_TopM22(n,m): the bending moments in the minor direction at top end of column

Element_Column_BottomM33(n,m): the bending moments in the major direction at bottom end of column

Element_Column_BottomM22(n,m): the bending moments in the minor direction at bottom end of column

Element_Column_SpanLoads(): identifier equals to 1 if having span loads and it equals to 0 if having no span loads. If having span loads, the moment factor, C_m (see chapter 2) is equal to 1 as a minimum value.

Element_Column_SpanMoments(): identifier equals to 1 if having span moments and it equals to 0 if having no span moments. If having span moments, the design will be only for these moments, else the design will be for the end moments.

3.8.4 The Reinforcement Design Options Submenu:

This menu is used to specify the design options dealing with the bars diameters and arrangement. For the beam section, the diameter of the main and shear bars are to be entered using the Assign Beam Reinforcement dialog as shown in Figure 3.20. For the column section, there are two options. The first: the main bars arrangement and the shear reinforcing steel bar diameter is to be entered. In this option, the program designs the main steel bar diameter for the given reinforcement arrangement as shown in Figure 3.21. The second: the main bars diameter and the shear reinforcing steel bar diameter is to be entered. In this option, the program designs the bars arrangement for the given bar diameter as shown in figure 3.22 (**form name: AssignDesignReinforcement, file: AsFotReinf.frm**).

Figure 3.20 Assign Beam Reinforcement dialog

Figure 3.21 Assign Column Reinforcement dialog/ Bars layout dialog

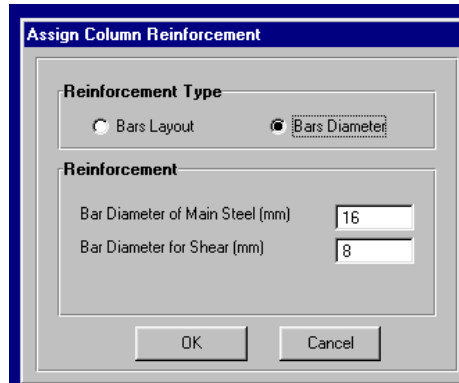

Figure 3.22 Assign Column Reinforcement/Bars diameter dialog

The variables that are read by these dialogs are defined as follows:

Element_Design_Reinforcement_Type(): identifier for the design option.

1 for bars layout and 2 for bars diameter

Element_Design_MainDiameter(): the bar diameter for main steel in mm

Element_Design_ShearDiameter(): the bar diameter for shear steel in mm

StirrupsBarsDiameter(): equals to Element_Design_ShearDiameter()

SectionStirrupsNo(): equals to 1. The number of stirrups in a section

Beam section:

TopBarsDiameter(): the diameter of top bars. It equals to Element_Design_MainDiameter()

BottomBarsDiameter(): the diameter of bottom bars. It equals to Element_Design_MainDiameter()

MiddleBarsDiameter(): the diameter of middle bars. It equals to Element_Design_MainDiameter()

Column section:

Element_Design_Column_Bars22(): the number of bars at each side of column parallel to direction h; the minor direction

Element_Design_Column_Bars33(): the number of bars at each side of column parallel to direction b; the major direction

Footing:

FootingBarsDiameter(): the diameter of reinforcing steel in footing section

3.9 The Analyze Menu:

This menu executes the program in the analysis mode by clicking on the Start Analysis/ Show Results submenu.

3.9.1 The Start Analysis/ Show Results Submenu:

This menu runs the subroutines needed for analysis of beam and column sections and displays the Analysis Output dialog as shown in Figure 2.23 (**form name: AnalysisOutput, file: AnalysisOutput.frm**). This dialog contains a table of the data. For the beam section, the table shows the positive and negative moment capacities (Beam/M+, Beam/M-) and the design shear capacity at zero axial force (Shear/Vd2). For the column section, the table shows the design shear capacity in the major and minor directions at zero axial force (Shear/Vd2, Shear/Vd3). Also, the Analysis Output dialog contains command buttons for footing analysis, displaying shear_axial interaction diagrams, displaying bending moment_axial interaction diagrams for the column section and displaying the analysis details. The details of these command buttons will be illustrated later.

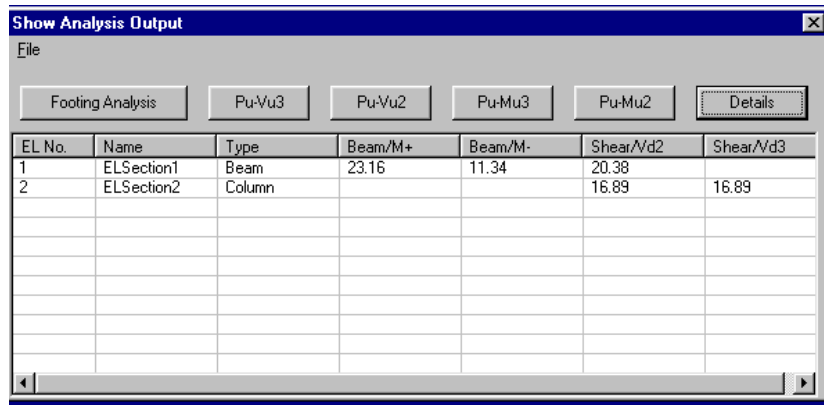

EL No.	Name	Type	Beam/M+	Beam/M-	Shear/Vd2	Shear/Vd3
1	ELSection1	Beam	23.16	11.34	20.38	
2	ELSection2	Column			16.89	16.89

Figure 2.23 the Show Analysis Output dialog

The flowchart of the main subroutine of this submenu is shown in Figure 3.24. In the flowchart, EN is the number of elements to be analyzed. The code of this subroutine is found in the form **MainForm** in the file **MDIForm.frm** in Appendix A.

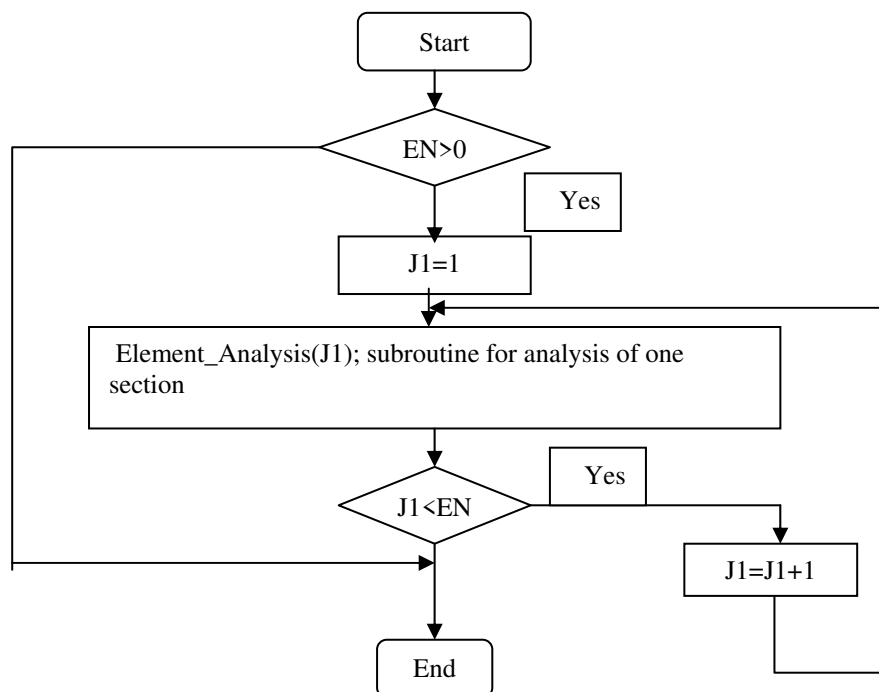

Figure 2.24 flowchart for the subroutine of Start Analysis/ Show Results submenu

The flowchart of the subroutine `Element_Analysis` is shown in Figure 2.25.

The variables in this flowchart will be defined as follows:

Element_Name(J1): element name

Element_Section(J1): name of element section

Element_Material(J1): name of material

Element_Shape(J1): element section shape

Element_Type(J1): element type; beam or column

Element_Fc(J1): element concrete compressive strength

Element_Fy(J1): element main steel yield strength

Element_Fys(J1): element shear steel yield strength

Element_B(J1): element section width

Element_H(J1): element section total depth

Element_BF(J1): element section flange width

Element_HF(J1): element section flange thickness

Element_TCover(J1): element section top concrete cover to bars center

Element_BCover(J1): element section bottom concrete cover to bars center

Element_SCover(J1): element section sides concrete cover to bars center

BeamMuP(J1): beam positive moment capacity (using bottom steel as the tension steel)

BeamMuN(J1): beam negative moment capacity (using top steel as the tension steel)

MuPCheck(J1): identifier for the state of the existing reinforcement in positive moment calculations: it equals 1 if the area of steel is less than the minimum, 0 if the area of steel is larger than the minimum and less than the maximum and 2 if the area of steel is larger than the maximum.

MuNCheck(J1): identifier for the state of the existing reinforcement in negative moment calculations: it equals 1 if the area of steel is less than the minimum, 0 if the area of steel is larger than the minimum and less than the maximum and 2 if the area of steel is larger than the maximum

AsMax(J1): the maximum area of steel for singly reinforced beam section

BeamVsMax(J1): the maximum allowed value of shear force due to existing reinforcement for beam section in the major direction, see chapter two

BeamTuCapacity(J1): the concrete torsional moment capacity for beam section

VsMax2(J1): the maximum allowed value of shear force due to existing reinforcement in the major direction of column section

VsMax3(J1): the maximum allowed value of shear force due to existing reinforcement in the minor direction of column section

Tc2(J1): the concrete torsional moment capacity for beam section in the major direction

Tc3(J1): the concrete torsional moment capacity for beam section in the minor direction

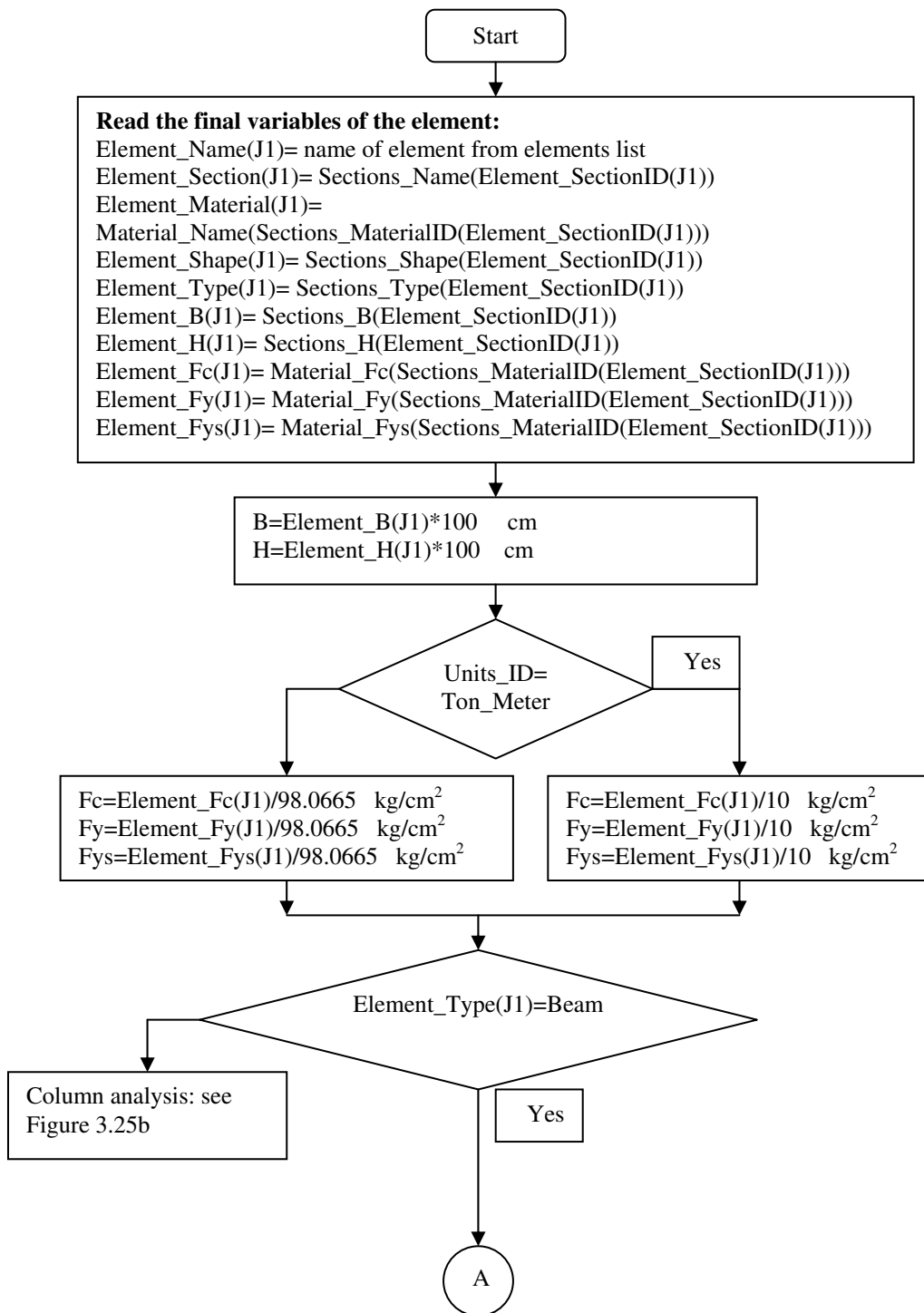
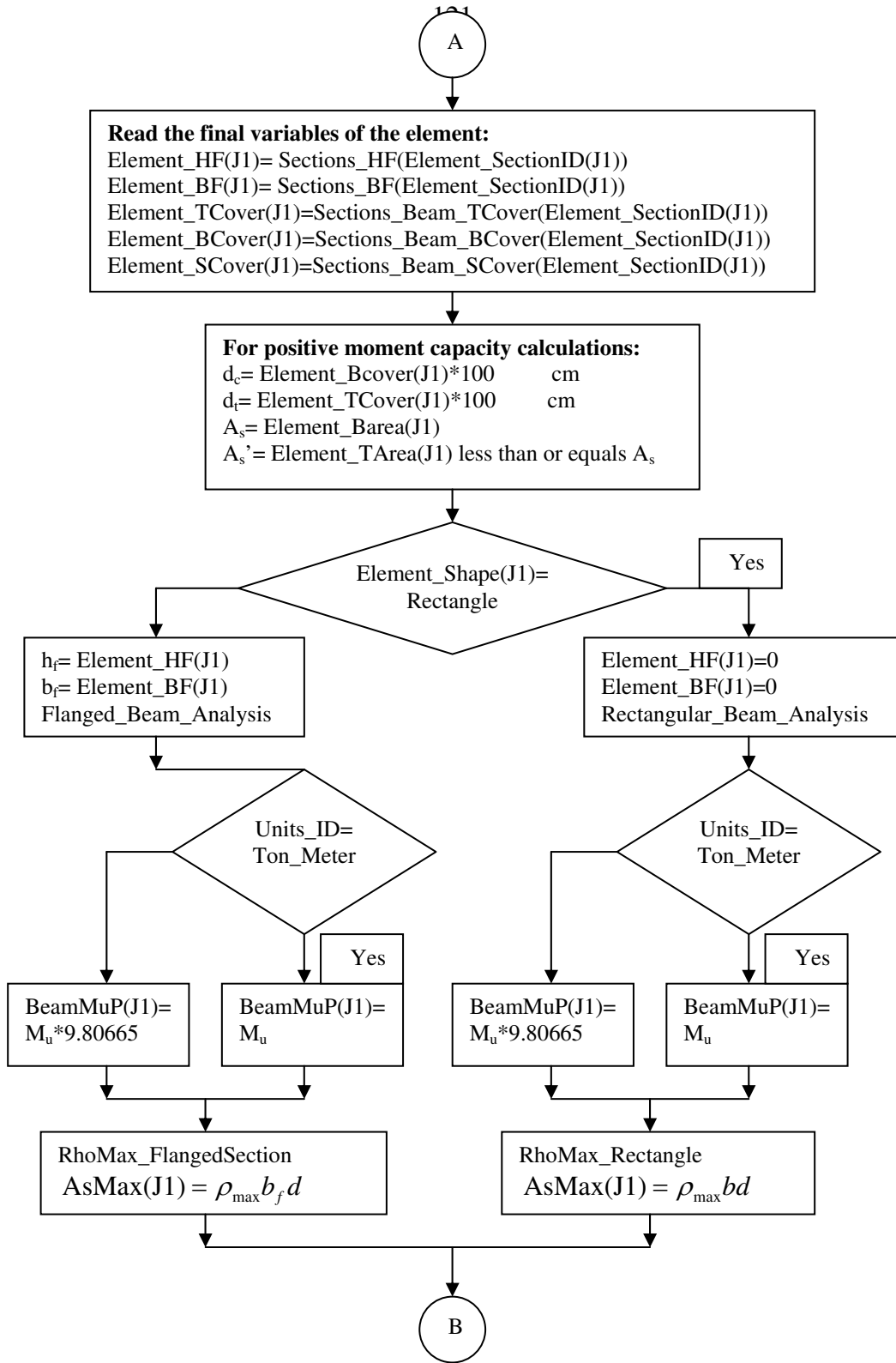

Figure 3.25a Flowchart for beam section column analysis, subroutine Element_Analysis(J1)

Figure 3.25a continued



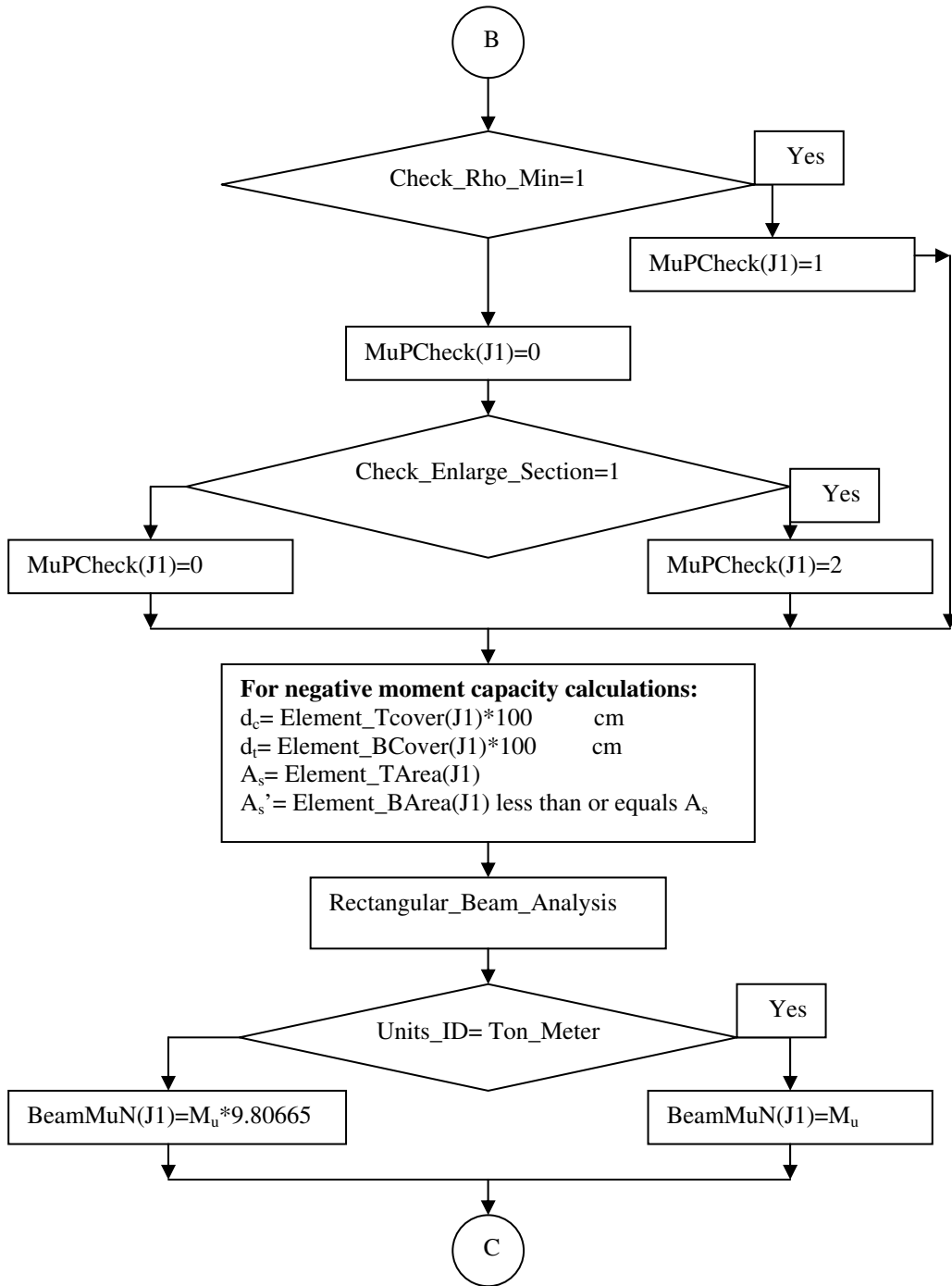

Figure 3.25a continued

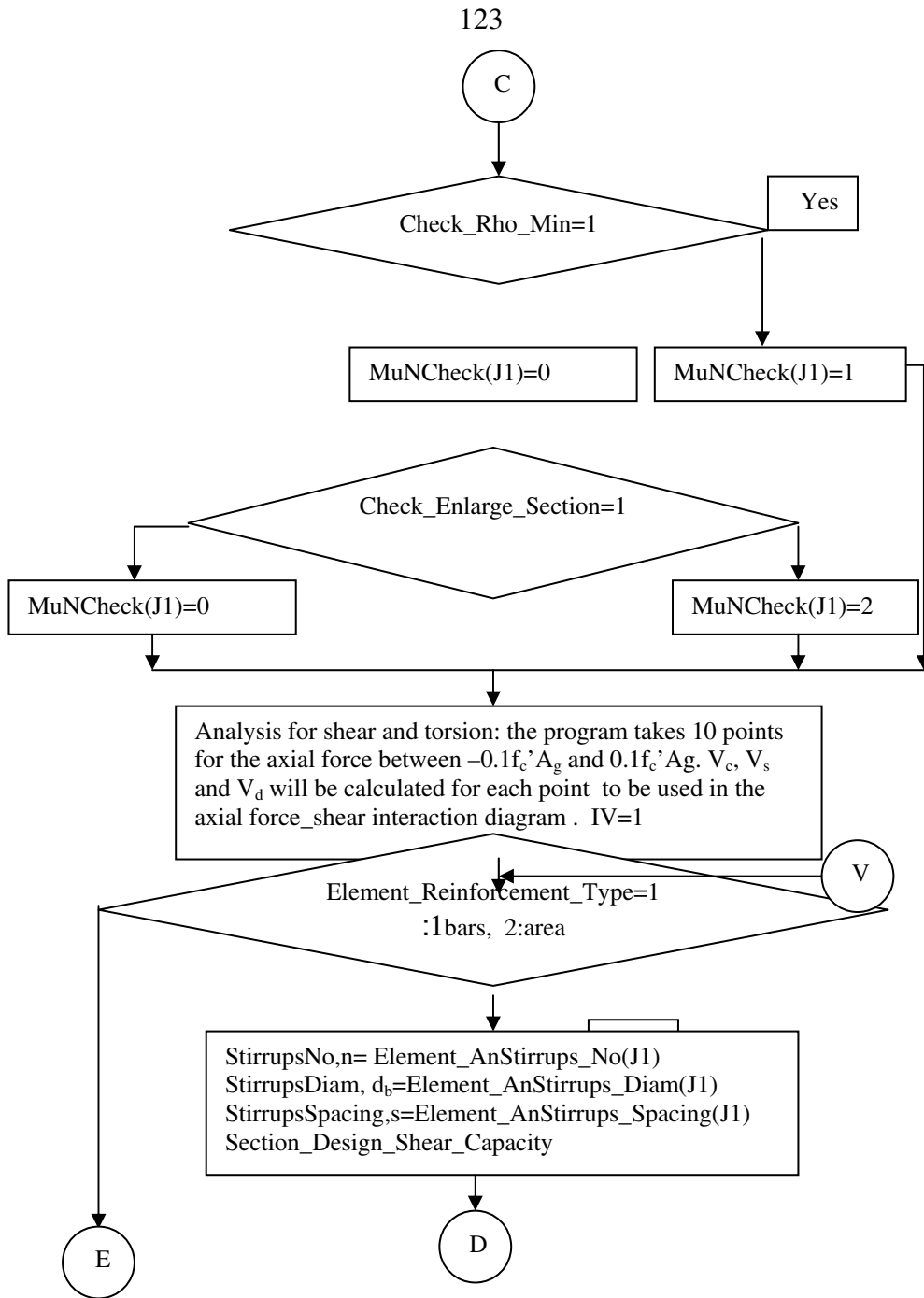

Figure 3.25a continued

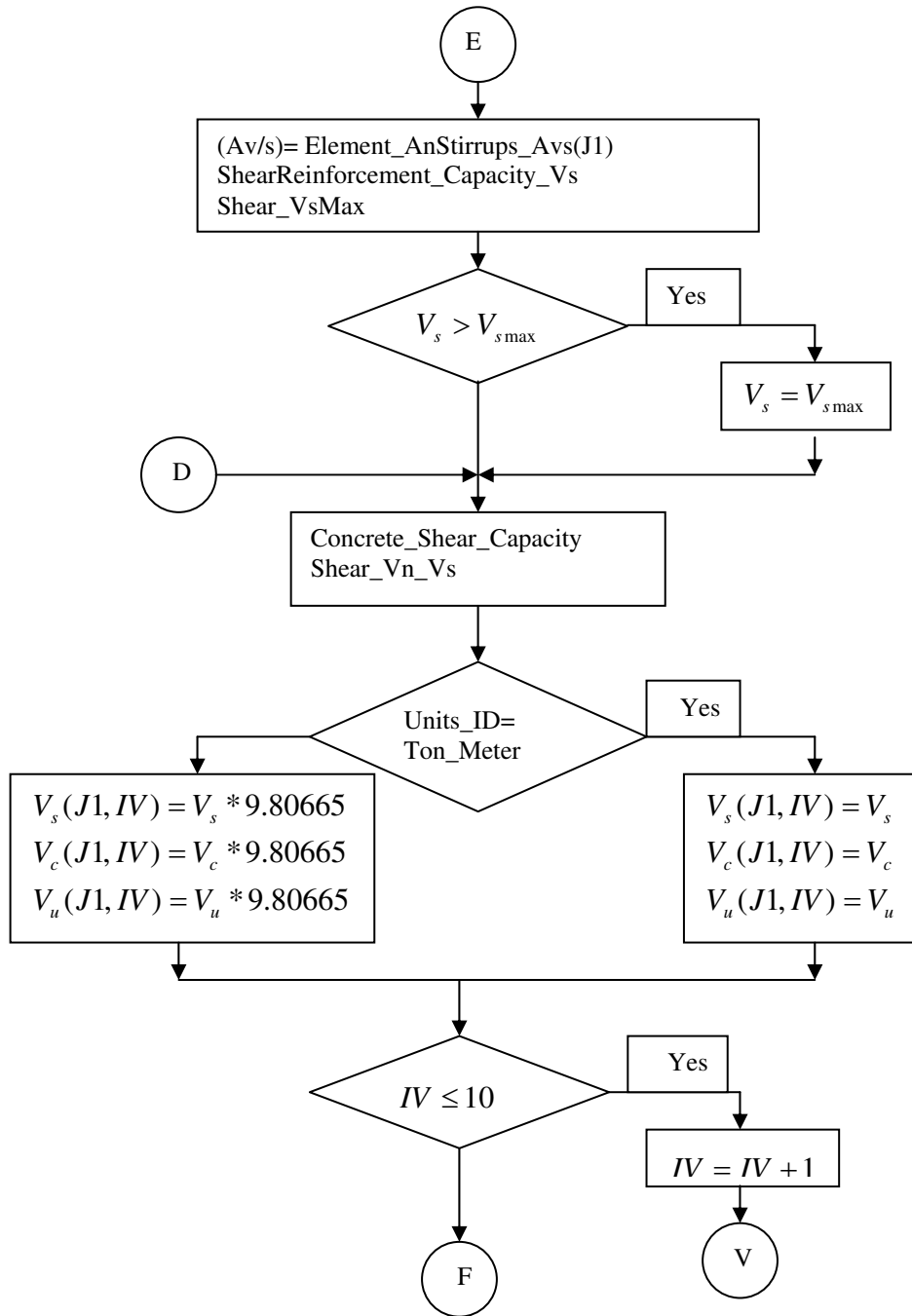

Figure 3.25a continued

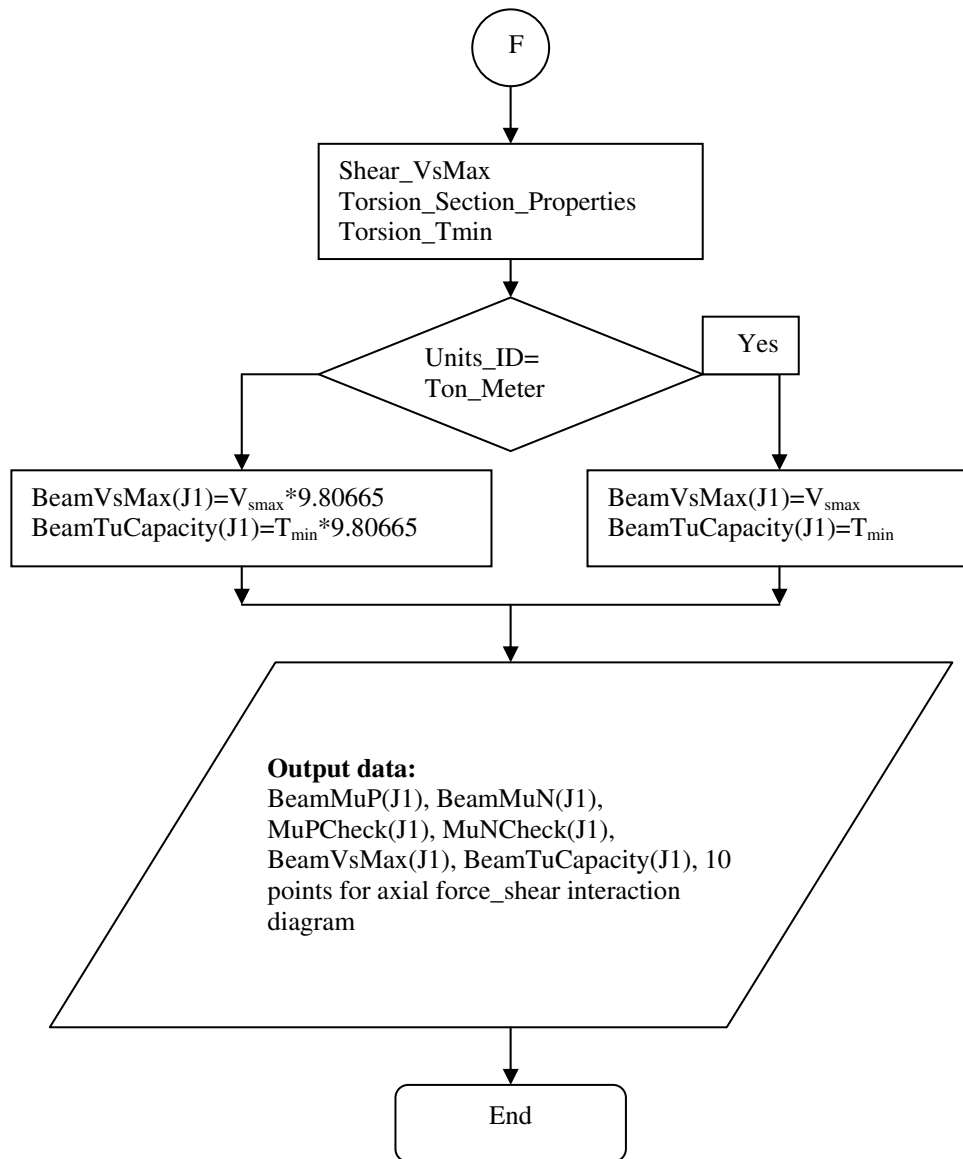

Figure 3.25a continued

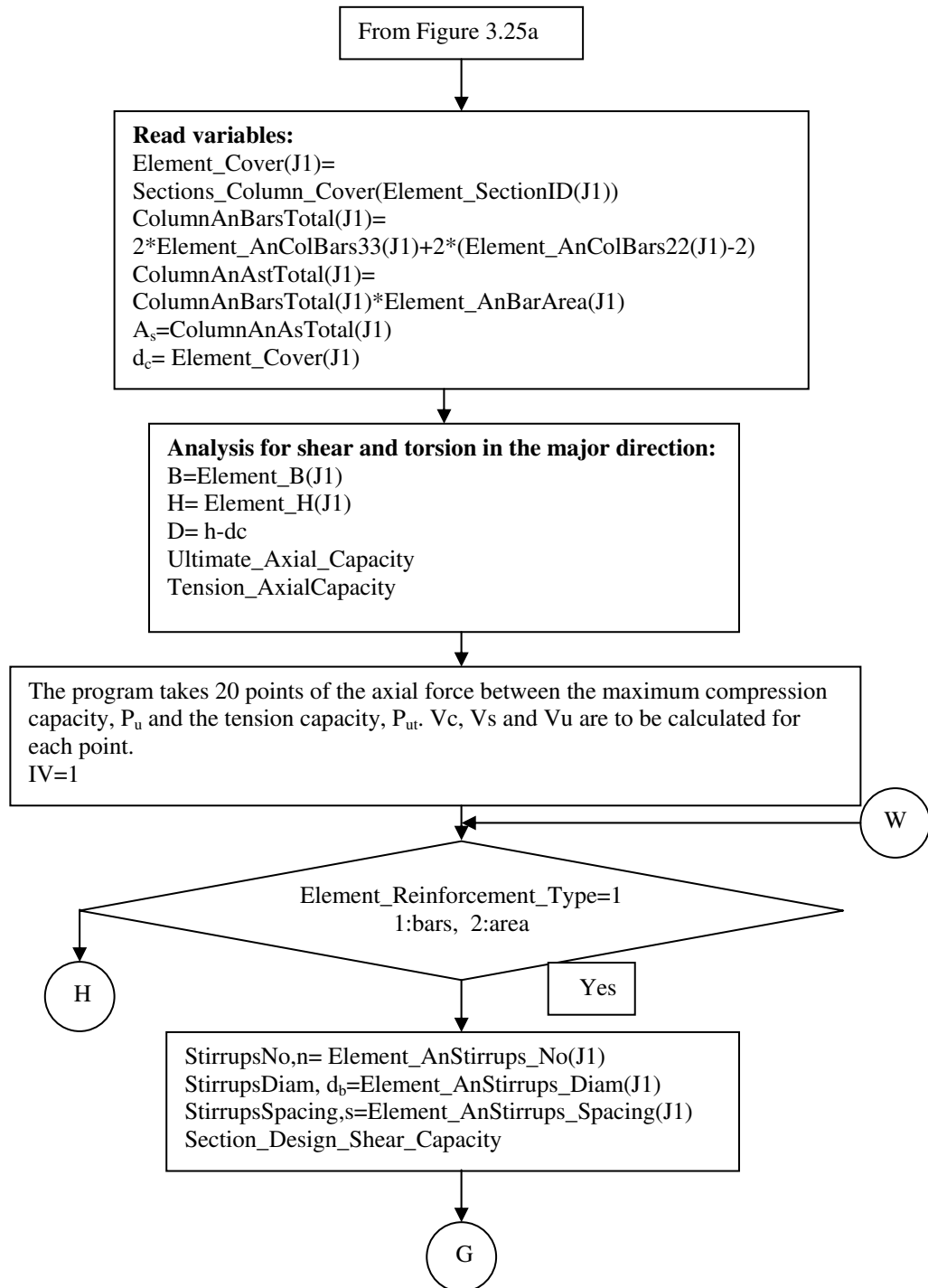

Figure 3.25b Flowchart for column section analysis, subroutine `Element_Analysis(J1)`

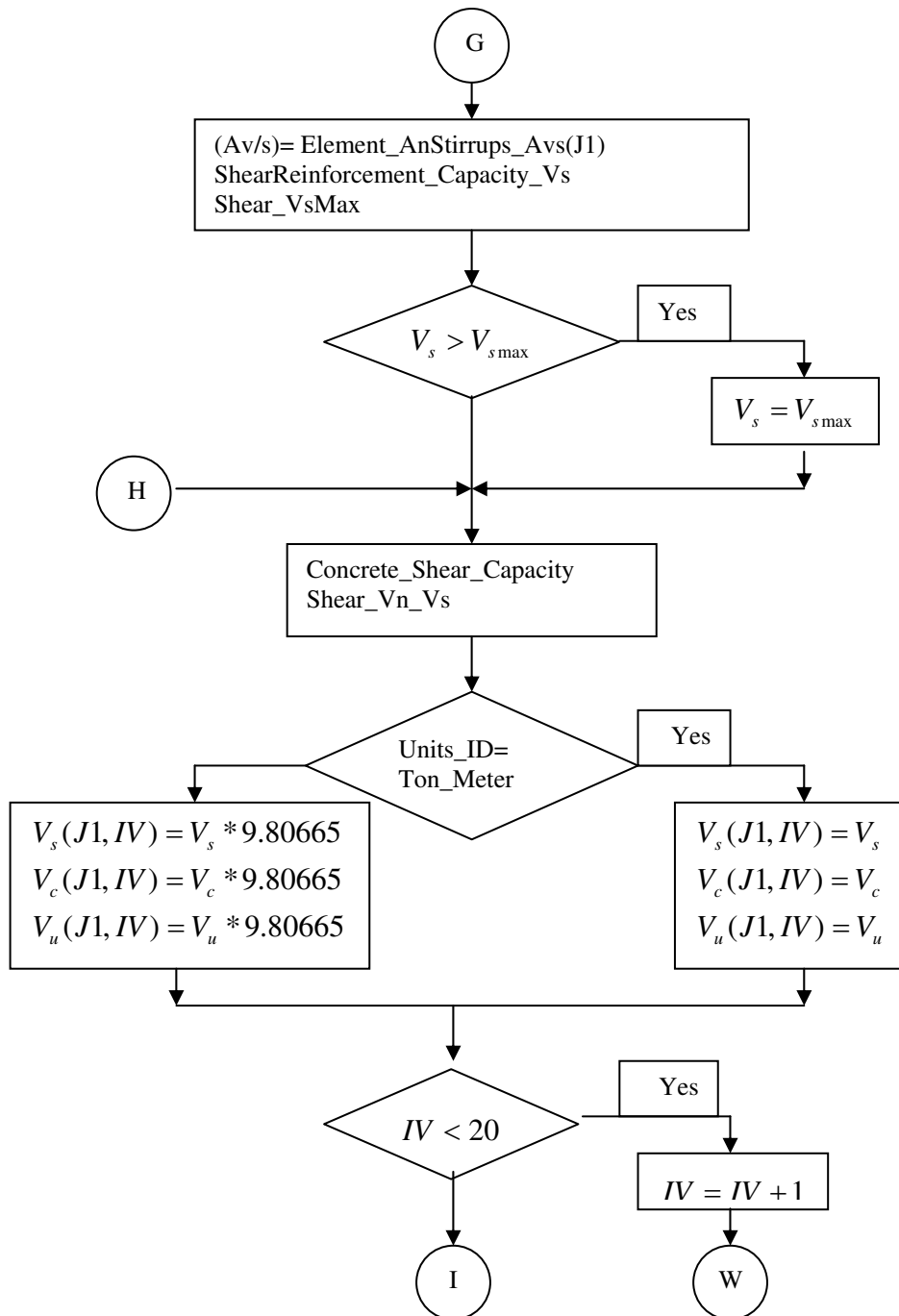

Figure 3.25b continued

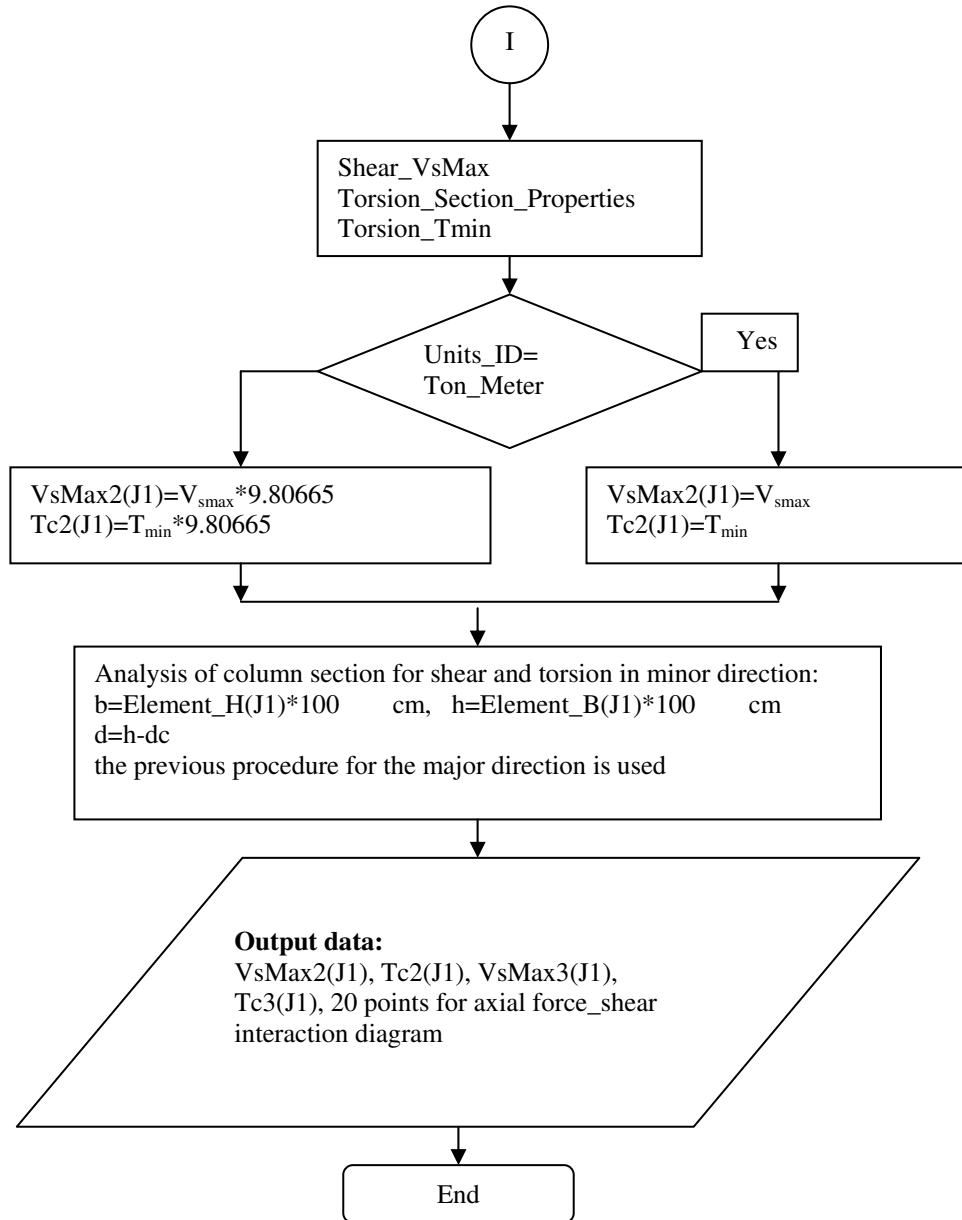

Figure 3.25b continued

The Footing Analysis command button in the Output Analysis dialog runs a subroutine for analysis of footing. The results are displayed in the form Details, file DesignDetails.frm as shown in Figure 3.26. Figure 3.27 shows the subroutine flowchart. The variables in the flowchart are defined as follows:

Element_Footing_Material(SL1): the material for the footing section

Element_Footing_Fc(SL1): the compressive strength of concrete for the footing section

Element_Footing_Fy(SL1): the steel yield strength for the footing section

Element_Footing_LoadFactor(SL1): average load factor for the dead and live loads

Element_Footing_SoilCapacity(SL1): allowable soil capacity

Element_Footing_Cover(SL1): concrete cover in footing section

BC: column width

HC: column length

BT: footing width

LT: footing length

FootingPu(SL1,1): the calculated Pu from soil capacity

FootingPu(SL1,2): the calculated Pu from wide beam shear capacity in L direction

FootingPu(SL1,3): the calculated Pu from wide beam shear capacity in B direction

FootingPu(SL1,4): the calculated Pu from punching shear capacity

FootingPu(SL1,5): the calculated Pu from flexural strength in L direction

FootingPu(SL1,6): the calculated Pu from flexural strength in B direction

FootingPuMax(SL1): the maximum value of Pu from the previous values

FootingMuL(SL1): the bending moment at face of column in L direction

FootingMuB(SL1): the bending moment at face of column in B direction

FootingVuL(SL1): the shear force at distance d from face of column in L direction

FootingVuB(SL1): the shear force at distance d from face of column in B direction

FootingID2(SL1): identifier for the existing area of steel:

- 1: if area of steel in direction L is less than the minimum
- 2: if area of steel in direction L is larger than the maximum
- 3: if area of steel in direction B is less than the minimum
- 4: if area of steel in direction B is larger than the maximum

ACI 318-99 Footing Section Analysis Units: Forces Ton_Meter Reinforcement cm

Element ID: ELSection1
 Section ID: FRSECT1
 Material ID: Concrete1
 Type ID: Single Footing

Fc= 2000 Fy= 42000 C= 0.1 Qa= 30 Lf= 1.6

Length(L)= 2 Width(B)= 2 Depth(D)= 0.5

Reinforcement:

Direction	Steel Area
Direction_L	20.000
Direction_B	20.000

Axial Load, Pu:

Design Pu	Soil Pu	Shear_L Pu	Shear_B Pu	Punching Pu	Moment_L Pu	Moment_B Pu
78.54	192.00	339.79	226.53	247.12	115.81	78.54

Footing Forces:

Direction	Moment	Shear
Direction_L	4.81	5.89
Direction_B	7.09	8.84

Figure 3.26 Show Footing Analysis dialog

Figure 3.27 Flowchart for footing analysis

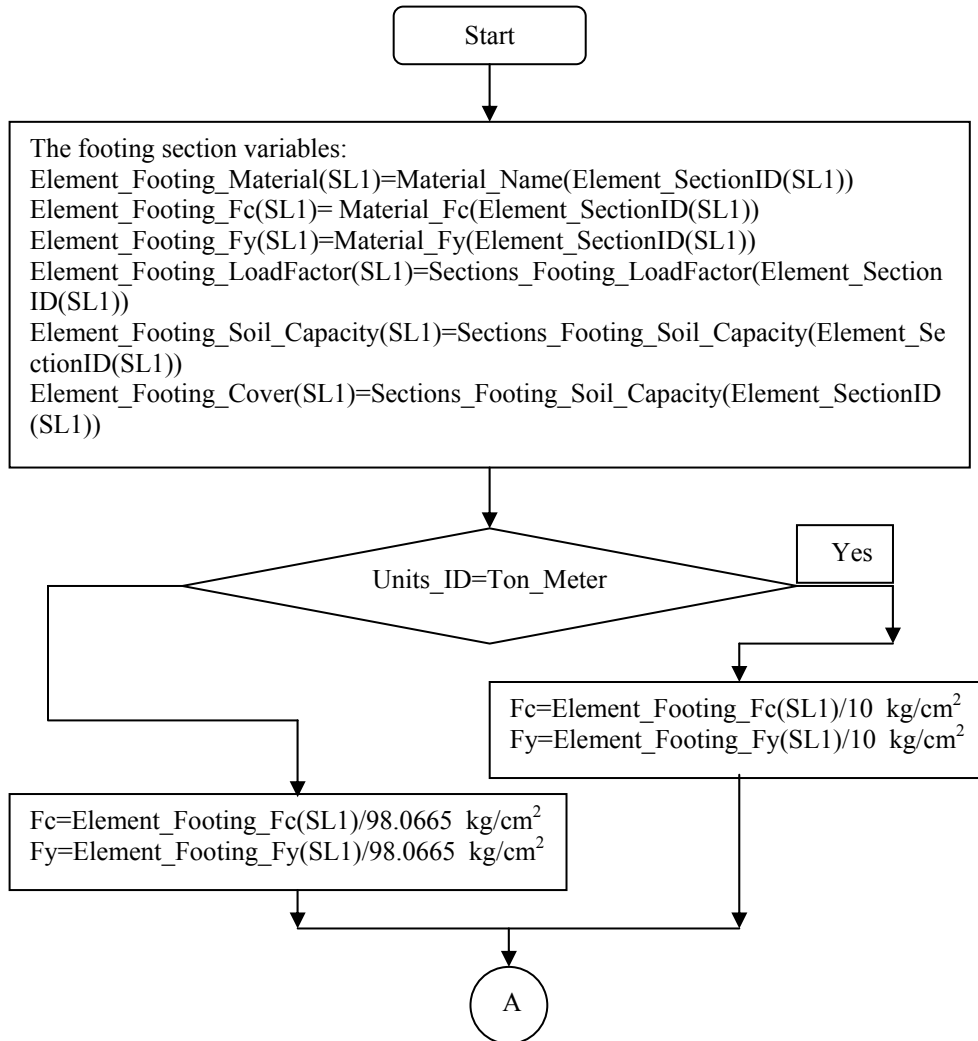
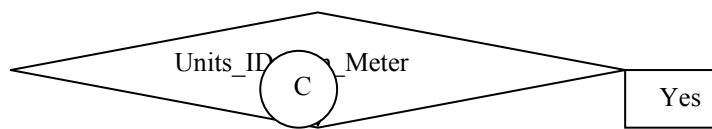
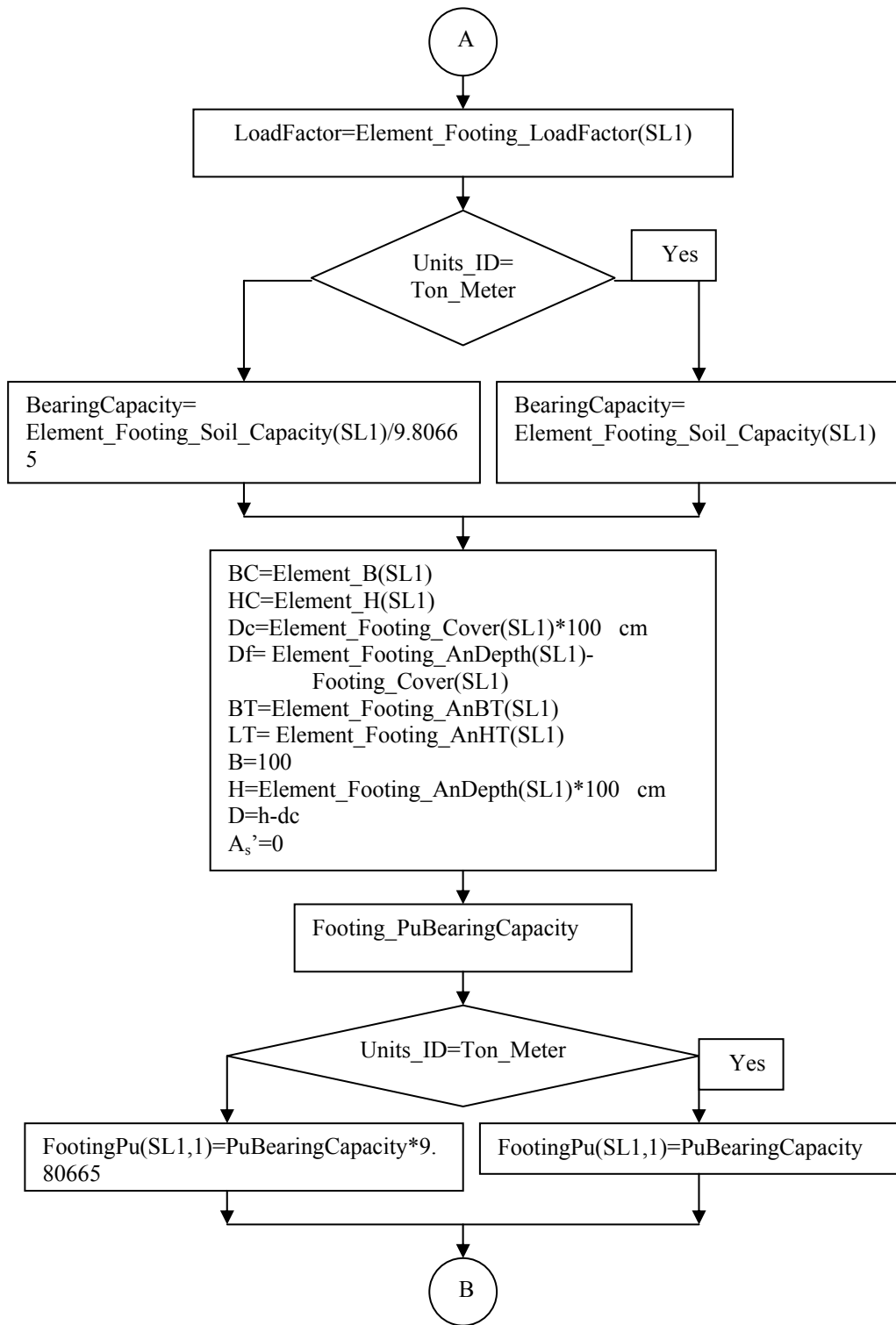

Figure 3.27 continued



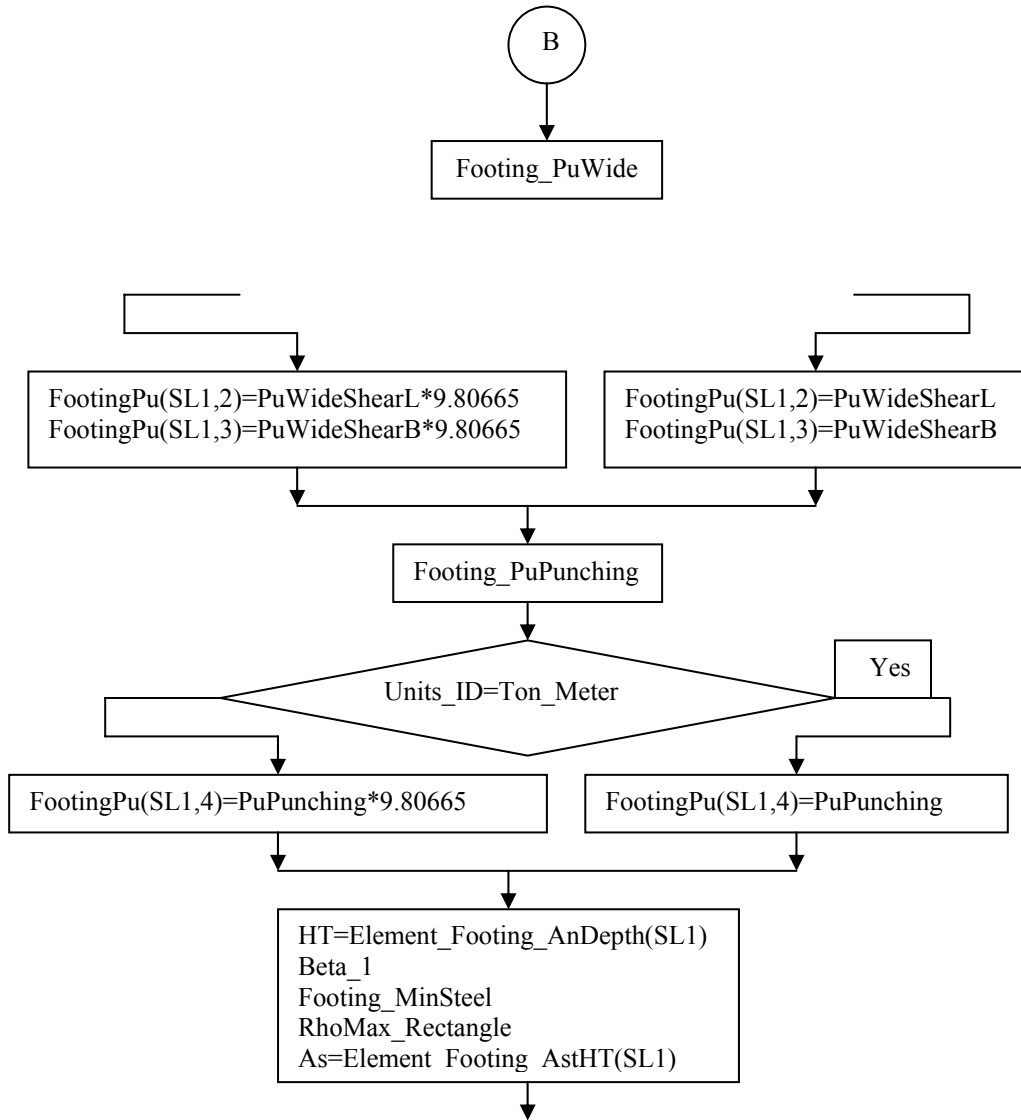
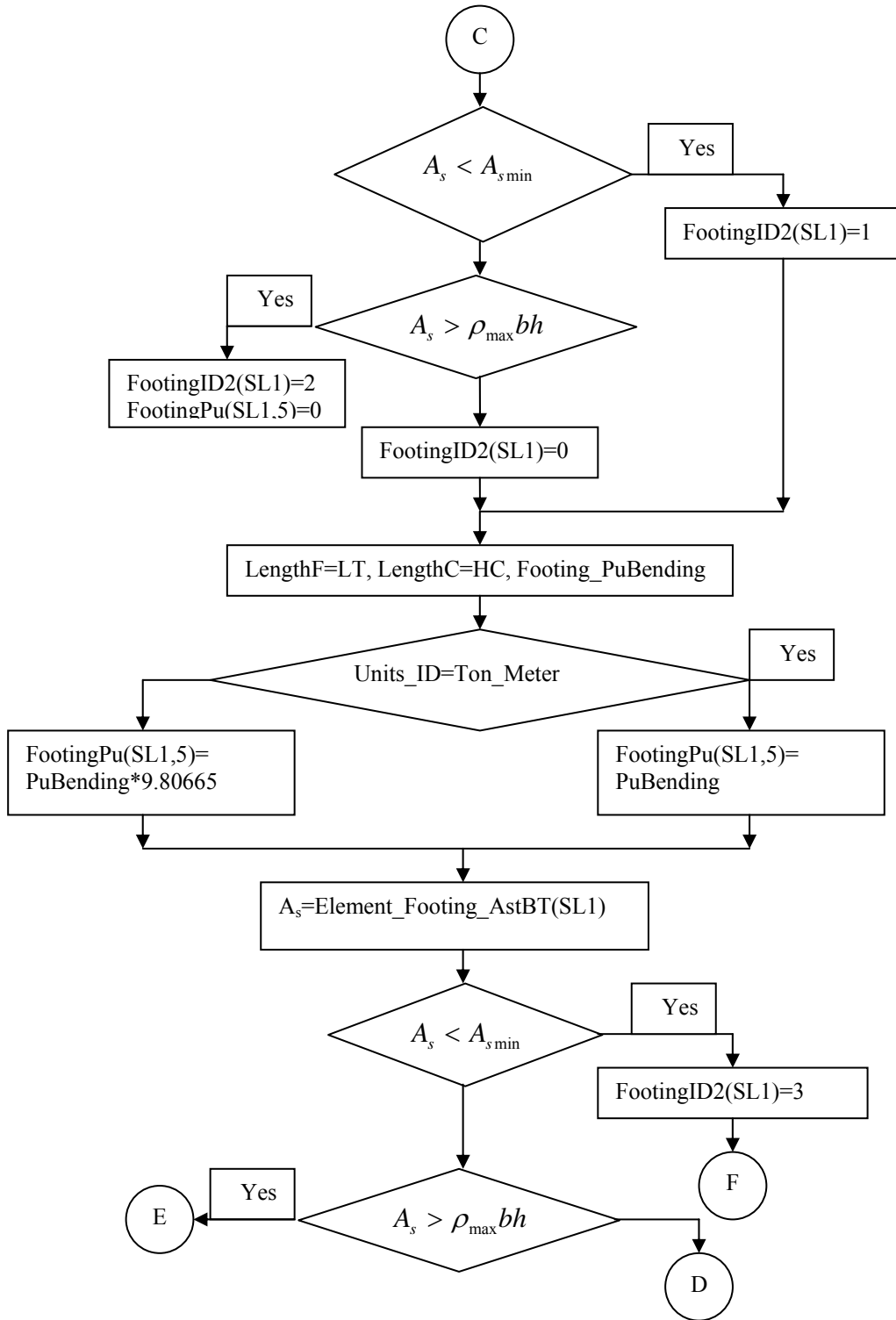

Figure 3.27 continued

Figure 3.27 continued



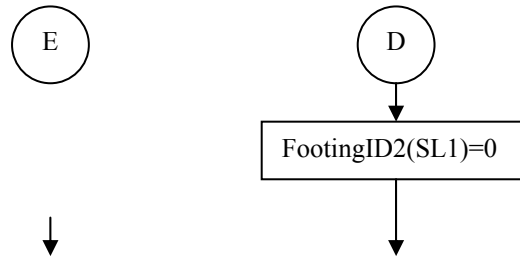
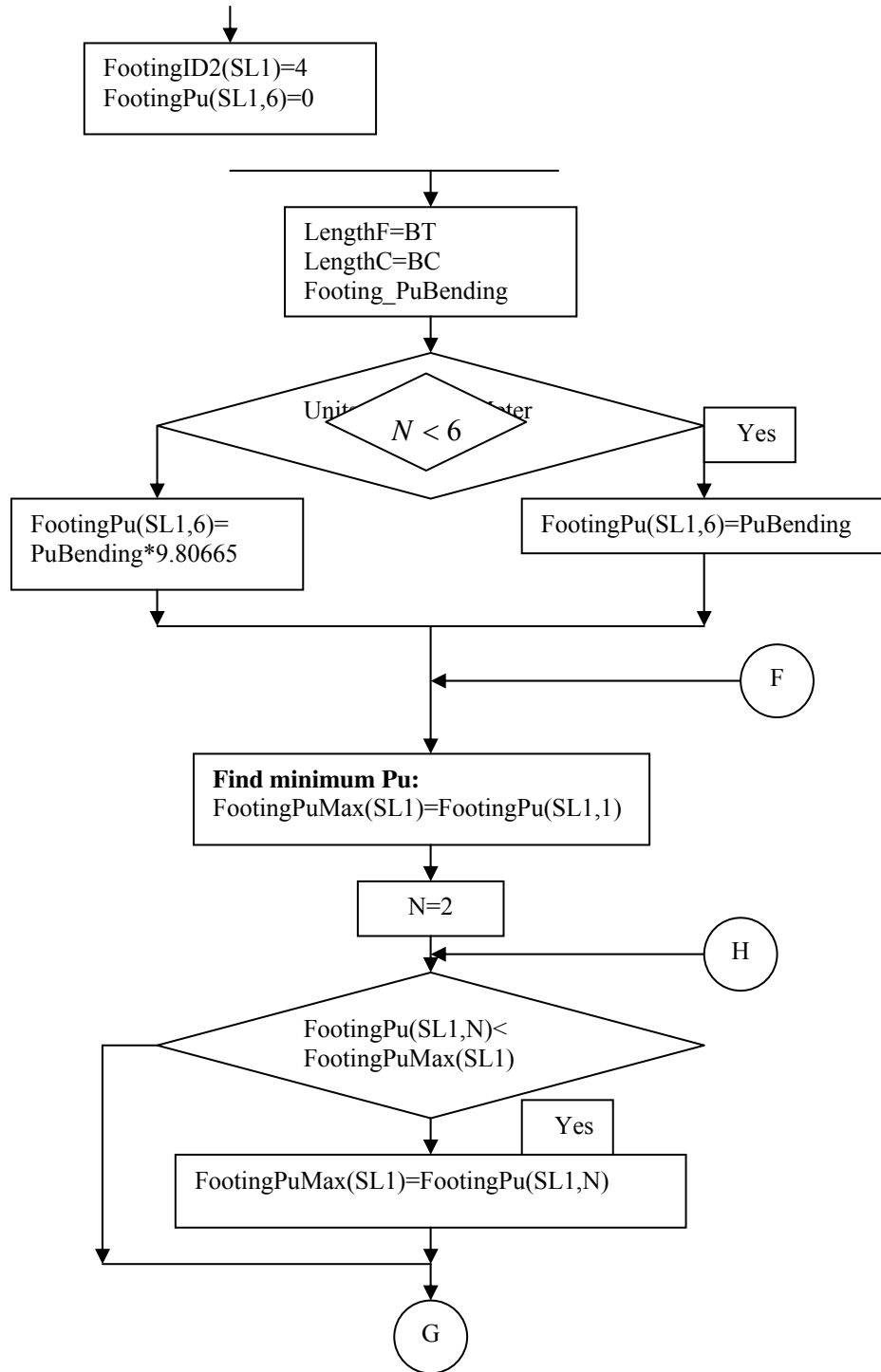

Figure 3.27 continued



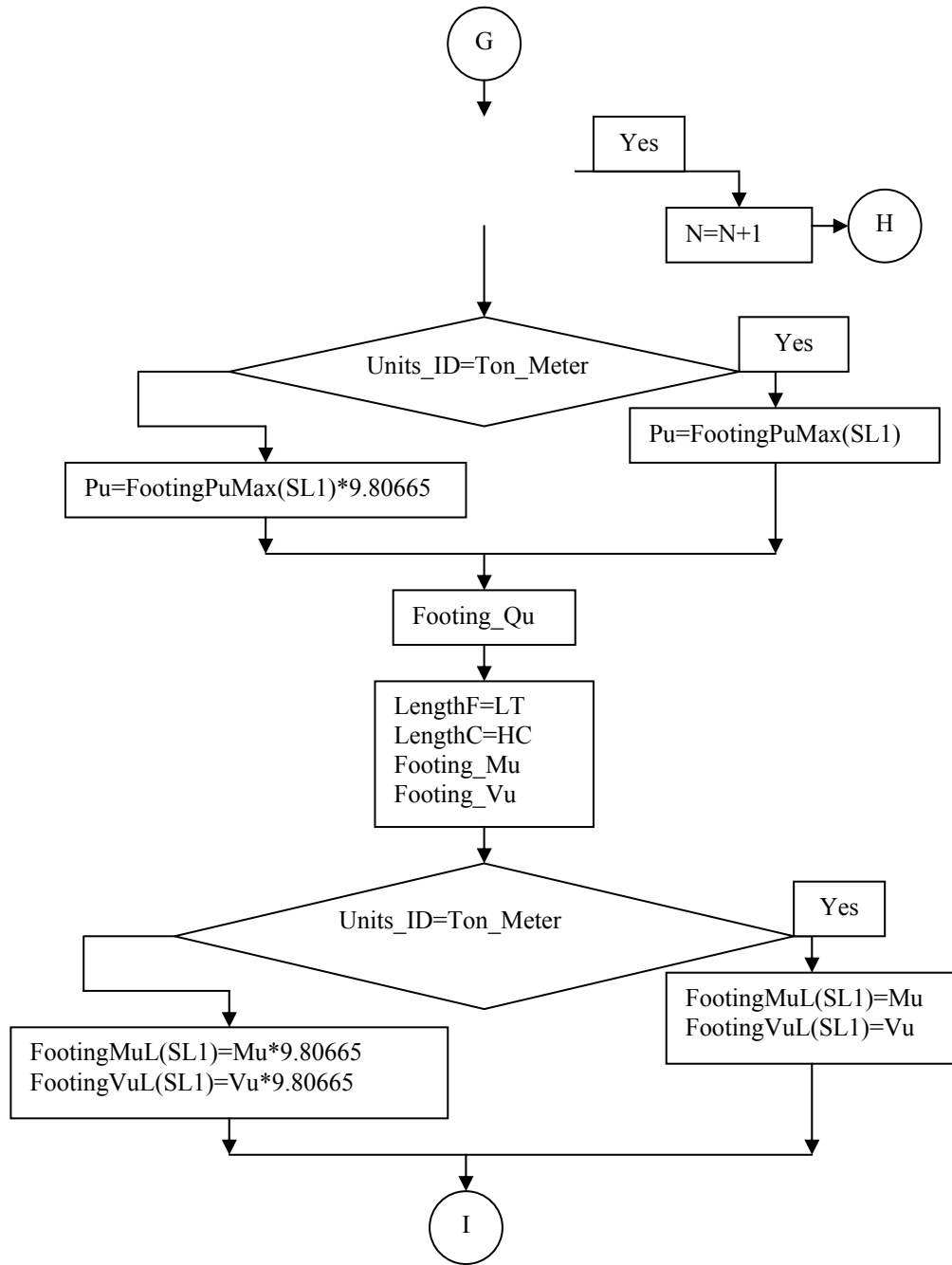

Figure 3.27 continued

LengthF=BT
LengthC=BC
Footing_Mu
Footing_Vu

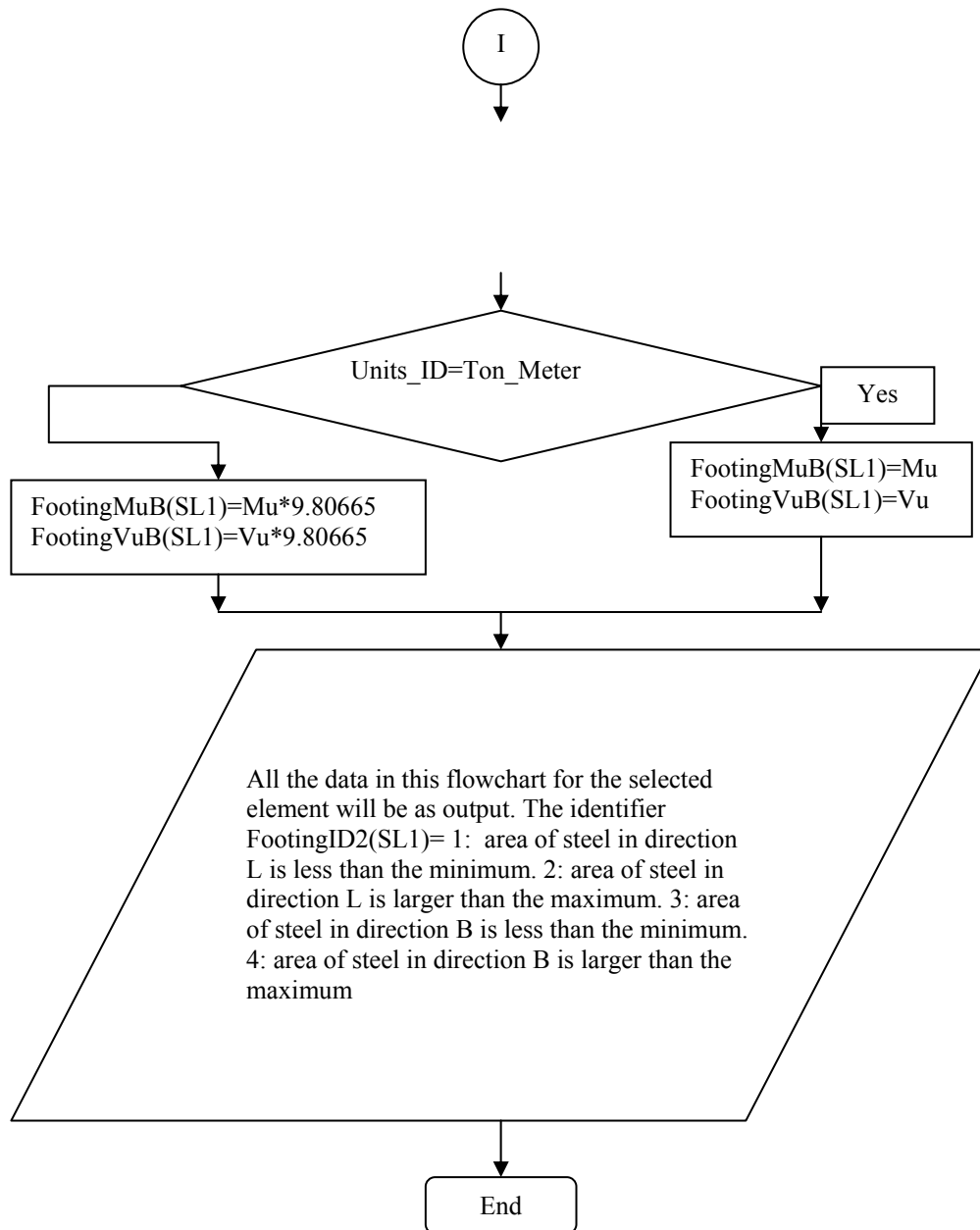

Figure 3.27 continued

The Pu_Vu2 and Pu_Vu3 commands each runs a subroutine to convert the points of the axial and shear forces calculated in the subroutine Element_Analysis(J1) to drawings as interaction diagrams as shown in Figure 3.28.

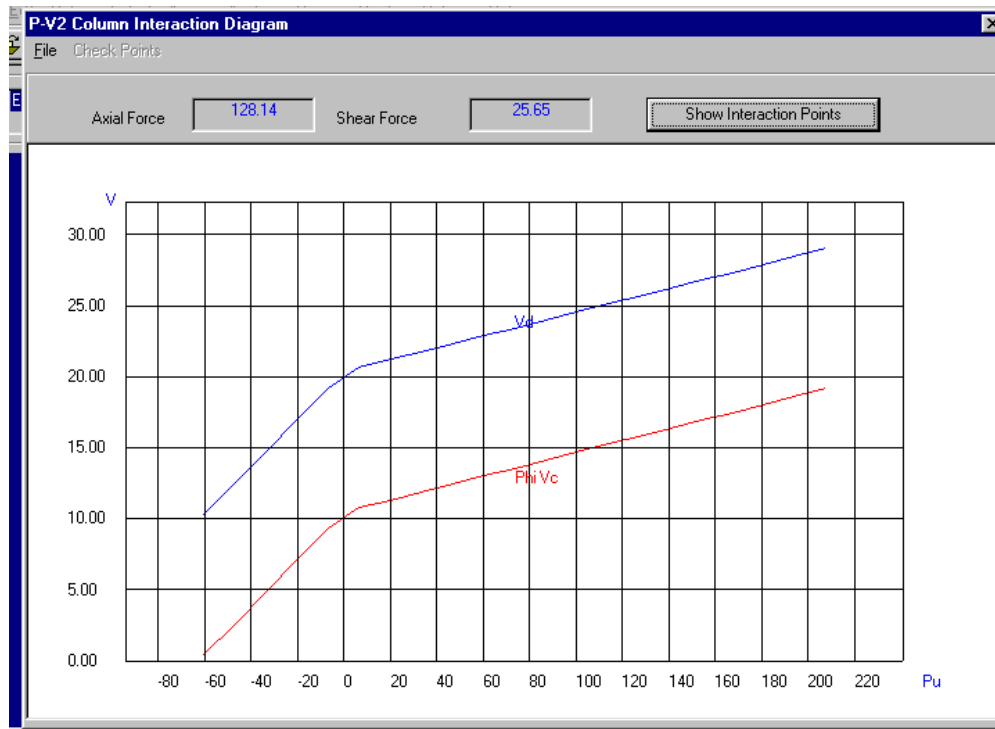

Figure 3.28a Axial force_shear force interaction diagram

No.	Pu	Vc	Phi Vc	Vs	Vn	Vd
1	-60.48	0.49	0.38	11.61	12.11	10.29
2	-47.08	3.12	2.41	11.61	14.74	12.53
3	-33.69	5.75	4.45	11.61	17.37	14.76
4	-20.29	8.38	6.48	11.61	20.00	17.00
5	-6.89	11.01	8.51	11.61	22.63	19.23
6	6.51	12.69	9.80	11.61	24.30	20.65
7	19.90	13.34	10.31	11.61	24.96	21.21
8	33.30	14.00	10.82	11.61	25.61	21.77
9	46.70	14.66	11.33	11.61	26.27	22.33
10	60.10	15.32	11.84	11.61	26.93	22.89
11	73.49	15.97	12.34	11.61	27.59	23.45
12	86.89	16.63	12.85	11.61	28.24	24.01
13	100.29	17.29	13.36	11.61	28.90	24.57

Figure 3.28b Interaction points of axial force_shear interaction diagram

The Pu_Mu3 command runs a subroutine to calculate the points of axial forces and bending moments that are necessary for the drawing of the axial force_moment interaction diagram in the major direction of column section as shown in Figure 3.29. Figure 3.30 shows the flowchart of the subroutine.

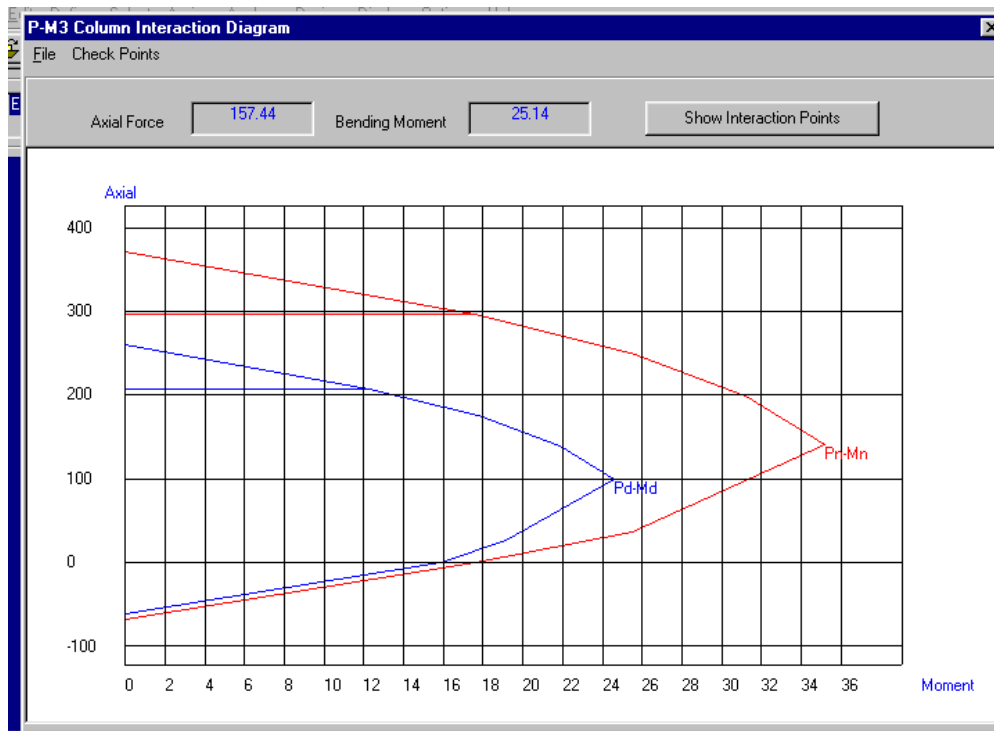

Figure 3.29a Axial force_bending moment interaction diagram in the major direction

No.	Pn	Mn	Pd	Md	Note
1	370.48	0.00	259.34	0.00	Maximum Axial Load
2	296.38	17.54	207.47	12.28	0.8*Maximum Axial Load
3	250.06	25.42	175.04	17.79	Between 0.8Pn and Pnbal
4	199.10	31.19	139.37	21.84	Between 0.8Pn and Pnbal
5	141.62	35.16	99.14	24.61	Balanced
6	36.00	25.48	27.01	19.12	0.1 Fc Ag
7	0.00	17.63	0.00	15.87	Pure moment
8	-67.20	0.00	-60.48	0.00	Pure tension

Figure 3.29b Interaction points of the axial force_bending moment interaction diagram

Calculating Interaction Points	
Given	
<input checked="" type="radio"/> Axial Force, Pu	<input type="radio"/> Eccentricity, e
Input	
Axial Force, Pu	50
OK	
Output	
Bending Moment, Mu	21.61
Reduction Factor, Phi	.700

Figure 3.29c Calculating moment value at a certain axial force

The variables in the flowchart are defined as follows:

ColHIPPn(SL1,1): the nominal maximum axial load capacity, P_n

ColHIPPn(SL1,2): $0.8P_n$

ColHIPPn(SL1,3): nominal axial load between the balanced force, P_{nb} and $0.8P_n$

ColHIPPn(SL1,4): nominal axial load between the balanced force, P_{nb} and $0.8P_n$

ColHIPPn(SL1,5): nominal balanced force, P_{nb}

ColHIPPn(SL1,6): nominal axial load of $0.1f_cA_g$

ColHIPPn(SL1,7): the nominal force at pure moment which it equals to zero

ColHIPPn(SL1,8): pure tension force

ColHIPPd(SL1,1): the design maximum axial load capacity, $0.7P_n$

ColHIPPd(SL1,2): $0.7(0.8)P_n$

ColHIPPd(SL1,3): design axial load between the balanced force, P_{db} and $0.7(0.8)P_n$

ColHIPPd(SL1,4): design axial load between the balanced force, P_{db} and $0.7(0.8)P_n$

ColHIPPd(SL1,5): design balanced force, P_{db}

ColHIPPd(SL1,6): design axial load of $\Phi 0.1f_cA_g$

ColHIPPd (SL1,7): the design force at pure moment which it equals to zero

ColHIPPd(SL1,8): design pure tension force

ColHIPMn(SL1,1): the nominal moment capacity at maximum axial load capacity, P_n which equals to zero

ColHIPMn(SL1,2): the nominal moment at $0.8P_n$

ColHIPMn(SL1,3): nominal moment at nominal axial load between the balanced force, P_{nb} and $0.8P_n$

ColHIPMn(SL1,4): nominal moment at nominal axial load between the balanced force, P_{nb} and $0.8P_n$

ColHIPMn(SL1,5): nominal moment at nominal balanced force, P_{nb} which is M_{nb}

ColHIPMn(SL1,6): the nominal moment at nominal axial load of $0.1f_cA_g$

ColHIPMn(SL1,7): the nominal pure moment

ColHIPMn(SL1,8): the nominal moment at nominal pure tension force

ColHIPMd(SL1,1): the design moment capacity at maximum axial load capacity, $0.7P_n$ which equals to zero

ColHIPMd(SL1,2): the design moment at $0.7(0.8)P_n$

ColHIPMd(SL1,3): design moment at design axial load between the balanced force, P_{db} and $0.7(0.8)P_n$

ColHIPMd(SL1,4): design moment at design axial load between the balanced force, P_{db} and $0.7(0.8)P_n$

ColHIPMd(SL1,5): design moment at the design balanced force, P_{db} which is M_{db}

ColHIPMd(SL1,6): the design moment at design axial load of $\Phi 0.1f_cA_g$

ColHIPMd(SL1,7): the design pure moment

ColHIPMd(SL1,8): the design moment at design pure tension force

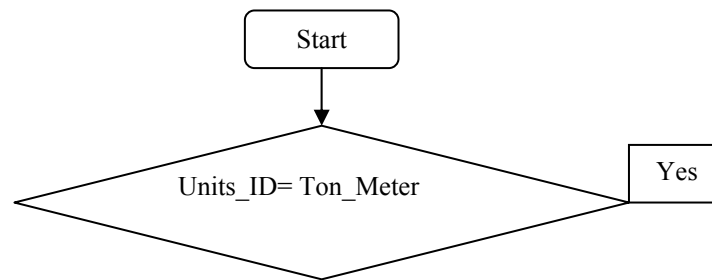
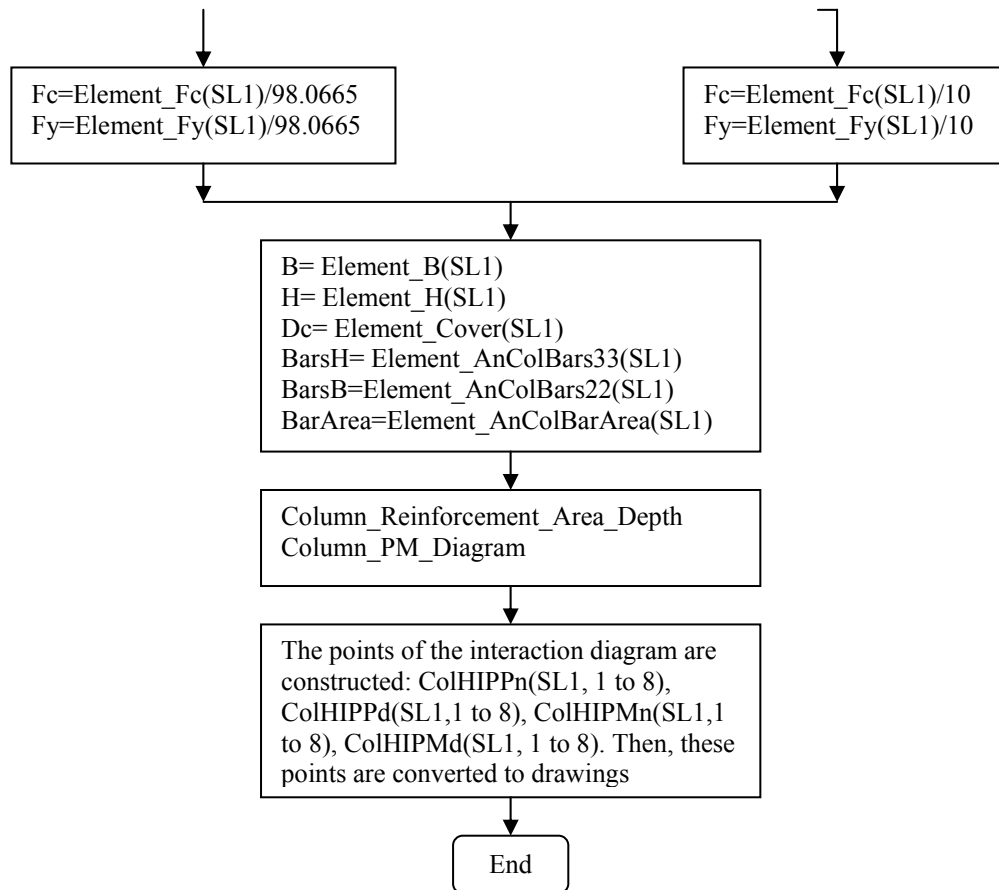

Figure 3.30 Flowchart of the subroutine that calculates points of the axial force_bending moment interaction diagram in column major direction

The Pu_Mu2 command runs a subroutine to calculate the points of axial



forces and bending moments that are necessary for the drawing of the axial force_moment interaction diagram in the minor direction of column section. Figure 3.31 shows the flowchart of the subroutine. The variables in the flowchart are defined as the variables in the flowchart in Figure 3.30 for the column section in the major direction. The variables are:

ColBIPPn(SL1, 1 to 8): defines the nominal axial forces

ColBIPPd(SL1, 1 to 8): defines the design axial forces

ColBIPMn(SL1, 1 to 8): defines the nominal bending moments

ColBIPMd(SL1, 1 to 8): defines the design bending moment

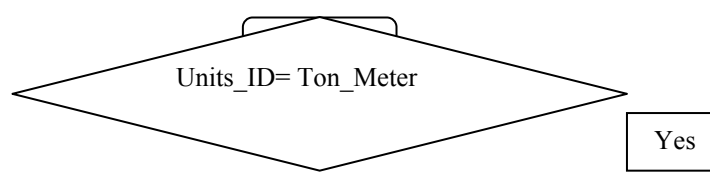

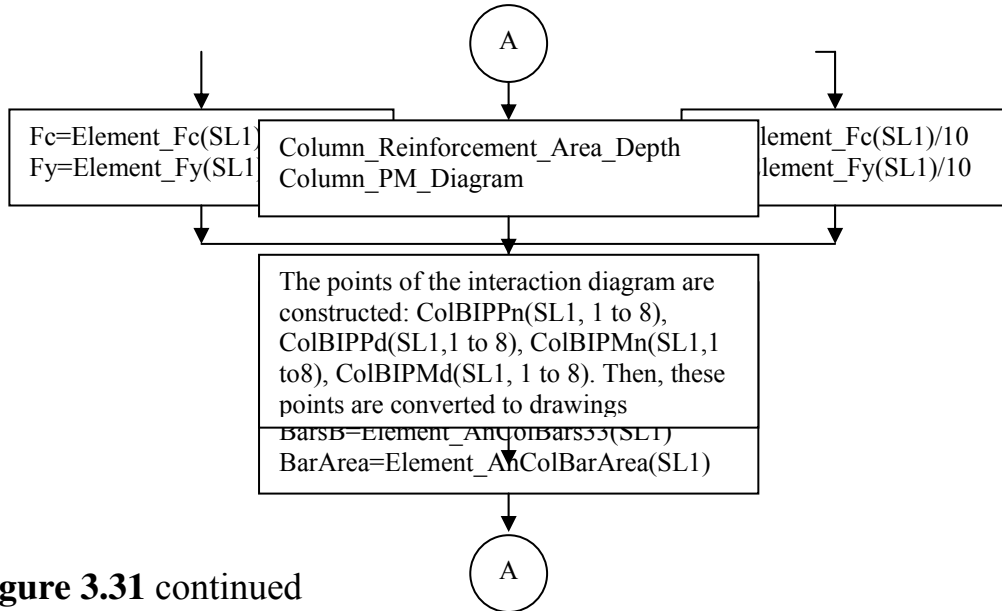

Figure 3.31 continued

End

Figure 3.31 Flowchart of the subroutine that calculates points of the axial force_bending moment interaction diagram in column minor direction

3.10 The Design Menu:

This menu is used to run the design mode and to overwrite the design factors for column design.

3.10.1 The Redefine Element Design Data Submenu:

This submenu is used to define or overwrite the column design factors. It displays the Redefine Element Design Data dialog as shown in Figure 3.32 (form name: **RedefineElementDesignData**, file: **DesignData.frm**). In this dialog, one can overwrite the values of the unbraced length ratios, effective length factors, moment factors C_m , nonsway factors δ_{ns} , sway factors δ_s , ratio of dead load to total load β_d and element type (see chapter two). The program uses the default values of the previous factors. If the value in the edit box is other than zero, the program use the value in the edit box.

Figure 3.32 Redefine Element Design Data dialog

The variables that are read from this dialog are defined as follows:

Element_OvULR33(): the overwrite value of the unbraced length ratio in the major direction. The default value is one.

Element_OvULR22(): the overwrite value of the unbraced length ratio in the minor direction. The default value is one.

Element_OvELF33(): the overwrite value of the effective length factor in the major direction. The default value is one.

Element_OvELF22(): the overwrite value of the effective length factor in the minor direction. The default value is one.

Element_OvCm33(): the overwrite value of the moment factor, C_m in the major direction. The default value is that calculated by the program.

Element_OvCm22(): the overwrite value of the moment factor, C_m in the minor direction. The default value is that calculated by the program.

Element_OvDns33(): the overwrite value of the nonsway factor, δ_{ns} in the major direction. The default value is that calculated by the program.

Element_OvDns22(): the overwrite value of the nonsway factor, δ_{ns} in the minor direction. The default value is that calculated by the program.

Element_OvDs33(): the overwrite value of the sway factor, δ_s in the major direction. The default value is one.

Element_OvDs22(): the overwrite value of the sway factor, δ_s in the minor direction. The default value is one.

Element_OvBd(): the overwrite value of the ratio of the factored dead load to the factored total load. The default value is that calculated by the program.

Element_Design_Type(): the column design type:

- 1: sway special moment resisting frame
- 2: sway intermediate moment resisting frame
- 3: sway ordinary moment resisting frame
- 4: nonsway moment resisting frame

3.10.2 Start Design/ Show Results:

This submenu is used to run the design mode. It will be active only if the design mode is firstly selected. It displays the Show Design Results dialog as shown in Figure 3.33 (**form name: DesignOutput, file: DesignOutput.frm**).

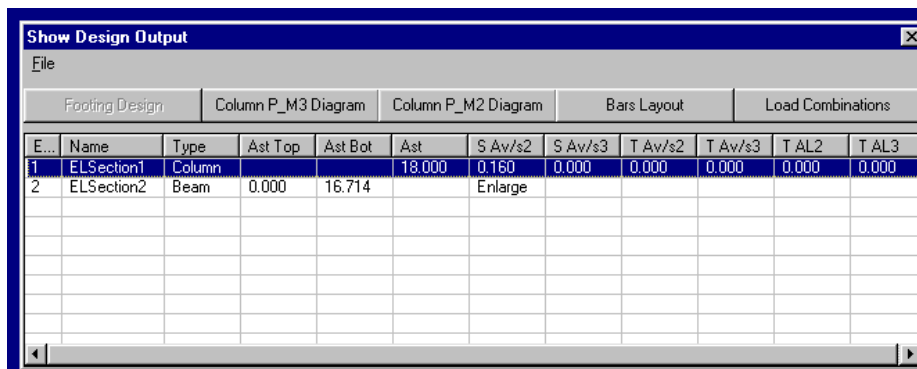

Figure 3.33 Show Design Output dialog

This dialog contains five command buttons. Each one runs a subroutine to achieve a specific work. The details of each subroutine will be illustrated later.

The Start Design submenu runs a subroutine for section design (**form name: MainForm, file: MDIForm.frm**) that runs the subroutine `Element_Design()` for each element. Figure 3.34 shows the flowchart of the main subroutine of this submenu and Figure 3.35 shows the flowchart of the subroutine `Element_Design()`.

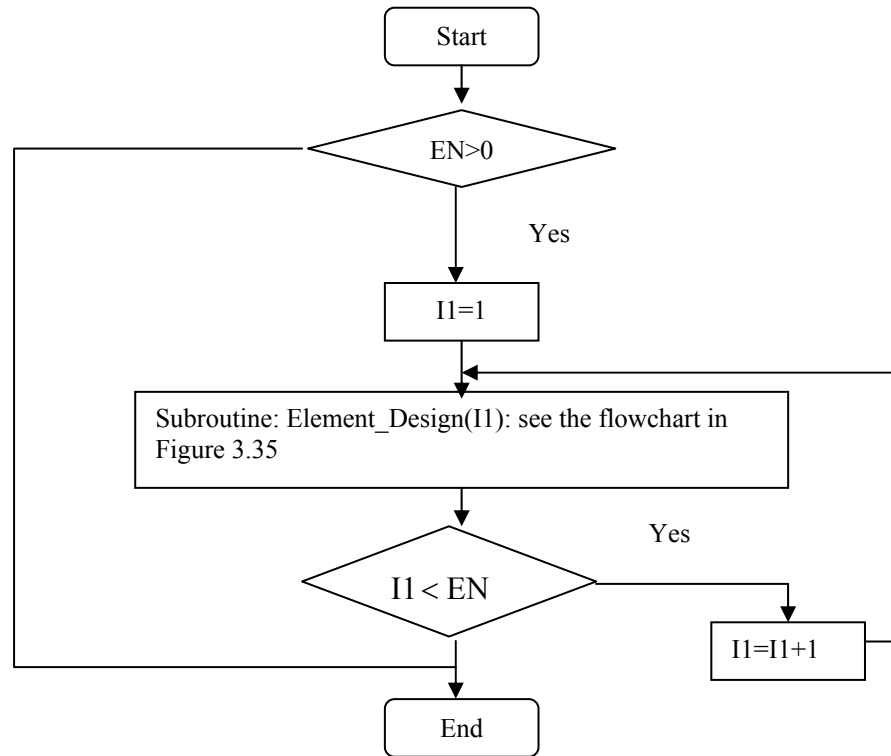

Figure 3.34 Flowchart for Start Design/Show Results submenu

The main variables in the flowchart in Figure 3.35 are defined as follows:

DesignSBArea= design shear reinforcement bar area

DesignMBArea= design main reinforcement bar area

Element_Beam_M33U(I1,I2)= the ultimate beam bending moment for the element section I1 and load combination I2

Element_Beam_V22U(I1,I2)= the ultimate beam shear force for the element section I1 and load combination I2

Element_Beam_T11U(I1,I2)= the ultimate beam torsional moment for the element section I1 and load combination I2

AstMin(I1)= minimum area of steel in a beam section

AsMax(I1)= maximum area of steel in a beam section

AsTop(I1,I2)= the required area of top steel in beam section in flexure design for element section I1 and load combination I2

AsBottom(I1,I2)= the required area of bottom steel in beam section in flexure design for element section I1 and load combination I2

BrTop(I1,I2)= the required top bars in beam section in flexure design for element section I1 and load combination I2

BrBottom(I1,I2)= the required bottom bars in beam section in flexure design for element section I1 and load combination I2

BeamAsMaxTop(I1)= maximum area of top steel from all load combinations

BeamAsMaxBottom(I1)= maximum area of bottom steel from all load combinations

BeamVc(I1,I2)= the concrete shear capacity, V_c for beam element section I1 and load combination I2

BeamVs(I1,I2)= the steel shear capacity, V_s for beam element section I1 and load combination I2

BeamVn(I1,I2)= the nominal shear capacity, V_n for beam element section I1 and load combination I2

BeamVsMax(I1,I2)= the maximum shear capacity of shear steel, V_s for beam element section I1 and load combination I2

BeamStressA(I1,I2)= the applied stress due to shear and torsion forces on beam element section I1 and load combination I2 (needed for checking section adequacy for shear and torsion computations)

BeamStressB(I1,I2)= the capacity stress to resist shear and torsion forces on beam element section I1 and load combination I2 (needed for checking section adequacy for shear and torsion computations)

BeamAvsShear(I1)= the required shear reinforcement for element section I1

BeamAvsTorsion(I1)= the required transverse torsion reinforcement for beam element section I1

BeamAvsMin(I1)= the minimum transverse reinforcement for beam element section I1

BeamAvsTotal(I1)= the required transverse reinforcement for shear and torsion for beam element section I1

BeamTorsionAl(I1)= the required longitudinal steel for torsion in beam element section I1

BeamTorsionAlmin(I1)= the minimum value of longitudinal steel for torsion in beam element section I1

BeamSpacing(I1)= the required stirrups spacing in beam element section I

BeamShearEnlargeSection(I1,I2)= identifier for beam section enlargement due to shear force. 1: should be enlarged. 2: should not

BeamTransverseSpacing(I1)= spacing of stirrups in beam section due to shear and torsion

BeamTorsionSteel(I1)= longitudinal steel in beam section due to torsion

BeamTransverseSteel(I1)= A_v/s due to shear and torsion

BeamShearAvs2(I1)= A_v/s due to shear

BeamTorsionAvs2(I1)= A_v/s due to torsion

Element_Column_F11Uns(I1,I2)= the ultimate axial force due to non sway loads for column element I1 and load combination I2

Element_Column_TopM33Uns(I1,I2)= the ultimate bending moment in the major direction at top of column due to non sway loads for element I1 and load combination I2

Element_Column_BottomM33Uns(I1,I2)= the ultimate bending moment in the major direction at bottom of column due to non sway loads for element I1 and load combination I2

Element_Column_M33Uns(I1,I2)= the ultimate bending moment in the major direction at a point of column height due to non sway loads for element I1 and load combination I2

Element_Column_F11Us(I1,I2)= the ultimate axial force due to sway loads for column element I1 and load combination I2

Element_Column_TopM33Us(I1,I2)= the ultimate bending moment in the major direction at top of column due to sway loads for element I1 and load combination I2

Element_Column_BottomM33Us(I1,I2)= the ultimate bending moment in the major direction at bottom of column due to sway loads for element I1 and load combination I2

Element_Column_M33Us(I1,I2)= the ultimate bending moment in the major direction at a point of column height due to sway loads for element I1 and load combination I2

Element_Column_F11U (I1,I2)= the ultimate axial force for column element I1 and load combination I2

Element_Column_TopM33U (I1,I2)= the ultimate bending moment in the major direction at top end for column element I1 and load combination I2

Element_Column_BottomM33U (I1,I2)= the ultimate bending moment in the major direction at bottom end for column element I1 and load combination I2

Element_Column_M33U (I1,I2)= the ultimate bending moment in the major direction at a point of column height for column element I1 and load combination I2

Betad= the ratio of the factored axial dead load to factored total axial load

ColumnDesignPcr3(I1,I2)= the critical axial load on column section in the major direction

Column_EnlargeSection(I1,I2)= identifier to enlarge column section. 1: the section should be enlarged. 2: should not

ColumnEnlargeID(I1,I2)= identifier to the cause of column section enlargement.

0: section should not be enlarged

1: if the ultimate applied axial force is larger than 0.75 Pcr; the critical column axial capacity

3: if the ultimate applied axial force is larger than the column maximum axial capacity

4: if the ultimate applied axial force is less than the column maximum tension capacity

5: if the biaxial factor is larger than one

ColumnDesignMu3(I1,I2)= the column design moment in the major direction for element I1 and load combination I2

ColumnDesignPu(I1,I2)= the column design axial force for element I1 and load combination I2

ColumnDesignMmin3(I1,I2)= the column design minimum moment in the major direction for element I1 and load combination I2

ColumnDesignCm3(I1,I2)= the column design moment factor, C_m in the major direction for element I1 and load combination I2

ColumnDesignLu3(I1,I2)= the column design length in the major direction for element I1 and load combination I2

ColumnDesignK3(I1,I2)= the column design effective length factor, k in the major direction for element I1 and load combination I2

ColumnDesignDns3(I1,I2)= the column design non sway factor, δ_{ns} in the major direction for element I1 and load combination I2

ColumnDesignDs3(I1,I2)= the column design sway factor, δ_s in the major direction for element I1 and load combination I2

ColumnDesignBetad(I1,I2)= the column ratio of factored axial dead load to factored total axial load for element I1 and load combination I2

ColumnDesignAst(I1,I2)= required area of steel in column element I1 and load combination I2

ColumnDesignBars33(I1,I2)= required number of bars in the major direction of column element I1 and load combination I2

ColumnDesignBars22(I1,I2)= required number of bars in the minor direction of column element I1 and load combination I2

ColumnDesignBars (I1,I2)= required number of bars for column element I1 and load combination I2

ColumnDesignRatio(I1,I2)= required steel ratio for column element I1 and load combination I2

ColumnDesignBarDiam(I1,I2)= required bar diameter for column element I1 and load combination I2

ColumnDesignPumax(I1,I2)= the design maximum axial load capacity, P_d

ColumnDesignPumin(I1,I2)= the design minimum axial load capacity, P_t

ColumnRatio(I1)= required steel ratio for column section element I1

ColumnBarDiam(I1)= required bar diameter for column section element I1

ColumnBars33(I1)= required number of bars in the major direction for column section element I1

ColumnBars22(I1)= required number of bars in the minor direction for column section element I1

ColumnBars (I1)= required number of bars for column section element I1

ColumnAst(I1)= required area of steel for column section element I1

Element_Column_T11U(I1,I2)= the ultimate torsional moment for column element I1 and load combination I2

Element_Column_V22U(I1,I2)= the ultimate shear force for column element I1 and load combination I2

Element_Column_V22DBU(I1,I2)= the ultimate shear force with doubling the seismic loads for column element I1 and load combination I2

Element_Column_V22USeismic(I1,I2)= the ultimate shear force from the seismic loads for column element I1 and load combination I2

ZeroVc= identifier for $V_c=0$ if the ultimate seismic shear forces are larger than half the total ultimate shear force. 1: $V_c=0$, 0: V_c does not equal zero

ColumnTu2(I1,I2)= the torsional moment in major direction for column element I1 and load combination I2

ColumnVu2(I1,I2)= the shear force in major direction for column element I1 and load combination I2

ColumnVp2(I1,I2)= the shear force due to end moment capacities in major direction for column element I1 and load combination I2

ColumnVc2(I1,I2)= the shear force capacity, V_c in major direction for column element I1 and load combination I2

ColumnVs2(I1,I2)= the shear force capacity due to reinforcement in major direction for column element I1 and load combination I2

ColumnVn2(I1,I2)= the nominal shear force in major direction for column element I1 and load combination I2

ColumnVsMax2(I1,I2)= the maximum shear force due to reinforcement in major direction for column element I1 and load combination I2

ColumnAvsShear2(I1,I2)= the shear reinforcement A_v/s in major direction for column element I1 and load combination I2

ColumnAvsTorsion2(I1,I2)= the torsion reinforcement A_t/s in major direction for column element I1 and load combination I2

ColumnAvsMin2(I1,I2)= the minimum shear reinforcement A_v/s in major direction for column element I1 and load combination I2

ColumnAvsTotal2(I1,I2)= the shear and torsion reinforcement A_v/s in major direction for column element I1 and load combination I2

ColumnStressA2(I1,I2)= the shear stress due to applied shear and torsion in major direction for column element I1 and load combination I2 used in shear and torsion design

ColumnStressB2(I1,I2)= the shear stress due to section capacity in major direction for column element I1 and load combination I2 used in shear and torsion design

ColumnAl2(I1,I2)= the torsion longitudinal reinforcement in major direction for column element I1 and load combination I2

ColumnAlmin(I1,I2)= the torsion minimum longitudinal reinforcement in major direction for column element I1 and load combination I2

ColumnTuCapacity2(I1,I2)= the concrete section torsion capacity in major direction for column element I1 and load combination I2

ColumnFSpacing2(I1,I2)= the spacing of stirrups for shear and torsion in major direction for column element I1 and load combination I2

ColumnTransverseSpacing2(I1)= the spacing of stirrups in major direction for column element I1

ColumnTransverseSteel2(I1)= the transverse steel A_v/s in major direction for column element I1

ColumnShearAvs2(I1)= the transverse steel A_v/s due to shear in major direction for column element I1

ColumnTorsionAvs2(I1)= the transverse steel A_v/s due to torsion in major direction for column element I1

ColumnTorsionSteel2(I1)= the torsional longitudinal steel in major direction for column element I1

In the minor direction of column, the same variables for shear are used but using 3 instead of 2

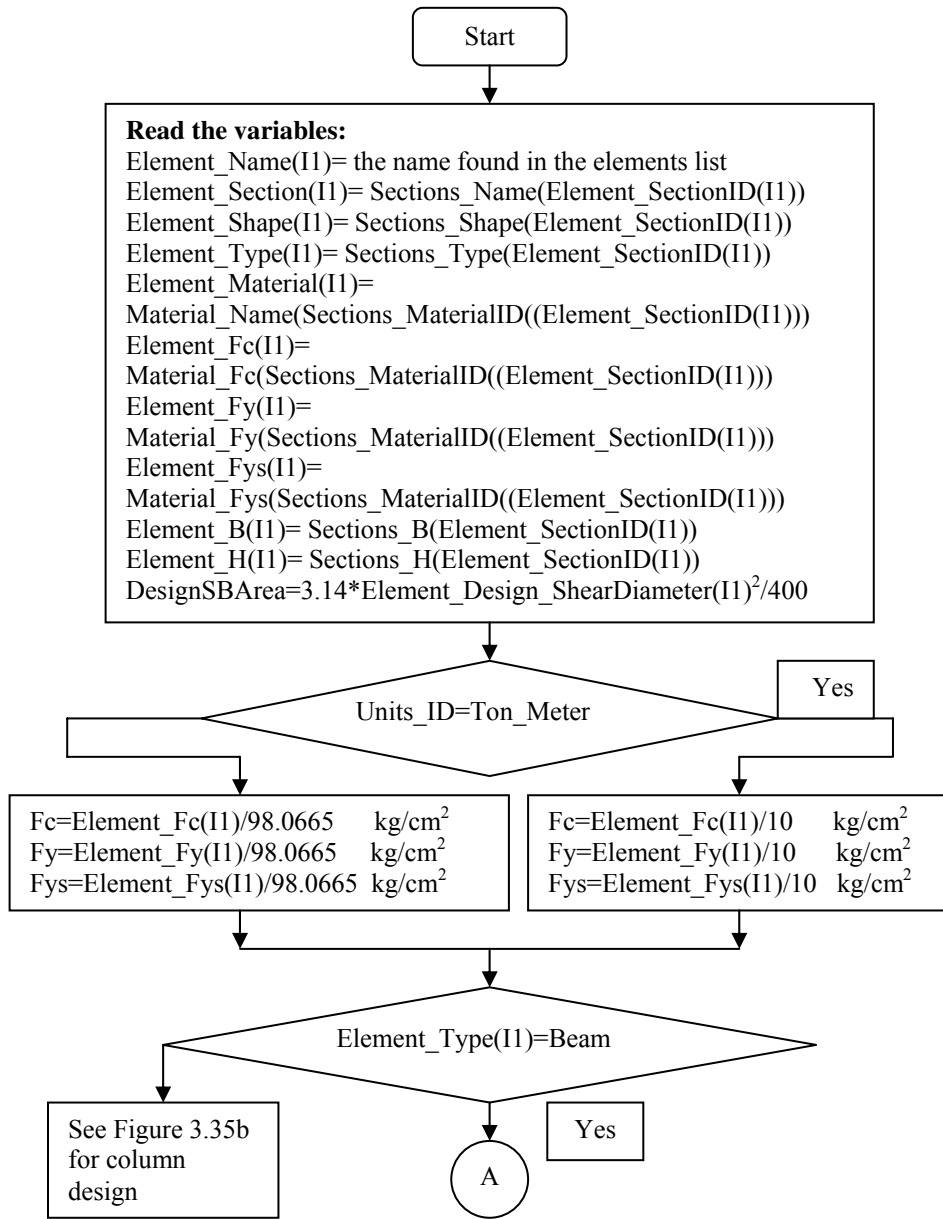

Figure 3.35a Flowchart of the subroutine Element_Design(I1)

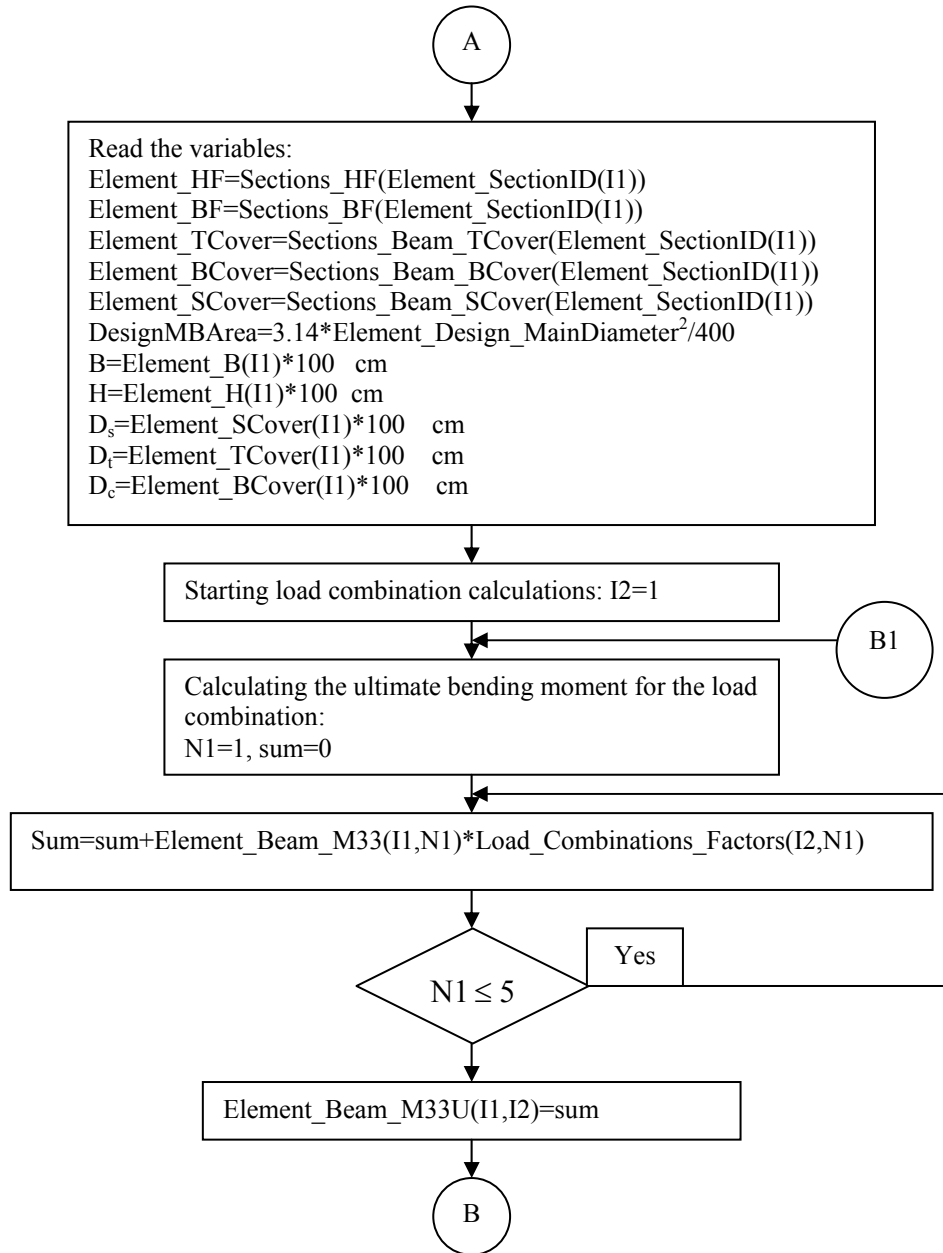

Figure 3.35a continued

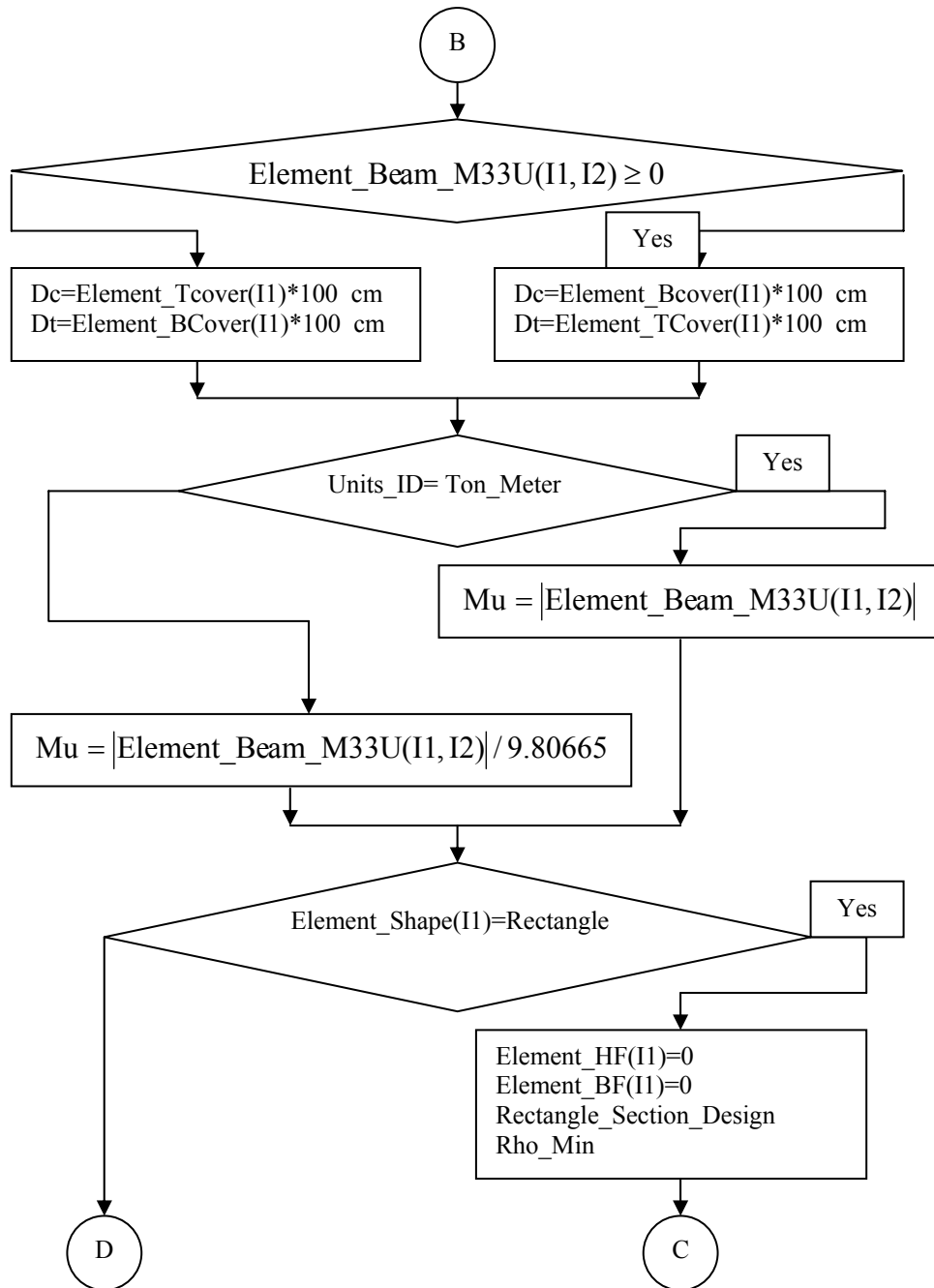

Figure 3.35a continued

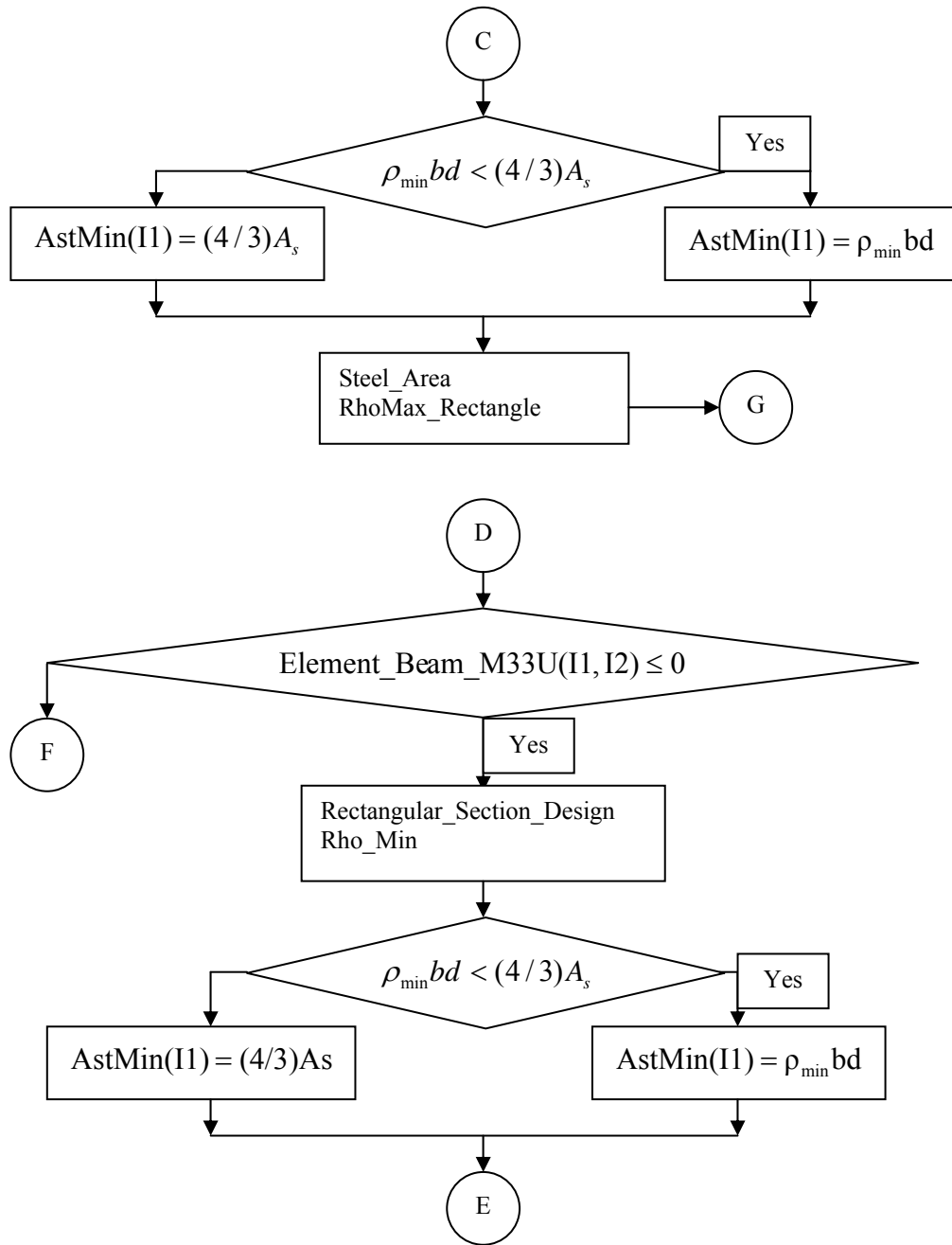

Figure 3.35a continued

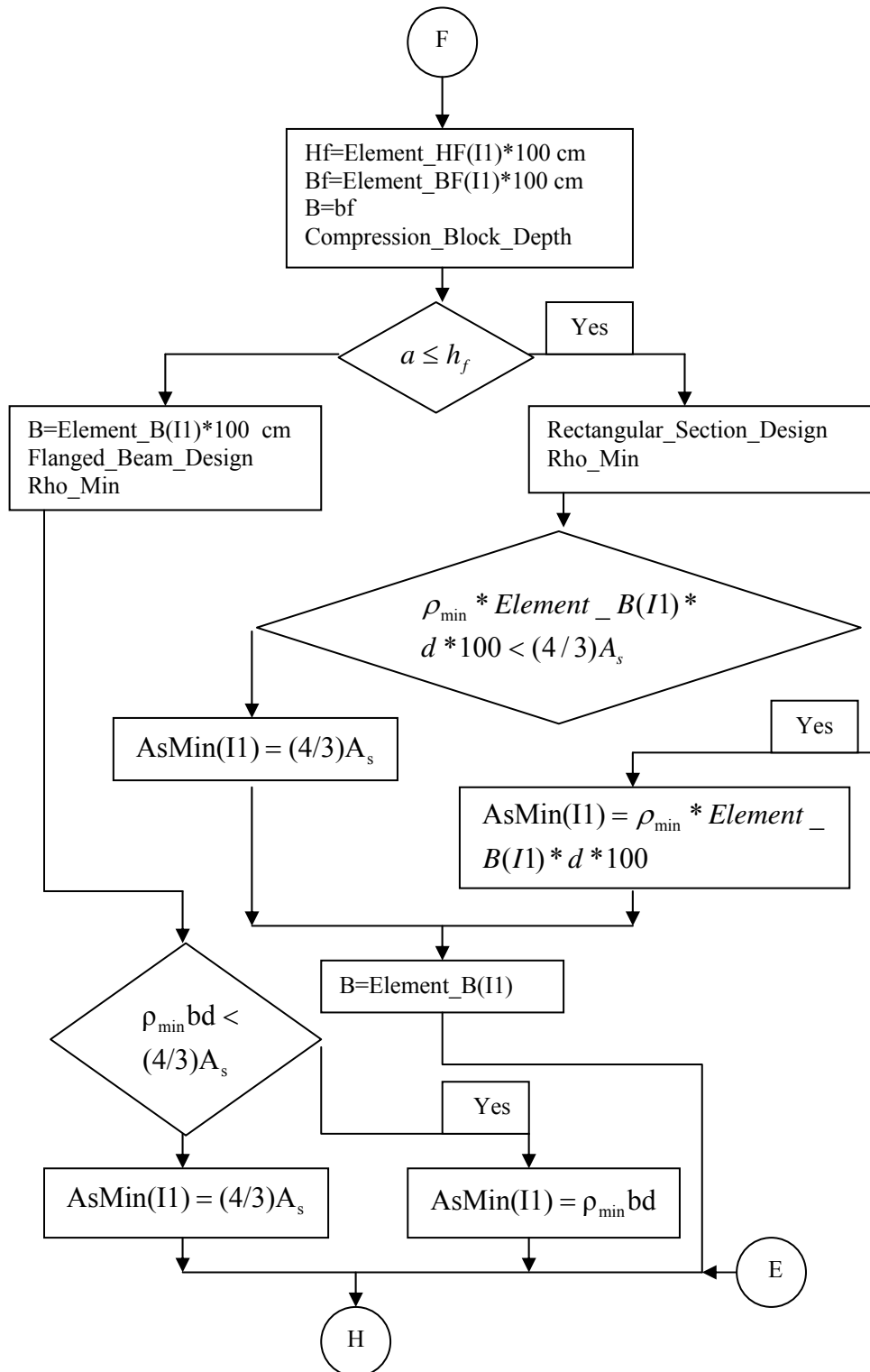

Figure 3.35a continued

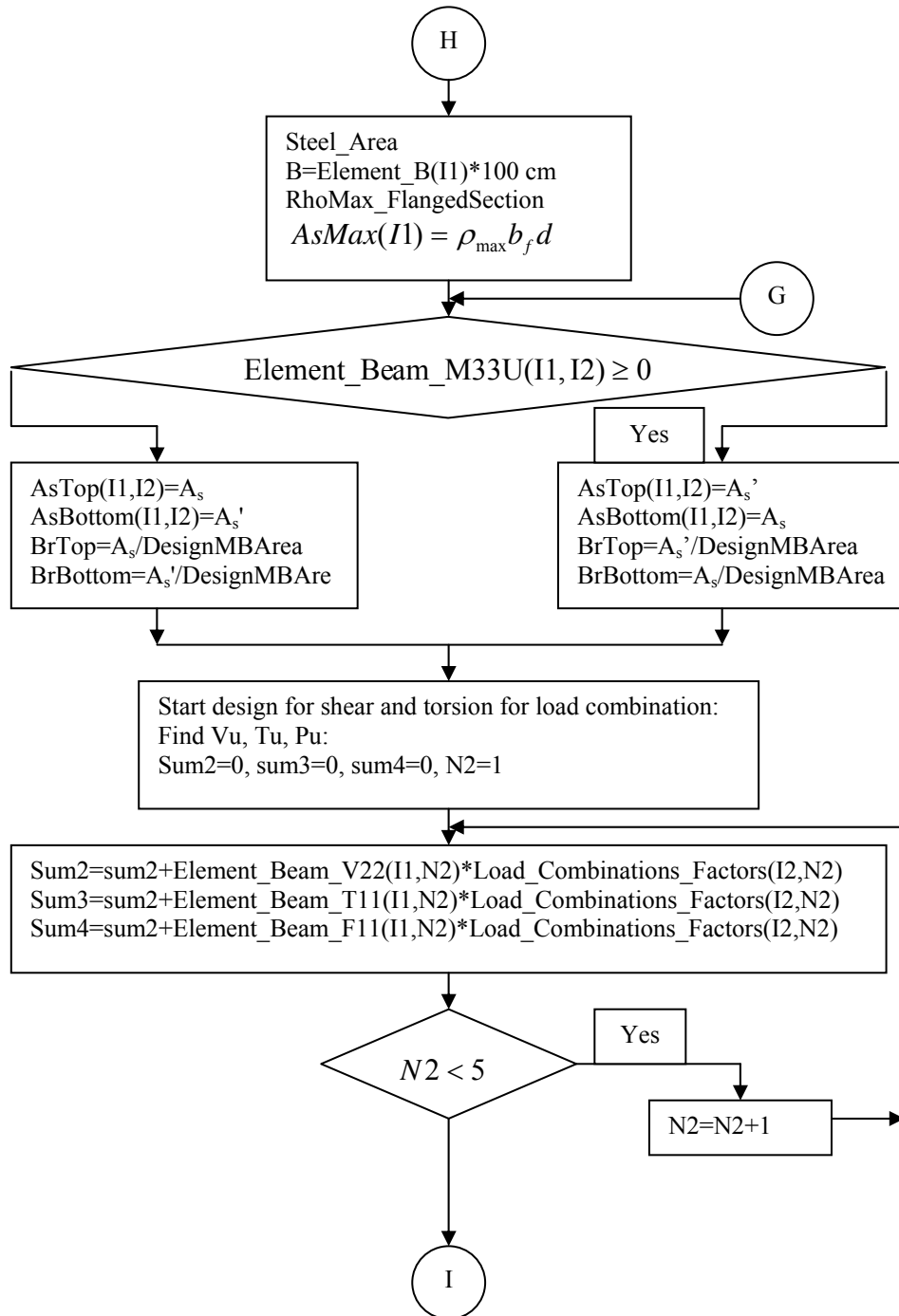

Figure 3.35a continued

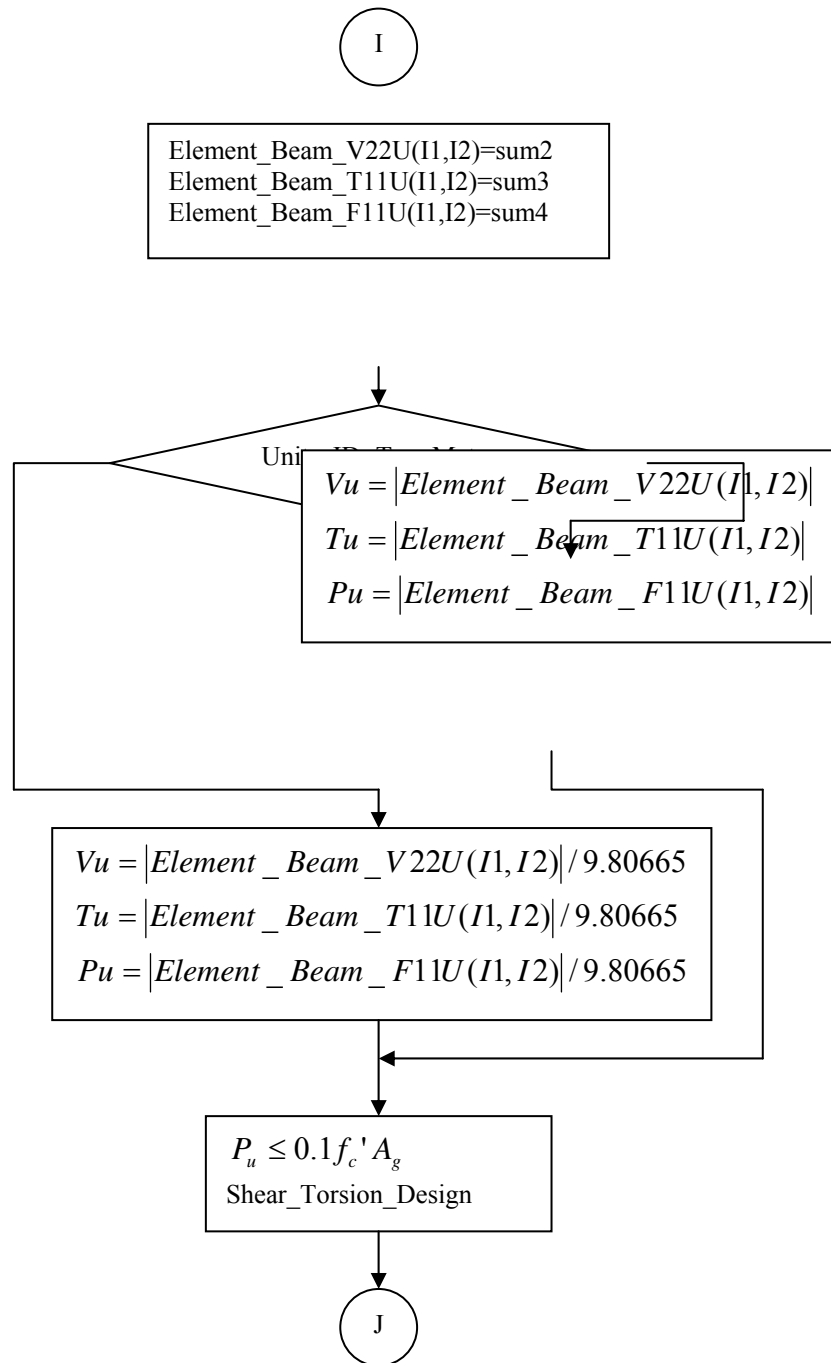

Figure 3.35a continued

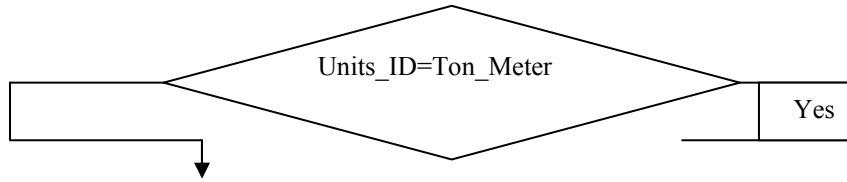

Figure 3.35a continued

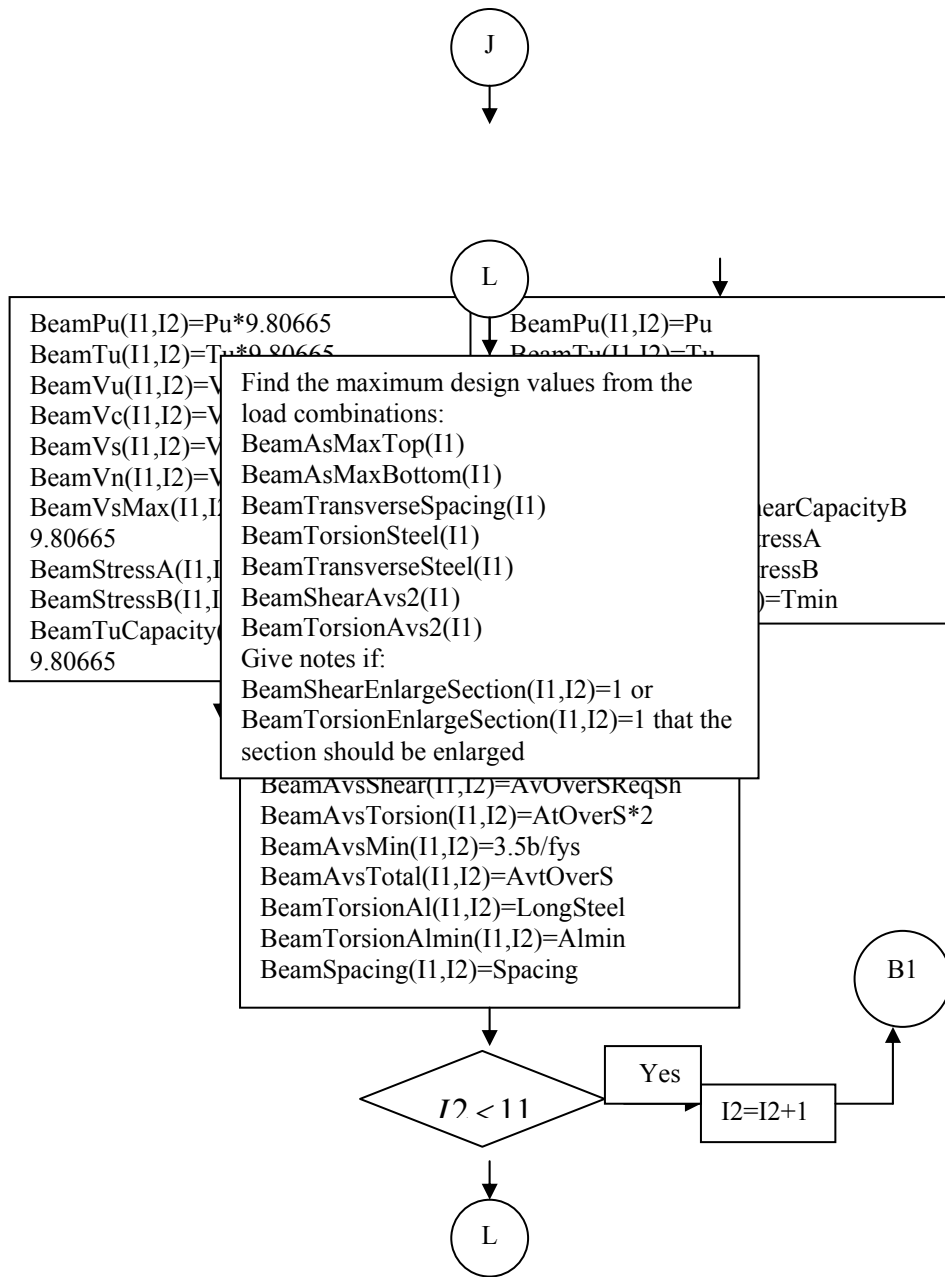

Figure 3.35a continued

From Figure 3.35a

Read variables:

Element_Cover(I1)=

Sections_Column_Cover(Element_SectionID(I1))

Element_Column_Length(I1)=

Sections_Column_Length(Element_SectionID(I1))

Figure 3.35b flowchart of the subroutine Element_Design(I1), column design for axial and bending

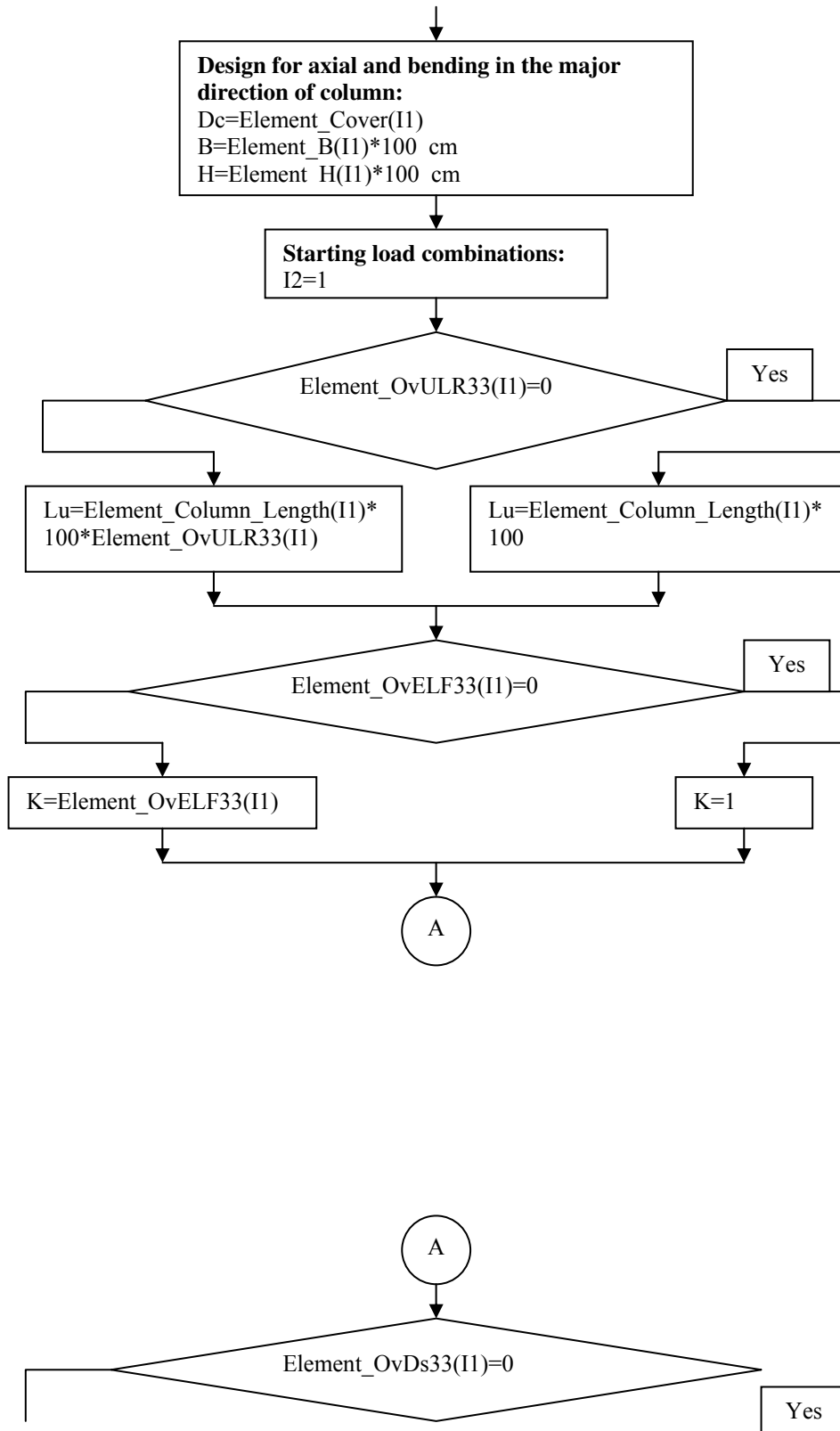

Figure 3.35b continued

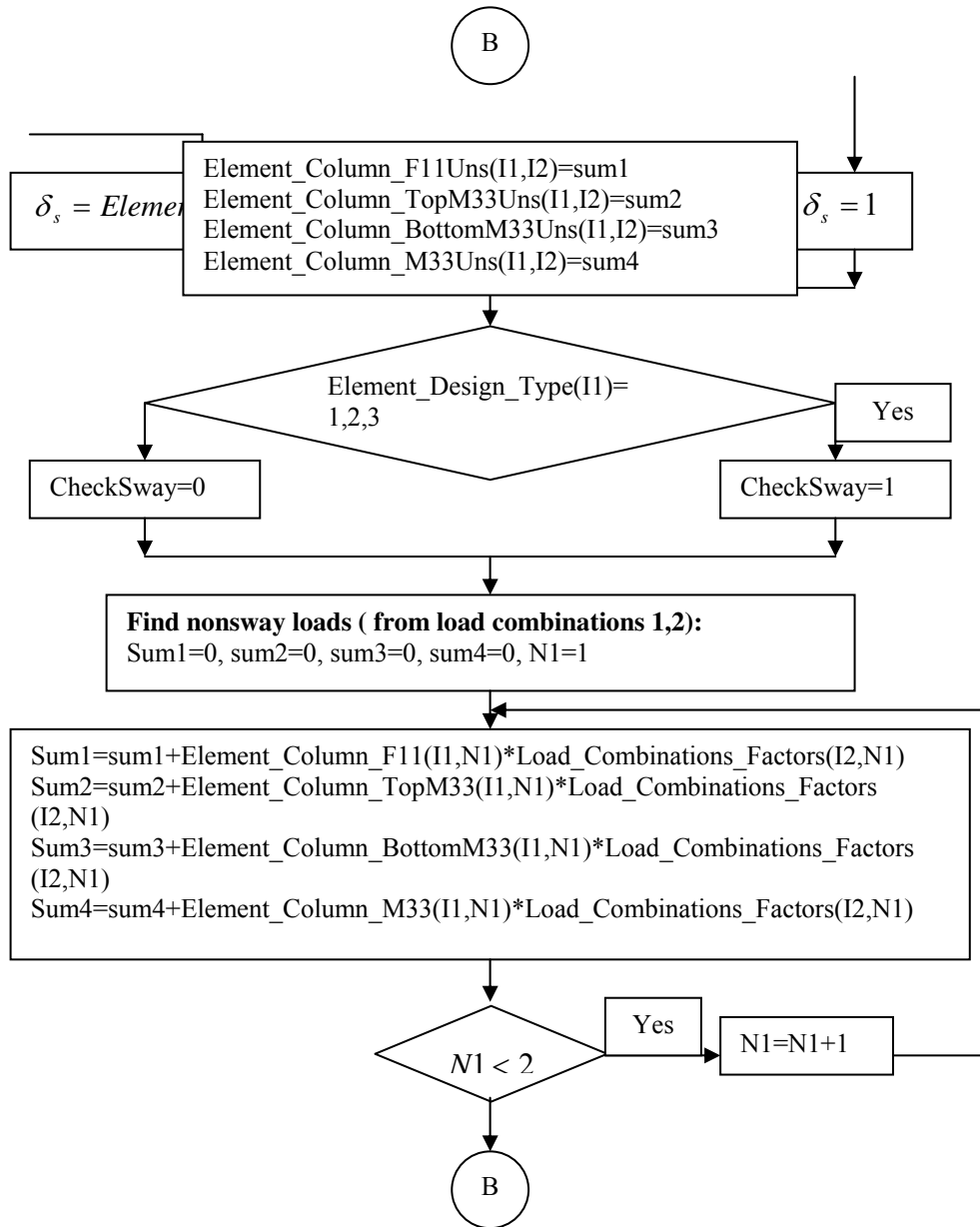

Figure 3.35b continued

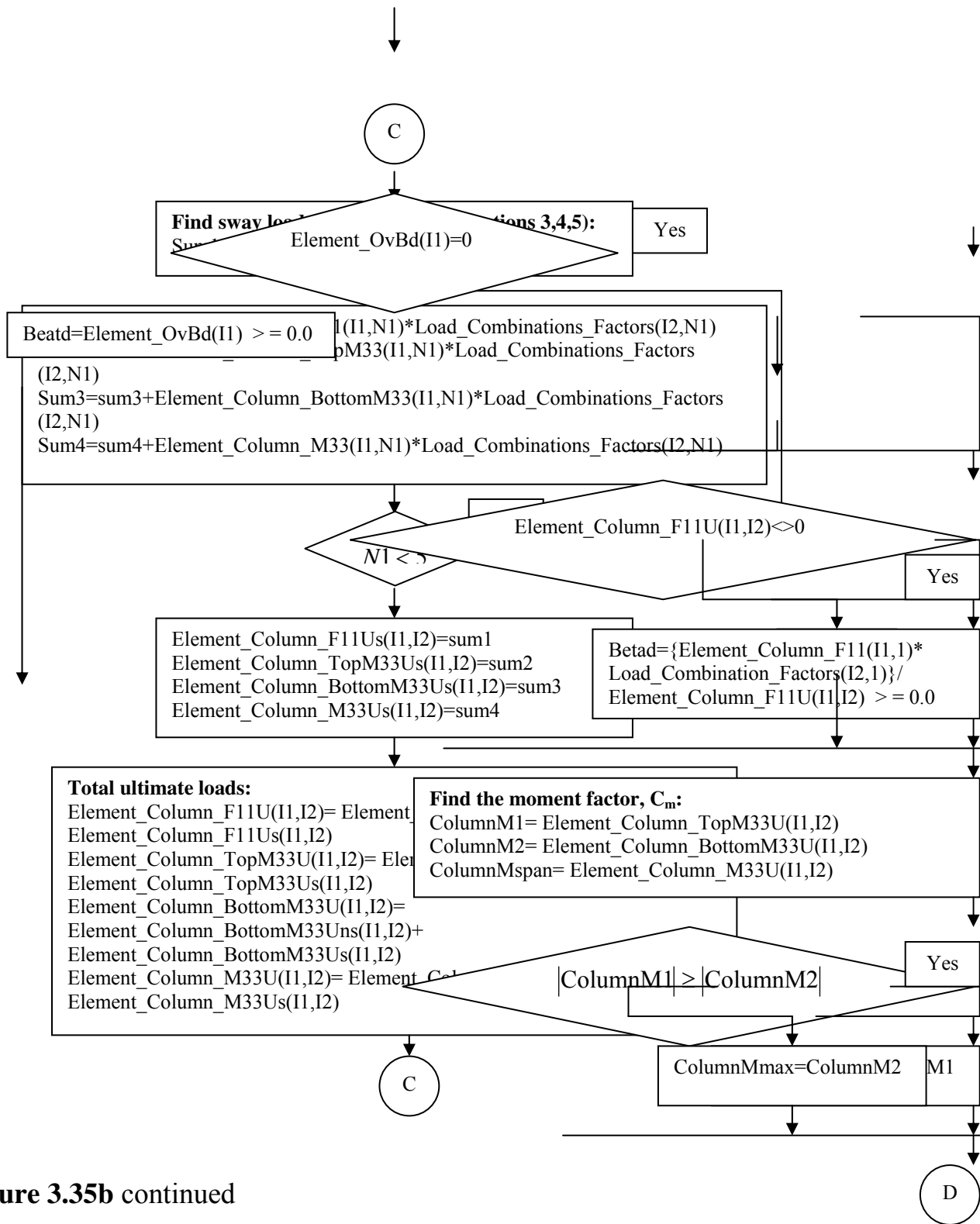

Figure 3.35b continued

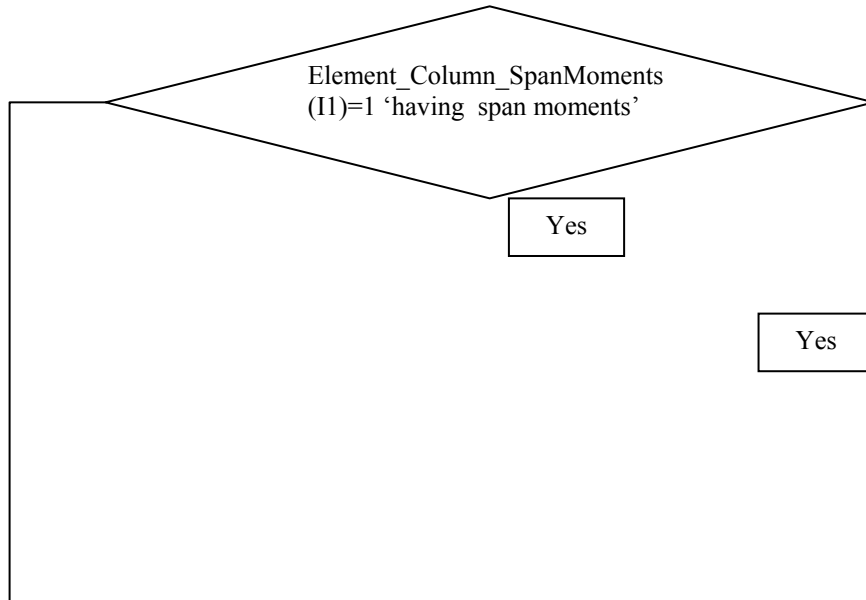

Figure 3.35b continued

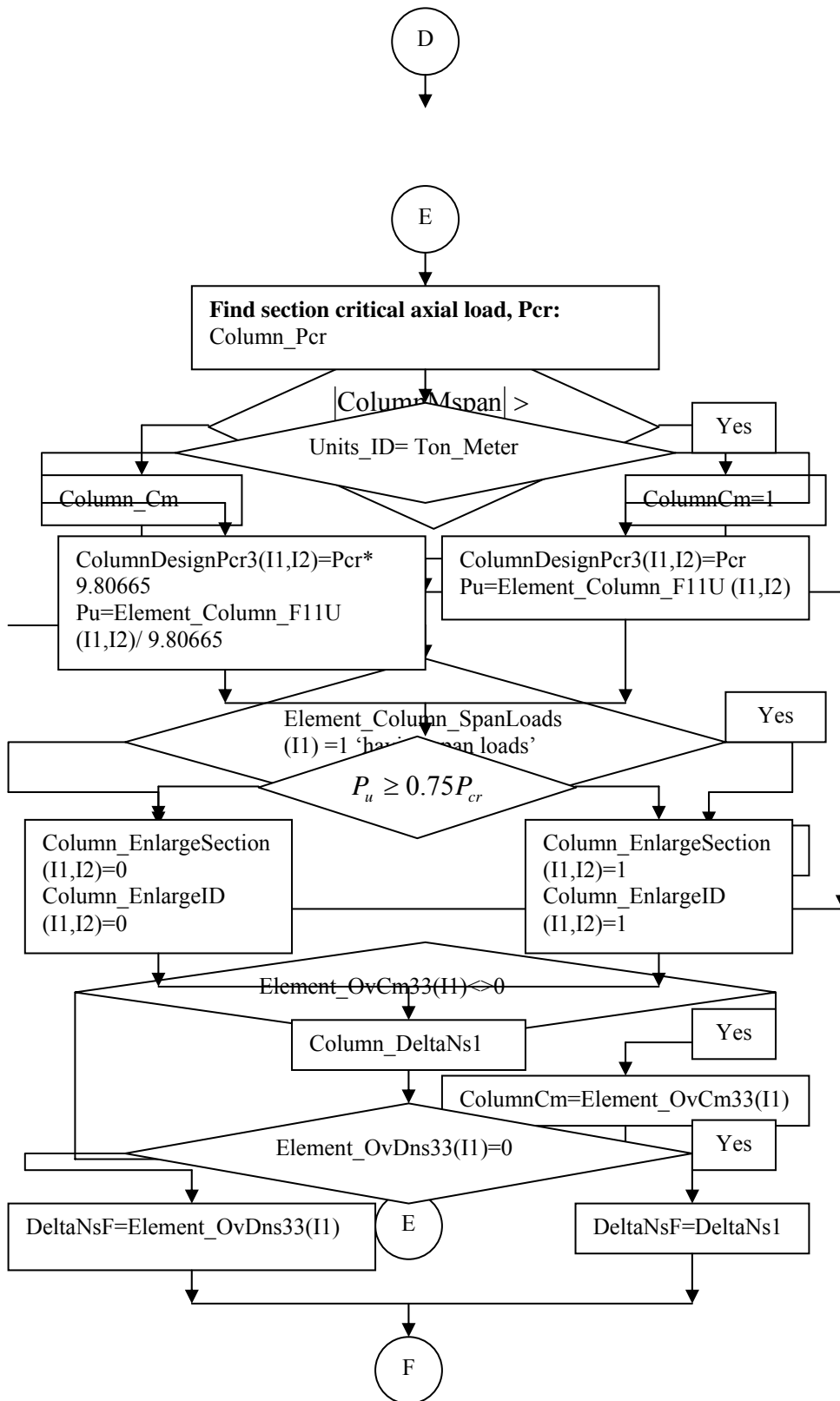

Figure 3.35b continued

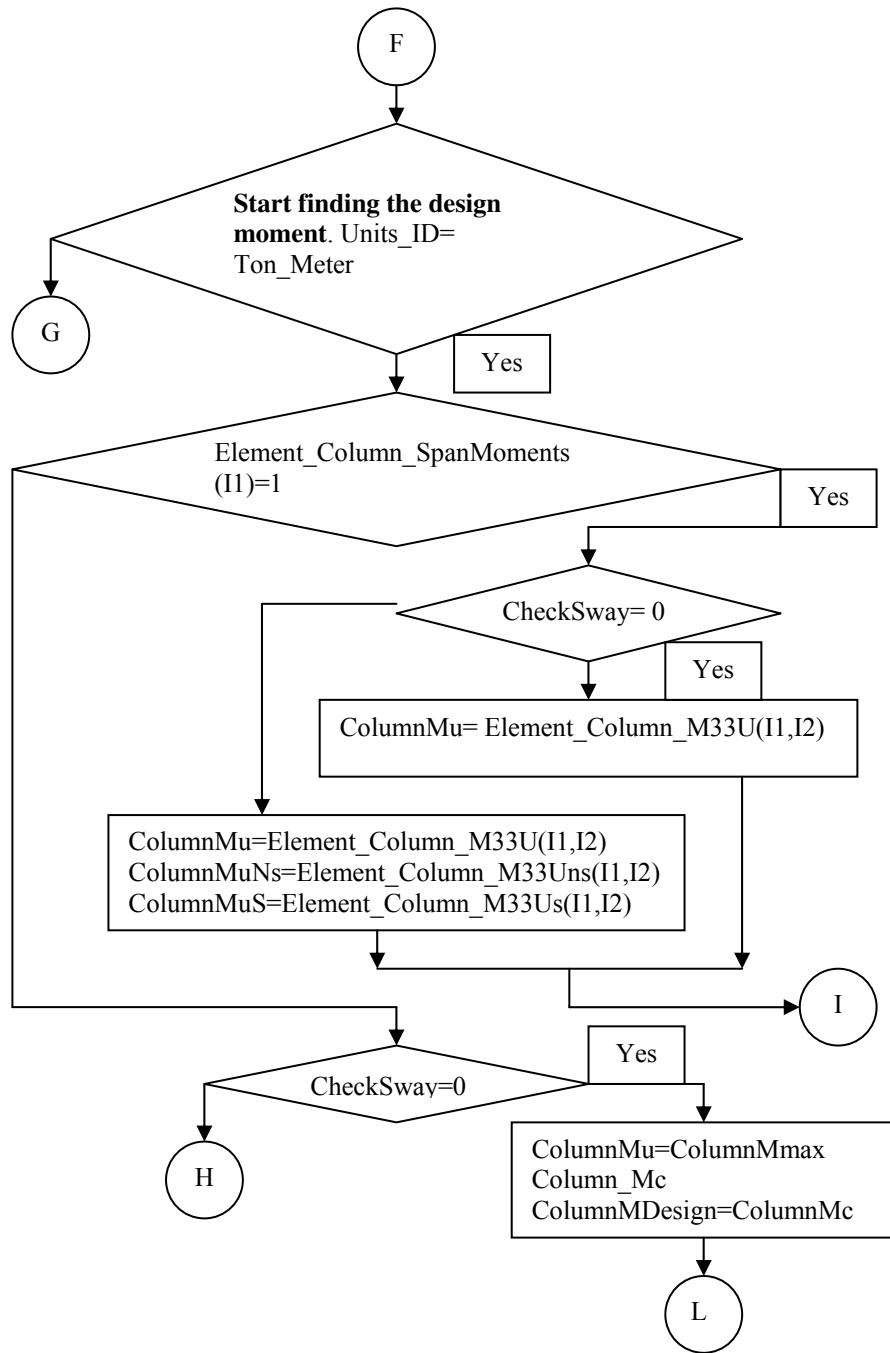

Figure 3.35b continued

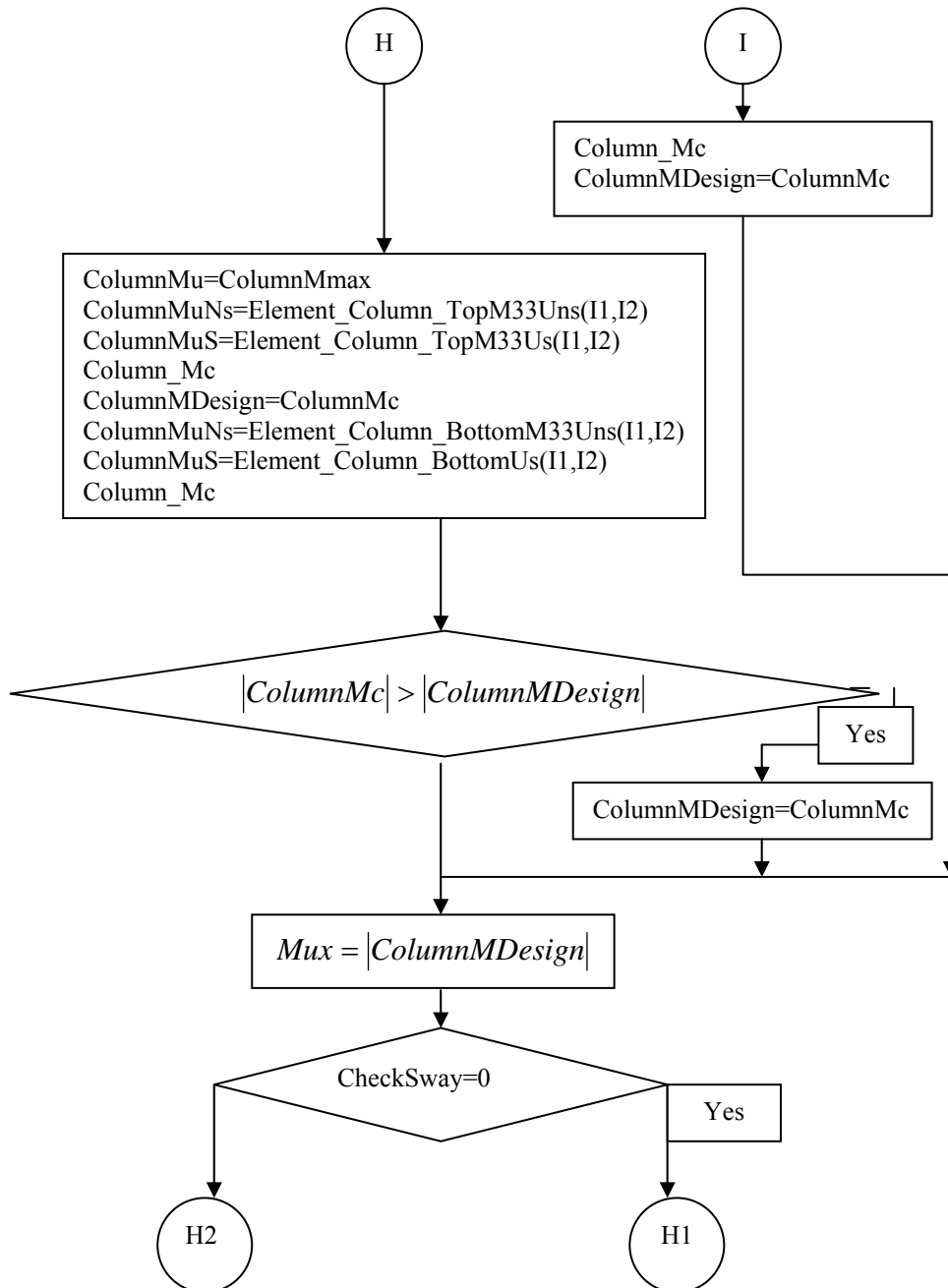

Figure 3.35b continued

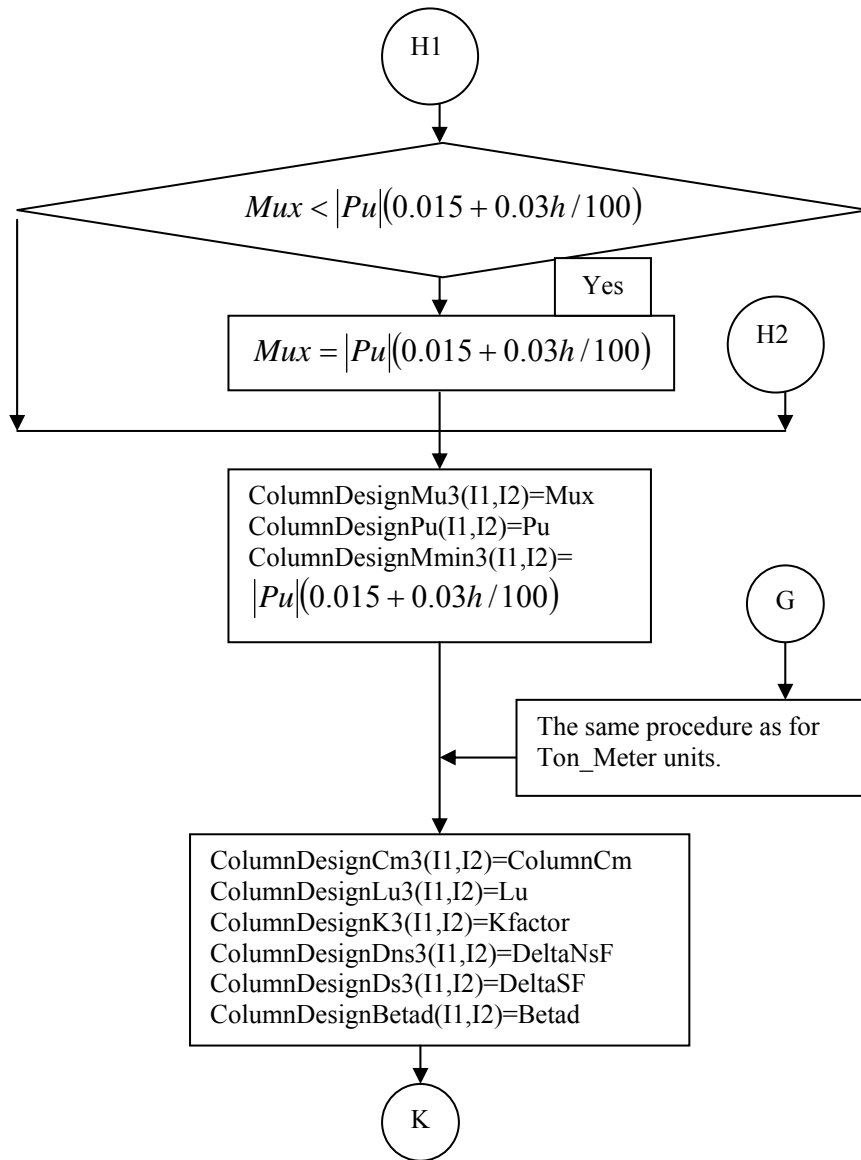

Figure 3.35b continued

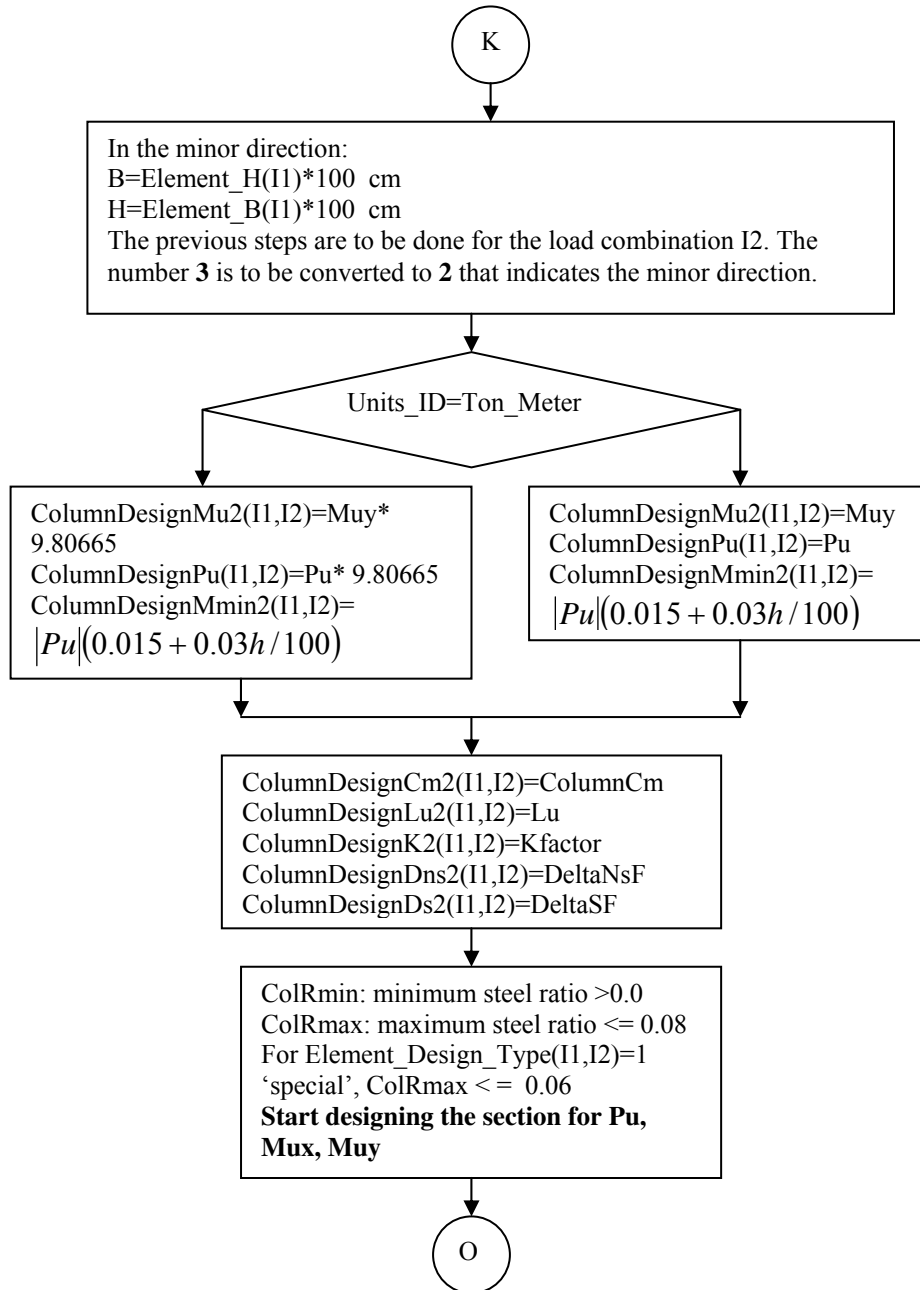

Figure 3.35b continued

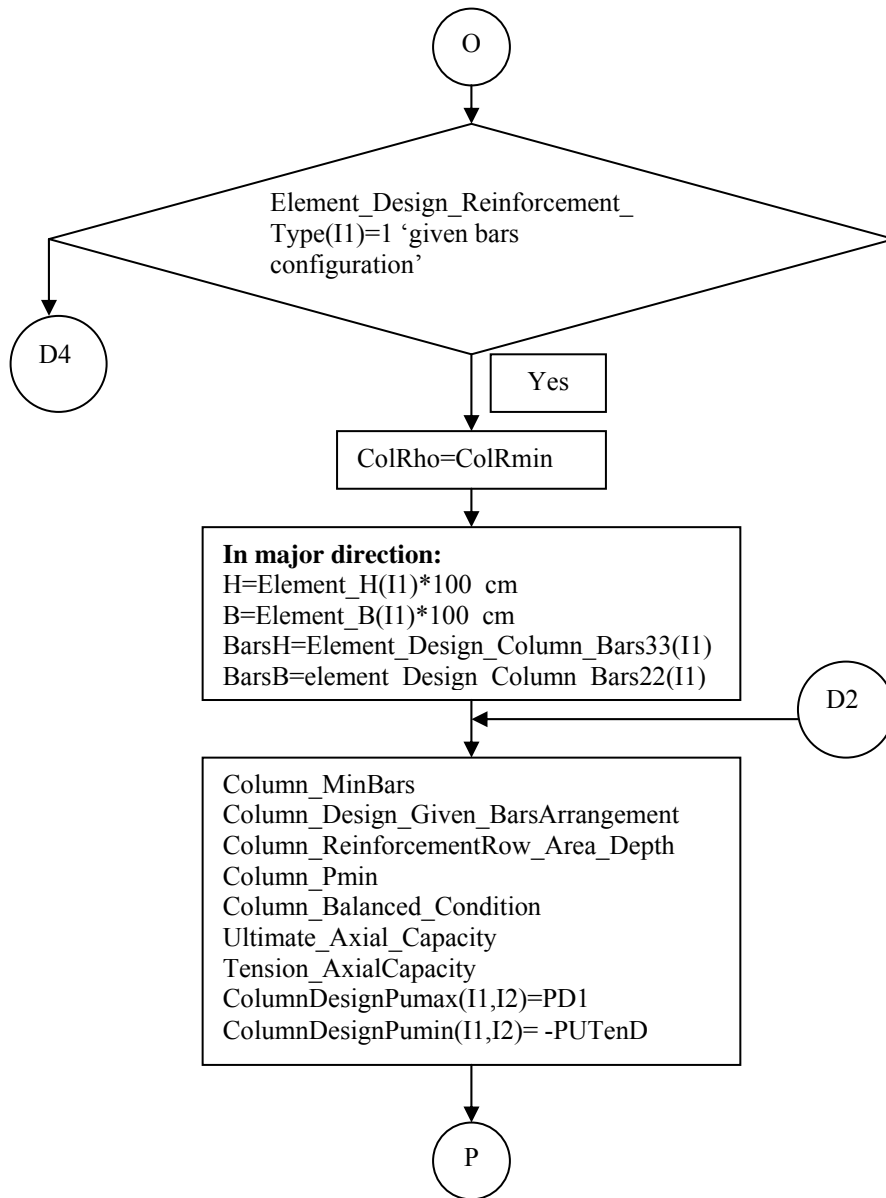

Figure 3.35b continued

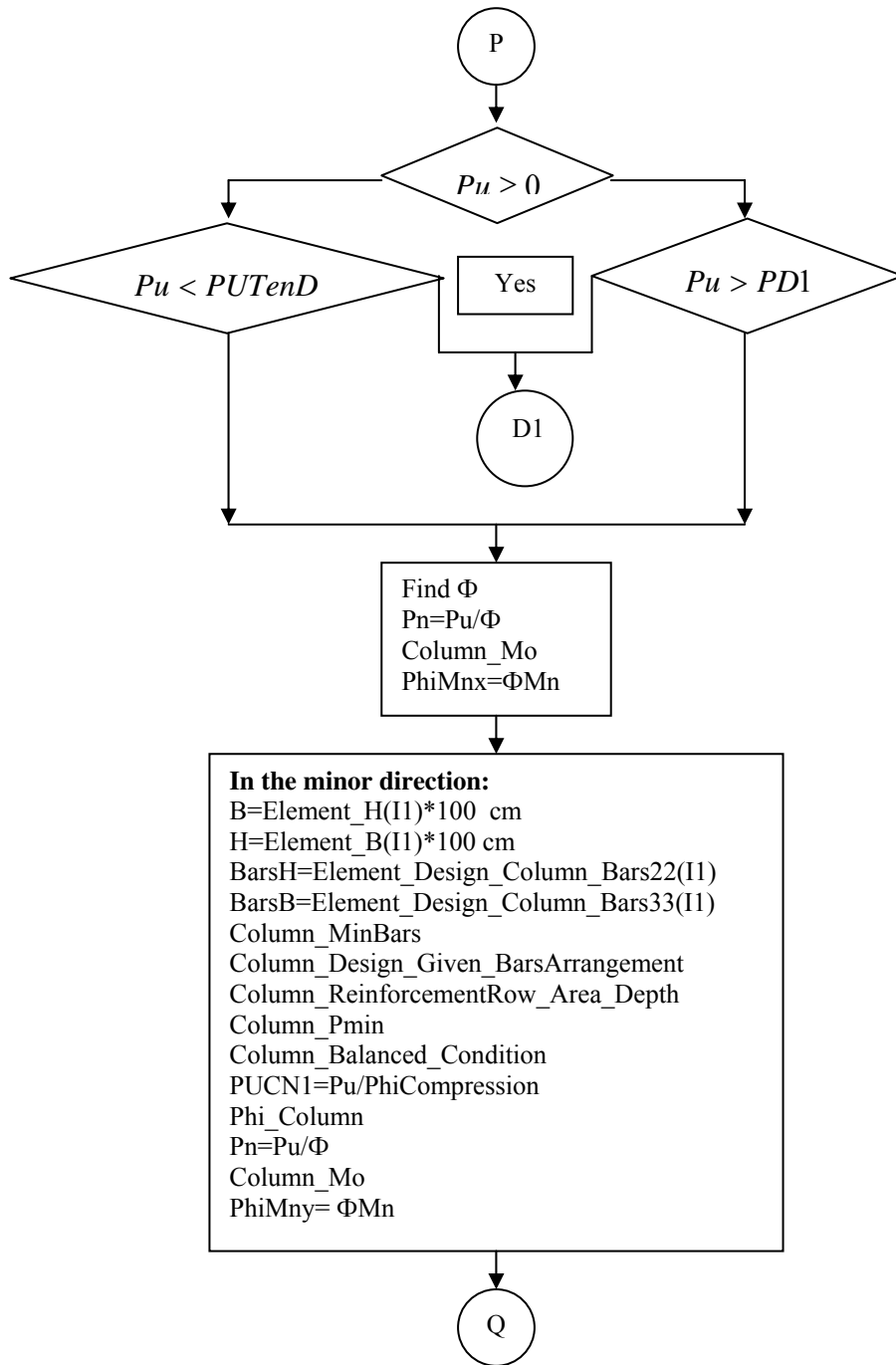

Figure 3.35b continued

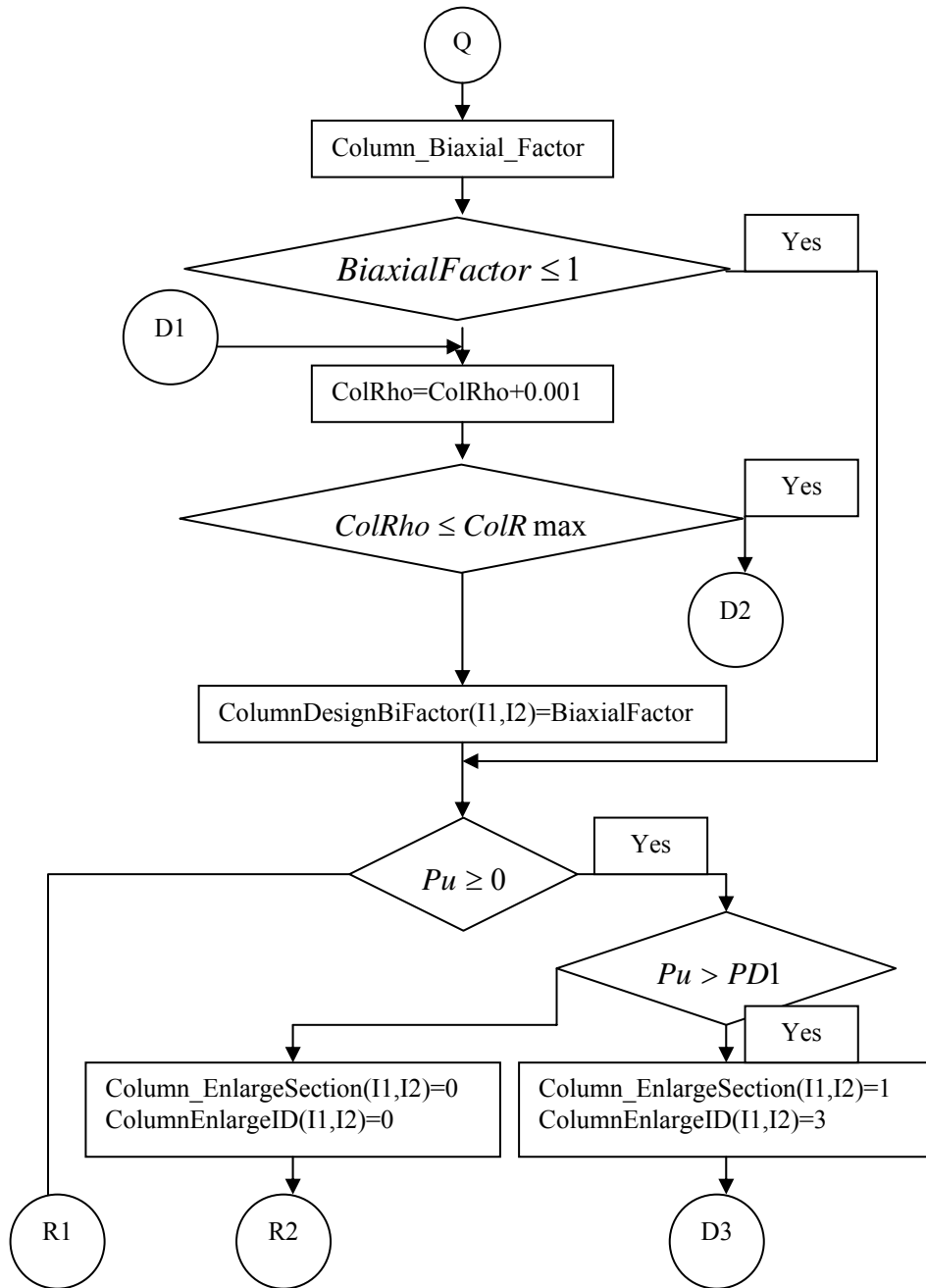

Figure 3.35b continued

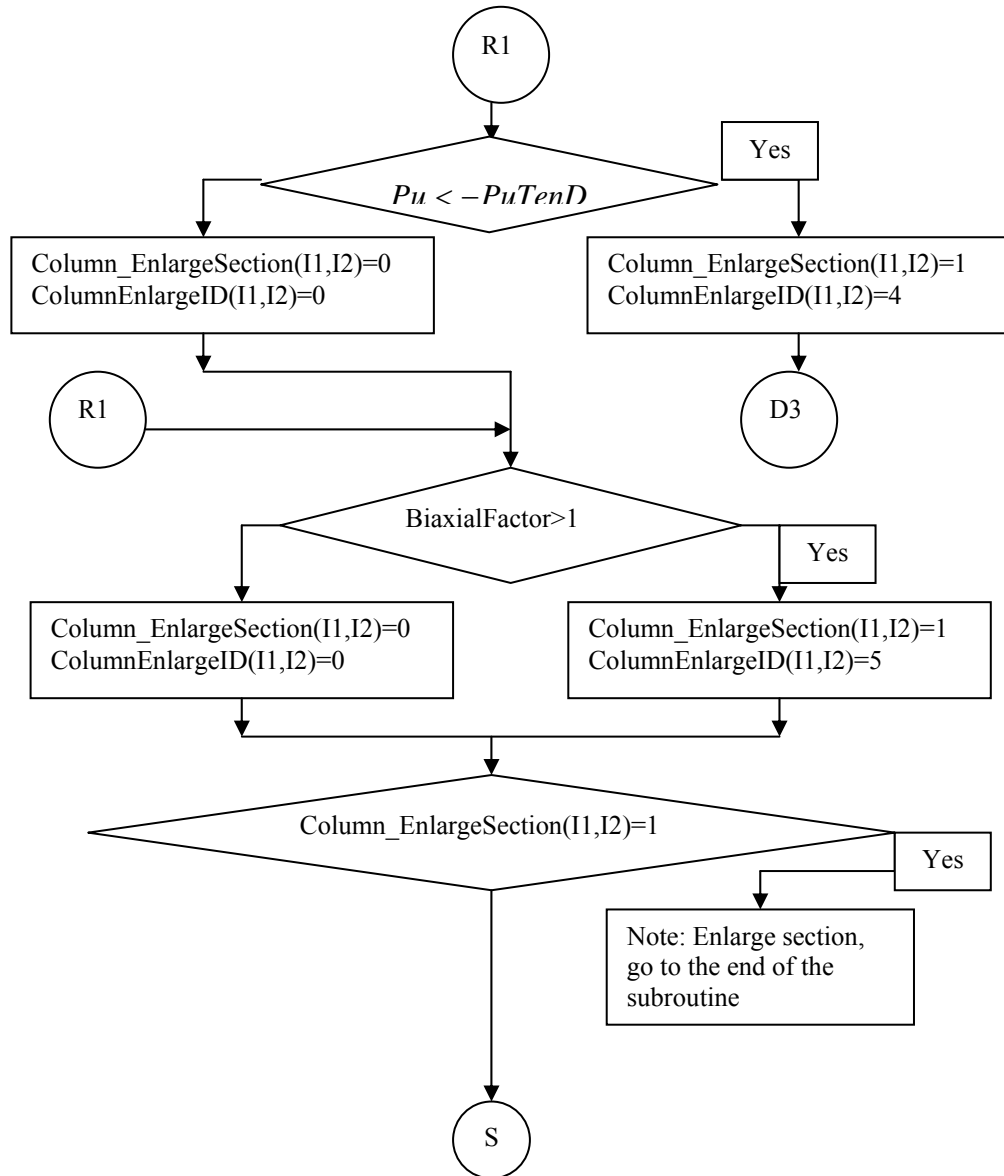

Figure 3.35b continued

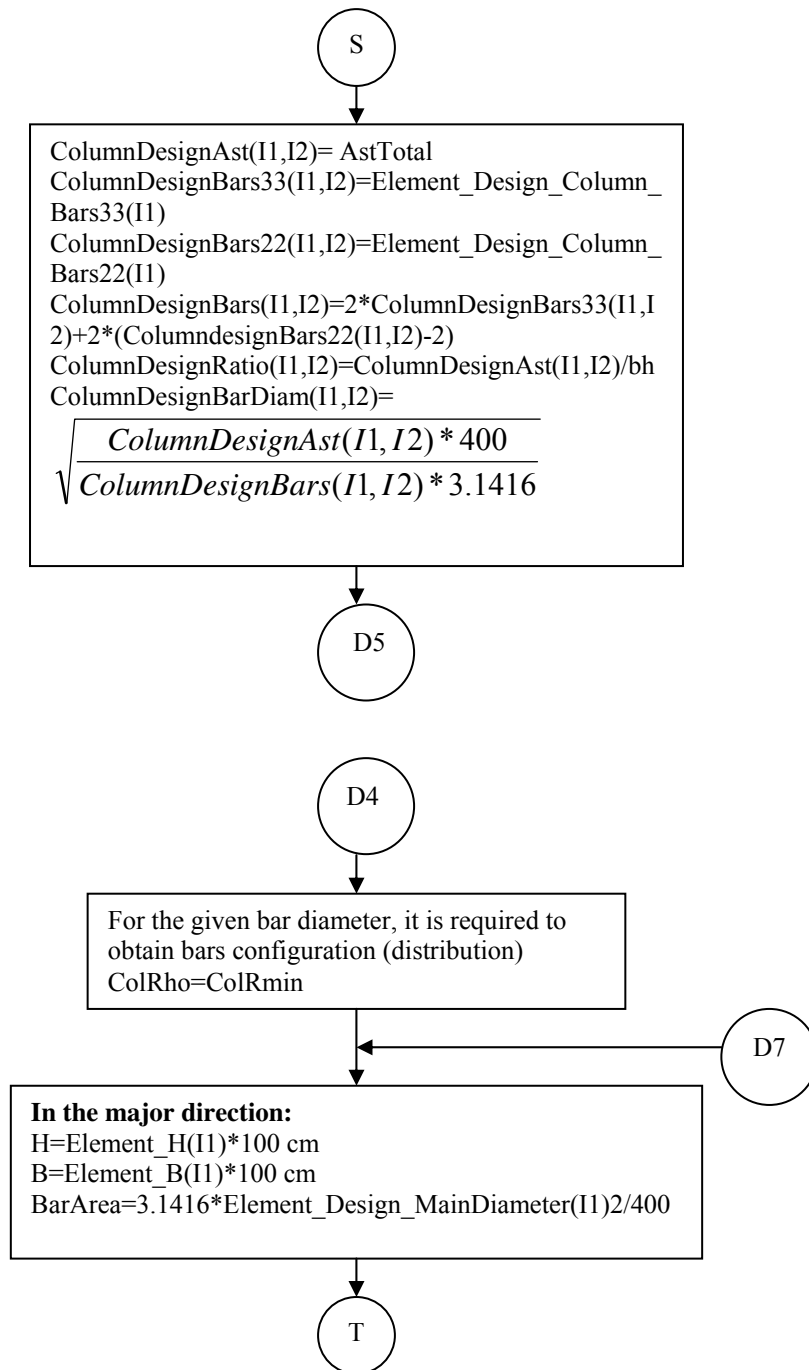

Figure 3.35b continued

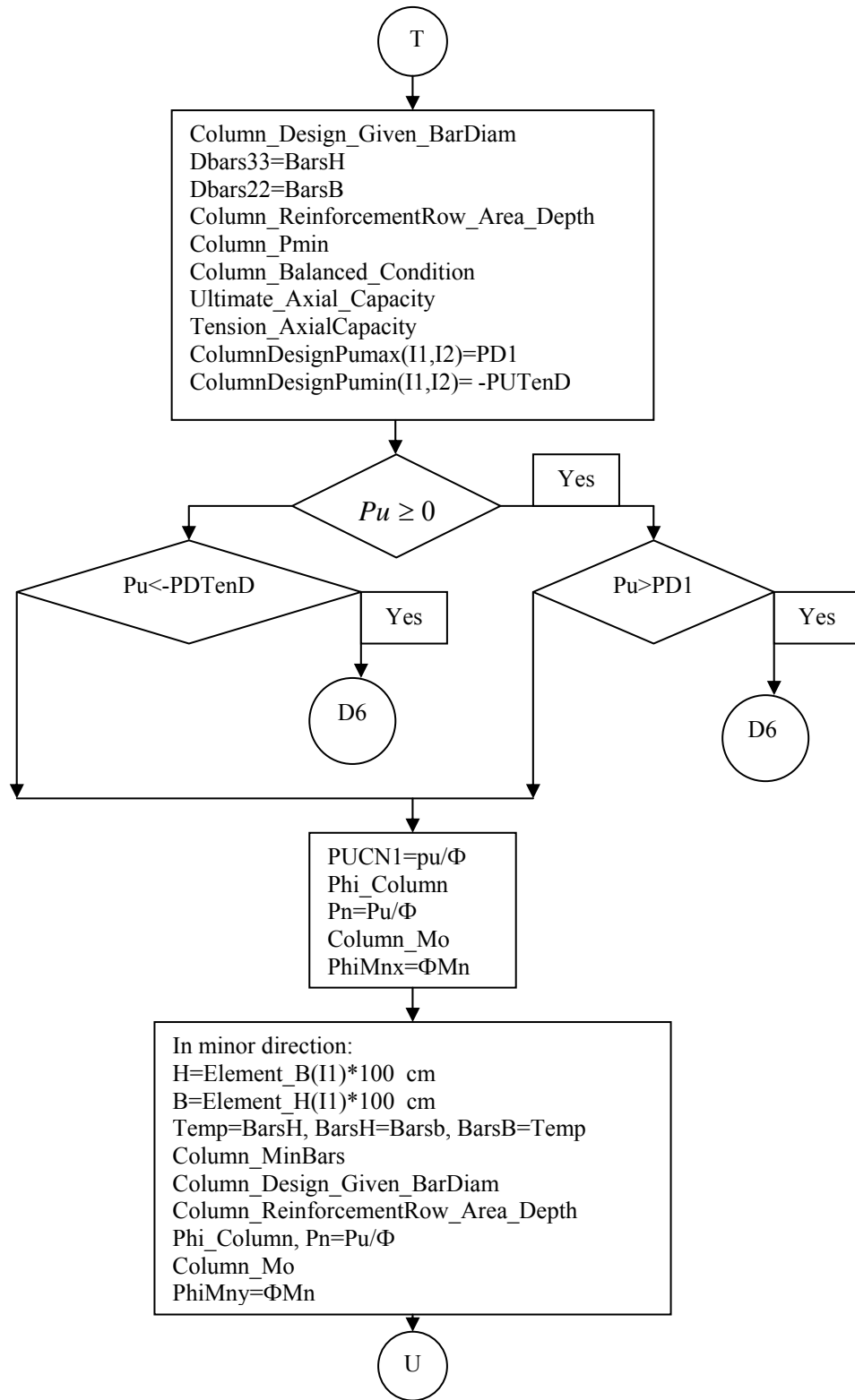

Figure 3.35b continued

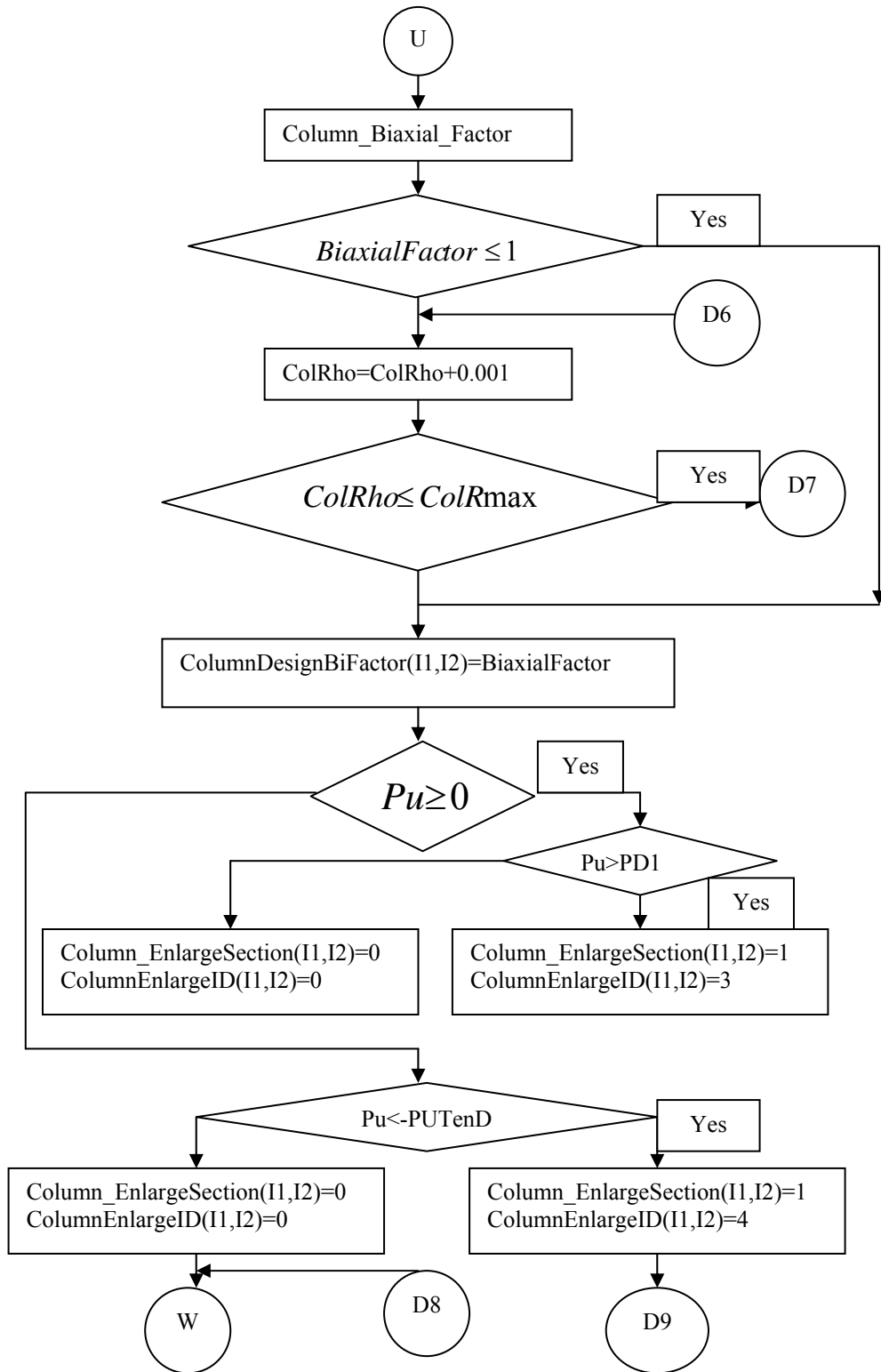

Figure 3.35b continued

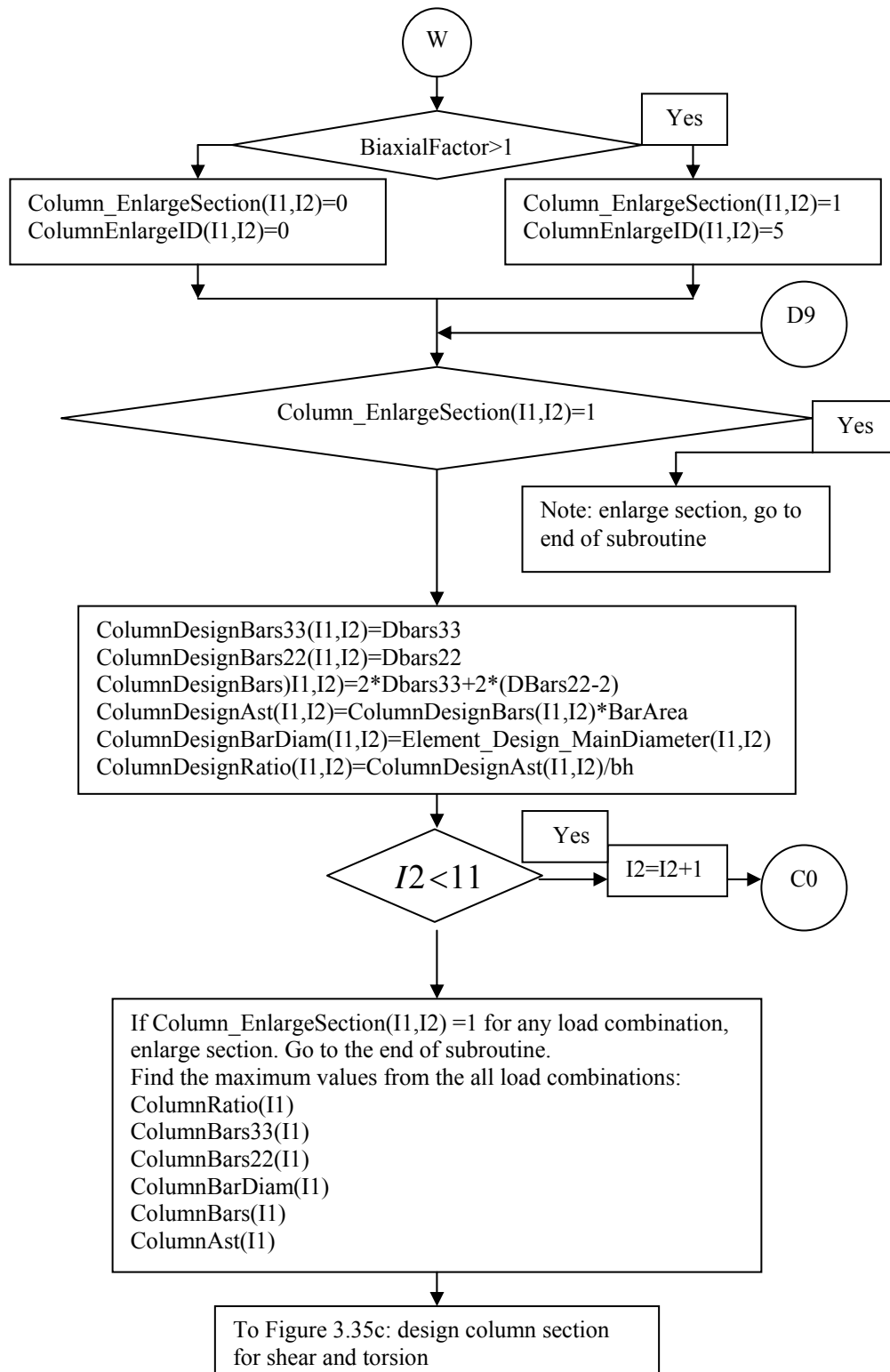

Figure 3.35b continued

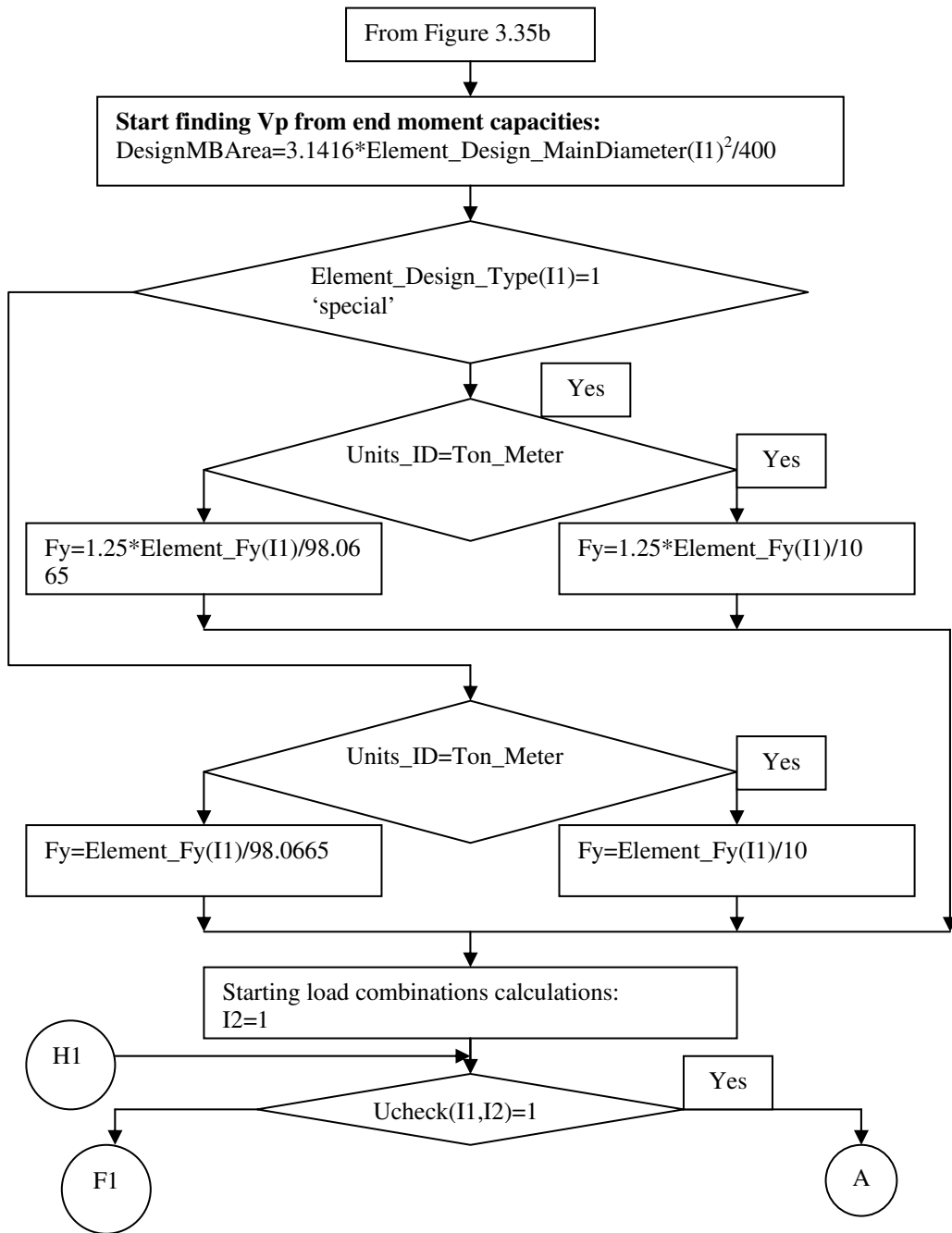

Figure 3.35c Flowchart of the subroutine Element_Design(I1), design for shear and torsion

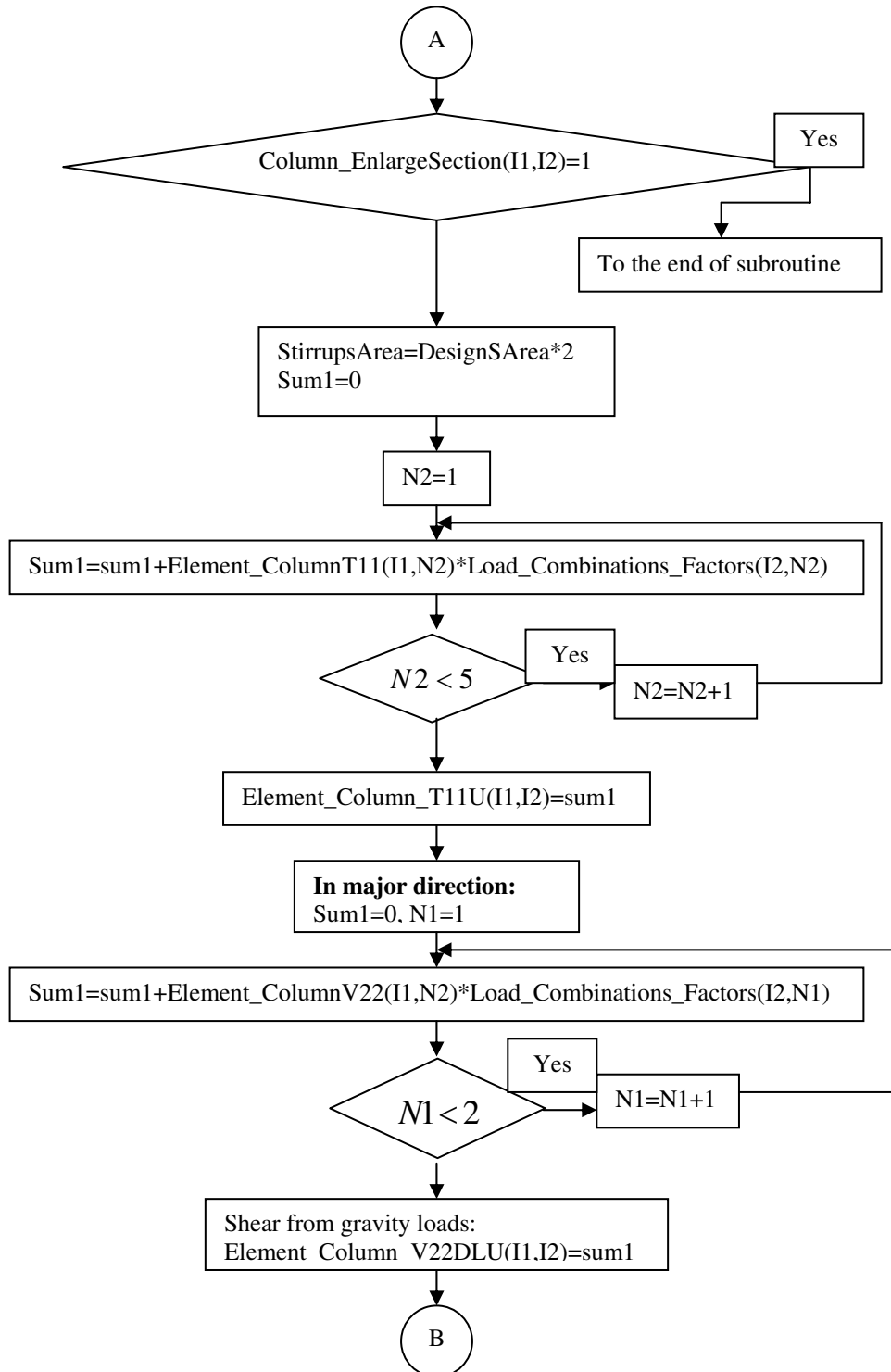

Figure 3.35c continued

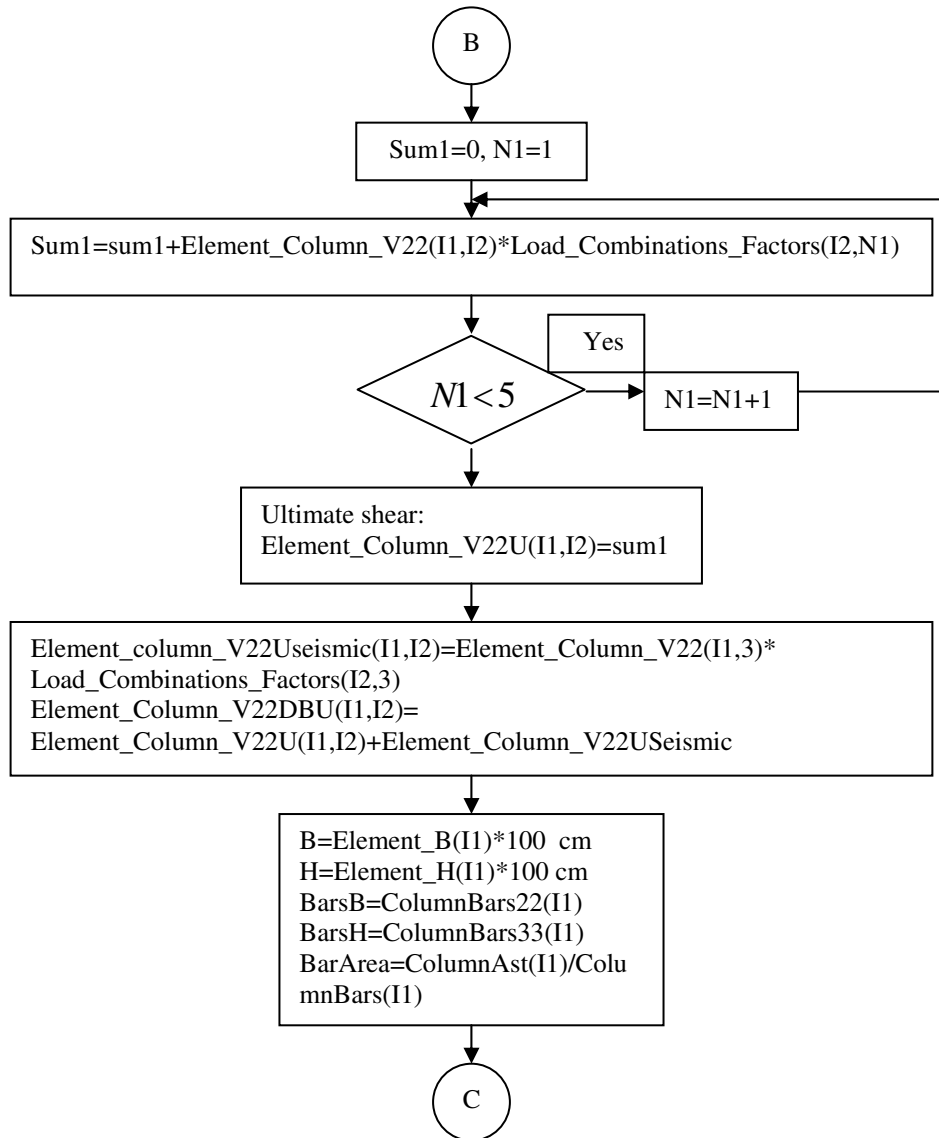

Figure 3.35c continued

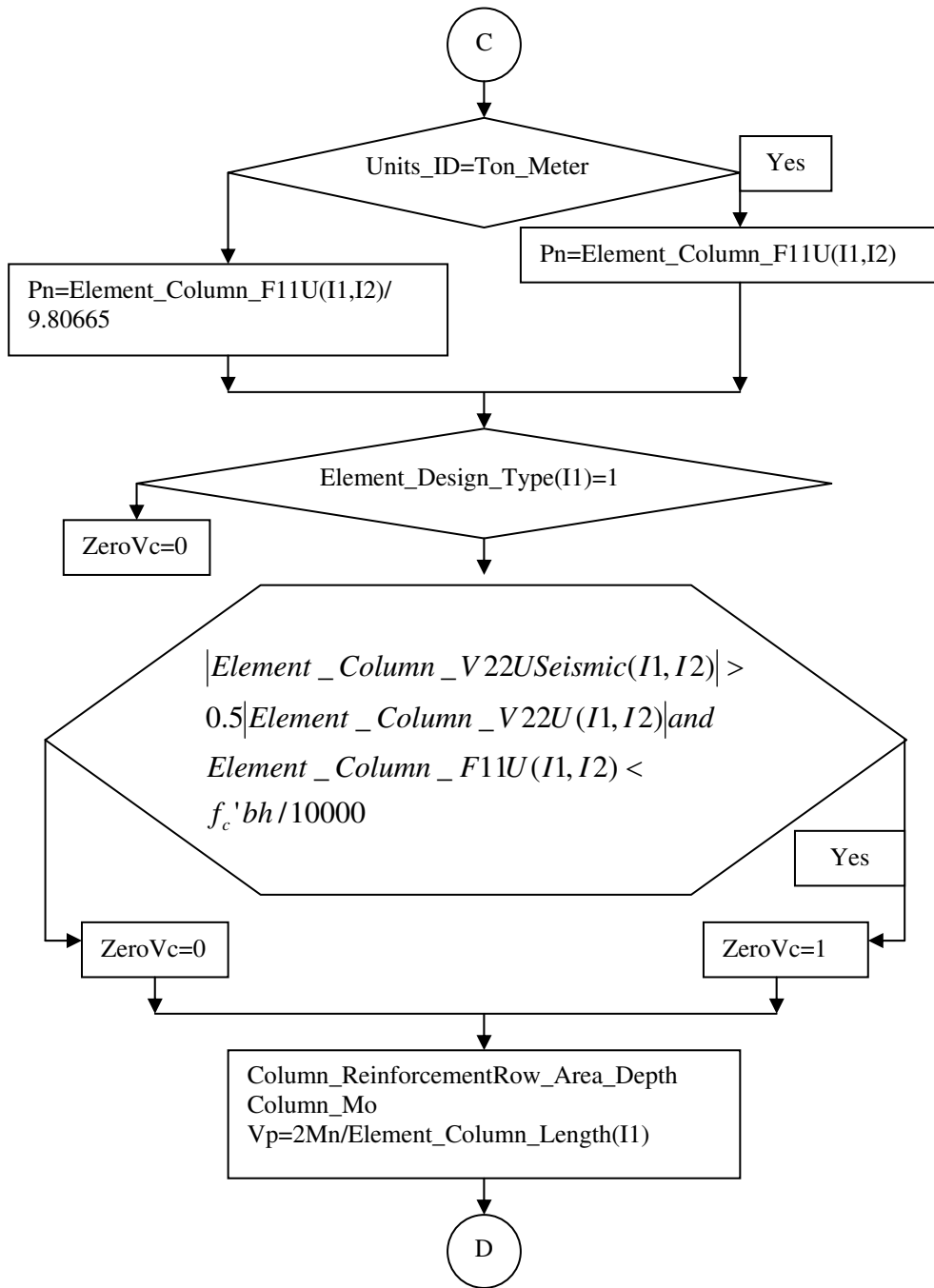

Figure 3.35c continued

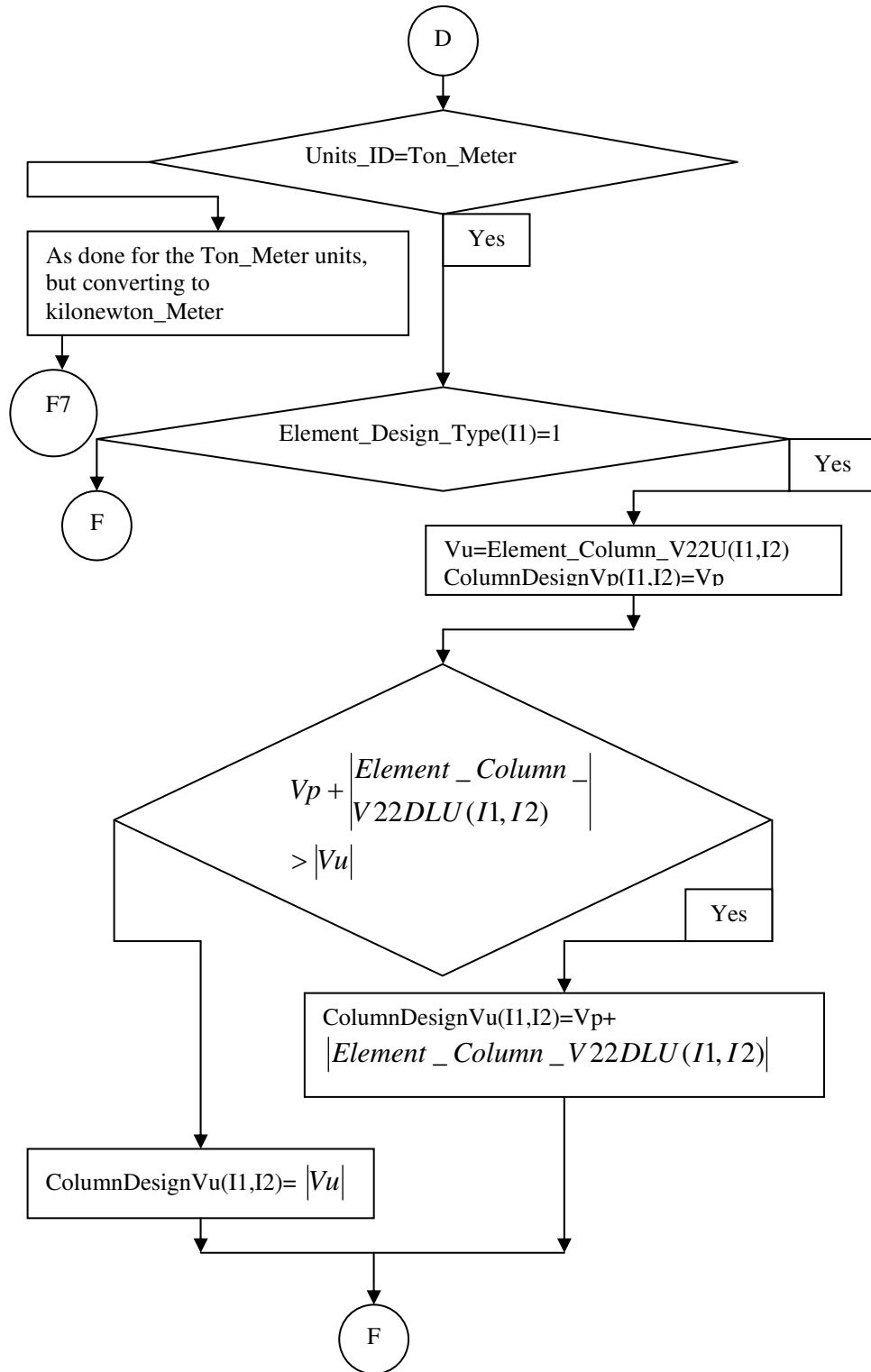

Figure 3.35c continued

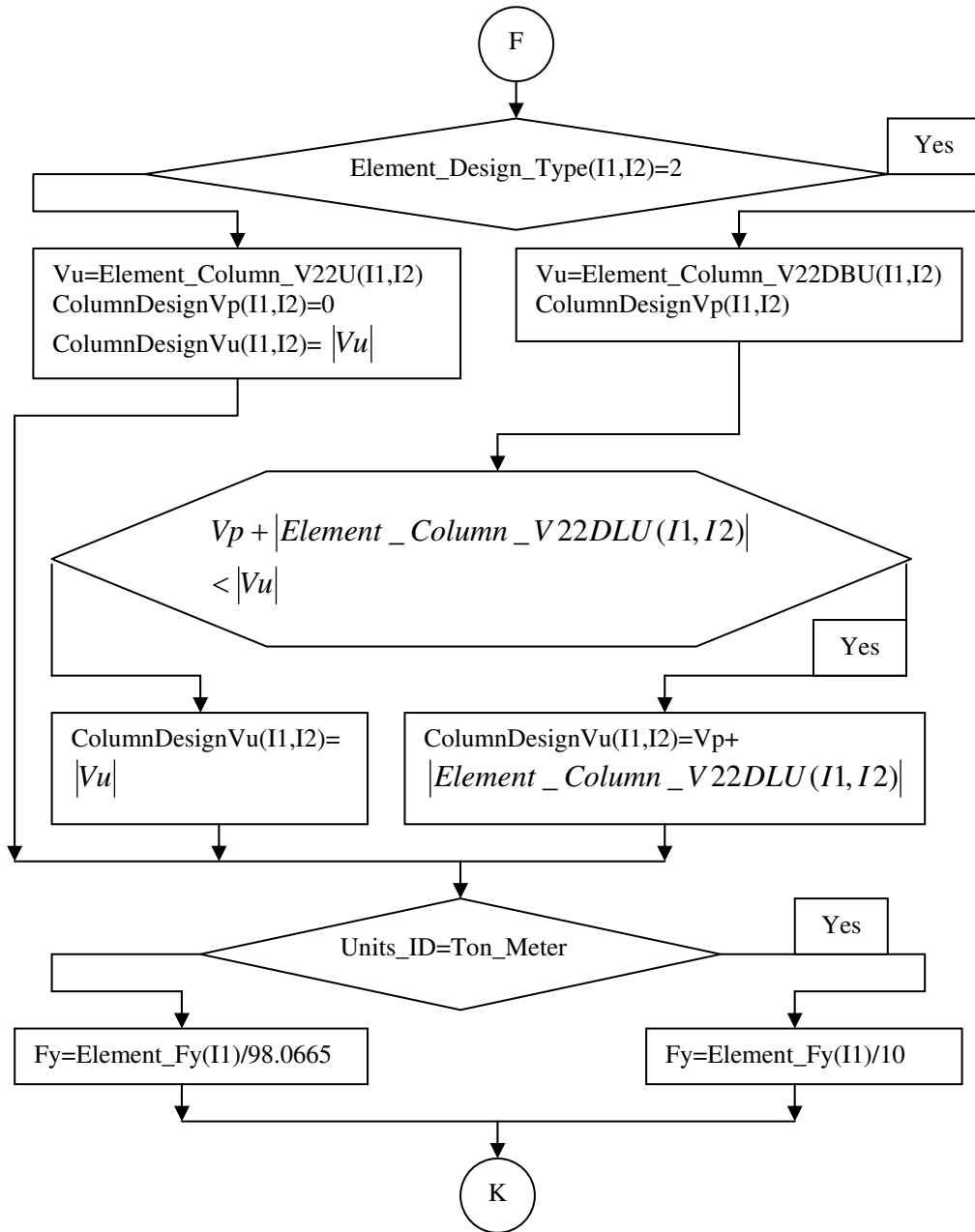

Figure 3.35c continued

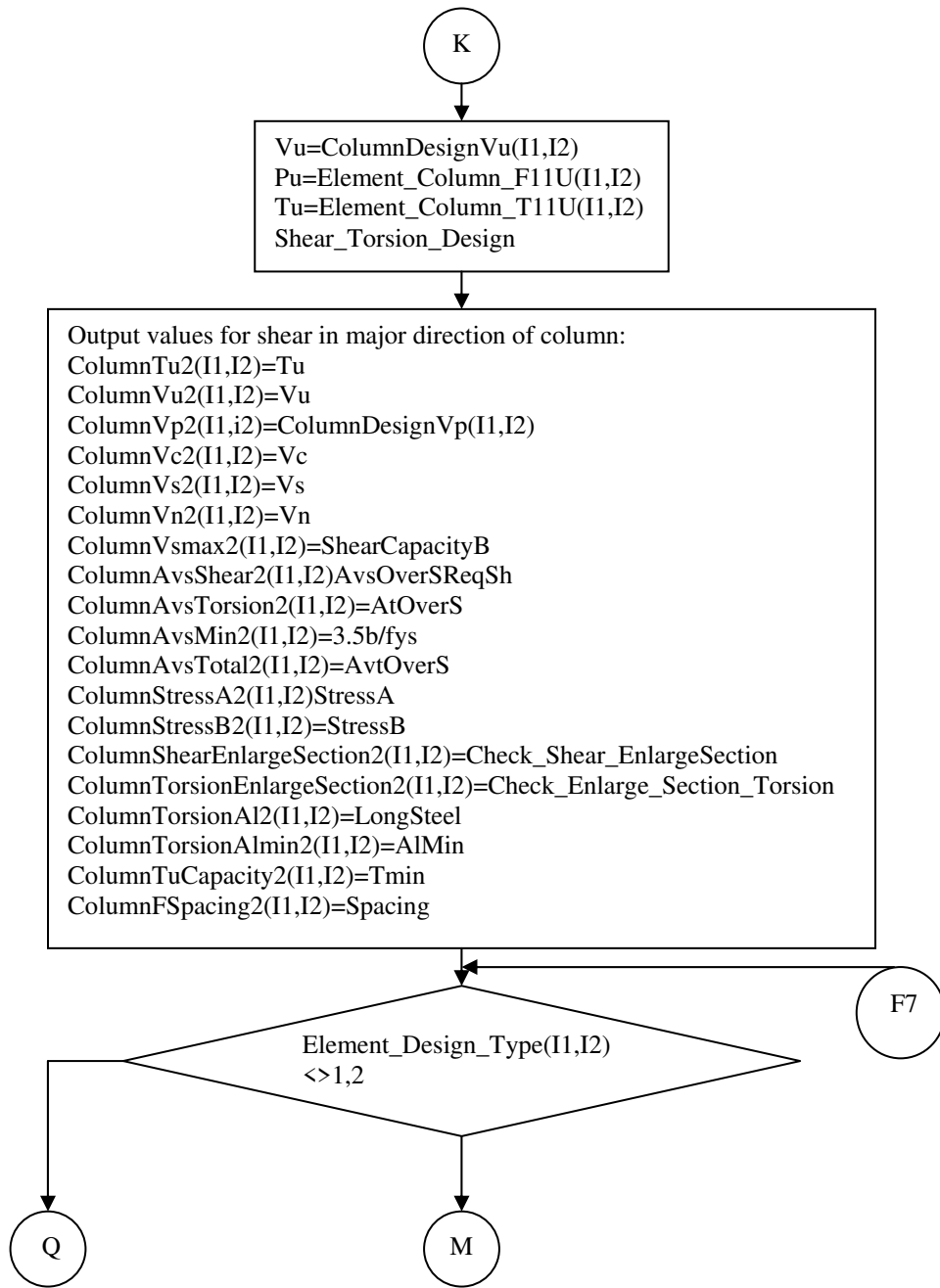

Figure 3.35c continued

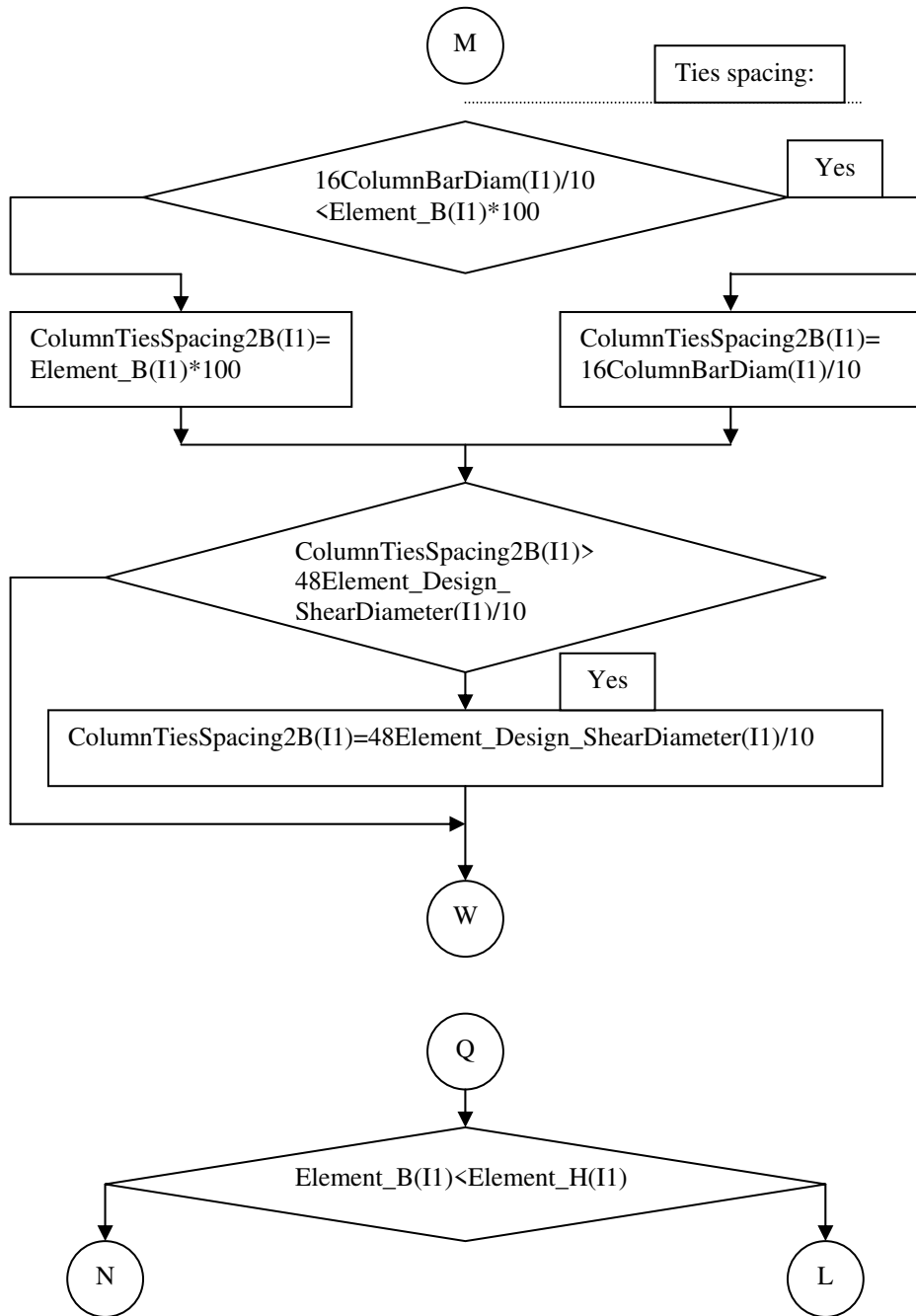

Figure 3.35c continued

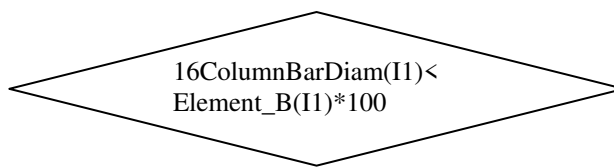
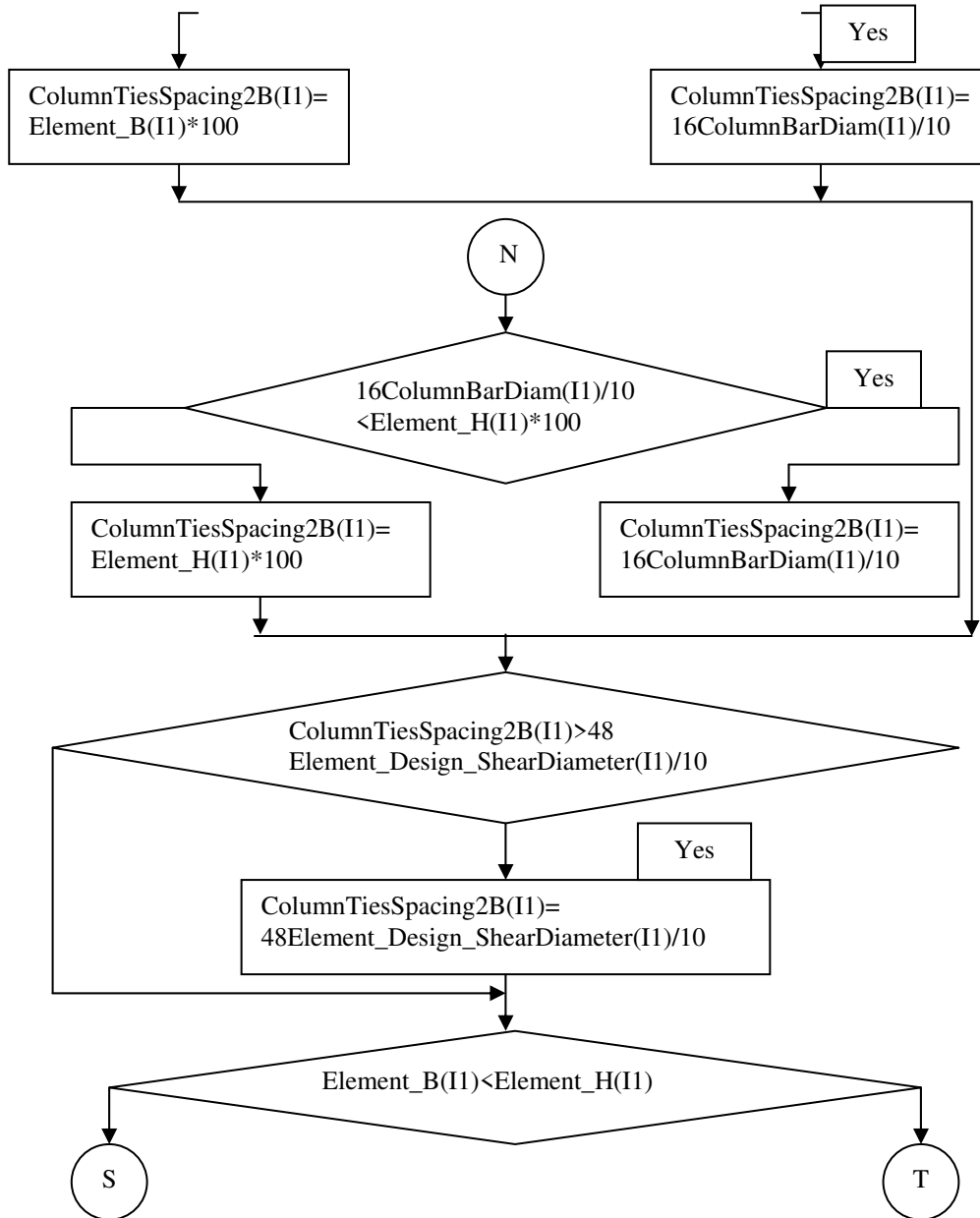

Figure 3.35c continued



T

Yes

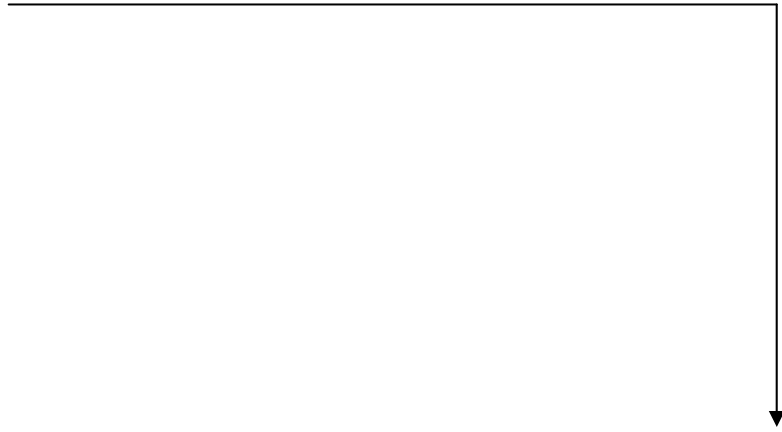

Figure 3.35c continued

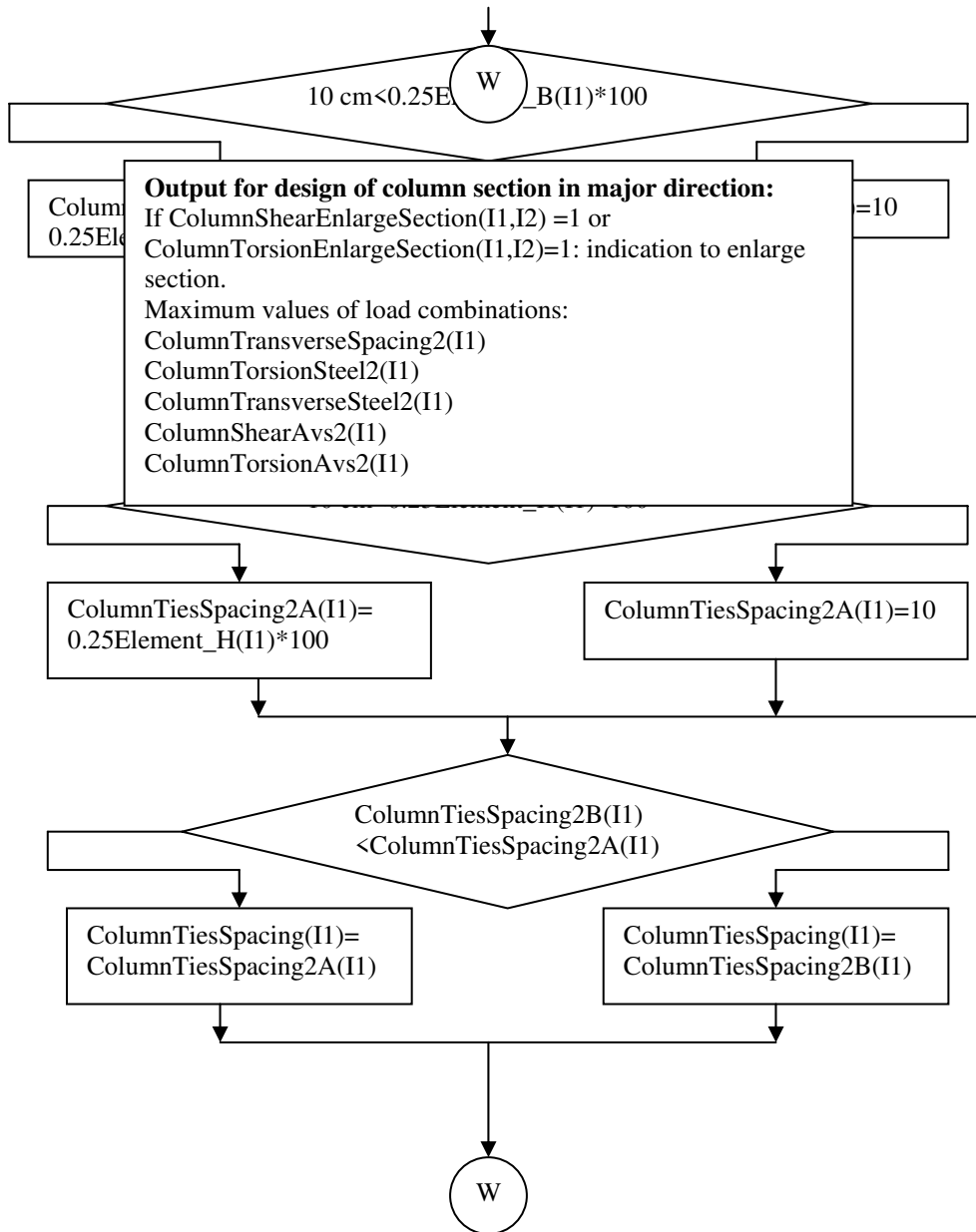

Figure 3.35c continued



In the minor direction:
 The same procedure is done as for the major direction. The main differences are:
 B=Element_H(I1)*100 cm
 H=Element_B(I1)*100 cm
 BarsB=ColumnBars33
 BarsH=ColumnBars22
 Use the numbers 33 instead of 22 in the variables
 Use the number 3 instead of 2 in the variables
 End

Chapter One

Introduction

1.1 Computer Programs and Structural Engineering:

The structural design process consists of three general phases: conceptual design, preliminary design and final design. In the conceptual design phase, the structural system for a particular structure is selected. Often more than one system needs to be worked out in order to compare them on the basis of cost, functionality and other important criteria. In case of most buildings, the architect is usually the decision-maker; but he or she is well advised to consult with the structural engineer from the very beginning of the conceptual design phase.

In the preliminary design phase, most of the specific structural design parameters (such as floor heights, column spacings, and beam and column cross sections) are selected if they have not been determined in the conceptual design phase. In order to design the structure, we need to know the forces and moments for which to design it. However, some of these forces and moments (e.g. those due to dead load) are not known until the structure has been designed. This dilemma is worsened in the case of statically indeterminate structures, because the analysis cannot be performed unless the individual member stiffness is known beforehand, in addition to the loads. This dilemma is resolved by the step-by-step procedure outlined schematically in Figure 1.1.

This procedure can be reduced by experienced engineers. Experienced designers have the added advantage of having access to a number of previous designs. The structural analysis is typically done with the help of computers, since powerful computers are now standard equipment in

design offices and engineering colleges and user-friendly, efficient, and versatile structural analysis programs are widely available.

After analysis, the design process begins. Each element section should be designed to compute the area of steel for the applied forces. If the sections' dimensions are satisfactory, the design process will finish. If not, the sections will be redesigned and then structural analysis should be made. This procedure is repeated until the sections' dimensions are enough.

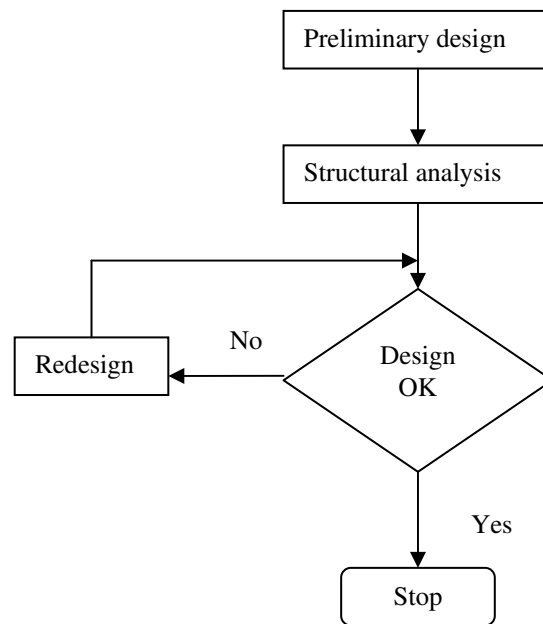

Figure 1.1 The design_analysis cycle

From the previous discussion, it is obvious that the analysis and the design processes are long. They need a quick method or way to achieve them. Computer programs are very important in these processes. There should be computer programs for structural analysis, section design and section evaluation.

Section design is very important in the design process. Usually the design should be controlled with a code of practice. The computer programs should cover the requirements of the design theory and the referred code of practice.

Computer programs for analysis (evaluation) and design of reinforced concrete sections are very important in the design process and in evaluating sections and members in existing structures. The design of the section is to compute the required areas of steel for the applied forces like bending moments, shear forces, axial forces and torsional moments. The required areas of steel are to be computed for a trial section from conceptual or preliminary design phases. Also, there is a need to distribute the reinforcement steel through the section for practical use.

Evaluating reinforced concrete section is to determine its capacity for bending, shear, axial and torsion. Interaction diagrams are needed for column section design and evaluation. Evaluating the element section is very important in studying and evaluating existing structures. Beam, column and footing capacities should be determined to check the structure strength.

1.2 Arabic Structural Engineering Programs:

The most popular structural engineering programs are of English language. Structural engineers in the Arabic world and also in our country, Palestine, studied the engineering courses in universities in English language, some of them in other languages like Russian, French and Arabic.

A nation can build its civilization using only its language. The nation can take benefits from other languages in civilization styles, but the own language should be the basic of civilization.

There is a need to have Arabic structural computer programs in order to have a common language between the whole engineers and to build our own civilization.

1.3 Available Programs for Analyzing and Designing of Reinforced Concrete Sections:

There are many computer programs dealing with reinforced concrete. Popular computer programs like SAP2000, STAAD and others are structural analysis and design programs. These programs have the ability to analyze the structural model and then design the sections to the applied forces. Other programs like PROKON have the ability of section design for input values of forces. Torsion is neglected in most of these programs but recently considered in SAP2000, version 8. There is no available program that has the ability of section analysis (evaluation) and section design for the user input data of different loads especially torsion, and in the same time it is in Arabic language and has the ability of producing section reinforcement layout and interaction diagrams for number of sections at the same time.

1.4 The Importance of the Program

The program **AD RCS** is able to analyze and design reinforced concrete beam and column sections for bending, shear, axial and torsion. For the analysis: the section dimensions, material properties, and the existing reinforcement should be entered and the section capacities will be found. For design: the preliminary section dimensions, material properties and the applied forces should be entered and the needed reinforcement will be found. For the beam section analysis, the moment, shear and torsional capacities are calculated. Also the axial force_shear force interaction diagram is displayed. For the column section analysis, interaction diagrams for axial forces_shear forces and axial forces_bending moments in the two directions are displayed. For beam section design, the required reinforcement is calculated for the applied forces of bending, axial, shear and torsion. For column section design, the required steel is calculated for the applied forces in the two directions. In addition, interaction diagrams for axial, shear and bending are displayed. For the footing analysis, the single footing column axial capacity is calculated. For footing design, the footing dimensions and reinforcement are calculated. The program produces reinforcement section details for the design of a beam, a column and a single footing. All the output data can be printed including the tables and the interaction diagrams. The program gives summarized tables for the analysis and design output in addition to detail sheets. The user can enter up to 50 sections at the same time and gets the results after. During the input time, the user can change any data he enters. Also, it is possible to change bar diameters of reinforcement steel in section design and the program develops a new section detail for the new bar diameters. The

program supports all the ACI 318-99 load combinations and the user can change the combination factors.

The program is introduced in Arabic and English languages and in ton.meter and kelonewton.meter (SI) units.

This program is designed to help students in structural engineering courses especially in their projects. The student spends much time on drawing interaction diagram for one column, calculating areas of steel for bending in beams, for shear calculations ...etc. The program helps him to achieve these calculations and he will have time for system creation. The program will help the engineers in the engineering offices. They can use it for design of forces especially the design for torsion. The program is very important in section evaluation for failure analysis projects; the section capacity will be determined.

1.5 Programming Language and Style

The program is constructed by using Visual Basic 6 programming language. This language is practical, quick and powerful.

The program is displayed with forms or dialog boxes and needs Windows for running, as it is the case for all the available visual programs. The input and output data are displayed in dialog boxes by edit boxes, options, lists, tables and graphs. There would be main menu and quick buttons to deal with the user.

In Visual Basic, each dialog box or form has a code page and they are found in a file. Also, the common data or subroutines can be written in code files that called Modules. So, the visual basic program or project consists mainly of many files; forms and modules.

1.6 The Thesis Composition:

The thesis is constructed in six chapters. Chapter one illustrated the program importance and the existing computer programs. Chapter two illustrates the theory basics of analysis and design of reinforced concrete sections; beams, rectangular columns and single footings. It introduces the main steps of section analysis and design and the flowcharts of the program subroutines using the common symbols of variables and the same names of the program subroutines. The analysis and design steps are divided to smaller units to be used in the subroutines, as they are many steps that are repeated in analysis or design of different sections. Chapter three illustrates the program composition. It introduces the flowcharts of the program menus, definition of variables used in the program code and the dialog boxes forms with names of files. Chapter four introduces quick tutorials or examples illustrate the steps of using the program. Chapter five illustrates the main steps of using the program. It illustrates the steps for defining materials, sections, load cases, forces and reinforcement. Chapter six introduces problems that are solved manually and by the program. Chapter seven introduces remarks and recommended future studies.

Chapter Seven

Remarks and Recommended Future Works

Programming is very important in engineering. Today, the programming languages are developed and widespread. These programming languages should be learned and used for constructing local and international programs that are needed to develop the engineering fields and especially to develop the local programming field. Local programs will be appropriate to local specifications and practice and also they will be cheaper. Programming companies should be established, as they are many local programmers in order to develop the scientific and economic national fields.

The program **AD RCS** (Analysis and Design of Reinforced Concrete Sections) can be considered as a step in the local engineering programming. This program is constructed in a master thesis, that is a work of one person. This program will be developed in the future and will stretched to have other many abilities such as the addition of other types of footings like combined and wall footings, other shapes of sections like I sections and more international units like pound and inch.

Chapter Five

Getting Started with the Program

In this thesis, a computer program will be introduced as a result of a very hard work. The program will have the ability of evaluating and designing reinforced concrete sections of beam, column and single footing. Also, the program has the ability of introducing axial force-bending moment interaction diagrams for the column section and details for section design of beam, column and single footing.

5.1 Evaluating (analyzing) Reinforced Concrete Sections:

The program has the ability of analyzing reinforced concrete sections of beams, columns and single footing.

Beam Section: The material property is defined by entering the values of the compressive strength of concrete, f_c' , longitudinal steel yield strength, f_y and transverse steel yield strength, f_{ys}' . The user defines the section dimensions; width and height of rectangular section or the width, height, flange width and flange thickness for a T and L sections.. The existing reinforcement is defined for the top, bottom and shear reinforcement. The program gives the moment capacities for the positive and negative moments and the design shear capacity. The torsion capacity for section is also introduced for concrete. Also, the program gives interaction diagram that relates the axial force capacity and the shear capacity in the major direction of the section. The axial load is limited to $0.1f_c'A_g$ (A_g is the section cross-area). The beam theory is applied to axial load maximum of $0.1f_c'A_g$.

Column Section: the user defines the rectangular section dimensions; width and height. The material property is also defined by entering the values of f_c' , f_y , and f_{ys} . The existing reinforcement is defined as the number of longitudinal bars and bars distribution and the shear reinforcement. The program gives the interaction diagrams that relates the axial force capacity and the bending moment capacity in the major and minor directions. Also, the program gives interaction diagrams that relates the axial load capacity and the shear capacity and concrete torsion capacity in the major and minor directions.

Footing: the user defines the column dimensions and the material properties. The footing dimensions are entered as footing length, width and thickness. The soil allowable bearing capacity, the concrete cover and the reinforcement in both directions are also entered. The program determines the ultimate axial load capacity that the footing can carry.

5.2 Designing Reinforced Concrete Sections:

The program has the ability of designing reinforced concrete sections of beams, columns and single footing.

The section property is defined by entering the section dimensions and the material properties are defined by entering f_c' , f_y and f_{ys} .

The Beam Section: the user enters the values of the applied forces; bending moment, shear force, axial force (less than $0.1f_c'A_g$) and torsional moment. The program gives the required longitudinal (top and/or bottom) and shear reinforcement.

The Column Section: the user enters the values of the applied forces. They may be axial force, torsional moment, shear forces in the major and minor

directions and bending moments in the two directions. In column design, it is required to know the values of the end moments that are very important in the moment magnification and section design. The program introduces axial force-bending moment capacities interaction diagrams in the two directions. Also, it introduces axial force-shear force capacities interaction diagrams in the two directions. It is required to specify the element type as found in sway special, sway intermediate, sway ordinary or nonsway moment resisting frame. The type of column element is very important in column section design. The column design factors can be modified.

Footing: the column dimensions, the footing material properties, the soil allowable bearing capacity, the concrete cover and the axial load on the column should be entered for footing design. The program gives the footing dimensions and reinforcement.

The program supports different types of loads; dead, live, earthquake, wind and other loads. In column design, the dead and live loads form the nonsway forces, while the earthquake, wind and other loads form the sway forces.

There are eleven load combinations that the program deals with. The load combination factors depend on the American Concrete Institute (ACI) code of practice. The factors in each load combinations can be overwritten.

In the output, the details for each design load combination can be displayed and printed. All tables in the output process can be printed. The design reinforcement details can be displayed and printed.

5.3 Getting Started with the Program:

In this section, the procedure of using the program will be illustrated. A Help file supports the program. The following sections illustrates the detailed use of the program.

5.3.1 Language and Units:

The program supports the Arabic and English languages and ton-meter and kilonewton-meter units. These can be determined soon after running the program.

5.3.2 Starting a New Project:

From the **File** menu, select **New Project**. This will display the New Project dialog. You can choose Analysis or Design modes and enter the number of sections you decide to design or analyze. Through running the program, you can add other sections by selecting the **Edit** menu and then **Add**. Also, you can rename or delete element sections by selecting **Modify** or **Delete** from the **Edit** menu respectively.

5.3.3 The Define Menu

The **Define** menu consists of three submenus: **Materials**, **Sections** and **Design Load Combinations**.

5.3.3.1 The Materials Submenu

From the **Define** menu, you can select **Materials** to define the material or materials properties. From the Define Materials dialog, you can add, modify or delete a material. You can modify the material properties by choosing the command button **Modify/Show Material** that displays the Material Property Data dialog. You can enter the values of the concrete

compressive strength, f_c' , the main steel yield strength, f_y , and the transverse steel yield strength, f_{ys} .

5.3.3.2 The Sections Submenu

Select **Section** from the **Define** menu. This will display the Define Sections dialog. You can add, modify or delete section or sections. The section properties can be shown or modified by clicking on the **Modify/Show Section** button. This will display the Show Section dialog. You can enter the section dimensions and the material name. Click on the **Section Data** command button to determine if the section is a beam or column, and if the section is column, does it has a footing to design or analyze. In the Section Data dialog, you can enter the concrete covers for a beam section and the concrete covers and height for a column section. If having a footing, choose **Footing** in the Column Data dialog and then click on the **Define Footing** button. This will display the Define Footing dialog. You can enter the values for the soil allowable bearing capacity, ultimate load factor (the factor that used to convert ultimate load to service load), and the concrete cover to rebar center.

5.3.3.3 The Design Load Combinations Submenu

From the **Define** menu, select **Design Load Combinations**. This will display the define load combinations dialog. You can select your load combinations or modifying the load factors. You can return to the default values according to the ACI318-99 by clicking on **Default Values**

command button. The design load combinations combines the dead, live, wind and earthquake load cases together.

5.3.4 The Assign Menu

The **Assign** menu will be active after selecting the element section name or names from the element section list. In the design mode, **Sections**, **Forces** and **Reinforcement Design Options** submenus will be active, while in the analysis mode, **Sections** and **Reinforcement** submenus will be active.

5.3.4.1 The Sections Submenu

Select element section name or names from the elements list. From the **Assign** menu, select **Sections**. This will display the Sections dialog. From the sections list, select the section name. You can modify the section properties in this stage.

5.3.4.2 The Forces Submenu

Select element section name or names from the elements list. From the **Assign** menu, select **Forces**. This will display the Forces dialog. The form of the dialog depends on the type of the section; beam or column. For a beam section, you can enter the values of the applied forces; bending moment, shear force, torsional moment and axial force for different types of load cases.

For a column section, you can enter the values of the axial force, shear force in the major and minor directions, torsional moment and bending moments about the major and minor directions of the section for different load cases. The column end moments in the major and minor directions should be entered. Check on the **Span Loads** button if having span loads along the column height (this will affect the design parameters of column

section. See chapter two). Check on the **Span Moments** button if you want the program to design for specified values of bending moments and not the end moments. If the **Span Moments** button is checked off, the design will be for the end moments, and this is the usual case of column elements.

5.3.4.3 The Reinforcement Submenu

In the Analysis mode, select element section name or names from the elements list. From the **Assign** menu, select **Reinforcement**. This will display the Assign Beam Reinforcement dialog (for beam section) or the Assign Column Reinforcement dialog (for column section). There are two reinforcement options; **Bars** and **Area** options.

Beam section: for the **Bars** option, the number of bars and the bar diameter for the top and bottom reinforcement and the number of stirrups (bars), bar diameter and bars spacing for shear reinforcement should be entered. For the **Area** option, the areas of the top and bottom main steel should be entered. For shear, the shear reinforcement, A_v/S (A_v : area of shear reinforcement in a section. S : stirrups spacing) should be entered.

Column section: for **Bars** option, the number of bars in the major and minor directions and the bar diameter should be entered. The number of stirrups, the stirrup diameter and the stirrup spacing should be entered for the shear reinforcement. For the **Area** option, the number of bars in the major and minor directions and the bar area should be entered. For shear, the shear reinforcement, A_v/s should be entered. If having a footing, the Footing Data command button will be active. Click on the **Footing Data** button. This will display the Assign Footing Dimensions and Reinforcement for Analysis dialog. In this dialog, the footing dimensions; the width, LB, the length, LH and the depth should be entered. The

reinforcement can be entered as bars or area. In the **Bars** option, the number of bars and bar diameter in the two directions should be entered. In the **Area** option, the area of steel in the two directions should be entered.

5.3.4.4 The Reinforcement Design Options Submenu

In the Design mode, select element section name or names from the elements list. From the **Assign** menu, select **Reinforcement Design Options**. This will display the Reinforcement Design Options dialog. By using this submenu, you can assign the reinforcement arrangement and diameters. For a column section, you can choose **Bars Layout** or **Bars Diameter** reinforcement options. In the **Bars Layout** option, you will enter the number of bars in the two directions and the transverse reinforcement bar diameter. The program will give the area of one bar. In the **Bars Diameter** option, you will enter the bar diameters of the main and transverse reinforcement and the program will give the bars layout (distribution). For a beam section, **Bars Diameter** option only is active. So you can enter the bars diameters for the main (longitudinal) and transverse bars.

5.3.5 The Analyze Menu

Click on **Start Analysis/Show Results** menu to run the analysis. This will display the Show Analysis Output dialog.

For the beam section, the design positive (Beam/M+) and the design negative (Beam/M-) moments and the shear capacity (Shear V_d2) will be displayed in the analysis output table. You can display the axial load-shear capacity interaction diagram by clicking on the **Pu-Vu2** command button. This will display the interaction diagram dialog (form). Moving the mouse

pointer shows the coordinates of the specified point. Click on **Show Interaction Points** button to display a table shows the main points of the interaction curve. From the **Show Analysis Output** dialog, you can display the details of the analysis process.

For the column section, the shear capacities in the major and minor directions (Shear/Vd2 and Shear/Vd3 respectively) will be displayed in the analysis output table. You can display the axial force-bending moment interaction diagrams in the major and minor directions by clicking on **Pu-Mu2** and **Pu-Mu3** command buttons. This will display the interaction diagram dialog. Moving the mouse pointer shows the coordinates of the specified point. Click on **Show Interaction Points** button to display a table shows the main points of the interaction curve. You can display the values of axial forces and bending moment's capacities for a given eccentricity and the value of a bending moment capacity at a given axial load. This will be achieved by selecting the **Check Points** menu from the Column Interaction Diagram dialog. The axial force-shear capacity diagrams can also be displayed as for the beam section. If having a footing, the Footing Analysis command button will be active. Click on **Footing Analysis** button to run footing analysis. This will display the Footing Analysis Details dialog.

5.3.6 The Design Menu

This menu consists of two submenus. They are Start Design/Show Results and Redefine Element Design Data.

5.3.6.1. The Start Design/Show Results Submenu

Click on the **Start Design/Show Results** submenu to run the design process. This will display the Show Design Output dialog.

For a beam section, the required areas of steel (A_{st} Top and A_{st} Bot); the top and bottom areas of steel for flexure and the shear reinforcement (A_v/S 2) and torsion reinforcement (transverse reinforcement A_v/S 2 and longitudinal T A12) will be displayed. You can display the design output for each load combination by selecting the **Load Combinations** button. This will display a table of output design for the different load combinations. Select a load combination and then click on **Details** button. This will display the design details for the selected load combination. You can display the designed section reinforcement details by clicking on the **Show Bars Layout** button. This will display the Show Bars Layout dialog. You can change the bars diameters by clicking on the **Change Bar Diameter** menu.

For a column section, the main steel (A_{st}), the shear steel in the major and minor directions (S A_v/S 2 and S A_v/S 3) and the torsion steel (transverse T A_v/S 2 and T A_v/S 3 and the longitudinal T A12 and T A13) will be displayed. You can display the reinforcement for each load combination by clicking on the **Load Combinations** button. This will display the table of reinforcement for the different load combinations. Select a load combination and then click on **Details** button. This will display the details of the design process for the specified load combination. You can display the axial force-bending moment capacities in the major and minor directions as in the Analysis Mode. If having a footing to be designed, the **Footing Design** button will be active. Click on the button. This will display the Show Footing Design dialog that shows the design output. You can display the reinforcement details for the footing by clicking on **Show Bars Layout** menu. This will display the Show Bars Layout dialog. You can change the bars diameters by clicking on **Change Bar Diameter** menu.

From the Design Output dialog, you can display the bars layout details for the column section by clicking on the **Bars Layout** button.

5.3.6.2 The Redefine Element Design Data Submenu

In the Design mode, select element section name or names from the elements list. From the **Design** menu, select **Redefine Element Design Data**. This will display the Redefine Element Design Data dialog. The column element should be determined as found in sway special, sway intermediate, sway ordinary or nonsway moment resisting frame. The type of the frame specifies column design parameters. From this dialog, you can select the column element type. Also, the design parameters can be modified. The design parameters deal with column length, the effective length factors, the moment coefficients, C_m and the sway and nonsway coefficients. The value of zero indicates that the program uses default values.

5.3.7 The Options Menu

In this menu, the values of the strength reduction factors; bending, tension, compression, shear and torsion can be modified. The default values are according to the ACI code of practice.

For the column section, the minimum and the maximum steel ratios and the reduction factor for minimum eccentricity can be modified. For the footing section, you can modify the minimum footing thickness.

5.3.8 The Help Menu

From the Help menu, the help file can be displayed. The help data will be displayed in Arabic for the Arabic language and will be displayed in English for the English language.

One can press the F1 key to get information about the active dialog or operation.

5.3.9 Saving and Opening Files

The data file can be saved by selecting **Save** from the **File** menu. Also, selecting **Open** from the **File** menu can open the saved data file.

5.3.10 Printer Setup

The program supports the Print Setup menu. One can determine the printer type, paper size and paper orientation. To change the default printer setup, select **Print Setup** from the **File** menu.

5.4 Brief steps in using AD RCS

The main points of using AD RCS in design are as follows:

1. From the first beginning, select language and units.
2. From the file menu, select New Project: select the Design option and enter the number of element sections to be designed.
3. From the Define menu, select Materials to enter the concrete properties
4. From the Define menu, select Sections to define the dimensions, element type beam or column and if a column has footing to be designed
5. From the Define menu, select load combinations to customize your own load combinations
6. Select element section or sections from the element sections list to assign a section, forces and reinforcement design type to the selected element section or sections using the Assign menu.

7. From the design menu, select Start Design/ Show Results the output will be displayed.

The main points of using AD RCS in analysis are as follows:

1. From the first beginning, select language and units.
2. From the file menu, select New Project: select the Analysis option and enter the number of element sections to be analyzed.
3. From the Define menu, select Materials to enter the concrete properties.
4. From the Define menu, select Sections to define the dimensions, element type beam or column and if a column has footing to be analyzed.
5. Select element section or sections from the element sections list to assign a section and reinforcement to the selected element section or sections using the Assign menu.
6. From the analyze menu, select Start Analysis/ Show Results the output will be displayed.

5.5 The Programming Language

The program is achieved and appears in reality using Visual Basic 6 programming language. This language is a quick and professional language. It contains complete and abbreviate statements more than other languages like Visual C++, Visual Fortran and Visual Java. Also, it can be studied in shorter time than other languages.

The program was compiled and it is found in the attached compact diskette. This program is beginning in the local programming capabilities. I hope to develop and extend its capabilities.

Chapter Six

Problems Verification

In this chapter, three problems will be introduced. These problems will be solved manually and using the computer program **AD RCS**.

6.1 Problem One: Design of Rectangular Beam Section for Bending, Shear and Torsion:

Design a rectangular beam section of 35cm width and 65cm depth that subjected to ultimate bending moment of 30t.m, ultimate shear force of 20t and ultimate torsional moment of 6t.m. $f_c' = 280\text{kg/cm}^2$, $f_y = 4200\text{kg/cm}^2$, $f_{ys} = 3500\text{kg/cm}^2$, top and bottom concrete cover = 5cm, sides cover = 6cm, main steel diameter = 20mm and shear steel diameter = 10mm.

Solution:

Design for bending moment:

Section effective depth, $d = 65 - 5 = 60\text{cm}$

The concrete compressive block depth, a :

$$a = d - \sqrt{d^2 - \frac{2 \times 10^5 M_u}{0.85 f_c' \phi b}} = 60 - \sqrt{60^2 - \frac{2 \times 10^5 (30)}{0.85 (280) (0.9) (35)}} = 7.088\text{cm}$$

$$a_{\max} = 0.75 \beta_1 c_b$$

$$c_b = \frac{6120d}{6120 + f_y} = \frac{6120(60)}{6120 + 4200} = 35.58\text{cm}$$

$$a_{\max} = 0.75(0.85)(35.58) = 22.68\text{cm} > a, \text{ so no need for compression steel}$$

$$A_s = \frac{M_u}{\phi f_y (d - a/2)} = \frac{30 \times 10^5}{0.9(4200)(60 - 7.088/2)} = 14.058 \text{ cm}^2$$

Design for shear and torsion:

$$V_u = 20 \text{ t}, T_u = 6 \text{ t.m}$$

1. Calculate the section torsional capacity, T_{uc} :

$$T_{uc} = 0.265 \phi \sqrt{f_c'} \frac{A_{cp}^2}{P_{cp}}$$

$$A_{cp} = bh = 35(65) = 2275 \text{ cm}^2$$

$$P_{cp} = 2(b + h) = 2(35 + 65) = 200 \text{ cm}^2$$

$$T_{uc} = 0.265(0.85)\sqrt{280} \frac{2275^2}{200} / 10^5 = 0.975 \text{ t.m} < 6 \text{ t.m}, \text{ so, consider torsion}$$

2. Check section adequacy. The section should satisfy the following equation:

$$\sqrt{\left(\frac{V_u}{bd}\right)^2 + \left(\frac{T_u P_h}{1.7 A_{oh}^2}\right)^2} \leq \phi \left(\frac{V_c}{bd} + 2.117 \sqrt{f_c'}\right)$$

$$V_c = 0.53 \sqrt{f_c'} bd = 0.53 \sqrt{280} (35)(60) / 1000 = 18.624 \text{ t}$$

$$P_h = 2(x_1 + y_1) = 2(35 - 12 + 65 - 10) = 156 \text{ cm}$$

$$A_{oh} = x_1 y_1 = 23(55) = 1265 \text{ cm}^2$$

$$\sqrt{\left(\frac{20(1000)}{35(60)}\right)^2 + \left(\frac{6(10^5)(156)}{1.7(1265)^2}\right)^2} \leq? 0.85 \left(\frac{18.624(1000)}{35(60)} + 2.117 \sqrt{280}\right)$$

$$35.7 \text{ kg/cm}^2 \leq 37.6 \text{ kg/cm}^2, \text{ ok}$$

3. Calculate the required torsional transverse steel and the total transverse steel:

$$\frac{A_t}{s} = \frac{T_n}{2A_o f_{ys}}$$

$$A_o = 0.85A_{oh} = 0.85(1265) = 1075.25 \text{ cm}^2$$

$$\frac{A_t}{s} = \frac{6(10^5)/0.85}{2(1075.25)(3500)} = 0.0938, \frac{A_v}{s} = 2(0.0938) = 0.1876$$

shear reinforcement:

$$V_c = 18.624t, V_u = 20t$$

$$V_s = V_n - V_c = 20/0.85 - 18.624 = 4.905t$$

$$\frac{A_v}{s} = \frac{V_s}{f_{ys}d} = \frac{4.905(1000)}{3500(60)} = 0.0233$$

$$\left(\frac{A_v}{s}\right)_{total} = 0.1876 + 0.0233 = 0.2109$$

$$\left(\frac{A_v}{s}\right)_{min} = \frac{3.5b_w}{f_{ys}} = \frac{3.5(35)}{3500} = 0.035 < 0.2109 \quad \text{ok}$$

Using 10mm diameter stirrups, $A_v = 2(3.1416(1)^2/4) = 1.57 \text{ cm}^2$

$$s = \frac{1.57}{0.2109} = 7.44 \text{ cm}$$

Check spacing:

$$S_{max} = \text{smaller of } Ph/8 \text{ or } 30 \text{ cm}$$

$$S_{max} = 156/8 = 19.5 \text{ cm} > 7.44 \text{ ok}$$

4. Calculate torsional longitudinal steel:

$$A_t = \frac{A_t}{s} \frac{P_h f_{ys}}{f_y} = 0.0938 \frac{156(3500)}{4200} = 12.2 \text{ cm}^2$$

$$A_{t \min} = 1.323 \frac{\sqrt{f_c'} A_{cp}}{f_y} - \frac{A_t}{s} \frac{P_h f_{ys}}{f_y}, \frac{A_t}{s} \geq 1.75 \frac{b}{f_{ys}} = 0.0175$$

$$A_{t \min} = 1.323 \frac{\sqrt{280}(2275)}{4200} - 12.5 = -0.21 \text{ cm}^2 < 12.2 \text{ cm}^2, \text{ so } A_t = 12.2 \text{ cm}^2$$

The final longitudinal steel can be distributed as follows:

bottom steel: $A_s = 14.058 + 12.2/4 = 17.108 \text{ cm}^2 (6\Phi 20 \text{ mm})$

middle steel: $A_s = 12.2/2 = 6.1 \text{ cm}^2 (2\Phi 20 \text{ mm})$

top steel: $A_s = 12.2/4 = 3.05 \text{ cm}^2 (1\Phi 20 \text{ mm})$, at least use $(2\Phi 20 \text{ mm})$

This problem is solved using AD RCS program and the results are shown in the following pages.

6.2 Problem Two: Design of a Long Column with various Loads:

Design a reinforced concrete column, given:

Concrete compressive strength, $f_c=240\text{kg/cm}^2$

Steel yield strength, $f_y=4200\text{kg/cm}^2$

Column height=4m

Effective length factor, $k=2$ (unbraced column)

Column dimensions: 70x70cm

There are two layers of steel only (tension and compression steel of the same area)

Loads:

Dead loads: $P_D=280\text{t}$

M_D top=-13t.m

M_D bottom=9t.m

Live loads: $P_L=134\text{t}$

M_L top=-7t.m

M_L bottom=5t.m

Earthquake loads: $P_E=60\text{t}$

M_E top=-23t.m

M_E bottom=47t.m

Concrete cover to centroid of bars=7cm

Solution:

The slenderness ratio kl/r is calculated as follows:

$$\text{radius of gyration, } r = \sqrt{\frac{I_g}{A}} = \sqrt{\frac{(0.7)^4 / 12}{0.7 \times 0.7}} = \sqrt{\frac{2 \times 10^{-2}}{0.7 \times 0.7}} = 0.202\text{m}$$

$$\frac{kl}{r} = \frac{2 \times 4}{0.202} = 39.6 > 22 \text{ for unbraced columns. so slenderness effect is to be considered}$$

Calculating the ultimate loads from load combinations:

The load combinations from the ACI318-99 are:

Combination1: $U=1.4D$

Combination2: $U=1.4D+1.7L$

Combination3: $U=0.75(1.4D+1.7L+1.87E)$

Combination4: $U=0.75(1.4D+1.7L-1.87E)$

Combination5: $U=0.9D+1.43E$

Combination6: $U=0.9D-1.43E$

It is very important to distinguish between the sway and nonsway loads, the gravity loads cause inconsiderable lateral deflection and so they are considered as nonsway loads. The earthquake loads cause considerable lateral deflection to the structure and so they are considered as sway loads.

A typical solution of this problem requires calculating the sway and nonsway moments in each load combination and then determining the magnification factors and the final design moments. The program AD RCS calculates the design moments and axial force for each load combination and gives the required area of steel for the design loads for each load combination. This is very long for hand calculations. In this problem the load combination3 is the critical and it will give the largest design combination of the bending moment and axial force. The load combination3 gives the maximum bending moment. The following calculations are done for load combination3.

$$P_u = 0.75(1.4 \times 280 + 1.7 \times 134 + 1.87 \times 60) = 549t$$

$$M_{us1} = 0.75(1.4 \times 13 + 1.7 \times 7) = -22.575t.m$$

$$M_{us1} = 0.75(1.87 \times 23) = -32.2575t.m$$

$$M_{u1} = -22.575 - 32.2575 = -54.8325t.m$$

$$M_{us2} = 0.75(1.4 \times 9 + 1.7 \times 5) = 15.825t.m$$

$$M_{us2} = 0.75(1.87 \times 47) = 65.9175t.m$$

$$M_{u2} = 15.825 + 65.9175 = 81.7425t.m$$

Calculate the magnification factors:

The nonsway magnification factor, δ_{ns} :

$$\delta_{ns} = \frac{C_m}{1 - \frac{P_u}{0.75P_{cr}}}$$

$$C_m = 0.6 + 0.4 \frac{M_1}{M_2}$$

$$P_{cr} = \frac{\pi^2 EI_e}{(kl_u)^2}$$

$$I_e = \frac{0.4I_g}{(1 + \beta_d)}$$

$$\beta_d = \frac{\text{maximum factored dead load}}{\text{total factored axial load}}$$

Applying the previous equations:

$$\beta_d = \frac{0.75 \times 1.4 \times 280}{549} = 0.5355$$

$$I_e = \frac{0.4 \times 2 \times 10^{-2}}{1 + 0.5355} = 5.21 \times 10^{-3} m^4$$

$$P_{cr} = \frac{\pi^2 \times (151000 \sqrt{240}) (5.21 \times 10^{-3})}{(2 \times 4)} = 1879.49t$$

$$C_m = 0.6 + 0.4 \frac{54.8325}{81.7425} = 0.8683$$

$$\delta_{ns} = \frac{0.8683}{1 - \frac{549}{0.75 \times 1879.49}} = 1.422$$

The sway magnification factor, δ_s :

$$\delta_s = \frac{1}{1 - \frac{P_u}{0.75 P_{cr}}}$$

$$I_e = \frac{0.4 \times 2 \times 10^{-2}}{1 + 0} = 8 \times 10^{-3} m^4 \quad \beta_d = 0$$

$$P_{cr} = \frac{\pi^2 \times (151000 \sqrt{240}) \times 8 \times 10^{-3}}{(2 \times 4)^2} = 2885.973t$$

$$\delta_s = \frac{1}{1 - \frac{549}{0.75 \times 2885.973}} = 1.34$$

The design moment will be:

$$M_c = M_{2ns} + \delta_s M_{2s} \quad \text{if} \quad \frac{l_u}{r} \leq \frac{35}{\sqrt{P_u / f'_c A_g}} \quad \text{and}$$

$$M_c = \delta_{ns} (M_{2ns} + \delta_s M_{2s}) \quad \text{if} \quad \frac{l_u}{r} > \frac{35}{\sqrt{P_u / f'_c A_g}}$$

$$\frac{l_u}{r} = \frac{4}{0.202} = 19.8 < \frac{35}{\sqrt{549/(2400 \times 0.7 \times 0.7)}} = 51.23 \quad \text{so,}$$

$$M_c = M_{2ns} + \delta_s M_{2s} = 15.825 + 1.34 \times 65.9175 = 104.15t.m$$

So, the section should be designed for:

$$P_u = 549t$$

$$M_u = 104.15t.m$$

The program AD RCS tries a steel ratio and does calculations for values of the neutral axis depth to reach the section capacity that is at least equals the applied design loads.

By trial and error $\rho = 0.02$ and the depth of neutral axis, $C = 53.2\text{cm}$

The stresses in the steel and then the axial force and bending moment capacities will be calculated.

$$A_s' = A_s = 0.02 \times 70 \times 70 / 2 = 49\text{cm}^2$$

$$f_{s1} = 6120 \frac{53.2 - 7}{53.2} = 5314.74\text{kg/cm}^2 > 4200\text{kg/cm}^2 \quad \text{so, } f_{s1} = 4200\text{kg/cm}^2$$

$$f_{s2} = 6120 \frac{63 - 53.2}{53.2} = 1127.37\text{kg/cm}^2$$

$$P_n = 0.85 f_c' b \beta_1 c + C_1 - T_1$$

$$C_s = A_s' f_{s1} = 49 \times 4200 / 1000 = 205.8t$$

$$T = A_s f_{s2} = 49 \times 1127.37 / 1000 = 55.24t$$

$$P_n = 0.85 \times 240 \times 70 \times 0.85 \times 53.2 / 1000 + 205.8 - 55.2 = 796.34t$$

$$M_n = \{(0.85 \times 240 \times 70 \times 0.85 \times 53.2 / 1000) \times (35 - 0.85 \times 53.2 / 2) + 205.8(35 - 7) + 55.2(35 - 7)\} / 100 = 152.53t.m$$

The capacity reduction factor, $\Phi = 0.7$ then

$$P_d = 0.7 \times 796.34 = 557.44t > 549t \quad \text{ok}$$

$$M_d = 0.7 \times 152.53 = 106.77t.m > 104.15t.m \quad \text{ok}$$

This problem is solved using AD RCS computer program and the results are shown in the following pages.

6.3 Problem three: Design of Single Footing:

Design a single footing that carries a service dead load of 120t and a service live load of 90t. $F_c' = 200 \text{ kg/cm}^2$. $F_y = 4200 \text{ kg/cm}^2$. Soil allowable bearing capacity, $Q_a = 30 \text{ t/m}^2$. Concrete cover = 10cm. Column dimensions: 30x60cm.

Solution:

1. Find footing area and dimensions:

$$A_f = \frac{P_d + P_l}{Q_a} = \frac{120 + 90}{30} = 7 \text{ m}^2$$

$$B = 2.5 \text{ m}, L = 2.8 \text{ m}$$

$$P_u = 1.4(120) + 1.7(90) = 321 \text{ t}$$

$$Q_u = \frac{321}{2.5(2.8)} = 45.86 \text{ t/m}^2$$

$$\text{average load factor} = \frac{321}{210} = 1.53$$

Find footing depth:

$$V_u = Q_u(a - d) = 45.86(1.1 - d)$$

$$\phi V_c = 0.53 \sqrt{f_c'} b d = 0.53 \sqrt{200} (1) d (10)$$

$$\text{from } V_u = \phi V_c, d = 0.465 \text{ m}$$

Check d for punching shear:

$$V_{cp} \leq \phi 1.06 \sqrt{f_c'} = 0.85(1.06) \sqrt{200} = 12.74 \text{ kg/cm}^2$$

$$P_{d \text{ punching}} = V_{cp} A_{cr} = 12.74(30 + 46.5 + 60 + 46.5)(2)(46.5) / 1000 = 216.8 \text{ t}$$

$$P_{u \text{ punching}} = 321 - (0.3 + 0.465)(0.6 + 0.465)(45.86) = 283.64 \text{ t} > 216.8 \text{ t} \quad \text{N.G}$$

So, the effective depth, d should be increased.

By trial and error or by solving equations, $d = 0.55 \text{ m}$

Footing total depth = $0.55 + 0.1 = 0.65 \text{ m}$

2. Calculate areas of flexural steel:

$$M_u = Q_u \frac{a^2}{2} = 45.86 \frac{1.1^2}{2} = 27.74$$

$$\rightarrow A_s = 13.74 \text{ cm}^2 / m$$

in long direction :

$$A_{s \text{ total}} = 13.74(2.5) = 34.35 \text{ cm}^2$$

in short direction :

$$A_{s \text{ total}} = 13.74(2.8) = 38.472 \text{ cm}^2$$

$$A_{s \text{ center}} = \frac{2}{\beta + 1} A_s = \frac{2}{(2.8/2.5) + 1} 38.472 = 36.29 \text{ cm}^2$$

$$A_{s \text{ sides}} = 38.472 - 36.29 = 2.18 \text{ cm}^2$$

This problem is solved using the AD RCS computer program and the results are shown in the following pages.

Chapter Four

Quick Tutorials

In this chapter, quick tutorials will be introduced to make the user familiar with the program. Two examples will be solved using the program and the detailed steps are to be introduced. The first example will be analysis of two sections; beam and column sections. The second will be design of two sections; beam and column.

4.1 Tutorial one:

Analyze the following two sections:

section 1: beam, width = 40cm, depth = 70cm, bottom steel = 6 Φ 25mm, top steel = 4 Φ 16mm, concrete cover to longitudinal bars center = 6cm, $f'_c = 240\text{kg/cm}^2$, $f_y = 4200\text{kg/cm}^2$. Shear reinforcement: 1 Φ 10mm/15cm.

Section 2: column, width = 30cm, depth = 50cm, concrete cover = 5cm, reinforcement = 10 Φ 18mm (2 bars 5 layers with equal spacings), $f'_c = 200\text{kg/cm}^2$, $f_y = 4200\text{kg/cm}^2$.

Shear reinforcement: 1 Φ 10mm/15cm.

Steps:

1. Click on the program icon or short cut in the computer, the first dialog of the program will be displayed showing the name of the program and then the **Analysis and Design of Reinforced Concrete Sections** dialog box will be displayed as shown in Figure 4.1. Click on the option " (English) 简体" and on the option "kN·m (ton. Meter)" to choose the English language and the ton. meter units. Click **ok**. This will display the program main form with the menu and the tool bar.

2. Select **New Project** from the **File** menu. This will display the **New Project** dialog box. Write project1 in the text box **Project Name** and select analysis then write 2 in the text box **Number of Sections to Analyze**. Then click **ok**. This will display a list of the element sections to be analyzed at the top left corner of the program screen.
3. From the **Define** menu, select **Materials**. This will display the **Define Materials** dialog box as shown in Figure 4.2. Two materials are to be added because of having two types of materials for the beam and column sections

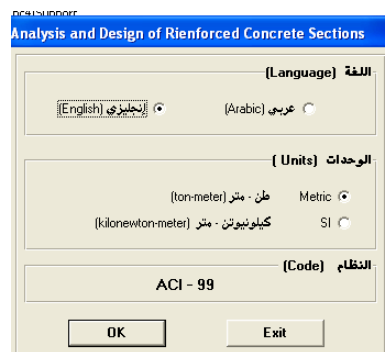
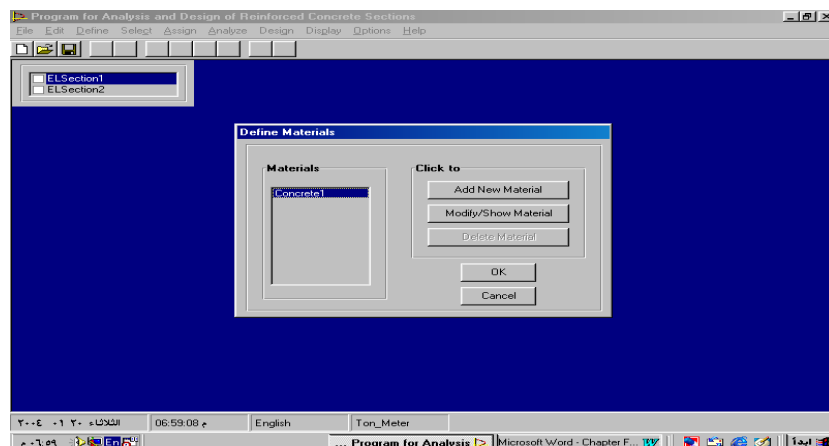

Figure 4.1 Analysis and Design of Reinforced Concrete Sections dialog



box

Figure 4.2 Define Materials dialog box

Click on the **Modify/Show Material** button to modify or set the material properties. This will display the **Material Property Data** dialog. In this dialog set the values of the concrete compressive strength and the main and shear steel yield strength in the specified text boxes; the concrete compressive strength, $f'_c = 2400\text{t/m}^2$ and the steel yield strength for the main steel and shear steel are 42000t/m^2 . Click ok to accept the values for the material of the first element section.

Click on the **Add New Material** command button to add a new material. This will display the **Material Property Data** dialog box. In this dialog, set in the edit boxes the concrete compressive strength to 2000t/m^2 and the steel yield strength of the main and shear steel to 42000t/m^2 . Then click **ok**. (The material name is concrete2, one can change the name of material at any stage of program running). The two materials are displayed in the Materials list in the **Define Materials** dialog box. Click **ok**. (you can rename the materials as beamCon and ColumnCon, for example).

4. From the **Define** menu, select **Sections**. This will display the **Define Frame Sections** dialog box. Click on the **Modify/Show Section** command button. This will display the default **Show Rectangular Section** dialog box. In this dialog, write 0.7 in the depth, HW text box and write 0.4 in the Width, BW text box. The size of the rectangular section in the picture will be modified. The material type is concrete1 as it is found in the list besides the

Materials label. Click on the **Section Data** command button to specify further properties of FRSEC1 section. This will display the **Beam- Column Data** dialog box. In this dialog, set the concrete cover to rebar center to 0.06 for the top, bottom and sides covers. The **Beam** option is chosen (see Figure 4.3). Then click **ok** to accept the input data. Click **ok** in the **Show Rectangular Section** dialog to accept the data of the first section.

Select **Add Rectangle** from the **Add New Section** List. This will display the **Add Rectangular Section** dialog box. In this dialog, the name of the section is FRSEC2. Select concrete2 for the material name. Set the depth to 0.5 and the width to 0.3 as shown in Figure 4.4. Click on the Section Data command button to specify further settings. This will display the **Beam-Column Data** dialog box. In this dialog, click on the column option. Write 0.05 in the text box for the concrete cover to rebar center. The column height is not needed for determining section interaction diagram, so no need to change the column height. Click **ok** and then click **ok** in the **Add Rectangular Section** dialog box. The two sections will be displayed in the sections list in the **Define Frame Sections** dialog box. Click **ok**.

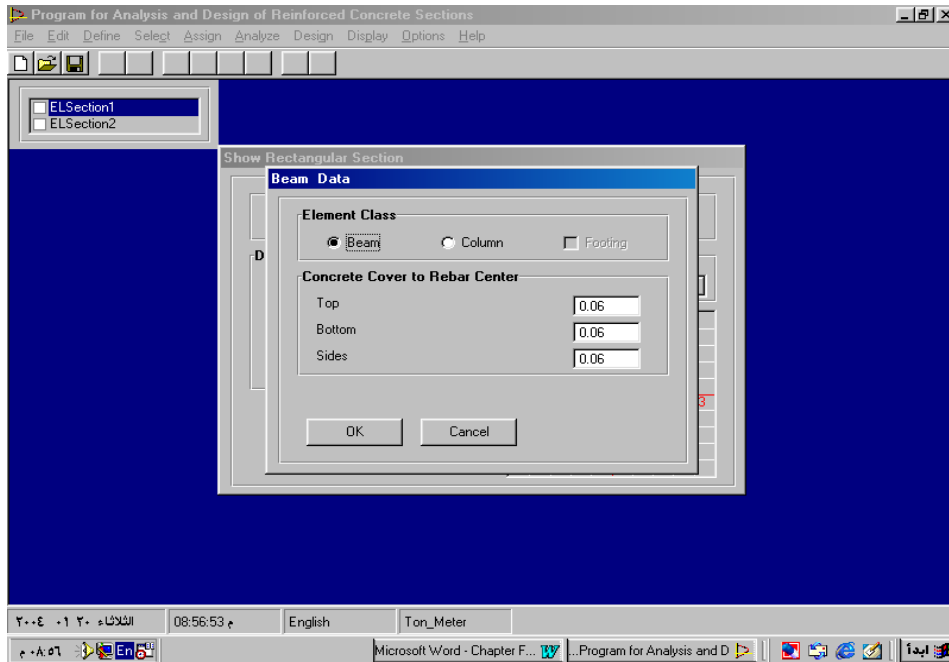

Figure 4.3 Beam Data dialog box

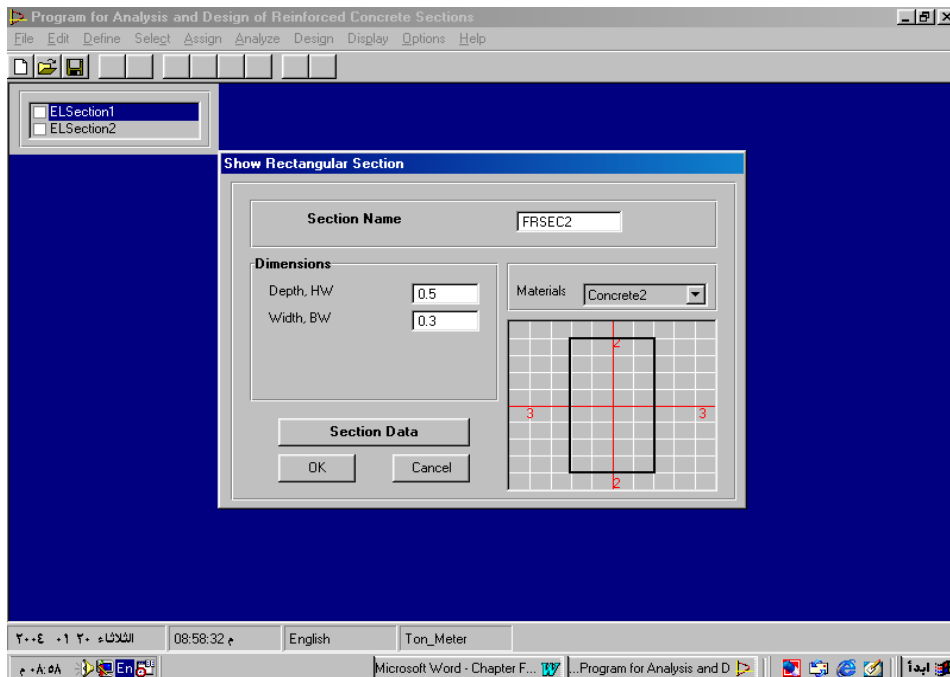

Figure 4.4 Show Rectangular Section dialog box for section2

5. The section names should be assigned to the element sections in the elements list. Click on the first element section ELSection1 in the elements sections list and then select the **Sections** submenu from the **Assign** menu. This will display the **Define Frame Sections** dialog. Click on FRSEC1 from the sections list to assign this name to the first element section ELSection1 in the list then click **ok**.

Click on the ELSection2 in the elements sections list. Select the **Sections** submenu from the **Assign** menu. This will display the **Define Frame Sections** dialog. Click on FRSEC2 from the sections list to assign this name to the second element section ELSection2 in the list then click **ok** as shown in Figure 4.5.

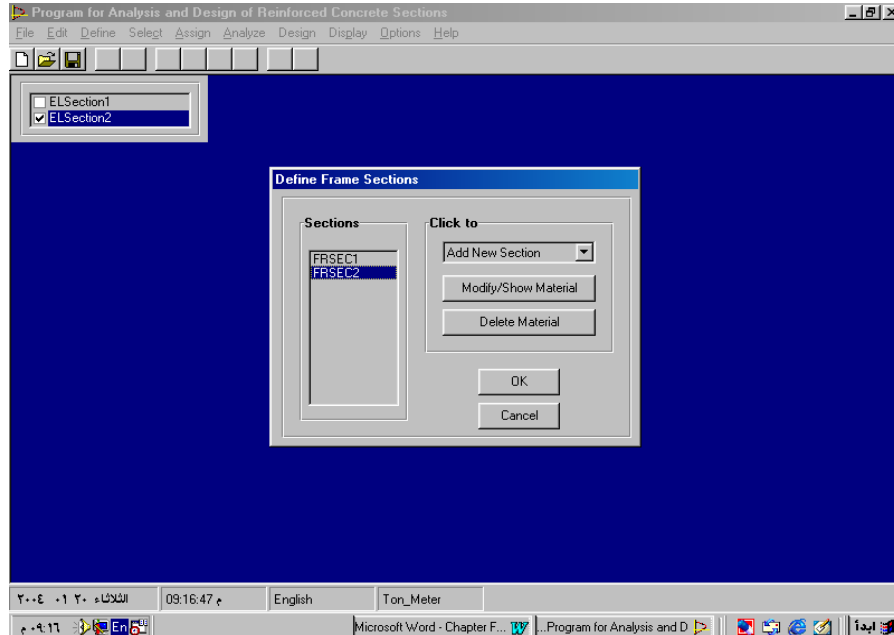

Figure 4.5 Assign FRSEC2 to ELSection2 element section

6. The reinforcement will be assigned to the element section in this step. Click on the ELSection1 in the element sections list, then select **Reinforcement** submenu from the **Assign** menu. This will display the **Assign Beam Reinforcement** dialog box. In this dialog, the top steel is 4 bars of 16mm diameter and the bottom steel is 6 bars of 25mm diameter. The shear reinforcement is 1 stirrup of 10mm diameter at 15cm spacing as shown in Figure 4.6. click **ok**.

Click on the ELSection2 in the element sections list and then select **Reinforcement** submenu from the **Assign** menu. This will display the **Assign Column Reinforcement** dialog box. No. of rebars in direction 3-3 is 2, no. of rebars in direction 2-2 is 5 (10 bars) and the bar diameter is 18mm. For shear reinforcement, the number of bars is 1, the bar diameter is 10mm and the bars spacing is 15cm. Click **ok**.

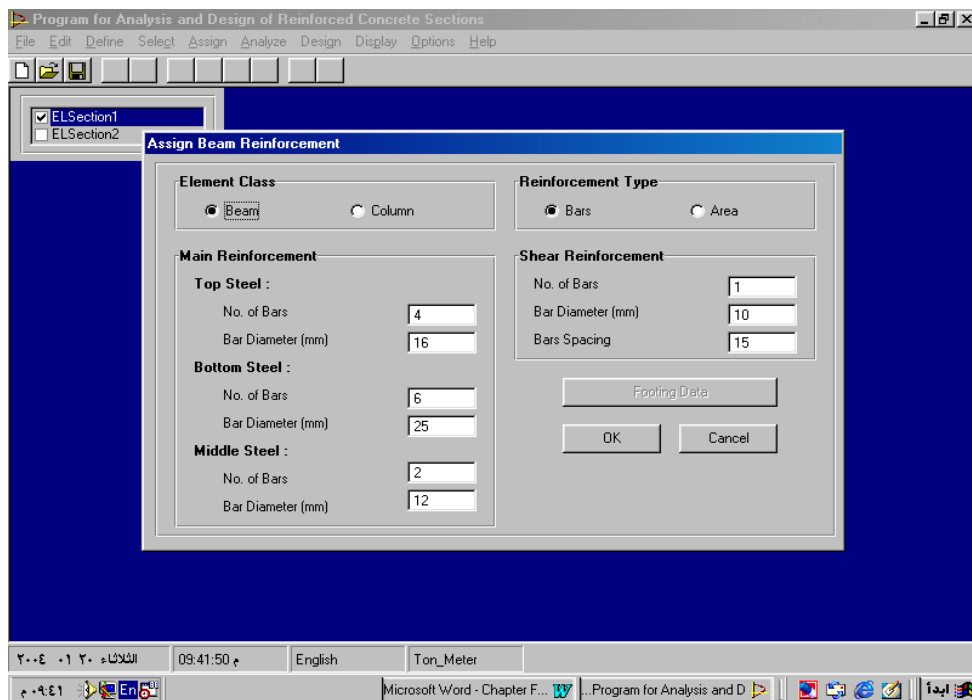

Figure 4.6 Assign Beam Reinforcement dialog box

7. From the **Analyze** menu, select **Start Analysis/ Show Results** submenu, this runs the analysis and displays the **Show Analysis Output** dialog box as shown in Figure 4.8.

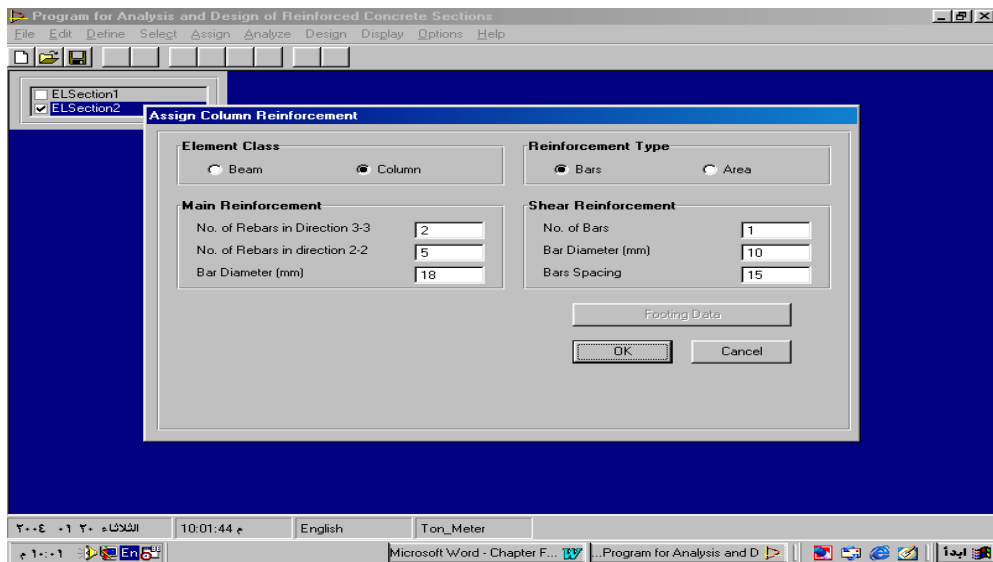

Figure 4.7 Assign Column Reinforcement dialog box

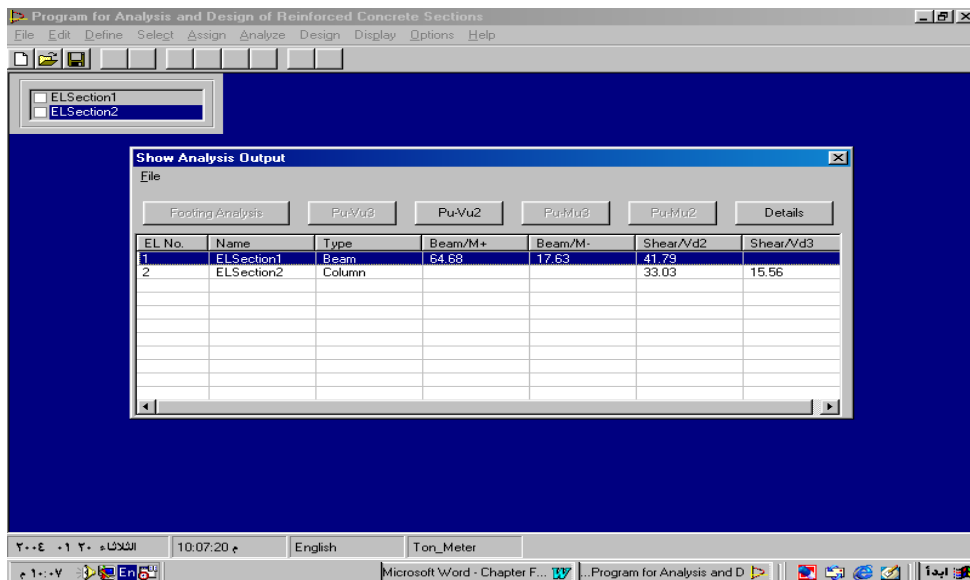

Figure 4.8 Show Analysis Output dialog box



Figure 4.9 P-V2 Beam Interaction Diagram dialog box

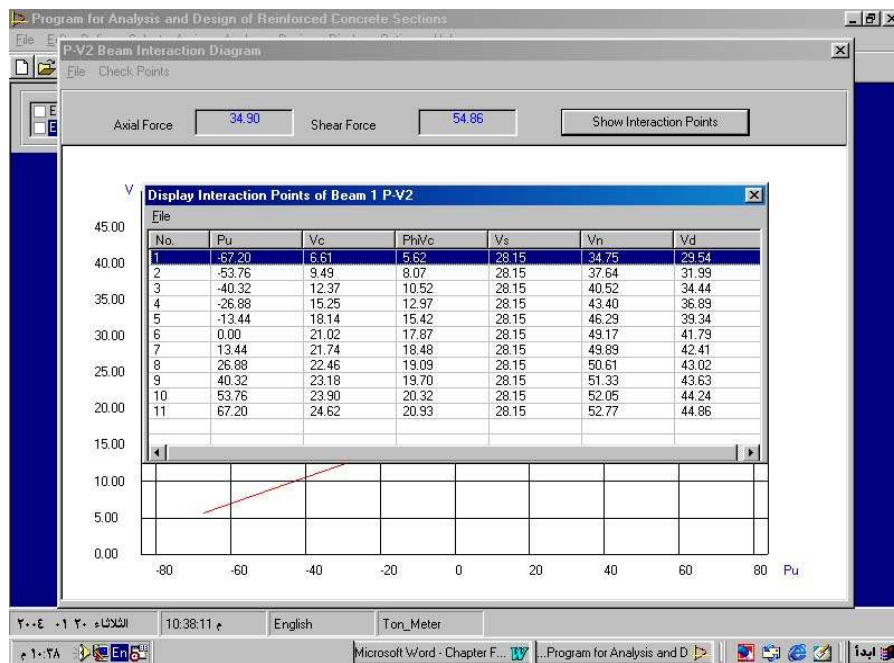
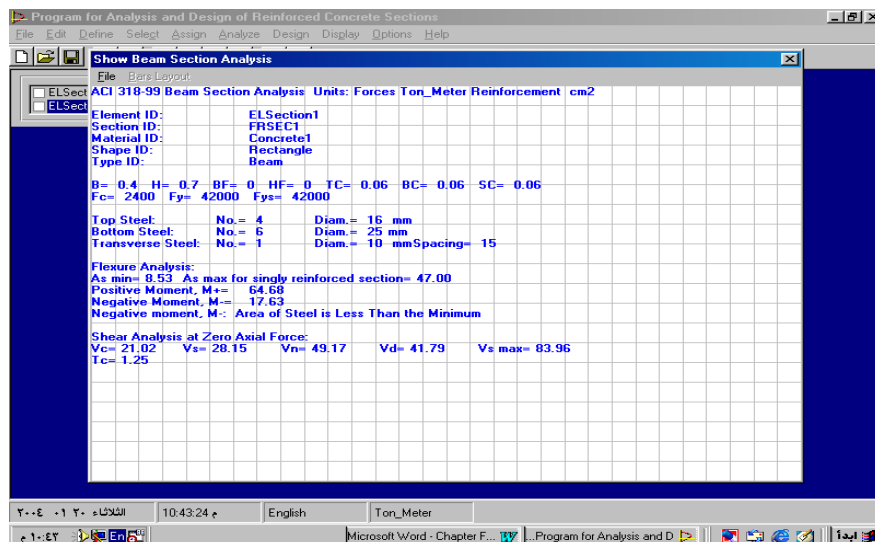

Figure 4.10 Display Interaction Points of Beam 1 P-V2 dialog box

Click on the **Pu-Vu2** command button to display the interaction curve between the axial load and the shear force capacities of the analyzed beam section, this will display the P-V2 Beam interaction diagram as shown in Figure 4.9. The diagram shows the design shear capacity, V_d and the concrete shear capacity ΦV_c . moving the mouse pointer on the diagram will display the coordinates of the point; the applied axial force and the corresponding design shear capacity, V_d . Click on the **Show Interaction Points** command button to display the points of the P-V diagram in table. This will display the **Display Interaction Points of Beam1 P-V2** dialog box (table) as shown in Figure 4.10.

Close the displayed two dialog boxes. Click on the **Details** command button, this will display the **Show Beam Section Analysis** dialog box as shown in Figure 4.11. This dialog shows details of analysis of the beam section.

Figure 4.11 Show Beam Section Analysis dialog box



Close the dialog.

Click on the second element section in the Show Analysis Output dialog, this will activate other command buttons that are related to column sections.

Click on the **Pu-Mu3** command button to show the axial force - bending moment capacities interaction diagram. This will display the **P-M3 Column Interaction Diagram** dialog box as shown in Figure 4.12. Moving the mouse pointer on the diagram will show the axial force and the bending moment capacities at a point. Click on **Show Interaction Points** command button to show the tabled points of the interaction diagram as shown in Figure 4.13. This will display the **Display Interaction Points of Column 2 P-M3** dialog box.

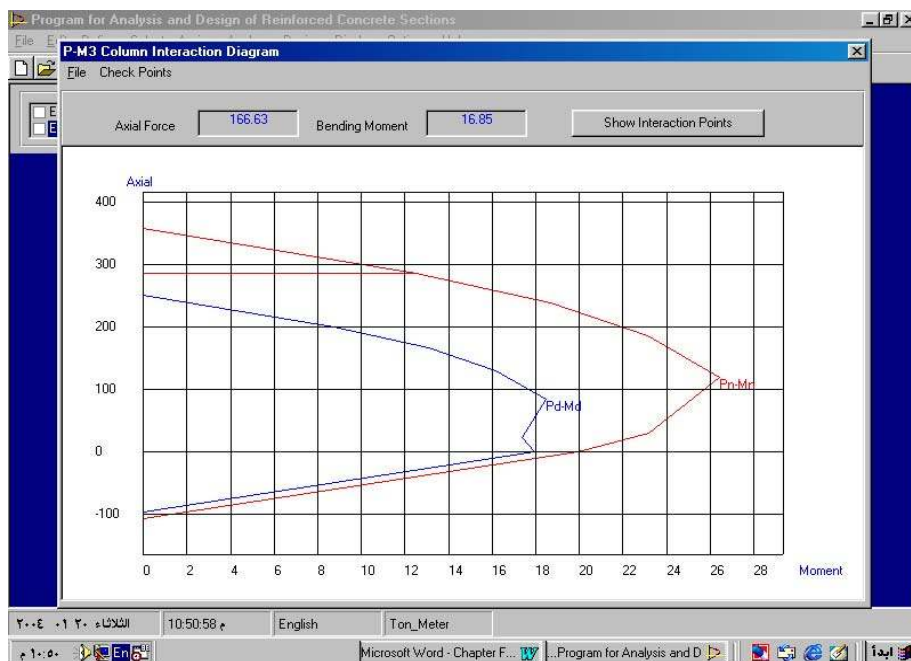

Figure 4.12 P-M3 column Interaction Diagram dialog box

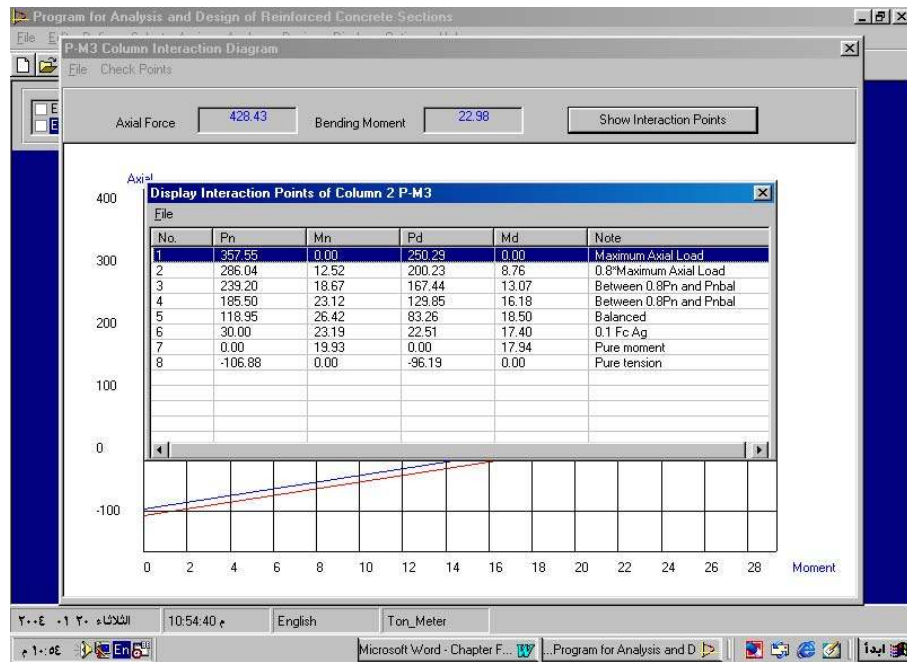

Figure 4.13 Display Interaction Points of Column 2 P-M3 dialog box
Close the last displayed dialog.

In the **P-M3 Column Interaction Diagram** dialog box, click on the **Check Points** menu to get the values of the axial force and bending moment capacities at a specified eccentricity and the bending moment capacity at a specified axial force. This will display the **Calculating Interaction Points** dialog box. If it is required to find the axial force and the bending moment capacities of the column at 0.15m eccentricity, click on **Eccentricity, e** option button and then write 0.15 in the eccentricity text box. Click **ok**, the values of the capacities will be displayed in the output results frame as shown in Figure 4.14.

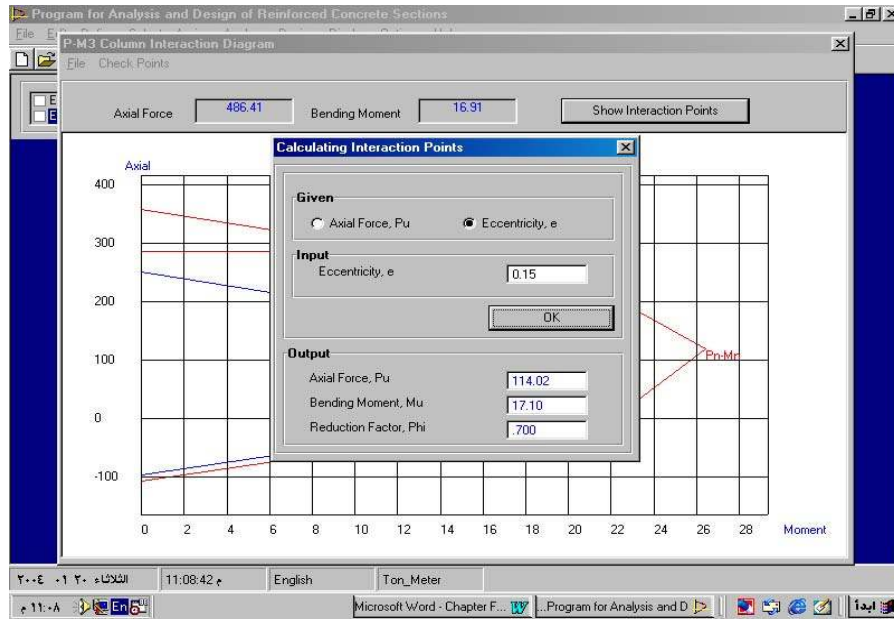

Figure 4.14 Calculating Interaction Points dialog box

Close the displayed forms except the **Show Analysis Output** dialog box. Click on the Details command Button to see the analysis details of the column section. This will display the **Show Column Section Analysis** dialog box as shown in Figure 4.15.

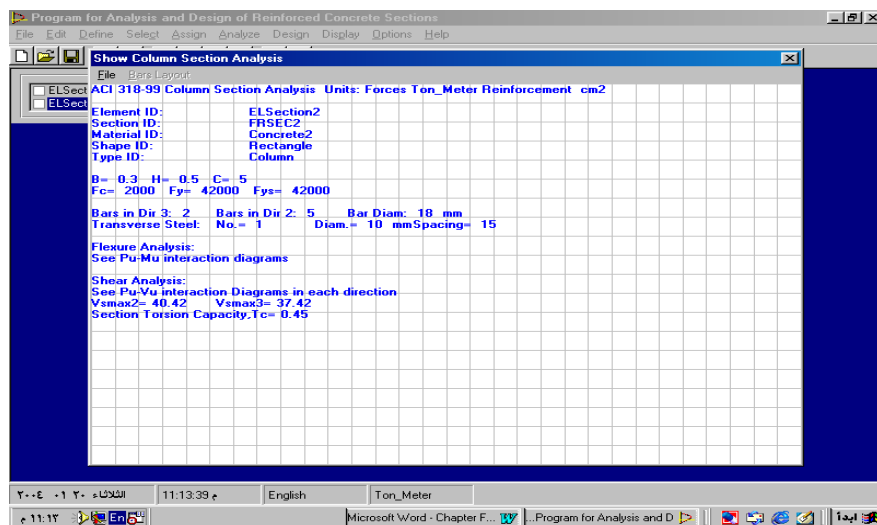

Figure 4.15 Show Column Section Analysis dialog box

8. From the **File** menu, select **Save**. This will display the **Save As** dialog box. Select the directory you wish to save the file in and then write the name of file in the File name edit box, for example, write **tutorial1**, then click on the **Save** button. The program saves only the input data.
9. The saved file can be opened by selecting the **Open** menu from the **File** menu.

4.2 Tutorial Two:

Design the following two sections:

section 1: beam, given: width = 80cm, depth = 30cm, concrete cover to longitudinal bars center = 5cm, $f'_c = 240\text{kg/cm}^2$, $f_y = 4200\text{kg/cm}^2$, ultimate positive bending moment = 15t.m, ultimate shear force = 20t, use $\Phi 18\text{mm}$ for main steel and $\Phi 8\text{mm}$ for shear reinforcement.

Section 2: column, given: width = 30cm, depth = 50cm, concrete cover = 5cm, reinforcement configuration: use 10 bars, (2 bars 5 layers with equal spacings), $f'_c = 200\text{kg/cm}^2$, $f_y = 4200\text{kg/cm}^2$. Dead loads: $P = 60\text{t}$, $M_3 \text{ top} = 6\text{t.m}$, $M_2 \text{ top} = 4\text{t.m}$. Live loads: $P = 40\text{t}$, $M_3 \text{ top} = 5\text{t.m}$, $M_2 \text{ top} = 2\text{t.m}$. Column height = 3m.

Steps:

1. Click on the program icon or short cut in the computer, the first dialog of the program will be displayed showing the name of the program and then the **Analysis and Design of Reinforced Concrete Sections** dialog box will be displayed. Click on the option " (English) 繁體中文" and on the option "kN.m (ton. Meter)" to choose the

English language and the ton. meter units. Click **ok**. This will display the program main form with the menu and the tool bar.

2. Select **New Project** from the **File** menu. This will display the **New Project** dialog box. Write project2 in the text box **Project Name** and select **Design** then write 2 in the text box **Number of Sections to Design**. Then click **ok**. This will display a list of the element sections to be designed at the top left corner of the program screen.
3. From the **Define** menu, select **Materials**. This will display the **Define Materials** dialog box. Two materials are to be added because of having two types of materials for the beam and column sections.

Click on the **Modify/Show Material** button to modify or set the material properties. This will display the **Material Property Data** dialog box. In this dialog set the values of the concrete compressive strength and the main and shear steel yield strength in the specified text boxes; the concrete compressive strength, $f'_c = 2400\text{t/m}^2$ and the steel yield strength for the main steel and shear steel are 42000t/m^2 . Click **ok** to accept the values for the material of the first element section.

Click on the **Add New Material** command button to add a new material for the second section. This will display the **Material Property Data** dialog box. In this dialog, set in the edit boxes the concrete compressive strength to 2000t/m^2 and the steel yield strength of the main and shear steel to 42000t/m^2 . Then click **ok**. (The material name is concrete2, one can change the name of material and/or the material properties at any stage of program running). The two materials are displayed in the Materials list in the **Define Materials** dialog box. Click **ok**.

4. From the **Define** menu, select **Sections**. This will display the **Define Frame Sections** dialog box. Click on the **Modify/Show Section** command button. This will display the **Show Rectangular Section** dialog box. In this dialog, write 0.3 in the depth, HW text box and write 0.8 in the Width, BW text box. The size of the rectangular section in the picture will be modified. The material type is concrete1 as it is found in the list besides the **Materials** label. Click on the **Section Data** command button to specify further properties of FRSEC1 section. This will display the **Beam Data** dialog box. In this dialog, set the concrete cover to rebar center to 0.05 for the top, bottom and sides covers. The **Beam** option is chosen. Then click **ok** to accept the input data. Click **ok** in the **Show Rectangular Section** dialog to accept the data of the first section.

Select **Add Rectangle** from the **Add New Section** List. This will display the **Add Rectangular Section** dialog box. In this dialog, the name of the section is FRSEC2. Select concrete2 for the material name. Set the depth to 0.5 and the width to 0.3. Click on the **Section Data** command button to specify further settings. This will display the **Beam Data** dialog box. In this dialog, click on the column option. Write 0.05 in the text box for the concrete cover to rebar center. Click **ok** and then click **ok** in the **Add Rectangular Section** dialog box. The two sections will be displayed in the sections list in the **Define Frame Sections** dialog box. Click **ok**.

5. The section names should be assigned to the element sections in the elements list. Click on the first element section ElSection1 in the elements sections list and then select the **Sections** submenu from the

Assign menu. This will display the **Define Frame Sections** dialog. Click on FRSEC1 from the sections list to assign this name to the first element section ELSection1 in the list then click **ok**.

Click on the ELSection2 in the elements sections list. Select the **Sections** submenu from the **Assign** menu. This will display the **Define Frame Sections** dialog. Click on FRSEC2 from the sections list to assign this name to the second element section ELSection2 in the list then click **ok**.

6. From the **Define** menu, select **Design Load Combinations**. This will display the **Define Load Combinations** dialog box as shown in Figure 4.16. The default load combinations are for ACI318-99. The factors in each load combination can be modified. Check on the last load combination to be used for the beam section, as the loads are the ultimate for the beam section. Click **ok**.
7. Select the first element section from the element sections list. Then, from the **Assign** menu select **Forces**. This will display the **Assign Beam Forces** dialog box. In this dialog, write 20 in front of the load case **other** and under Shear2 and write 15 under Moment3 as shown in Figure 4.17 (axis 2 is the vertical and axis 3 is the horizontal). Click **ok**.

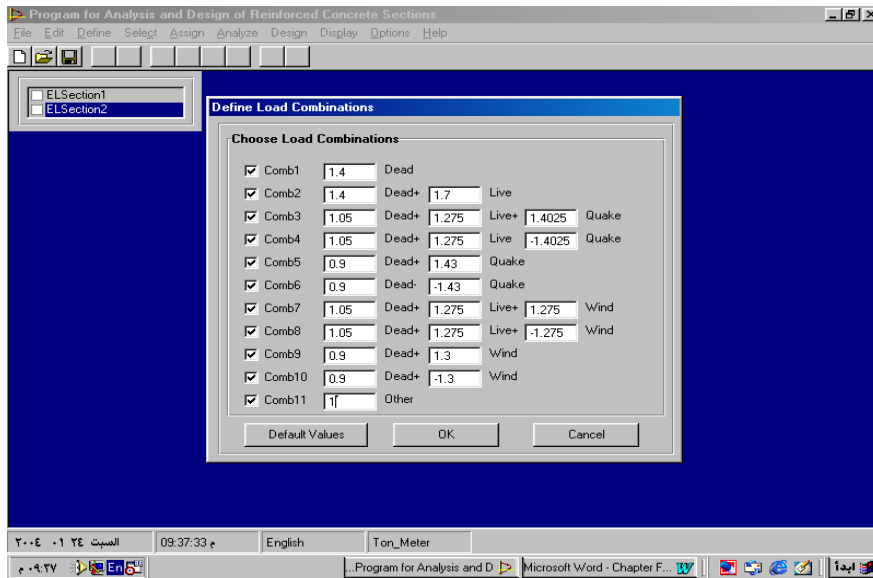

Figure 4.16 Define Load Combinations dialog box

8. Select the second element section from the element sections list. Then from the **Assign** menu select **Forces**. This will display the **Assign Column Forces** dialog box. In this dialog, write 60 and 40 for the dead and live axial loads respectively. Also, write 6 and 4 for Moment3 and Moment2 dead loads respectively as top moments. And write 5 and 2 for Moment3 and Moment2 live loads top moments respectively as shown in Figure 4.18. Click **ok**.

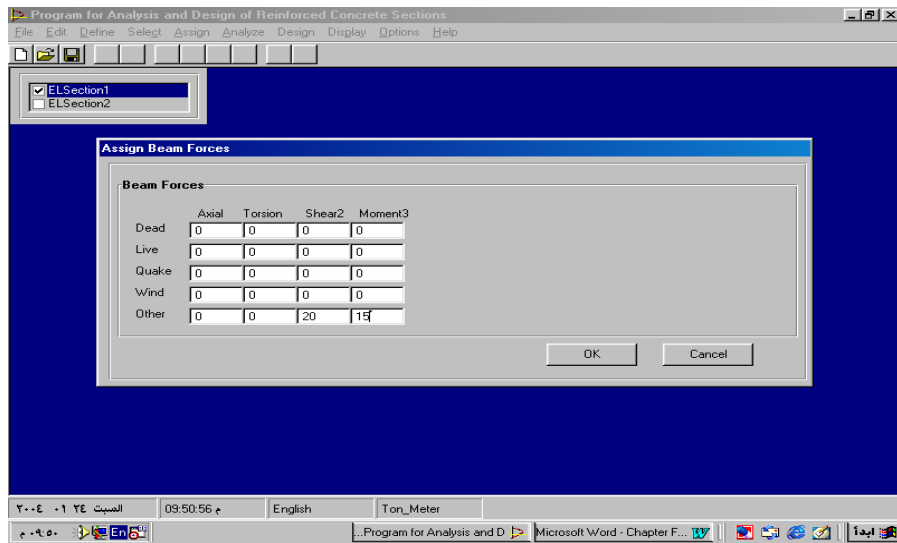

Figure 4.17 Assign Beam Forces dialog box

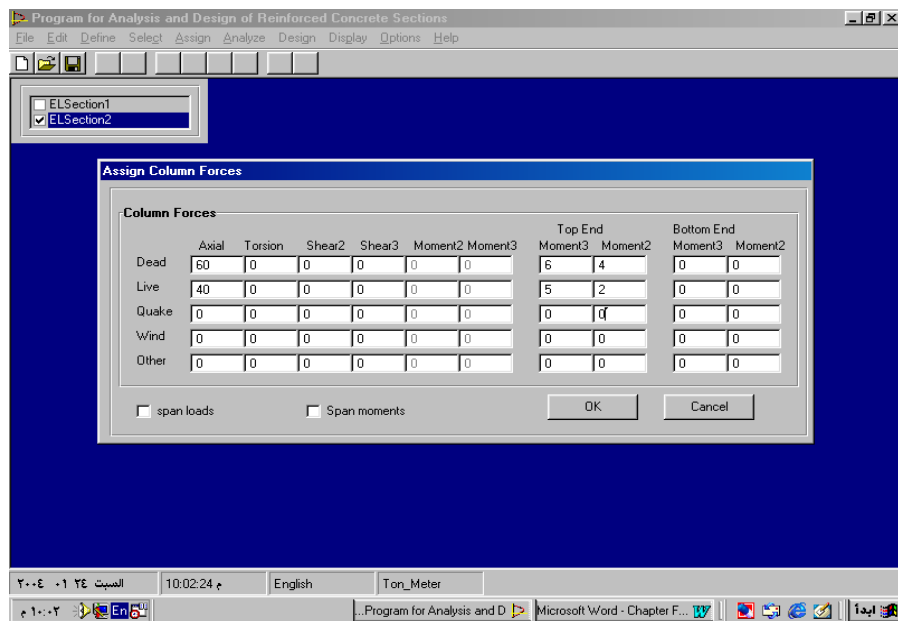

Figure 4.18 Assign Column Loads dialog box

9. Select the first element section in the elements sections list and then click on the **Assign** menu and select **Reinforcement Design Options** menu. This will display the **Assign Beam Reinforcement** dialog box as shown in Figure 4.19. In this dialog, change the bars diameter from 16mm to 18mm. Then click **ok**.

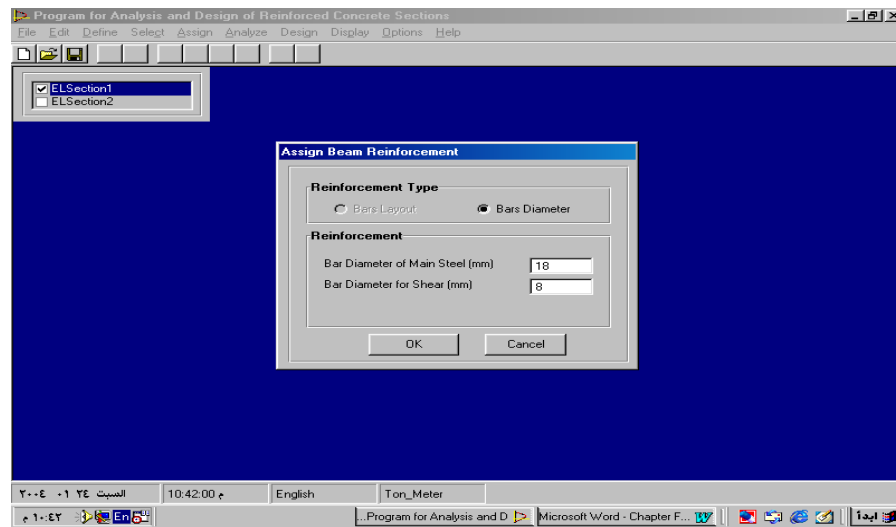

Figure 4.19 Assign Beam Reinforcement dialog box

10. Select the second element section in the elements sections list and then click on the **Assign** menu and select **Reinforcement Design Options** menu. This will display the **Assign Column Reinforcement** dialog box as shown in Figure 4.20. In this dialog, click on the option **Bars Layout**. Write 2 and 5 for the bars in directions 3 and 2 respectively.
11. From the **Design** menu, select **Start Design/Show Results**. This will display the **Show Design Output** dialog box as shown in Figure 4.21.

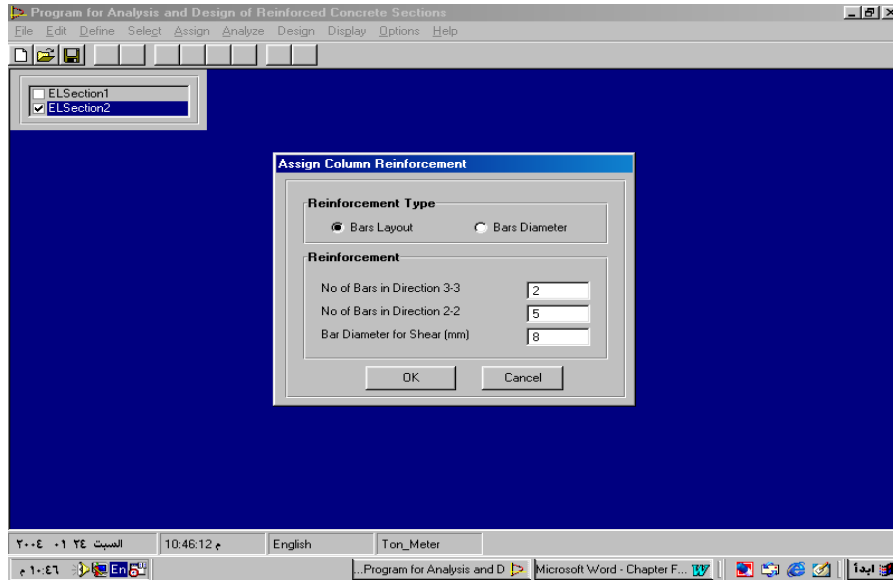

Figure 4.20 Assign Column Reinforcement dialog box

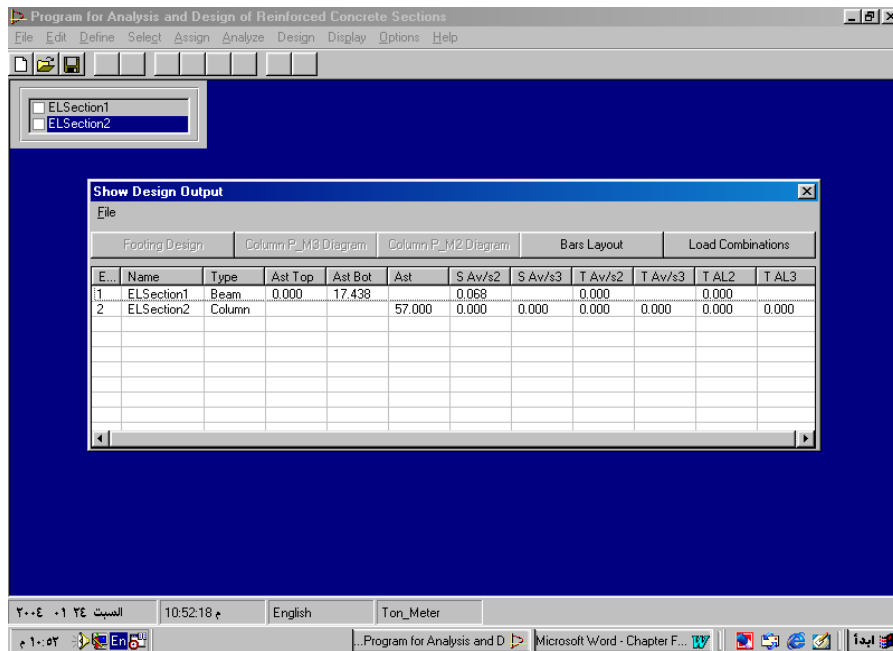

Figure 4.21 Show Design Output dialog box

Click on the first row in the table (the beam section). Then click on the command button **Bars Layout**, this will display the **Show Bars Layout** dialog box as shown in Figure 4.22. Then close the dialog box. Click on the button **Load Combinations**, this will display a table for the design output of the eleven load combinations as shown in Figure 4.23.

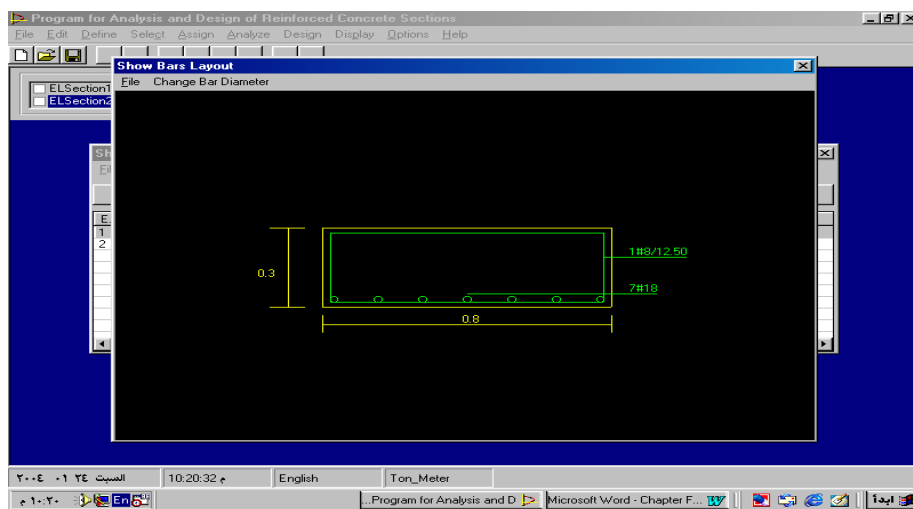

Figure 4.22 Show Bars Layout dialog box for the beam section

EL No.	Comb.	Ast Top	Ast Bot	Ast	S Av/s2	S Av/s3	T Av/s2	T Av/s3	T AL2	T AL3
1	1	0.000	0.000	0.000	0.000	0.000	0.000	0.000	0.000	0.000
1	2	0.000	0.000	0.000	0.000	0.000	0.000	0.000	0.000	0.000
1	3	0.000	0.000	0.000	0.000	0.000	0.000	0.000	0.000	0.000
1	4	0.000	0.000	0.000	0.000	0.000	0.000	0.000	0.000	0.000
1	5	0.000	0.000	0.000	0.000	0.000	0.000	0.000	0.000	0.000
1	6	0.000	0.000	0.000	0.000	0.000	0.000	0.000	0.000	0.000
1	7	0.000	0.000	0.000	0.000	0.000	0.000	0.000	0.000	0.000
1	8	0.000	0.000	0.000	0.000	0.000	0.000	0.000	0.000	0.000
1	9	0.000	0.000	0.000	0.000	0.000	0.000	0.000	0.000	0.000
1	10	0.000	0.000	0.000	0.000	0.000	0.000	0.000	0.000	0.000
1	11	0.000	17.438	0.0677	0.000	0.000	0.000	0.000	0.000	0.000

Figure 4.23 Load combinations design output for the beam section

One can select (click on) any load combination in the table and then clicks on the button **Details** to display some details of the analysis procedure. Click on the second element section in the table. This will activate the **Column P-M3 Diagram** and **Column P-M2 Diagram** buttons. Clicking on these buttons will display the axial load- bending moment interaction diagrams in the major and minor direction of the column respectively. Click on the button **Bars Layout**. This will display the section reinforcement details as shown in Figure 4.24.

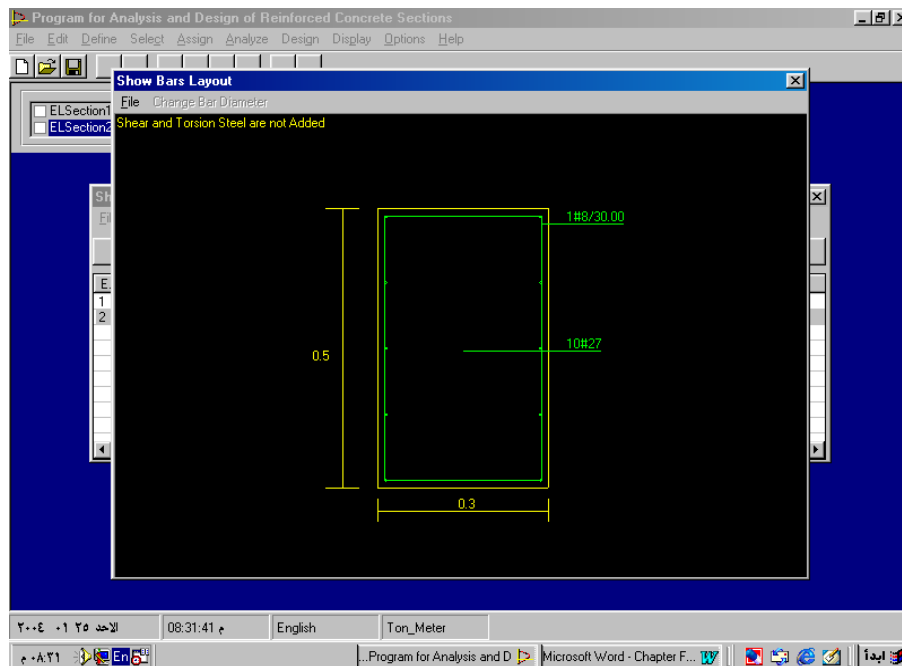

Figure 4.24 Show bars Layout dialog box for the column section

From the bars layout dialog box, the reinforcement needed is 10 $\Phi 27$ mm bars. This reinforcement is not practical. The reinforcement configuration (bars distribution) can be changed and so the final reinforcement will be achieved. The reinforcement configuration can be modified by selecting the column section from the sections elements list and select **Design Reinforcement Options** from the **Assign** menu and redo the design.

Detailed description of steps for using the program will be introduced in the following chapter; chapter five and verification problems will be introduced in chapter six.

Bibliography

1. ACI Committee 318: **Building Code Requirements for Structural Concrete (ACI 318-99) and Commentary (ACI 318R-99)**. American Concrete Institute, Farmington Hills, MI, 1999
2. Bob Reselman, Wayne Pruchniak, Richard A. Peasly and Eric A. Smith: **Practical Visual Basic 6**. A Division of Macmillan Computer Publishing, USA, 1998
3. Edward G. Naway: **Reinforced Concrete Design A Fundamental Approach**. Forth edition, Prentice Hall, 2000
4. Joseph E. Bowles: **Foundation Analysis and Design**. Fifth edition, McGraw-Hill Companies, Inc., 1996
5. Wang, Chu-Kia and Salmon, Charles G.: **Reinforced Concrete Design**. Fifth edition, HarperCollins Publishers, 1992
6. ايريك بريلي، أنطوني برنس ودافيد رينالدي: **Visual Basic 6 How To**. ترجمة مركز التعريب والترجمة، الدار العربية للعلوم، 1999
7. ستيف براون: **Visual Basic 6 in Record Time**. دار الفاروق للنشر والتوزيع، 1999
8. مايكل هالفرسون: **خطوة خطوة 6 Microsoft Visual Basic**. ترجمة مركز التعريب والترجمة، الدار العربية للعلوم، 1999

ADRCS に関する
資料

ADRCS に関する資料

AD RCS に関する資料

(一)

ADRCS に関する資料

ADRCS

ADRCS (一)

ADRCS に関する資料
ADRCS に関する資料

