

**NASA
Technical
Paper
3627**

September 1996

**Development and Flight
Evaluation of an Emergency
Digital Flight Control System
Using Only Engine Thrust
on an F-15 Airplane**

Frank W. Burcham, Jr., Trindel A. Maine,
C. Gordon Fullerton, and Lannie Dean Webb



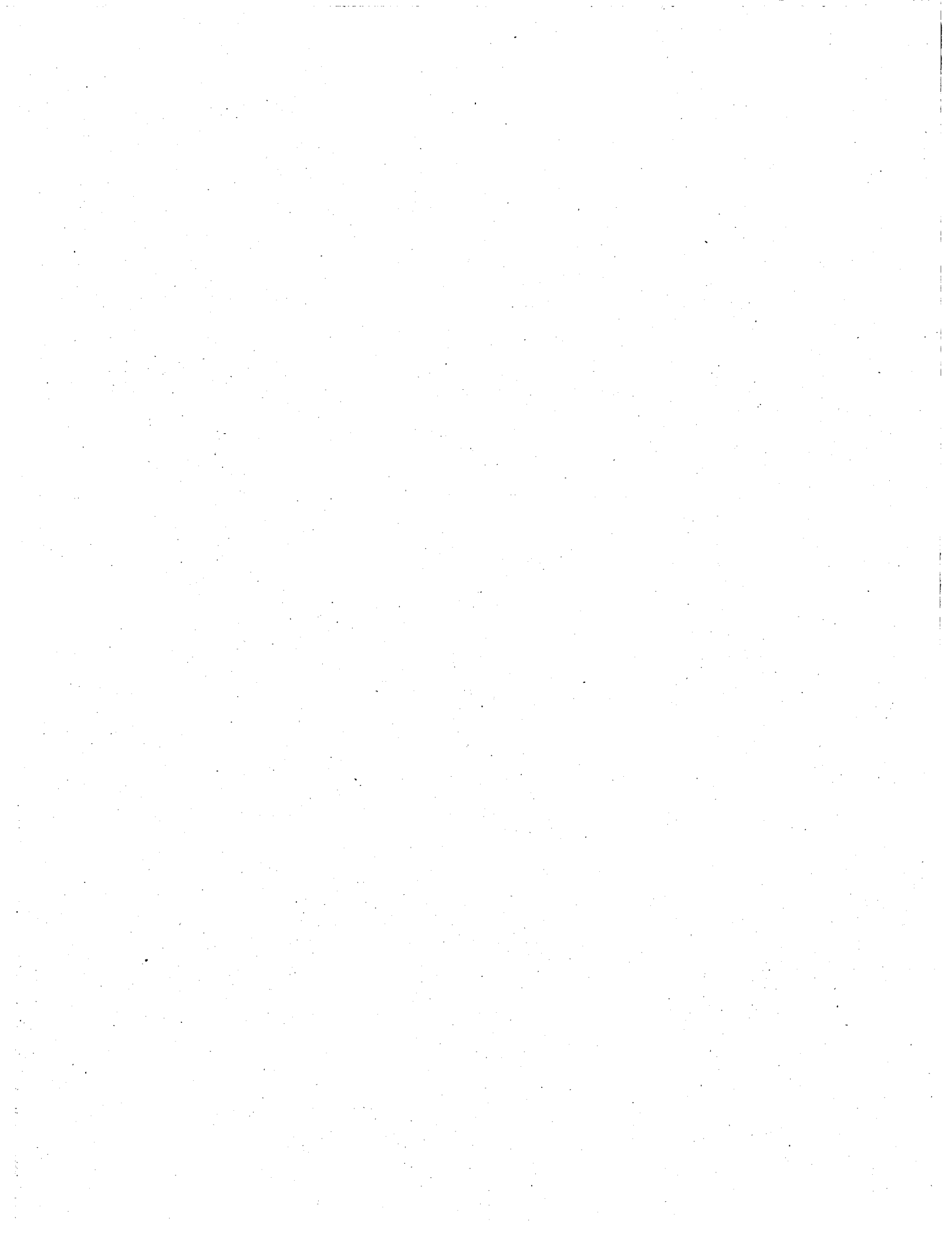

**NASA
Technical
Paper
3627**

1996

**Development and Flight
Evaluation of an Emergency
Digital Flight Control System
Using Only Engine Thrust
on an F-15 Airplane**

Frank W. Burcham, Jr., Trindel A. Maine,
C. Gordon Fullerton, and Lannie Dean Webb
*Dryden Flight Research Center
Edwards, California*



National Aeronautics and
Space Administration
Office of Management
Scientific and Technical
Information Program

CONTENTS

	<u>Page</u>
ABSTRACT	1
NOMENCLATURE	1
INTRODUCTION	1
LOSS-OF-FLIGHT-CONTROL ACCIDENT OR INCIDENT HISTORY	2
Commercial Airplanes	2
DC-10, Sioux City, Iowa	2
B-747, Mt. Mikuni, Japan	2
DC-10, Paris, France	3
DC-10, Detroit, Michigan	4
L-1011, San Diego, California	4
Military Accidents	4
XB-70, Edwards, California	4
B-52H, Dayton, Ohio	4
B-52G, Warner Robins AFB, Georgia	4
C-5A, Saigon, Vietnam	4
F/A-18, Jasper County, Indiana	5
US Navy F/A-18, Sea of Japan	5
Southeast Asia Loses	5
Summary of Experience	5
PRINCIPLES OF THROTTLES-ONLY FLIGHT CONTROL	5
Roll	5
Pitch	5
Flightpath Angle Change Caused by Speed Stability	5
Pitching Moment Caused by Thrust Line Offset	7
Flightpath Angle Change Caused by the Vertical Component of Thrust	7
Phugoid	7
Relative Position of Inlet to Exhaust Nozzle	7
Speed Control	9
Stability	9
Speed Effects on Propulsive Control Power	10
Fuel Slosh	10
F-15 AIRPLANE AND INSTRUMENTATION DESCRIPTION	11
Air Inlets	13
Engines	15
Flight Control System	16
Head-Up Display	18
Weight, Inertia, and Center of Gravity	18
Differences from Production F-15 Aircraft	18
Instrumentation	18
F-15 SIMULATION	20

THROTTLES-ONLY CONTROL MODES.....	20
Throttles-Only Manual Control Tests.....	20
Propulsion-Controlled Aircraft System Mode.....	22
Propulsion-Controlled Aircraft System Control Logic.....	22
Propulsion-Controlled Aircraft Controller Study.....	25
Center of Gravity Control Study.....	26
Propulsion-Controlled Aircraft System Trim Logic.....	26
Propulsion-Controlled Aircraft System Implementation.....	26
TEST PROCEDURE.....	27
RESULTS AND DISCUSSION.....	28
Initial Throttles-Only Control Simulation and Flight Tests.....	31
Throttle Step Flight Tests.....	34
Effects of Inlet Airflow.....	38
Inlet Effect on Simulation Propulsion-Controlled Aircraft System Control.....	38
Inlet Effect at 150 Knots.....	41
Inlet Effect Water-Tunnel Test.....	42
Propulsion-Controlled Aircraft System Control in Simulation at 150 Knots.....	42
Propulsion-Controlled Aircraft Flight Tests.....	42
Propulsion-Controlled Aircraft Trim Tests.....	42
Step Inputs.....	46
Propulsion-Controlled Aircraft System Approaches.....	50
Ground Effect.....	55
Propulsion-Controlled Aircraft Approach and Landing.....	56
Propulsion-Controlled Aircraft System Flight Profile.....	56
Simulated-Loss-of-Control Upset and Propulsion-Controlled Aircraft System Recovery.....	56
Throttles-Only Manual Control.....	60
Throttles-Only Manual Approach.....	67
Effects of Weight and Center of Gravity.....	67
Propulsion-Controlled Aircraft System Envelope Expansion.....	67
Heading-Mode.....	72
Single-Engine Propulsion-Controlled Aircraft System Control Plus Rudder.....	76
Guest Pilot Evaluation Summary.....	76
Overall Inlet Effect and Final Simulation Improvement.....	79
CONCLUSIONS.....	86
LESSONS LEARNED.....	87
REFERENCES.....	88
APPENDIX A – WIND-TUNNEL INLET-AIRFLOW VARIATION DATA.....	89
APPENDIX B – GUEST PILOT COMMENTS.....	93
Excerpts from Guest Pilot G.....	93
Excerpts from Guest Pilot H.....	93
Control Augmentation System-Off Control.....	93
Manual Throttles-Only Control.....	93
Control.....	94
Approach to 200 ft Above Ground Level.....	94

Recovery from Unusual Attitude and Descent to Approach to 20 ft Above Ground Level	94
Manual Throttles-Only Approach to 200 ft Above Ground Level	94
Conclusions	94
Excerpts from Guest Pilot C	94
Control Augmentation System-Off Control	95
Throttles-Only Manual Control	95
Propulsion-Controlled Aircraft System Control.	95
Unusual Attitude Recovery	95
Instrument Descent.	95
Final Approach.	95
Go-Around	95
Excerpts from Guest Pilot E	95
Throttles-Only Manual Control	96
Coupled Approaches	96
Coupled Waveoff	96
Summary	96
Excerpts from Guest Pilot D.	96
Summary	97

TABLES

1. Changes to the NASA Dryden F-15 simulation.	22
2. Propulsion-controlled aircraft software module size and execution time	27
3. Pilots for the propulsion-controlled aircraft system flight evaluation	28
4. Test cards for the propulsion-controlled aircraft system guest pilot evaluation.	29
5. F-15 throttles-only and propulsion-controlled aircraft flights	29

FIGURES

1. Ground track of UAL flight 232.	3
2. Ground track of JAL flight 123	3
3. Roll control resulting from full differential thrust, F-15, 170 knots	6
4. Pitch effects of a step increase in thrust on both engines.	6
5. The F-15 flight phugoid oscillation initiated by pitch input	8
6. Nozzle gross thrust and inlet ram drag vectors for the F-15 airplane	9
7. Speed control effects on the F-15 airplane.	10
8. Effects of airspeed on throttles-only maximum roll and pitch rates, CAS off, PARRE, inlet emergency	11
9. The NASA F-15 HIDEDEC research airplane	12
10. Inlet of the F-15 airplane	13
11. Location of the NASA F-15 inlet and engine forces with respect to the CG for PCA flight tests, mid-fuel, gear down (dimensions in inches)	15

12.	The F100 engine model derivative (PW1128) engine	16
13.	The NASA F-15 CAS-off PARRE flight speeds and angle-of-attack.....	17
14.	Variations of moments of inertia and CG with fuel weight for the NASA F-15 airplane	19
15.	The F-15 simulators used for the PCA tests	21
16.	The PCA system on the NASA F-15 HIDEDEC airplane	23
17.	The PCA system in the NASA F-15 cockpit	24
18.	The F-15 PCA control logic.....	25
19.	Simplified PCA control law with the trim function shown in the shaded region.....	27
20.	Early simulation manual throttles-only landings for pilots with no previous throttles-only landing experience, F-15, flight controls locked, KCAS = 170 knots, gear down, flaps up	31
21.	Early simulation PCA landings, new pilots with no previous PCA experience, flight controls locked, KCAS = 170 knots, gear down, flaps up.....	33
22.	Manual throttles-only approaches, flight and early simulation, CAS-off PARRE, KCAS = 170 knots, flaps up	35
23.	Comparison of flight and early simulation response for a different throttle input, CAS-off PARRE, gear down, flaps up	36
24.	Comparison of flight and simulation data for a 10° step increase in throttle setting, KCAS = 170 knots, flaps up. (Simulation without airflow effects modeled.)	37
25.	Comparison of flight and simulation data for a step decrease in throttle setting to idle, KCAS = 170 knots, flaps up. (Simulation without airflow effects modeled.)	39
26.	Pitching moment variation caused by inlet capture-area ratio, F-15 airplane 7.5 percent wind-tunnel test results: $\alpha = 8^\circ$, Mach 0.6, $\rho = -4^\circ$ (emergency position). ⁸	40
27.	Comparison of flight and simulation for throttle step to idle, with and without inlet-airflow effect, KCAS = 170 knots, flaps up	40
28.	Flight comparison of step throttle reduction from <i>PLF</i> to idle at 170 and 150 knots	41
29.	The F-15 airplane 1/48 scale model water tunnel test	43
30.	Flight PCA trimming operation, 5000 ft, 150 knots, smooth air, flaps down	45
31.	PCA response to a flightpath step command response, gear and flaps down, 4000 ft.....	47
32.	PCA bank-angle response with initial and improved control logic, KCAS = 150 knots, flaps down	49
33.	Time history of a PCA approach and go-around, flaps down, pilot A.....	51
34.	The PCA approach and go-around, KCAS = 150 knots, flaps down, light turbulence, pilot G	52
35.	Time history of PCA approach to 10 ft <i>AGL</i> , flaps down	53
36.	Original and updated ground effect model.....	55
37.	First PCA system landing, flaps down, pilot A	57
38.	Time history of second PCA approach and landing with 360° turn for spacing, pilot A.....	59

39.	An F-15 PCA pitch oscillation caused by inlet effect, gear up, flaps up, PCA trim on, velocity feedback off and inlets emergency	61
40.	An F-15 PCA pitch oscillation caused by inlet effect, gear up, flaps up, PCA trim on, inlets automatic, velocity feedback off	62
41.	The F-15 upset, PCA recovery, descent, approach to landing, velocity feedback on, pilot F	63
42.	Time history of F-15 upset, PCA recovery, descent, approach to landing, velocity feedback on, pilot H	65
43.	Time history of a manual throttles-only approach compared to a PCA approach, pilot F, flaps down	68
44.	The F-15 PCA maximum bank-angle test, flaps down	69
45.	Time history of PCA climb at $KCAS = 280$ knots, flaps up	71
46.	The F-15 PCA design and flight test envelope	72
47.	The PCA heading control mode	73
48.	The PCA heading mode evaluation	74
49.	Simulation comparison of PCA bank-angle and heading modes approach and landing, light-to-moderate turbulence, 150 knots, flaps down. (Task: Aggressively maintain extended runway centerline alignment to touchdown.)	77
50.	The F-15 PCA single engine plus rudder mode, turn and approach for landing, 170 knots, right engine at idle, pilot A	78
51.	Effect of inlet capture-area ratio and α on pitching moment	80
52.	Combined effects of inlets emergency and airflow variation on airplane pitching moment coefficient, flaps down	82
53.	Comparison of final simulation to final 6 sec of PCA landing of figure 37	83
54.	Comparison of flight and simulation touchdown sink rates for PCA landings	84
55.	Manual throttles-only approach, final simulation, flaps down, pilot X	85
A-1.	The 7.5 percent wind-tunnel data of reference 8, $M = 0.6$, total aircraft coefficients	90

ABSTRACT

A propulsion-controlled aircraft (PCA) system for emergency flight control of aircraft with no flight controls was developed and flight tested on an F-15 airplane at the NASA Dryden Flight Research Center. The airplane has been flown in a throttles-only manual mode and with an augmented system called PCA in which pilot thumbwheel commands and aircraft feedback parameters were used to drive the throttles. Results from a 36-flight evaluation showed that the PCA system can be used to safely land an airplane that has suffered a major flight control system failure. The PCA system was used to recover from a severe upset condition, descend, and land. Guest pilots have also evaluated the PCA system. This paper describes the principles of throttles-only flight control; a history of loss-of-control accidents; a description of the F-15 airplane; the PCA system operation, simulation, and flight testing; and the pilot comments.

NOMENCLATURE

A/A_c	inlet capture-area ratio (inlet flow area/capture area)
AGL	above ground level (altitude), ft
BL	butt line, in.
CAS	control augmentation system
C_d	airplane drag coefficient
C_l	airplane lift coefficient
C_m	airplane pitching moment coefficient
CG	center of gravity
$DEEC$	digital electronic engine control
$EMAZ$	offset of the thrust line from the CG in the Z (vertical) axis, in.
EMD	engine model derivative
FS	fuselage station, in.
$HIDEC$	Highly Integrated Digital Electronic Control
HUD	head-up display
I_{xx}	moment of inertia about the x axis, slug-ft ²
I_{xy}	product of inertia about the xy axis, slug-ft ²
I_{yy}	moment of inertia about the y axis, slug-ft ²
I_{zz}	moment of inertia about the z axis, slug-ft ²

$KCAS$	calibrated airspeed, knots
LDP	landing difficulty parameter (fig. 20)
$M.A.C.$	mean aerodynamic chord
$m.s.l.$	mean sea level (for altitude)
MDA	McDonnell Douglas Aerospace, St. Louis, Missouri
NCI	Navigation Control Indicator
$PARRE$	pitch and roll ratios emergency
PCA	propulsion-controlled aircraft
PLA	power lever angle, deg
PLF	power for level flight, deg
$S1-20$	upgrades in the NASA Dryden F-15 simulation (table 1)
t	time, sec
WL	water line, in.
α	angle of attack, deg
Δ	change
γ	flightpath angle, deg
ρ	inlet cowl angle, deg

INTRODUCTION

The crew of a multiengine aircraft with a major flight control system failure may use throttle manipulation for emergency flightpath control. Differential throttle inputs generate yaw that, through dihedral effect, results in roll. Collective throttle inputs may be used to control pitch. Pilots of DC-10, B-747, L-1011, and C-5A aircraft have had to use throttles for emergency flight control.¹

To investigate the use of engine thrust for emergency flight control, the NASA Dryden Flight Research Center at Edwards, California, has been conducting a research project that includes flight, ground simulator tests, and analytical studies.

One objective of the research is to determine the degree of control power available with engine thrust for various classes of airplanes. This objective has shown a surprising amount of control capability for most multi-engine airplanes.

A second objective is to provide awareness of throttles-only control capability and suggest throttles-only manual control techniques for pilots. Results of simulation and flight studies of several aircraft, including B-720, Lear 24, F-15, B-727, C-402, and

B-747 airplanes, have been presented.^{2,3} More recently, T-39, B-777, MD-11, and F/A-18s have been studied. The use of throttles—only manual control is difficult but possible for up-and-away flight, but a safe runway landing is extremely unlikely. Difficulties arise because of the low control power available, very slow response, poor predictability, and difficulty in damping the phugoid and dutch roll oscillations.

A third objective of the research is to investigate possible augmented, computer-controlled thrust modes that could be developed for future airplanes. An augmented control system that uses pilot flightpath inputs and airplane sensor feedback parameters to provide appropriate throttle commands for emergency landings has been developed at NASA Dryden. This augmented system, called propulsion-controlled aircraft (PCA) has been evaluated on a B-720 transport airplane simulation;⁴ a generic twin-jet simulation at the NASA Ames Research Center, Moffett Field, California,⁵ and a simulation of a conceptual megatransport.⁶

Recently, the first flight investigation of throttles-only augmented control was conducted on the NASA F-15 research airplane.⁷ Studies of throttles-only manual control and the performance of a PCA system, designed using conventional control law development and stability analyses, have been conducted. The objectives of the flight program were to demonstrate and evaluate PCA system performance, in up-and-away and landing-approach flight, over the speed range from 170 to 190 knots at altitudes below 10,000 ft. If PCA system performance proved adequate, attempting PCA system landings was also an option.

NASA Dryden has completed a 36-flight series of tests on the F-15 airplane in which the original objectives have been exceeded, including actual landings using the PCA system. Recoveries from upset conditions including a 90° bank at a 20° dive have also been flown. Altitudes to a maximum 38,000 ft and speeds to a maximum 320 knots were flown. Six guest pilots evaluated the F-15 PCA system.

This paper presents a history of loss-of-flight-control situations in which throttle control was or could have been tried; a summary of the principles of throttles-only flight control; a summary of the flight tests of manual and PCA system flight control for the F-15 airplane; and the test techniques, results, and pilot comments. Development of the simulations is also discussed. The Results and Discussion section presents events in the order in which they occurred, thus serving to preserve the chronology of the project.

The authors wish to acknowledge the work of McDonnell Douglas Aerospace and, in particular, of James Urnes, MDA PCA program manager, and Ed Wells, MDA PCA design and flight test engineer, for their assistance in the PCA project and contributions to the design, development, test, analysis, and reporting.

LOSS-OF-FLIGHT-CONTROL ACCIDENT OR INCIDENT HISTORY

Many accidents and incidents have occurred in which major flight control failures were a factor, and the crew either did or could have used throttles for emergency flight control.¹ These incidents provide insight into the capabilities of throttles-only manual control and illustrate the potential for a PCA emergency flight control system.

Commercial Airplanes

Several cases of loss-of-flight controls in commercial airliners exist. The best known use of throttles-only control occurred in July 1989, in the Sioux City, Iowa, accident discussed in the following subsection. Several other accidents also occurred. Some are also discussed in the following subsections.

DC-10, Sioux City, Iowa

A United Airlines flight 232, DC-10, suffered an uncontained tail engine failure during cruise flight that caused the loss of all hydraulics. After the failure occurred, the airplane trimmed at approximately 210 knots with a significant yaw caused by damage to the center engine nacelle. The crew used the only remaining controllers, the wing engine throttles, to maintain control under extremely difficult circumstances. The crew learned to achieve sufficient control and was able to reach the Sioux Gateway Airport. In spite of the crew's heroic efforts, the airplane crashed on the runway, but many of the persons on board were saved. Figure 1 shows the ground track for the flight.

B-747, Mt. Mikuni, Japan

In 1985, a B-747, Japan Airlines flight 123, suffered a total hydraulic system loss as a result of an aft cabin pressure bulkhead failure. After the failure, the aircraft

remained essentially trimmed. The throttles and electric flaps were the only usable devices for control. The aircraft was flown for 31 min using throttle control, but the crew was not able to effectively control the airplane. The airplane eventually hit a mountain, and 520 lives were lost. Figure 2 shows the ground track for the flight.

DC-10, Paris, France

On March 3, 1974, during Turkish Airlines flight 981, while climbing out of Paris, a DC-10 airplane suffered a failure of the aft cargo door. The decompression buckled the cabin floor, breaking or stretching control

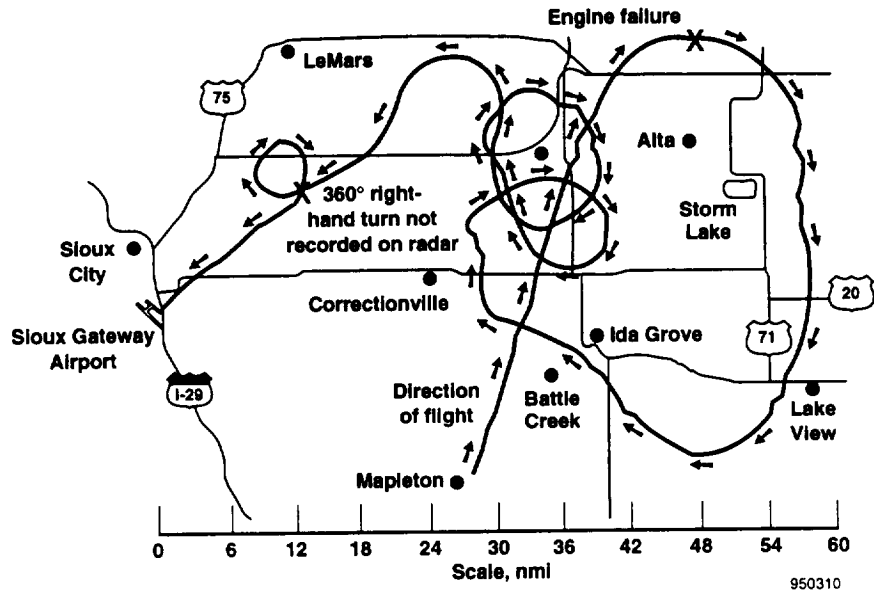

Figure 1. Ground track of UAL flight 232.

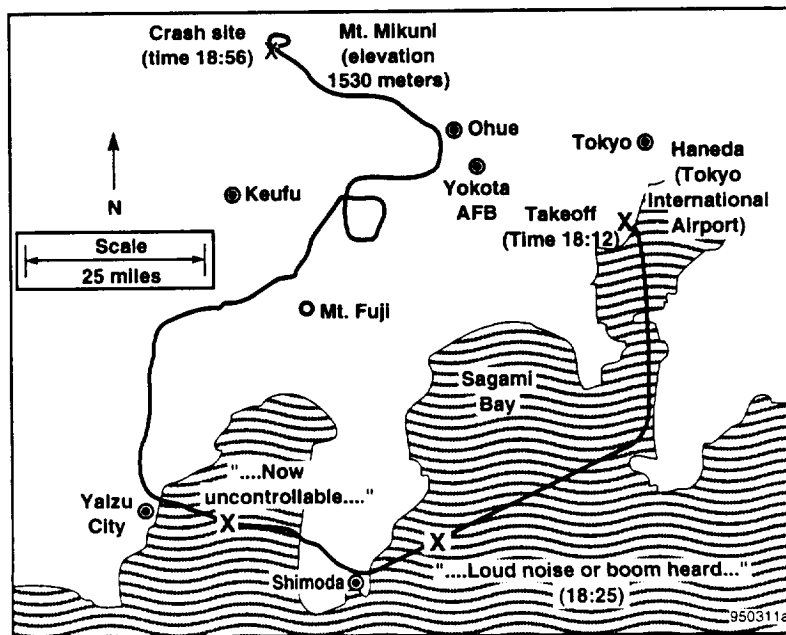

Figure 2. Ground track of JAL flight 123.

cables to the tail. The airplane impacted the ground in near-level flight at high speed, killing all 346 onboard. Adding thrust to the wing engines would possibly have pulled the airplane out of the dive although the trim condition might have been at a very high speed.

DC-10, Detroit, Michigan

Another potentially serious DC-10 incident occurred in June 1972 when American Airlines flight 96 suffered a cargo door failure. The rudder and 50 percent of the elevator and stabilizer control were lost, but sufficient pitch and full roll capability remained. The airplane landed safely. During landing rollout, with no rudder control or nose wheel steering available, differential reverse thrust was required to keep the airplane on the runway.

L-1011, San Diego, California

On April 12, 1977, an L-1011, Delta Airlines flight 1080, had an undetected failure in which the left stabilizer jammed in the full trailing-edge-up position before takeoff from San Diego. This failure resulted in a large noseup and rolling moment that almost exceeded the capability of the flight controls. The airplane was just about to stall in the clouds when the captain, with unusual insight, reduced power on the wing engines and began using the throttles to supplement the remaining flight controls, using differential and collective engine thrust. The crew of this airplane did an exceptional job, learned rapidly, and completed a safe landing. A less capable crew would not likely have been able to save this airplane.

Military Accidents

Several military aircraft have also suffered major failures in which throttles were or could have been used for control. These incidents are discussed next.

XB-70, Edwards, California

In 1967, a USAF XB-70, no. 2, airplane lost both vertical tails in a midair collision. With no yaw stability or control available, the airplane slowly diverged in yaw, entered a spin, and crashed. One crew member was injured in ejecting; the other was unable to eject and was killed. The use of differential thrust might have permitted yaw control to be maintained, perhaps allowing a safe landing or at least a safe ejection.

B-52H, Dayton, Ohio

In May 1974, a USAF B-52H airplane lost all tail hydraulic fluid because of a leak in a common drain line to the separate hydraulic reservoirs. The crew still had stabilizer trim for speed control and spoilers for roll control. For pitch, the crew used the throttles and the airbrakes. All eight engines were functioning normally. The crew split the task. One person manipulated the throttles while another handled the airbrakes. The crew made a practice approach at an altitude of 10,000 ft using these controllers and were satisfied that they could land. At that point, the gear was lowered. The upset from that action caused the crew to lose 8000 ft of altitude before regaining full control. Despite these control difficulties, the crew elected to try to land at Patterson Air Force Base (AFB). During the final approach, the phugoid was not properly damped, and the aircraft hit the ground on the downswing of the phugoid. The impact broke off the nose section at the forward landing gear. The rest of the airplane was consumed by fire, but all eight crewmembers in the nose section walked away from the crash.

After this accident, several flights were flown to determine the controllability of B-52H airplanes with this type of failure, and procedures were developed. The procedures, which used throttles and wing spoilers for pitch control, called for a flaps-up landing at higher speeds to improve the pitch response to spoilers.

B-52G, Warner Robins AFB, Georgia

In 1981, a similar failure to the one which occurred in Dayton, Ohio, occurred on a USAF B-52G airplane. The same procedure was followed, and a landing was attempted at Warner Robins AFB, Georgia. The airplane hit hard enough to crack the fuselage, but no injuries were incurred, and the airplane was repaired. All B-52 crews are still trained for this and similar emergencies using throttles for control.

C-5A, Saigon, Vietnam

In 1973, a USAF C-5A airplane was carrying 300 orphans on an evacuation flight in Vietnam. While climbing through an altitude of 12,000 ft, the rear pressure bulkhead, which is part of the cargo-loading ramp, failed. This failure caused secondary damage to the aft fuselage and loss of all hydraulics to the tail. The airplane remained roughly trimmed, and roll control was

still available. Pitch was controlled with throttles. The crew commented on the difficulty in achieving precise control because of the slow response of the engines. The crew practiced using this control mode for 30 min, made a practice landing at an altitude of 10,000 ft, and then tried an approach to the runway. When the landing gear was lowered, a phugoid oscillation was excited that caused ground impact 3 miles short of the runway. The airplane hit very hard, broke up, and was destroyed by fire. There were no survivors.

As a result of this accident, extensive simulation studies were conducted. To this day, C-5A crews do some throttles-only simulator practice for loss of hydraulics.

F/A-18, Jasper County, Indiana

In Jasper County Indiana in 1989, a US Navy F/A-18 lost both hydraulic systems from a leak in a stabilizer actuator. When all hydraulic fluid was lost, the airplane initially remained trimmed. Then it experienced a very slow rolloff to the right. When the roll reached 90°, the pilot ejected. A failure of the dam seal in the right horizontal tail actuator caused this accident.

US Navy F/A-18, Sea of Japan

An F/A-18 suffered an intermittent failure of the linear variable differential transformer sensor in the left horizontal tail. This failure resulted in large, uncommanded actuator inputs of random size and timing. With the airplane uncontrollable in this digital mode, the pilot pulled circuit breakers to select the backup mechanical system, which operated normally but is not recommended for landing. After repeated tries to reselect the digital mode that resulted each time in wild gyrations, the pilot reselected the backup mechanical system, went out over the ocean, and ejected.

Southeast Asia Losses

Recently released information on the Vietnam War shows that 18 percent of the more than 10,000 aircraft lost were lost because of flight control failure. How many of these 1800 airplanes could have been saved if a PCA system had been used is unclear.

Summary of Experience

Experience has shown that large transport, bomber, and fighter airplanes with total or major flight control

system failures have sufficient throttles-only control capability for extended up-and-away flight but, without extensive practice, cannot be landed safely. Gross control capability exists, but not enough precision control exists to effect a safe runway landing.

PRINCIPLES OF THROTTLES-ONLY FLIGHT CONTROL

The principles of throttles-only flight control are presented in the following subsections. The discussion uses examples for the F-15 airplane.

Roll

Differential thrust generates sideslip that, through the dihedral effect present on most airplanes, results in roll rate. Roll rate is controlled to establish a bank angle that results in a turn and change in aircraft heading. Figure 3 shows a full differential throttle step-input at $t = 0$ sec. Engine thrust response takes approximately 1 sec, and the sideslip builds up over a 2-sec period. Roll rate follows sideslip. Full differential thrust for the F-15 airplane yields a roll rate of approximately 15 deg/sec at a speed of 170 knots. With throttles-only flight control, bank is controlled by yaw, and the turns are typically not coordinated.

Pitch

Pitch control caused by throttle changes is more complex. Figure 4 shows the four effects that occur for a throttle step-increase on both engines at $t = 0$ sec.

Flightpath Angle Change Caused by Speed Stability

Most stable airplanes, including the F-15 airplane, exhibit positive speed stability. Over approximately 15 sec, a thrust increase will cause a speed increase that will cause a lift increase. With the lift being greater than the weight, the flightpath angle will increase, causing the airplane to climb. If allowed to continue, this effect will be oscillatory. (See the Phugoid subsection.) The degree of change to the flightpath angle is proportional to the difference between the initial trim airspeed and the current airspeed. Hence, the flightpath angle tends to increase as speed increases.

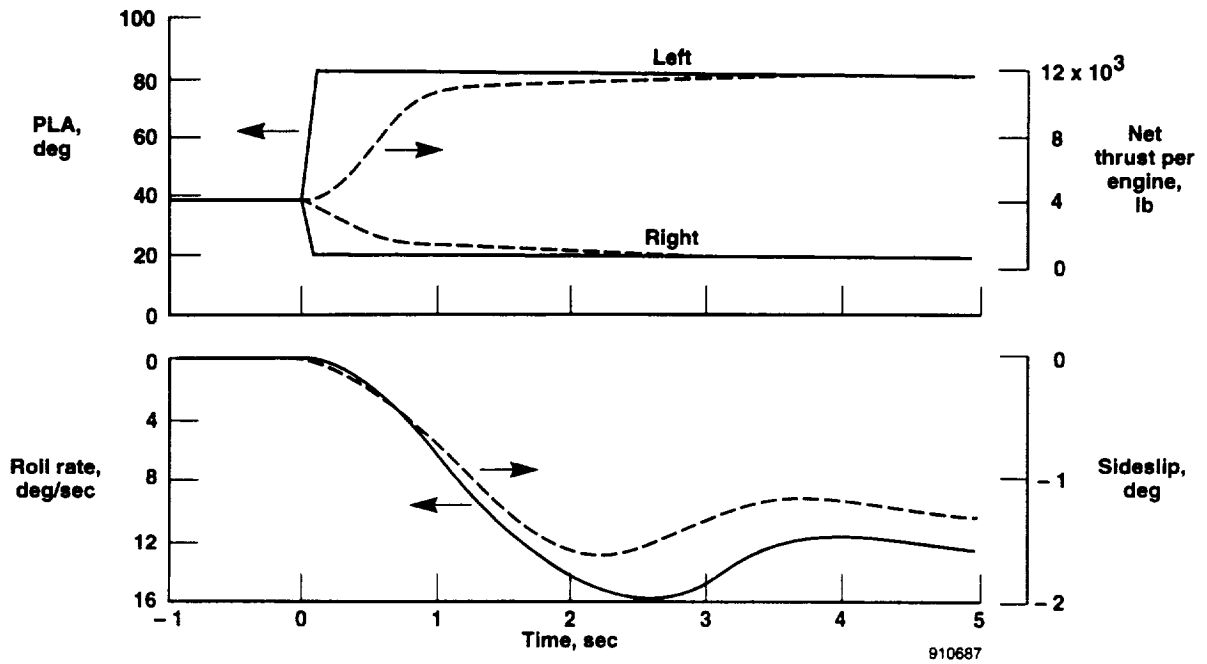

Figure 3. Roll control resulting from full differential thrust, F-15, 170 knots.

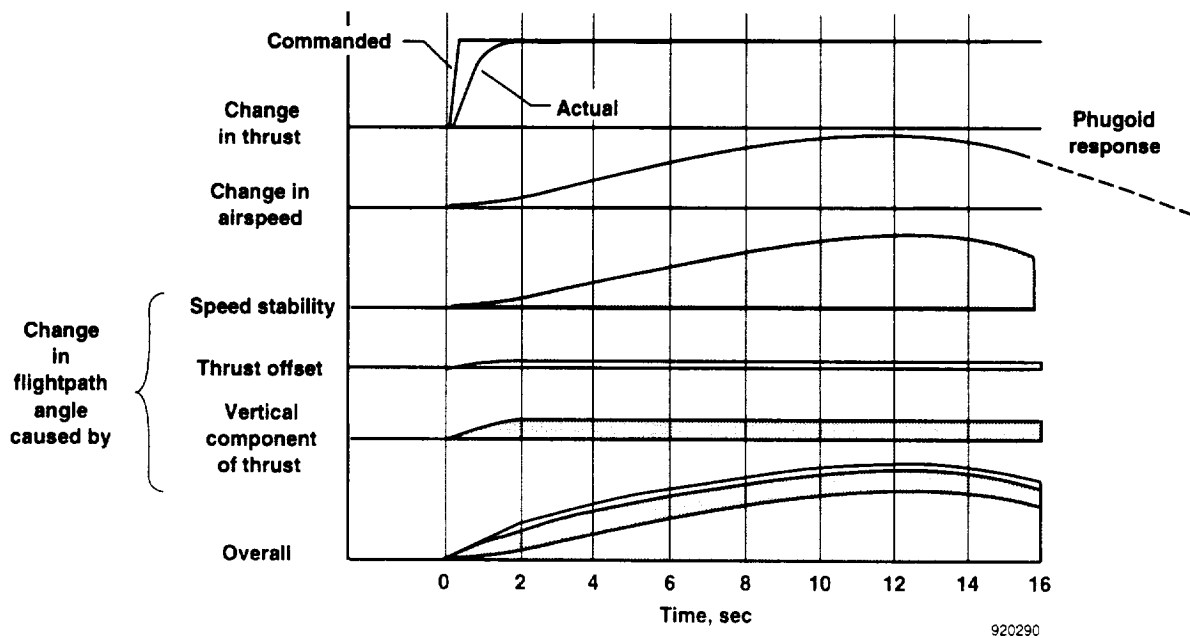

Figure 4. Pitch effects of a step increase in thrust on both engines.

Pitching Moment Caused by Thrust Line Offset

If the engine-thrust line does not pass through the vertical center of gravity (CG), a pitching moment introduced by thrust change occurs. For many transport aircraft, the thrust line is below the CG. Increasing thrust results in a desirable noseup pitching moment. Magnitude is a linear function of the thrust change. Having the thrust line below the CG is the desirable geometry for throttles-only control because a thrust change immediately starts the nose in the same direction needed for the long-term flightpath angle change. The effect is more a function of change in thrust than of change in speed and occurs near the time of the thrust increase. For the F-15 airplane, the thrust line passes within ± 1 in. of the vertical CG, depending on fuel quantity, and this pitching moment is small. For airplanes with high-mounted engines (such as many business jets), the initial response to a thrust increase is a nosedown pitching moment opposite to that desired. Many seconds may be required to get the nose to start moving in the positive direction. Throttles-only control of these aircraft, including the Learjet and T-39 aircraft, is very difficult.

Flightpath Angle Change Caused by the Vertical Component of Thrust

If the thrust line is inclined noseup to the flightpath, as is commonly the case, an increase in thrust will increase the vertical component of thrust. This increased vertical component of thrust will cause a direct increase in vertical velocity (that is, rate of climb) and a resulting increase in flightpath angle. For a given aircraft configuration, this effect will increase as angle of attack, α , increases (that is, as speed decreases).

For the F-15 airplane, the combination of the aforementioned three effects of the engine thrust is to produce a noseup flightpath angle-rate response. This rate response peaks at approximately 2 deg/sec for a throttle step from power for level flight (PLF) to intermediate power on both engines at 170 knots.

Phugoid

Phugoid is the longitudinal long-period oscillation of an airplane. Phugoid is a motion in which kinetic and potential energy (speed and altitude) are traded. The phugoid oscillation is excited by a pitch or a velocity change. Such oscillations have a period of approximately 1 min. Phugoid may or may not damp naturally.

Figure 5 shows an example of an F-15 phugoid. The oscillation was excited by a pullup initiated by the pilot to disturb the flightpath, which resulted in an oscillation with light damping and a period of approximately 50 sec. Although a very low amplitude phugoid is usually considered to be a constant angle-of-attack maneuver, if the amplitude is not small, variations in angle of attack resulting from damping terms can exist.

Properly sized and timed throttle inputs can be used to rapidly damp unwanted phugoid oscillations. These techniques for a generic airplane have previously been reported.^{2,3} This technique is not fully effective on the F-15 airplane because of a nonlinear inlet-airflow effect.

Relative Position of Inlet to Exhaust Nozzle

The relative positions of the inlet and the exhaust nozzle of each engine are an important effect for throttles-only flight control. The inlet ram drag vector is assumed to act through the centroid of the inlet area, along the flightpath, and thus rotates with respect to the airplane geometric reference system as angles-of-attack and -sideslip changes. The gross thrust vector usually acts along the engine centerline and thus maintains its relationship to the airplane geometric reference system. Ram drag can be a significant percentage of gross thrust, particularly at low power settings.

In the pitch axis, having the inlet located above the engine centerline is beneficial. An increase in throttle increases ram drag and gross thrust and results in a noseup moment. This inlet location is the case for the B-2 airplane and for the center engines of such airplanes as the B-727 and the L-1011. If the inlet is located below the engine centerline, an increase in thrust causes an undesirable nosedown moment. The F-16 and F-18 aircraft are examples of such a configuration. Podded engines typically have the inlet and nozzle closely aligned and thus would have neutral effect. This gross thrust-ram drag effect is generally less important than the relationship of the engine to the airplane vertical CG.

Increasing angle of attack is beneficial for the effect of the relative positions of the inlet and the exhaust nozzle, for conventional aircraft. The F-15 inlet is approximately 3 in. below the engine centerline at 0° angle of attack. However, this inlet is far enough forward that the ram drag vector is above the vertical CG for most of the angle-of-attack range. Figure 6 shows the nozzle gross thrust and inlet ram drag vectors for the F-15 airplane at two angles-of-attack. At a 0° angle of attack, if a throttle increase occurs, the resulting ram drag increase will

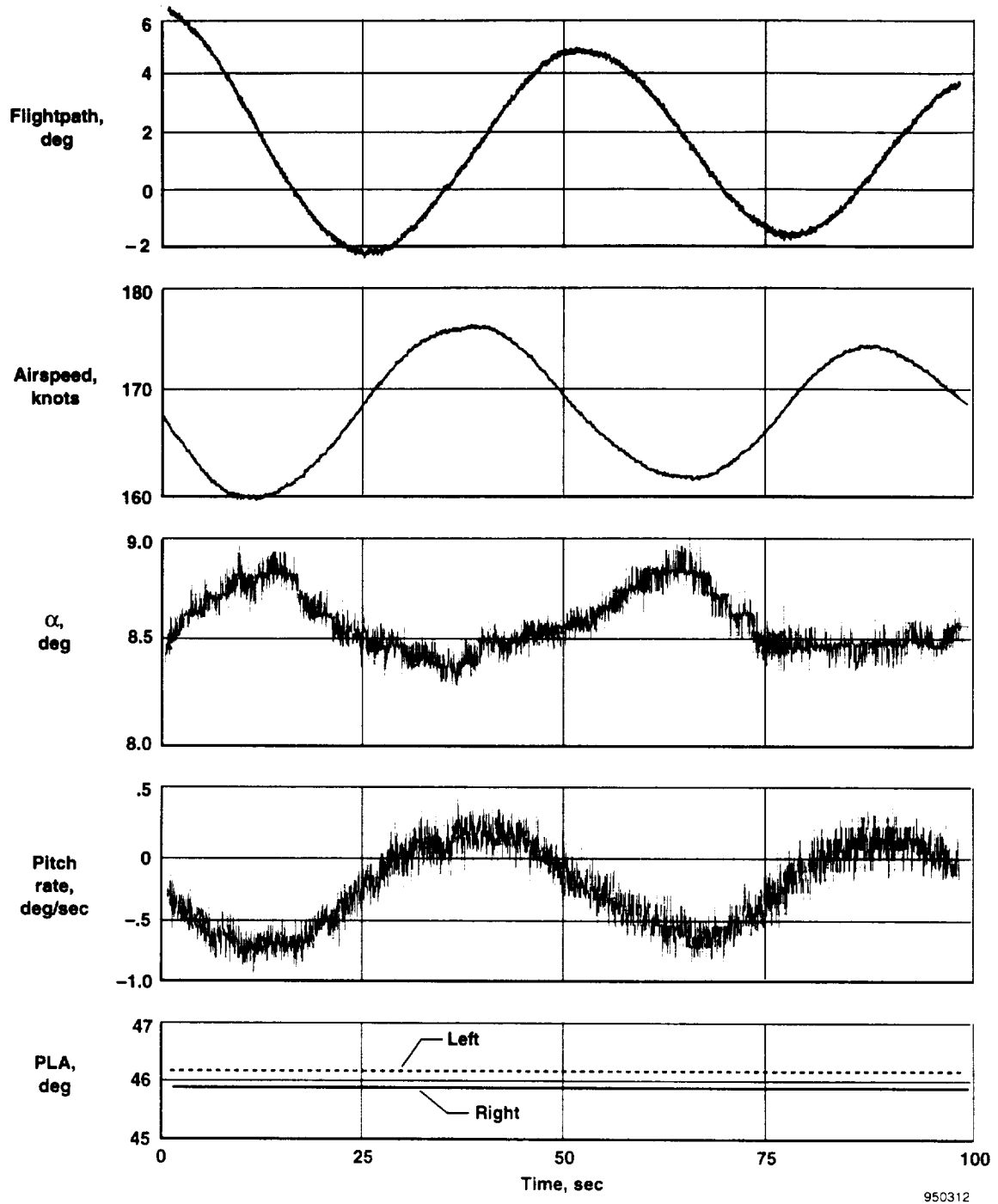

Figure 5. The F-15 flight phugoid oscillation initiated by pitch input.

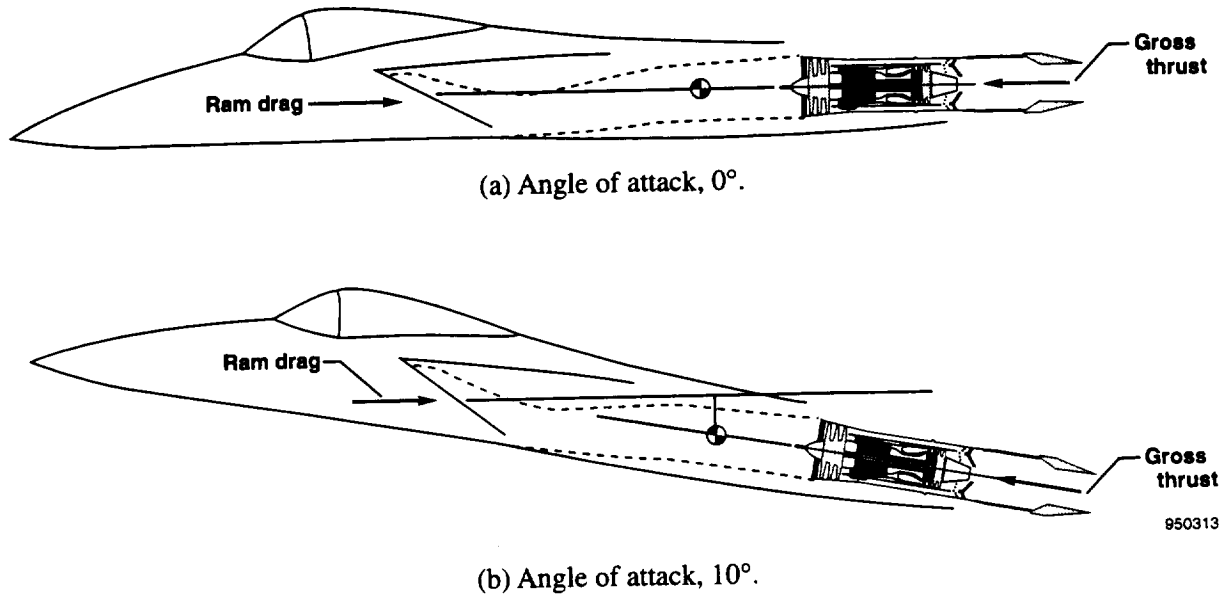

Figure 6. Nozzle gross thrust and inlet ram drag vectors for the F-15 airplane.

cause a nosedown pitching moment. Such pitching moments are undesirable. At a 10° angle of attack, if a throttle occurs, the resulting ram drag increase will cause a noseup pitching moment. Noseup pitching moments are desirable.

In the yaw axis, the principles are similar. The desirable geometry would be to have the engine nozzles outboard of the inlets so that an increase in thrust would result in a favorable yawing moment. Unfortunately, this is not the case for many fighter airplanes that have the inlets outboard of the engines. For the F-15 airplane, the inlets are approximately 15 in. outboard of the engines.

Speed Control

When the flight control surfaces of an airplane are locked at a given position, the trim airspeed of most airplanes is only slightly affected by engine thrust. Re-trimming to a different speed may be achieved by other techniques, such as controlling the variable stabilizer, controlling CG, moving the flaps, lowering the landing gear, and changing weight. In general, the speed will need to be reduced to an acceptable landing speed, which implies developing noseup pitching moments. Methods for reducing speed depend on the aircraft and may include moving the CG aft, lowering the flaps, extending the landing gear, or burning off or dumping

fuel. Figure 7 shows some of these effects for the F-15 airplane.

Trim speed is affected by changes in weight. As weight is reduced (for example, by burning or dumping fuel), the lift remains constant (assuming that the CG remains constant), so the airplane tends to climb. To maintain level flight, the throttle setting must be reduced to decrease speed until lift and weight are again in balance. For the F-15 airplane flying at low speed, this effect reduces trim speed by approximately 1 knot every 1 to 2 min. Over the duration of a flight that reduces the 10,000 lbm of fuel to 2500 lbm and has a fixed-stabilizer setting and constant CG, speed would be reduced by approximately 50 knots.

Other effective ways of slowing the F-15 airplane include moving the air inlets to the full-up emergency position and lowering the flaps. Landing gear extension on the F-15 airplane has essentially no effect on trim speed.

Stability

The flight controls–failed stability of an airplane is also an important consideration for throttles-only control. Large transport airplanes typically have good basic static stability. Yaw dampers may be used for increasing the dutch roll mode stability, but good pitch, roll, and yaw static stability is usually inherent. This stability

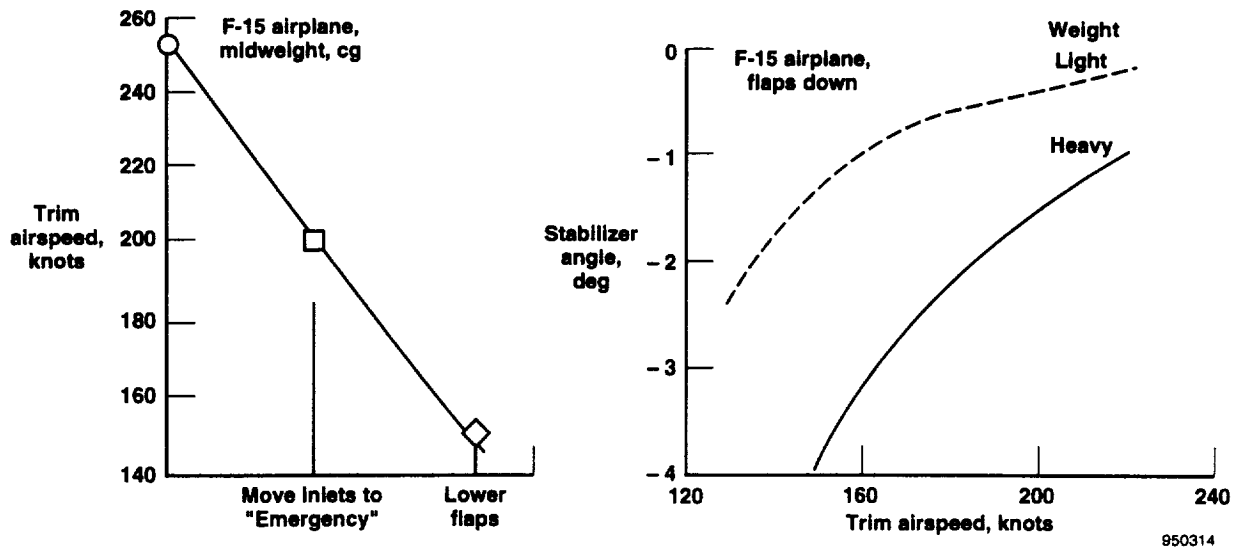

Figure 7. Speed control effects on the F-15 airplane.

remains if the flight control system should be lost in such a way that the surfaces lock. If control surfaces float, the stability may be somewhat reduced.

For fighter airplanes, the airframe may have lower levels of natural stability, with adequate stability being achieved with mechanical or electronic stability augmentation. Thus, in the case of flight control system failure in a fighter, the basic short-period stability may be considerably reduced, and the control requirements for a PCA system will be more difficult. (The previous comments do not apply to the long-period phugoid stability that will likely be a problem for fighter and transport aircraft.)

Speed Effects on Propulsive Control Power

The net propulsive forces (gross thrust minus ram drag) tend to be relatively independent of speed. On the other hand, the aerodynamic restoring forces that resist the propulsive forces are proportional to the dynamic pressure. Dynamic pressure is a function of speed squared. In addition, vehicle aerodynamic parameters, such as the dihedral effect, tend to increase with increasing angle of attack (decreasing speed). These relationships result in the propulsive control power being inversely related to the square of the speed.

Figure 8 shows these effects for the F-15 airplane. Figure 8(a) shows the maximum roll rate for a full differential thrust step varies from 7 deg/sec at 300 knots

to 19 deg/sec at 150 knots. Figure 8(b) shows the maximum positive pitch rate occurs approximately 12 to 15 sec after the throttles were stepped from *PLF* to intermediate power (maximum nonafterburning) and varies from 0.4 deg/sec at 300 knots to 2.7 deg/sec at 150 knots. Figure 8(b) also shows that the maximum pitchdown for throttle steps from *PLF* to idle occurs approximately 15 sec after the thrust change and varies from -0.3 to -2.0 deg/sec. At speeds faster than 150 knots, however, the initial response of the F-15 airplane to a throttle decrease is a pitchup. (See the Results and Discussion section.)

Fuel Slosh

Fuel movement during throttles-only control may be a consideration. In the pitch axis, adding power to climb would move fuel aft. Moving fuel aft adds to the desired noseup pitching moment and, therefore, is a favorable effect. In roll, the effect is unfavorable. The sideslip used to induce a rolling moment tends to move the fuel in the opposite direction to that desired. For example, adding thrust to the left engine for a desired turn to the right will tend to move unrestrained fuel to the left, thus resisting the roll induced by the dihedral effect.

Whether these effects are significant depends on the airplane fuel tank configuration, baffles, and fuel quantity. Full or empty tanks will obviously have no effect.

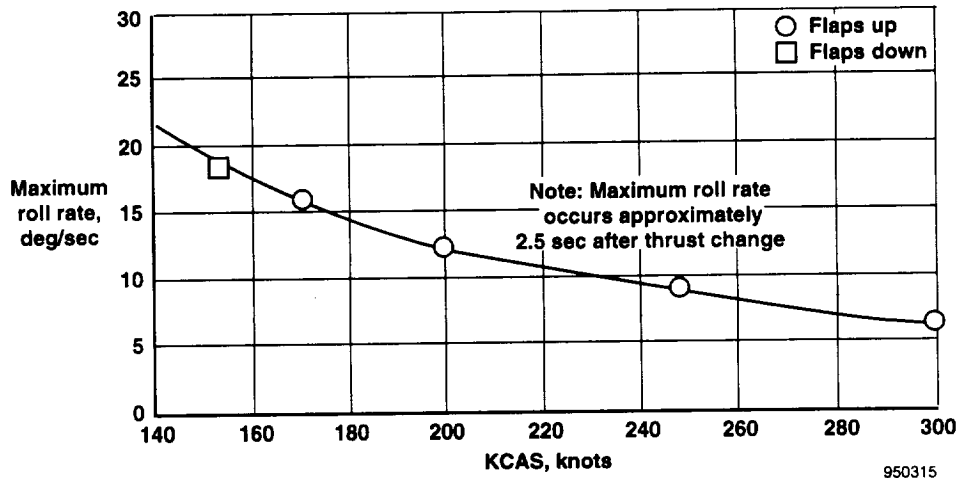

(a) Roll rate.

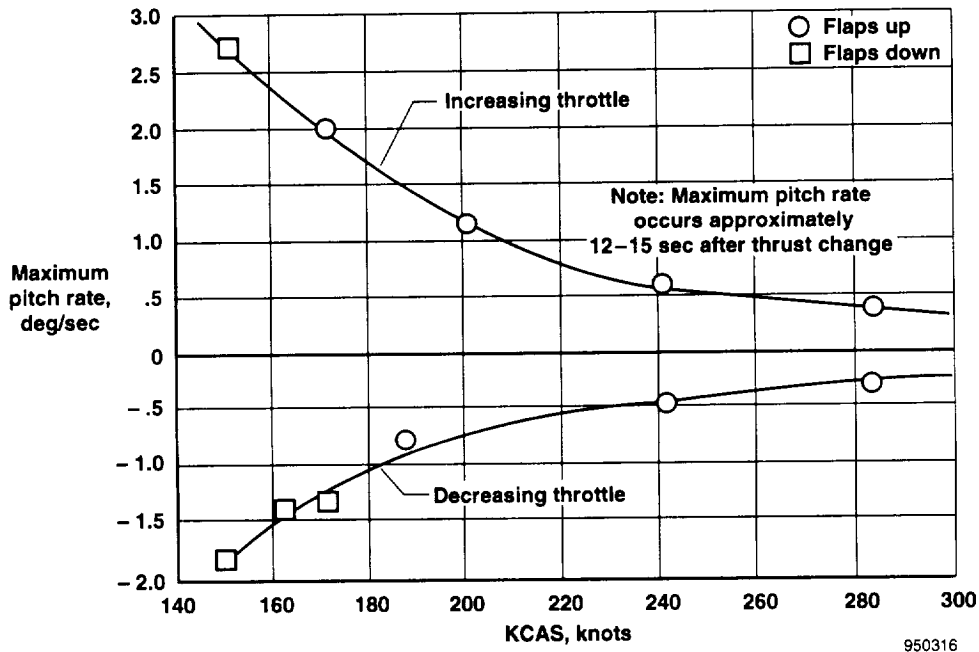

(b) Pitch rate.

Figure 8. Effects of airspeed on throttles-only maximum roll and pitch rates, CAS off, PARRE, inlets emergency.

Maximum effect may occur when tanks are 50 percent full. The effect of fuel slosh has been studied for the F-15 airplane, but no firm conclusions have been made. Some evidence of wing fuel migration during sustained turns exists. (See the Flight Envelope Expansion subsection.)

F-15 AIRPLANE AND INSTRUMENTATION DESCRIPTION

The F-15 airplane (fig. 9) is a high-performance fighter airplane with a maximum Mach number capability of 2.5. Figure 9(a) shows the NASA Dryden F-15

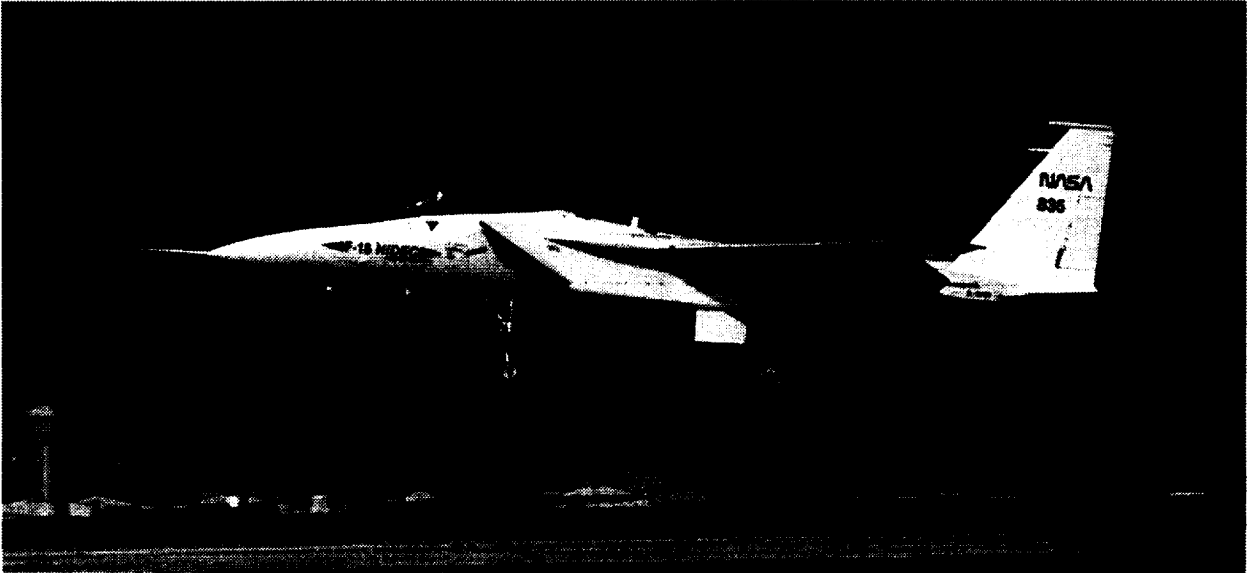

(a) The F-15 airplane.

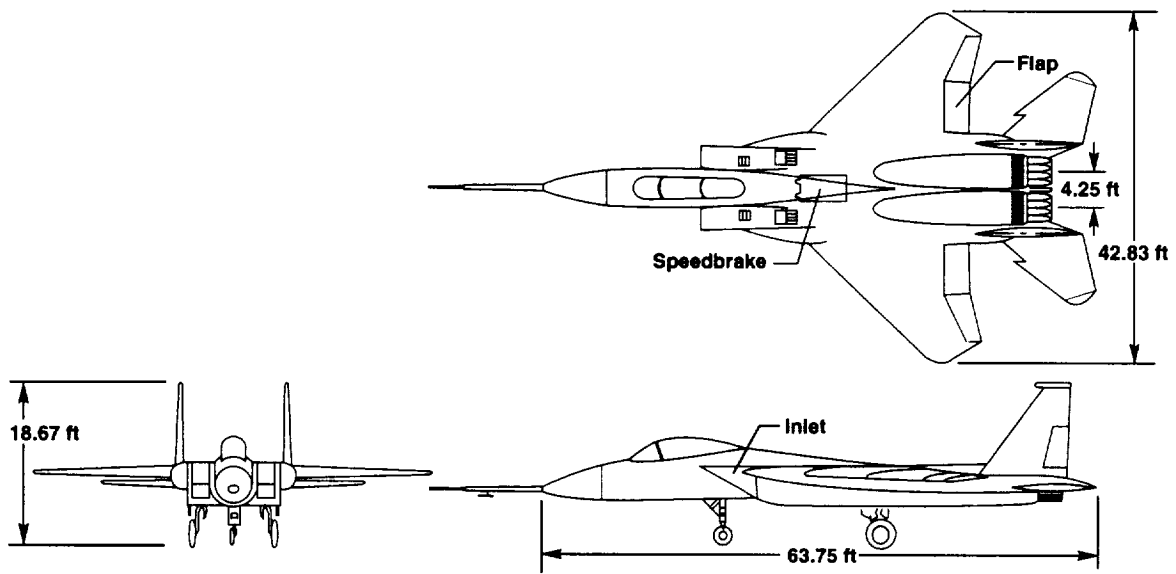

(b) Three-view drawing of an F-15 airplane.

Figure 9. The NASA F-15 HIDE research airplane.

airplane under PCA system control 10 ft above the runway. Figure 9(b) shows a three-view drawing of the F-15 airplane. The F-15 airplane, manufactured by McDonnell Douglas Aerospace (MDA) (St. Louis, Missouri), has a high wing and twin vertical tails. The propulsion system is highly integrated into the fuselage. Thrust is provided by two F100 afterburning turbofan engines mounted close to the centerline in the aft

fuselage. The NASA Dryden F-15 airplane is a pre-production model (airplane number 8).

The F-15 airplane has a low-aspect-ratio wing with 45° of leading-edge sweep and 0° dihedral. Approximately one-half of the internal fuel is carried in integral wing tanks. The F-15 airplane is equipped with trailing-edge flaps (fig. 9(b)) that, on the NASA Dryden airplane, are positioned with electric motors. The flap

position is either up (0° deflection) or down (40° deflection). No intermediate positions are available. No leading-edge flaps exist.

The NASA Dryden F-15 airplane is equipped with a speed brake located on the upper fuselage aft of the cockpit (fig. 9(b)) that is actuated by a single hydraulic actuator. The speed brake was not used for most of the PCA testing.

This airplane is equipped with preproduction landing gear located 6 in. further aft than the landing gear on production F-15 airplanes. The gear is normally lowered with hydraulic pressure. An emergency pneumatic system is also available in case of hydraulic failure. Lowering the gear moves the CG 0.75 in. aft and 0.75 in. down. The main gear has a maximum touch-down sink rate capability of 10 ft/sec. Care must be exercised to prevent the nose gear from touching down before the main gear.

The F-15 airplane carries 11,600 lbm of fuel in fuselage and wing tanks. Each wing tank holds 2700 lbm of fuel. In the fuselage, tank 1 (the most forward) holds 2700 lbm, tank 2 holds 2000 lbm, and tank 3 (the most aft) holds 1500 lbm. In the normal sequence, tank 2 and tank 3 (the feed tank) remain full while the wing tanks and tank 1 feed equally until empty. The variation of CG position are discussed in the Center of Gravity subsection.

Air Inlets

The inlets are mounted on the sides of the forward fuselage and are external compression, horizontal-ramp inlets with variable geometry (fig. 10). Figure 10(a) shows a drawing of the inlet. A variable capture-area capability exists in which the inlet cowl rotates about a point near the lower cowl lip. Inlet geometry is positioned by a digital control system that processes input signals and drives the inlet actuators. At subsonic speeds, the third ramp is fully retracted (up), and the inlet cowl angle is normally positioned by the automatic inlet control system as a function of angle of attack.

Because these inlets are well forward and outboard of the aircraft CG, pitching, rolling, and yawing moments are developed by the inlet aerodynamics as engine airflow changes. Although these forces and moments are small in conventional flight, they become significant when the flight controls are locked. If hydraulic pressure to the inlet ramp actuators is lost, if the inlet control system fails, or if the pilot selects it, the inlet ramps go to a full-up "emergency" position. The inlet cowl angle, ρ , is -4° when the ramps are in this position. This emergency position was used for the majority of F-15 throttles-only tests (except where noted) to help simulate loss of hydraulic pressure.

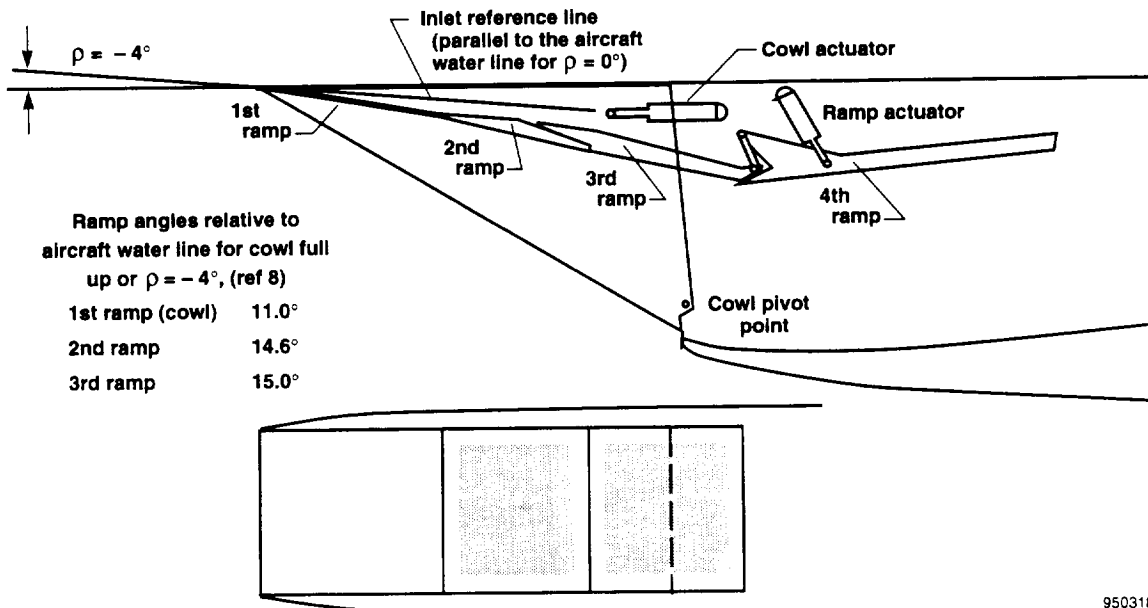

950318

(a) The F-15 inlet in the full-up "emergency" position.

Figure 10. Inlet of the F-15 airplane.

Figure 10(b) shows the automatic schedule of the inlet control system and emergency inlet first-ramp position for level flight. At the angle of attack for landing ($9^\circ-10^\circ$), the automatic schedule would be full-down ($\rho = 11^\circ$); whereas, the emergency position is full-up.

This large difference in inlet cowl position results in significant changes in aircraft drag and pitching moment and small changes in lift (fig. 10(c)). Appendix A shows 7.5 percent scale wind-tunnel data⁸ that was extrapolated and interpolated using flight data to

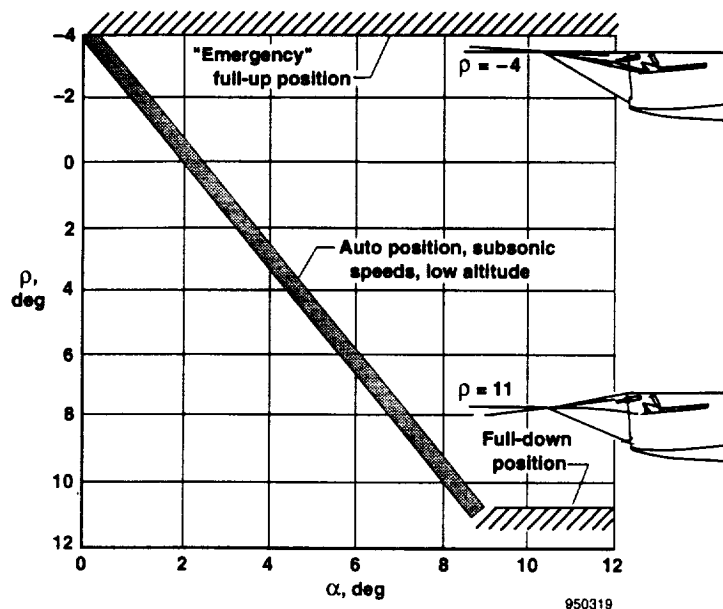

(b) "Auto" and "emergency" cowl position, level flight.

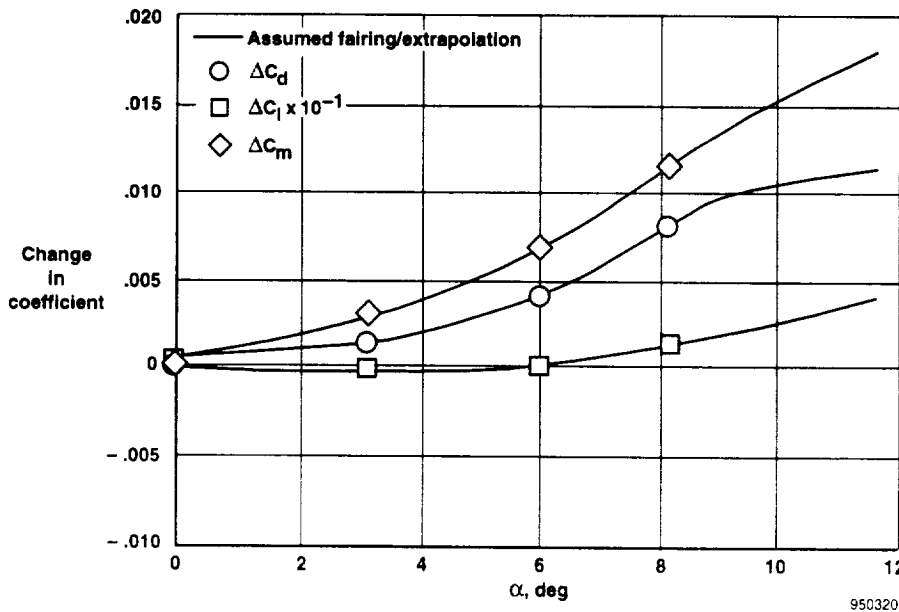

(c) Automatic-to-emergency increments in total aircraft lift, drag, and pitching moment coefficients, *PLF* at 150 knots, level flight.

Figure 10. Concluded.

develop the data (fig. 10(c)). Because the F-15 simulation aerodynamic database assumes automatic-schedule inlet operation, these changes were incorporated into the F-15 simulation for operation in the emergency position.

Operation with inlets in the emergency position is somewhat destabilizing as indicated by the noseup pitching moment that occurs with increasing angle of attack. The increase in drag at the landing angle of attack is more than 10 percent, which raises the required thrust. The pilots noted significantly increased noise when the inlets were in the emergency position that was probably caused by excess air being spilled around the inlet sideplates.

Figure 11 shows the dimensions of the propulsion system forces. Inlet forces and moments are assumed to pass through the center of the inlet, fuselage station (FS) 372.4, butt line (BL) 43.0, and water line (WL) 113.2.

Engines

Developmental F100 engine model derivative (EMD) engines built by Pratt & Whitney (West Palm Beach, Florida), designated PW1128, are installed in the NASA F-15 airplane. These engines were derived from the F100-PW-100 engine, have a maximum thrust of 27,000 lbf, and include a redesigned high airflow fan

(fig. 12(a)) and other improvements. (This fan was later incorporated into the F100-PW-229 engine.)

The F100 EMD engines are controlled by a digital electronic engine control (DEEC). Interim control system software, incorporated in these EMD engines, produced slower-than-production-engine response characteristics at low power settings. The engine response remained rapid (thrust time constant approximately 0.7 sec) in the midthrust range. During decelerations to near-idle thrust, the time constant increased to 7 sec. The PW1128 rotor inertias are 6.02 slug-ft² for the low-pressure spool and 4.55 slug-ft² for the high-pressure spool. The power lever angle (PLA) values for the engines are 20° for the idle PLA and 83° for the intermediate PLA.

With the landing gear extended, the engine control system increases the nozzle area to reduce thrust. This feature, called "idle-area-reset," operates for PLA values less than 50°. Figure 12(b) shows the thrust as a function of PLA at conditions of interest for this paper. The PLF thrust value is on the steepest part of the PLA/thrust curve when the landing gear is down. Typical engine thrust at intermediate power at an altitude of 3000 ft and 190 knots was 12,500 lbf for each engine, while PLF was approximately 3500 lbf for each engine. For PCA flights, the engines were limited to nonafterburning power settings.

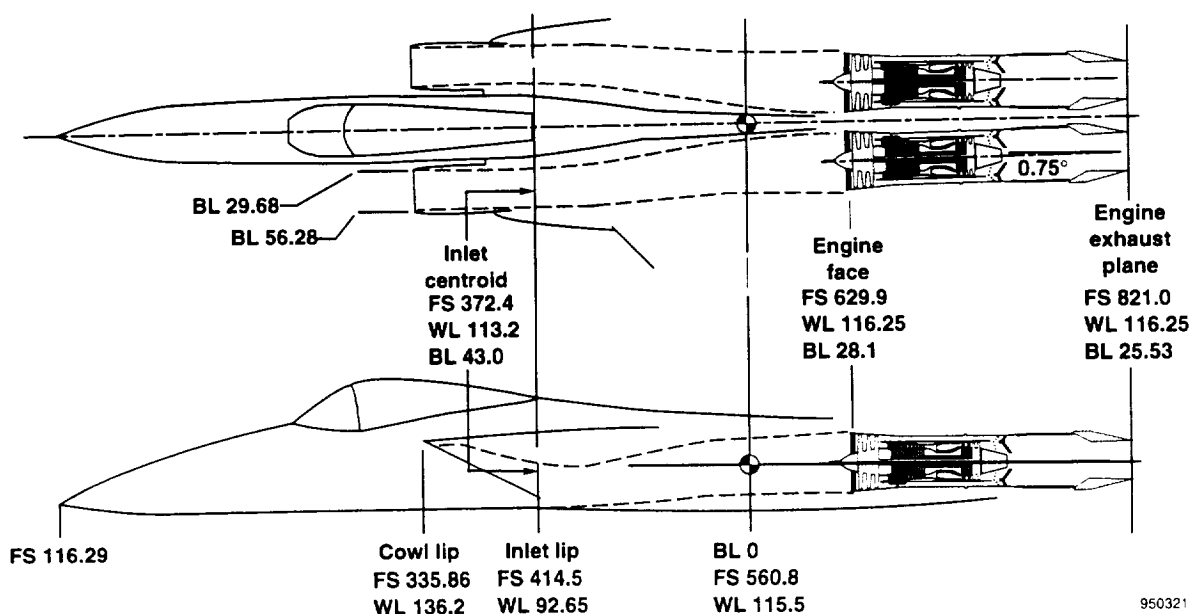
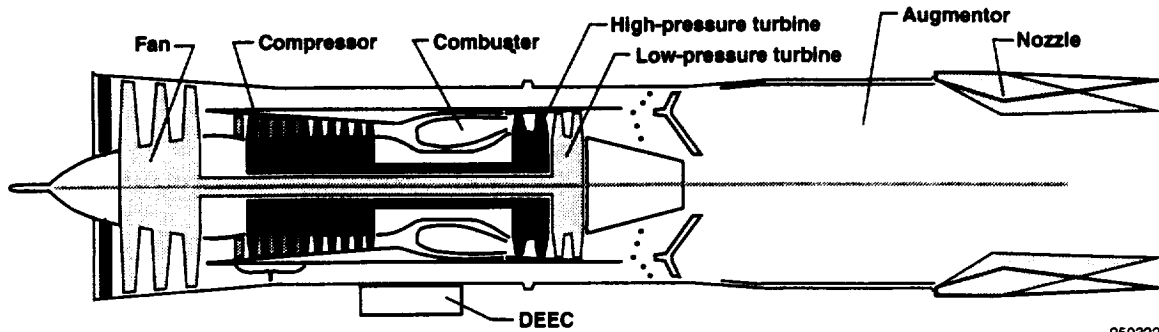
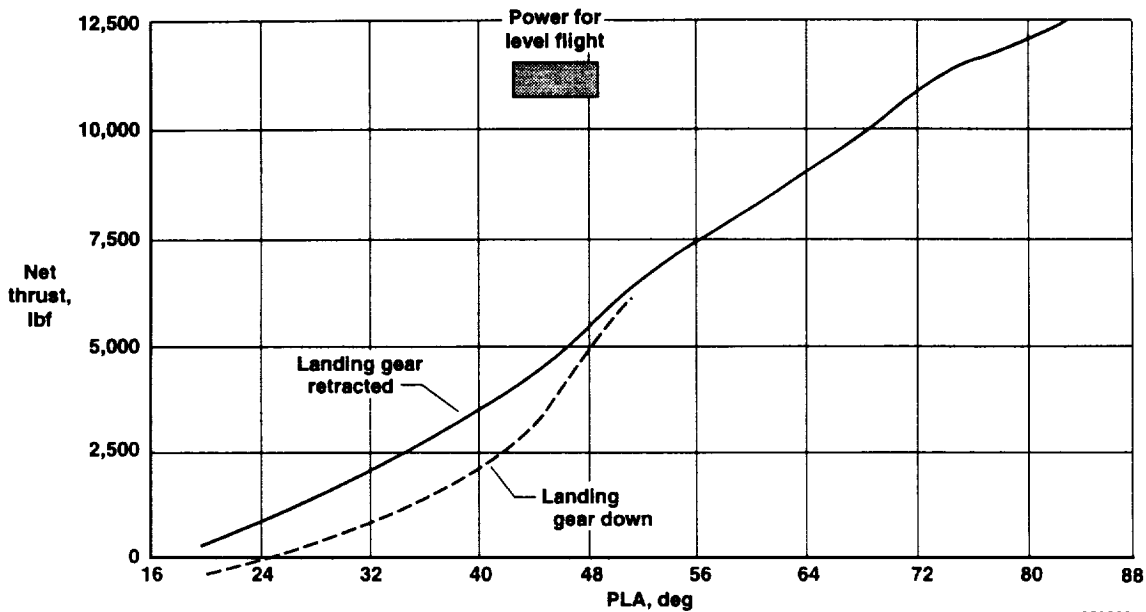

Figure 11. Location of the NASA F-15 inlet and engine forces with respect to the CG for PCA flight tests, mid-fuel, gear down (dimensions in inches).



(a) Cutaway view.



(b) Thrust as a function of *PLA* for a single engine, altitude = 3000 ft, Mach 0.3.

Figure 12. The F100 engine model derivative (PW1128) engine.

Figure 11 shows the location of the engines and the thrust vectors. The engines are mounted close together in the aft fuselage. The nozzles are 4.25 ft apart. The engines are canted out 0.75° from the fuselage reference line in the horizontal plane and aligned with the fuselage reference line at waterline 116.25 in. in the vertical plane.

Flight Control System

The NASA F-15 flight control system incorporated the standard F-15A mechanical flight control system and a nonstandard digital implementation of the

standard F-15 control augmentation system (CAS). For throttles only-control research, the CAS could be turned off and the mechanical system could be switched to a setting that keeps the pitch and roll ratios in one fixed position. Placing the pitch and roll ratios in this emergency position (PARRE) eliminated any flight control system feedbacks and prevented surface motion except that caused by pilot inputs. This CAS-off PARRE mode simulated the total locking of the flight controls, which is similar to what would occur with loss of all hydraulic pressure. In this mode, damping is light, response is sluggish, and stick forces are high, but the airplane may still be flown and landed safely.

In the CAS-off PARRE mode, the normal full range of pilot pitch trim was not available. At full fuel weight, with the inlets set to automatic and the flaps up, the airplane could not be trimmed below an airspeed of 190 knots. With the inlets set to the emergency position, the trim speed could be as low as 175 knots. With the flaps down, trim speed could be as low as 155 knots

(figure 13(a)). At less than full fuel weights, the trim speeds were correspondingly lower. More details of the flight control system have previously been given.⁹

Figure 13(b) shows the typical flight angle of attack as a function of airspeed with the inlets in the emergency position. Lowering the flaps reduces the angle of attack by approximately 2°.

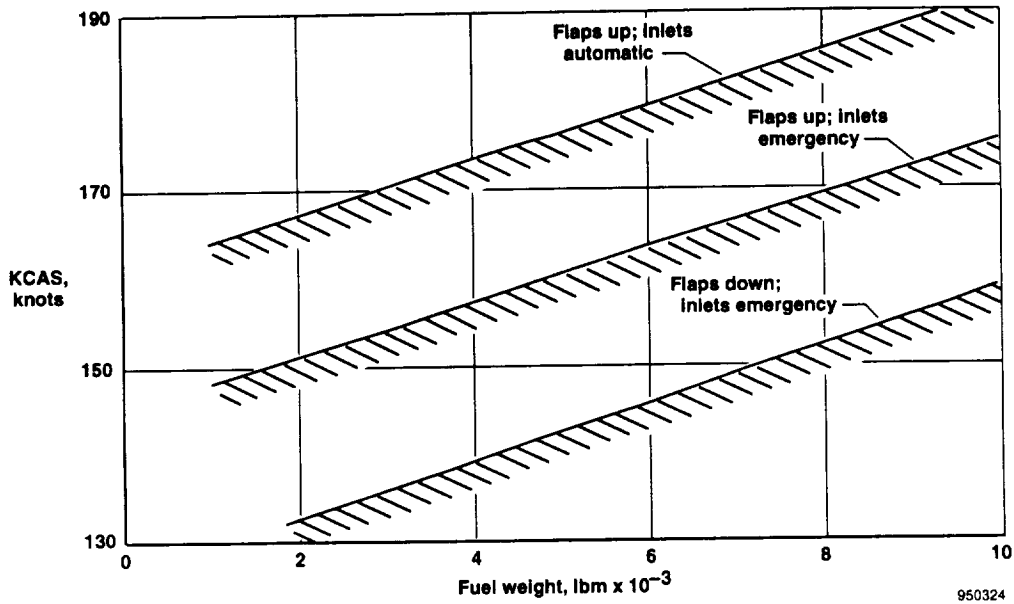

(a) Minimum trim speeds for the NASA F-15, CAS-off PARRE, full noseup pitch trim.

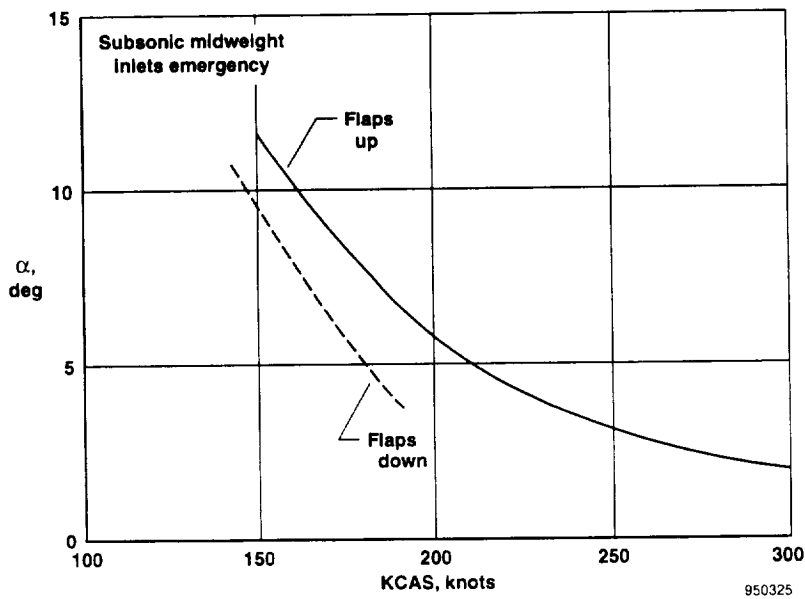

(b) Level flight angle-of-attack for PCA flight tests, subsonic, midweight, inlets emergency.

Figure 13. The NASA F-15 CAS-off PARRE flight speeds and angle-of-attack.

Head-Up Display

The F-15 airplane is equipped with a head-up display (HUD) that provides flight information, such as flight-path, heading, airspeed, and altitude. A velocity vector symbol, driven by the inertial navigation system, is available for determining the precise flightpath relative to the ground. For some flights, the radar altimeter height above the ground was displayed on the HUD.

Weight, Inertia, and Center of Gravity

Weight, inertia, and CG effects of the F-15 airplane are significant in the throttles-only control mode. These parameters vary as a function of fuel quantity.

Weight

The NASA F-15 airplane with F100 EMD engines has a zero-fuel weight of 30,035 lbm. This weight includes the pilot, instrumentation system, and test equipment. Maximum fuel quantity is 11,600 lbm; typical fuel quantity at takeoff is 10,000 lbm.

Inertia

The F100 EMD engines are each approximately 400 lbm heavier than the standard F100 engines. This weight is combined with ballast mounted in the nose to maintain CG. The extra weight increases the pitch and yaw inertias significantly with respect to a standard F-15 airplane. Figure 14(a) shows the variation in moments and product of inertia with fuel quantity for the NASA F-15 airplane.

Center of Gravity

Figure 14(b) shows the horizontal and vertical CG variations. Extending the landing gear moves the CG aft and down by 0.75 in. As fuel was burned with the landing gear down, the vertical CG moved down relative to the engine thrust line from 0.7 in. to -1.0 in., and the horizontal CG moved aft from 26.3 to 28.4 percent M.A.C. Testing was terminated at a fuel weight of 2500 lbm.

Differences from Production F-15 Aircraft

The NASA F-15 airplane has four differences from standard production F-15 aircraft that might affect the throttles-only control capability. First, this airplane does not have the open-cell foam in the wing tanks. This absence increases the tendency for the wing tank fuel to migrate to the extremes of the wing tanks during maneuvering. Second, this preproduction airplane has throttle cables that have more bends than production airplanes. This characteristic results in increased throttle friction and a tendency for the throttles to stick and then break loose during throttle-only manual control. Third, the nonproduction F100 EMD engines have slower and somewhat less predictable response than production engines. Fourth, the airplane has the preproduction small speed brake.

Although none of these differences is a major factor, they each could contribute to difficulty in throttles-only control. The throttle friction is not an issue under PCA system control because the throttle cables do not move in this mode. The landing gear is also 6 in. further aft on the preproduction NASA F-15 airplane, but this has a negligible effect for PCA system tests.

Instrumentation

The F-15 airplane was instrumented to measure more than 700 parameters for the throttles-only control and PCA system flights. All typical engine and airplane parameters were measured. The digital engine and flight control system data on the data buses were recorded. A radar altimeter was installed for the ground-effect tests and was displayed on the HUD, and its readings were recorded. Pilot thumbwheel positions and approximately 100 internal, digital, PCA-system calculated parameters were recorded. These data were recorded onboard and telemetered to the ground for recording and real-time display. The pilot's navigation control indicator (NCI) panel entries that modified the PCA system control logic gains and constants and options were also sent to the control room for verification. A continuously recording microphone (hot mike) provided a record of pilot comments. The HUD video camera output was recorded onboard and telemetered for real-time display in the control room. For some flights, the NASA F-15 airplane was equipped with a radar altimeter that provided height above ground level (AGL) for the HUD and data system.

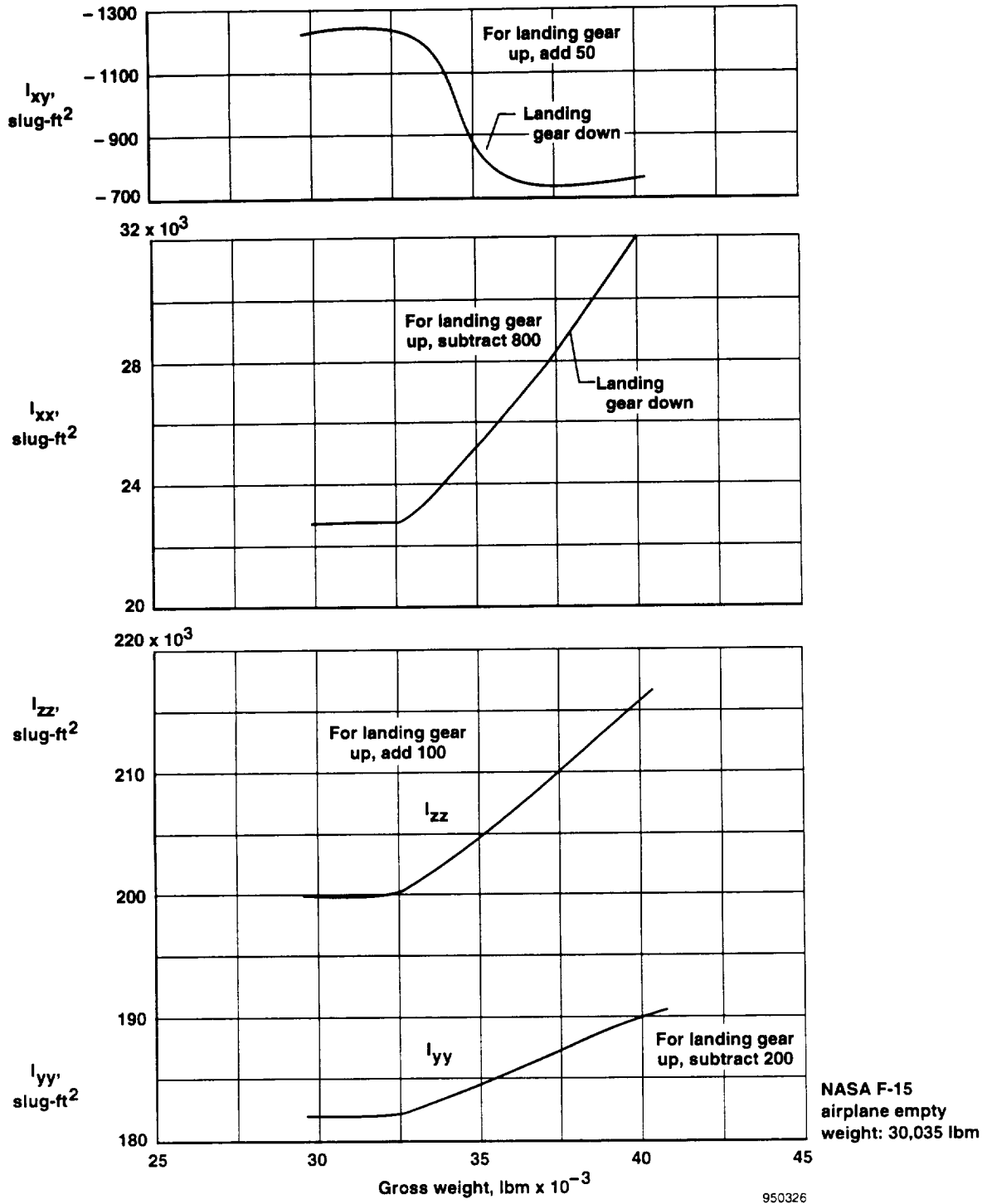

(a) Moments and products of inertia, CG = 28 percent, gear down.

Figure 14. Variation of moments of inertia and CG with fuel weight for the NASA F-15 airplane.

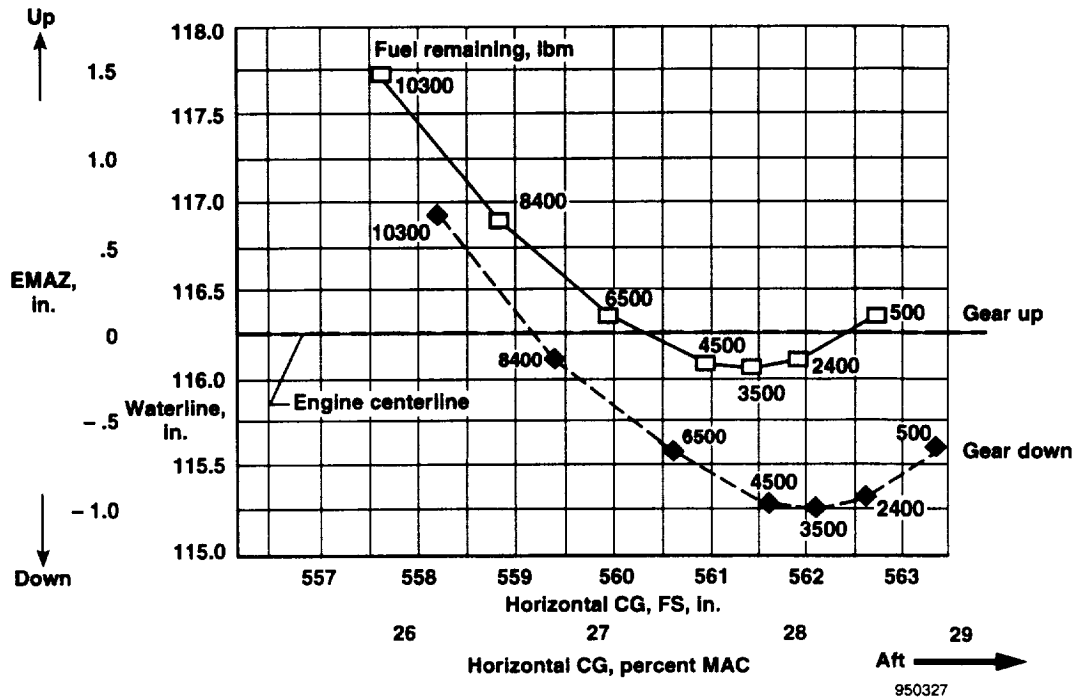

(b) Vertical and horizontal CG for the NASA F-15 HIDE C airplane.

Figure 14. Concluded.

F-15 SIMULATION

Two F-15 airplane simulations were used in this study: one at NASA Dryden and the other at the MDA Simulation Facility in St. Louis, Missouri. The NASA Dryden F-15 simulation is a fixed-base, full-envelope, six-degree-of-freedom aircraft simulation installed in a fighter cockpit (fig. 15(a)). This model contains nonlinear aerodynamics, a nonlinear flight control system, and originally, a first-order engine response model. A simple but effective visual system consists of a 20 in. monitor driven by a high-resolution graphics display of the Edwards, California, area.

The MDA F-15 simulation is a fixed-base simulation that features an F-15 cockpit and a high-fidelity visual capability incorporating scenery projected onto a 40 ft dome (fig. 15(b)). The aerodynamic, control system, and propulsion system models were similar to those at NASA Dryden. Edwards scenery was also available in the MDA simulation.

Many improvements to the F-15 simulations at NASA Dryden and MDA were required for the PCA project. The NASA Dryden simulation upgrades are summarized in table 1 and are discussed in the Results and Discussion section.

THROTTLES-ONLY CONTROL MODES

Two throttles-only control modes were studied for the F-15 airplane. The modes were throttles-only manual control and PCA-system augmented throttles-only control.

Throttles-Only Manual Control Tests

For the throttles-only manual control tests, the pilot selected the CAS-off PARRE configuration, trimmed the airplane, and released the stick. Only the throttles were then used for flight control. To climb, the pilot increased the throttle setting until the desired climb angle was reached, then modulated thrust to maintain this angle. The reverse was used for descents.

For turns to the right, the pilot advanced the left throttle and retarded the right throttle until the desired bank angle was reached. The differential throttle was then modulated to maintain the bank angle as long as desired. Unfortunately, each throttle change excited the phugoid, and all but very small bank angles coupled into the pitch axis, making the task more difficult.

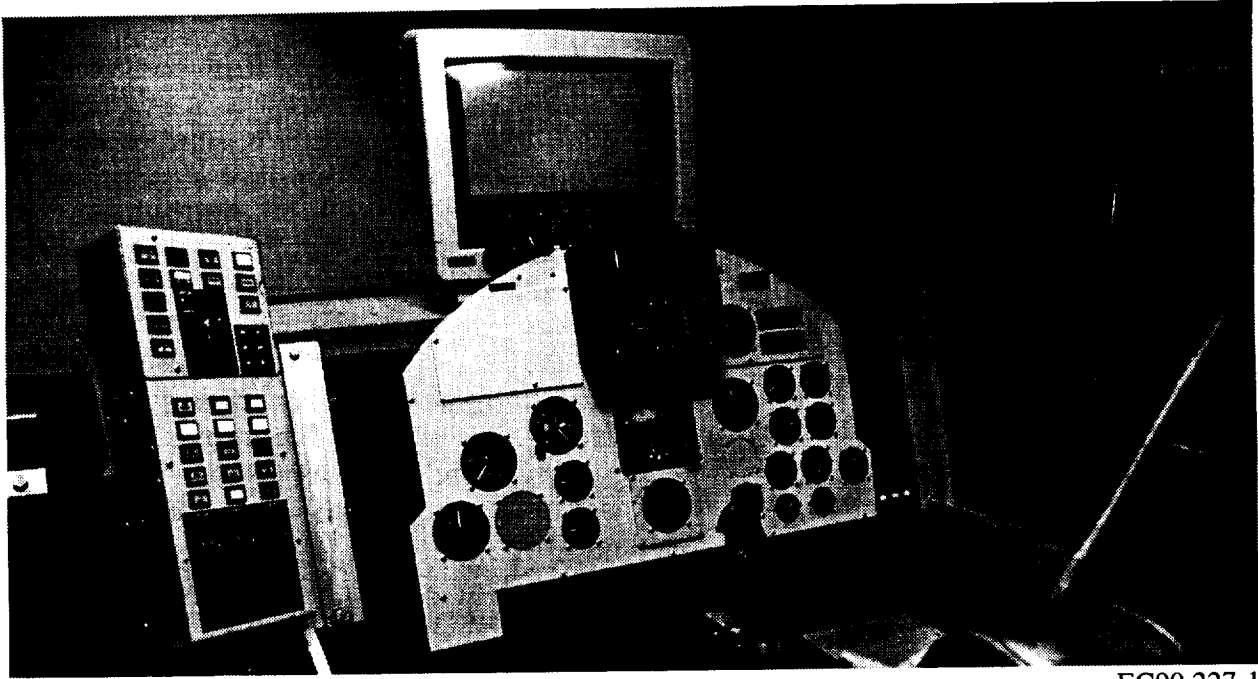

EC90 227-1

(a) Dryden F-15 simulation cockpit.



(b) The MDA simulation cockpit, St. Louis, Missouri.

Figure 15. The F-15 simulators used for the PCA tests.

Table 1. Changes to the NASA Dryden F-15 simulation.

Upgrade	Simulation change
S1	Lock surfaces at any given position
S2	Incorporate augmented PCA control laws from B-720 airplane ⁴
S3	Incorporate effects of the inlets emergency at $\alpha = 8^\circ$
S4	Separate gross thrust and ram drag terms in the thrust tables
S5	Add thumbwheels for control inputs
S6	Incorporate vertical and horizontal CG as a function of fuel quantity
S7	Model CAS-off PARRE flight control system
S8	Add MDA ground-effect model
S9	Add landing gear dynamics model
S10	Incorporate nonlinear Ed Wells engine model
S11	Add engine gyroscopic moments
S12	Accept flight <i>PLA</i> inputs into the simulation batch mode
S13	Add nonlinear inlet effect at $\alpha = 8^\circ$ (fig. 26)
S14	Add MDA control laws, trim function, and the three trim modes
S15	Add flightpath command box to HUD (fig. 17)
S16	Incorporate updated CG, inertia, weight for NASA F-15 airplane (fig. 14)
S17	Incorporate velocity feedback into PCA control laws
S18	Incorporate revised ground-effect model (fig. 36)
S19	Incorporate heading command mode (fig. 47)
S20	Incorporate updated differences between automatic and emergency inlets for full α range and the inlet effect as a function of α and <i>PLA</i> (fig. 52)

Propulsion-Controlled Aircraft System Mode

Figure 16 shows the PCA system installation on the F-15 airplane. Most of the equipment used for the PCA system had been previously installed on the NASA F-15 airplane for other integrated control research as part of the Highly Integrated Digital Electronic Control (HIDEC) system (fig. 16(a)).¹⁰ The equipment included the digital flight control computer, general-purpose research digital computer, F100 EMD engines with DEECs, cockpit HUD and control system input/output, interface equipment to allow these systems to communicate, and data system and tape recorder. The PCA system hardware was implemented by adding only the attitude command thumbwheel controllers in the cockpit.

The various avionics and PCA system units communicate with each other through digital data buses (fig. 16(b)). The logic for the PCA control laws resides in the general purpose research computer in FORTRAN code. Digital inputs are received from the digital flight control system located in the vehicle management system computer, the inertial navigation set, the airdata computer, the digital engine controls, and the pilot's pitch and roll thumbwheels. The PCA system sends throttle commands to the internal DEEC electric throttle command logic without driving the throttles in the cockpit. No commands are sent to the inlets during PCA operation.

Figure 17(a) shows the F-15 HIDEC airplane cockpit and the location of the PCA equipment, including the thumbwheel controllers, the HUD, the navigation control indicator (NCI), and the switches and control panels associated with the PCA and HIDEC systems. The HUD had symbology modified to add a box that indicated the position of the PCA system flightpath command and trim status (fig. 17(b)).

The thumbwheels were located just aft of the throttles on the pilot's left console (fig. 17(a)). The thumbwheels each had a detent at the zero position and $\pm 175^\circ$ of total rotation.

Propulsion-Controlled Aircraft System Control Logic

Figure 18 shows a simplified block diagram of the initial PCA system control law. In the pitch axis, pilot thumbwheel command for flightpath angle is compared

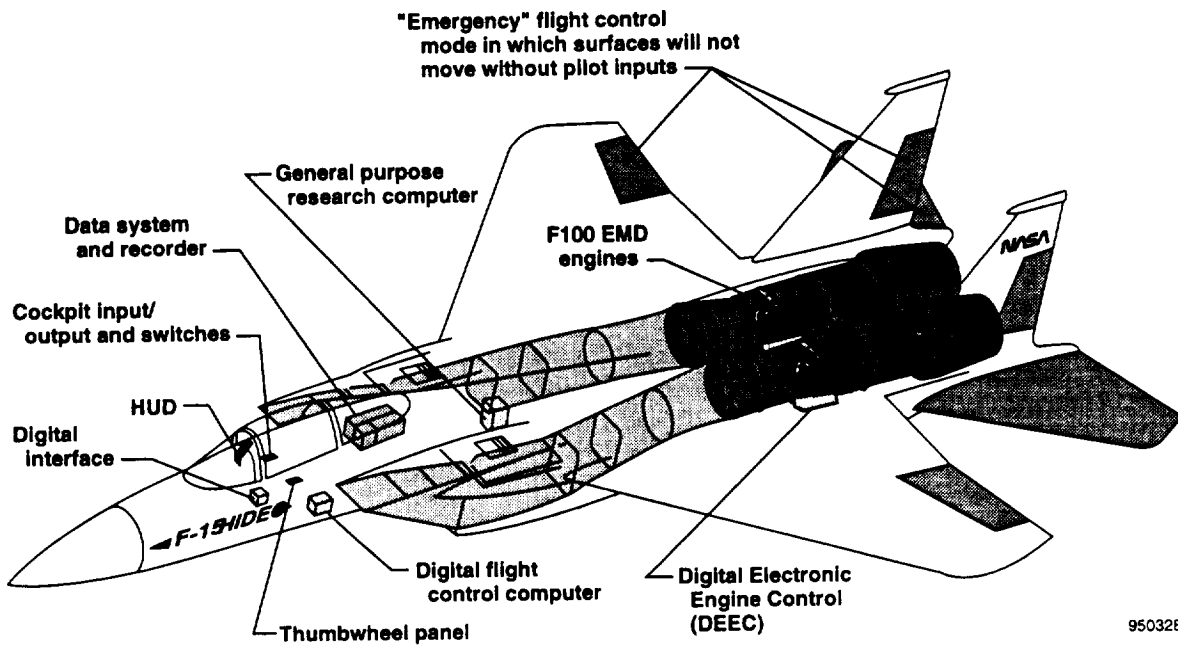

950328

(a) Features of the F-15 HIDEC airplane for the PCA tests.

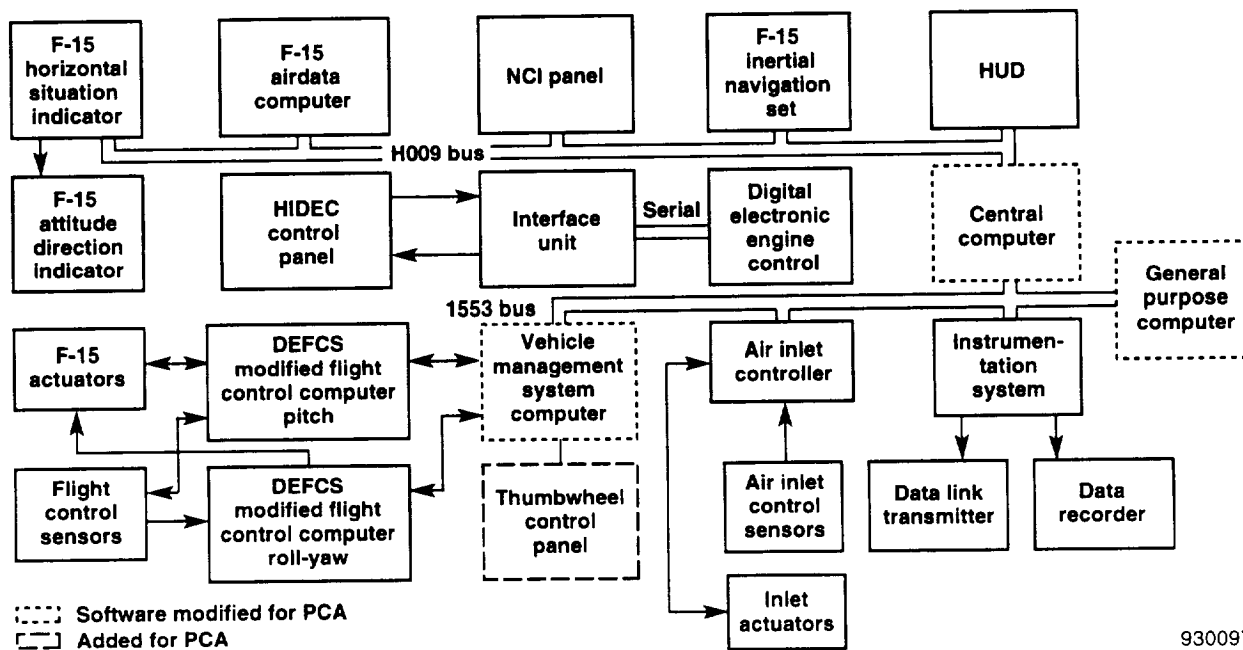

930097

(b) Electronic equipment used for the PCA tests.

Figure 16. The PCA system on the NASA F-15 HIDEC airplane.

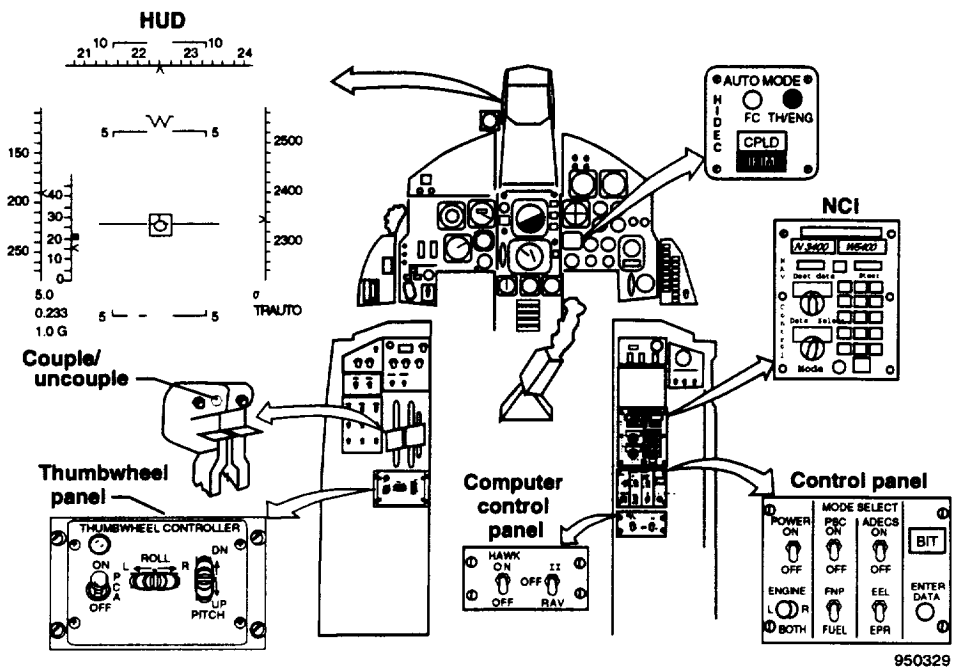

(a) The PCA cockpit equipment configuration.

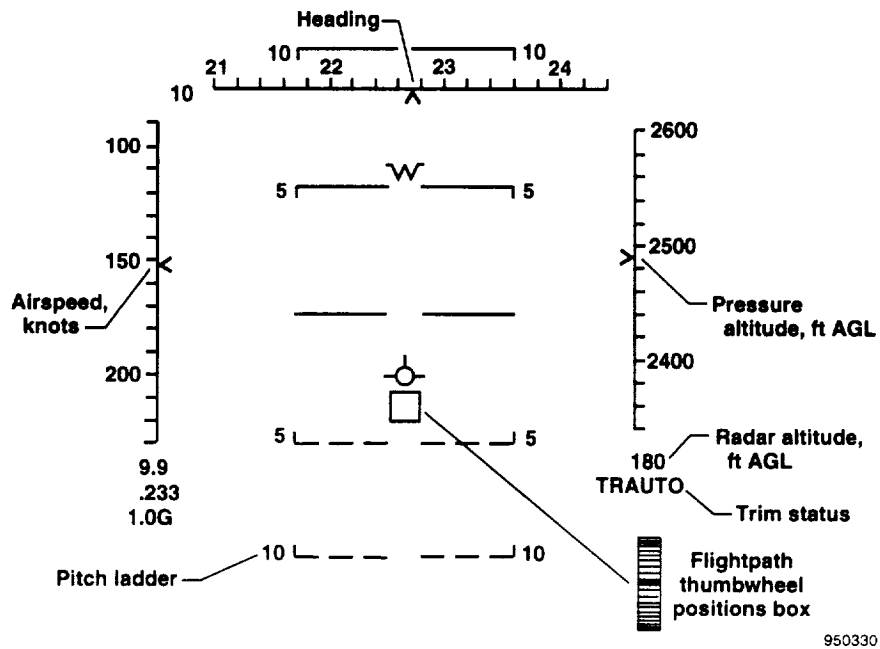

(b) Head up display.

Figure 17. The PCA system in the NASA F-15 cockpit.

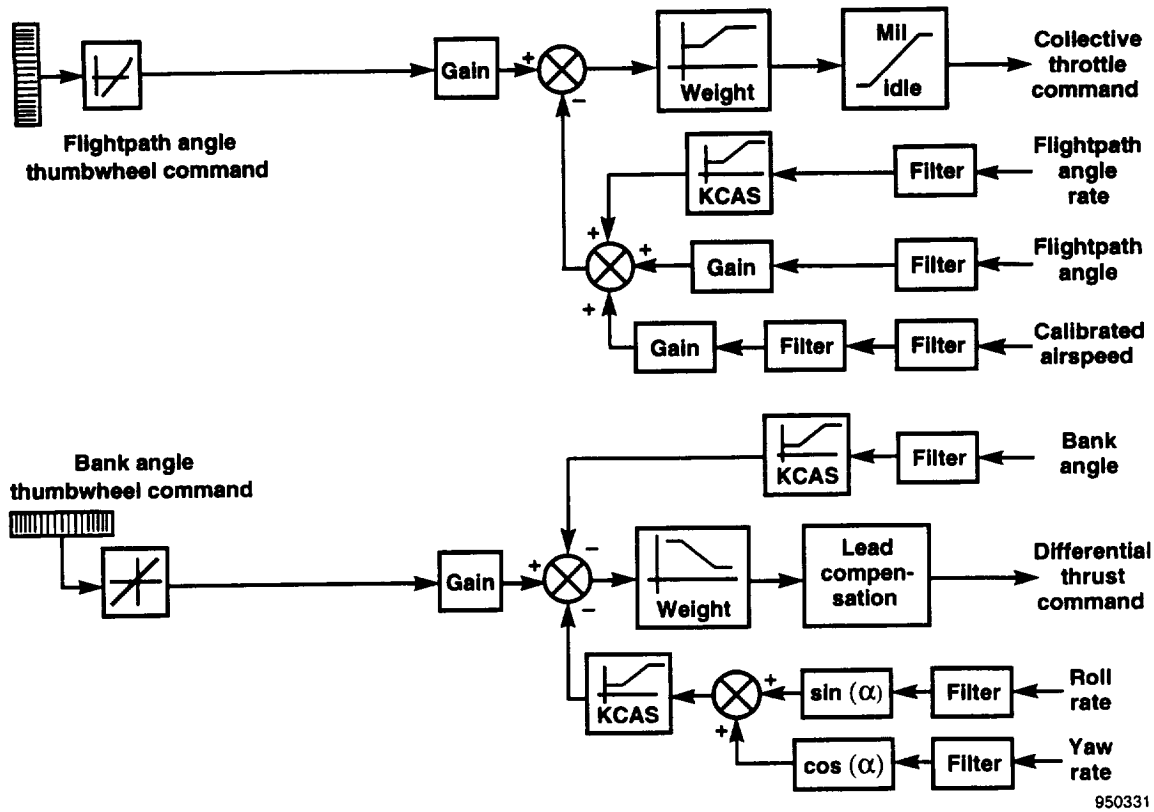

Figure 18. The F-15 PCA control logic.

to the sensed flightpath angle. The flightpath angle rate is used as feedback to assist in phugoid damping. Collective (equal) thrust commands are sent to both engines to obtain the commanded flightpath. The thumbwheel flightpath command is displayed to the pilot on the HUD using a small box symbol. Normal flightpath command limits were 15° to -10° . Velocity feedback was added later in the PCA system development.

In the roll axis, the pilot bank-angle command is compared with yaw rate, roll rate, and bank angle. Differential thrust commands are issued to both engines to obtain the commanded bank angle. Normal bank-angle limits were $\pm 30^\circ$.

The pitch and roll axis control laws were developed by MDA and NASA Dryden using linear models, nonlinear simulations, and nonlinear piloted simulations. Extensive changes occurred during the development of these control laws. Details of the PCA system control law design have been given.⁹

The PCA system was engaged by selecting the various cockpit switches to the proper position, then

depressing the button on the right throttle (fig. 17(a)). The system could be disengaged by depressing this button again, by moving the throttles or stick more than a predetermined limit, or by tripping the paddle switch on the stick. Numerous automatic features were installed to disengage the PCA system in case the system malfunctioned or exceeded predefined limits.

Variable gains, filters, multipliers, and gain schedules, selectable by the pilot, were available at most points within the PCA software, providing a great deal of flexibility for testing. This flexibility became extremely important during the flight tests. Other features were added to the control laws during the testing. These features are discussed in the Results and Discussion section.

Propulsion-Controlled Aircraft Controller Study

After the preliminary PCA system control law analysis, a trade study was performed on the MDA F-15 flight simulator to investigate the best type of controller and controller location for the pilot to use to make

inputs to the PCA system. The following four types were studied:

1. Thumbwheels with a pitch wheel proportional to the change in flightpath angle and a roll wheel proportional to change in bank angle. A detent was used for the zero position. The thumbwheels were located just aft of the throttles on the left console.
2. A small stick (or joystick) with position fore and aft for flightpath changes and left and right for bank-angle changes. The stick was also located aft of the throttle quadrant.
3. A small sidestick controller using force instead of position to command PCA system changes.
4. The F-15 center stick with pitch rate and roll rate commands.

The results showed that the thumbwheels were the best choice for flightpath precision and pilot anticipation of the proper command level.⁹ The joysticks resulted in overcommanding the desired inputs. The use of a center stick for PCA system operation would be possible for fly-by-wire aircraft application. For the F-15 airplane with the combined electronic and mechanical inputs to the flight control system, mechanization for the flight test for PCA system steering using the center stick while still maintaining the fixed control surfaces was not feasible.

Center of Gravity Control Study

During the PCA system preliminary design phase, MDA investigated using fuel transfer for CG control in order to vary trim airspeed. Two modes were studied on the MDA simulator: a manual, pilot-activated fuel transfer and a velocity command system that provided automatic control of fuel and CG position. Simulator results showed speed changes of approximately 0.4 knots/sec while maintaining PCA system control. Airspeed changes of a maximum 50 knots were possible, depending on initial conditions, fuel state, and allowable CG position. Details have previously been given.⁹

Flight testing would have required fuel system hardware changes and additional electronics that were beyond the scope of the PCA system investigation. However, the study showed the feasibility for airplanes with a digitally controlled fuel management system.

Propulsion-Controlled Aircraft System Trim Logic

The normal PCA system control laws used proportional control techniques. Integral control, which may be used to trim out biases, was not normally used because the presence of integrators reduced the phugoid damping of the flightpath mode. To eliminate biases in flightpath angle and bank angle that occurred when the PCA system was first engaged, a trim function that included integrators in the pitch and roll axes was provided (fig. 19).

The pilot could select "trim on," "trim off," or "trim auto." With "trim on" selected, the trim loop remains active. With "trim off" selected, the trim loop is bypassed. With "trim auto" selected, the trim is active until trim requirements are satisfied. Biases are reduced to less than a preset value; the trim is then bypassed. To indicate the trim status to the pilot, the flightpath command box flashed when the trim mode was active, then became steady when trim was bypassed. The trim status was also displayed on the HUD below the radar altimeter readout (fig. 17(b)).

Propulsion-Controlled Aircraft System Implementation

The PCA system logic was installed in the general purpose computer. The PCA system interface software was located in the central computer and, to a lesser extent, in the vehicle management system computer. Table 2 shows the PCA system computational requirements. Most of the code served to provide the safety checks and flexibility for the flight test. The flight software was considered "not flight-safety critical" because the pilot had multiple ways to disengage the PCA system and still had the mechanical flight control system available as a backup. The details of the software development and implementation have been given.⁹

The PCA system was designed for a very limited-envelope flight evaluation of throttles-only augmented control. The system was designed to function at airspeeds between 170 and 190 knots at altitudes below 10,000 ft. An assumption that the airplane would be trimmed in level flight at the desired test conditions before PCA system engagement existed.

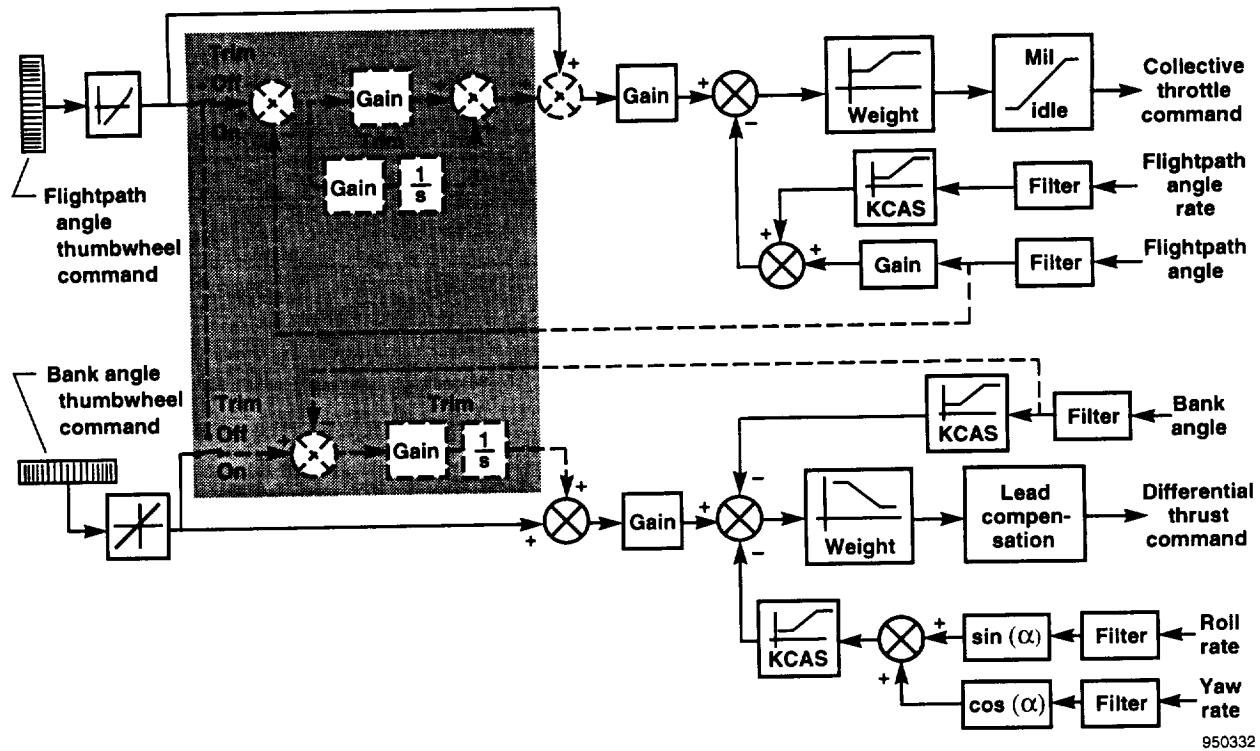

Figure 19. Simplified PCA control law with the trim function shown in the shaded region.

950332

Table 2. Propulsion-controlled aircraft software module size and execution time.

Module	Time to execute, msec	Size, bytes
Initialization	2.8	5,126
Data input/output and communication	4.2	48,550
Signal monitoring	0.9	1,550
Signal conditioning	0.6	1,394
Trim control law	0.4	1,451
Control law	1.7	9,010
Ground test and maintenance	---	48,494
Flight test mode control	---	23,295
Total	10.6	138,870

TEST PROCEDURE

Procedures were developed to assess the throttles-only control capability of the F-15 airplane and simulation. To avoid the presence of flight control system inputs, the emergency mode was selected for the mechanical flight control system (the CAS-off PARRE mode). In this mode, the flight control surfaces would not move if the pilot did not move the stick or rudder pedals. The inlet was moved to its emergency position, simulating what would occur if hydraulic pressure were lost. For low-speed approach and landing tests, the landing gear and electrically powered flaps were lowered. The pilot trimmed the airplane to the desired airspeed and then released the flight controls. The flight controls remained available at all times; hydraulics were not turned off.

Open-loop throttles-only manual control tests, including small- and full-throttle steps, were flown, and the aircraft response was observed and related to control capability. Phugoid tests were also flown. For longitudinal open-loop tests, the pilot was sometimes

allowed to use small rudder inputs to keep the wings level; otherwise, the airplane would roll off before sufficient data could be obtained.

The augmented system tests were initially conducted by following the same procedure used for throttles-only manual control tests. The pilot trimmed the airplane and then engaged the PCA system in approximately level flight. The PCA system trimming took approximately 20–30 sec in smooth air. During this time, thumbwheel commands could be made, but often the trimming was completed in level flight. This procedure often resulted in unequal throttle settings for PCA-system level flight. Another procedure used had the pilot first closely match the engines using fan speed callouts from the ground control room, then use rudder trim to minimize sideslip and aileron trim to level the wings.

Initial tests involved making small step commands in pitch and roll from level flight at several flight conditions. When these tests were complete, combinations of pitch and roll commands were tested, followed by PCA system approaches to the runway at Edwards. Initial approaches were flown using the PCA system to a preplanned altitude, with the pilot taking over and making a CAS-off PARRE mode landing. Finally, approaches to PCA system landings were made. Later, PCA system engagements at other than trimmed conditions were made, including upset conditions; and the flight envelope (speed, altitude, bank angle) was expanded.

Throttles-only manual control techniques were also evaluated, first with gentle maneuvers at an altitude of approximately 10,000 ft. Later, numerous landing approaches using throttles-only manual control were attempted.

Guest pilots as well as the NASA project test pilot tested the PCA system. Guest pilots included NASA, USAF, Navy, and MDA personnel (table 3). A series of flight cards were developed to demonstrate the PCA system capabilities and allow the pilots to evaluate its performance.

Each guest pilot received a briefing on the PCA concept, its implementation on the NASA F-15 airplane, and the predicted performance. The guest pilots then flew the flight test cards (table 4) in the NASA Dryden simulator, repeating as desired. A detailed cockpit briefing was then held, and the actual flight

followed within a few days. The NASA test pilots flew the points listed in table 4 and other PCA-system test points.

Table 3. Pilots for the propulsion-controlled aircraft system flight evaluation.

Pilot	Affiliation	Current assignment
A	NASA	NASA Dryden F-15 PCA Project Pilot
B	NASA	NASA Dryden F-15 Project Pilot
C	USAF	Guest, Experimental Test Pilot, 445th Test Squadron, Edwards AFB, CA
D	MDA	Guest, Contractor Test Pilot, F-15 Combined Test Force, Edwards AFB CA
E	NASA	Guest, NASA Dryden F-18 Project Pilot
F	NASA	NASA Guest, Dryden Chief, Flight Operations
G	USAF	Guest, USAF Test Pilot School, Edwards AFB, CA
H	NAVY	Guest, F-14 Test Pilot, Naval Air Warfare Center, Patuxent River, MD
X	NASA	NASA Dryden Propulsion Branch Chief
Y	NASA	NASA Dryden F-15 Project Manager
Z	NASA	NASA Dryden Chief Pilot

RESULTS AND DISCUSSION

Flight and simulation tests were conducted over a period of 3 years prior to actual PCA system flights (table 5). For the first year, these tests were low-level concept feasibility tests often consisting of one or two test points at the end of a flight performed with minimum instrumentation. Simulation improvements and high-priority flight tests followed as understanding of

Table 4. Test cards for the propulsion-controlled aircraft system guest pilot evaluation.

Inlets emergency, gear and flaps down 150 knots, CAS-off PARRE,	Cruise configuration (gear and flaps up, inlets automatic) 260 knots, CAS-off PARRE
CAS-off flight control and handling qualities evaluation	PCA system recovery from simulated hydraulic failure and upset
Up-and-away throttles-only manual control, small pitch, then small heading changes, then combined pitch and heading control	With stick, fly to 90° bank, release controls, inlets to emergency position, engage PCA system as flightpath falls through -10°
PCA-engaged step response, small pitch, roll inputs, combined	After recovery, with wings level and nose dropping, lower gear and flaps
PCA approach to 200 ft AGL, disengage, touch-and-go landing	Descend and perform approach to 20 ft AGL
PCA approach to 100 ft AGL, PCA go-around	
PCA approach to 50 ft AGL, disengage, touch and go	
PCA approach to 20 ft AGL, disengage, touch and go	
Throttles-only manual approach to 200 ft AGL, go-around	

Table 5. F-15 throttles-only and propulsion-controlled aircraft flights.

Flight #	Date	Pilot	Remarks
Concept study noninstrumented engines, nondedicated flights.			
578	3/23/90	Z	300 knot eval CAS on, off, no PLA data
580	3/28/90	B	300 knot eval, no PLA data
581	4/3/90	Z	No PLA data, little usable data
582	7/6/90	B	No PLA data, 1 test point
595	12/20/90	F	F100/EMD, 170 knot steps, gear up/down
Dedicated throttles-only control feasibility flights			
607*	3/14/91	A	F100/EMD, gear up big PLA steps at 170, 200, 240, 300, CAS off flight and approaches
608	3/26/91	A	F100/EMD, smaller PLA steps, effect of flaps, inlet ramps, gear, several speeds
Instrumented engines, throttles-only data flights			
616*	7/2/91	A	EMD/EMD, approaches, PARRE eval, GE
617	7/9/91	Z	One manual throttles-only approach

Table 5. Concluded.

Flight #	Date	Pilot	Remarks
Instrumented engines, throttles-only data flights			
634*	9/12/91	A	Gear down 170 kt small <i>PLA</i> steps, phugoid damping, approaches
653*	5/1/92	F	Flaps down phugoid and throttle steps
661*	6/1/92	A	Flaps down steps at 150, phugoid, manual approaches
PCA system installed, PCA flights			
679*	1/22/93	A	First PCA, safety checks, steps, gains
680*	1/25/93	A	Steps, gains, 2 low approaches
682*	1/27/93	A	Steps, gains, filters, 3 approaches
683*	1/28/93	A	Steps, gains, PCA appr and go-arounds
684*	1/29/93	B	PCA steps and appr, PCA go-arounds
685*	2/1/93	A	4 appr, 150 and 170 knots to 50 ft
688*	2/4/93	A	HUD off approach
689*	2/5/93	A	4 appr, one to 10 ft
691*	4/17/93	A	Filters, PCA approaches, windy
692*	4/20/93	A	6 PCA approaches
693*	4/21/93	A	Approaches, 2 PCA landings
696*	6/28/93	A	Maximum banks, heading, rudder, roll integral trim, windy
708*	8/18/93	A	Single engine + rudder, heading, freq sweeps, turbulence response
710*	8/20/93	A	Single engine + rudder, heading
712*	8/23/93	A	No data, photos of single engine mode
713*	8/30/93	A	Climb to 20,000 ft, profile, heading, single eng + rudder, cont trim
PCA guest pilots and envelope expansion flights			
714*	9/1/93	F	NASA guest, approaches, one to 10 ft
717	9/10/93	B	20K to 30K climb on a PSC flight
721*	9/17/93	C	USAF guest pilot, windy
722*	9/22/93	G	USAF guest, gusty crosswind
724*	9/29/92	E	NASA guest, clear and calm
727*	10/6/93	H	NAVY guest, windy
731*	10/15/93	D	MDA guest, windy
734	10/19/93	F	NASA PCA climb at 280 knots, 20,000 to 37,000 ft at Mach 0.88

Total: 36 flights, 9 pilots.

*Dedicated PCA flights.

throttles-only control increased and the concept became more promising. Unless stated otherwise, all data shown is for the F-15 airplane in the CAS-off PARRE, inlets emergency, landing-gear-down configuration.

Initial Throttles-Only Control Simulation and Flight Tests

The first simulation tests at NASA Dryden were made when the first NASA Dryden simulation software improvement, S1 (table 1), was made. This improvement permitted the flight control surfaces to be locked with a software switch at any time.

Initial throttles-only control simulation tests were flown at 250 knots. For the first few minutes, full attention was required just to avoid a crash. After a few minutes, techniques improved rapidly. Roll control was good, but pitch control was sluggish. The ability to hold altitude was poor.

The first preliminary throttles-only flight tests were flown on the NASA F-15 airplane in early 1990 as back-up tests on flights with other objectives. The engines were not instrumented except for cockpit parameters,

and little was known about throttles-only control characteristics. The first tests, performed at 300 knots with inlets set to the automatic schedule and gear up, evaluated the effects of the CAS. As expected, with the CAS on, essentially no effects of throttle setting other than speed change existed. The CAS negated any propulsive moments. With the CAS off, some roll control was available, but the PARRE mode was not selected, and no pitch response existed. The mechanical ratio changer system still effectively masked any pitching moments of the engines.

In the simulation, throttles-only control improved as speed decreased. At 200 knots, pitch control improved, and at 170 knots, it appeared more improved. After approximately 10 min of flying at altitude, a series of landings was attempted by pilot X with the airplane trimmed to a speed of 170 knots. Later, pilot A went through the same short training period and also tried landings.

Figure 20 shows results of these first throttles-only manual control simulation landings. Figure 20(a) shows vertical bars representing the combined sink rate in feet per second and bank angle in degrees at touchdown. Numbers up to 10 are "safe" landings; numbers over

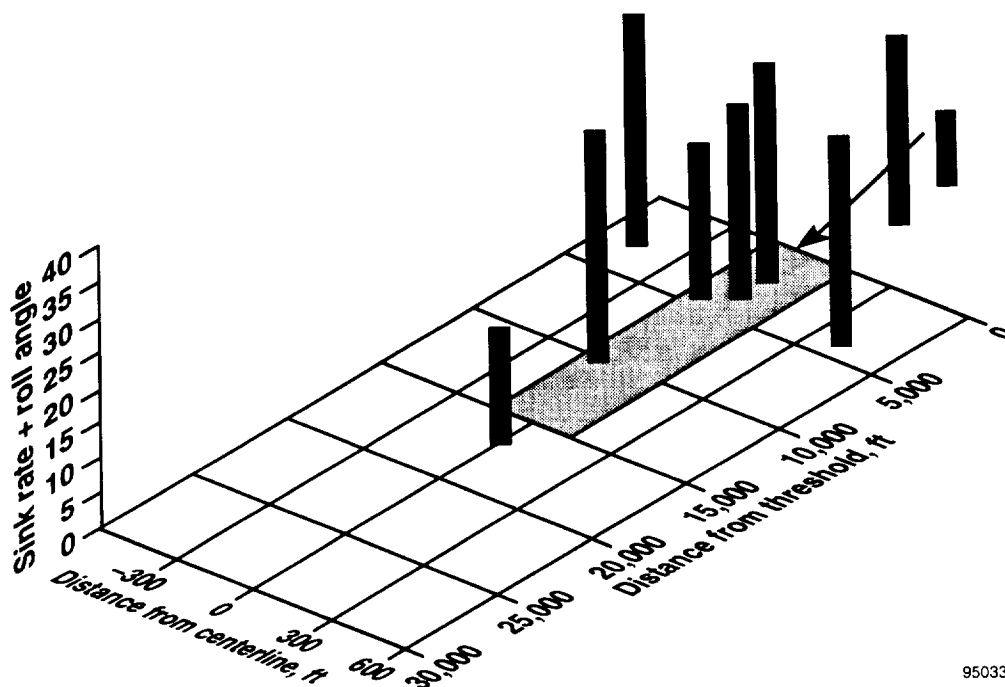

950333

(a) Landing results for the first five landings.

Figure 20. Early simulation manual throttles-only landings for pilots with no previous throttles-only landing experience, F-15, flight controls locked, KCAS = 170 knots, gear down, flaps up.

20 are "unsafe" landings. The bar is located at the touchdown point referenced to a simulation of the Edwards runway. Most of the landings were unsafe (crashes); the only "safe" landing was more than 1 mile short of the runway.

The same results are plotted on a landing difficulty parameter (LDP) plot (fig. 20(b)) that shows the same first five landings of each pilot shown in figure 20(a). Successive landings are also shown. A dispersion penalty was added to the sink rate and bank-angle data (fig. 20(a)) to account for landing off the runway. In all of the first five landings, each pilot had unsafe landing difficulty parameters in excess of 25. However, the additional landings showed improvements with time. After approximately seven landings, each pilot had become proficient enough to make simulated safe landings on the runway.

Shortly afterward, the PCA control laws developed for the B-720⁴ were installed on the F-15 simulation in upgrade S2. The center stick was used for pitch and roll inputs. The first F-15 PCA simulation approach using the B-720 software was successfully landed without any changes. However, the control system gains were such that approximately 50 percent of throttle could be commanded. When the gains had been adapted to the

F-15 airplane, PCA system performance improved significantly when compared over throttles-only manual control performance. Figure 21 shows the LDP for pilots making PCA system landings. These new pilots had not practiced. All landings were safe.

Simulation testing continued. At low speeds the manual control and PCA system appeared to work well enough to continue the study. Simulation upgrades S3, S4, and S5 were made. For the S3 upgrade, tables were added to simulate the lift, drag, and pitching moment effects of the inlets "emergency" position at an 8° angle of attack for speeds of approximately 170 knots.

The simulation thrust model had consisted of net thrust tables. These tables were changed in upgrade S4 to separate the gross thrust, which is aligned with the engine, and the ram drag, which is assumed to act along the airplane velocity vector (flightpath) through the center of the inlet (fig. 6). The effects of this change amounted to approximately a 5-10 percent reduction in propulsion-induced forces and moments.⁷

Thumbwheels were added to the cockpit in upgrade S5 to provide a means, other than using the control stick, for making flightpath and bank-angle commands.

Throttles-only manual approaches in the simulation were initially difficult. After some practice, pilots could

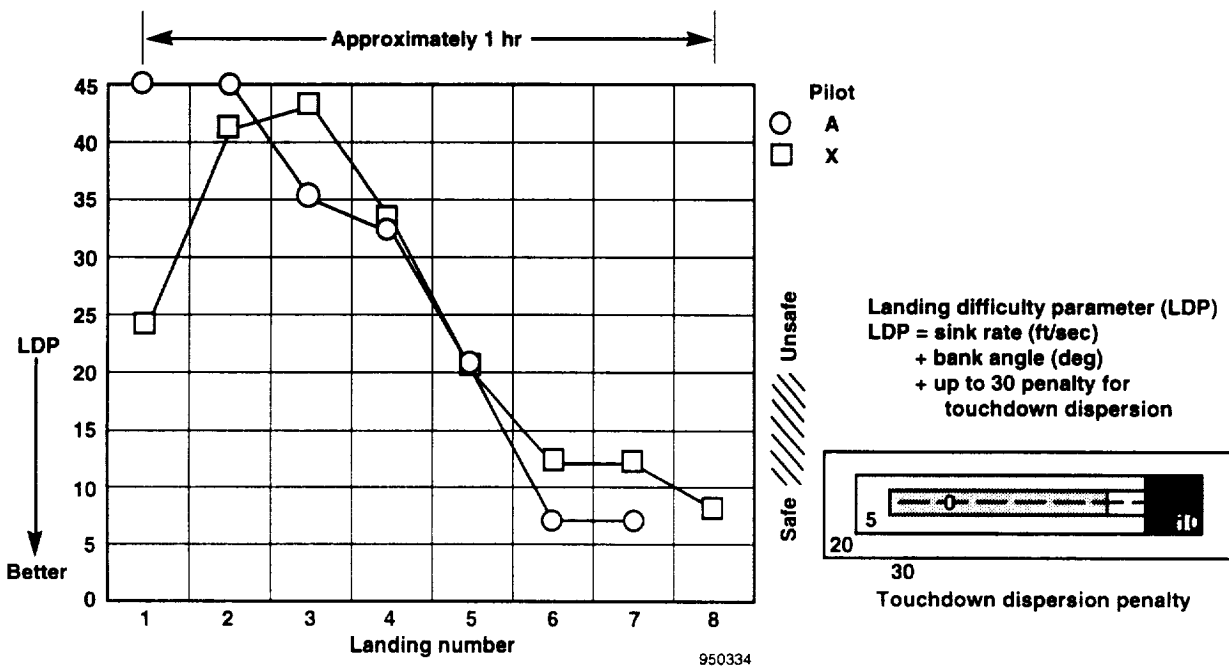

(b) Landing difficulty parameter for the first eight landings.

Figure 20. Concluded.

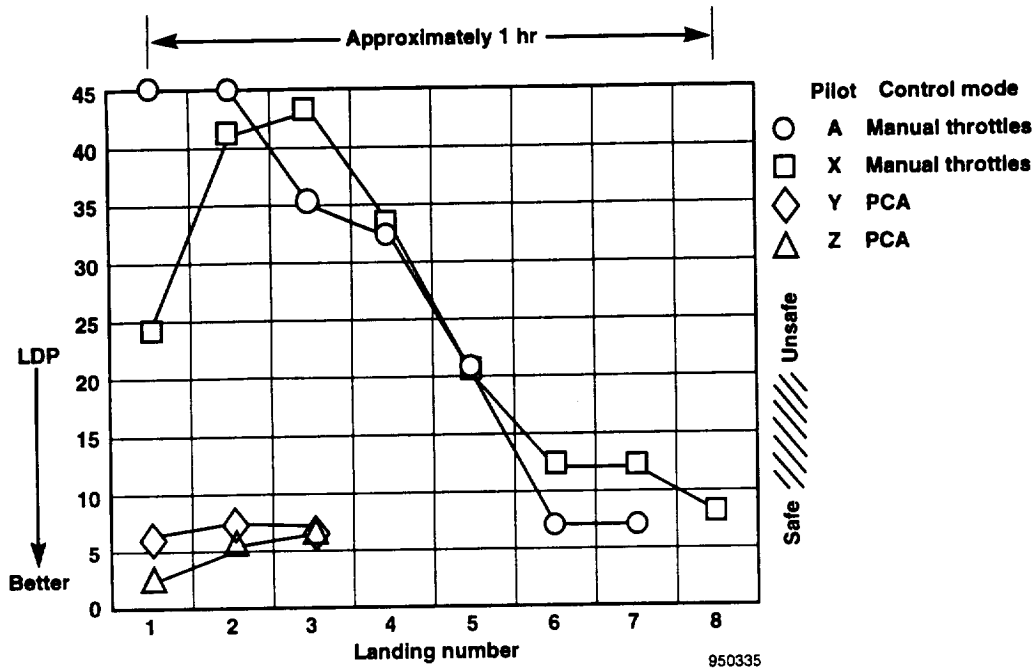

Figure 21. Early simulation PCA landings, new pilots with no previous PCA experience, flight controls locked, KCAS = 170 knots, gear down, flaps up.

make safe landings every time in the NASA Dryden simulator. Tests in the MDA simulator showed similar results. The PCA system approaches were easy to perform, even on the first try. The thumbwheels provided a significantly better method than a stick for pilot commands. The slow response of the PCA system was more consistent with thumbwheels than with a stick. With a thumbwheel, pilot workload is greatly reduced because flightpath and roll commands can be left in as long as desired. Results of the preliminary throttles-only research have been given.¹¹

Based on these simulation results, additional flight tests were flown. The simulation had indicated increasing control power as speed decreased, as predicted in the Principles section. In late 1990, the flight test speed was reduced to 170 knots and step-input throttle tests were made. Pitch control was greatly improved at this speed. Based on the success of these tests, plans were made to develop and flight test a PCA system on the NASA F-15 airplane.

In 1991, MDA was contracted to develop the PCA-system flight software and began in-house control law analysis, development, and simulation implementation. Design tradeoffs included PCA-system cockpit controllers (thumbwheels and joysticks), feedback motion sensors, fuel transfer for speed control, and control law

integrators. The design and testing of the PCA system software have been described.⁹ Plans were also made for dedicated throttles-only control flights on the NASA F-15 airplane to commence in early 1991.

The NASA F-15 airplane became available for dedicated flights in early 1991. Two flights were flown for validation of simulator results. Only one instrumented PW1128 engine was available. This engine had higher thrust and a slightly different response than the other (standard F100-PW-100) engine. Throttles-only manual control was much more difficult than in the simulators. In addition, throttle control was less effective, particularly in pitch, even when the different characteristics of the engines were modeled. Attaining level flight was very difficult, and constant bank-angle upsets occurred. This mismatch between flight and simulation led to an interactive series of flights and simulation upgrades.

The F-15 simulation obviously needed major improvements. In an attempt to improve the flight-to-simulation match, simulation upgrade S6 incorporated the effects of horizontal and vertical CG as a function of fuel quantity (fig. 14(b)).

By mid-1991, two essentially identical PW1128 engines were installed in the NASA F-15 airplane. In flight tests with the CAS off, small but significant flight

control surface motions still occurred because of the ratio changers in the mechanical flight control system. As a result, the PARRE mode with fixed ratios in the mechanical system was selected for additional flights. Full aft trim in this mode yielded a speed of 190 knots. With the inlets moved to the emergency position, the trim speed could be as low as 170 knots. As expected, in the CAS-off PARRE mode, the F-15 airplane had poor stability, light damping, and sluggish response with high stick forces. The airplane was difficult to trim and would roll off to the left or right within a few seconds of releasing the stick. Although greatly degraded from the normally excellent F-15 airplane flying qualities, the airplane was still safe to maneuver and land in this mode.

The CAS-off PARRE mode was added in upgrade S7, so the simulation could be flown with the stick rather than with the surfaces locked, as was the case in the F-15 airplane. In this mode, if the stick was not moved, no control surface motion existed.

Initial attempts at approaches in the NASA F-15 airplane were surprisingly unsuccessful, even after much practice. Figure 22 shows a comparison of flight and simulation approaches at the same conditions; the poor performance in the airplane is clearly evident. The basic airplane stability in the CAS-off PARRE and inlets emergency mode was lower than in the simulation. Even with matched engines, rolling moments induced by collective throttle inputs existed.

Throttles-only and PCA system tests in the MDA simulation, which incorporated a ground effect model, showed that PCA system landings were easy. However, the ground effect provided high sink rates at touchdown that were close to the maximum capability of the F-15 airplane. Based on these results, simulation upgrades S8 and S9 were made at NASA Dryden. Upgrade S8 added a ground effect model to the NASA Dryden simulation to improve the assessment of touchdown sink rates. Upgrade S9 added a model of the landing gear dynamics to see if bounce problems might be incurred. In addition, plans to study the ground effect on future flights were made.

Initial simulations with a linear engine model did a poor job of predicting the throttles-only control characteristics of the F-15 airplane. The thrust as a function of the throttle is particularly nonlinear with the landing gear down (fig. 12(b)). The nozzle opens to reduce thrust at less than a 50° PLA. The dynamic response is also critical for PCA system operation.

Therefore, in upgrade S10, a nonlinear digital model of the F100 EMD engine developed by MDA was implemented into the MDA and NASA Dryden simulations. The engine-model dynamics were developed using rate limits and first-order lags to approximate the response of the engine as determined from the Pratt & Whitney nonlinear aero-thermodynamic computer simulation.⁹ Gyroscopic moments from the engine rotors were added in upgrade S11. This change had very little effect on PCA system characteristics.

With these additions, the simulations were difficult to land, but these landings were still much easier than those in the actual airplane. Some unmodeled effect still was obviously present. In an attempt to improve the flight-to-simulation analysis capability, the NASA Dryden simulation (batch version) was modified in upgrade S12 to accept airplane throttle inputs from flight tests, so increasingly precise flight and simulation comparisons could be made.

Throttle Step Flight Tests

Small, throttle step inputs suitable for linear modeling were needed for the flight-to-simulation comparison. These step inputs were flown in September 1991. The configuration was CAS-off PARRE, inlets emergency, and landing gear down, so the idle-area reset feature and its effect on thrust and response would be present. The majority of these tests were flown at 170 knots. These results were compared to the simulations.

Differential Throttle Step Tests

Figure 23 shows a typical differential throttle roll test case where the pilot initially split the throttles approximately 2 in. from the trim setting and held that position for 3 sec. Then, the pilot split the throttles 2 in. in the opposite direction. The yaw rate match is very good. The resulting roll rate oscillations were comparable in frequency and damping in the flight and simulator responses. The roll rates were somewhat higher in the simulation than in the flight data.

Small Throttle Increase

Results of tests in which the throttles were increased approximately 10° from the PLF showed the expected pitchup (fig. 24). The result was less than the simulation had predicted. The measured angle of attack varied

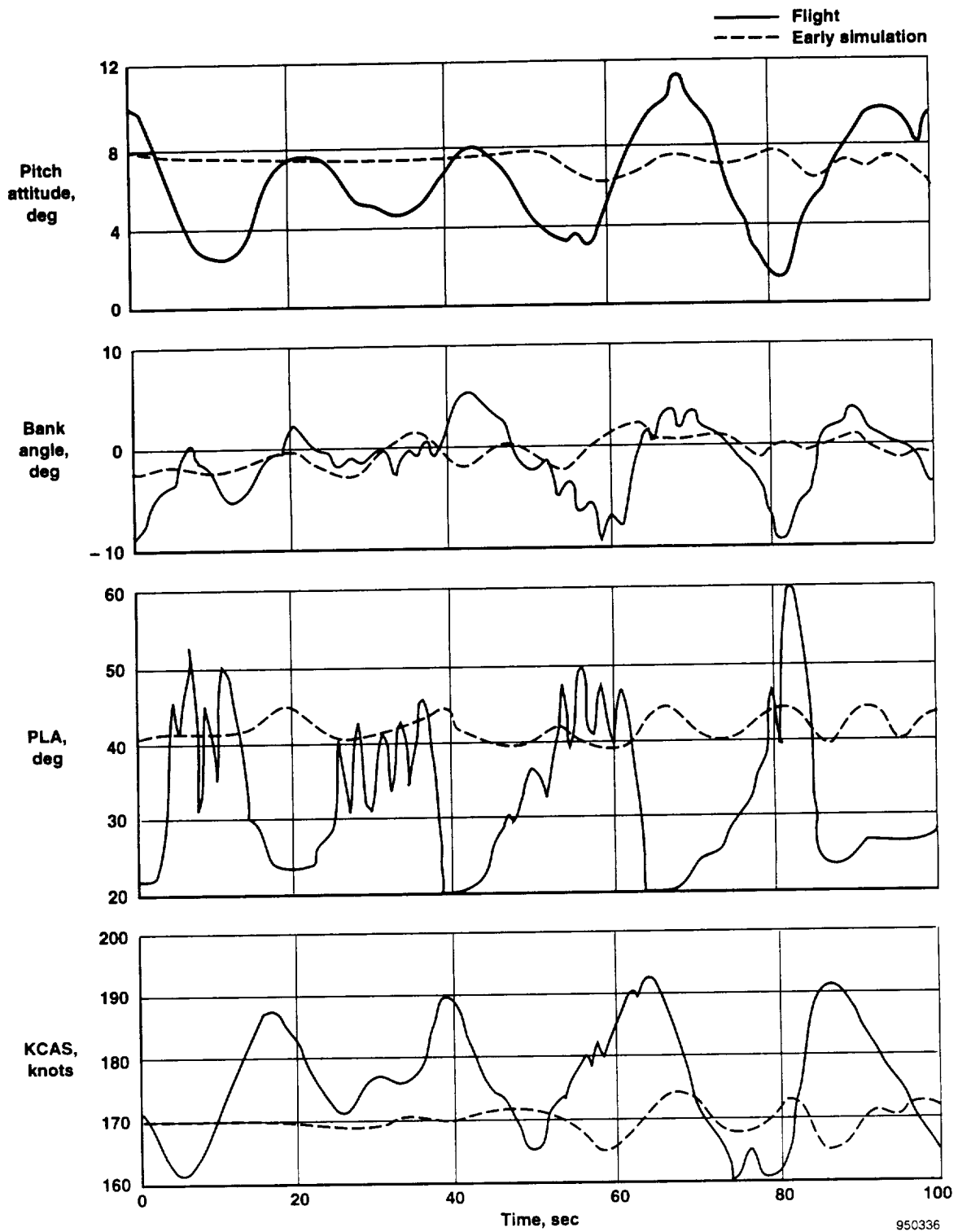
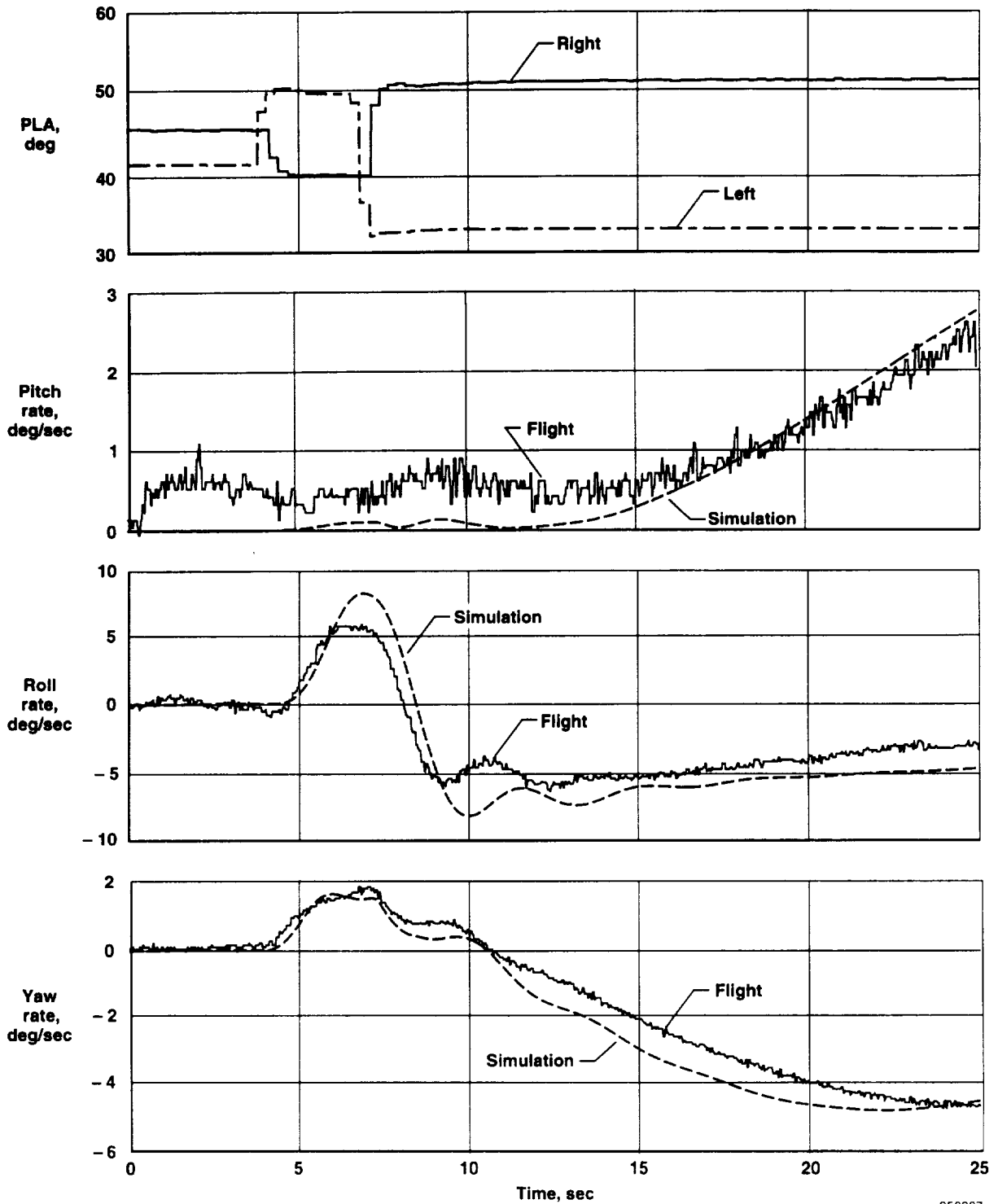

Figure 22. Manual throttles-only approaches, flight and early simulation, CAS-off PARRE, KCAS = 170 knots, flaps up.



950337

Figure 23. Comparison of flight and early simulation response for a differential throttle input, CAS-off PARRE, gear down, flaps up.

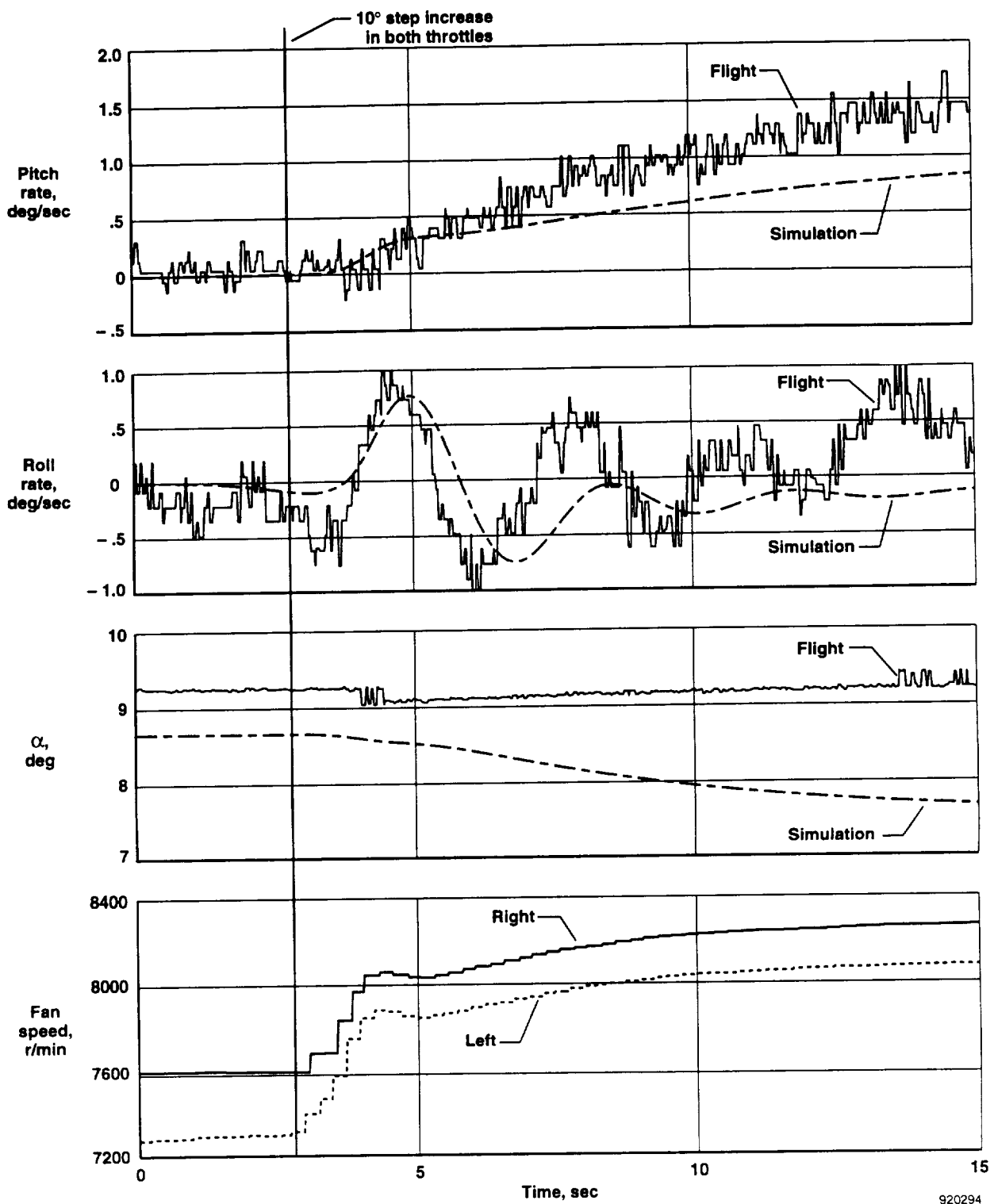

Figure 24. Comparison of flight and simulation data for a 10° step increase in throttle setting, KCAS = 170 knots, flaps up. (Simulation without airflow effects modeled.)

slightly and did not display the reduction seen in the simulation. The small roll oscillation in the simulation closely matched that seen in flight.*

Small Throttle Reduction

Figure 25 shows results for a typical *PLA* step reduction. The pitch rate comparisons of flight and simulation data are shown where both throttles were reduced from the *PLF* to idle at 170 knots. While the long-term response of the flight data was the expected pitchdown, a significant initial pitchup existed. A significant increase in angle of attack also occurred. Similar data at other flight conditions also showed the same initial pitchup and angle-of-attack increase. These results called attention to what was a serious discrepancy between the simulation and flight. Although thrust falls off rapidly because of the nozzle opening, fan speed decays slowly. It takes approximately 9 sec to stabilize, because of the slow response of the engine control logic. Fan speed, which is proportional to engine and inlet airflow, and angle of attack show a nearly direct inverse relationship.

Effects of Inlet Airflow

Because the fan speed is proportional to engine airflow and hence inlet airflow, possible airflow effects of the inlet on airplane pitching moment were investigated. Wind-tunnel test data were found that documented these effects. Wind-tunnel tests had been conducted on the effects of inlet airflow on F-15 inlet and overall airplane drag, lift, and pitching moment.⁸ These data show that reducing the inlet airflow increases the inlet lift and drag and the overall airplane lift, drag, and pitching moment. This increase would be expected with the forward-fuselage overhanging ramp configuration of the F-15 inlet.

Figure 26 shows the wind-tunnel pitching moment coefficient data at Mach 0.6 and an 8° angle of attack with the inlet in the emergency position. With an extrapolation to high capture-area ratios iteratively varied to match flight data, and when adjusted to the correct inlet capture-area ratio for the flight data at Mach 0.27, the simulation appeared to agree with the trend of the flight data.⁷

*The presence of a roll response from what was supposed to be a small pitch input is indicative of a problem that contributes to difficulty in flying throttles-only manual control. That is, the pilots cannot make perfectly equal throttle inputs. If the pilot could make such inputs, the engine thrust changes would not be equal.

With this airflow effect modeled, substantially improving the simulator's ability to match the flight data was possible. Figure 27 shows the results of this airflow effect using the same flight data shown in figure 25. The initial changes in pitch rate and angle of attack were properly modeled. With this match, the NASA Dryden real-time simulation was modified by upgrade S13 to incorporate the inlet pitching moment as a function of inlet capture-area ratio using data at an 8° angle of attack.

With this effect added, the simulation showed many of the characteristics of the flight data: poor phugoid damping, pitch pilot-induced oscillation tendency, sluggish response to pitch inputs, and initial response in the opposite direction to that desired. The simulation match to the flight data was markedly improved, but the simulation was still easier to fly than the airplane.

The inlet-airflow effect was slight and would often be neglected in an airplane simulation. However, when the small moments from the propulsion system are the only moments used for control, normally neglected effects may become significant. This increase in significance is particularly true for airplanes with highly integrated propulsion systems, such as fighters where inlet and airframe interactions are strong. The effects would not be significant for subsonic airplanes with podded engines where the inlets tend to be simple pitot inlets normal to the flow.

The inlet-airflow effects that are important in pitch have only a minor effect on the yawing and rolling moments caused by differential throttle, but they are in a direction to slightly reduce rolling effects of differential throttle. This observation is consistent with the data in figure 23.

Additional improvements were made to the NASA Dryden simulation. In upgrade S14, the MDA PCA control laws, including the trim function and the three trim options, were added. In upgrade S15, a small, square box representing the thumbwheel flightpath command was added (fig. 17). In upgrade S16, the improved weight, CG, and inertia data were added to the simulation (fig. 14(a) and 14(b)).

Inlet Effect on Simulation Propulsion-Controlled Aircraft System Control

As expected, the inlet effect change had an adverse effect on PCA system control as well as the already observed adverse effect on throttles-only manual

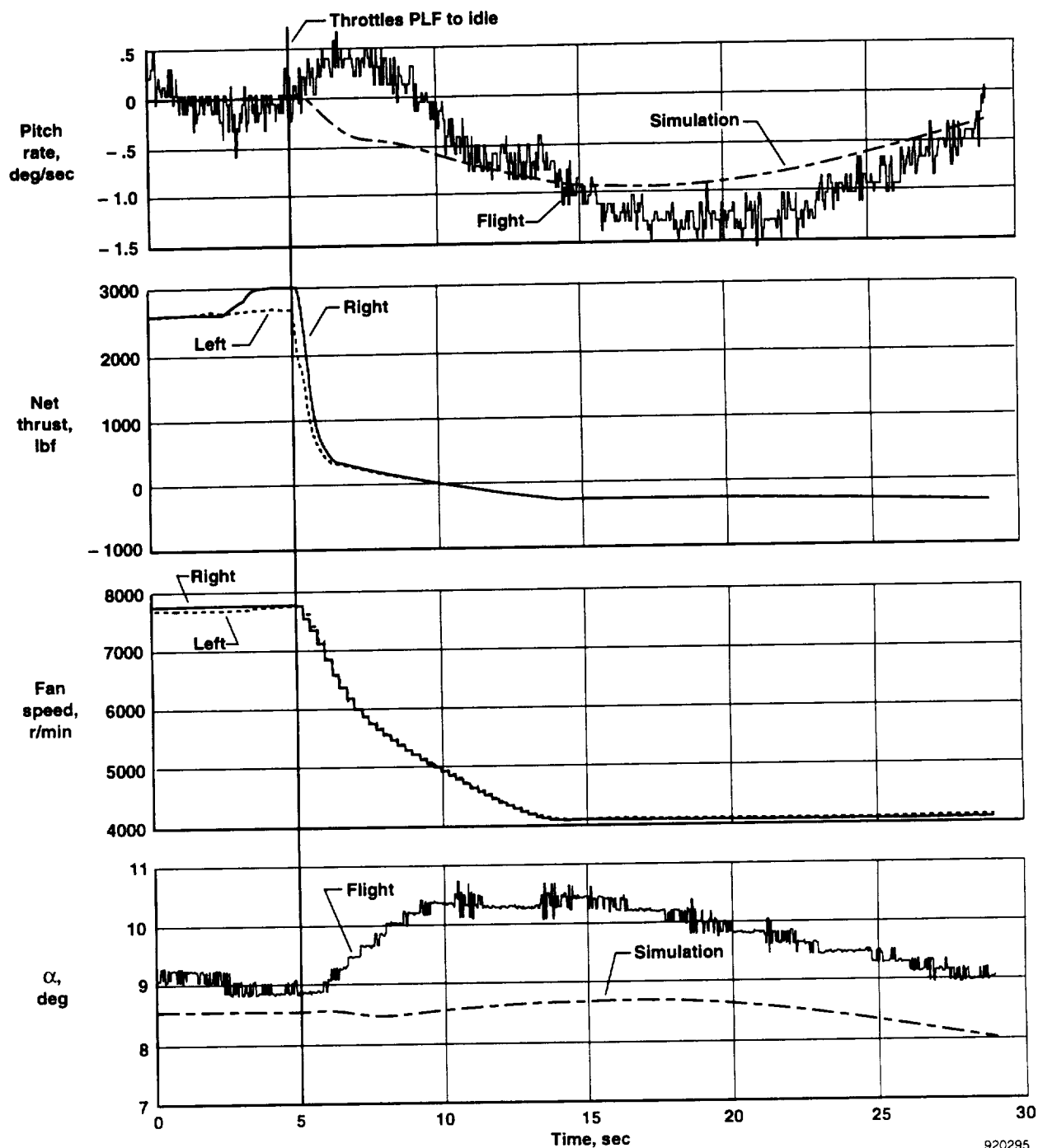

920295

Figure 25. Comparison of flight and simulation data for a step decrease in throttle setting to idle, KCAS = 170 knots, flaps up. (Simulation without airflow effects modeled.)

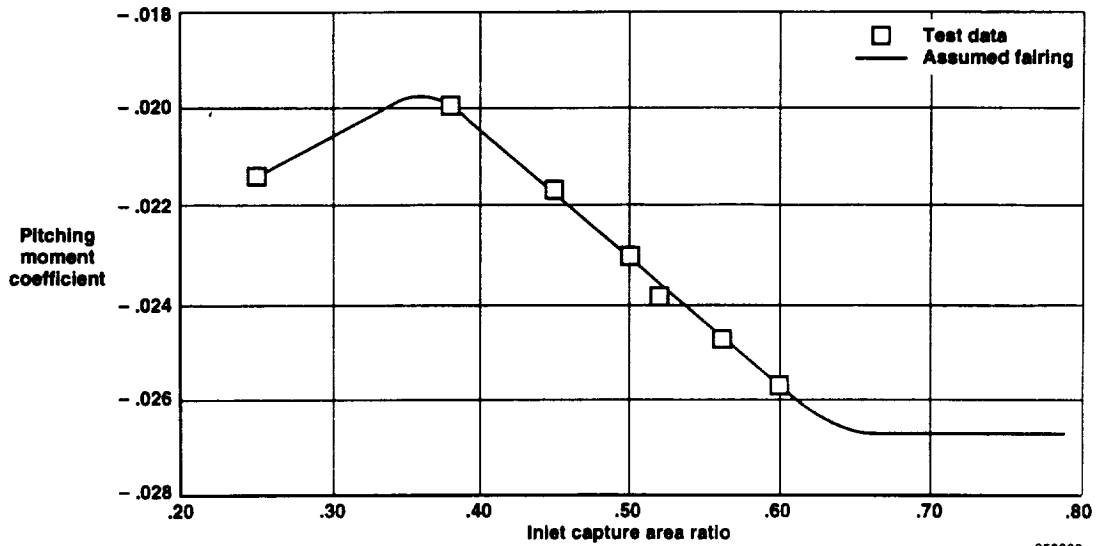

950338

Figure 26. Pitching moment variation caused by inlet capture-area ratio, F-15 airplane 7.5 percent wind-tunnel test results: $\alpha = 8^\circ$, Mach 0.6, $\rho = -4^\circ$ (emergency position).⁸

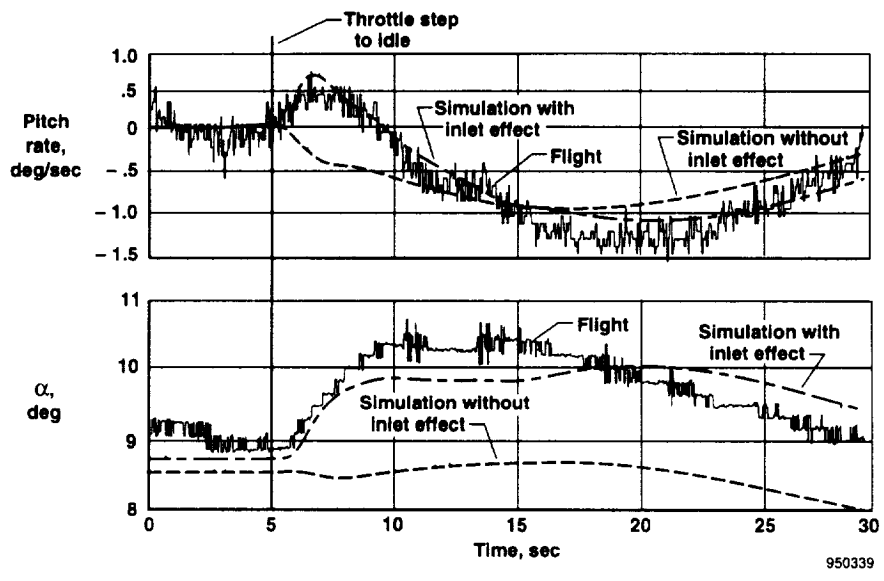

950339

Figure 27. Comparison of flight and simulation for throttle step to idle, with and without inlet-airflow effect, KCAS = 170 knots, flaps up.

control. In the MDA and NASA Dryden simulators, at 170 knots, the PCA system control became very sluggish in pitch. Much anticipation was required to compensate for the initial response that was in the opposite direction to that desired.

McDonnell Douglas Aerospace did an extensive analysis and found that velocity feedback was helpful in improving PCA system control at 170 knots. In upgrade

S17, this feedback option was added to the MDA and the NASA Dryden simulations. The simulation tests showed some improvement with the velocity control active, but performance was still less than desired.

In 1992, the flight software was tested with the pilot in the loop in the MDA simulation. Most of the effort in the simulation tests focused on the flightpath control problem caused by the inlet effect. Gain variations were

evaluated, and the velocity feedback mode was tested. In the MDA simulation, roll performance was adequate.

Finally, the flight software was evaluated in the MDA flight-hardware-in-the-loop simulation. Flightpath control was acceptable. In the roll axis, lowering the roll gain by a factor of 2 was necessary to eliminate a limit-cycle oscillation in bank angle. At this point, the flight software was qualified and ready for flight test.

Inlet Effect at 150 Knots

In May 1992, an additional flight was flown to look at the inlet effect at speeds other than 170 knots. Because speeds less than 170 knots would generally require deployment of flaps to permit trimmed flight in the CAS-off PARRE mode, flaps-down tests were also flown. At 190 knots, the inlet effect was stronger than at

170 knots. At 160 knots, with the flaps down, the inlet effect was less than at 170 knots.

It was hoped that the lower speed, which would increase the inlet capture-area ratio, would permit operation on the flat part of the curve (fig. 26), thus reducing the destabilizing effect of the inlet effect. In June 1992, a flight was flown with tests at 150 knots with flaps down. Many small, throttle step-input tests were made. Figure 28 shows a comparison of a throttle step input from *PLF* to idle at 150 knots and with the previous data at 170 knots. The initial response at 150 knots is an immediate flightpath decrease, as desired, and the angle-of-attack increase is small, indicating minimal inlet effect and improved pitch control capability. Although still quite difficult, throttles-only manual control in the airplane improved at 150 knots.

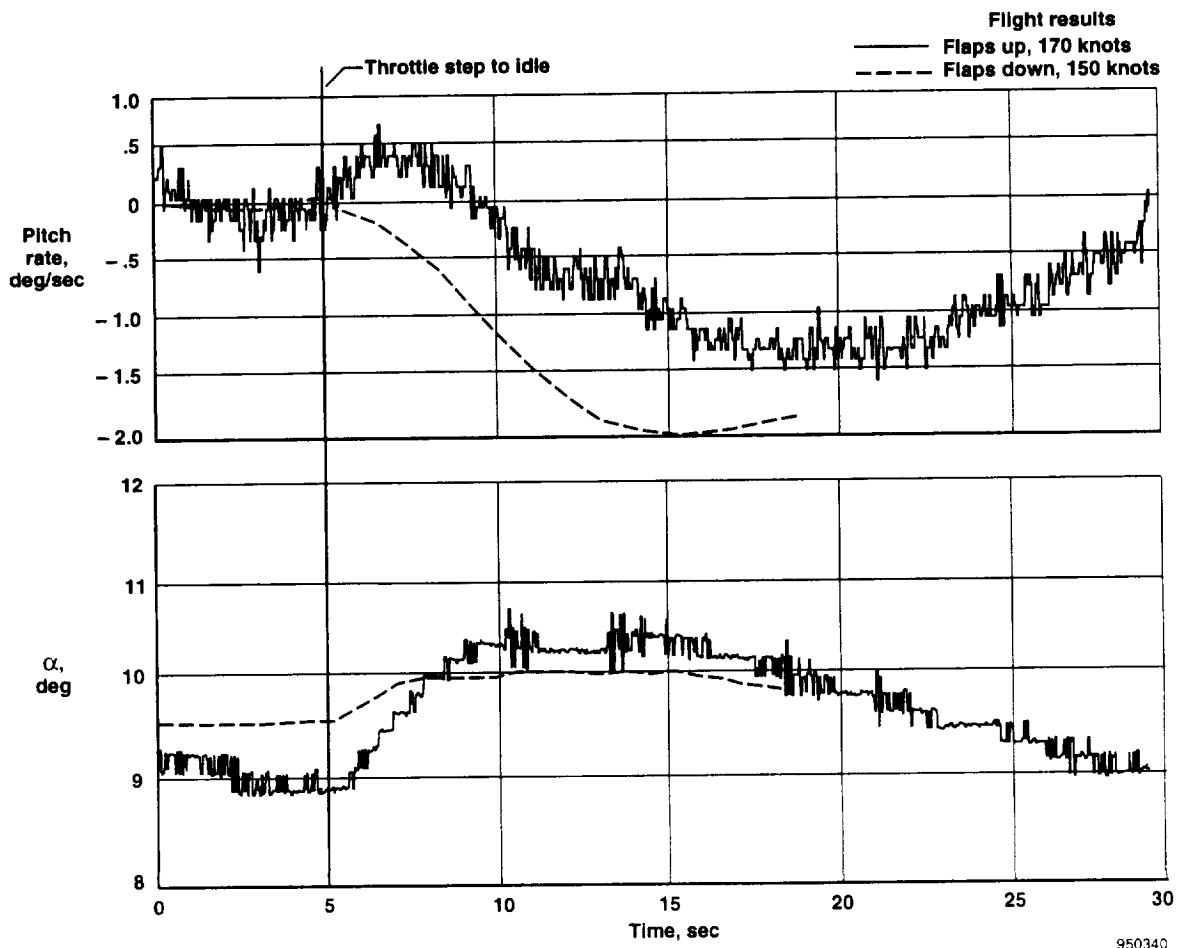

Figure 28. Flight comparison of step throttle reduction from *PLF* to idle at 170 and 150 knots.

The PCA project pilot flew throttles-only manual-control approaches with the flaps down at 150 knots. The pilot reported improved pitch control and actually achieved short periods of stable control on approaches. However, the workload was so high that even a radio call was a major distraction. Adequate control could not be maintained all the way to landing, and these approaches were terminated at 200 ft AGL with little hope that a safe, throttles-only manual landing could be made. This experience also cast doubt on the potential for the PCA system to provide adequate control for landing.

Inlet Effect Water-Tunnel Test

In an attempt to understand the inlet effect, a water-tunnel test was conducted. A 2 percent-scale F-15 airplane model was built with the gear down and the inlet in the emergency position. The left inlet flow was piped out of the water tunnel and could be regulated to simulate mass flow ratio variation. Dye injection ports were added at several locations, and the left outer inlet wall was made transparent. During the test, angle of attack and inlet capture-area ratio were varied. Video and still pictures were taken.

Figure 29(a) shows the F-15 model in the water tunnel. Figure 29(b) shows traces of inboard wall orifice flow streamlines at an 8° and a 10° angle of attack for capture-area ratios of 0.6 and 0.9. At an angle of attack of 10°, capture-area ratio variation caused negligible changes in the dye patterns. At an angle of attack of 8°, the capture-area ratio change modified the inlet flow streamlines, a trend consistent with the adverse inlet effect.

Propulsion-Controlled Aircraft System Control in Simulation at 150 Knots

With no adverse inlet effect present at 150 knots, the PCA control laws were tested in the NASA Dryden simulation. Performance was good, much improved from the 170-knot results. As weight decreased, the speed needed to be decreased to keep the angle of attack high enough to avoid the adverse inlet effect. Low weights also moved the CG aft and down. These adverse effects decreased PCA performance. Based on the simulation results, the PCA flight test plan was developed. Tests at 150 knots were considered primary.

Expectations existed that PCA performance would be degraded at light airplane weight.

Propulsion-Controlled Aircraft Flight Tests

The first PCA system flight was flown on January 22, 1993 (table 5), and was followed by seven additional flights in the next 2 weeks. The flight software incorporated the velocity feedback in the pitch control laws. The radar altimeter was installed, and an added objective of this test series was to acquire new ground effect data to improve the ground effect model. Results indicate that atmospheric turbulence levels could be inferred from the short term (approximately 1–2 sec) variation in the airspeed trace. A smooth trace indicated no turbulence. A variation of ± 0.5 knots indicated very light turbulence, ± 1 knots indicated light turbulence, and ± 2 knots indicated light-to-moderate turbulence.

The first flight checked out all of the PCA safety-disengage features. Then, the PCA system was engaged in level flight at an altitude of 10,000 ft and 150 knots in smooth air. The first engagement was successful; the trimming operation successfully trimmed the F-15 airplane to level flight. Initial tests evaluated the performance of the PCA trim modes and response to small bank and flightpath commands.

Propulsion-Controlled Aircraft Trim Tests

When the PCA system was first engaged, the pitch and roll thumbwheels were set in the detent position. Next, the trimming function with integrators in the flightpath and bank-angle loops slowly adjusted the thrust of the engines to achieve level flight. Figure 30 shows a typical trimming operation in smooth air. In this case, the pilot had the throttles set very close to the needed positions, and speed was approximately 2 knots faster than the trim speed. The trim logic adjusted both throttles to reduce the flightpath to 0°, and increased the right throttle slightly to lift the right wing. Trim requirements were satisfied with the flightpath within approximately 0.2° and the bank angle within 2° of the commands in approximately 18 sec. The pilot then began step inputs in flightpath and bank angle. The trim function performed just as it had in the simulation. In the typical PCA engagement, approximately 30 sec were required for trimming to be completed.

If the air was turbulent, the trim criteria might never be satisfied; if this occurred, the pilot would select

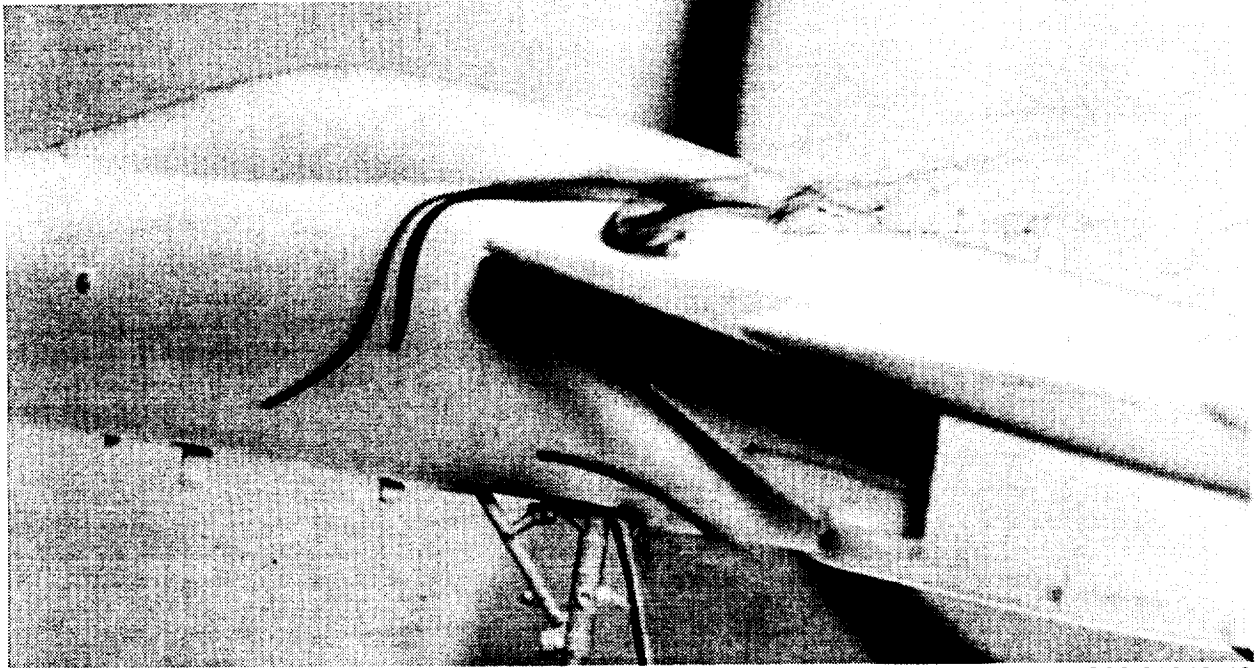

EC93 01042-40

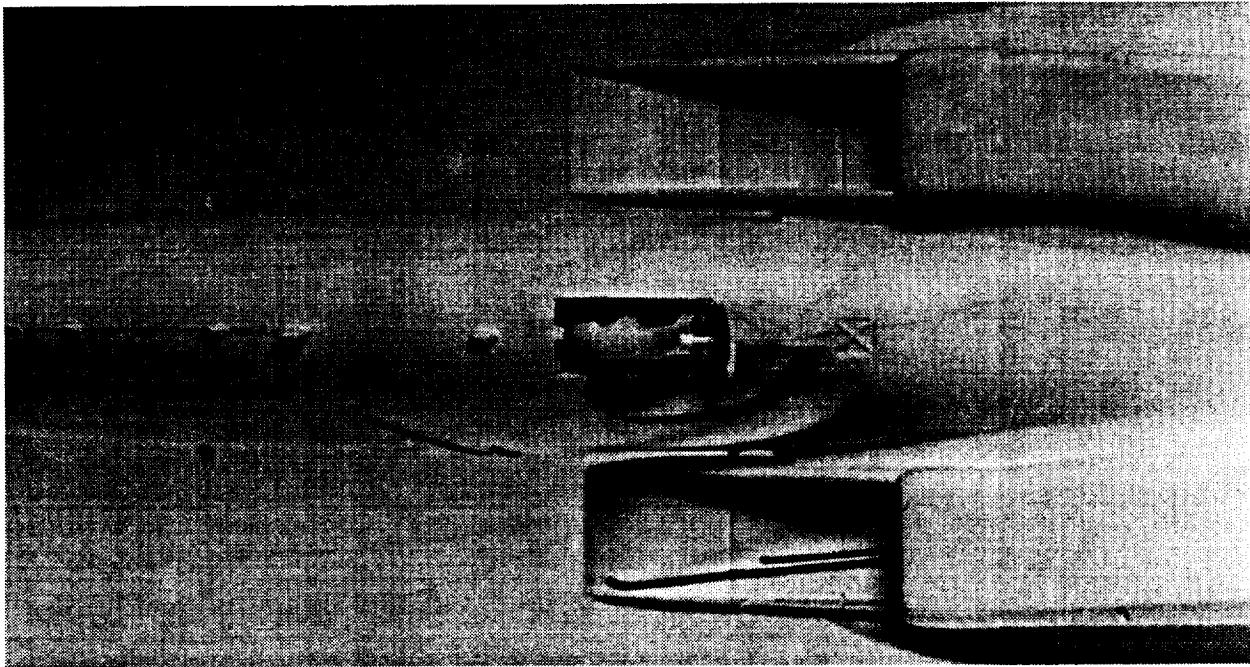

EC93 01042-18

(a) Model showing dye patterns, $A/A_c = 0.9$.

Figure 29. The F-15 airplane 1/48 scale model water tunnel test.

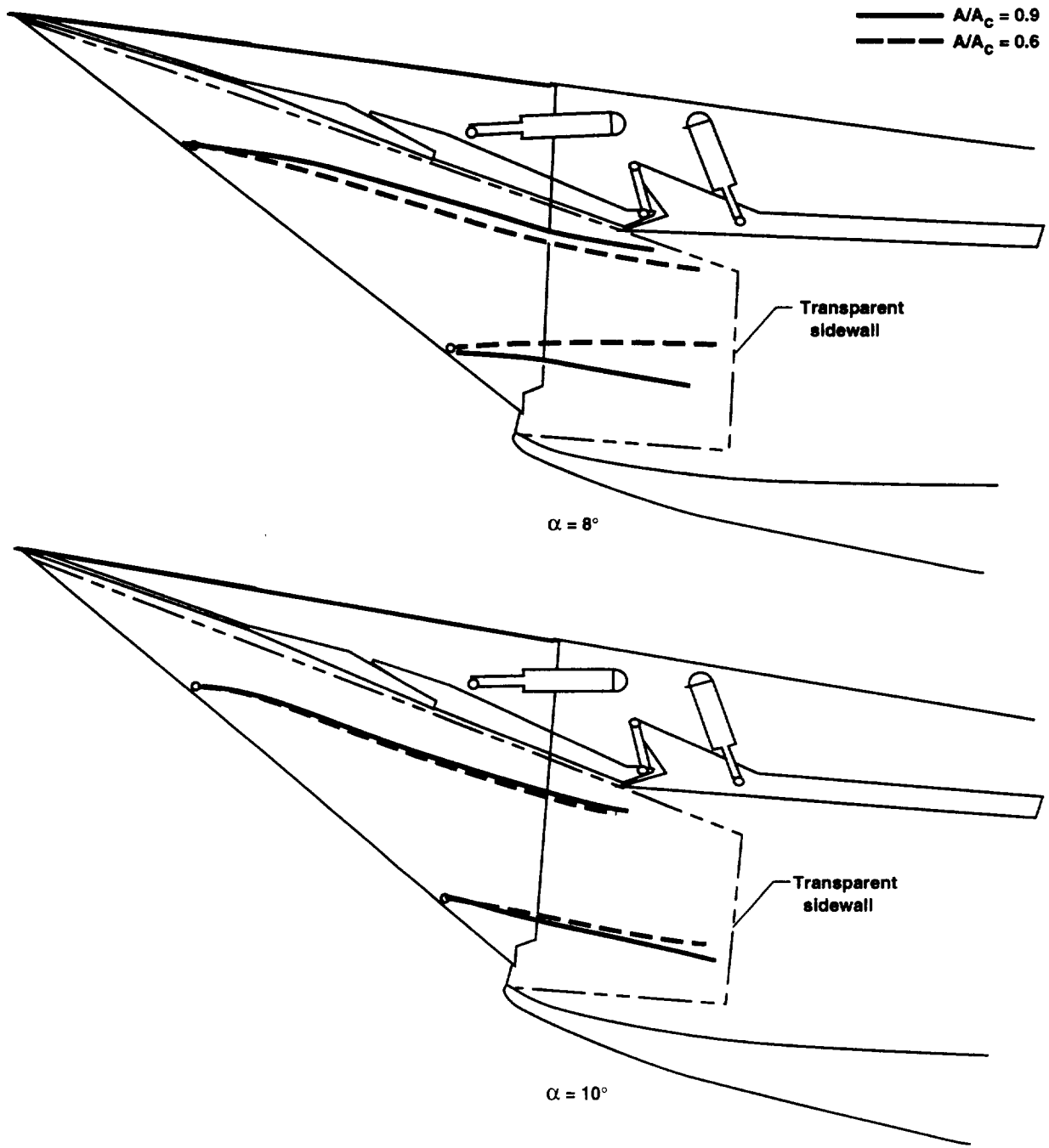

(b) Effect of inlet capture-area ratio and angle of attack on inlet streamlines.

Figure 29. Concluded.

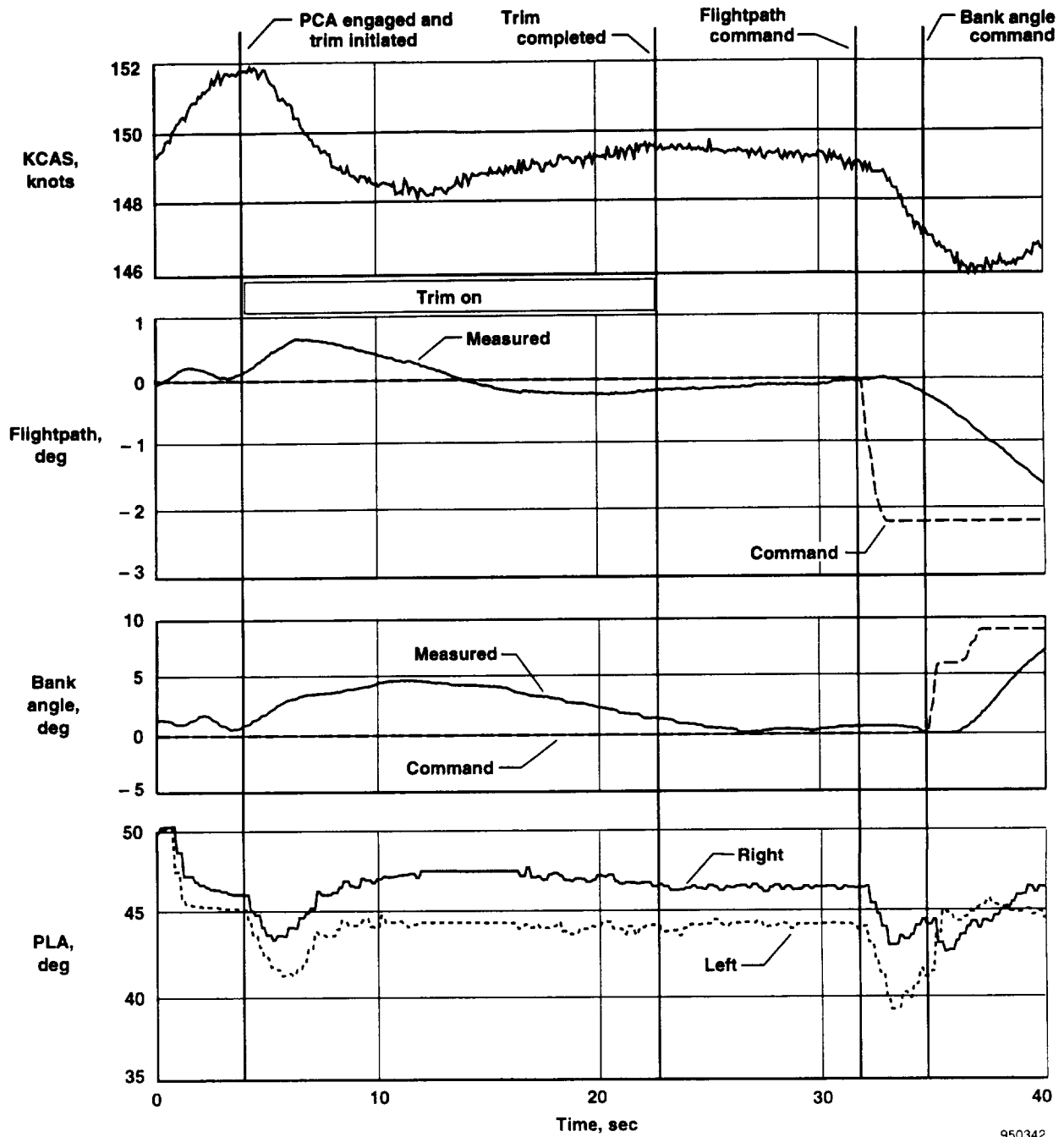

950342

Figure 30. Flight PCA trimming operation, 5000 ft, 150 knots, smooth air, flaps down.

“trim off” to improve the flightpath stability. After several minutes of PCA system operation, biases would sometimes develop that required the pilot to select other than the detent position on the thumbwheels to achieve level flight. When this occurred, the pilot could select “trim on” (or “trim off” and then “trim auto”) to initiate a new trim cycle to trim out the biases.

A few instances existed when the trim requirements were immediately met when the pilot released the controls and immediately engaged the PCA system. These instances occurred even though an adequate trim had not really been achieved because the rates had not had time to build to values in excess of the trim limits. In these cases, when unacceptable biases developed, the pilot would cycle trim to “off” and back to “auto.” Details of the trim logic and limits have been reported.⁹

Step Inputs

Numerous thumbwheel command step inputs were made to flightpath and bank-angle axes at varying weights, airspeeds, and gain combinations. These step inputs were designed to allow detailed postflight comparisons of actual flight performance with simulation predictions for the different flight control configurations tested.

Figure 31(a) shows a typical throttle step input sequence. The pilot matched the engines closely, trimmed the airplane, then engaged the PCA system in approximately level flight at 150 knots. The trimming process took approximately 25 sec. The pilot then decreased the flightpath command to -2.4° . The PCA system reduced both throttles almost to idle but then immediately returned the *PLA* to its original position as the flightpath angle-rate feedback became equal to the flightpath angle error. The bank-angle disturbance was very small because of the well-matched throttles. Approximately 10 sec were required to meet the flightpath angle command, and a small overshoot occurred. Airspeed had decreased approximately 6 knots, then increased to approximately 151 knots to hold the rate of descent.

Next, the pilot increased the flightpath angle to 0° . Compared to the previous step, the throttle increase was smaller because of the nonlinear thrust/*PLA* relationship, but the flightpath response was similar and slightly improved. Another step increase to 2.2° was followed by a step decrease to 0° . The air was very smooth, and the pitch and roll coupling was minimal. The project pilot commented that “the pitch response was as good as

you could ask for,” considering all control was being provided by engine thrust.

Figure 31(b) shows a response to a small, negative flightpath angle command at 150 knots with the flaps down. The initial throttle decrease is followed by throttle modulation to achieve the desired flightpath with minimum overshoot. The average fan speed, an indicator of net thrust, is also shown. Approximately 11 sec are required to achieve the 1.8° decrease in flightpath angle. A comparison of the nonlinear simulation, incorporating the inlet effect, at 150 knots with the flaps down shows a slightly slower response than was measured, but reasonably good agreement with the flight data.

Figure 32 shows roll response to a 20° roll step-input command at 150 knots. Roll control was initially quite poor because of slow bank-angle response (fig. 32(a)). To achieve the commanded bank angle, 28 sec were required. Only a very small differential throttle command was generated by the control laws. This low roll rate was dictated by results from the MDA hardware-in-the-loop simulation, in which high gains caused a limit-cycle oscillation in bank angle.

Extensive flight evaluations were conducted to improve roll performance. After several iterations, changes in gains and yaw rate filtering and the addition of bank-angle feedback greatly improved the roll response. In general, the noisy yaw-rate feedback was reduced and the bank-angle feedback increased.

Figure 32(b) shows the roll response after these changes. The commanded bank angle is reached within 6 sec. A significant degree of differential thrust was commanded in this test. No evidence of the limit-cycle oscillation was seen in the flight tests. Again, comparison to the nonlinear simulation prediction for this condition is reasonably good. The flexibility of the flight software was **absolutely critical** in making the major improvement in roll response in five flights.

After the improvement in roll response, the basic PCA system performed acceptably well at 150 knots. As expected, pitch response was sluggish but very stable, and roll had a 3-sec lag that was predictable. Considering the low stability of the F-15 airplane in the CAS-off PARRE mode, the PCA system performance in stabilizing and controlling the F-15 airplane was surprisingly good. In smooth air, flight path was controlled to $\pm 0.5^\circ$, and bank angle was controlled to $\pm 1^\circ$.

The PCA system performance at 170 knots was also evaluated briefly. Roll control was about equal to that at 150 knots, but flightpath control was badly degraded.

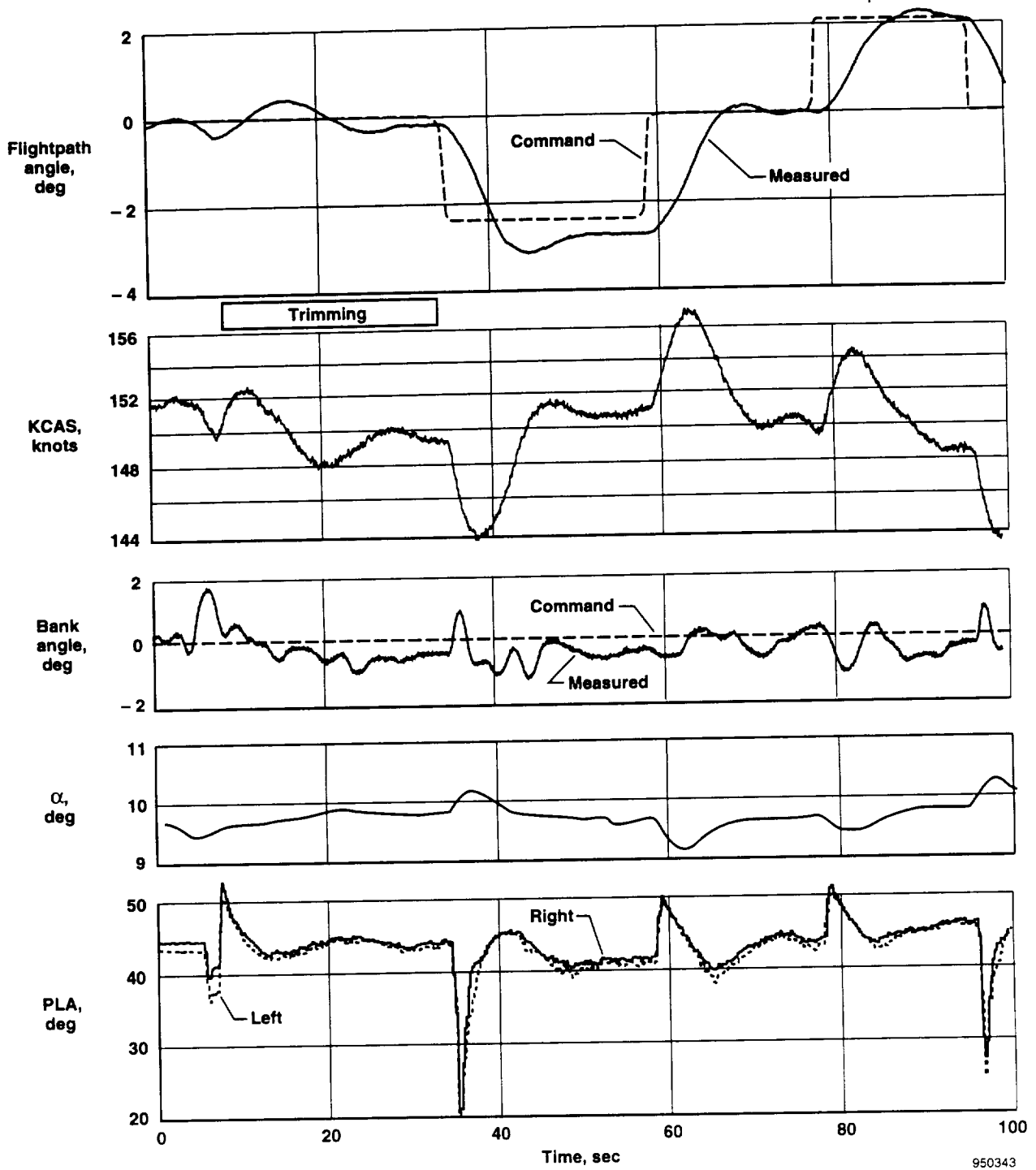

950343

(a) Flightpath angle steps.

Figure 31. PCA response to a flightpath step command response, gear and flaps down, 4000 ft.

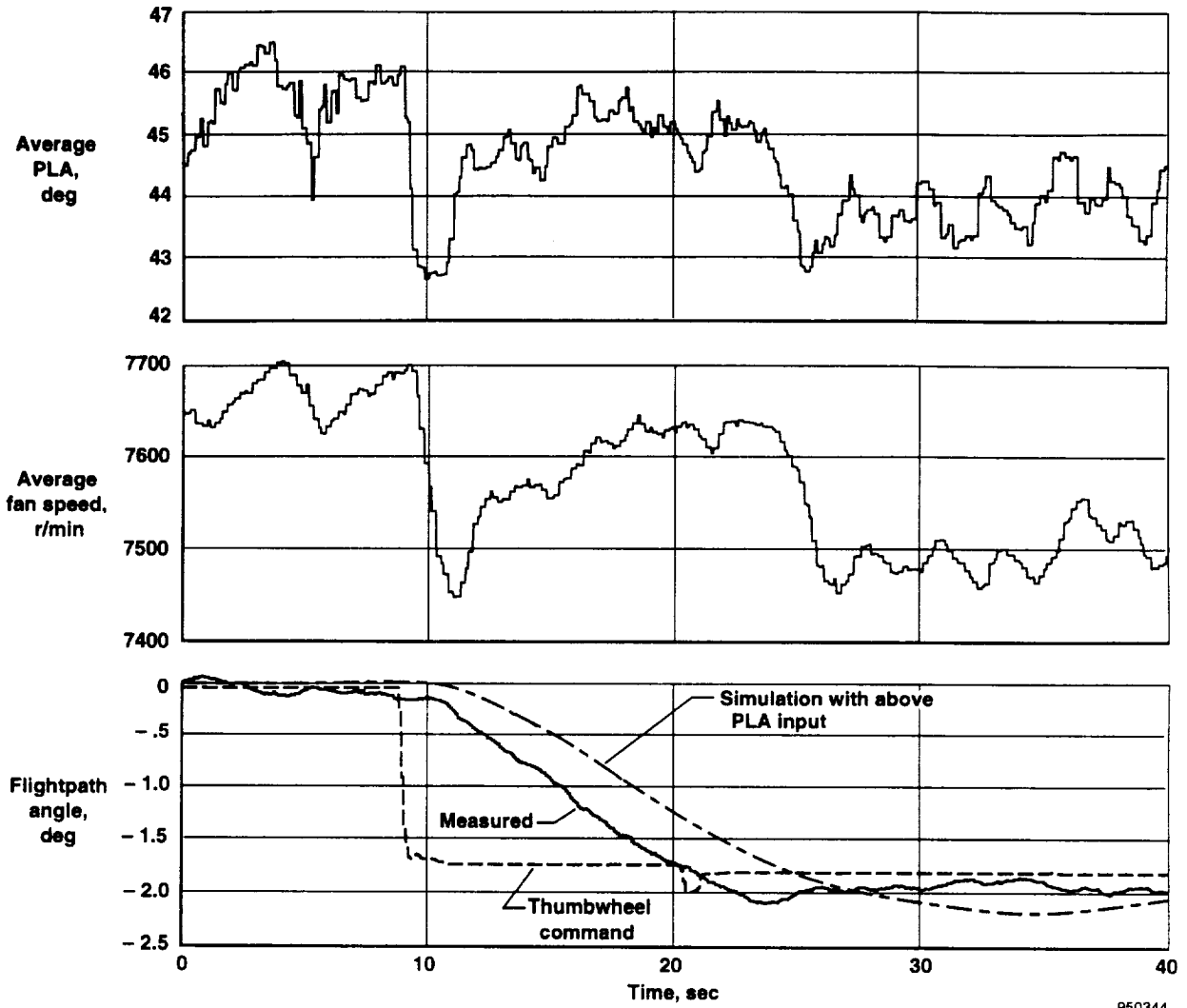

950344

(b) Flight and simulation response to a -1.8° flightpath step command.

Figure 31. Concluded.

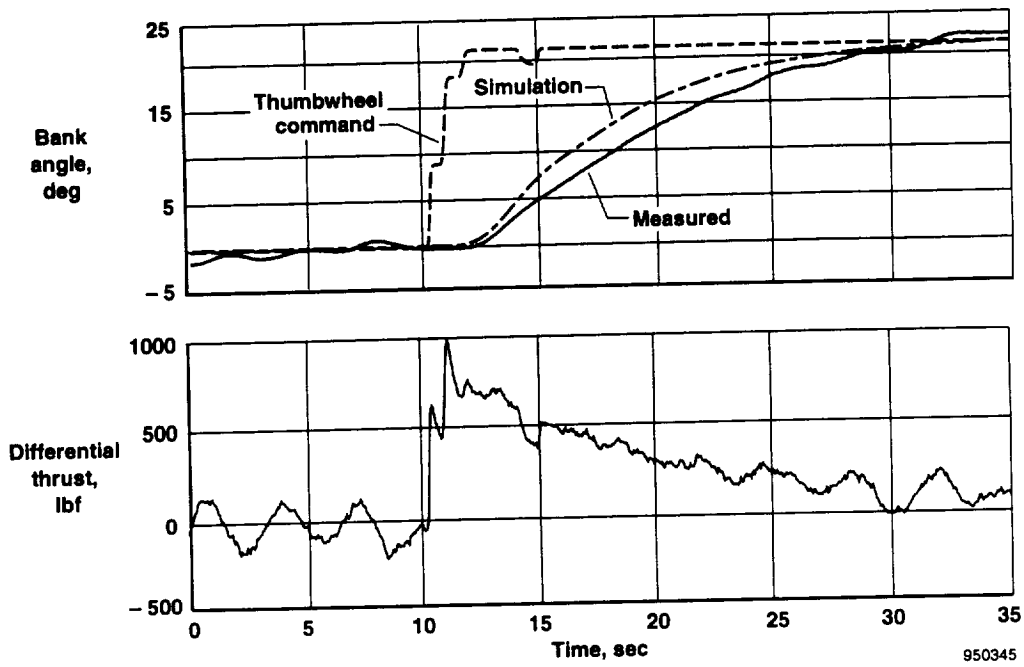

(a) Initial response.

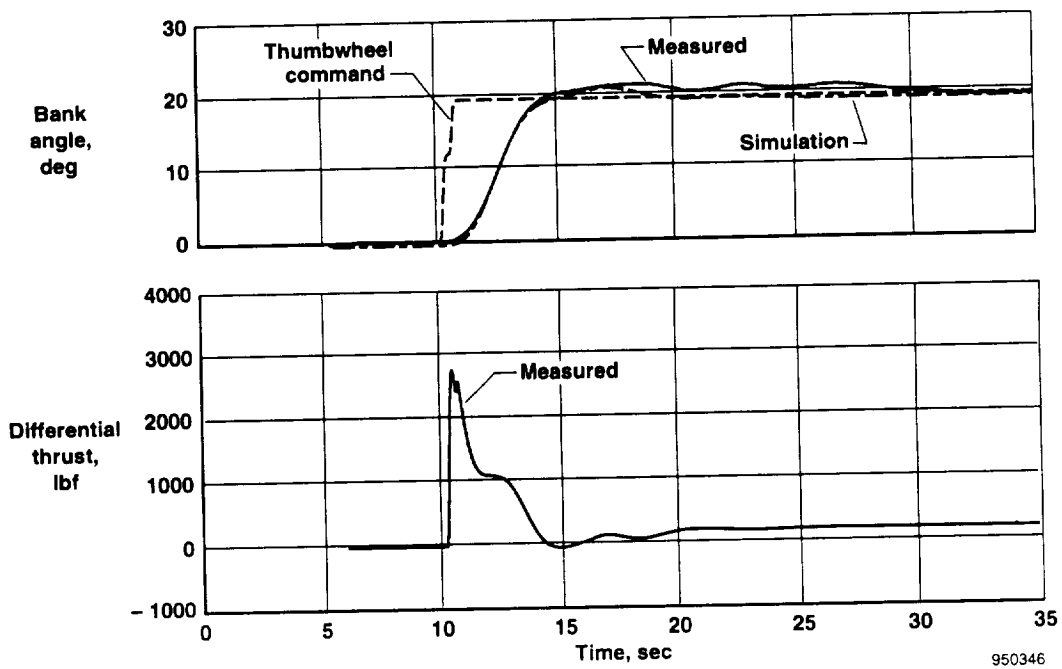

(b) Improved response.

Figure 32. PCA bank-angle response with initial and improved control logic, KCAS = 150 knots, flaps down.

For a 2° negative flightpath command, the flightpath initially increased slightly and did not start to drop for approximately 10 sec. After the flightpath dropped, it overshot to -4° . The poor performance, caused by the adverse inlet effect, was similar to that seen in the simulation. The velocity feedback improved stability, but response was very slow.

Propulsion-Controlled Aircraft System Approaches

The PCA system was typically engaged in level flight on the downwind or base leg of approaches to the Edwards runway. Turns were made, using PCA system control, to the base leg and to a long, straight-in final approach approximately 5 to 7 miles from the runway. In most cases, the pilot did not make a great effort to match the engines before trimming the airplane; this lack of match typically resulted in significant throttle differences during PCA system operation.

Runway Approaches with Go-Around—Figure 33 shows the command and actual flightpath (glide slope) and bank-angle values for a low approach and PCA system go-around at approximately 155 knots. Engine throttle settings, altitude *AGL*, and airspeed are also shown. For this approach, with light turbulence, good control is seen. Flightpath was maintained within approximately 1° of command until the go-around was initiated. The majority of the throttle motion was differential to maintain the commanded bank angle. Bank angle lagged pilot inputs by approximately 3 sec. At 100 ft *AGL*, as planned, the pilot initiated a go-around by moving the flightpath command from -1.4° to 3° . Altitude reached a minimum of 50 ft *AGL*, and bank angle was held within $\pm 2^\circ$. The pilot considered the system response to be good in pitch and adequate in roll.

Figure 34 shows another, more aggressive go-around. In this case, guest pilot G had leveled off at approximately 140 ft *AGL*, with a trim speed of 151 knots, and in light-to-moderate turbulence, at $t = 15$ sec, the pilot reduced the flightpath command to -3° . Speed decreased to 140 knots, and at 100 ft *AGL*, the pilot moved the flightpath command from -3° to 14° to initiate the go-around. Approximately 70 ft of altitude was lost, and 5 sec elapsed from the go-around command until the flightpath became positive, as the speed increased back to 151 knots. The PCA system command reached approximately full throttle and speed increased to 170 knots during the go-around.

Propulsion-Controlled Aircraft System Approach with Head-Up Display Off—The HUD shows the flightpath command and flightpath marker. Both are important information for flying with the PCA system. Determining how much of a problem it would be to use the PCA system with the HUD off was of interest. The PCA project pilot made one approach with the HUD off. The pilot found that, without the flightpath marker, too steep a glideslope was initially established and the airplane got too low. At approximately 1000 ft *AGL*, the pilot leveled off, reestablished the glidepath closer to the runway, and continued the approach to 200 ft *AGL*. Workload was considerably higher and approach precision was poorer than when the displays were on, but the PCA system approach was still possible.

Propulsion-Controlled Aircraft Approach at 170 Knots—Flightpath control was known to degrade at 170 knots because of the adverse inlet effect. One approach was flown down to 50 ft *AGL*. Roll performance was similar to that at 150 knots, but pitch performance was definitely worse than at 150 knots.

Propulsion-Controlled Aircraft Approach to 10 ft Above Ground Level—In another approach, pilot A flew with PCA system control to within 10 ft *AGL* of the runway in a test to evaluate the PCA system response close to the ground. Figure 35 shows a time history of this approach. Weather conditions included a 5-knot tailwind and very light turbulence. Occasional small upsets were caused by thermals. Figure 35(a) shows 83 sec of the approach. Flightpath command varied between -1° and -2° for the majority of the approach. Flightpath was maintained within 0.5° of the command except when mild atmospheric thermal activity caused a pitchup at 23 sec and again at 60 sec. Bank-angle commands were generally small, and bank angle was maintained, considering the 3-sec lag, within 3° . At 70 sec, the pilot increased the flightpath command to -0.5° to initiate a landing flare. In the final 6 sec of this approach, the pilot disengaged the PCA system 10 ft *AGL* and made a small aft stick input equal to 0.5° of stabilizer in the remaining 2 sec until touchdown (fig. 35(b)). Touchdown sink rate was 4 ft/sec. Even with the aft stick input, the angle of attack dropped because of ground effect. The pilot made an aft stick input at initial touchdown to cushion the landing. The PCA pitch control was rated as good.

At that time, the PCA system performance was deemed sufficiently good to consider flying with the PCA system all the way to touchdown. The only significant unresolved issue was the ground effect.

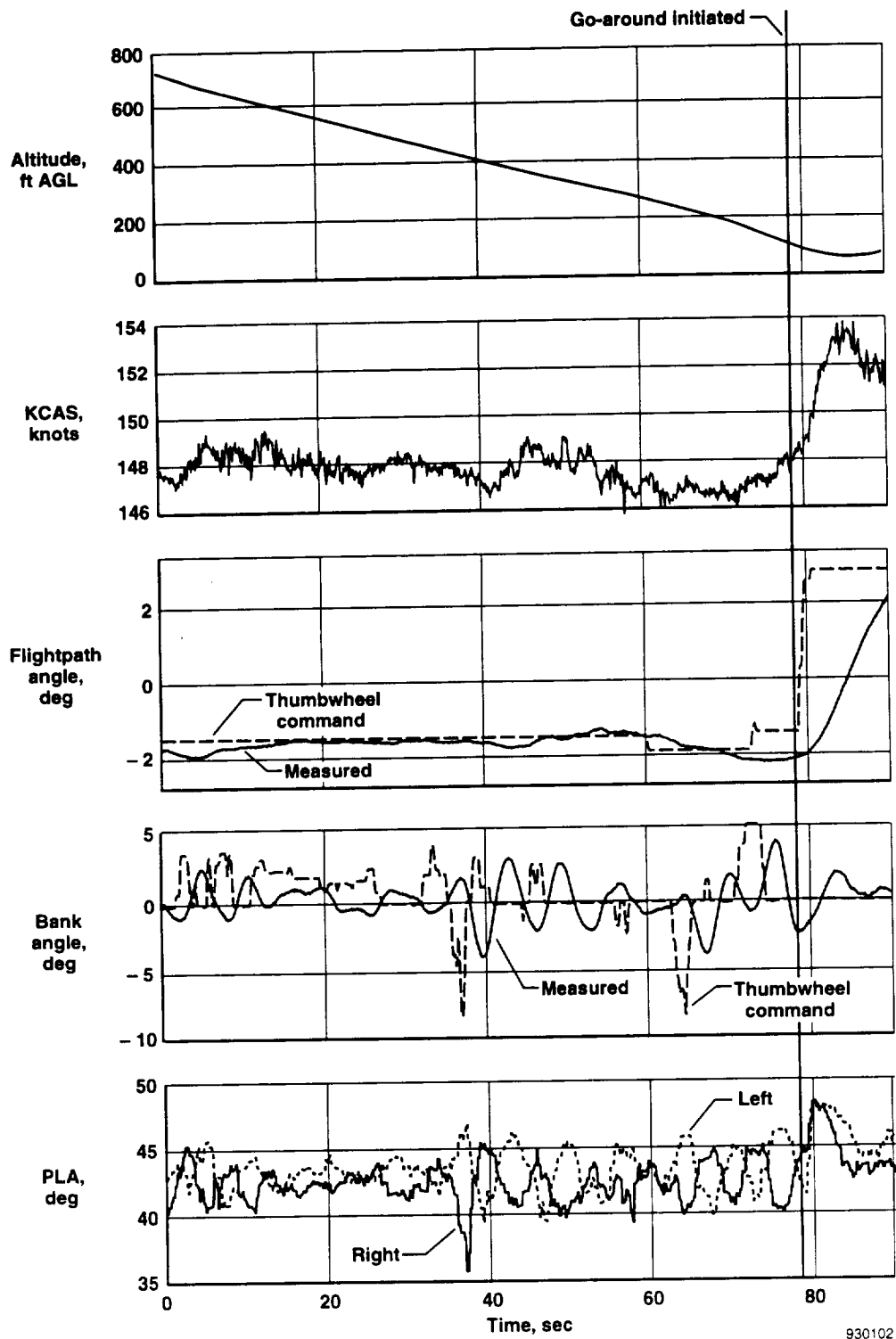

930102

Figure 33. Time history of a PCA approach and go-around, flaps down, pilot A.

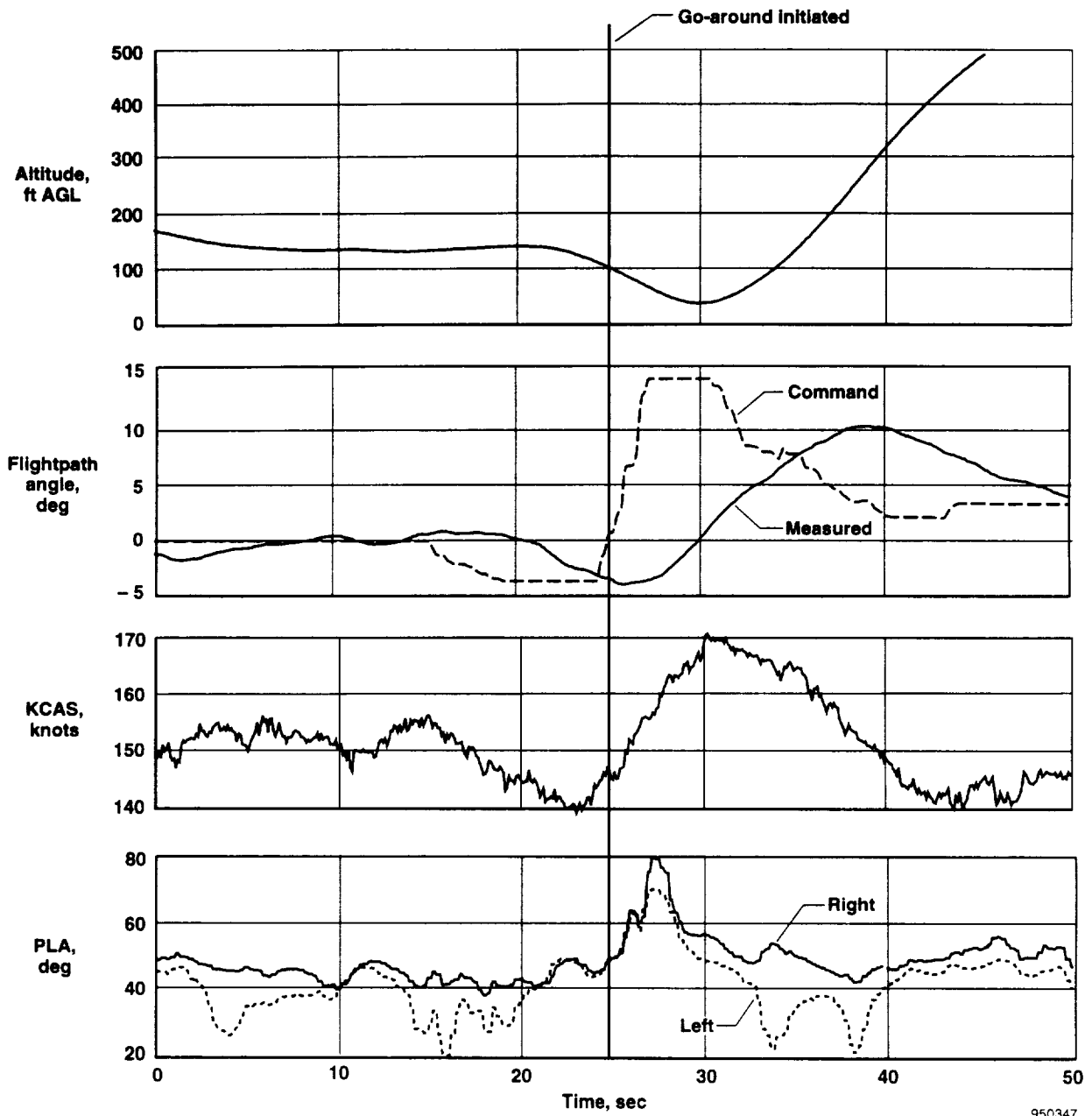

950347

Figure 34. The PCA approach and go-around, *KCAS* = 150 knots, flaps down, light turbulence, pilot G.

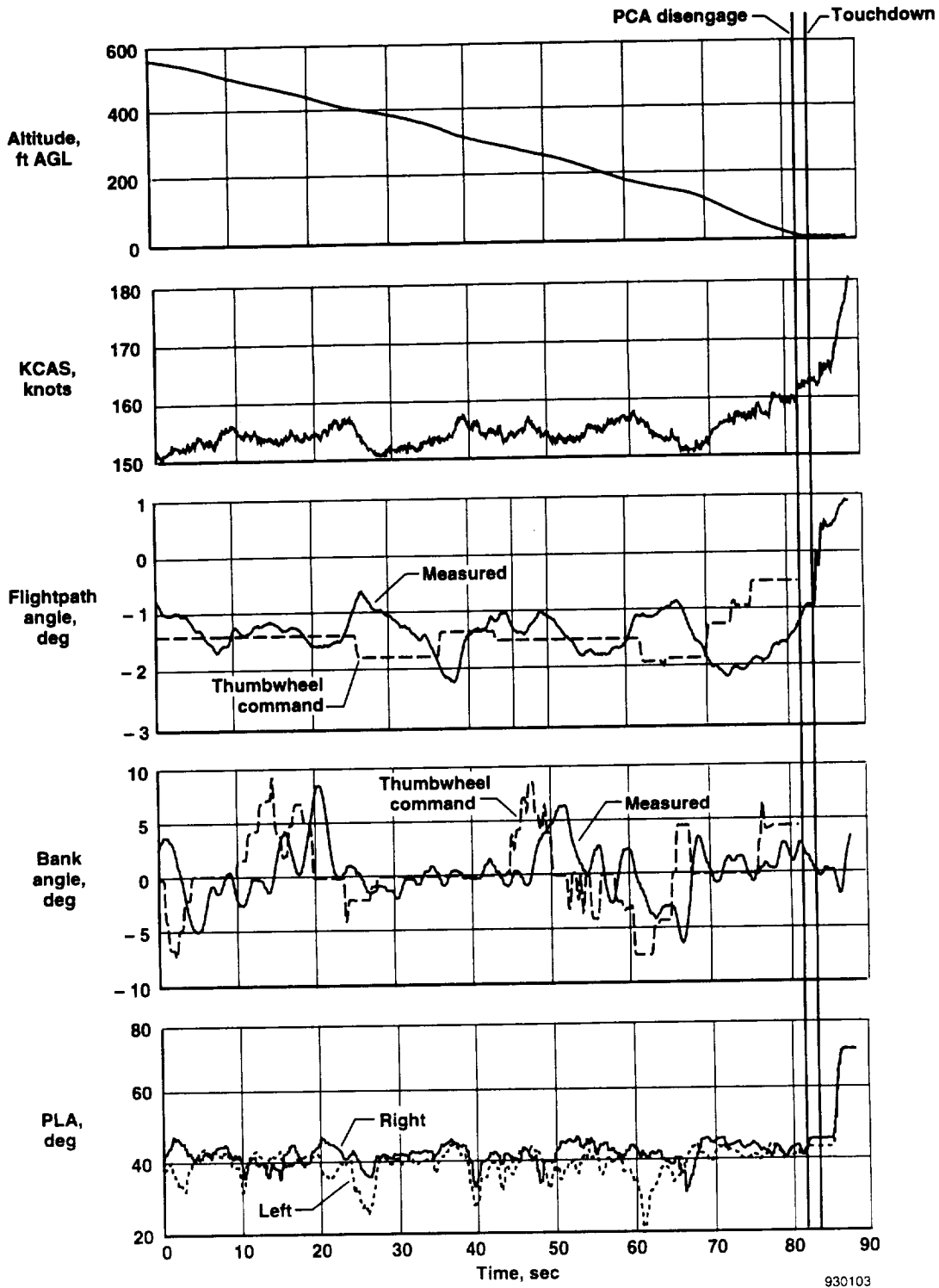

(a) Eighty-three seconds of landing approach.

Figure 35. Time history of PCA approach to 10 ft AGL, flaps down.

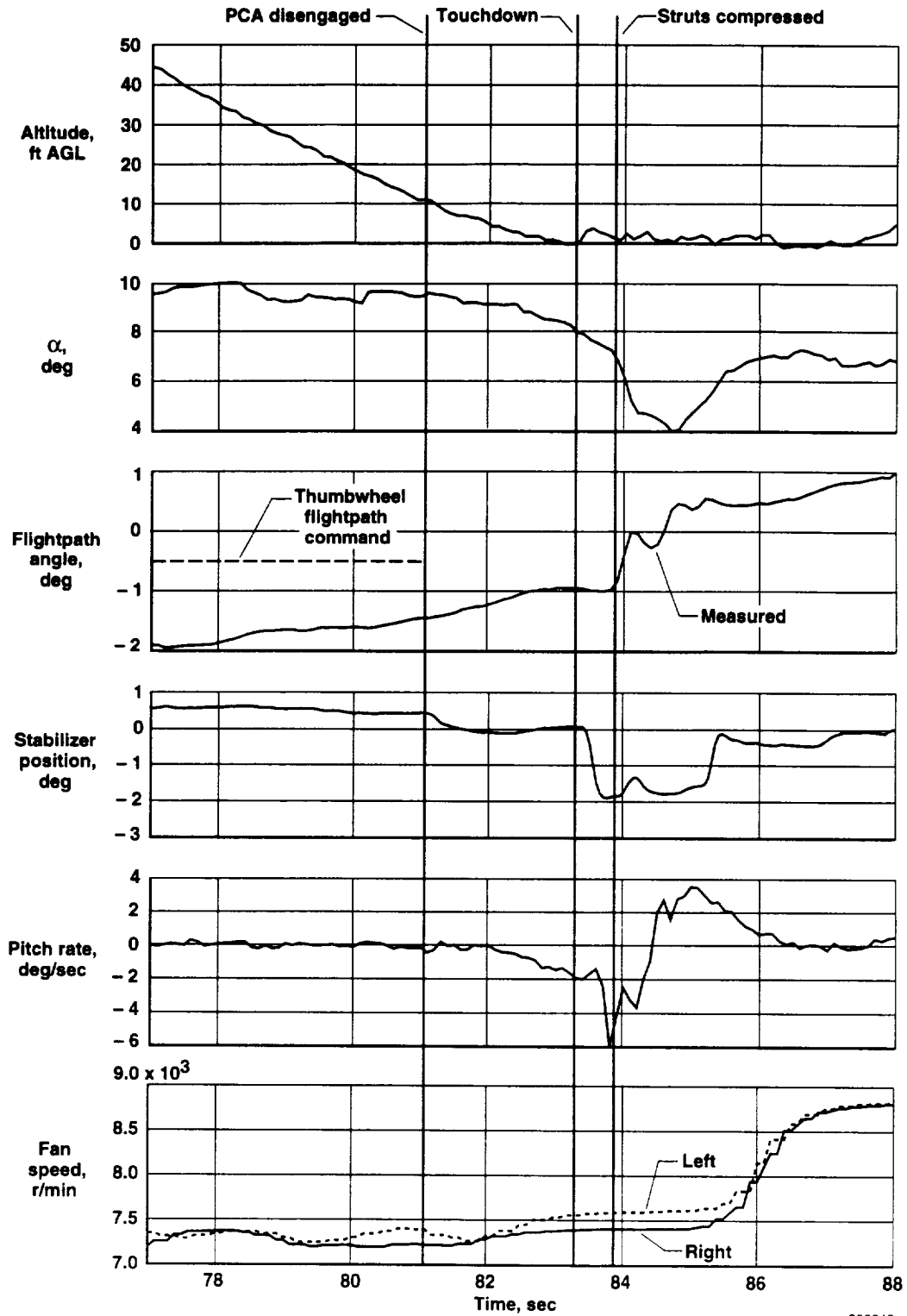

(b) Last 6 sec of approach.

Figure 35. Concluded.

Ground Effect

Approximately 24 approaches were made in which the ground effect was studied.¹³ The tests were performed, with CAS off and CAS on, at constant throttle to avoid the inlet effect. The radar altimeter provided accurate height AGL information. Based on these results, a revised ground effect model was incorporated into the NASA Dryden simulation in upgrade S18. This

model included the dynamic effects in which ground effect is less for high sink rates than for low sink rates (fig. 36). The changes in the model resulted in less ground effect very near the ground. A small increase in ground effect occurred in the 16 to 30 ft AGL range.

Based on this model, techniques for minimizing sink rate on PCA system landings were developed. Based on simulation results, landing sink rates in the 5 to 6 ft/sec range appeared attainable and PCA system landings were planned.

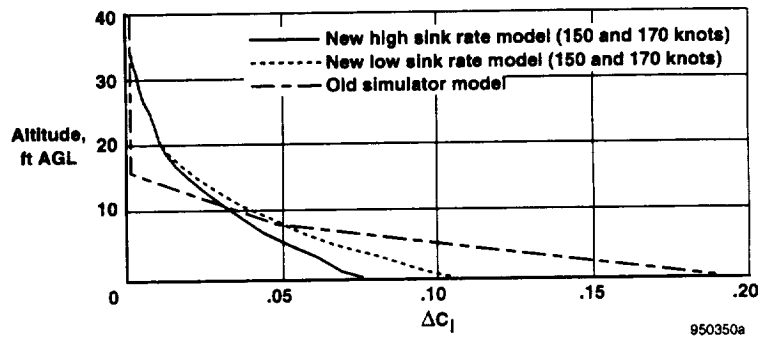

(a) Change in lift coefficient caused by ground effect.

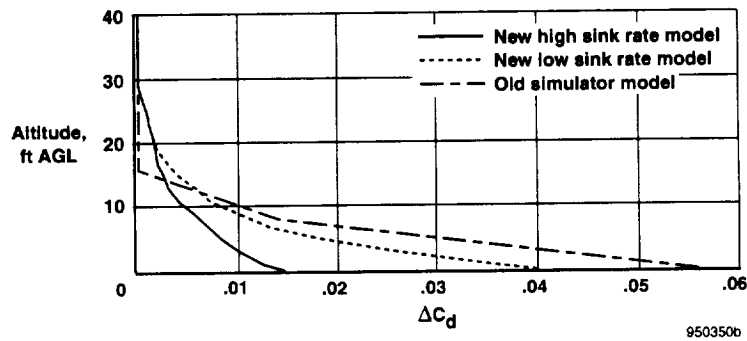

(b) Change in drag coefficient caused by ground effect.

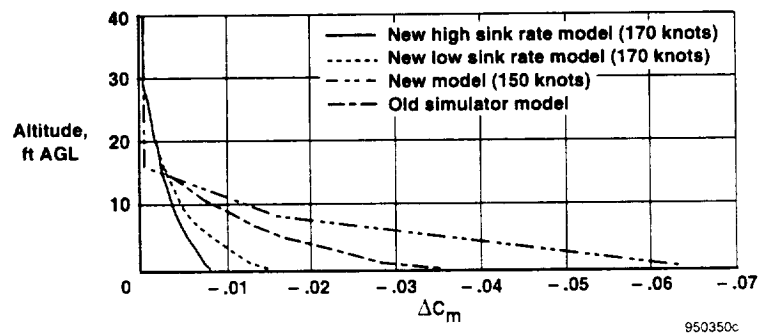

(c) Change in pitching moment coefficient caused by ground effect.

Figure 36. Original and updated ground effect model.

Propulsion-Controlled Aircraft Approach and Landing

Figure 37 shows a time history of the final 56 sec of the first PCA system approach and landing. The conditions for this landing included an 8-knot headwind approximately aligned with the runway and very light turbulence, except for a short period of light turbulence at $t = 30$ sec. Pilot A flew this approach and, based on simulations with the revised ground effect model, reduced the flightpath command from -1.6° to -1.1° at an altitude of 200 ft AGL and to -0.4° at 80 ft AGL, resulting in a shallow final approach. Pitch commands were few, and almost all of the time was spent making small bank-angle commands to maintain runway alignment.

At an altitude of 20 ft AGL and 6 sec before touchdown, the ground effect began to affect the flightpath, primarily with a nosedown pitching moment. The PCA system increased throttle setting and speed to try to counter the ground effect. However with no flight control input, the nose pitched down to -1.8° (8 ft/sec) at touchdown. At that point, the pilot made an aft stick input to cushion the impact on the main gear and to ensure that the nosegear did not touchdown first. Bank-angle control and lineup were good throughout the final approach. A small correction to the right was made just before touchdown.

Figure 37(b) shows the last HUD video frame before touchdown. The frame shows the flightpath marker below the command because of the ground effect. The radar altimeter is off; it does not show an output below 10 ft AGL. The bank angle at touchdown was -1° , and the touchdown was approximately 6 ft to the left of the runway centerline. The pilot rated the pitch control as very good except for the ground effect, and roll control was rated adequate for this first landing.¹² The nosewheel was approximately 1 ft AGL when the main gear touched, as shown in the captured video (fig. 37(c)).

Pilot A made a second approach. In this case, the control tower requested a 360° turn (for spacing) 6 miles from the runway at $t = 90$ sec (fig. 38). The pilot made this turn under PCA system control, selecting an immediate 32° bank. The nose dropped to -4° but was recovering when the pilot commanded a slight climb. At 200 sec, the pilot rolled out and then continued the approach. Air was smooth until 200 ft AGL when very light turbulence began. On final approach, a glideslope of -2.5° , decreasing to -1° , was flown until 20 ft AGL, when the command was raised to 0° . The resulting

glideslope was steeper than the one flown in the previous flight. In spite of this different technique, the ground effect was similar, and the airplane pitched over in the last few feet. The pilot made a small aft stick input approximately 0.4 sec before touchdown to ensure the nosewheel would not hit first. The touchdown sinkrate was again 8 ft/sec. Lineup was again good. Touchdown occurred 6 ft to the left of the centerline.

Based on these two PCA system landings, the ground effect was more severe than predicted by the updated NASA Dryden simulation. Because of the ground effect, it appeared that all landing sink rates could be at least in the 8 ft/sec range. Because the landing gear was only capable of sink rates of 10 ft/sec, a large margin for error or variation did not exist. Because of the PCA guest pilots' limited experience flying the F-15 airplane in the CAS-off PARRE mode and the significant ground effect, no additional PCA system landings were made.

Propulsion-Controlled Aircraft System Flight Profile

The PCA system was used to fly a preplanned flight profile to demonstrate that a mission segment could be flown without any control surface movement. After the PCA system was engaged at an altitude of 10,000 ft, the pilot flew an outbound heading, initiated a climb to an altitude of 15,000 ft, executed a 210° turn, and returned to the original point while maintaining an altitude of 15,000 ft. Altitude was maintained within ± 50 ft, and heading was maintained to within $\pm 2^\circ$.⁹ The flight controls remained fixed during this 7-min test.

Simulated-Loss-of-Control Upset and Propulsion-Controlled Aircraft System Recovery

Although the PCA system was designed to be engaged in essentially level flight, simulation studies indicated that it could safely recover the F-15 airplane when engaged at unusual attitudes. Such an upset might occur with a hydraulic system failure. In the simulation, the PCA system could be engaged at bank angles in excess of 90° and at dive angles to a maximum 20° and safely recover the F-15 to level flight.

The first flight tests were performed without the velocity feedback and with the PCA trim set to "auto." Starting from level flight at 250 knots, the airplane was rolled to an 85° bank, the flight controls were released, the emergency inlet position was selected, and the PCA system was engaged as the flightpath fell through -20° .

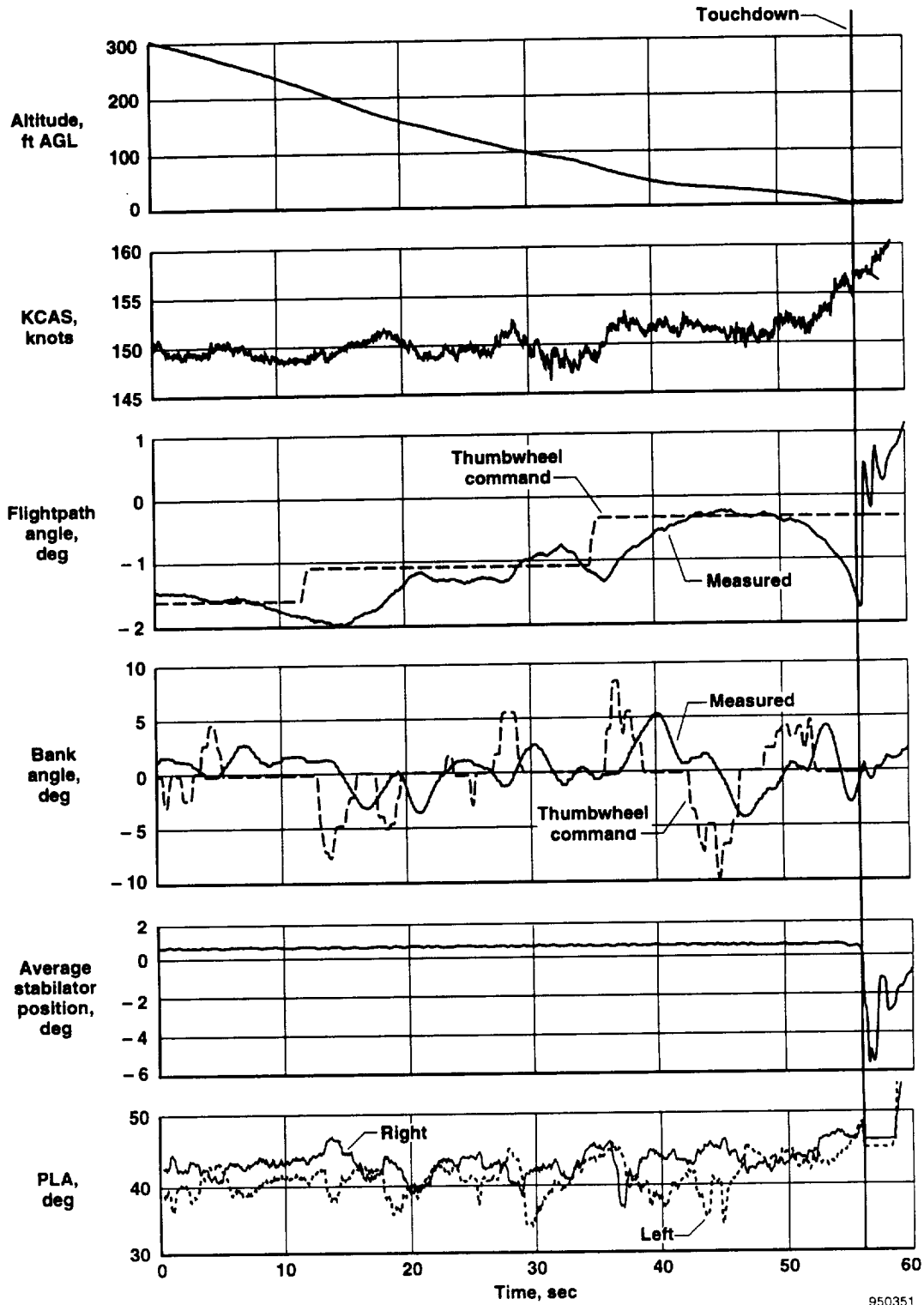

(a) Time history of last 56 sec.

Figure 37. First PCA system landing, flaps down, pilot A.

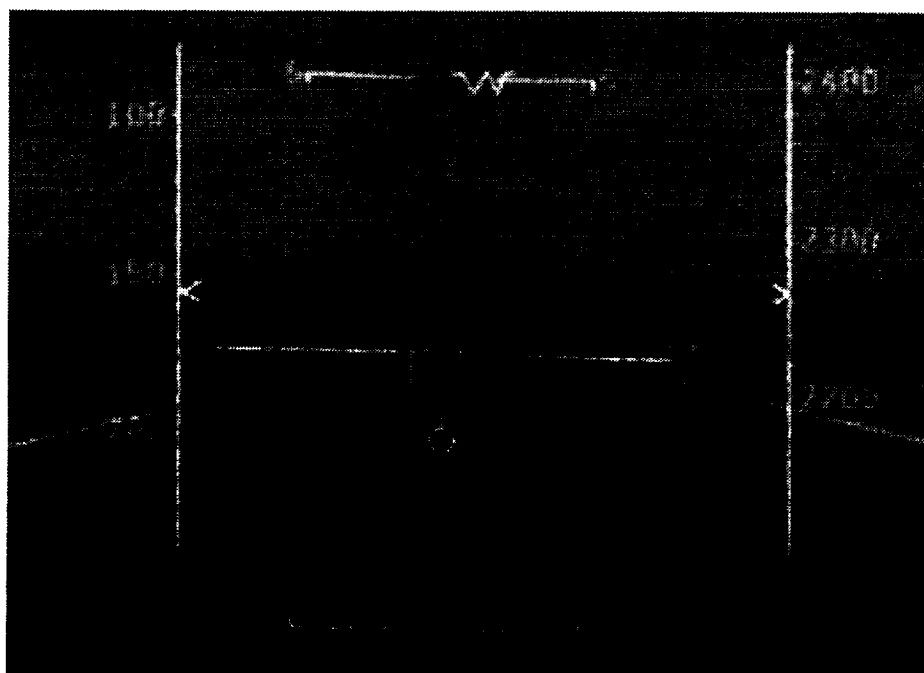

(b) The HUD video 0.2 sec before touchdown.

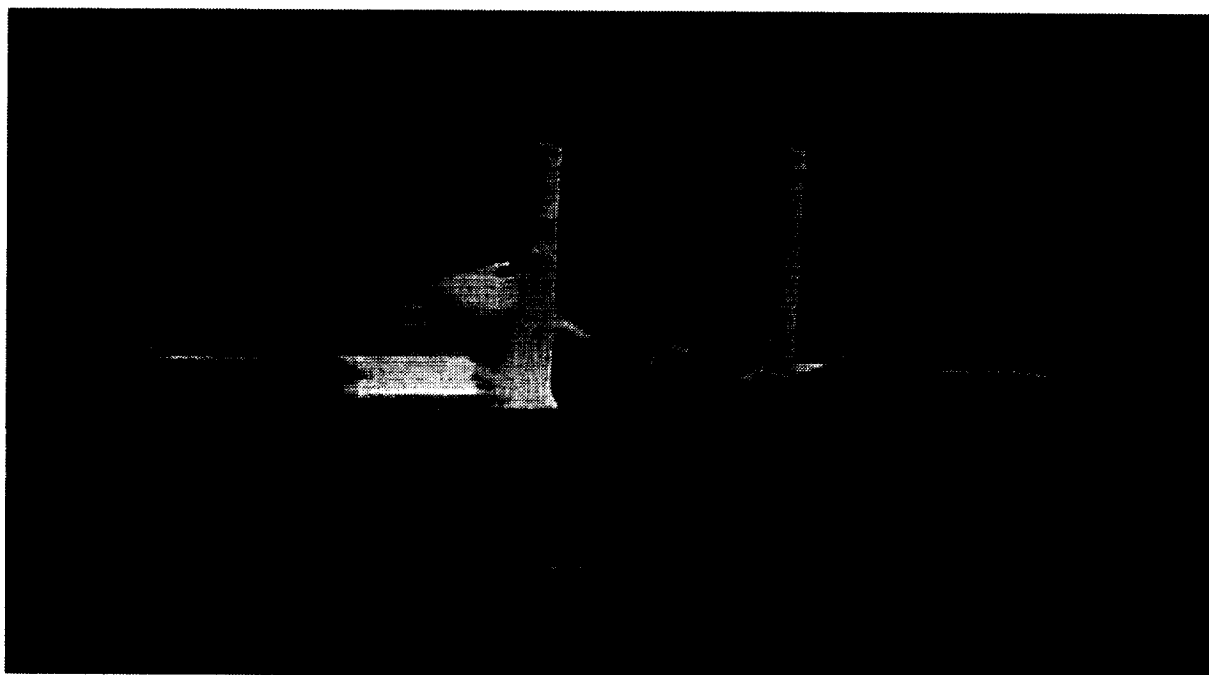

(c) Touchdown of first PCA landing.

Figure 37. Concluded.

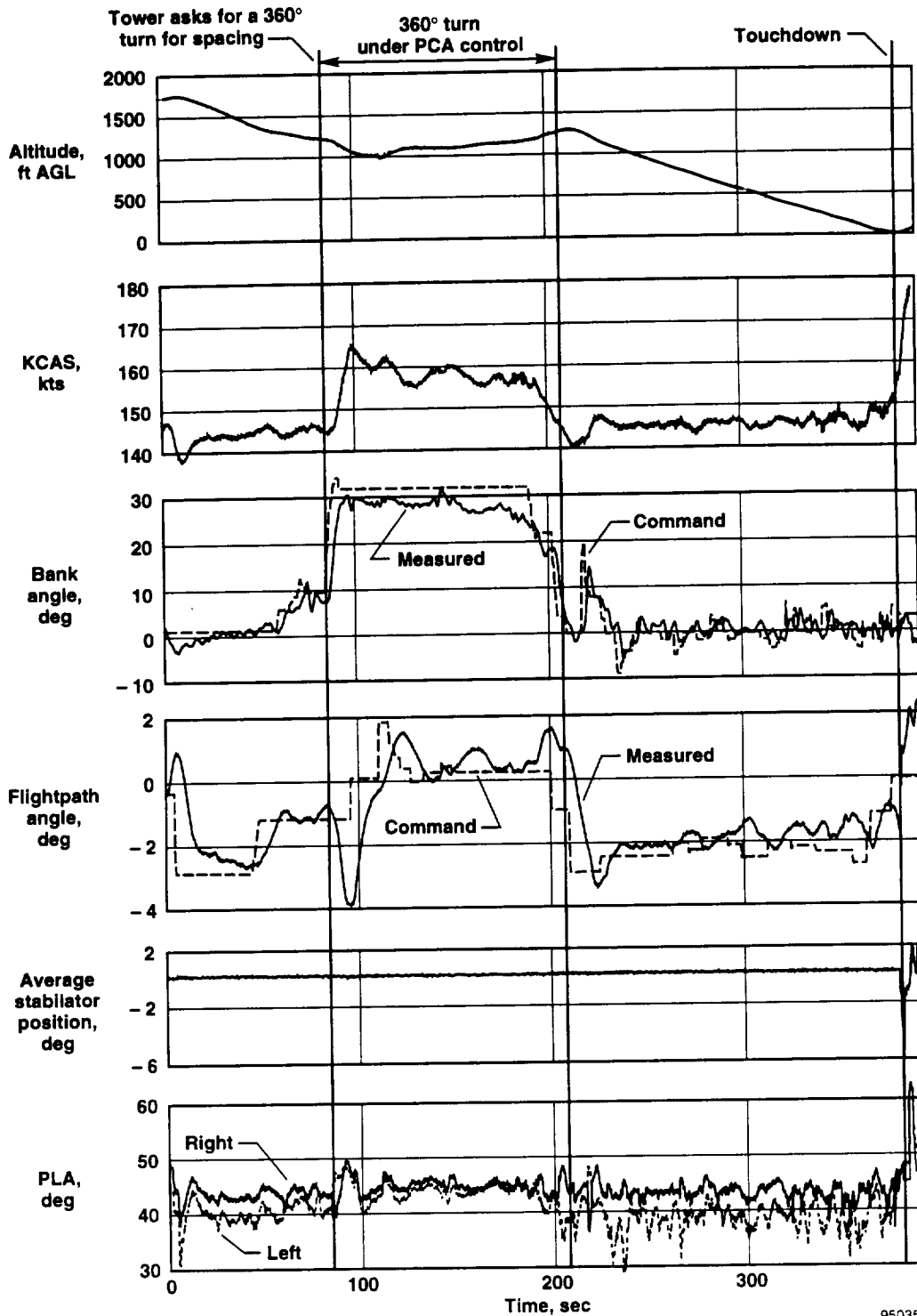

950352

Figure 38. Time history of second PCA approach and landing with 360° turn for spacing, pilot A.

The PCA system rolled the wings level but entered a neutrally damped pitch oscillation at an average trim airspeed of 190 knots (fig. 39).

The strong inlet effect at the high speed can be seen in the pitch rate parameter. Each time the system commanded increased thrust, the definite pitchdown is evident, as is the pitchup when the thrust command decreases. In addition, the trim remained on. The inlet effect and the trim being on prevented the PCA system from totally damping the pitch oscillation.

In another test (fig. 40), a PCA oscillation occurred at a trim speed of 255 knots. This oscillation occurred with the flaps up, gear up, inlets in the automatic position, and trim on. This oscillation was lightly damped and showed the inlet effect clearly as the PCA system called for thrust (and hence fan speed and inlet airflow) changes. Data from tests (figs. 39 and 40) were used to expand the inlet effects data (fig. 26) to a wider range of angles of attack and speeds. Based on these PCA system oscillations, the velocity feedback option for pitch control was used for further upset testing.

Guest pilot F performed the upset test with the velocity feedback active. Figure 41(a) shows a time history of this upset followed by a PCA system engagement and recovery. In this test, the PCA system was engaged with trim set to "auto" at an 85° bank and a -18° flightpath. The PCA system commanded full differential thrust, rolled the wings level, then reduced thrust to begin the phugoid damping.

Figure 41(b) shows the ground track and HUD. When the pilot put in a bank command to convert some of the excess pitch energy into a turn to reduce the pitchup, airspeed decreased to 150 knots at the maximum altitude. After one full pitch cycle, the pilot lowered the flaps, which caused another pitchup and speed reduction. Speed decreased to a minimum of 105 knots. The landing gear was extended, and the pitch oscillation was damped quickly. The PCA trim was satisfied. Trim speed was 150 knots. The pilot then turned back toward the Edwards runway and began a descent with a -6° flightpath command. At 450 sec, the pilot leveled and made a turn to start a long, straight-in approach to runway 22. The approach was continued with minimal deviation until the airplane was 10 ft AGL and on the centerline in perfect position to land (11 min after the upset). At that point, the pilot used the stick to disengage the PCA system and flared slightly for touchdown.

Figure 42 shows another upset and PCA recovery. In this flight, flown by guest pilot H, the PCA system was engaged at a 68° bank and a -10° flightpath, a somewhat

less severe upset than the previous one (fig. 42(a)). To improve phugoid damping, the PCA trim was turned off and velocity feedback was turned on. The PCA system commanded a large but not full differential thrust that rolled the wings to near level, and the pitch oscillation was damped rapidly. The flaps and gear were lowered during a downswing of the phugoid, which aided in rapid stabilization of flightpath. Trim was then switched to "auto," initiating a trim cycle that eliminated biases in bank and flightpath. The pilot then turned and began a descent similar to that shown in the previous figure. Air was smooth at altitudes from 8,000 to 12,000 ft.

At lower altitudes, light to occasionally moderate turbulence existed with surface winds at a 260° heading and a speed of 12 knots. Figure 42(b) shows the final 60 sec of this approach. At $t = 795$ sec, a downward gust drove the flightpath from -2° to -5°. At $t = 800$ sec, another gust drove the right wing down and caused the aircraft to deviate to approximately 100 ft to the right of the extended centerline. The PCA system response to this gust and the resulting pilot input was affected by the left throttle saturating at idle (20°), thus reducing the differential thrust available for bank control. Effects of PCA-system throttle saturation have been discussed.¹⁴ Still, with aggressive bank-angle commands, the pilot was able to fly under PCA system control to 20 ft AGL and within 6 ft of the centerline. At this point, the pilot disengaged the PCA system and made small stick inputs to bank right and flare for touchdown. The flightpath angle would have resulted in a touchdown at approximately 11 ft/sec if PCA system control had been maintained to touchdown.

The recovery from upset was flown by the NASA project pilot and all guest pilots. The results show that the PCA system has a good chance for recovering airplanes from actual flight control system failures, provided that the flight control system and aircraft configuration are such that throttle forces and moments have adequate authority to achieve controlled flight.

Throttles-Only Manual Control

Tests were flown using throttles-only manual control for up-and-away flight. The basic stability of the airplane in the CAS-off PARRE mode was already greatly reduced. Engine response usually differed for the two engines, which had very high thrust and high throttle friction. As a result, precise thrust changes were difficult. The slow spooldown to low thrust values was particularly troublesome. In spite of these problems,

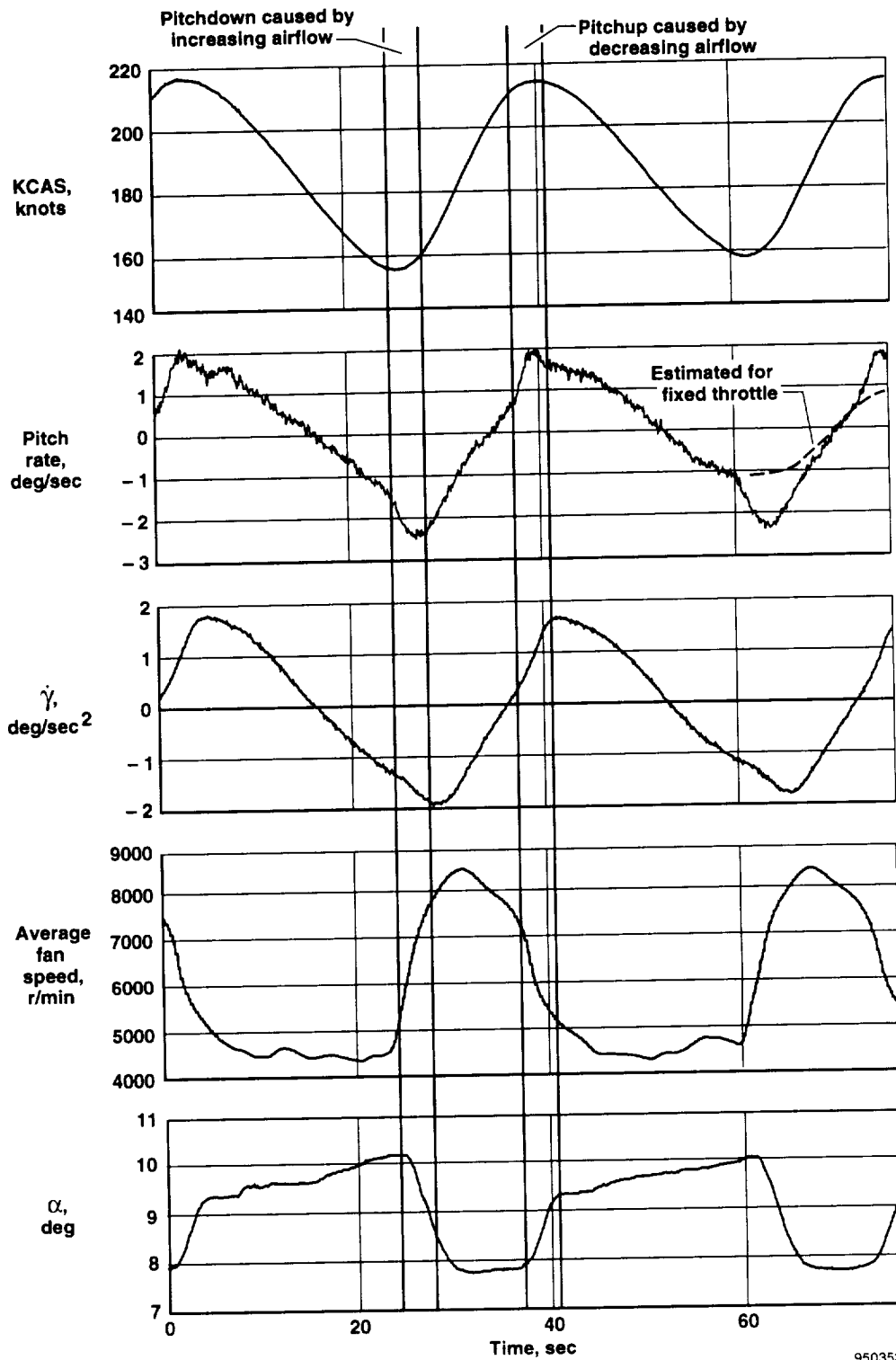

950353

Figure 39. An F-15 PCA pitch oscillation caused by inlet effect, gear up, flaps up, PCA trim on, velocity feedback off and inlets emergency.

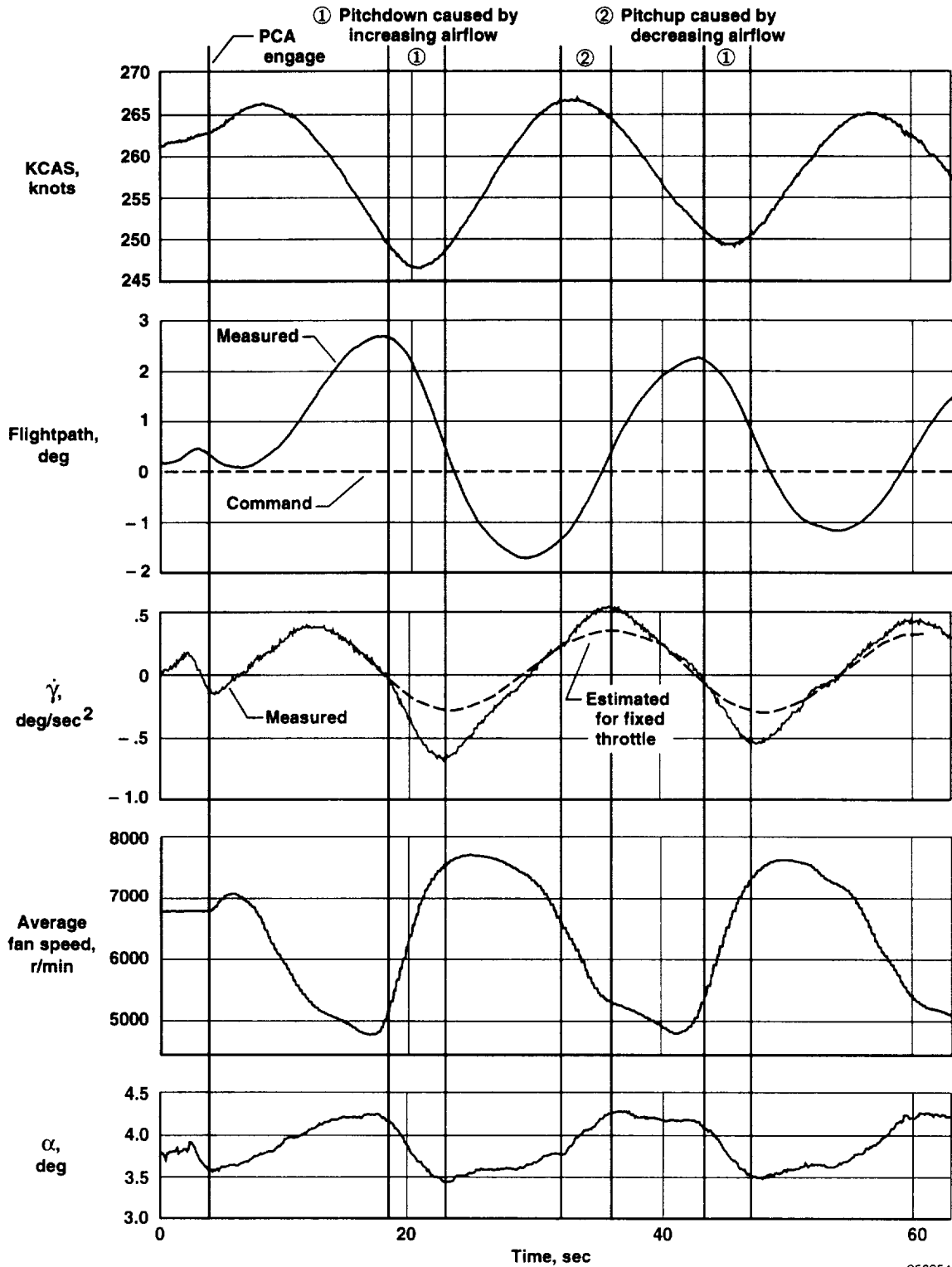

950354

Figure 40. An F-15 PCA pitch oscillation caused by inlet effect, gear up, flaps up, PCA trim on, inlets automatic, velocity feedback off.

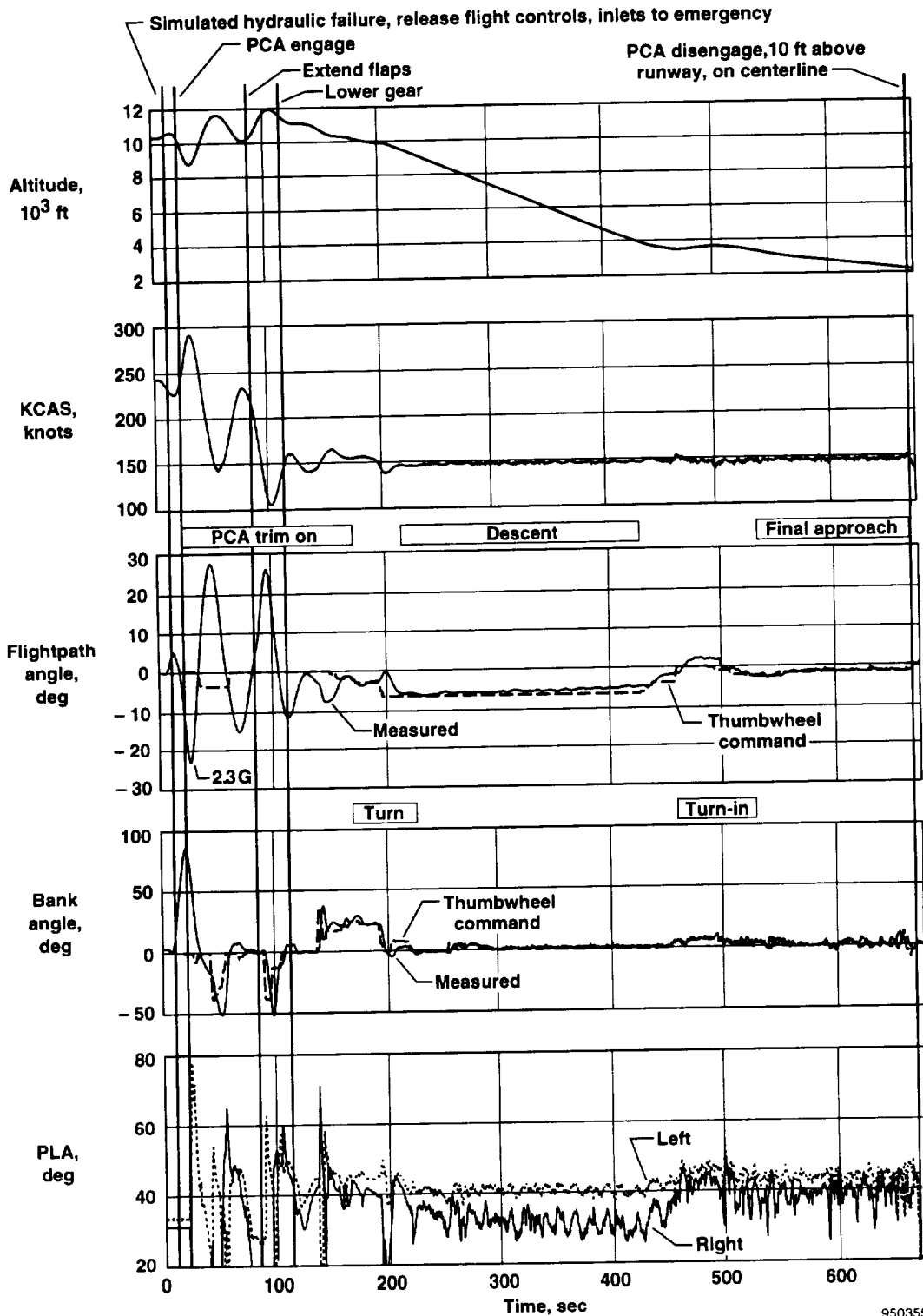

(a) Time history.

Figure 41. The F-15 upset, PCA recovery, descent, approach to landing, velocity feedback on, pilot F.

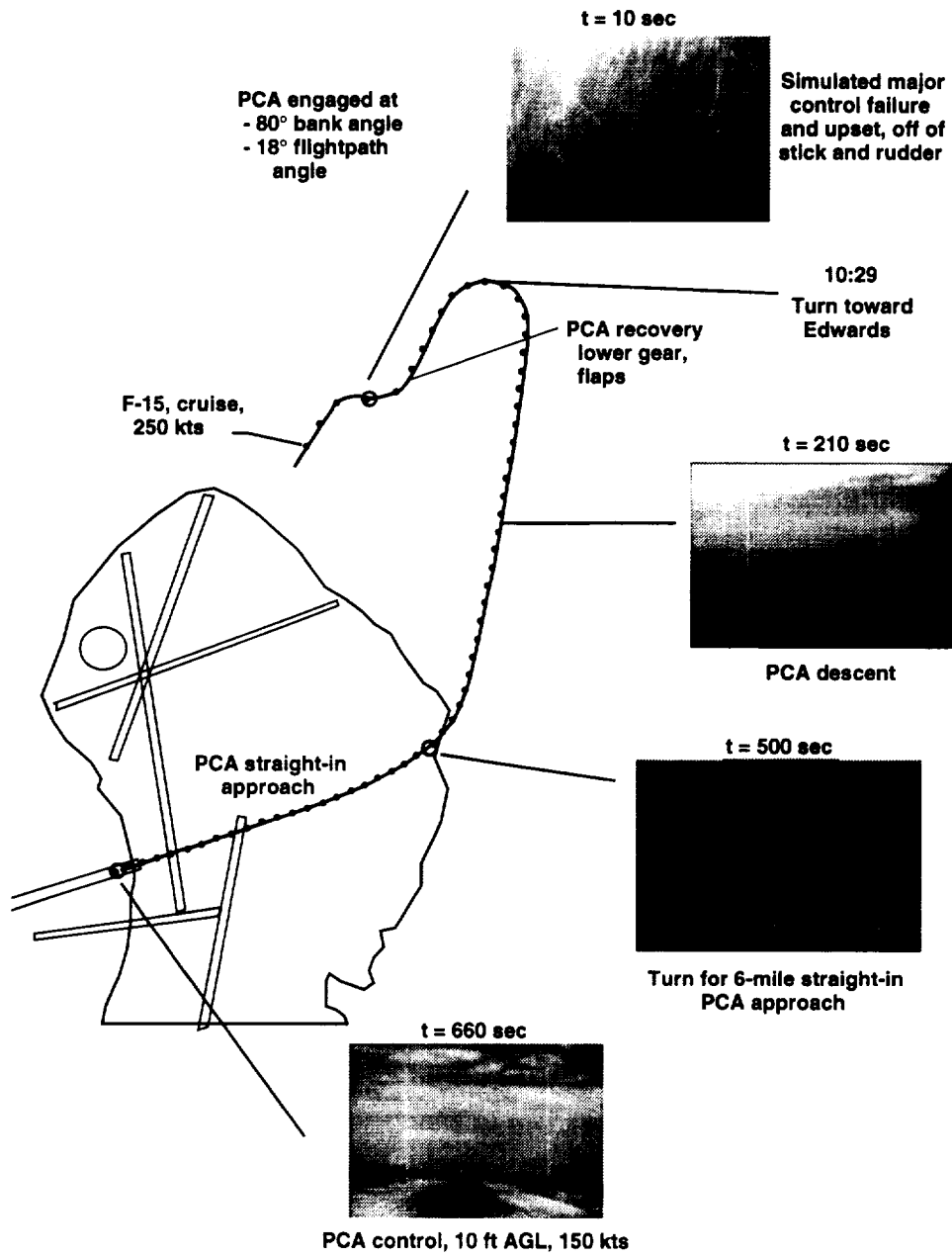

950356b

(b) Ground track and selected HUD video.

Figure 41. Concluded.

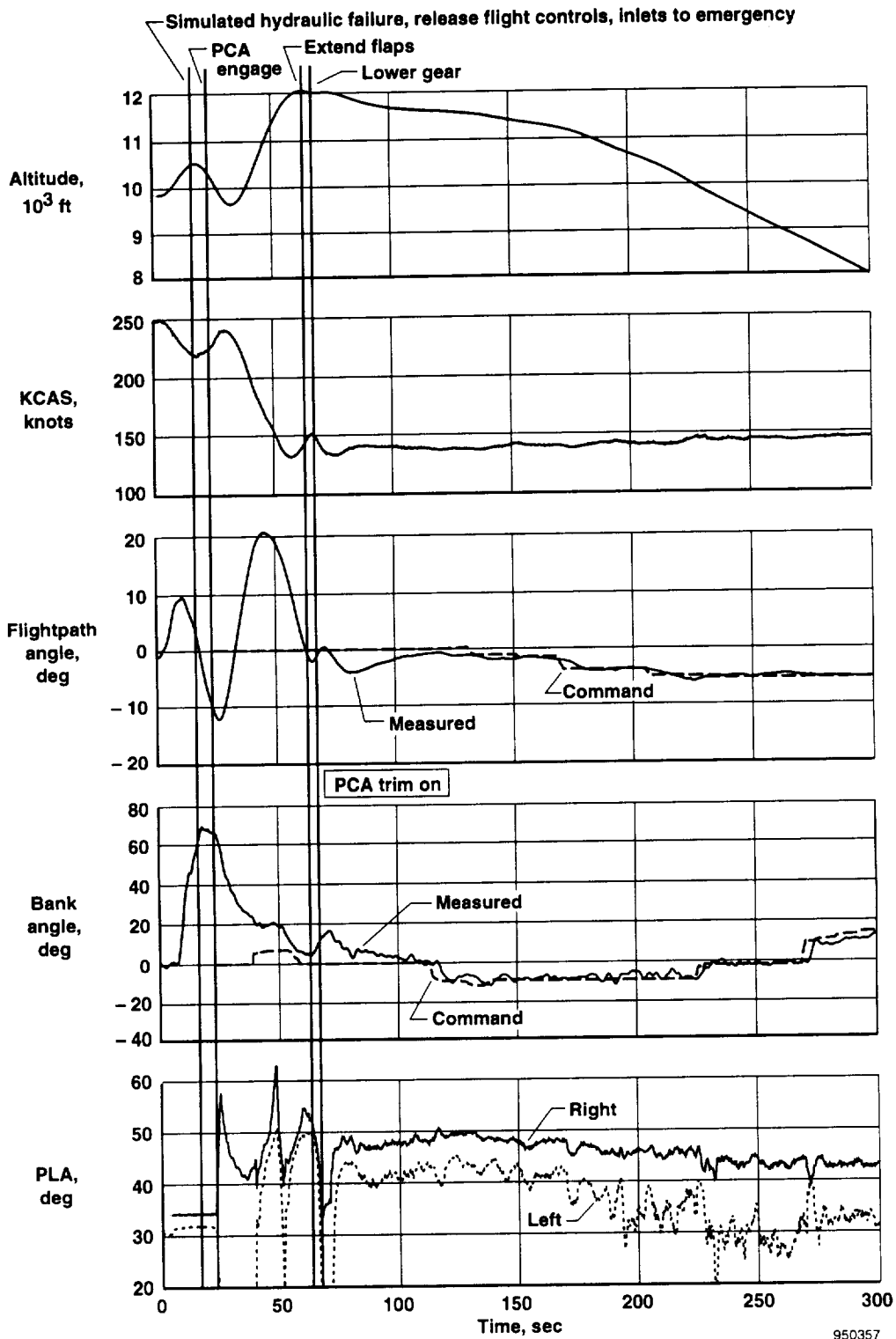

(a) Upset, PCA engagement, recovery and initial descent.

Figure 42. Time history of F-15 upset, PCA recovery, descent, approach to landing, velocity feedback on, pilot H.

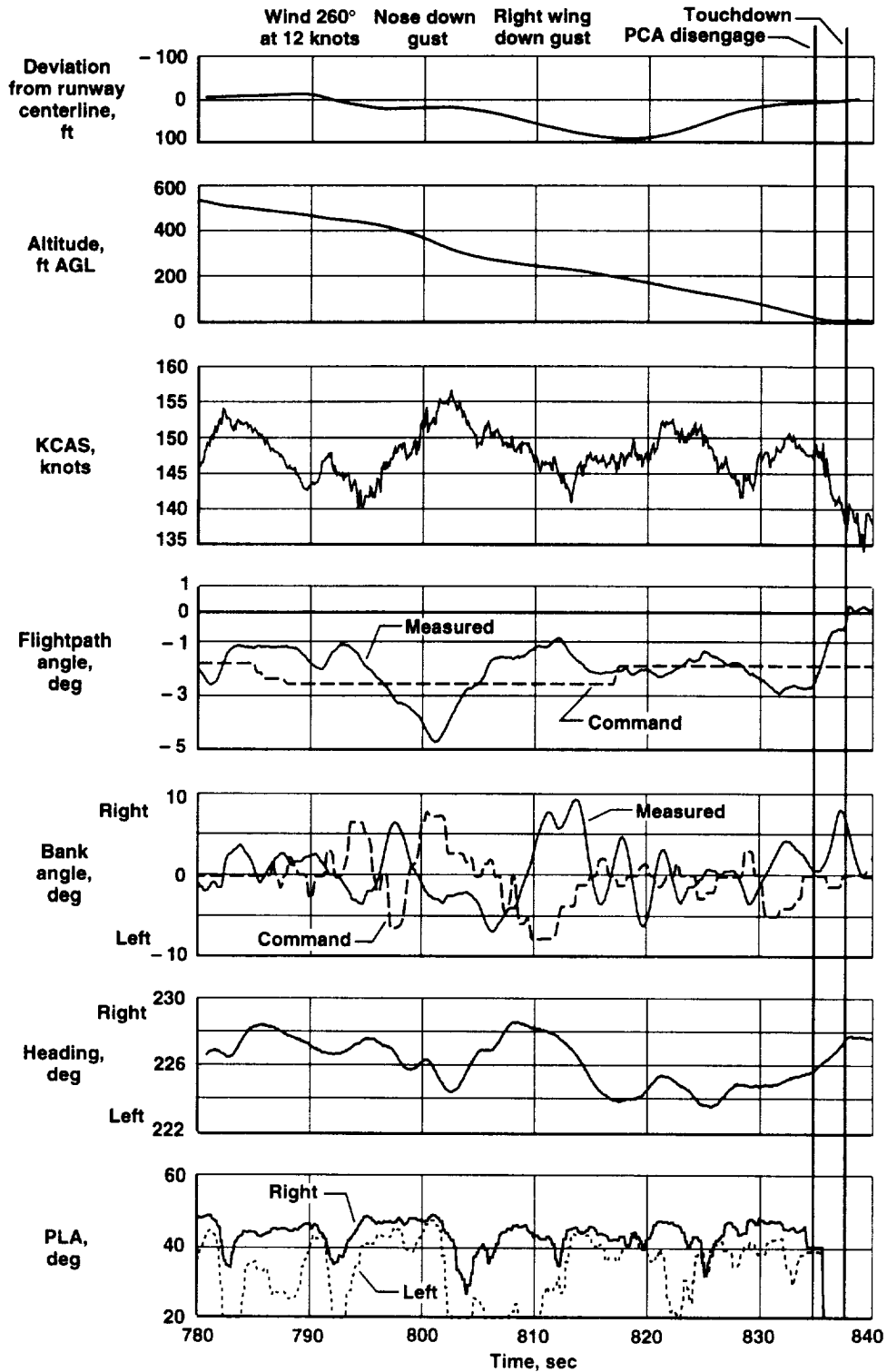

(b) Final approach to 20 ft AGL in light-to-moderate turbulence.

Figure 42. Concluded.

with some practice, pilots could control roll reasonably well at 150 knots with flaps down and hold the heading within a few degrees. Pitch control was difficult. Small changes could be made, but setting up and holding a climb or descent was a full-time task, and results were less than desirable. Holding flightpath within 1° of desired was very difficult. Combining pitch-and-roll tasks with any sort of precision was almost impossible, even in smooth air.

Throttles-Only Manual Approach

Throttles-only manual approaches were flown by all pilots for comparison with the PCA systems approaches. A manual approach was flown by pilot F on the same flight in which the upset and approach was flown (fig. 41). Figure 43 shows a 5-min interval of the two approaches. The manual approach shows poor heading control and flightpath oscillations of a minimum of $\pm 5^\circ$ at a time when the PCA system was controlling to $\pm 0.5^\circ$. Large airspeed excursions and much throttle activity are evident. The right throttle was on the idle stop for approximately one-half of the approach. The pilot concluded that reaching the runway was possible, but it would have been a crash. When the guest pilots tried throttles-only manual approaches, none were successful. These pilots agreed that a safe landing was very unlikely. Even after extensive practice, Pilot A, the project pilot, also concluded that a safe runway landing was virtually impossible.

Effects of Weight and Center of Gravity

Although definitive results as a function of weight were not obtained, some trends were obvious. The PCA system performed best immediately after takeoff when the vertical CG was highest (so that thrust increases caused a slight noseup moment) and horizontal CG was forward, resulting in the highest degree of pitchup for each knot of speed gained. Late in the flights, the PCA system became less stable as CG dropped and moved aft. With 3000 lbm of fuel remaining, performance was poor unless the speed was reduced to approximately 140 knots to keep the angle of attack in the range of favorable inlet effect. At light weights and 150 knots, the PCA system flightpath control was neutrally stable with PCA trim on and only slightly better with trim off. The PCA system landings were made with approximately 6000 lbm fuel weight.

Propulsion-Controlled Aircraft System Envelope Expansion

Following successful PCA system landings, tests were made to determine the limits of PCA system operational abilities. Once it became clear that the system capabilities exceeded initial expectations, additional tests were conducted. These tests are discussed next.

Maximum Bank Angle—Tests were performed to determine the maximum bank-angle capability of the PCA system in the F-15 airplane. The software limits and thumbwheel scaling were modified to permit bank-angle commands to a maximum 60°.

Figure 44(a) shows results with flaps and gear down. This test was flown immediately after takeoff with approximately maximum fuel. Initial trim speed was 151 knots at an altitude of 12,000 ft. Commands to 15° were flown for reference and held accurately. A command of 35° resulted in an overshoot to 40° and a drop in pitch attitude to -5° . Speed was increased to approximately 180 knots to sustain the bank and keep the nose from dropping more than it had. The increased throttle setting made the inlet effect more destabilizing.

Repeating the test, bank commands to 25° were accurately held. Again, the 35° command resulted in an overshoot to approximately 50°. After 400 sec, altitude had decreased to 9000 ft, and a 35° command was held at approximately 40° in light-to-moderate turbulence (note the dynamics on KCAS (fig. 44)). Trim speed was reduced to 145 knots. At this point, the pilot, still using PCA system control, rolled to wings level and commanded a climb to get above the turbulence. At 650 sec, a left turn was commanded, 40° was held, then bank angle was increased to the full 60° command. Bank angle oscillated $\pm 10^\circ$, and the flightpath had decreased to -10° , even though speed increased to 210 knots. On the rollout command, a pitch overshoot to 20° occurred as the energy from the increased speed was converted into pitch. After the flightpath stabilized, the trim speed had decreased to 140 knots.

Figure 44(b) shows the trim airspeed as a function of bank angle compared to the simulation. Comparison is good to 50°. At 60°, the simulation displays an unstable bank control with a steep dive similar to that seen in flight.

Over the 13-min test, the weight had been reduced by 1000 lbm and the trim speed had decreased 11 knots or approximately 1 knot/min. This trim speed reduction caused by reduced weight is an important factor in throttles-only control speed management. Refer to the Principles section for additional information.

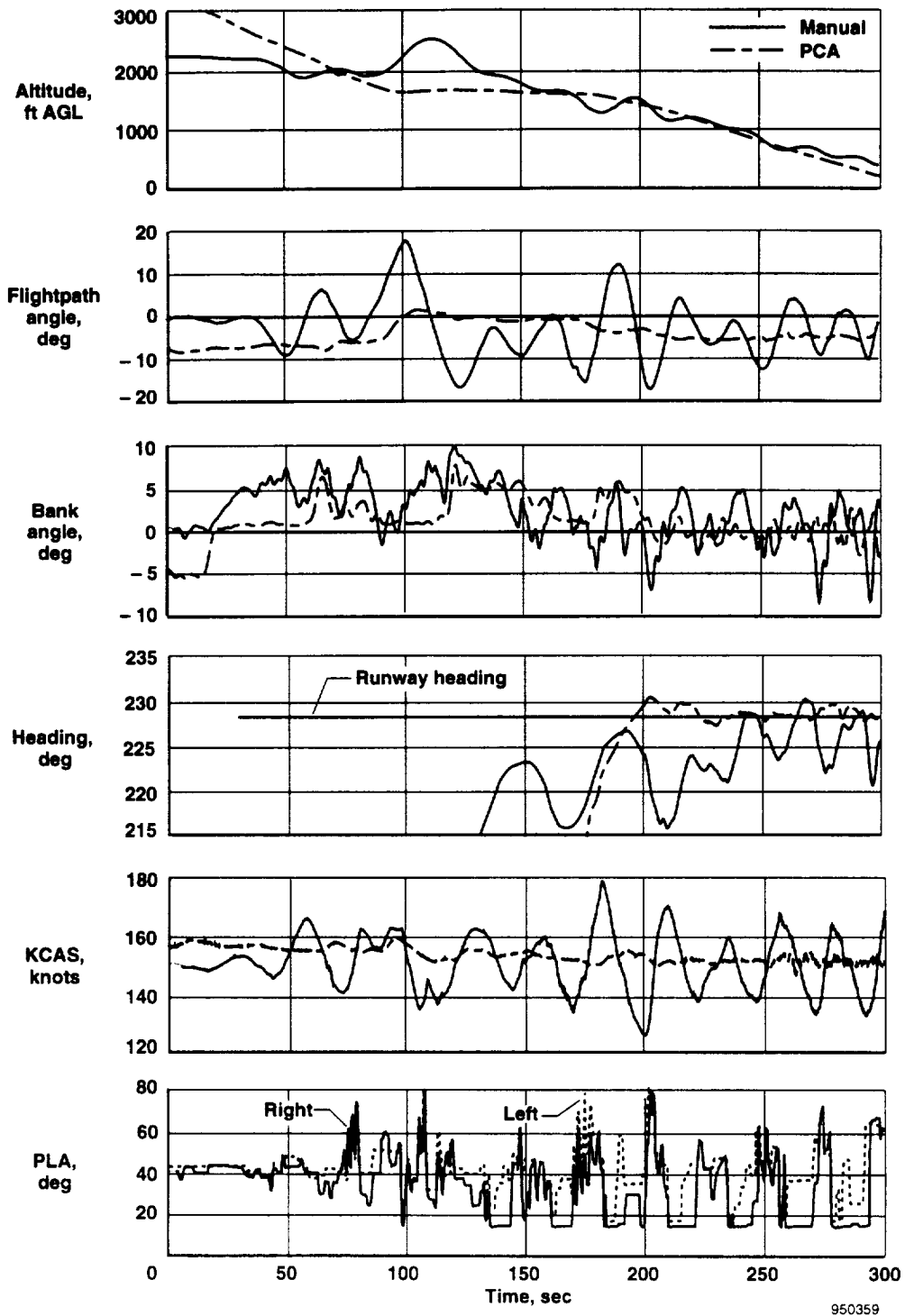
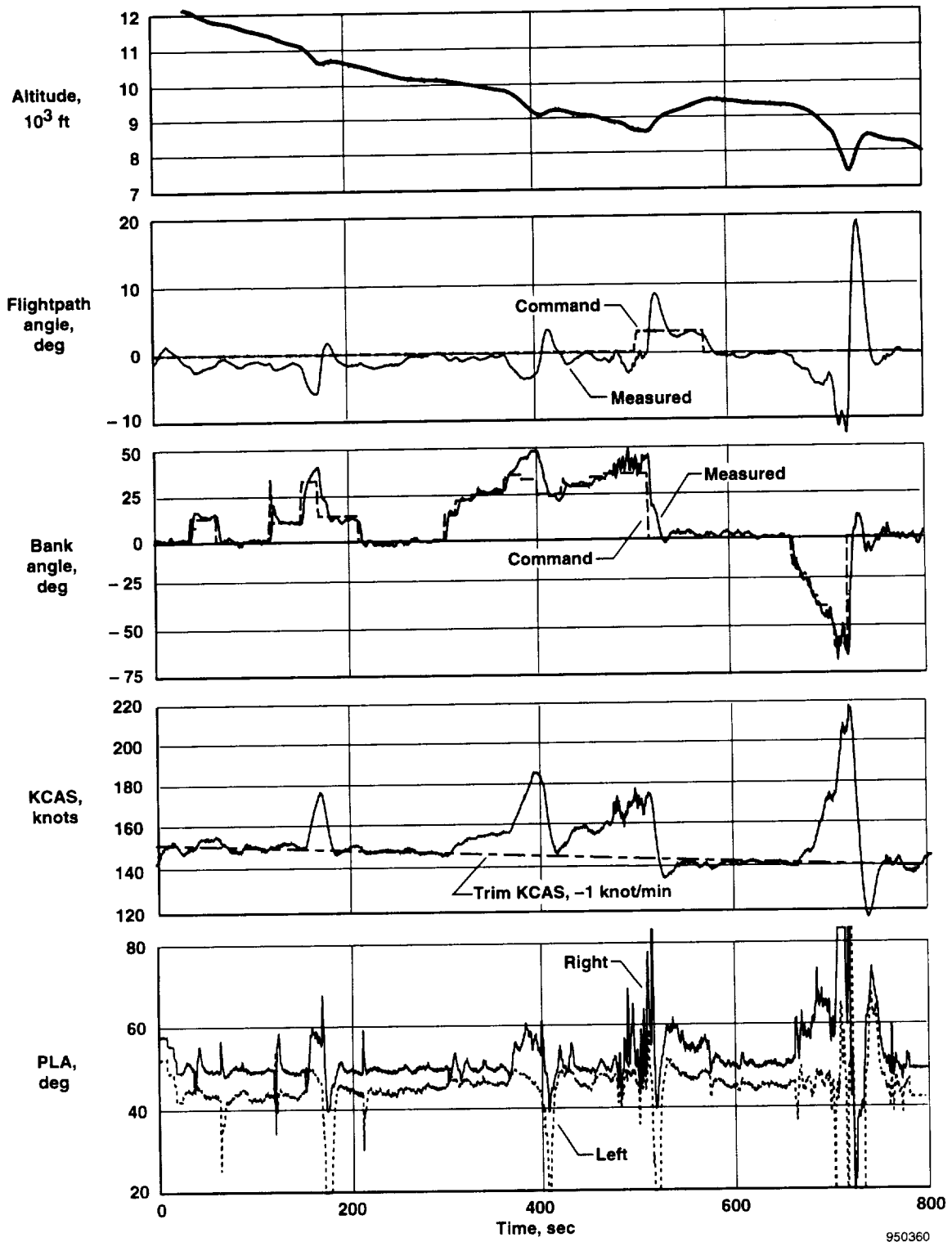
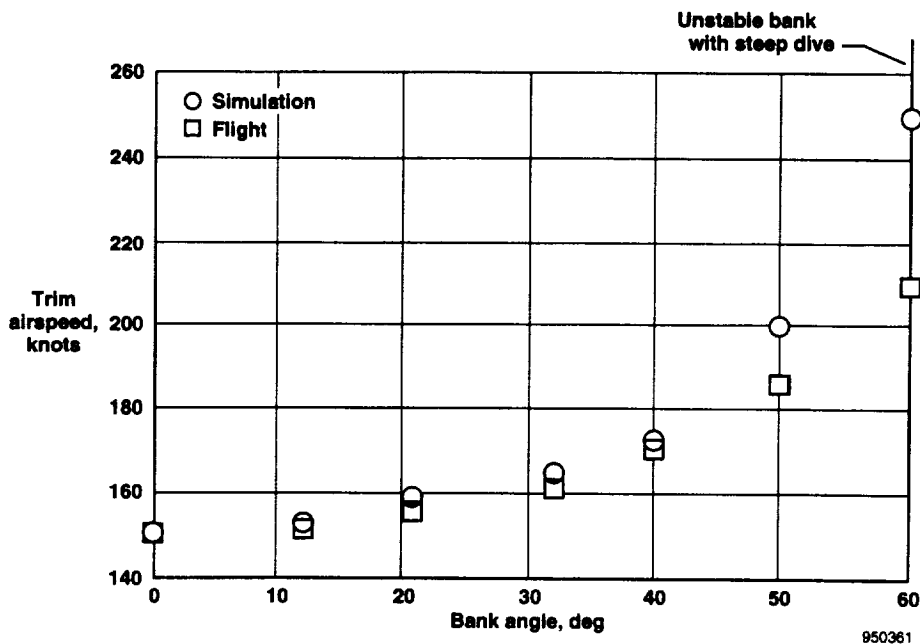

Figure 43. Time history of a manual throttles-only approach compared to a PCA approach, pilot F, flaps down.



(a) Time history of flight parameters.

Figure 44. The F-15 PCA maximum bank-angle test, flaps down.



(b) Change in trim speed with bank angle, flight and simulation.

Figure 44. Concluded.

Flight Envelope Expansion—The PCA system was designed to operate between 170 and 190 knots and at altitudes to a maximum 10,000 ft. After the PCA system landings, system operation was expanded outside of the design envelope to determine the robustness of the control algorithm. A climb at 150 knots was made. At an altitude above 20,000 ft, a lateral mistrim that required unequal throttle commands for level flight had resulted in a need to increase throttle split to maintain wings-level flight. This mistrim had been a minor problem at lower altitudes. Roll performance was also degraded, and pitch performance deteriorated. The climb was discontinued when one engine reached intermediate power at an altitude of 28,000 ft, and heading could no longer be maintained.

The speed envelope had been expanded during the recovery from upsets. Although the phugoid damping was poor, gross control was possible. Figure 45 shows a 280-knot climb with the flaps up, gear up, inlets in the emergency position, and velocity feedback active. After engaging and initiating a PCA trim, the pilot started a turn. The PCA trim process took more than 150 sec because of poor phugoid damping and pilot inputs. When trim was completed, PCA system performance was improved.

At an altitude of 30,000 ft, pitch and roll steps were made. At 410 sec, when the right roll command was

removed, the left throttle went to idle. This change contributed to the nose dropping 5°. The climb was then continued. At an altitude of 35,000 ft, another set of flightpath and roll steps was made. Flightpath was generally maintained within $\pm 2^\circ$. Roll control was better than pitch control. Maximum altitude was 37,000 ft, and maximum speed was Mach 0.88. The climb was discontinued at this point, not because of PCA system limitations, but because CAS off PARRE mode flight is not recommended in the transonic region.

The throttles were well matched at the beginning of the test. These throttles developed an increasing bias. As a result, increases in right throttle were required to hold the wings level. This bias may result from wing fuel migration during the extended uncoordinated turn from 90 to 180 sec. When the fuel had shifted to the right, increased right throttle would be required. Without a left turn to return the fuel, the bias continued. Wing fuel quantity measurements also showed a bias consistent with fuel migration. Similar throttle biases had been seen at other flight conditions when extended periods of turning flight were flown with partially full wing tanks. The bank-angle test (fig. 44) was flown with approximately full fuel and did not show major changes in throttle bias.

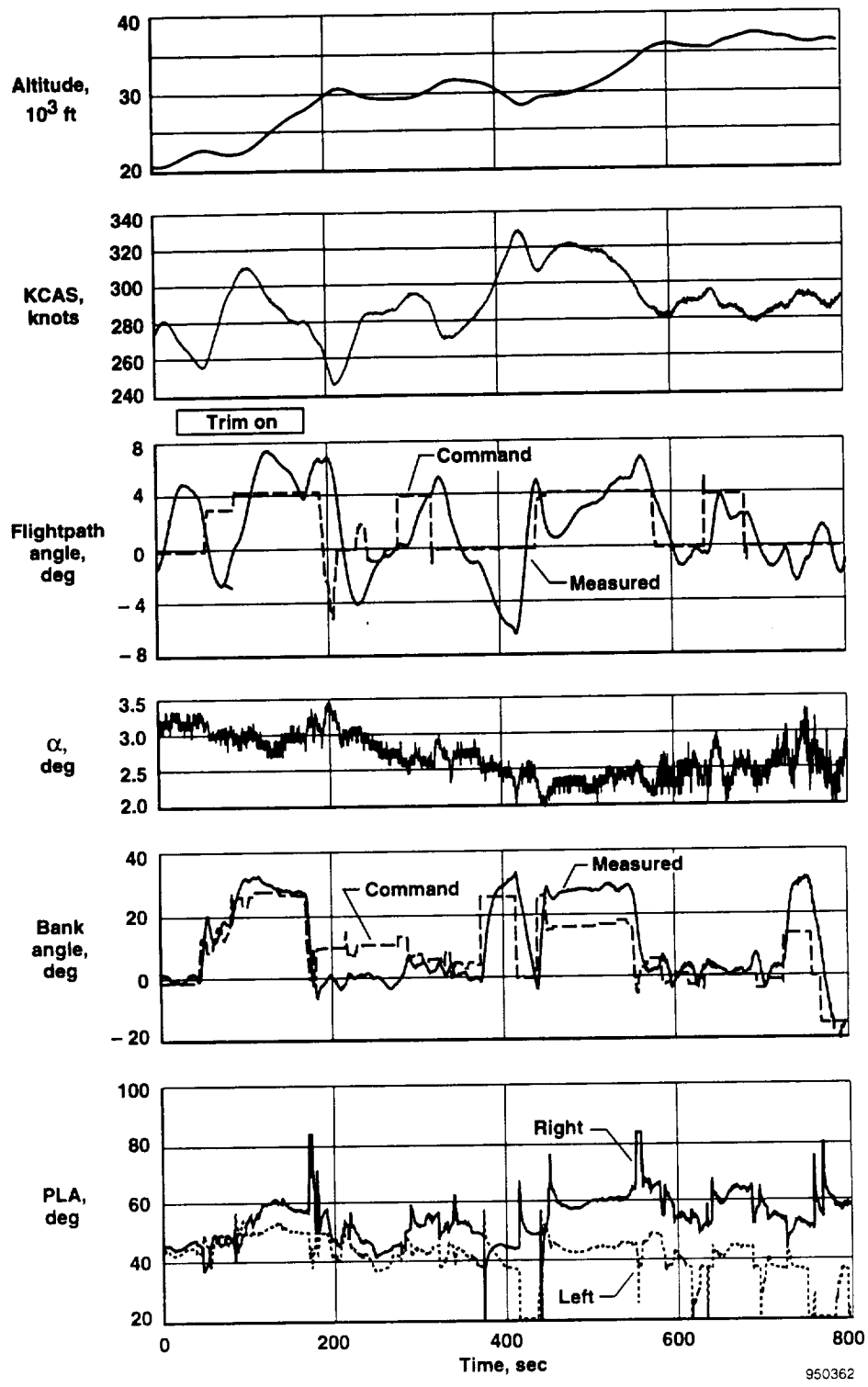

950362

Figure 45. Time history of PCA climb at KCAS = 280 knots, flaps up.

Figure 46 shows the tested PCA system envelope. The fact that the PCA system remained usable well beyond its design envelope is encouraging for future applications.

Heading Mode

A heading mode was developed for the F-15 PCA system. This mode was designed to maintain a commanded heading when the bank-angle thumbwheel was in or near the detent and to allow a heading to be selected with the bank-angle thumbwheel. This mode was developed late in the PCA project and did not get extensive simulation nor flight test.

Figure 47 shows the heading mode control law. No convenient input device, such as a heading command knob, existed in the F-15 airplane for making heading commands. The bank thumbwheel was used, but it could only be reasonably scaled for approximately $\pm 10^\circ$ of heading change. When in the heading mode, the pilot would press the PCA "engage" button on the throttle to establish a new heading reference (the heading at that time). The thumbwheel would then be used for heading command. If more than a 10° heading change were needed, the engage button would be pressed again to establish a new heading reference.

The gain for large heading commands was initially too high. The results were a very large initial bank angle and some lightly damped bank-angle oscillations. With the flexibility of the PCA software, a 60-percent reduction in gain was made immediately, and performance greatly improved.

Figure 48 shows the flight test of the heading mode. Despite the cumbersome mechanization, the heading mode worked acceptably at altitude (fig. 48(a)). Level flight at an altitude of 4800 ft was held for the first 280 sec. The indication of heading reference then reset. Heading was held to within $\pm 0.5^\circ$. Bank-angle limiting would need to be incorporated in this mode to avoid large bank angles when large heading changes are commanded.

Figure 48(b) shows a PCA heading mode approach to the runway down to 50 ft AGL. Weather for the final approach was light turbulence with surface winds at a 220° heading and a speed of 12 knots. Fluctuations on the airspeed trace indicate a significant level of atmospheric activity. Approximately 1° of bias existed in the flightpath command throughout the approach, probably because the test lasted more than 12 min.

Pilot A commented that, when established on final approach, the workload was significantly reduced compared to approaches using bank-angle control.

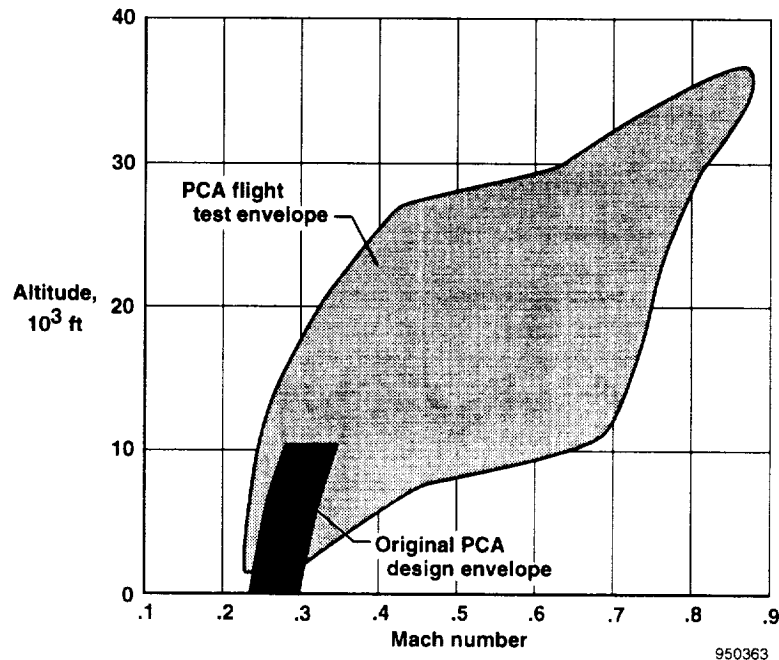
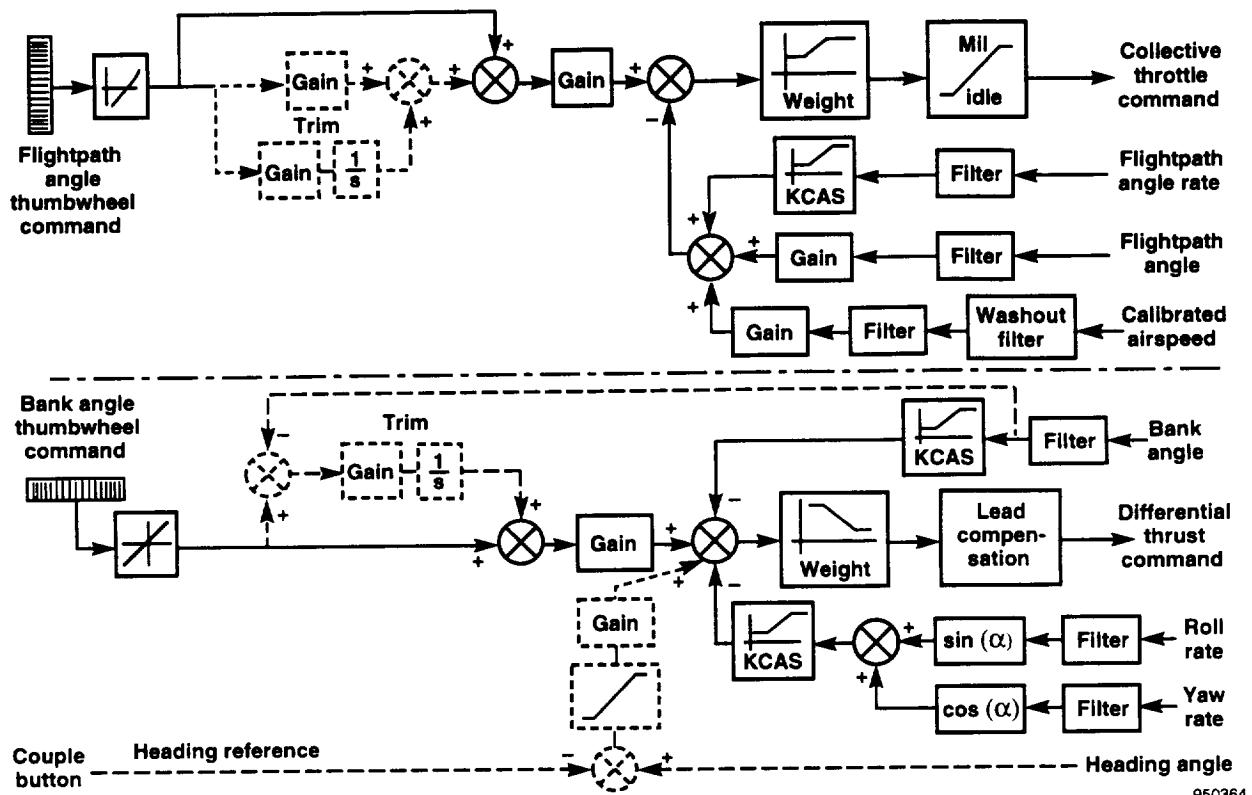
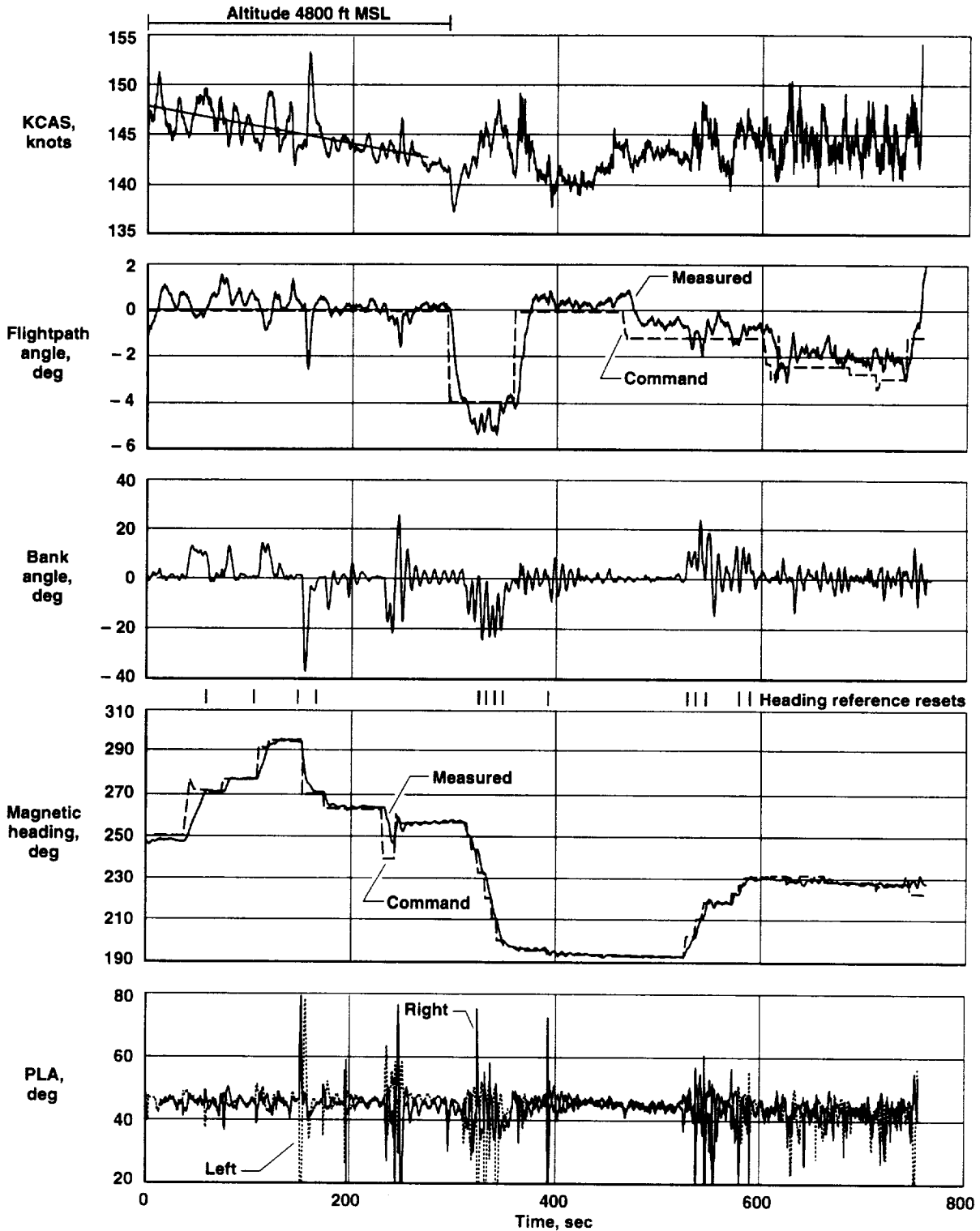

Figure 46. The F-15 PCA design and flight test envelope.



950364

Figure 47. The PCA heading control mode.



950365

(a) Entire time segment.

Figure 48. The PCA heading mode evaluation.

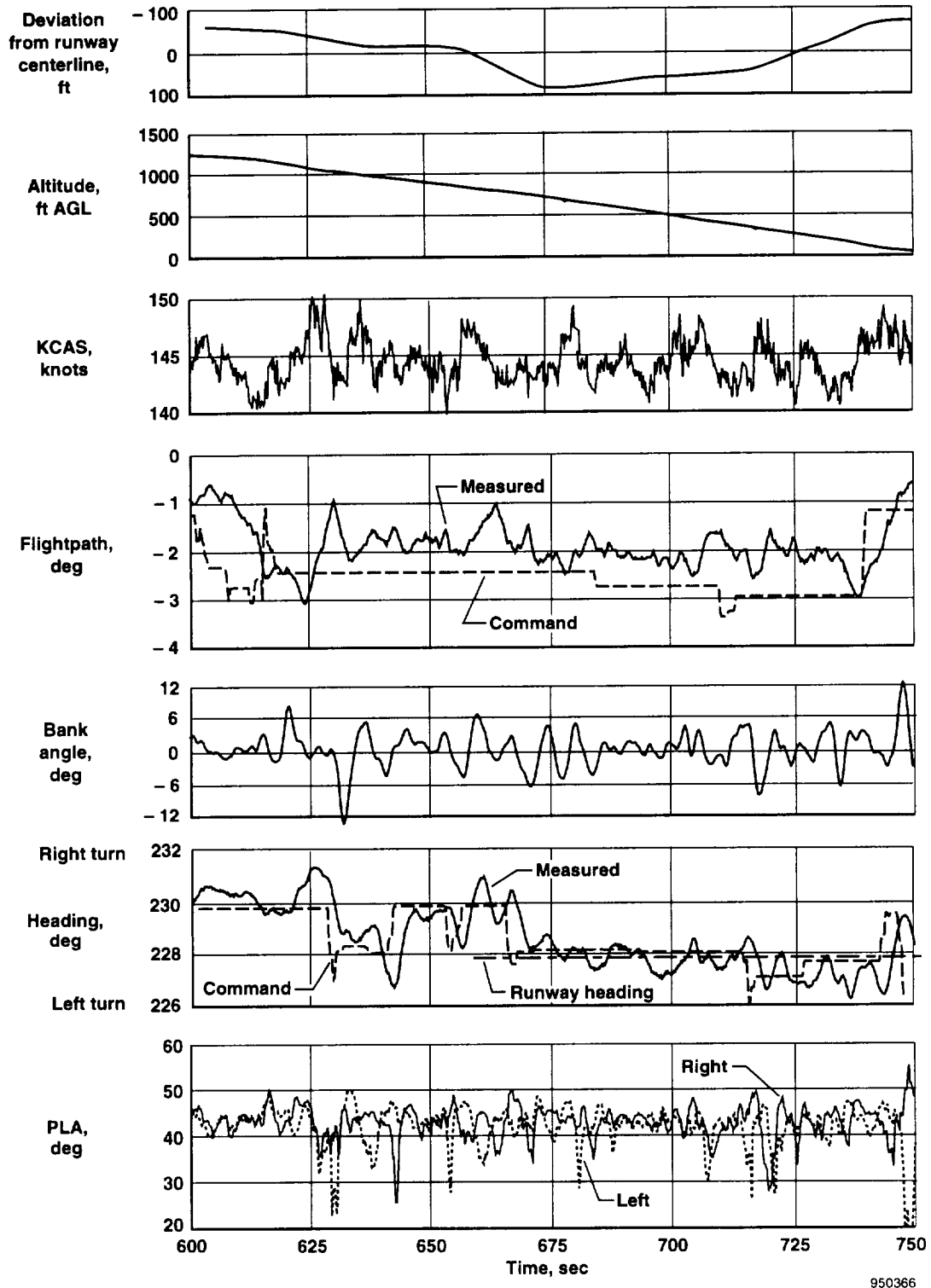

950366

(b) Final approach to 50 ft AGL.

Figure 48. Concluded.

Long periods (as much as 45 sec) passed without thumbwheel input. A crosswind component from the left existed that decreased at 200 ft AGL, and the airplane began to drift to the left. The pilot made a small right correction at $t = 725$ sec, but the drift continued. At $t = 740$ sec and 100 ft AGL, the pilot decreased the flightpath command from -3° to -1° and returned the heading thumbwheel to the detent, which turned out to be approximately a 2° right heading change.

This heading command produced a larger than desired right bank, and the pilot was unable to predict what heading would be needed to get the wings level. The pilot took over with the stick at 50 ft AGL approximately 75 ft left of and parallel to the runway centerline. Additional experience might have helped, but the pilot comment was that the heading mode was less desirable than the bank-angle mode close to the runway. One major difficulty in this implementation was that the pilot had no way of knowing what heading had been commanded.

An attempt to show the benefits of the heading mode was made using the NASA Dryden simulation. Pilot X made back-to-back PCA system approaches with simulated light-to-moderate turbulence. The task was to aggressively maintain runway alignment. Figure 49 shows the results. The PCA system approach with the usual bank-angle command required almost continuous bank-angle inputs to correct the turbulence-induced deviations from the extended centerline.

Use of the heading mode required significantly less inputs and had a much lower workload, similar to that from the flight approach (fig. 48(b)). Bank-angle excursions and throttle activity were reduced. Overall performance was adequate in both cases. Deviations from centerline were held to within ± 100 ft, and touch-downs were near the centerline. These data show that the heading mode does promise to reduce workload and should be considered for future applications of the PCA system. Use of a "track" mode might provide an even better approach guidance capability than the heading mode. "Track" was not immediately available from the F-15 inertial system but is an optional control mode on many modern transport airplanes.

Single-Engine Propulsion-Controlled Aircraft System Control Plus Rudder

Analysis of flight control system failures has shown several cases in which pitch control was lost, but roll control through rudder or ailerons was still possible. In

these cases, the PCA system could be used for flightpath control. In fact, one engine under PCA system control could be sufficient to control pitch.

To investigate this condition, an option to fly a "single engine plus rudder" mode was provided. The pilot controlled bank angle, and thus heading, with rudder. The PCA flightpath command controlled flightpath with one engine. The other engine throttle was moved to idle for the test. The only control law changes needed were to eliminate the differential thrust command and to increase the gain on the flightpath angle command.

Figure 50 shows an approach flown in this mode at 170 knots with the flaps up. Pilot A had to become familiar with this method for controlling bank angle and found strong interactions between rudder control and yaw. These interactions were caused by the single engine serving as a pitch controller. During the turn, the PCA trim had not been completed, and phugoid damping was poor. When the turn was completed, PCA trim was completed. As experience was gained, control improved. The oscillations in pitch and rudder inputs were reduced. Over the latter part of the approach, flightpath was held within 1° of command, approximately one-half of that caused by an apparent bias of 0.5° . Pitch control at 170 knots was improved because the one engine used was at high power. The inlet effect was minimal at the high inlet capture-area ratio.

The pilot was uncomfortable with this control mode because of a lack of experience and the fact that every pitch input caused a roll disturbance. In spite of these problems, the pilot maintained runway lineup to 100 ft AGL. The pilot did not feel comfortable about continuing to a runway landing. On the other hand, the pilot thought a safe landing on the lakebed could be made if precise lineup were not critical.

Another option might be to control the rudder through the bank-angle thumbwheel. This option might be able to improve control of the pitch and roll interactions and provide a stable configuration that requires less pilot familiarization. This option was not tested for this mode.

Guest Pilot Evaluation Summary

Guest pilots flew the maneuvers discussed in the Tests section (table 4). Overall comments were very favorable. All the guest pilots flew PCA system approaches to 20 ft AGL, the upset and PCA system recovery, and a throttles-only manual approach. Although the original

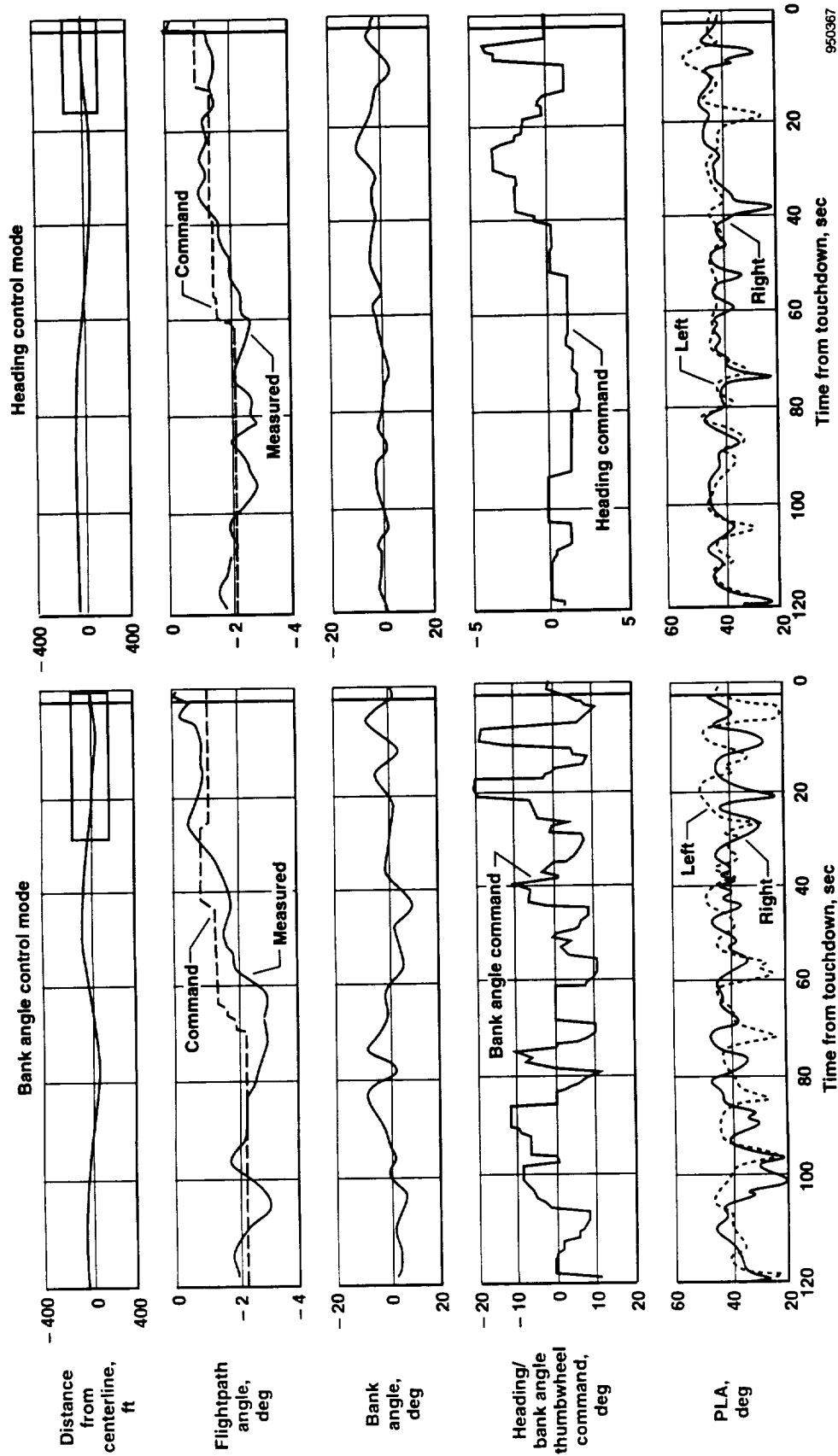
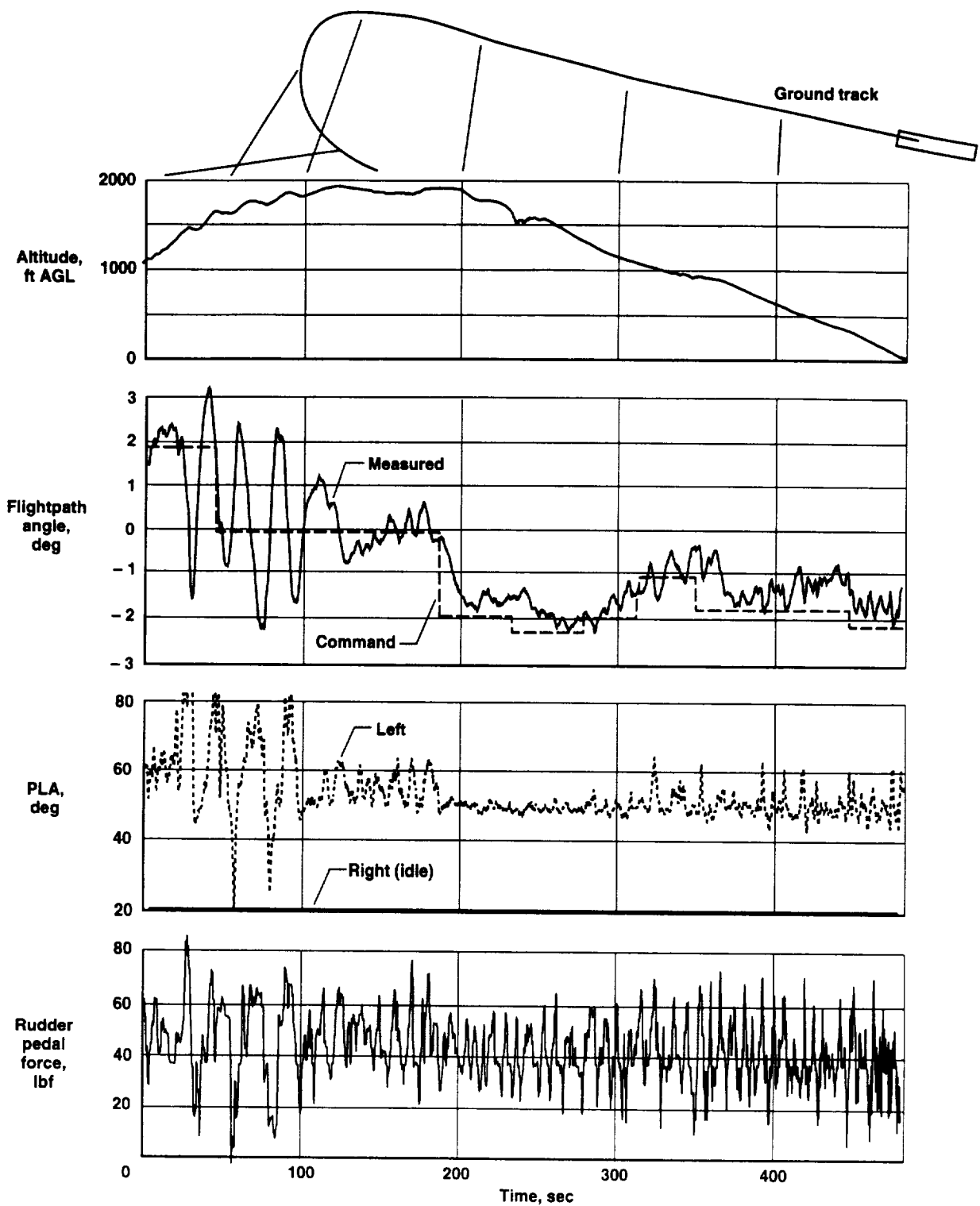

Figure 49. Simulation comparison of PCA bank-angle and heading modes approach and landing, light-to-moderate turbulence, 150 knots, flaps down. (Task: Aggressively maintain extended runway centerline alignment to touchdown.)



950368

Figure 50. The F-15 PCA single engine plus rudder mode, turn and approach for landing, 170 knots, right engine at idle, pilot A.

intent was to fly only in good weather, four of the six guest pilots flew in less than ideal weather with winds stronger than 15 knots and significant levels of turbulence. Guest pilot comments are presented in appendix B.

Overall Inlet Effect and Final Simulation Improvement

After the PCA envelope expansion was completed and an increased range of flight data was available, a reanalysis of the data was performed. The inlet effect was developed for a large range of speeds and angles of attack with flaps up and down (fig. 51). The data are for approximately trimmed level flight. That is, the high angles of attack occurred at low speeds ($\alpha \approx 10^\circ$ at 150 knots), and the low angles of attack occurred at high speeds ($\alpha \approx 3^\circ$ at 250 knots).

These data were obtained using the following method: The F100 EMD engine deck data were used to convert the *PLA* into fan airflow. From a relatively clean throttle step change, the initial *PLA* was converted into inlet capture-area ratio. Then the capture-area ratio was divided by the inlet capture airflow computed at the current true velocity. Next, this capture-area ratio and angle of attack data were plotted (fig. 51) with the *PLA* noted. The data at the end of the step change were also plotted and faired considering the variation in angle of attack during the engine thrust change. The wind-tunnel data⁸ were also plotted, using the typical F-15 aerodynamic relationship of $\Delta C_m/\alpha \approx 0.004/\text{deg}$. Sufficient increasing and decreasing throttle steps data were obtained to fair values of the *PLA* through part of the angle-of-attack envelope for the flaps-up case (fig. 51(a)) and to determine the *PLF* values of the *PLA*. The curves representing the variation of α and ΔC_m with inlet capture-area ratio ($\Delta\alpha/\Delta(A/A_c)$) were faired considering the flight and wind-tunnel data.

Less data were available for flaps down (fig. 51(b)) than for flaps up except near the 150 knot and 9° to 10° angle-of-attack range where the majority of the PCA system testing occurred. The fairings of the variation in angle of attack with inlet capture-area ratio were made from the flaps-down data supplemented with the flaps-up data where necessary.

For figures 51(a) and 51(b), the value of $\Delta\alpha/\Delta(A/A_c)$ is only valid for a given angle of attack, not for the full angles-of-attack range. The effects of the flaps are to change the angle of attack required for level flight at a

given speed and weight and to increase the drag, hence increasing the average *PLA* and inlet capture-area ratio. These data show that at the high angles of attack and high capture-area ratios, the inlet effect becomes less adverse than at the low angles of attack and capture-area ratios and possibly even favorable (positive slope). Decreasing speed at a fixed *PLA* increases angle of attack and capture-area ratio. The fact that both of these effects would result from speeds lower than 170 knots explains the improved control at 150 knots where the slope of $\Delta\alpha/\Delta(A/A_c)$ is near zero.

Some evidence of a flattening or turnaround (positive slope) in the inlet effect can also be seen in the wind-tunnel data of appendix A. This change occurred at an angle of attack of 12° and at the high values of A/A_c , although only data at one inlet ramp position, $\rho = 0^\circ$, existed.

The lift, drag, and pitching moment differences between the automatic inlets position used in the F-15 aerodynamic database and the full-up "emergency" position used in PCA system testing is a function of angle of attack and inlet capture-area ratio. When the added flight data (fig. 51) over an increased speed and angle-of-attack range were available, the wind-tunnel data⁸ could be extrapolated to provide the needed differences over the angle-of-attack range. For the nominal *PLF*, these differences were used to update figure 10(c) (appendix A).

When these updated inlet effects data (figs. 10(c) and 51) were available, the combined pitching moment effects of the emergency inlet position and inlet-airflow variation were developed. Figure 52 shows these effects for flaps down. When these data (fig. 52) were incorporated into the NASA Dryden simulation in upgrade S20, the flight-to-simulation match improved greatly. The PCA system oscillations at speeds higher than 190 knots (figs. 39 and 40) could be reproduced in the simulation although with a different period.

The observed large ground effects on landing could also be duplicated. Figure 53 shows a comparison of the simulation to the flight data of figure 37 for the first PCA system landing. Excellent agreement is seen. The ground effect causes the angle of attack to be reduced from 9° to approximately 7.5° . This angle-of-attack change causes the inlet automatic-schedule-to-emergency-position correction (fig. 10(c)) to generate additional nosedown pitching moments that reduce the angle of attack to 6.5° . At this low angle of attack, the PCA system action of increasing thrust to counter the pitchdown causes additional nosedown pitching

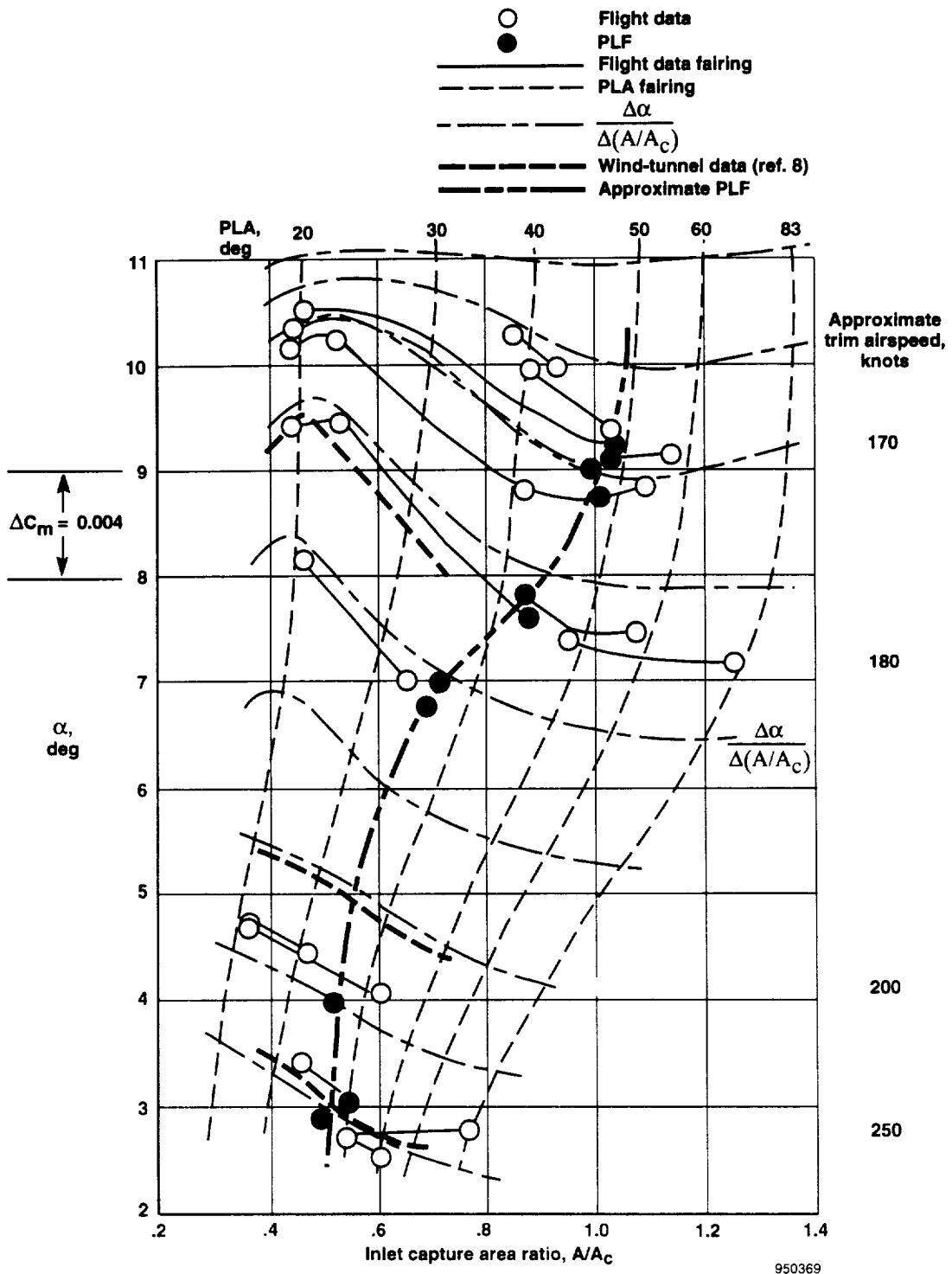

(a) Flaps up.

Figure 51. Effect of inlet capture-area ratio and α on pitching moment.

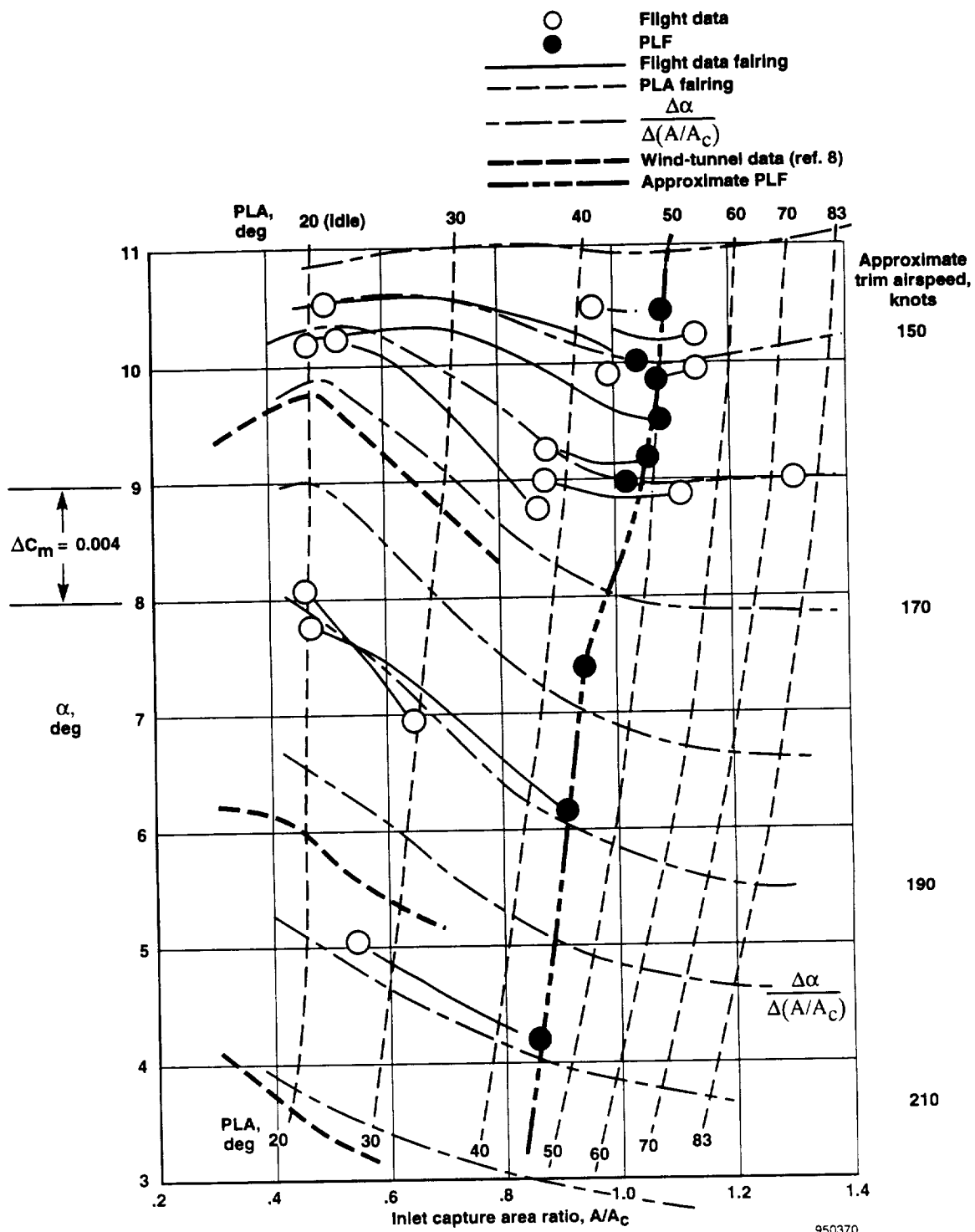

(b) Flaps down.

Figure 51. Concluded.

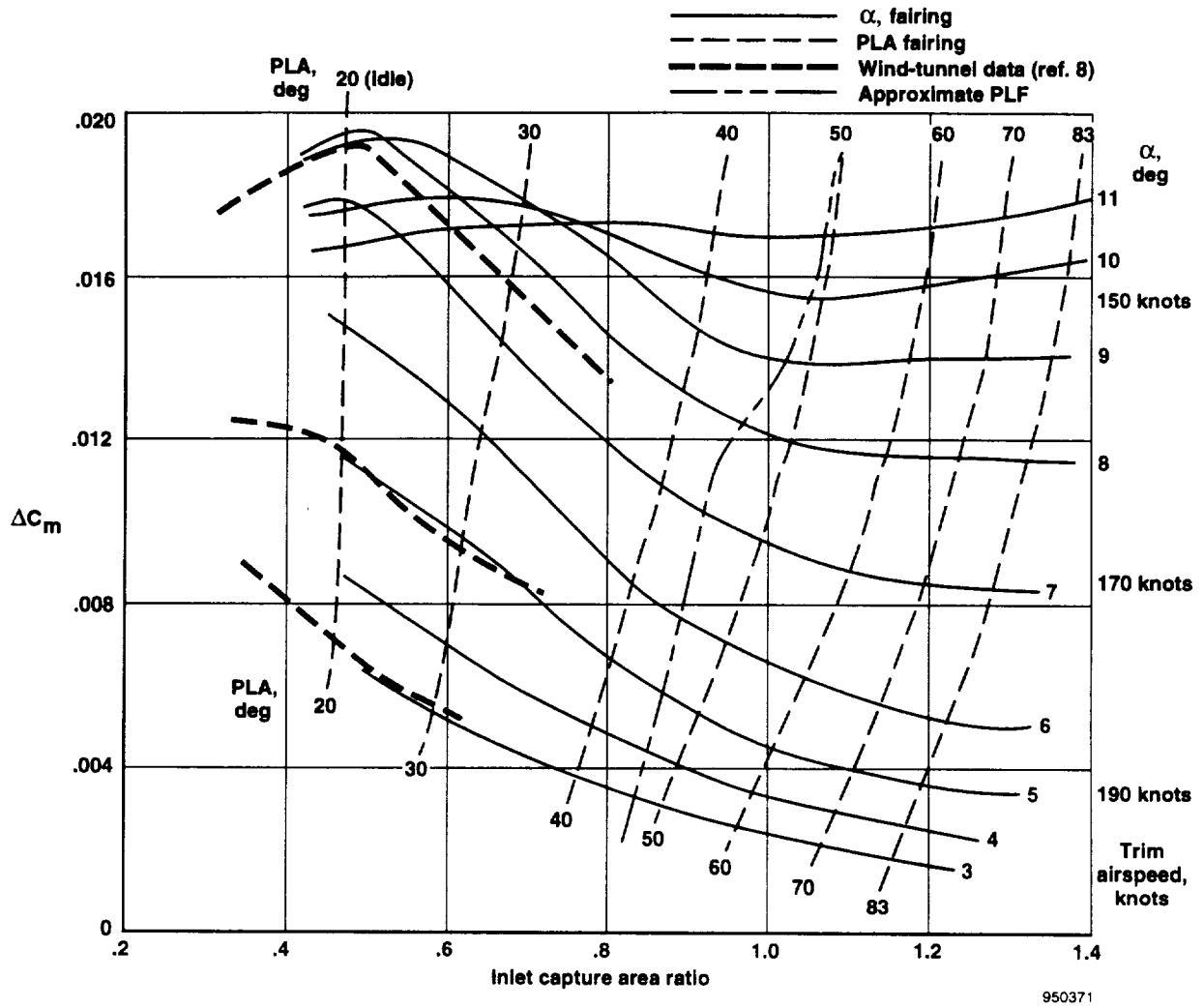

Figure 52. Combined effects of inlets emergency and airflow variation on airplane pitching moment coefficient, flaps down.

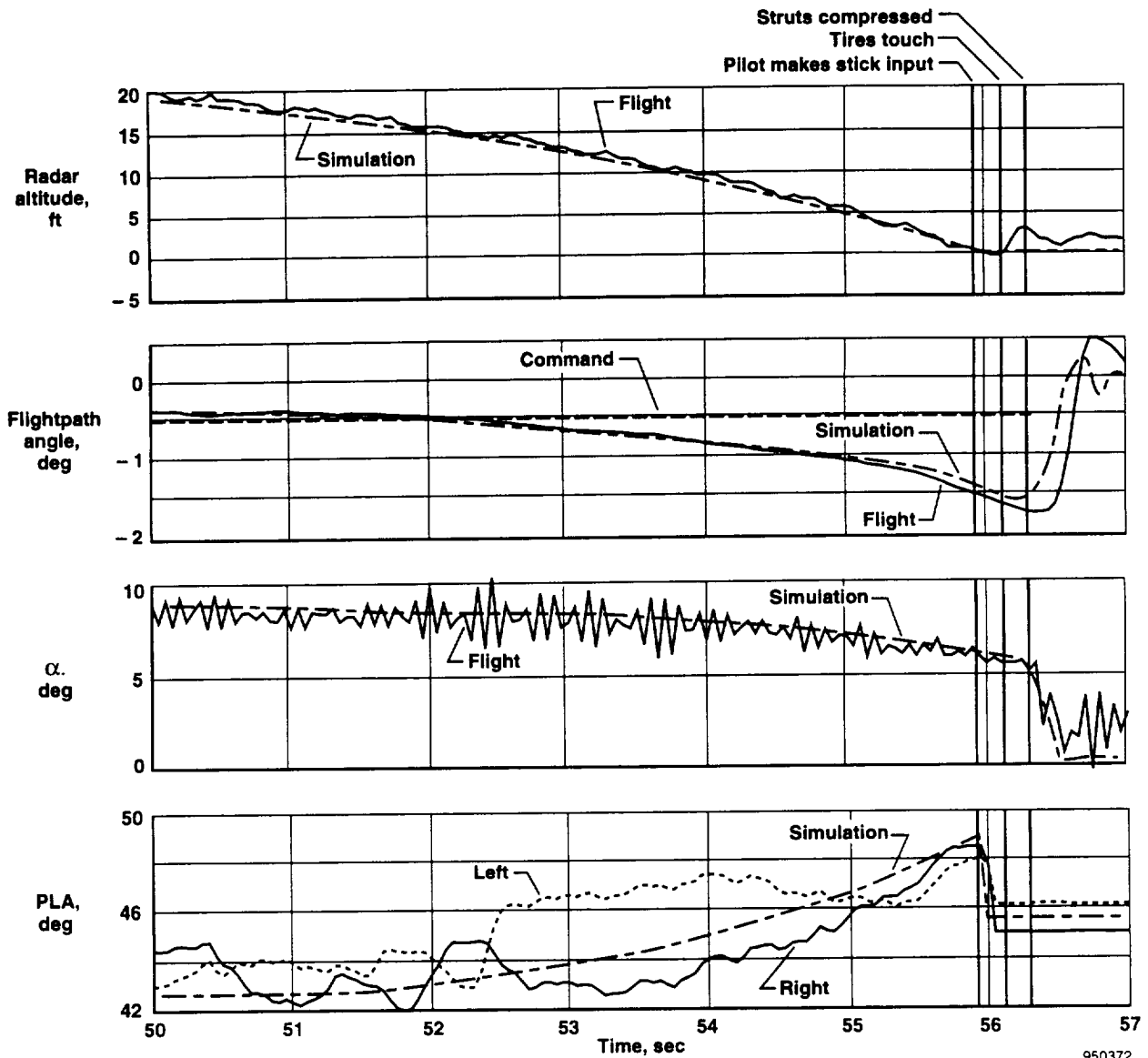

Figure 53. Comparison of final simulation to final 6 sec of PCA landing of figure 37.

moments (fig. 52). These pitching moments make the angle of attack at touchdown equal to 6° and causes the increased sink rate.

The sink rates for the two flight landings are compared to the simulation results in figure 54 for a range of sink rates. The overall result is that the touchdown sink rate is 8 ft/sec for a range of sink rates out of ground effect from 6 to 1 ft/sec. In the simulation, the effects of speeds lower than 150 knots were also evaluated. As expected, PCA system landings could be made at reduced touchdown sink rates as low as 5 ft/sec if the speed were reduced. Lateral control deteriorated because of reduced natural dutch roll damping, but it remained acceptable in the simulation down to 136 knots.

Although ground effect will be a concern for any airplane using a PCA system, the added adverse ground effects caused by the F-15 inlet effects generally should not be a factor, particularly for transport airplanes with podded engines. If it had been possible to trim the F-15 airplane at 150 knots with the inlets set to the automatic schedule, the ground effect would have decreased. The destabilizing pitching moment caused by having the

inlets in the emergency position (fig. 10(c)) would not have been present.

With the full inlet effects modeled over a complete angle-of-attack and PLA range (S20) the simulated throttles-only manual control task finally became as difficult as it is in the actual airplane. A strong pitch pilot-induced oscillation tendency was evident, and simulation landings were mostly in the unsafe range.

Figure 55 shows the final part of one of the more successful throttles-only manual approaches from the simulation. A persistent pitch oscillation is seen. Flight-path excursions ranged from 1° to -2.7° . Significant periods when the throttles were at idle power existed, just as was the case in flight (figs. 43 and 22). The touchdown rate of sink was fortuitously 8 ft/sec, but touchdown was more than 5000 ft from the threshold.

With the full inlet effects modeled, PCA system performance was evaluated and continued to be acceptable, matching the flight results well. This good match between simulation and flight was not obtained until 9 months after the first PCA system landings had been made.

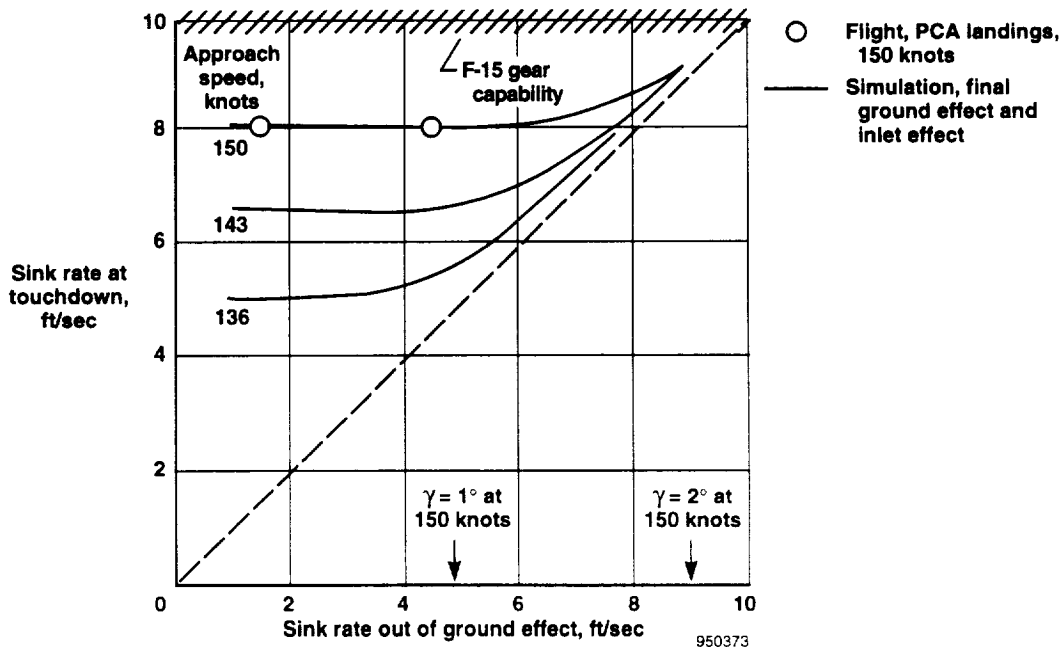

Figure 54. Comparison of flight and simulation touchdown sink rates for PCA landings.

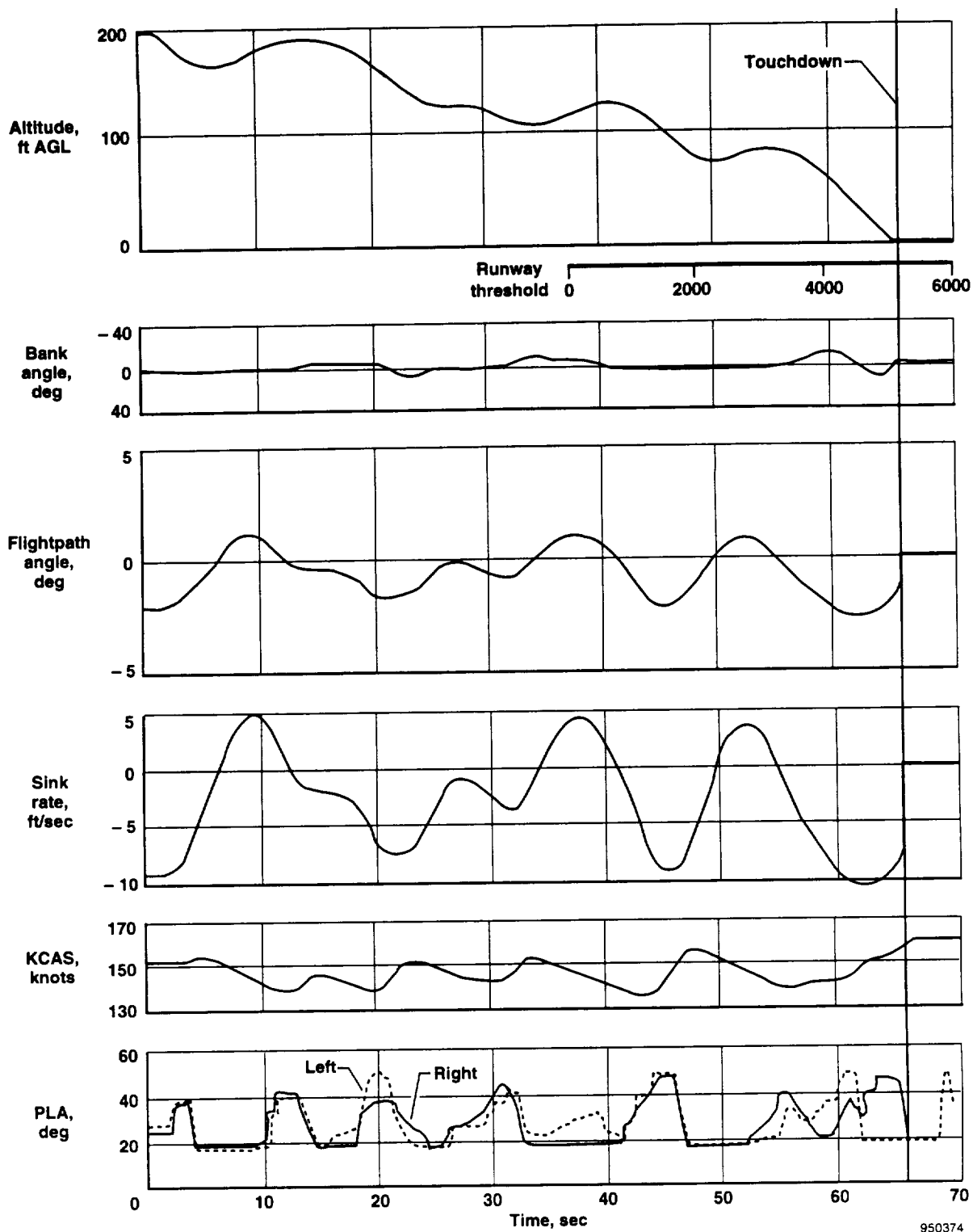

Figure 55. Manual throttles-only approach, final simulation, flaps down, pilot X.

CONCLUSIONS

A propulsion-controlled aircraft (PCA) system on an F-15 airplane has been developed and flown as part of a study of throttles-only flight control capability. For comparison, throttles-only manual approaches have also been flown. The following conclusions were made:

1. The PCA system, using computer-controlled engine thrust, provided a suitable method for emergency flight control of an airplane without any flight controls. The PCA pitch and roll control provided adequate up-and-away flight control. In addition, PCA system control was used for landings. Control was adequate for safe runway landings in good weather.
2. Pitch control was sluggish but very stable and predictable. Approximately 10 sec were required to achieve a commanded flightpath change. On approaches, the pilots tended to set the flightpath command by placing the head up display flightpath command box on the end of the runway and to make few changes.
3. Bank-angle control was positive and predictable but lagged inputs by approximately 3 sec. On approaches, the pilots spent most of their time making bank-angle corrections. A heading mode was implemented that reduced the pilot workload. However, this mode was not adequately evaluated to make any firm conclusions.
4. The guest pilots were able to use the PCA system effectively on their first flight. They liked the stable pitch control and could adapt to the roll control. These pilots were able to complete approaches to the runway that they felt could have continued to safe landings. The pitch and bank-angle thumbwheels were liked by all pilots.
5. The simulations used to develop the PCA system required extensive updates, many based on flight data, to incorporate models of many small effects that are normally ignored. Initial simulation results were overly optimistic. Fully adequate simulation-to-flight comparisons were not obtained until after the flight program was completed.
6. The most significant addition to the simulation was an inlet-airflow effect that resulted in an initial pitching motion opposite to that expected. This effect required extensive data analysis and control law development. This inlet effect was a result of the highly integrated nature of the F-15 propulsion system and would not be expected for an airplane with podded engines. Ground effect was also not properly predicted until updated dynamic ground effect data and the inlet effect were properly modeled.
7. The PCA system operated successfully well beyond the original design goals. This system operated successfully at altitudes higher than 35,000 ft and Mach numbers to 0.88. System engagements in upset conditions to a maximum 90° bank and 20° dive were successful. These results show that the PCA system has a good chance for recovering airplanes from flight control system failures if the flight controls fail in a condition in which engine forces and moments have adequate authority to achieve controlled flight.
8. Throttles-only manual control is possible for up-and-away flying. However, this control cannot make a safe landing for an airplane with the low natural stability and adverse inlet-airflow effect of an unaugmented F-15 airplane.
9. The F-15 airplane flown with the control augmentation turned off has sufficiently poor stability and flying qualities to make it a very challenging application for the PCA system. The F-15 PCA system succeeded in stabilizing such a difficult airplane. This success indicates that more stable airplanes, such as large transports, should have better, or at least equal, success than the F-15 airplane had with the PCA system.
10. The flexible flight software that permitted changes in gains, constants, sensitivities, and control modes was crucial for rapidly improving a poor control system into one that substantially exceeded the project goals in a short flight program.
11. The ground effect had an adverse effect on F-15 PCA system landings, making the touchdown sink rate 8 ft/sec for a range of sink rates from

1 to 6 ft/sec out of ground effect. On the F-15 airplane, the ground effect was exacerbated by the adverse inlet-airflow effect. This adverse effect should not occur on a transport airplane.

12. The PCA system controlled the F-15 airplane with no flight control surface motion for periods that exceeded 10 minutes on many occasions. This capability might be of interest for an application where control surface deflections would need to be minimized in order to reduce radar return.

LESSONS LEARNED

1. The flight evaluation was crucial in maturing PCA technology. Before the flight program, a great deal of doubt existed that computer-controlled engine thrust could be used to safely land an airplane with no flight controls. Repeatability was also questioned. In addition, doubt existed that such landings could be accomplished without extensive training.
2. Initial simulation results were overly optimistic. Extensive interactive flight and simulation work was required to match simulation to flight.
3. Digital integrated engine and flight control technology is sufficiently precise to provide stabilization and control and is adequate for

landing an airplane with low natural stability and no flight control system.

4. Throttles-only manual control was incapable of providing safe landings for the F-15 airplane, even when the pilots had extensive study and practice.
5. The inlet-airflow effect was very small and would often be neglected in an airplane simulation. However, when the only moments being used for control are the small moments from the propulsion system, normally neglected effects may become significant. This observation is particularly true for aircraft with highly integrated propulsion systems, such as fighters where inlet and airframe interactions are strong. This observation would likely be less true for subsonic airplanes with podded engines, where the inlets tend to be simple pitot inlets normal to the flow.
6. Experience not only indicates that large transport and bomber airplanes have better throttles-only manual control capability than the F-15 airplane but also that safe landings are still most unlikely without extensive practice.

*NASA Dryden Flight Research Center
National Aeronautics and Space Administration
Edwards, California, March 20, 1995*

REFERENCES

- ¹Burcham, Frank W., Jr., Maine, Trindel A., Fullerton, C. Gordon, and Wells, Edward A., *Preliminary Flight Results of a Fly-By-Throttle Emergency Flight Control System on an F-15 Airplane*, NASA TM-4503, 1993.
- ²Burcham, Frank W., Jr., and Fullerton, C. Gordon, *Controlling Crippled Aircraft—With Throttles*, NASA TM-104238, 1991.
- ³Dornheim, Michael A., "Research Pilot Devises Rules of Thumb for Engine-Only Control of Disabled Aircraft," *Aviation Week and Space Technology*, June 24, 1991, p. 43.
- ⁴Gilyard, Glenn B., Conley, Joseph L., Le, Jeanette L., and Burcham, Frank W., Jr., "A Simulation Evaluation of a Four-Engine Jet Transport Using Engine Thrust Modulation for Flightpath Control," AIAA-91-2223, June 1991.
- ⁵Bull, John, et al., *Piloted Simulation Tests of Propulsion Control as Backup to Loss of Primary Flight Controls for a Mid-Size Jet Transport*, NASA TM-110374, 1995.
- ⁶Gerren, Donna S., *Design, Analysis and Control of a Large Transport Aircraft Utilizing Engine Thrust as a Backup System for the Primary Flight Controls*, NASA CR-186035, 1995.
- ⁷Burcham, Frank W., Jr., Maine, Trindel, and Wolf, Thomas, *Flight Testing and Simulation of an F-15 Airplane Using Throttles for Flight Control*, NASA TM-104255, 1992.
- ⁸Kamman, J.H. and Wallace, H.W., *Assessment of Installed Inlet Forces and Inlet/Airframe Interactions*, AFFDL-TR-76-62, July 1976.
- ⁹Wells, Edward A. and Urnes, James M., Sr., *Design and Flight Test of the Propulsion Controlled Aircraft (PCA) Flight Control System on the NASA F-15 Test Aircraft*, NASA CR-186028, 1994.
- ¹⁰Stewart, James F., Burcham, Frank W., and Gatlin, Donald H., *Flight-Determined Benefits of Integrated Flight-Propulsion Control Systems*, NASA TM-4393, 1992.
- ¹¹Burcham, F., Jr., Fullerton, C., Gilyard, G., Wolf, T., and Stewart, J., "A Preliminary Investigation of the Use of Throttles for Emergency Flight Control," AIAA-91-2222, June 1991.
- ¹²Fullerton, C. Gordon, "Propulsion Controlled Aircraft Research," *37th Symposium Proceedings*, The Society of Experimental Test Pilots, Sept. 1993, pp. 78-88.
- ¹³Corda, Stephen, Stephenson, Mark T., Burcham, Frank W., and Curry, Robert E., *Dynamic Ground Effects Flight Test of an F-15 Aircraft*, NASA TM-4604, 1994.
- ¹⁴Maine, Trindel, Schaefer, Peter, Burken, John, and Burcham, Frank, "Design Challenges Encountered in a Propulsion-Controlled Aircraft Flight Test Program," AIAA-94-3359, June 1994.

APPENDIX A

WIND-TUNNEL INLET-AIRFLOW VARIATION DATA

Wind-tunnel data from a 7.5-percent model of the F-15 airplane had previously been obtained.⁸ For these tests, inlet capture-area ratio was varied over a range of angles of attack, first-ramp angles, and Mach numbers. The lowest Mach number tested was 0.6. Inlet and overall aircraft lift, drag, and pitching moment were measured.

Figures A-1(a) through A-1(e) show the effect of inlet capture-area ratio on airplane lift coefficient, drag

coefficient, and pitching moment coefficient for a range of inlet cowl angles. These results show the wind-tunnel data and extrapolations and interpolations used to develop the effects of the emergency inlet operation (fig. 10(c)). The inlets data at $\rho = -4^\circ$ (the "emergency" position) and the interpolated data for automatic scheduling are shown. These data were also used to help develop the effects of power setting variation on the aircraft pitching moments (fig. 51 and 52).

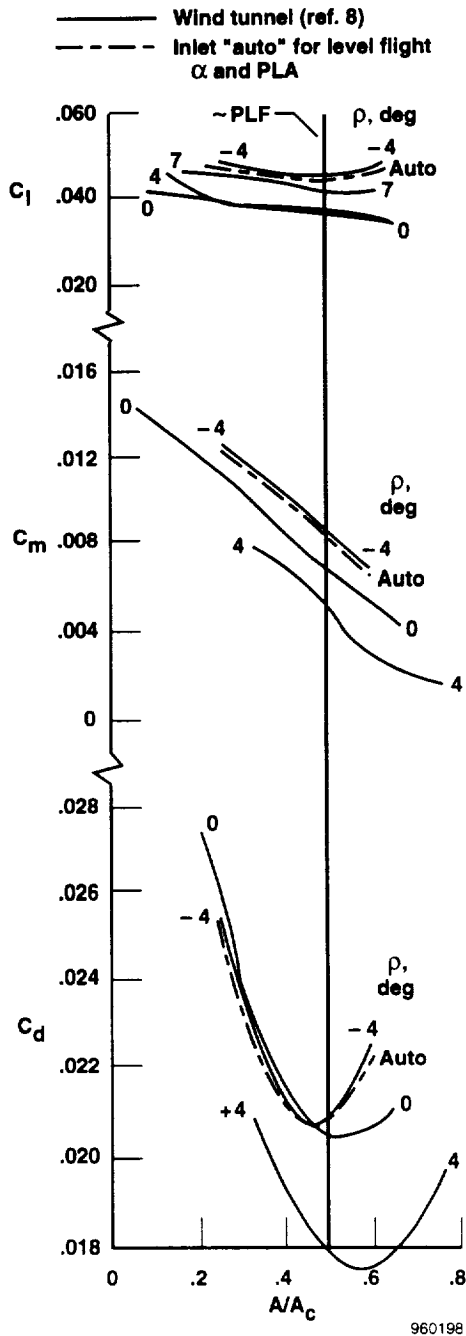

(a) $\alpha = 0$, $\rho_A = -4^\circ$.

Figure A-1. The 7.5 percent wind-tunnel data of reference 8, $M = 0.6$, total aircraft coefficients.

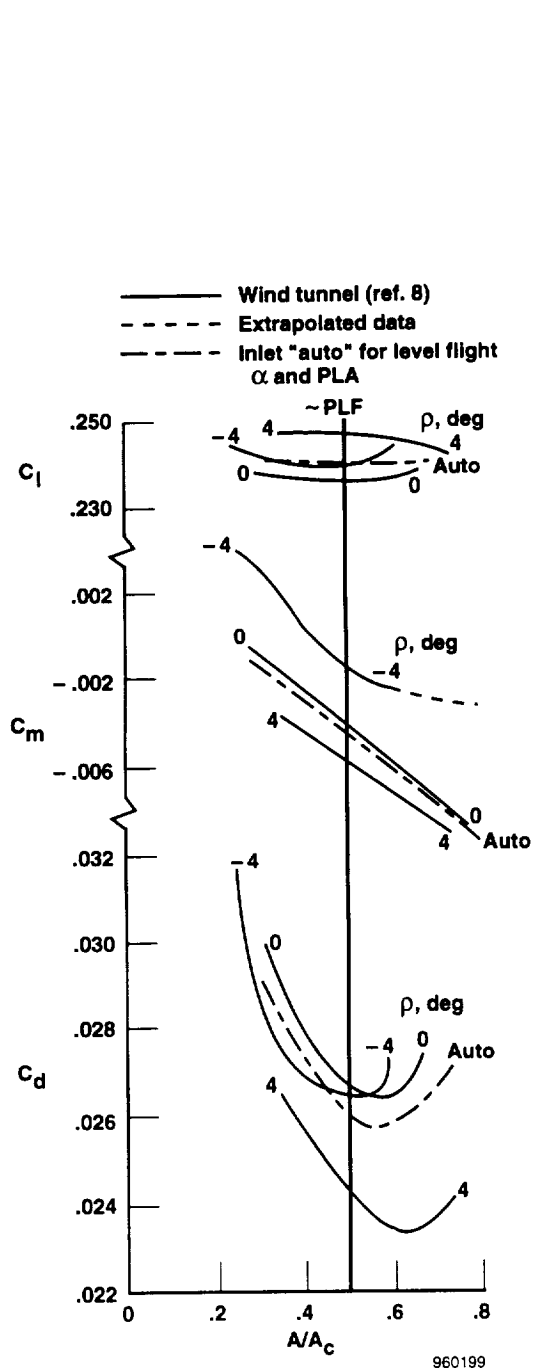

(b) $\alpha = 3^\circ$, $\rho_A = 1.4^\circ$.

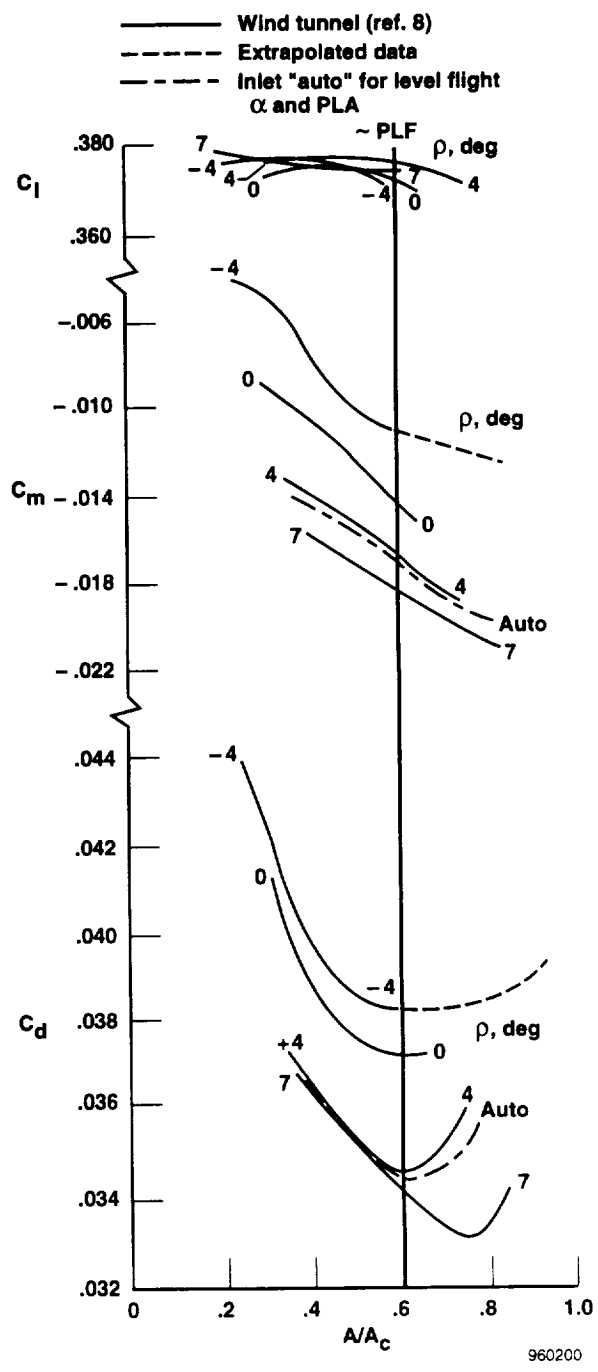

(c) $\alpha = 5^\circ$, $\rho_A = 4.7^\circ$.

Figure A-1. Continued.

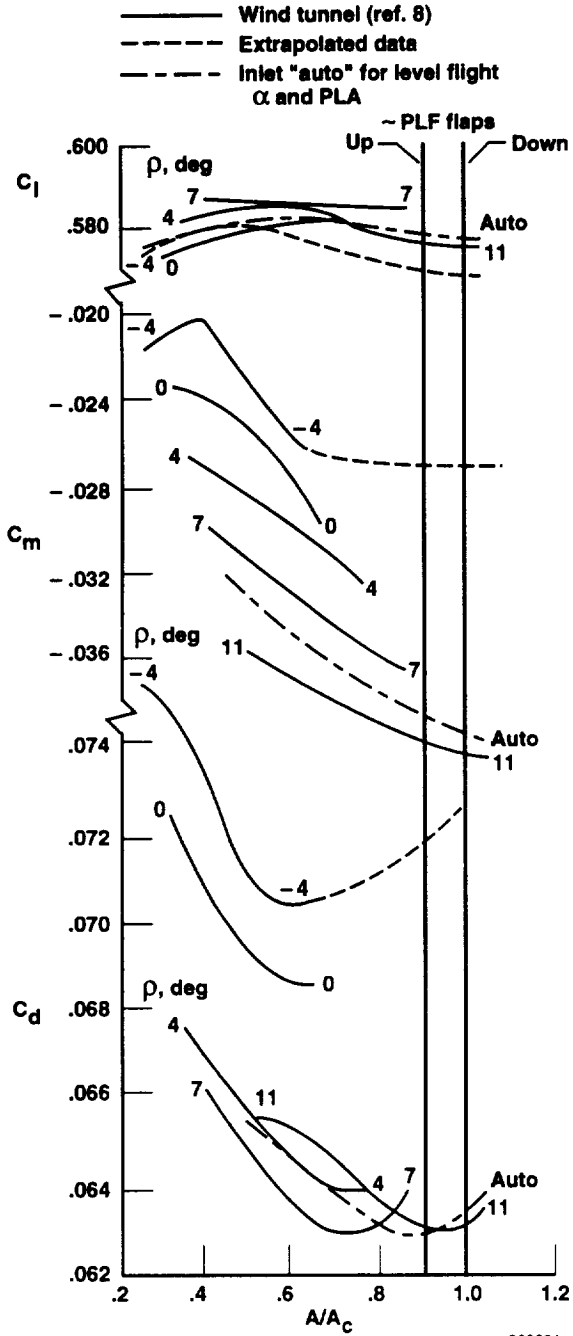

(d) $\alpha = 8^\circ$, $\rho_A = 9.5^\circ$.

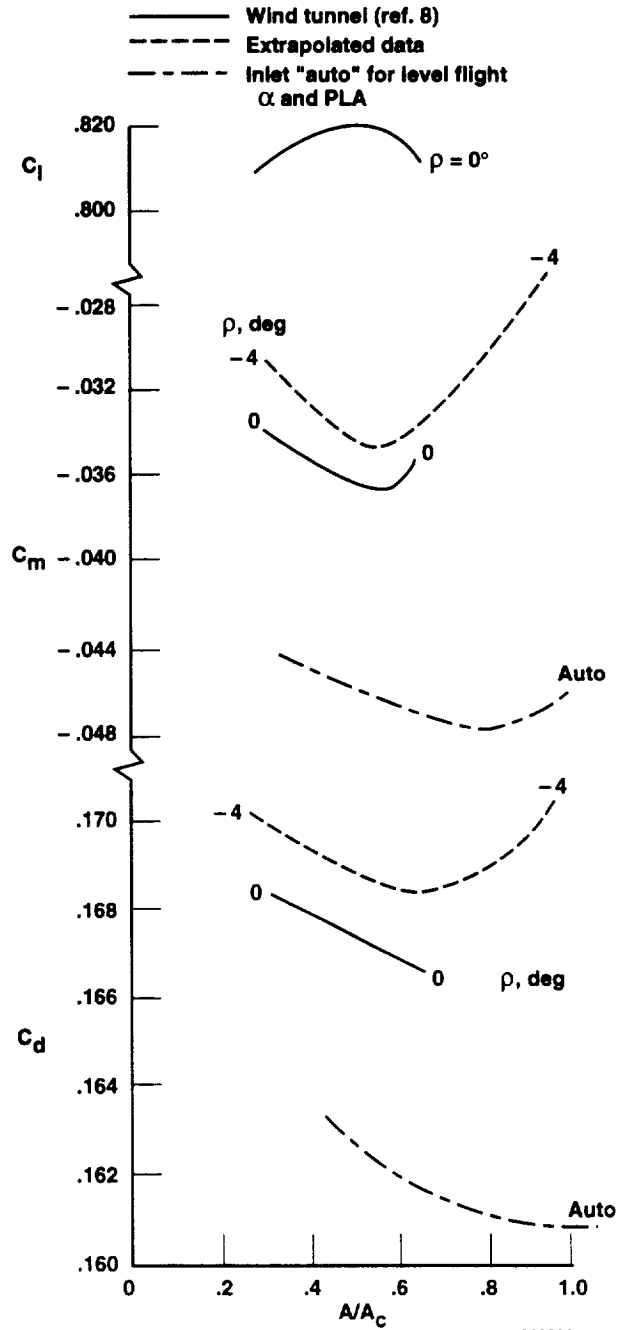

(e) $\alpha = 12^\circ$, $\rho_A = 11^\circ$, $\rho = 0^\circ$.

Figure A-1. Concluded.

APPENDIX B

GUEST PILOT COMMENTS

The propulsion-controlled aircraft guest pilots were all test pilots; their comments and recommendations for added features are presented here. The comments of the PCA project pilot have previously been reported.¹²

EXCERPTS FROM GUEST PILOT G

The flight was flown in the morning, but a significant crosswind and light turbulence existed. After takeoff, pilot G flew the basic airplane CAS-off card. As expected, the airplane had poor stability, had very light damping, rolled off quickly, was hard to trim, and was sluggish because of high stick forces.

When the PCA system was turned on, the pilot's comment was "PCA flies the airplane really well. The thumbwheel concept is good, and the gains are just right." On the first approach, pilot G commented that "the airplane was real stable. I was surprised at how well the PCA held glideslope. The roll response was really good."

On the PCA system go-around, the airplane was at a -3° glideslope at 100 ft AGL, but the pilot put in a big noseup command. The comment was "I was confident of the go-around, which bottomed out 60 ft above the ground." On the next approach to 50 ft AGL, the pilot had a very nice approach going and said, "I think you could get the airplane on the ground from this approach in spite of the crosswind."

The pilot then did the simulated hydraulic failure upset at an altitude of 10,000 ft, with a 90° bank and 20° dive, and engaged the PCA system. The system rolled out aggressively, pulled approximately 3 g in the pull-out, and recovered nicely to level flight. The pilot accidentally bumped the stick, which disengaged the system. This action prevented a full PCA system descent and approach, but the pilot had no doubts that the test could have been completed.

Then pilot G tried a throttles-only manual approach, and, like all the guest pilots, had no success at all. The pilot did manage to get the runway in sight but had to use the stick occasionally to maintain control.

EXCERPTS FROM GUEST PILOT H

The PCA system flown in the HIDECA F-15 airplane was evaluated as a highly effective backup recovery system for aircraft that totally lose conventional flight controls. The system was simple and intuitive to use and would require only minimal training for pilots to learn to use effectively. Of course, landing using the PCA system would require higher workloads than normal, but this pilot believes landings could be done safely. The fact that the system provides a simple, straight-forward, go-around capability that allows multiple approaches further supports its safe landing capability. The dutch-roll suppression characteristics of the system were extremely impressive to the pilot and would allow landings to be done even in nonideal wind conditions. The pilot thought the PCA system exhibited great promise and, if incorporated into future transport aircraft, could further improve the safety of the passenger airlines.

Control Augmentation System-Off Control

Shortly after takeoff, the aircraft was placed in the powered-approach configuration while flying straight and level at an altitude of 6200 ft mean sea level (m.s.l.). Pilot workload in the CAS-off mode was high, and control precision was marginal. The F-15 airplane felt sluggish in pitch and roll and was difficult to trim. The airplane felt like a "heavier" aircraft because of slow response to pilots inputs and heavy stick forces. The pilot had to shape or lead inputs to capture desired bank or pitch angles. Rudder doublets excited a moderately damped dutch roll.

Manual Throttles-Only Control

Overall controllability was adequate with throttle manipulation. Bank-angle control was intuitive and fairly easy to accomplish. Collective throttle movement

provided marginally adequate pitch-angle control in the F-15 airplane. Controlling one axis at a time was not too difficult, but maintaining simultaneous control of pitch and roll required all of the pilot's attention. Overall, throttles-only manual control would probably allow the pilot to return to friendly territory, but pilot fatigue and task saturation could occur. The PCA system control and approach tests are described next.

Control

The PCA system provided satisfactory control of pitch and roll axes. Bank-angle capture was generally good with an approximately 2° oscillation about the desired bank angle. This oscillation was likely caused by turbulence or gust response because dutch roll appeared to be well-damped by the PCA system.

Flightpath angle captures were successful using the pitch thumbwheel to position the HUD flightpath command box. Overall, the pilot was impressed with the capability of the PCA system and the reduction in pilot workload it afforded. A pilot could easily accomplish several other tasks while flying the aircraft in this mode.

Approach to 200 ft Above Ground Level

Pitch control was outstanding, which allowed the pilot to work almost exclusively in the roll axis. Pilot workload in roll was high; however, the workload could have been significantly reduced if a "heading hold" feature was incorporated. Overall pilot confidence in the PCA system during this first approach was high.

Recovery from Unusual Attitude and Descent to Approach to 20 ft Above Ground Level

This point was entered at 260 knots calibrated airspeed (KCAS) and an altitude of 10,200 ft m.s.l. The gear and flaps were up, and the inlets were in the automatic scheduling mode. The CAS was off, and pitch and roll ratios were in the emergency position. The aircraft was then maneuvered to 90° left wing down and 10° nosedown. Next, the pilot positioned the inlets to the emergency position to simulate hydraulic failure and engaged the PCA system. The nose continued to drop until the wings leveled approximately 5 sec later. Maximum airspeed during the pullout was 360 KCAS. After

two phugoid cycles, the oscillatory motion was damped by the PCA system. In addition, the aircraft stabilized at 150 KCAS.

A straight-in approach was flown to runway 22 in winds at a magnetic heading of 280° and a speed of 10 knots in light turbulence. Aggressive roll thumbwheel action resulted in good lineup control. One item of concern was a slight pitchdown that occurred as the airplane passed 30 ft AGL. This pitchdown appeared to be similar to the ground effect-induced pitchdown encountered on the initial PCA system landings conducted by NASA pilots.

Overall, the ability of the PCA system to recover the aircraft from an unusual attitude at 260 KCAS and then provide satisfactory approach control at a trim airspeed of 150 KCAS was impressive.

Manual Throttles-Only Approach to 200 ft Above Ground Level

This straight-in approach was flown to runway 22 in winds at a magnetic heading of 280° and a speed of 8 knots in light turbulence. The F-15 manual mode (throttles only, no augmentation) was unacceptable for flying a safe or repeatable approach to landing.

Conclusions

Overall, the PCA concept demonstrates good potential for use as a backup flight control system for tactical naval aircraft. The system provides adequate control authority for the F-15A airplane and enables repeatable, safe approaches without the use of conventional mechanical flight controls. The pilot was impressed with the ability of the system to precisely control bank and flightpath angles. Pilot workload throughout the PCA-coupled approaches was low relative to the throttles-only manual approach. This low workload was convincing testimony to the value of the PCA system. An aircraft employing the PCA system as the sole backup flight control system would be able to save considerable weight by eliminating typical hydromechanical backups.

EXCERPTS FROM GUEST PILOT C

The evaluation was flown in clear weather with more than 30 n. mi. visibility. Winds were at magnetic

heading of 240° at a speed of 18 knots gusting to 26 knots. All approaches were flown to runway 22.

Control Augmentation System–Off Control

With the CAS off, the aircraft responded sluggishly in all axes. In addition, fine-tracking tasks were difficult to complete, and the completed task only marginally adequate.

Throttles-Only Manual Control

Throttles-only manual flight was extremely difficult, if not impossible, without a large amount of training. The major problem was controlling the phugoid in pitch. The anticipation required to achieve such control was monumental. Using differential thrust to control roll was marginal at best, and it was fairly easy to use the wrong throttle when trying to control bank. The throttles-only manual flight condition was unsatisfactory and would not be recommended for use in any ejection-seat-equipped aircraft.

Propulsion-Controlled Aircraft System Control

The airplane responded adequately to all inputs commanded by the pilot. Pitch and roll response were very sluggish, yet always consistent and, therefore, predictable. The phugoid was suppressed by the system and was not noticeable except when making large changes in pitch. The dutch roll was well-controlled by the system. Generally, the system provided excellent flightpath stability and good control of the aircraft without being overly sensitive to gusts.

Unusual Attitude Recovery

The airplane was flown with the CAS off, at 250 KCAS and at an altitude of 10,000 ft m.s.l., to a -10° flightpath angle and then banked to approximately 75°. When this attitude was achieved, the flight controls were released, the inlets were selected to the emergency position, and the PCA system was engaged. Only the PCA system was used to recover the aircraft. Initially, a level flight attitude was selected at the thumbwheels. The aircraft pitched up and basically entered the phugoid mode,

slowing down in the climb. Right bank was selected with the thumbwheels to aid the nosedrop and minimize the airspeed bleed off. While on the downswing of the phugoid motion, the gear and flaps were extended. This action was accomplished on the descending portion of the phugoid to minimize the effects of the increased pitching moment caused by flap extension. Unusual attitude recovery was easy and effective using the PCA system controls, and at no time was the pilot concerned about the aircraft position because of PCA system performance.

Instrument Descent

Two instrument descents were flown during the flight evaluation. The pitch response was solid. At this point, flightpath and speed stability were also good. The aircraft performance during these maneuvers was similar to those observed in basic autopilots capable of speed and attitude hold.

Final Approach

Four approaches were attempted with the full PCA system. A visual approach to a safe position from which to land was consistently achieved using the PCA system.

Go-Around

A go-around using the PCA system was completed during the PCA system approach to 100 ft AGL. The PCA system allowed a timely and safe go-around without requiring undue pilot effort or skill.

EXCERPTS FROM GUEST PILOT E

This flight was an evaluation flight of the F-15 PCA system. The weather was good, winds were light, and little or no turbulence existed.

After takeoff and a climb to an altitude of 7500 ft m.s.l., a short pilot evaluation was flown with the airplane in the landing configuration, with inlets in the emergency position, and with the CAS off. Pitch and roll ratios were also in the emergency position. Trim speed was 150 KCAS. This evaluation “warmed up” the pilot for throttles-only flying by allowing exposure to a

degraded landing configuration. In addition, the evaluation was useful in demonstrating the somewhat sluggish and imprecise basic handling of the un-augmented F-15 airplane.

Throttles-Only Manual Control

Before approaches with the PCA system engaged, an up-and-away evaluation was flown with manual throttle control. Up-and-away manual control of heading and changes in vertical flightpath were achieved with a high degree of pilot workload. Many rapid, large, symmetric and asymmetric throttle movements were necessary, few of which seemed intuitive. A satisfactory, yet imprecise, job of up-and-away control was accomplished providing that corrections were made in a single axis. A large effort was required to damp the phugoid motion. In addition, small precise throttle movements were hindered by the very large amounts of throttle friction. A throttles-only manual approach was flown but aborted at less than 1000 ft AGL when pitch control was lost during an attempt to make a lineup correction to the runway.

Coupled Approaches

Engaging the PCA system and flying with it for several minutes provides a remarkable contrast to using throttles-only manual control. Steep bank angles (25°) can be flown with full confidence, and precise ($\pm 1^\circ$) heading and flightpath angle changes can be performed. Pilot confidence in their ability to conduct an approach increases greatly. The tendency toward a very flat glideslope well before the threshold was finally corrected on the third approach. The correction required aggressively, yet smoothly, driving the velocity vector in pitch by overdriving the command box. Then, some of the commanded input was taken out when the velocity vector neared the desired position. Laterally, a series of nearly constant small corrections was required to maintain heading.

Coupled Waveoff

On the second approach to 100 ft AGL, a go-around was initiated using only the PCA pitch thumbwheel. By rolling the command box to an approximately 7° noseup pitch attitude, the control system added power and flew

the aircraft away with the roundout before the climb occurred at approximately 70 ft. This maneuver was straight-forward and demonstrated another impressive system capability.

Summary

Overall, the PCA system on the F-15 airplane is a breakthrough technology that is strongly recommended for incorporation in future or current aircraft. The system gives the pilot the ability to control and safely land an aircraft that otherwise would crash or be abandoned before landing.

EXCERPTS FROM GUEST PILOT D

The weather at engine start included a scattered-cloud layer at 6000 ft, winds at a heading of 230 and a speed of 14 knots, and light turbulence from the surface to an altitude of 8000 ft. Turning all three CAS axes off and selecting the emergency position for the pitch and the roll ratios resulted in the expected: very sloppy handling characteristics. The airplane was difficult to trim in the roll and pitch axes. The pitch axis required a larger than expected amount of noseup trim to stabilize at 150 KCAS.

Once trimmed, the pilot released the control stick and attempted to maintain level flight and capture a heading by manually adjusting the throttles. Even though the air was very smooth at these 8000- to 9000-ft m.s.l. test conditions, aircraft control was very poor. The velocity vector varied $\pm 4^\circ$, and the pilot overshot the intended heading by 7° . Rather than continuing to try to fine-tune this manual control, the pilot engaged the PCA system. The immediate increase in airplane controllability was very dramatic. Small flightpath angle changes to a maximum of 2° were made very accurately, and the first heading capture attempt was only overshot by 2° .

The second PCA approach was to 100 ft AGL at 150 KCAS and an 11° angle of attack and included a PCA system-controlled go-around. During the approach, the pilot could hear the engines winding up and down, but the ride quality was quite smooth. On this approach, the pilot initially biased the airplane upwind of the runway to compensate for the crosswind. The pilot overcompensated and had to perform a sidestep to the left. That sidestep maneuver was easy to perform. The engine speed was matched for this approach, and the roll command no longer had to be biased one way or another.

Even though the overall turbulence seemed very similar to the previous approach, two or three upsets occurred that seemed larger than the previous approach and actually displaced the flightpath laterally. These upsets emphasized the observation that the pilot workload was significantly higher in the roll axis than in the pitch axis. From a -2° flightpath, pilot D used the PCA system to command a 10° flightpath angle go-around at 100 ft AGL. The minimum altitude during this go-around was 60 ft AGL. The airplane quickly started climbing, and the pilot had to aggressively command level flight to keep from climbing into conflicting traffic overhead. At the end of the maneuver, the pilot was level at an altitude of 2800 ft (500 ft AGL). All in all, the approach was very comfortable. Pilot D had good control over the aim point and had reasonably good control over the heading of the flightpath.

The third PCA system approach was flown to 50 ft AGL at 140 KCAS, then uncoupled with the PCA engage/uncouple button and then hand-flown through a CAS-off PARRE (the button is located on the right throttle) touch-and-go landing. The winds were at a heading of 230° at a speed of 19 knots gusting to 24 knots. The pilot's overwhelming conclusion from this approach was that the PCA system easily has sufficient authority and controllability for straight-in approaches and for navigational maneuvers (provided the gear and flaps are down). The presence of the velocity vector on the HUD was also a tremendous aid.

During the approach, the pilot got low and dragged in. As if that wasn't enough, the pilot also got a large upset from turbulence at approximately 250 ft AGL. At that time, the pilot made a large correction to get back on the desired flightpath. That correction bottomed out at 160 ft AGL and then peaked at 230 ft AGL. At that point, the pilot reestablished a 2.5° glideslope and continued

with the approach. Despite this large and very late correction, the only penalty suffered was the intended touchdown point shifted from 500 ft down the runway to 2000 ft down the runway. Of all the maneuvers performed during the flight, that last-minute correction impressed the pilot more than anything else. Pilot D was very pleased with the robustness and the ability of the PCA system to handle that large of a correction in such a short time.

The final approach was to 200 ft AGL at 140 KCAS using throttles-only manual control. The workload during the manual approach was extremely high. The pilot had worked up a sweat on the last [manual] approach. Approaching the runway, pilot D got behind on the pitch corrections, and the flightpath angle ballooned to 6° . The subsequent pitchdown correction dropped to -7° . The pilot still did not have this large pitch change under control using the throttles alone, so as the flightpath angle started passing up through level flight, the pilot took over manually at 200 ft AGL. This manual approach was not landable.

Summary

From the ground training and the demonstration profile to the PCA control law implementation, this PCA system demonstration was very well-done. More than simply a proof-of-concept demonstrator, this flight exhibited capabilities that would enhance the survivability of aircraft. As long as aircraft have failure modes where the ability to fly the airplane with the control stick or yoke may be lost, this pilot would like to have the backup capability demonstrated by the PCA system.

REPORT DOCUMENTATION PAGE

Form Approved
OMB No. 0704-0188

Public reporting burden for this collection of information is estimated to average 1 hour per response, including the time for reviewing instructions, searching existing data sources, gathering and maintaining the data needed, and completing and reviewing the collection of information. Send comments regarding this burden estimate or any other aspect of this collection of information, including suggestions for reducing this burden, to Washington Headquarters Services, Directorate for Information Operations and Reports, 1215 Jefferson Davis Highway, Suite 1204, Arlington, VA 22202-4302, and to the Office of Management and Budget, Paperwork Reduction Project (0704-0188), Washington, DC 20503.

1. AGENCY USE ONLY (Leave blank)		2. REPORT DATE September 1996	3. REPORT TYPE AND DATES COVERED Technical Paper	
4. TITLE AND SUBTITLE Development and Flight Evaluation of an Emergency Digital Flight Control System Using Only Engine Thrust on an F-15 Airplane			5. FUNDING NUMBERS WU 533-02-31	
6. AUTHOR(S) Frank W. Burcham, Jr., Trindel A. Maine, C. Gordon Fullerton, and Lannie Dean Webb				
7. PERFORMING ORGANIZATION NAME(S) AND ADDRESS(ES) NASA Dryden Flight Research Center P.O. Box 273 Edwards, California 93523-0273			8. PERFORMING ORGANIZATION REPORT NUMBER H-2048	
9. SPONSORING/MONITORING AGENCY NAME(S) AND ADDRESS(ES) National Aeronautics and Space Administration Washington, DC 20546-0001			10. SPONSORING/MONITORING AGENCY REPORT NUMBER NASA TP-3627	
11. SUPPLEMENTARY NOTES				
12a. DISTRIBUTION/AVAILABILITY STATEMENT Unclassified—Unlimited Subject Category 08			12b. DISTRIBUTION CODE	
13. ABSTRACT (Maximum 200 words) A propulsion-controlled aircraft (PCA) system for emergency flight control of aircraft with no flight controls was developed and flight tested on an F-15 airplane at the NASA Dryden Flight Research Center. The airplane has been flown in a throttles-only manual mode and with an augmented system called PCA in which pilot thumbwheel commands and aircraft feedback parameters were used to drive the throttles. Results from a 36-flight evaluation showed that the PCA system can be used to safely land an airplane that has suffered a major flight control system failure. The PCA system was used to recover from a severe upset condition, descend, and land. Guest pilots have also evaluated the PCA system. This paper describes the principles of throttles-only flight control; a history of loss-of-control accidents; a description of the F-15 airplane; the PCA system operation, simulation, and flight testing; and the pilot comments.				
14. SUBJECT TERMS Emergency flight control, F-15 airplane, Flight control systems, Propulsion-controlled aircraft, Propulsive control, Throttle-only control			15. NUMBER OF PAGES 106	
			16. PRICE CODE AO6	
17. SECURITY CLASSIFICATION OF REPORT Unclassified	18. SECURITY CLASSIFICATION OF THIS PAGE Unclassified	19. SECURITY CLASSIFICATION OF ABSTRACT Unclassified	20. LIMITATION OF ABSTRACT Unlimited	