

Utah State University

DigitalCommons@USU

Reports

Utah Water Research Laboratory

January 1975

Development of a Management Framework of the Great Salt Lake

J. Paul Riley

Calvin G. Clyde

William J. Grenney

Yacov Y. Haimes

Craig T. Jones

Follow this and additional works at: https://digitalcommons.usu.edu/water_rep



Part of the [Civil and Environmental Engineering Commons](#), and the [Water Resource Management Commons](#)

Recommended Citation

Riley, J. Paul; Clyde, Calvin G.; Grenney, William J.; Haimes, Yacov Y.; and Jones, Craig T., "Development of a Management Framework of the Great Salt Lake" (1975). *Reports*. Paper 120.

https://digitalcommons.usu.edu/water_rep/120

This Report is brought to you for free and open access by the Utah Water Research Laboratory at DigitalCommons@USU. It has been accepted for inclusion in Reports by an authorized administrator of DigitalCommons@USU. For more information, please contact digitalcommons@usu.edu.



**DEVELOPMENT OF A MANAGEMENT FRAMEWORK
OF THE GREAT SALT LAKE**

by

J. Paul Riley
Calvin G. Clyde
William J. Grenney
Yacov Y. Haimes
and
Craig T. Jones

The work upon which this report is based was supported in part with funds provided
by the Department of the Interior, Office of Water Research and Technology
as authorized under the Water Resources Research Act of 1964, P.L. 88-379
Project Number A-019-Utah, Agreement Number 14-31-0001-4045
Investigation Period May 1, 1973 to July 1, 1974

Additional funds were provided by
the Environment and Man Program, Utah State University

Utah Water Research Laboratory
College of Engineering
Utah State University
Logan, Utah 84322

March 1975

PRJEW 116-1



ABSTRACT

The development of a comprehensive management framework of the Great Salt Lake is a complex process involving the cooperation and close coordination of many groups, disciplines, and activities. In the approach to this problem which is being followed by researchers at Utah State University, the study was divided into three separate phases. Phase I provides the overall structural framework for management of the Great Salt Lake, identifies the data needs, and establishes priorities for the development of submodels (both structural and non-structural) for incorporation into the overall framework. The submodels can be developed both from basic considerations and through the modification of existing models. This report summarizes the results of Phase I.

Phase II involves the process of developing submodels, and Phase III is concerned with the application of the framework of models to specific management problems. The future management of the resources of the Great Salt Lake is the concern of both public and private entities in Utah. In this respect, the Economic Committee of the Utah Legislature has recognized the need for a study which synthesizes all available knowledge and identifies any additional information which must be gathered in order to establish a management strategy for the Great Salt Lake. The study reported herein is in accordance with and in response to this concern as to how the resources of the lake might be utilized to best suit the needs of the citizens of Utah.

Managing a complex water resource and the related land system requires an understanding of the fundamental processes which occur in the system and the interactions or coupling relationships between these processes. The management framework developed here is aimed at providing decision-makers at various levels in government with the capability to predict the impacts (environmental, economic, and societal) which might result from various policies and decisions. The management framework developed here takes into account the major societal and economic uses of the Great Salt Lake. These uses are (1) recreation and tourism, (2) mineral extraction, (3) transportation, (4) brine shrimp harvesting, (5) oil drilling, and (6) fresh water supply. On the basis of these six major uses, a chart was prepared which lists the potential impacts on cultural and social factors, biological conditions, and physical and chemical characteristics resulting from alterations to the existing lake system.

Modeling the Great Salt Lake system represents a formidable task. For this reason, the problem is approached by decomposing the total system into a number of subsystems and considering the total system as being organized in terms of hierarchies. The hierarchical-multilevel approach being adopted in this study enables the full utilization of existing hydrological and other available water resource planning and management models.

KEYWORDS: Great Salt Lake/water resources planning and management/systems analysis/simulation/water resource modeling/environmental impact analysis/social uses/multi-objective planning /Utah

ACKNOWLEDGMENTS

This publication represents the final report of a project which was supported with funds provided jointly by the Environment and Man Program at Utah State University and the Office of Water Research and Technology under the Allotment Program and through the Utah Center for Water Resources Research.

Many people assisted with the acquisition of needed data, and provided constructive comments and suggestions throughout the course of the study. Special thanks are extended to Senator E. LaMar Buckner, Chairman of the Economic Resources Committee of the Legislature, and to Mr. Reed T. Searle, Executive Director, Great Salt Lake Study, Legislative Council. Both of these people were very cooperative throughout the entire course of the study and provided useful information and concepts which were helpful in identifying management problems concerning the lake system. Mention also is made of the helpful assistance which was provided during the study by Mr. Daniel F. Lawrence and his staff of the Utah Division of Water Resources. Gratitude also is expressed to Dr. Wade H. Andrews, Mr. Frank W. Haws, Dr. A. Leon Huber, and Dr. Trevor C. Hughes for their careful and constructive review of the manuscript. Their comments contributed much to the content of the report.

The authors would be negligent if they failed to recognize the degree to which the Utah Center for Water Resources Research and the Office of Water Research and Technology in Washington, D. C., contributed to the success of this project. Over the years these offices have provided a large portion of the funding support which contributed to the development of the computer modeling techniques and procedures which were applied in this study. In a very basic sense, the project represents the application of research results to the solution of practical problems of the real world.

J. Paul Riley
Calvin G. Clyde
William J. Grenney
Yacov Y. Haimes
Craig T. Jones

TABLE OF CONTENTS

Chapter		Page
PART I: PROBLEM DEFINITION		
I	INTRODUCTION	1
	Scope and Objectives of the Study	2
II	HISTORICAL DEVELOPMENT AND USE OF GREAT SALT LAKE	5
	Background Information	5
	Past Development and Use Strategies	8
III	THE BASIC STRUCTURE OF A MANAGEMENT STRATEGY FOR GREAT SALT LAKE	11
PART II: LAKE MODEL DEVELOPMENT		
IV	MODELING THE WATER RESOURCES SYSTEM OF GREAT SALT LAKE	13
	Identification of Objectives	14
	Lake watershed subsystem	24
	Near-shore and lake subsystems	24
	System Definition	26
	Evaluation and Analysis of Available Studies and Data	26
	Model Formulation	33
	Watershed submodels	37
	Lake and near shore submodels	39
	Model Verification	42
	Computer synthesis	42
	Model calibration and testing	42
	Model Operation	42
	Management Studies	43
PART III: MANAGEMENT MODEL DEVELOPMENT		
V	MULTIOBJECTIVE ANALYSES	45
	Introduction	45
	Construction of Objective Functions	45
	The Surrogate Worth Tradeoff Method	47
	Definition: Non-inferior solution	48

TABLE OF CONTENTS (Continued)

Chapter	Page
Sub-objective Decomposition	50
Sub-objective Coordination	51
Highest Level Coordination	51
Computational Procedure	51
VI CONTINUING MODEL DEVELOPMENT -- A SUMMARY	55
REFERENCES	61
APPENDIX	
STUDY COMMITTEES ESTABLISHED BY THE ECONOMIC RESOURCES COMMITTEE OF THE STATE LEGISLATURE	65

LIST OF FIGURES

Figure		Page
1	Map of Great Salt Lake	6
2	A conceptual diagram of the processes involved in the optimal management of a physical system	12
3	Steps in the development of a model of a real world system	15
4	Steps in the development and application of a simulation model	16
5	An example of possible impacts produced by modification of the physical system to accommodate some specific societal uses of Great Salt Lake	17
6	A diagram illustrating interaction between different components of the total system and various kinds of uses	27
7	First level hydrological-geographical decomposition	28
8	The four brine zones within Great Salt Lake (after Hahl and Handy, 1969)	30
9	General circulation patterns and UGMS brine and sediment sampling sites within Great Salt Lake	32
10	A flow diagram of the hydrologic system within a typical watershed area	38
11	Diagram of the horizontal grid in a node-link model (after Chen and Orlob, 1972)	40
12	Diagram of one column of nodes in a three-dimensional node-link model	41
13	Two objective function representations -- enhancement of recreation and tourism and enhancement of brine shrimp harvesting in the Great Salt Lake	49
14	A sub-hierarchy for recreation and tourism sub-objectives	52
15	Generalized multiobjective hierarchical structure	53
16	A representation of the process of developing a comprehensive management model consisting of linked and integrated submodels	56
17	Schedule of phases in the project to develop a management model of the Great Salt Lake water resource system	57
18	Great Salt Lake basin management study for Phases II and III - Project Flow Diagram	59
A-1	Organizational structure for the Great Salt Lake study by the Economic Resources Committee of the State Legislature	70

LIST OF TABLES

Table		Page
1	Identification of problems associated with possible uses of Great Salt Lake . . .	18
2	Information matrix for assessment of environmental impacts on the water resource system of the Great Salt Lake (modified from Leopold, et al., 1971). . .	25
3	Summary of the adequacy of data within the Great Salt Lake system	34

PART I: PROBLEM DEFINITION

CHAPTER I

INTRODUCTION

The proper management of the resources of Great Salt Lake and its surrounding drainage area so as to achieve maximum public benefit is a matter of increasing public concern as the value of these resources becomes more fully appreciated and their future uses are contemplated. There are, for example, numerous possibilities for utilizing the fresh waters of the tributaries. Chemical industries, recreation, wildlife refuges, and many other uses compete for water in and near the lake itself. A myriad of potential uses at water deficient locations elsewhere within the basin also need to be considered. The manner in which the available water supplies eventually are allocated and used will have a long-term impact on the economic and social development of the entire State of Utah. Thus, the question of how the resources of Great Salt Lake can be utilized to best suit the needs of the citizens of Utah is a real one, and the answer will require a well-integrated and cooperative approach by all groups and agencies concerned with the water resources of the entire lake system.

Governmental concern for the future management of the resources of Great Salt Lake was expressed by Governor Calvin Rampton in a presentation to the First Annual Meeting of the Utah Section of the American Water Resources Association in Salt Lake City on November 30, 1972. This same concern is reflected by a joint resolution which was passed recently by the 40th State Legislature regarding the authorization of a long-range and comprehensive plan for the management and development of Great Salt Lake. Some of the specific problems concerning the management of Great Salt Lake as viewed by State Legislators are contained in the Preamble to the Resolution cited above. In order to emphasize the justification for the study reported herein, this Preamble is quoted as follows:

WHEREAS, the Great Salt Lake is a unique physical feature and is one of Utah's greatest potential industrial and recreational assets; and,

WHEREAS, this 'natural wonder' attracts visitors from throughout the world, many of

whom leave in disappointment over the lack of facilities and accommodations at the lake; and,

WHEREAS, several hundred studies, generally single-purpose reports, have been prepared over the years relating to Great Salt Lake; and,

WHEREAS, no comprehensive, long-range plan of the lake, using these many studies, has ever been made to determine goals and policies for Great Salt Lake development; and,

WHEREAS, a comprehensive, long-range plan should be formulated to insure that all developmental potentials, including but not limited to facilities which provide for transportation, recreation, and industry, are placed in their proper perspective as being harmonious with each other; and,

WHEREAS, a comprehensive plan would insure that environmental and ecological controls be considered and that the development process would be done on an orderly basis; and,

WHEREAS, long-range development of the lake should be a joint venture between federal, state, county, and private sectors supplementing the present work of Wasatch Front Regional Council and Box Elder County in preparing a preliminary general plan of the multi-county area adjacent to the lake.

Recognizing the need for establishing an integrated approach to the development of a management strategy for Great Salt Lake, the Economics Committee of the State Legislature, under the chairmanship of Mr. E. LaMar Buckner, in 1973 established an interagency technical team of 38 state, federal, and local agencies. The mandate of this team is to identify all relevant past and ongoing research activities, and to summarize all existing data and findings into a single document. In addition, a Great Salt Lake policy advisory committee was appointed by the Legislative Committee. These two bodies ultimately will be responsible for recommending to the Legislature broad and specific goals, objectives, and policies to be followed in the management and development of Great Salt Lake in both short and long-term planning concepts (see Appendix A).

Through its actions, the Economics Committee of the Legislature has recognized the need for a study which synthesizes all available knowledge and which identifies information gaps in establishing a management strategy for Great Salt Lake. As indicated by the recent LAKE COM Report (1973), a large number of specific and unrelated studies of various aspects of the lake system have been conducted. Like many other agencies and groups, Utah State University (USU) has completed several specific investigations. However, in early 1973 a study was initiated at USU with the objective of defining an integrated approach to the management of the entire lake system, including the tributary drainages. The basic characteristic of this study is the development of a framework of realistic computer models which are capable of being used to analyze and predict the consequences of various management alternatives. Over the years research workers at USU have gained considerable experience in the development of computer models of a wide spectrum of natural resource and social systems. This approach is particularly suited to management studies which involve complex systems, and which require the synthesis of much information and many professional disciplines. In addition to providing predictions of the results of management alternatives, computer models are capable of increasing insight concerning the relative importance of system components and processes. In this way, models suggest priorities in the search to gain further information and understanding about various aspects of the system as a whole.

The USU study was divided into three basic phases, with the first phase being to define the problem and scope of activities for the subsequent model development and operation phases. The results and recommendations of the first phase of the study comprise this report. Although the study was initiated several months before the formation of the technical team and the policy advisory committee to the Economics Committee of the Legislature, it is submitted that the subsequent phases as proposed for the USU study are capable of providing a much needed basic framework for the broad scope of activities and deliberations which will be undertaken by these two bodies in their efforts to formulate an integrated and meaningful plan for the effective management of the water and related land resources of Great Salt Lake.

Scope and Objectives of the Study

As previously indicated, at the time of its inception the entire project was divided into three separate phases of specific activity, with Phase I being concerned with the definition of the problem and the development of specific recommendations for work in subsequent phases. It was envisioned that Phase II would involve the actual model development process and that Phase III would be concerned with the applica-

tion and operation of the models to obtain answers to specific management problems. Thus, depending upon the ultimate stage of model development, various aspects of Phases II and III could be continued for an extended period of time, and could be considerably overlapping.

The overall, long-range objective of the entire study is to develop a management strategy for allocating the resources of the region (natural, manpower, and economic) so as to provide for the optimal enhancement of environmental quality, economic development, and social well-being within the region. This comprehensive objective is broken into sub-objectives as follows:

1. To examine the societal, environmental, economic, and other activities relating to the Great Salt Lake system, such as oil-well drilling, extraction of minerals from the lake, and the construction of physical structures in the lake.
2. To examine the positive and negative impacts (societal, environmental, and economic) of various commercial and economic activities, such as land use (including urbanization) and structural developments within the tributary basins to the lake.
3. To examine the positive and negative impacts (societal, environmental, economic, and others) of various exogenous (from outside the region) inputs and constraints, such as:
 - a. Federal decisions which affect environmental quality, appropriation of funds, and changing use priorities.
 - b. Economic development outside the region.
 - c. Advances and changes in science and technology, such as improvements in mineral extraction processes and shifts in demands upon particular resources.
4. To develop a comprehensive planning framework for the development of the Great Salt Lake and its immediate environment. This framework will provide productive assessments of alternatives helpful in the decision-making process.

This report is concerned with those activities which are associated with Phase I of the study, and the specific objectives of this phase are as follows:

1. To identify and evaluate all previous studies, data, and other information pertaining to the lake system.
2. To identify the following:

a. All potential major societal uses associated with the lake system.

b. Means by which the physical system might be modified to implement these societal uses within the environmental constraints.

c. Potential problems or impacts which might occur as a result of the modifications suggested under Objective 2(b).

3. To estimate the relative magnitudes of the impacts which are identified under Objective 2(c).

4. To identify general information needs, model structures, and steps for the model development processes of Phase II. This objective includes the identification of agencies and groups which might contribute to subsequent phases of the project.

CHAPTER II

HISTORICAL DEVELOPMENT AND USE OF GREAT SALT LAKE

Background Information

In general, the historical development of Great Salt Lake (Figure 1) has proceeded as a sequence of uncoordinated activities without an established overall management plan or strategy to maximize the total public benefit from the resources of the lake. Even so, the use of the resources of Great Salt Lake has played, and continues to play, an important role in the economic and social development of Utah.

Extraction of salt from Great Salt Lake was established by the Mormon settlers soon after their arrival in Utah in 1847. They are responsible for pioneering the use of evaporation ponds for the removal of salt from the Great Salt Lake brine. The procedure which they used for recovering table salt (sodium chloride), which is essentially the same process used today, consists of filling a pond with brine, allowing the brine to concentrate to a particular density where sodium chloride precipitates out, and then draining the rest of the brine from the pond. This process leaves a layer of almost pure sodium chloride in the bottom of the pond.

The brine of Great Salt Lake contains a variety of other salts more valuable than sodium chloride. At present there are two companies, National Lead Industries, and Great Salt Lake Minerals and Chemicals Corporation, extracting minerals other than common salt from the lake. National Lead Industries plans to produce magnesium metal (45,000 tons/year), liquified chlorine (81,000 tons/year), and gypsum (48,000 tons/year). Great Salt Lake Minerals and Chemical Corporation plans to produce magnesium chloride (300,000 tons/year), potash (potassium sulfate) (200,000 tons/year), sodium sulfate (100,000 tons/year), lithium chloride (5,000 tons/year), and bromine (2,500 tons/year). The lake contains additional salts of magnesium, sulfur, and potassium which may become economic to produce in the future.

The completion of the Southern Pacific Transportation Company's causeway across Great Salt Lake in 1957 has resulted in a drastic change in the brine concentration characteristics of the lake. Since construction of the causeway, the brine in the northern

arm of the lake has remained near saturation, while the brine south of the causeway is found to be less concentrated than before constructions. The main cause of this difference is that the southern end of the lake is fed by over 95 percent of the surface water inflow to the lake. The northern arm receives most of its inflow as brine from the southern end through the causeway. The major effect of this brine difference has been on the mineral extraction industries. The plants which intake brine from the northern arm of the lake receive brine which is already near saturation, while the plants receiving brine from the southern arm are fearful that the concentration of the brine will be diluted to a point where economic operations are not feasible. Whelan and Stauffer (1972) investigated the cost of equalizing brine concentration in the lake by: (1) removing 1,500 feet of fill and replacing it with a bridge or trestle; (2) pumping brine from the south arm to the north arm; or (3) removal of 65 feet of fill and diverting the Bear River to the north end. Alternately, freshening of the south arm could continue and a pipeline constructed to furnish brine from the northern arm to National Lead and the south arm salt companies. The importance of proper management of this resource is perhaps more fully appreciated when it is realized that the minerals contained in Great Salt Lake have an estimated value of over 90 billion dollars (Searle, 1973).

The exploration for oil in and around the north arm of Great Salt Lake has received attention at various times since the turn of the century. The presence of oil was established with the discovery of natural oil seeps at Rozel Point. Attempts to produce oil within the lake have resulted in only marginal success to the present time. Recent leases have been granted to Amoco and Wolfe for oil and gas exploration and drilling within the boundaries of Great Salt Lake. The effects this undertaking will have on other lake uses has not been established.

The Dow Chemical Company (1973) prepared a report for the Division of Water Resources, Utah Department of Natural Resources, on the feasibility of locating an industrial complex in the Wasatch

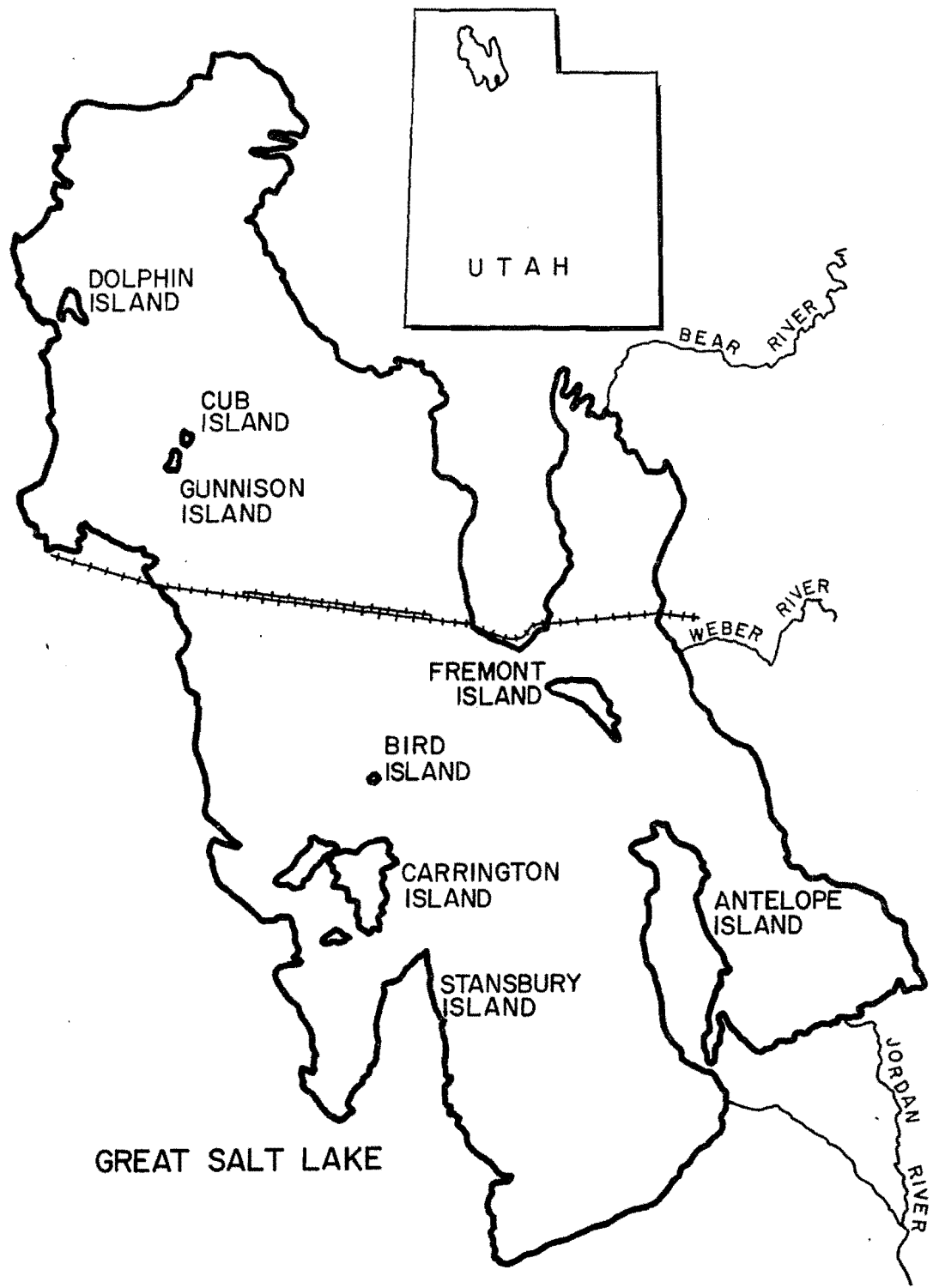

Figure 1. Map of Great Salt Lake.

Front region. The study was based on the assumption of manufacturing 14 chemical products mainly from Utah crude oil and minerals extracted from the Great Salt Lake brine. The report gives favorable results on the possibility of locating such a complex near Great Salt Lake. The discovery of a large quantity of oil in the north arm of Great Salt Lake could give new impetus to such a project.

Great Salt Lake for many years provided major resort facilities for the tourists and local residents that visited the lake. The late 1880's and early 1900's saw the establishment and eventual failure of many resorts around the lake. Black Rock, Garfield Beach, Lake Point, Lake Park, Syracuse, and Saltair all flourished as major resort areas at one time during this period, but all eventually failed. Saltair was perhaps the most popular resort on the lake with swimming facilities, a dance pavilion, and an amusement park. Saltair survived with varying degrees of popularity from 1893 until 1968 when it was once again closed and later destroyed by fire.

The continuous fluctuation of the volume of the lake was a common enemy of the resorts. The bottom of the lake has a very gentle slope which results in a large change in surface area for a small change in lake volume. The location of the shore line varies drastically between dry and wet years. During periods of decreasing lake stage the shore line would recede leaving the resorts high and dry. Saltair lost most of its popularity during the low lake periods of the 1930's and the 1960's when the shore line of the lake receded several hundred yards from the pavilion.

The present private recreational facilities on the lake are found at Silver Sands Beach. These facilities provide the opportunity to swim, boat, or tour the lake. The use of the lake for boating has grown recently, mainly due to the use of fiberglass craft which are impervious to the effects of the salt brine. An active group of sail boaters has reestablished the old Salt Lake Yacht Club Charter.

The State of Utah has obtained the north end of Antelope Island and established it as the Great Salt Lake State Park. A highway which opened between Syracuse and the Park in 1969 was severely damaged during higher water levels in the lake and reconstruction is nearing completion.

Many people in the state feel that the facilities now available on Great Salt Lake are not sufficient to produce the maximum income possible from the tourist industry. Reed T. Searle's (1973) view of the problem is, "Tourists by the thousands visit the Great Salt Lake each year although the majority of them leave in disappointment over the lack of facilities and

accommodations at the lake. Nevertheless, the potential for attracting and holding tourists in Utah by recreational development at the lake is limited only by the imagination and the development pocketbook."

At the 1970 meeting of the Utah Section of the American Water Resources Association, W.M. Katzenberge expressed this view on the present tourist facilities:

The state's interest in development of the southern half of the Great Salt Lake should swing into action rather than remain dormant. Lack of control of the brine flies and lack of development of a clean beach area costs us, the taxpayer, untold dollars per year. We could and would hold tourists in our area for longer periods if we were to develop the Great Salt Lake as a tourist attraction and have motels/hotels there to give the tourists something to stay for. Cruising upon the lake itself has potential as evidenced by the number utilizing the only operating cruise boat at this time.

The islands of Great Salt Lake and the marshlands which are found around the shore of the lake provide nesting and rest areas for a variety of migratory birds. The California gull, white pelican, Caspian tern, great blue heron, and double-crested cormorant migrate inland from the Pacific Coast to nest on the islands of Great Salt Lake. During the spring and summer these birds mainly use the smaller islands for nesting, having abandoned the use of the larger islands.

An extensive network of marshlands is found around the shores of Great Salt Lake. These marshlands provide a vital link in the waterfowl flyway extending from Canada to Mexico. Much of the marshland is controlled by federal and state agencies and private organizations. The Utah Division of Wildlife Resources operates five waterfowl management areas at the mouths of streams entering Great Salt Lake, and the U.S. Bureau of Sport Fisheries and Wildlife operates the Bear River Migratory Bird Refuge at the mouth of the Bear River. The rest of the marshlands are managed mainly by private organizations, such as hunting clubs.

The continued demand on water upstream from the marshland has the potential of depleting both the quantity and quality of water entering the marsh. If productive marshlands are to be maintained, a supply of water that will fill the evapotranspiration needs of the marsh plants and provide sufficient outflow to maintain a satisfactory salinity level will have to be dedicated to this purpose. Proper control of water fluctuation within the marshes may provide needed control of the mosquito population, but may also affect the water demand of the marshlands.

Great Salt Lake is fed by three main surface inflows, namely, the Bear, Weber, and Jordan Rivers. Water development within the Great Salt Lake drainage has centered around projects within these river basins. The Bear River has been partially developed for power and irrigation purposes with several storage reservoirs within the basin. The Weber River basin has undergone extensive development under the Weber River Project of the U.S. Bureau of Reclamation. Inflow to Great Salt Lake from the Jordan River has been affected by the development of water supply for the Salt Lake City area and through the development of the streams which feed Utah Lake. Under the proposed Central Utah Project the flow of the Jordan River would undergo further alteration.

The development of reservoirs in the vicinity of Great Salt Lake appears to be essential for developing large quantities of fresh water now "wasting" into Great Salt Lake. Two alternatives are most apparent: creation of off stream reservoirs such as (1) Willard Bay reservoir, and (2) connecting the east lake islands and the mainland with a system of dikes to create a fresh water body within the present Great Salt Lake boundaries. Further development of the present inflow to Great Salt Lake, whether upstream or within the vicinity of Great Salt Lake, will have to be a compromise between developing new fresh water supplies and maintaining the level of Great Salt Lake to serve other interests, such as recreation, tourism, wildlife, and mineral extraction.

Before the railroad developed as an efficient means of transportation, shipping on Great Salt Lake was an important means of transportation. Ore, salt, livestock, and passengers were the major cargoes. The largest vessel to use the lake was the steam powered "City of Corinne" constructed in Corinne, Utah. It was launched in 1871 to carry ore mined in the Oquirrh Mountains to the smelter at Corinne.

The Southern Pacific Railroad Company eliminated Great Salt Lake as a barrier to rail transportation with the completion of the Lucin Cutoff across the waters of the lake in 1904. The cutoff was completed with the construction of a wooden trestle with short sections of fill at each end across the main body of the lake from the east shore to Promontory Point. During the 1950's, the main section of trestle was replaced with a rock and gravel causeway. As a result, the lake essentially has been divided into two separate portions or arms. The major effect of the causeway has been the disruption of the brine concentrations in the north and south arms of the lake and the resulting effect on the mineral extraction industry. Additionally, travel on the lake by watercraft has been restricted. The effects the railroad causeway has had on alternative uses of the resources of Great Salt Lake further illustrate the need for comprehensive coordi-

nated management of the total resources of the Great Salt Lake system.

Past Development and Use Strategies

The main effort at a coordinated development of Great Salt Lake has centered around the development of fresh water storage reservoirs within the present boundary of Great Salt Lake. During the 1930's, two different schemes for diking the lake were proposed. The "large project" consisted of a diking system extending westerly from the mainland to the southern end of Antelope Island, from the north end of Antelope Island to the southern end of Fremont Island, and from the north end of Fremont Island to Promontory Point. The reservoir created by this inter-island diking system would capture the flow of the Bear, Weber, and Jordan Rivers. Under the "small project," dikes would be constructed to connect the north and south ends of Antelope Island to the mainland. Water for this reservoir would be supplied by the Jordan River and a diversion canal from the Weber River. Even though feasibility studies were undertaken, interest in these projects was lost.

In 1955, the Utah Legislature authorized the Utah State Road Commission to initiate a study on the advisability and feasibility of creating a fresh water reservoir through the construction of an inter-island diking network. The findings were summarized in a 1958 report by the Advisory Committee to Utah State Road Committee entitled "Great Salt Lake Diking Study." The report recommended:

1. The State of Utah acquire all or part of Antelope Island for development as a state park.
2. The construction of dikes to form the large project be undertaken as early as possible.
3. Roads be constructed on the dikes in conjunction with connecting roads to form a scenic 'loop' which would include Salt Lake City, Antelope Island, Fremont Island, and Promontory Point.
4. A comprehensive survey be made to determine the demand for water of the quality that would be produced in the fresh water lake.

The major effort to coordinate the development of Great Salt Lake was undertaken when the Utah State Legislature created the Great Salt Lake Authority in 1963. The Great Salt Lake Authority was given the responsibility to plan, formulate, and execute a program for the development of the mainland, islands, minerals, and water within the Great Salt Lake meander line for industrial, recreational, agricultural, and chemical purposes. The authority was directed

to obtain part of Antelope Island and develop it for recreational use.

Under the direction of the Great Salt Lake Authority a preliminary master plan for the development of Great Salt Lake, over a period of the next 75 years, was prepared by Caldwell, Richards, and Sorenson, Inc., Consulting Engineers. This 1965 study again put emphasis on the construction of inter-island dikes to form a fresh water reservoir in the eastern section of Great Salt Lake so that the fresh water running into Great Salt Lake could be saved and stored. Tests were begun to investigate the feasibility of using tailings from the Kennecott Copper Corporation operations as material for dike construction and as fill material for an area of approximately 60 square miles in the southern end of the inter-island embayment. The reclaimed land was to be used for agricultural and industrial development or other suitable purposes. The master plan also called for recreational development to be encouraged between Black Rock and old Saltair resort by designating this area a major resort area and stabilizing the lake at about elevation 4,200. A zoning plan for the lake bed land was proposed with agricultural-industrial development on the land reclaimed with tailings, recreational-wildlife development covering most of the area between Black Rock and Promontory Point, and the balance of the lake designated for chemical extraction purposes.

Tests on the feasibility of using the Kennecott tailings for dike construction were carried out for the Authority. In December, 1968, Caldwell, Richards, and Sorenson, Inc., presented the Great Salt Lake Authority the result of the tailing feasibility test. The report pointed out the practicability and limitations of using tailings for dike construction. H. S. Suekawa (1970) reported the findings of a three-year test conducted in the lake on the stability of Kennecott tailings. General conclusions were that placing the tailings by transporting them in a slurry through a pipeline appeared to be economically feasible but the destructive force of wave action would require the dike to have a protective cover.

During its existence the only task the Great Salt Lake Authority was able to complete was the establishment of the Great Salt Lake State Park on Antelope Island. The dissolving of the Great Salt Lake Authority in 1969 has left the state without an agency with responsibility for coordinating the development of the resources of Great Salt Lake.

Uncoordinated development of the lake can create situations where resource use alternatives are undertaken without previously investigating the potential impacts which the developments might have on possible or existing projects which involve alternative uses of the resources. The limitations on the creation of an inter-island diking system for fresh water storage created by other development and resource use alternatives is an excellent example of how the lack of a comprehensive development strategy has limited development alternatives involving Great Salt Lake. Under the Weber River Project of the USBR, Willard Bay Reservoir was constructed as an off-stream reservoir for storage of Weber River water which would be lost to Great Salt Lake. The possible contribution of the Weber River to an inter-island reservoir is therefore greatly reduced over natural conditions. Although off-stream reservoirs might be the best solution for storing fresh water now entering Great Salt Lake, Willard Bay Reservoir was constructed and now has a major influence on the remaining alternatives for saving water now flowing into Great Salt Lake. In the case of the inter-island diking schemes, it appears that construction of the "small project," discussed earlier, might not be feasible due to the reduced flow of the Weber River.

The locating of a major chemical extraction operation in the lower reaches of Willard Bay further restricts the possible alternatives available for fresh water storage. Willard Bay was once considered a prime site for fresh water storage. But due to possible damage to the chemical extraction operation, the use of Willard Bay for fresh water storage might be limited.

Proper management of the resources of Great Salt Lake requires that possible use alternatives be coordinated in a manner which will bring maximum benefit to the entire state. The responsibility given the Great Salt Lake Authority was an attempt to properly manage the lake. In creating the Great Salt Lake Authority, the state viewed the problem as developing the mainland, islands, minerals, and water within the Great Salt Lake meander line. Proper management of Great Salt Lake for maximum benefit to the state requires that the entire lake system, including the lake, marshland, and tributaries, be managed as a single entity. Otherwise it is possible to have management decisions made for one area of the lake system (tributary streams) which conflict with the management goals in another area of the lake system (Great Salt Lake) without the consequences of such conflicts being minimized.

CHAPTER III

THE BASIC STRUCTURE OF A MANAGEMENT STRATEGY FOR GREAT SALT LAKE

A system might be broadly defined as a group of interconnected and interdependent components, each of which contributes to the overall functioning of the whole. Systems management implies a planned manipulation of a particular system and/or its associated input functions so as to achieve specific objectives and goals. Management, then, is a dynamic process which must be continually responsive both to changing societal goals and objectives and to fluxes within the components of the managed system itself. Optimal management involves manipulation of the system so as to achieve optimal resource use in terms of the needs, objectives, and goals of the system users as a whole.

The general management concept for a natural resource system, such as Great Salt Lake, is illustrated by Figure 2. As indicated by this diagram, there is first the need to understand and describe the physical components of the system through basic information and data. Next to be considered are the societal demands or use options which might be implemented in varying degrees through management measures (both technical and non-technical) which alter certain characteristics of the physical system. Any management policy is imposed upon the physical system in order to produce a particular set of conditions. In turn these conditions are interpreted in terms of the needs of a particular social objective or set of objectives. Thus, while an achieved set of conditions might be desirable in terms of a given societal objective, these same conditions might represent disadvantages to other social uses or objectives. For this reason, a particular management plan is necessarily selected by means of some form of optimizing process which usually is based on cost and value factors. The selection, or optimizing, procedure often involves 'trade-offs' between value functions, but hopefully

the management plan which ultimately is selected is able to provide the optimal resource use in terms of the needs, objectives, and goals of the society as a whole. Frequently, the plan which is adopted does not provide the optimal resource use in terms of economics alone. Finally, through the input of labor and capital, the physical system is modified to accommodate to some degree the requirements of the various resource use options which are emphasized by the management plan being implemented.

As suggested by the preceding discussion, the selection of a particular management plan from a group of possible alternatives requires methodologies for assessing the degree to which each potential plan meets specific and defined management objectives. Obviously, it is usually not practical to implement and test a number of possible plans by manipulation of the real-world system on a "trial and error" basis. Many courses of action tend to be irreversible. For example, once a structure such as a dike or bridge is constructed, subsequent extensive modifications to the plan usually are not feasible. Frequently a system manager reaches a decision on the basis of his judgment from past experience and knowledge. However, in the case of highly complex systems, such as that of Great Salt Lake, the many interacting processes and interdependencies cannot easily be perceived and expressed. In this situation computer modeling has great practical utility. To the degree that the model represents the system being managed, the technique enables various possible management alternatives to be tested quickly and effectively under a wide range of known and assumed physical and social conditions. For this reason, computer modeling is proposed by this report as the basic framework of a management strategy for the water resource system of Great Salt Lake.

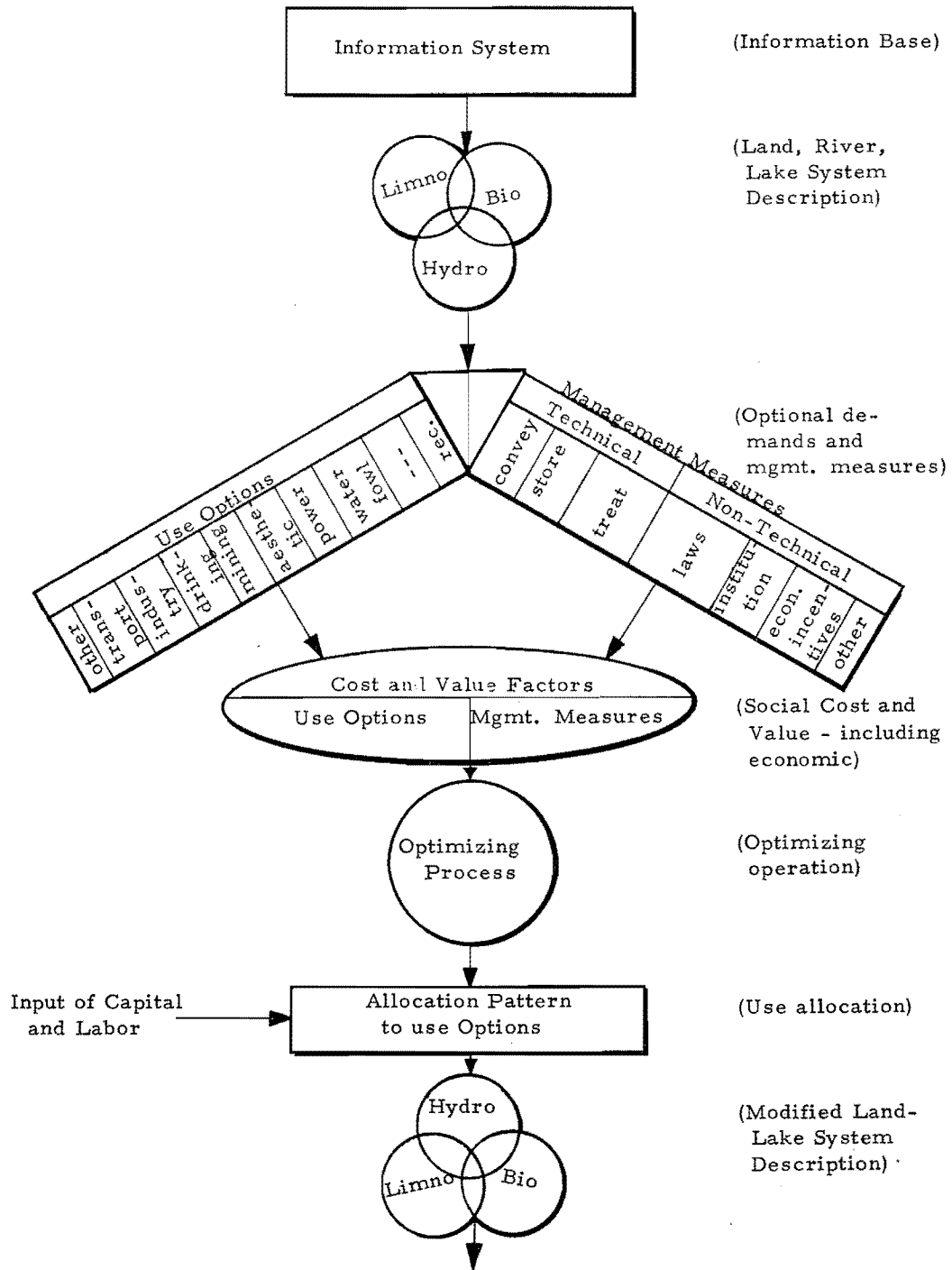

Figure 2. A conceptual diagram of the processes involved in the optimal management of a physical system.

PART II: LAKE MODEL DEVELOPMENT

CHAPTER IV

MODELING THE WATER RESOURCES SYSTEM OF GREAT SALT LAKE

The problems of managing a complex water resources system require an understanding of the fundamental processes and coupling relationships involved in the system. With this understanding a manager is then able to predict realistically the consequences of possible changes which might be imposed upon the system. For example, in the case of Great Salt Lake it might be desirable to be able to predict changes in lake levels which might result from the adoption of particular water use patterns on some of the major tributary streams. In recent years, the advent of electronic computers has stimulated the use of simulation analysis for planning and management of large and complex systems. In essence, the computer model is intended to reproduce the behavior of the important system variables of the prototype under study.

Mathematical simulation is achieved by using arithmetic relationships and mathematical equations to represent the various processes and functions of the prototype system, and by linking these equations into a systems model. Thus, computer simulation is basically a technique of analysis whereby a model is developed for investigating the behavior or performance of a dynamic prototype system subject to particular constraints and input functions. The model behaves like the prototype system with regard to certain selected variables, and can be used to predict probable responses when some of the system parameters or input functions are altered. Computer simulation, therefore, has the following important advantages:

1. A model provides a basis for coordinating information and the efforts of personnel across a broad spectrum of scientific disciplines.
2. A model approach requires a clear identification of problems and objectives associated with the system being examined.
3. Insight into the system being studied is increased. In particular, the relative importance of various system processes and input functions is suggested.

4. Priorities and adequacies are indicated in terms of planning objectives and data acquisition.

5. A model is capable of indicating in quantitative terms progress toward system definition and conceptual understanding.

6. Proposed modifications of existing systems can be non-destructively tested.

7. Many planning and management alternatives and proposals can be studied within a short time period.

8. Hypothetical system designs can be tested for feasibility or comparison with alternate systems.

As already suggested, a computer model (like any model) is an abstraction from reality, and in this sense is a simplification of the real world which forms the basis of the model. The degree of simplification is a function of both intent or planning and knowledge about the real world. Verbal information and conceptualization may be translated into mathematical form for eventual use in a computer. Therefore, the model development process should proceed essentially from the verbal symbols which exist in both theoretical and empirical studies to the mathematical symbols which will compose the model.

The development of a working mathematical model requires two major steps. The first step is the creation of a conceptual model which represents to some degree the various elements of the system and their interrelationships. In general, the conceptualizations and hypotheses of the real world of a particular study area are formulated in terms of the available data. Efforts are made to use the most pertinent and accurate data available in creating the conceptual model. As additional information is obtained, the conceptual model is improved and revised to more closely approximate reality.

The second major step in the development of a working mathematical computer model is between the conceptual model and the computer or working model itself. During this step an attempt is made to express in both mathematical and verbal forms the various processes and relationships identified by the conceptual model. Thus, the strategy involves a conversion of concepts concerning the real world into terms which can be programmed on a computer. This step usually requires further simplification, and the resulting working model may be a rather gross representation of real life.

The loss of information, first between the real world and the conceptual model, and second, between the conceptual model and computer implementation, might be compared to a filtering process, as depicted by Figure 3 (Riley, 1970). The real world is 'viewed' through various kinds of data about the system which are gathered. Additional data usually produce an improved conceptual model in terms of time and space resolutions. The improved conceptual model then provides a basis for improvements in the working model. Output from the working model can, of course, be compared with corresponding output functions from the real world, and if discrepancies exist between the two, adjustments are indicated in both the conceptual model and the working model.

The important steps involved in the process of model development are depicted by the diagram of Figure 4 (Riley, 1970), and these steps will be followed in the following development of a management strategy for the water resource system of Great Salt Lake.

Identification of Objectives

Clearly, the starting point in the formulation of a management model is a precise definition of the function or purpose of the model. As already indicated, an important objective of the investigation described by this report is to define the management problems and objectives involving the Great Salt Lake system. Without this essential first step, a meaningful and effective management strategy obviously could not be formulated and implemented.

By definition, a problem is associated with a characteristic of a physical or social system which is in some way detrimental to, or perhaps not amenable to, a particular social use. The problem for the particular social use is solved by modification of the system so as to better accommodate the use. For example, a dam might be constructed to provide flood control and so reduce the risks associated with flood plain development. However, the construction of the dam might well have adverse effects on other social uses,

such as transportation and farming within the reservoir area. A modification at any point in a system initiates a whole series of adjustments throughout the entire system until a new equilibrium condition is reached. These adjustments produce both physical and social impacts, some of which are positive and others of which are negative, but all of which need to be anticipated and assessed by a program of efficient system management.

The kind of "chain reaction" which is triggered by a change or modification at some point in a system is illustrated by the diagram of Figure 5. This figure illustrates some of the possible impacts of constructing a causeway in Great Salt Lake to facilitate transportation. In this example, the physical system is altered in order to better accommodate a transportation use. However, it is speculated that the causeway also produces effects which might adversely influence other social uses. Figure 5 suggests, for example, that the causeway alters prevailing lake circulation patterns and obstructs open water surface areas. Thus, some of the other social uses of the lake which might be adversely affected are water transportation, water recreation (such as boating), brine shrimp harvesting, and mineral extraction industries.

A system is managed in order to accommodate particular social uses which are identified with specific goals and objectives. For this reason, the first step in identifying possible problems associated with the management of a particular system is to delineate the various potential social uses for the system. In the case of the Great Salt Lake system the major social uses are identified as follows:

1. Recreation and tourism.
2. Mineral extraction.
3. Transportation.
4. Brine shrimp harvesting.
5. Oil drilling.
6. Fresh water supply.

On the basis of the 6 major uses listed above, a chart was prepared (Table 1) which lists desirable system characteristics for each use and some of the methods or system modifications by which these desirable characteristics might be achieved. For example, more stable water levels in Great Salt Lake to benefit recreation and tourism might be achieved by the construction of additional storage reservoirs on the major tributaries. Also suggested by Table 1 are some possible problem areas which might be influenced by the various system changes. These are possible areas of adverse impact on other social uses, and these also are indicated by the table. Continuing with the storage reservoir example, developed lands might be flooded which, of course, would have adverse effects

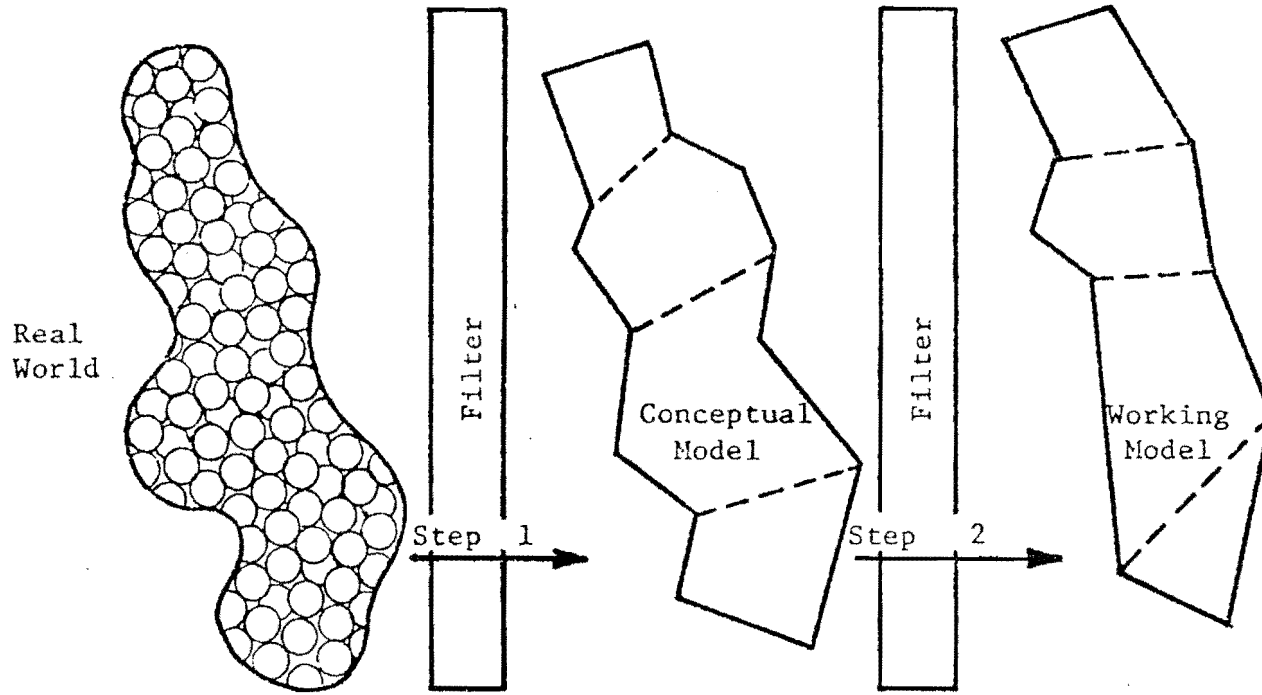

Figure 3. Steps in the development of a model of a real world system.

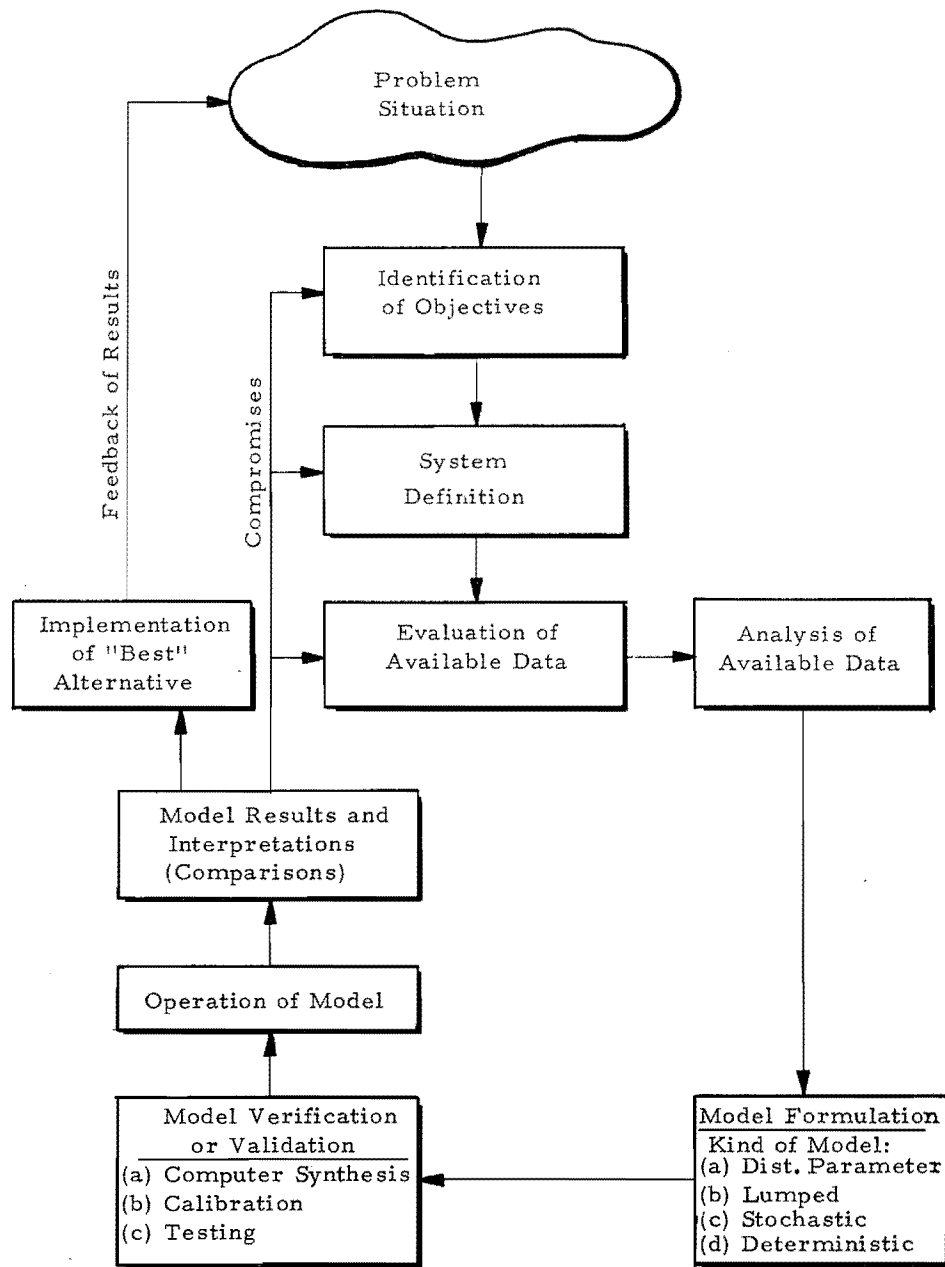

Figure 4. Steps in the development and application of a simulation model.

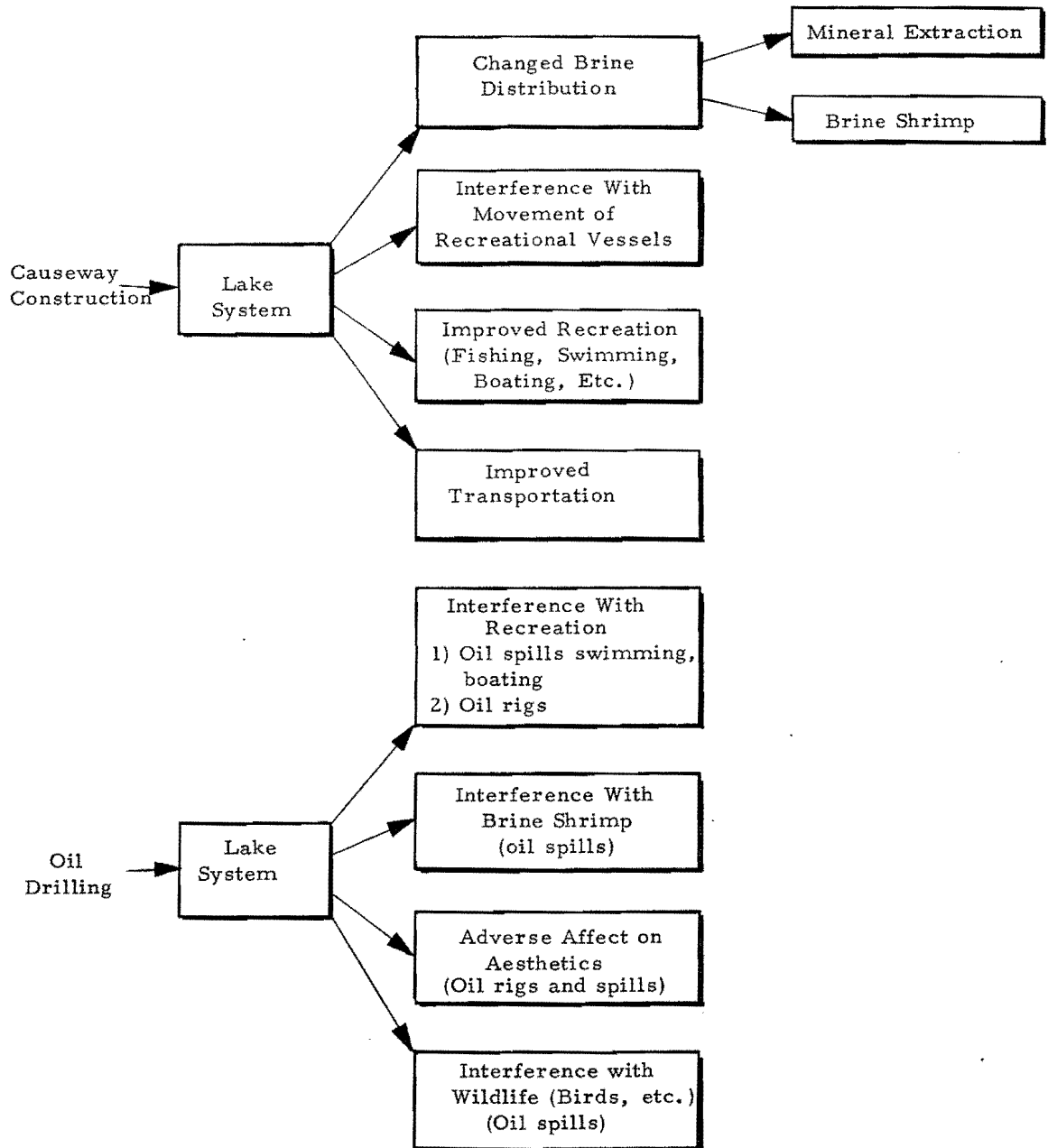

Figure 5. An example of possible impacts produced by modification of the physical system to accommodate some specific societal uses of Great Salt Lake.

Table 1. Identification of problems associated with possible uses of Great Salt Lake.

Possible Uses	Desirable System Characteristic Related to Uses	Some Methods of Achieving Desirable System Characteristics	Some Possible Problem Areas Influenced by Implementation of Methods (Impact Areas)	Some Social Use Areas Affected by Problems
Recreation and Tourism	Stable Water Level	Dike Construction in the Great Salt Lake	Alteration of Circulation Patterns	Mineral Extraction Industry Recreation
			Physical Barrier to Free Access to Entire Lake	Recreation Water Transportation
			Maintenance of Dikes	Recreation and Tourism
			Alteration of the Biological Habitat	Wildlife Bring Shrimp Harvesting Recreation
		Construction of Tributary Storage Reservoirs	Flooding of Developed Lands	Recreation Agriculture Industry Transportation
			Alteration of Biological Habitat	Wildlife Recreation
		Transbasin Diversions	Interrupted Deliveries During Low Flow Periods	Recreation
		Weather Modification	Alteration of Biological Habitat	Wildlife Recreation
				Control Procedures not Sufficiently Well Established
		Fresh Water Bodies for Water Based Activities (Skiing, Boating, Swimming, Fishing)	Dike Construction in the Great Salt Lake	(Same as those Listed Under Stable Water Level)
			Construction of Tributary Storage Reservoirs	(Same as those Listed Under Stable Water Level)
		Easy Access	Road Construction	Maintenance Problems
Obtaining Right-of-Ways	Agriculture Wildlife			
Dike Construction in GSL for Road Bed	(Same as Those Listed Under Stable Water Level)			
Development of Parks, Resorts, Beaches, and Associated Features	Adverse Ecological Effects		Wildlife Recreation	
	Aesthetics (Visual)		Recreation	
	Use Regulation	Recreation		
	Interference with Other Possible Uses	Recreation Industry Agriculture		

Table 1. Continued.

Possible Uses	Desirable System Characteristic Related to Uses	Some Methods of Achieving Desirable System Characteristics	Some Possible Problem Areas Influenced by Implementation of Methods (Impact Areas)	Some Social Use Areas Affected by Problems	
Recreation and Tourism (cont.)	Optimum Use Intensity	Boat Launching, Mooring, and service Features	(Same as Those Listed Under Road Construction)	Recreation	
		Developing Facilities in Accordance to Demand	Aesthetics	Wildlife	
			Adverse Ecological Effects	Recreation	
			Interference with Other Possible Uses	Recreation Industry Agriculture	
			Reservation Policies	Recreation	
		Charges for Use	Reduced Per Capita Recreational Opportunity	Recreation	
	Low Health Hazard	Adequate Sewage Treatment	Some Limitations of Use to Lower Income Groups	Recreation	
		Solid Waste Disposal	Installation and Operation of Plants	Recreation Tourism	
		Mosquito Control Measures	Implementation and Operation of Collection and Disposal Facilities	Recreation Tourism	
	Low Insect Population (Brine Fly, Deer Fly, Horse Fly)	Chemical Spraying	Marsh Stabilization	Water Supply Wildlife	
			Operation and Maintenance of Spray Equipment	Recreation	
		Biological Control	Adverse Ecological Effects (Mainly Through Food Chain)	Wildlife	
Mineral Extraction	Aesthetic Appeal	Structural Design	Problems Associated With Decaying Organic Matter	Recreation	
			(Same as Those Listed Under Chemical Spraying)		
			Economic Feasibility	M.E. Industry	
	Maintenance of Natural Brine Concentration	Low Plant Density	Construction of Plants in Remote Areas	Number of Plants is Restricted	M.E. Industry
				Access	M.E. Industry
				Economic Feasibility	M.E. Industry Transportation
				Change in Brine Concentration on Both Sides of Existing Dikes	M.E. Industry
Provide for Adequate Flow Through Causeways (Alter Existing Structure and Include in Design of Planned Structures)	Objectives Associated With Development of Fresh Water Areas Could Not Be Achieved	Recreation	Wildlife		

Table 1. Continued.

Possible Uses	Desirable System Characteristic Related to Uses	Some Methods of Achieving Desirable System Characteristics	Some Possible Problem Areas Influenced by Implementation of Methods (Impact Areas)	Some Social Use Areas Affected by Problems	
Mineral Extraction (cont.)	Maintenance of Adequate Brine Concentration for Efficient Plant Operation	Dikes to Produce Evaporation Areas	Maintenance of Dikes	Recreation Tourism	
			Interference with Other Possible Uses of Area	Recreation Water Supply M.E. Industry	
		Convey Brine From Areas of High Brine Concentration	Economic Feasibility	M.E. Industry	
			Maintenance of Equipment and Facilities	M.E. Industry	
		Construct Plants at Locations of High Brine Concentration	Economic Feasibility	M.E. Industry	
		Limit Number of Plants on Lake	Regulation	M.E. Industry	
		Limit the Extraction Rate of Each Plant	Economic Feasibility	M.E. Industry	
			Regulation	M.E. Industry	
		Adequate Transportation Facilities	Roads	Maintenance Problems	M.E. Industry
				Acquisition of Right-of-Ways	Agriculture Wildlife
	Interference with Lake Circulation Patterns			M.E. Industry	
	Physical Barriers to Free Access to Entire Lake			Transportation Recreation	
	Access			M.E. Industry Wildlife Recreation	
	Minimize Ecological Effects	Appropriate Location of Plants and Evaporation Ponds	Economic Feasibility	M.E. Industry	
			Adequate Brine Concentration at Point of Diversion	M.E. Industry	
Limit Extraction Rates so as to Maintain Brine Concentrations and Constituents in the Lake			Regulations	M.E. Industry	
Economic Feasibility			M.E. Industry		

Table 1. Continued.

Possible Uses	Desirable System Characteristic Related to Uses	Some Methods of Achieving Desirable System Characteristics	Some Possible Problem Areas Influenced by Implementation of Methods (Impact Areas)	Some Social Use Areas Affected by Problems
Transportation	Stable Road	Causeway and Roadbed Construction	Economic Feasibility	Transportation Industry
			Aesthetics	Recreation
			Disturbance of Lake Circulation	M.E. Industry
			Disturbance of Brine Concentration	M.E. Industry Brine Shrimp Harvesting
			Interference with Ecological Habitat	Brine Shrimp Harvesting Wildlife
			Interference with Other Possible Uses	Recreation Water Transportation
	Minimum of Obstacles	Open Channels for Water Transport	Interference with Other Possible Uses	M.E. Industry Land Based Transportation
			(Same as Those Listed Above Under Causeway and Roadbed Construction)	
		Smooth Road Surfaces	Economic Feasibility	Transportation Industry
			Maintenance (Such as Erosion by Wave Action)	Transportation Industry
Minimum Distance	Construction Method	(Same as Those Listed Above Under Causeway and Roadbed Construction)		
Pleasing Surroundings	Appropriate Selection of Road Location	(Same as Those Listed Above Under Causeway and Roadbed Construction)		
	Construction Method	(Same as Those Listed Above Under Causeway and Roadbed Construction)		
Brine Shrimp Harvesting	Adequate Nutrients	Maintain Conditions Required for Algae Growth	Enhancement of Brine Fly Population	Recreation
			Interference with Other Possible Uses	Recreation M.E. Industry
	Require Brine Concentration Level	Limit Rate of Mineral Extraction	Economic Feasibility	M.E. Industry
			Regulation	M.E. Industry
	Maintain Natural Circulation Patterns	Interference with Other Possible Uses	Transportation Recreation M.E. Industry	

Table 1. Continued.

Possible Uses	Desirable System Characteristic Related to Uses	Some Methods of Achieving Desirable System Characteristics	Some Possible Problem Areas Influenced by Implementation of Methods (Impact Areas)	Some Social Use Areas Affected by Problems	
Brine Shrimp Harvesting (cont.)		Create Artificial Cultivation Areas	Disturbance of Lake Circulation	M.E. Industry	
			Disturbance of Brine Concentration	M.E. Industry	
			Interference with Ecological Habitat	Wildlife	
			Interference with Other Possible Uses	Recreation Water Transportation M.E. Industry	
			Required Oxygen Level in Lake	Natural Processes Adequate Sewage Treatment	None Installation and Operation of Plants
Maintenance of Conditions Free From Harmful Pollutants		Utilize Adequate Control Measures	Interference with Other Possible Uses	Oil Drilling Recreation Industry	
			Regulation	Oil Drilling Industry	
Oil Drilling	Aesthetic Appeal	Structural Design Construction of Facilities in Remote Areas	Economic Feasibility	Oil Industry	
			Economic Feasibility	Oil Industry	
			Access	Wildlife Oil Industry	
	Adequate Transport Facilities	Road Pipeline	(Same as Those Listed Under Mineral Extraction)		
			Line Oil Spill	Recreation M.E. Industry Wildlife	
				Physical Barrier to Free Access to Lake	Wildlife Recreation M.E. Industry
				Maximum Production of Oil	Appropriate Location of Drilling Facilities
Minimize Ecological Effect		Appropriate Location of Drilling Facilities	Lack of Adequate Oil at Location of Drilling Facilities	Oil Industry	

Table 1. Continued.

Possible Uses	Desirable System Characteristic Related to Uses	Some Methods of Achieving Desirable System Characteristics	Some Possible Problem Areas Influenced by Implementation of Methods (Impact Areas)	Some Social Use Areas Affected by Problems
Oil Drilling (cont.)		Minimize Oil Spill Problem	Regulation Appropriate Transportation of Oil	Oil Industry
Water Supply	Fresh Water Storage	Dike Construction in GSL	(Same as Those Listed Under Recreation and Stable Water Level)	
		Construction of Tributary Storage Reservoirs	(Same as Those Listed Under Recreation and Stable Water Level)	
	Supplement Natural Supply	Transbasin Diversions	Interrupted Deliveries During Low Flow Periods	Water Supply
		Weather Modification	Alteration of Biological Habitat	Wildlife Recreation
			Control Processes Not sufficiently well established	Agriculture Recreation
		Recycle Wastewater	Reduced Inflow to GSL	Recreation M.E. Industry Wildlife
Desalt Flow	Reduced Inflow to GSL	Recreation M.E. Industry Wildlife		

on land use within the impoundment area prior to the dam construction.

Table 1 identifies and categorizes some possible problems associated with the major societal uses of the water resource system of Great Salt Lake. For example, the existing railroad causeway across the lake was constructed to accommodate transportation, but the structure is causing some concern to a portion of the mineral extraction industry. Table 1 does not assign priorities to either social uses or to the problems which result from system modification and use. One management objective is to manipulate the system so as to obtain an optimal "mix" of a broad range of uses in terms of the objectives and goals of the using society as a whole. For this reason, a system planner is primarily interested in identifying, and obviating if possible, areas of major negative impact. The problems associated with these major impact areas are those which are most pressing in terms of system management.

In Table 2 an attempt is made to assign relative magnitudes to those areas of impact which are identified by the fourth column of Table 1. Across the top of Table 2 are listed possible changes in the water resource system of Great Salt Lake which might cause some degree of environmental impact. On the left side of the table existing characteristics and conditions of the entire system are listed. Beneath each proposed action a diagonal slash is made opposite each existing condition for which a significant impact by the particular proposed action might be possible. The relative magnitude of the impact is indicated by a number between 1 and 10, and which is situated above the diagonal slash, with 1 indicating minimal impact and 10 an impact of considerable magnitude. The relative social importance of the impact is indicated by a number (also between 1 and 10) which is situated beneath the slash. Thus, for example, a designation of 10/2 suggests an impact of considerable magnitude but of rather low social importance. An example of such an impact is presented under Item II.A.c. and opposite Item I.B.2.d. Although the magnitude of the impact of transbasin diversions on benthic (channel bottom) organisms is apt to be considerable, the social importance of this impact is likely to be minimal. No attempt is made in Table 2 to distinguish between positive and negative impacts. Frequently, a particular action might produce both positive and negative impacts on the same general condition. For example, a transbasin diversion might have negative impacts on fishing in the source channel, whereas in the receiving channel the impacts might well be positive.

Table 2 is helpful in the development of a management model for the lake system because it assists

in defining critical areas of potential environmental impact (and therefore of potential problems) from the standpoint of both magnitude and importance. In this way, insight is increased concerning the kinds of problems which the model should be designed to solve. For example, the table indicates that the construction of dikes and causeways is capable of producing major impacts in terms of both magnitude and importance on the use areas of recreation and tourism, mineral extraction, water transportation, brine shrimp harvesting, and fresh water supplies. On the basis of this analysis a model which is capable of quantitatively evaluating the specific effects of proposed dykes and causeways at particular locations within the lake clearly is needed.

On the basis of an impact analysis provided by Tables 1 and 2, the model development process under the USU project will emphasize initially an ability to examine management problems associated with possible actions in the following areas of activity:

Lake watershed subsystem

1. Weather modification.
2. Transbasin diversions.
3. Construction and operation of dams and reservoirs.
4. Land use practices, including:
 - a. Farming, ranching, and feed lot operations.
 - b. Urbanization, including municipal and industrial sewage outflows.

Near-shore and lake subsystems

1. Changes associated with recreation and tourism, including buildings and offshore structures.
2. The construction of dikes and causeways within the lake.
3. The development of impoundments within the lake, such as reservoirs for mineral extraction activities and those for fresh water storage.
4. Well drilling activities, particularly oil well development.
5. Changes resulting from industrial operations adjacent to and in the lake, such as mineral extraction and other mining operations.

Table 2. Information matrix for assessment of environmental impacts on the water resource system of the Great Salt Lake (modified from Leopold, et al., 1971).

I. EXISTING CHARACTERISTICS & CONDITIONS OF THE LAKE ENVIRONMENT			Instructions		II. CHANGES TO THE PHYSICAL SYSTEM WHICH MIGHT CAUSE ENVIRONMENTAL IMPACT																										
					A. Mod. of Regime		B. Land Transformation and Construction				C. Resour. Extraction		D. Processing				E. Waste-Treat.		F. Chemical Treat.		G. Others										
					Biological controls (Brine fly) Modification of habitat	Transbasin diversions	Irrigation, drainage	Weather modification	Urbanization	Industrial sites and buildings	Airports	Highways and bridges	Railroads	Dams and reservoirs	Dikes and causeways	Recreation structures	Roads and trails	Mineral extraction	Well drilling and pumping	Dredging	Farming	Ranching and grazing	Feed lots	Food processing	Energy generation	Mineral processing	Chemical industry	Oil refining	Other	Landfill	Oil well flooding
A. Physical & Chemical Characteristics	1. Water	a. Surface streams	a	b	c	d	e	f	g	h	i	j	k	l	m	n	o	p	q	r	s	t	u	v	w	x	y	z	aa	ab	
		b. Salt Lake																													
B. Biological Conditions	1. Flora	a. Trees																													
		b. Grass																													
C. Cultural or Societal Factors Relating to the Great Salt Lake	1. Recreation and Tourism	a. Hunting																													
		b. Fishing																													
D. Others	1. Water	a. Quality																													
		b. Recharge																													

System Definition

The basis of system identification is the conceptual model of the real world developed through various kinds of data which are gathered about the system. System identification involves two important steps, both of which are dependent upon the objectives of the study, or the kinds of questions which might be asked of the model:

1. A demarkation of the boundaries or limits of the system to be modeled.
2. The establishment of model resolution in terms of the time and space dimensions and functional considerations (both physical and social).

In the case of the Great Salt Lake study, the long-range goal is to develop a comprehensive planning and management model with predictive and decision-making capabilities of the entire water resource system of the lake. This objective requires a model which is sufficiently broad in scope to consider the entire lake system, including its environs, and also which has adequate resolution in terms of both the time and space dimensions and functional considerations to realistically represent the system. A gross conceptual model of the Great Salt Lake system is shown by Figure 6, which is intended to represent the basic physical and sociological components. With reference to the hydrologic component, the lake itself is a residual quantity whose level, volume, and quality are influenced and determined by characteristics of its tributaries and surrounding areas. Thus, any alteration in the regimen or character of tributary inflows (both surface and subsurface) will affect the lake. Further, this complex hydrologic system, of which the lake is an integral part, has an inextricable influence on the biological and quality components of the total system. Consequently, in order to assess the impacts of any management scheme, a clear identification of the entire system is needed, including the physiographic, hydrologic, salinity, biologic, limnologic, and societal aspects, and the complex and dynamic couplings which are inherent in a system of this nature.

The development of a comprehensive model of a system such as that identified by Figure 6 is a difficult and lengthy process. For this reason, the problem is approached by decomposing the total system into a number of subsystems. For example, each of the boxes shown by Figure 6 might be considered to represent a subsystem. A close examination of any one of the subsystems depicted by this figure would reveal some of its internal processes, and thus lead to an improved conceptual understanding of the system as a whole. The usual approach is to consider the to-

tal system as being organized in terms of hierarchies or levels as shown by Figure 7. This procedure permits the separate identification and subsequent development of models for the various parts of the total system. In this process model resolutions might be varied from one component subsystem to another, depending upon the requirements of the overall model and the available knowledge of each particular subsystem. Eventually, submodels are linked to comprise an overall model of the entire system.

Evaluation and Analysis of Available Studies and Data

The review and evaluation of previous studies and available data for a water resource system is an important step in the simulation of the system. Previous studies involving the system provide insight into system components and allows, when appropriate, established procedures for describing certain components of the system to be included in the simulation model. Data from a particular system or subsystem provide an understanding of the real world, and thereby provide a basis for evaluating model performance. The accuracy of predictions from a particular model is governed to a large degree by the reliability of the information on which the model is based and the accuracy of the data which are input to the model to provide the predicted output functions.

Past investigations of the Great Salt Lake system, which includes the watershed, nearshore, and lake, have been structured toward the investigation of individual components of the system. The result of this kind of uncoordinated research has been that not all components of the system have received attention and in many areas an adequate understanding of specific components of the system has not been attained. Additionally, little work has been done on investigating the interactions between components of the system and on how such interactions affect the entire lake system.

The Great Salt Lake drainage area or watershed is composed of the Bear, Weber, and Jordan River basins, which, when combined, form the major inflow to Great Salt Lake, and a number of minor drainage basins. Components of the Great Salt Lake watershed have been the subject of various studies due to the importance of this watershed in Utah's water development. The Utah Water Research Laboratory and the Utah Division of Water Resources have performed a series of water budget studies of the Bear, Weber, and Upper Jordan drainage areas (Hyatt et al., 1969; Haws et al., 1970; and Haws and Hughes, 1973). Simulation model studies of the hydrology and salinity within the Bear River basin were performed by Hill et al. (1970

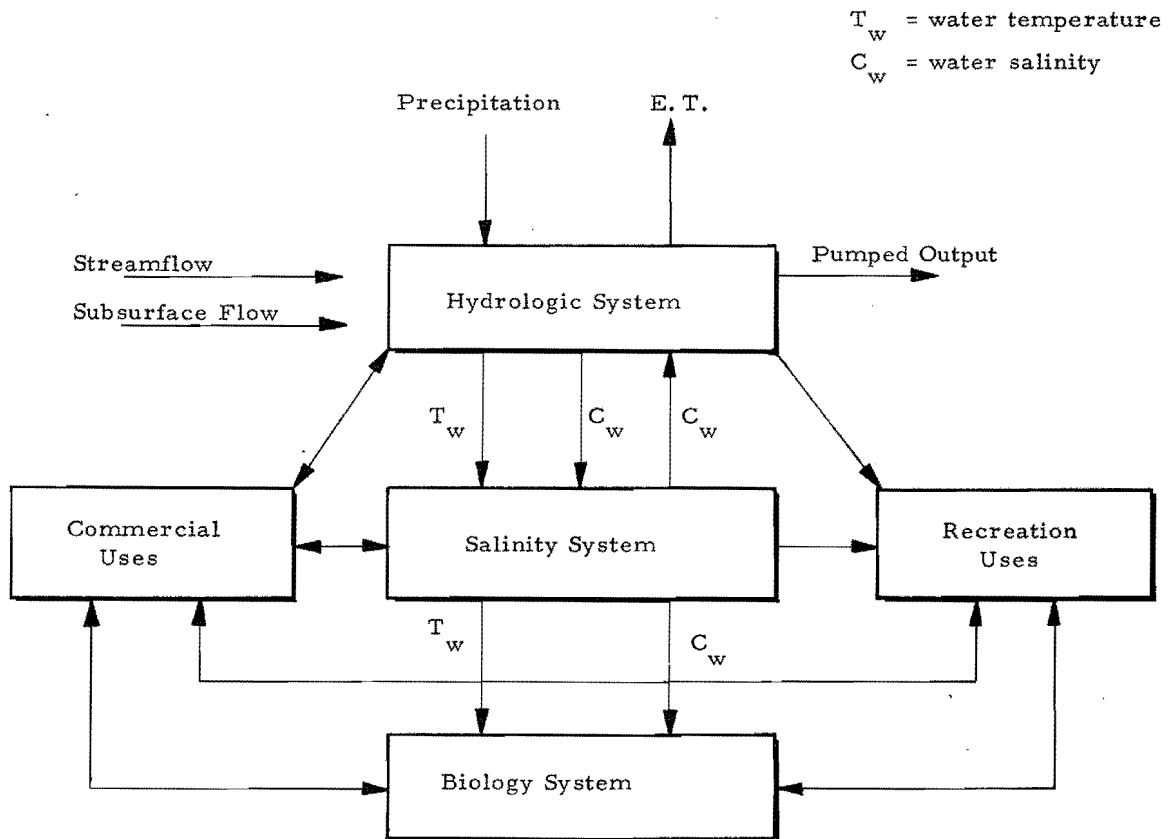

Figure 6. A diagram illustrating interaction between different components of the total system and various kinds of uses.

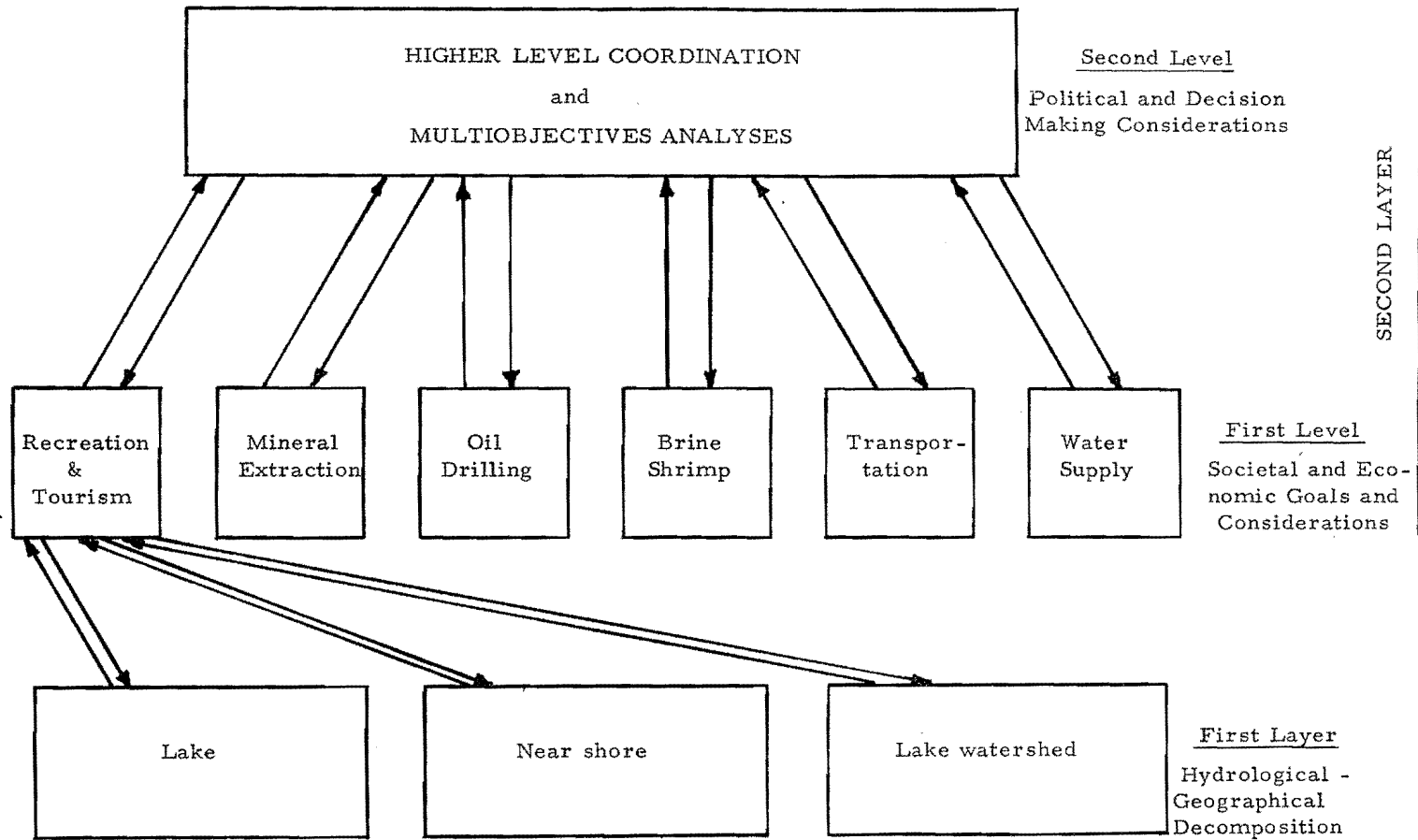

Figure 7. First level hydrological-geographical decomposition.

and 1973). A model study of the Upper Jordan River drainage was carried out by Wang et al. (1973).

Under current studies at the Utah Water Research Laboratory, the high resolution QUAL model (Texas Water Development Board, 1970) and the intermediate resolution (Utah State University River Model - USU RM - Grenney et al., 1974) model are being used to provide simulation models of waste load allocation on each of these rivers. These models cover the Weber-Ogden system from Park City to Kamas to Great Salt Lake, the Jordan River from the Jordan Narrows to Great Salt Lake, and the Bear River from the Utah-Idaho border to Great Salt Lake.

Several studies of the smaller drainage areas of Great Salt Lake also have been performed. A water budget study of the Great Salt Lake Desert area, similar to the water budget analysis of the major rivers, was prepared by Foote et al. (1971). The water resources of Salt Lake County were discussed in Hely et al. (1971) and later simulated in a computer model (Israelsen et al., 1973). Future water use in Utah Valley was modeled by Huntzinger (1971). A water resource allocation model of the entire State of Utah, including Great Salt Lake, has been developed at the Utah Water Research Laboratory (Keith et al., 1973).

The contribution which groundwater makes to the inflow to Great Salt Lake has not been well established. Lofgren (1954) estimates the groundwater inflow to be 30 percent of the total inflow. Current investigators have placed the groundwater contribution at 6-10 percent of the total annual inflow. Many of the estimates of total groundwater inflow to Great Salt Lake have come from water budget studies which estimate the groundwater inflow by balancing inflow, outflow, and storage change in the lake. Major components in a water budget study of Great Salt Lake are evaporation and precipitation on the lake. The accuracy of estimating groundwater inflow using water budget studies should be accepted with the realization that neither evaporation nor precipitation on the lake is well defined.

Groundwater conditions in Utah are investigated by the Utah Department of Natural Resources and the U. S. Geological Survey (USGS). Foote et al. (1971) used the data available on groundwater conditions in the Great Salt Lake Desert to estimate the average annual groundwater inflow to the lake from this area. Studies of this nature should provide better estimates of the total groundwater inflow to Great Salt Lake than estimates made by water budget analysis. Additionally, this type of study provides information on the spatial variation of groundwater inflow.

The near shore area can be considered as a strip of land around the perimeter of Great Salt Lake which contains the marshlands, chemical extraction industries, and sites for recreational facilities. The water requirements for waterfowl marshlands in the vicinity of Great Salt Lake were studied under an extensive project which began in 1959 as a cooperative effort of the Utah State Division of Fish and Game, the Utah Water Research Laboratory, and the USU Cooperative Wildlife Unit. The investigation took place on the Howard Slough management area and the data gathered were used to develop a procedure for determining the monthly and seasonal water requirements for marshlands. The results of the study are summarized in Christiansen and Low (1970). This report presents a method for calculating marshland water requirements based on the salinity of flow, the evapotranspiration (consumptive use) from the marshland, and the precipitation on the marshland. The study not only provided a means for estimating water requirements of marshlands, but also through the development of the necessary background information and data, provided insight into the tolerance of marsh plants to salinity and the evaporation losses to be expected within marshlands.

Marshlands often provide the necessary environment for producing mosquitos. Methods of mosquito control on marshlands through the proper regulation of water levels were described by Rees et al. (1966). In this series of studies it was shown that water management techniques and practices effectively used in mosquito abatement often improved the marshes for waterfowl and other wildlife.

Great Salt Lake is an important component of the entire Great Salt Lake system. Physical processes within its boundary have been studied in a series of single purpose studies with the goal of describing specific aspects of the lake system.

Evaporation, perhaps because it is the only outflow from Great Salt Lake, has been the subject of a number of studies. In 1932, T. C. Adams established a method of estimating the evaporation from the Great Salt Lake by correlating pan evaporation of salt and fresh water. The work done by Adams has been referred to in most of the subsequent studies of evaporation from Great Salt Lake.

Harbeck (1955) investigated the effects of salinity on evaporation from a theoretical basis and used the results obtained by Adams to verify his findings. Dickson, Yepsen, and Hales (1961) performed laboratory measurements of the vapor pressure of Great Salt Lake brine at various concentrations and temperatures. Dickson (1962) and Dickson and McCullom (1965) used vapor pressure, wind speed, temperature, and

humidity data collected in the vicinity of Great Salt Lake to estimate evaporation using the eddy flux technique. Their results indicated evaporation from Great Salt Lake was greater than predicted in earlier studies. Precipitation on the surface of Great Salt Lake constitutes a major inflow to the lake. Research on the distribution of precipitation over the lake at this time has not progressed much beyond the preparation of isohyetal maps, by E. L. Peck, which include the Great Salt Lake regions.

Several water budget analyses have been performed on Great Salt Lake with the goal of better defining the magnitude of the components which contribute to lake inflow and outflow. Peck and Dickson (1965) used a water budget analysis in which monthly precipitation, surface inflow, and change in storage of the lake were assumed to be known from basic data. Unknown quantities were evaporation and groundwater inflow. Although no specific estimates of groundwater inflow or evaporation were made, the study concluded that groundwater contributes significantly to the lake with the exact amount being related to the amount of evaporation.

Palmer (1966) proposed a yearly water budget for the years 1930-1963. The average annual inflow to the lake was estimated at 1,690,000 acre-feet (excluding precipitation) with 6 percent of the inflow contributed by groundwater.

Steed (1972) prepared a water budget analysis for 1944-1970 in which monthly terms were used. Average annual inflows were found to be 1,756,000 acre-feet of surface flow, 206,000 acre-feet of groundwater, and 685,000 acre-feet of precipitation. Outflows included 2,493,000 acre-feet of evaporation and 151,000 acre-feet of evapotranspiration.

The chemical makeup of the dissolved mineral inflow to Great Salt Lake and the makeup of Great Salt Lake brine has been investigated mainly by the USGS and Utah Geological and Mineralogical Survey (UGMS). Hahl and Mitchell (1963) present a compilation of data collected from July 1959 through June 1962 to aid in the definition of the chemical composition of streams, drains, and springs discharging into Great Salt Lake and, additionally, to define the chemical composition of the lake brine. Hahl and Langford (1964) is a continuation of the above study and reports on conclusions drawn from the above data.

During the 1964 water year more detailed data were obtained on surface inflow at sites closer to the lakeshore. Hahl (1968) used these data to estimate the salt inflow at the lakeshore for water years 1960, 1961, and 1964. The data for 1960 and 1961 were collected during low inflow and low lake stage years. The fact that data for high flow years were not included may affect the estimate of salt inflow to the lake which Hahl obtained.

Using data on the brine concentration within the lake from 1963-1966, Hahl and Handy (1969) concluded that four types of brine coexist in the lake. The northern arm (north of the railroad causeway) was found to contain a typical concentrated brine, while the brine in the southern arm was divided into three distinct concentration categories or zones, namely: (1) from the surface to a depth of about 16 feet; (2) below 16 feet and assumed to originate from flow from the northern arm through the causeway; and (3) below 16 feet and assumed to originate from groundwater inflow. The four brine types (that of the northern arm and the three zones in the southern arm) are illustrated by Figure 8.

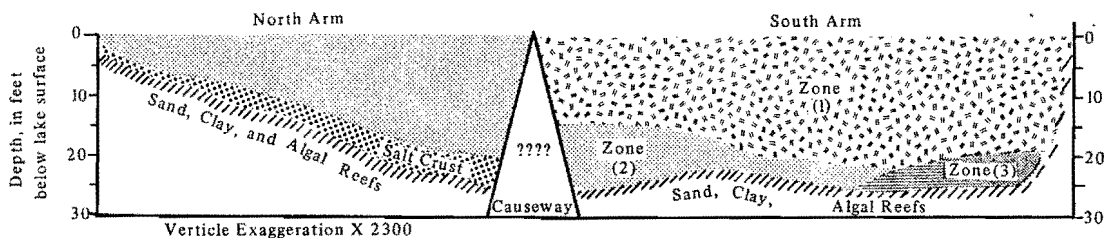

Figure 8. The four brine zones within Great Salt Lake (after Hahl and Handy, 1969).

The UGMS and the USGS have conducted preliminary investigations of the circulation patterns within Great Salt Lake. Figure 9 illustrates the general circulation patterns within the lake since the construction of the railroad causeway. The UGMS and the USGS are continuing to gather data which will provide further information on circulation patterns and the distribution of dissolved solids within the lake.

Lin et al. (1972) report on data collected during the summer of 1972. Detailed vertical profiles of temperature, dissolved oxygen, conductivity and pH values were measured among 17 buoy stations installed at the south end of the lake. Lin also found a deep and more dense brine underlying portions of the south end brine. It was pointed out that the collection of such detailed data for the first time allowed the observation of the very subtle characteristics of the lake water, and that more extensive study of the same type will lead to answers to questions such as the occurrence of deep brine (Figure 8).

The salt distribution problem which resulted from the construction of the Southern Pacific Transportation Company's causeway across Great Salt Lake prompted studies of the effects which the causeway is having on the lake and possible solutions to the problem. The net movement of salt to the northern arm was reported in a brief article by Adams (1964). Because of the decreasing density of the brine in the southern arm, the salt extraction companies located there became deeply concerned with finding the cause and a solution to the problem. Clyde, Criddle, and Woodward, Inc., Consulting Engineering Firm, was retained by several salt companies to establish the fundamental reasons for the changes in salt content. The firm's 1970 report links the density change to the railroad causeway and concluded that an opening in the causeway 1500 feet long would be required to restore pre-causeway conditions. This conclusion was based on an assumption of a small flow through the causeway fill.

A reconnaissance study by Madison (1970) indicated that a net load of about 0.30 billion tons of dissolved solids had moved from the south to the north part of the lake from 1963 to 1969 due to effects of the causeway. Madison recommended that a detailed study be made to enable predictions of long-term effects of the causeway.

During 1970-72, the USGS and the Utah Geological and Mineralogical Survey carried out an investigation based principally on Madison's recommendations. The purpose of the study was to determine the net movement of dissolved solids through the causeway during 1971-1972 water year, to predict salt load

movements during rising and falling lake stages for the existing causeway through the use of a simulation model, and to predict the possible effects of various culvert widths on load movement. The study gives culvert widths required to establish various conditions in the relation between the north and south arm brines and recommends that the results be verified with additional data. The study also recognizes that the economic and social impacts must be considered in any decision to alter the widths of the present causeway culverts.

Two additional models of flow through the causeway have been developed. Lin and Lee (1972) developed a Hele-Shaw model of seepage flow through the causeway and suggest that the model study, when coupled with field investigations, should provide all the information needed to assess the impacts of the causeway. Cheng and Hu have submitted a report for publication in the Journal of the Hydraulics Division of the American Society of Civil Engineers in which they present a mathematical model of a two-fluid flow system through a homogeneous porous media. Results of the numerical solution are correlated with that of a Hele-Shaw experiment.

The USGS in Salt Lake City will incorporate the causeway model they developed into a simulation model of Great Salt Lake which is currently under development. The model which the USGS is developing will divide the lake into three or four units and assume complete horizontal mixing within each unit, but will not deal with vertical stratification. The model will be used to study the effects produced by changes in the inflow and will also analyze the various diking schemes proposed for the lake.

Life species which inhabit the waters of Great Salt Lake are few due to the harsh environment created by the high brine concentration. Organisms include bacteria, several species of green and blue-green algae, several species of protozoans, one species of crustacean (brine shrimp), and two species of brine fly. In addition, forms typical of fresh water are found in the lake on occasion, but it is felt that these are extraneous forms which have been washed in from freshwater bays and probably survive for only short periods of time.

Most of the biological work on the lake was done in the 1930s. Flowers (1934) found four species of blue green algae and two species of green algae. Kirkpatrick (1934) cultured lake waters in the laboratory in an attempt to separate native from extraneous algal forms. She reported 13 species of algae as well as some protozoans. Patrick (1936) identified 24 genera and 62 species of diatoms from lake bottom samples. Eardley (1938) reviewed the literature on life in the lake and listed the brine shrimp, three flies, five pro-

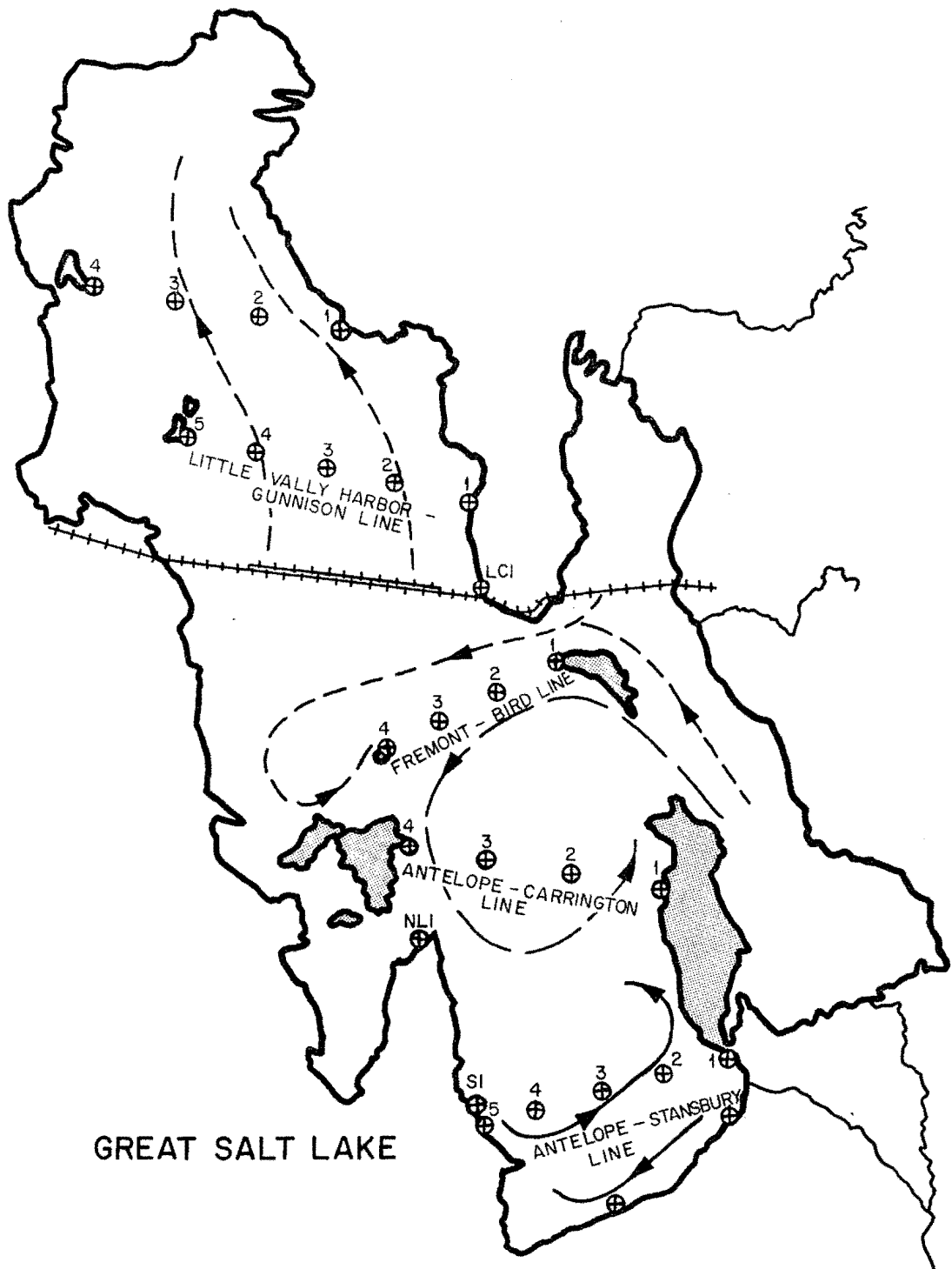

Figure 9. General circulation patterns and UGMS brine and sediment sampling sites within Great Salt Lake.

tozoans, and 13 species of algae. ZoBell et al. (1937) worked on the bacterial flora of the lake.

Recently, work has progressed toward understanding the interactions between organisms in the lake and the fate of pollution which enters the estuaries (bays) of Great Salt Lake. Porcella and Holman (1972) reported on the relationship between nutrients, algal growth, and brine shrimp in the southern arm of Great Salt Lake. Coburn and Eckhoff (1972) and Meide and Nicholes (1972) report on the fate of pollution input to the Great Salt Lake estuaries. Still needed, however, is a complete ecological study of Great Salt Lake on a seasonal basis.

Over the years, various government agencies (federal, state, and local) and other groups have collected considerable quantities of data relating to the water resource system of Great Salt Lake. For example, records of lake levels have been maintained on a monthly basis by the U.S. Geological Survey since 1875. Even so, data deficiencies exist for many aspects of the system, and these inadequacies will become more apparent as the modeling process is continued. The LAKE COM Report (1973, p. 14) lists five specific areas of data deficiency pertaining to the lake system as follows:

1. Evaporation and rainfall.
2. Lake currents and general water movement patterns within the lake.
3. Geologic or subsurface conditions as indicated by seismic and gravity soundings.
4. The effects of high sulfur concentration levels in the lake brines on the extraction of other salts.
5. Groundwater conditions beneath the lake, including subsurface inflow rates.

The preceding list is not intended to be exhaustive, but was a list of the major areas of data deficiency discovered by LAKE COM during their investigation. As part of this study a preliminary investigation was conducted to evaluate the adequacy of available data, defined in terms of spatial and temporal resolution requirements, as currently envisioned for the development of a management model of the lake system. The results of this survey are summarized by Table 3. The data for the various categories in the table have been rated as adequate, reasonably adequate, or not adequate for the three general areas of the Great Salt Lake basin (watershed, nearshore, and lake).

Model Formulation

Model formulation is the step between the conceptual model and the working model indicated by Figure 3. The form of the model which is used is dependent entirely upon the requirements of the problem (the objectives) and the data which are available for the study. Some insight into this process might be obtained by comparing a model to predict the effects of increased fresh water inflows on average lake salinity concentrations with a model developed to predict the fate of oil spills in the lake. In the case of the first model, brine concentrations at specific locations in the lake are not needed and so the spatial resolution can be gross. However, the second model requires a high degree of resolution in the space dimension. Thus, the requirements of the problem always are a prime consideration in model formulation and design, including the selection of appropriate time and space increments.

The hierarchical-multilevel structure shown by Figure 7 is achieved through the combination of several models which become submodels in the hierarchical structure (Haines, 1973). Two layers are recognized in the hierarchical structure, namely, an information layer (first layer) and a prediction and optimizing layer (second layer). The second layer is composed of two levels: (1) societal and economic goals and considerations (first level); and (2) political and decision-making considerations (second level). The first layer represents the various physical aspects of the system, while the first models for each of the six major uses of the lake system as listed earlier in this report. Clearly, any decision in the second level of the second layer which requires a change in some aspect of the physical system (first layer) in order to accommodate a particular use in the first level of the second layer will create an adjustment throughout the entire system which will have a trade-off affect on other societal activities. For example, a societal activity such as oil drilling might cause oil spills which will have an impact on the ecology of the lake, and in turn influence tourism and recreation. Thus, it is possible to view the second layer shown by Figure 7 as the cause and the first layer as the effect on the physical system, which in turn has a further effect on the second layer. The second level of the second layer represents the decision-making processes which coordinate and evaluate these cause and effect interactions and the trade-offs among the various societal uses and activities.

At the lowest layer of the hierarchy (first layer), the impacts of decisions and policies made by man and society on the Great Salt Lake system from a hydrological, limnological, and ecological point of view over a short, intermediate, and long time horizon are analyzed.

Table 3. Summary of the adequacy of data within the Great Salt Lake system.

Category	Classification	Primary Data Collection Agency	Adequacy	
			Watershed	Near Shore Lake
Meteorological	Precipitation	NOAA, USGS ^a	A ^b	N ^b
	Wind	NOAA, USGS	A	N
	Radiation	NOAA, USGS	A	N
	Evaporation	NOAA, USGS	A	N
	Cloud Cover	NOAA, USGS	A	N
	Air Temperature	NOAA, USGS	A	N
Hydrological	Streamflow	USGS	A	P ^b
	Subsurface Flow	USGS	A	P
	Soil Characteristics	SCS	P	-
	Snow Data	SCS	A	-
Limnological	Lake Levels	USGS, UGMS	-	P
	Lake Circulation Patterns	USGS, UGMS	-	N
	Lake Water Temperature	USGS, UGMS	-	N
	Density Stratification	USGS, UGMS	-	N
Water Quality	Lake Brine Concentrations	USGS, UGMS	-	N
	Stream Quality Characteristics	USGS, UGMS, UDH, USWPCB	A	P
	Lake Quality Characteristics	USGS, UGMS, UDH	-	N
Ecological	Brine Shrimp		-	P
	Algae etc. (micro-organisms)		-	P
	Insect Control	USPHS, UDH	P	P
	Land Use	UGMS, BLM	-	P

Table 3. Continued.

Category	Classification	Primary Data Collection Agency	Adequacy	
			Watershed	Near Shore Lake
Geological	Lake Bottom Topology	USGS, UGMS	-	N
	GSL Predecessors (Lake Bonneville)	USGS, UGMS	A	A
	Bottom Sediments	USGS, UGMS	-	N
Wildlife	Marshland Users & Inhabitants	UDWR, USBSFW	A	A
	Island Users & Inhabitants	UDWR, USBSFW	-	A
Societal	Recreational Uses	NPS, UDWR, USPRD, BLM	A	P
	Industrial Uses	UGMS, USBM	A	P
	Population Information	USDES		
	Land Use		A	A

^aNOAA - National Oceanic and Atmospheric Administration
 USGS - U.S. Geological Survey
 SCS - Soil Conservation Service
 UGMS - Utah Geological and Mineralogical Survey
 UDH - Utah Division of Health
 USWPCB - Utah State Water Pollution Control Board
 USPHS - U.S. Public Health Service
 UDWR - Utah Division of Wildlife Resources
 USBSFW - U.S. Bureau of Sport Fisheries and Wildlife
 NPS - National Park Service
 USPRD - Utah State Parks and Recreation Division
 BLM - Bureau of Land Management
 USBM - U.S. Bureau of Mines
 USDES - Utah State Department of Employment Security

^bA = Adequate
 P = Partly Adequate
 N = Not Adequate

Thus, it is clear that the problems considered at this first layer are of three dimensions as follows:

1. Geographic-Hydrological Considerations
 - a. The lake itself
 - b. Near shore
 - c. The watershed
2. Temporal Considerations
 - a. Short term time horizon (1-5 years)
 - b. Intermediate term time horizon (5-15 years)
 - c. Long term time horizon (15-50 years or over)
3. Functional Considerations
 - a. Hydrological
 - b. Limnological
 - c. Ecological

A variety of considerations may be adopted for decomposition of the system, depending on the solution desired. For example, if the desired solution depends on examining the system from a functional point of view, a functional decomposition of the system logically is suggested. In this situation, all time horizons and all parts of the Great Salt Lake system (hydrological, limnological, and ecological) will be included in each functional submodel. In other words, for the functional decomposition the temporal and geographical-hydrological dimensions may be viewed as parameters for the first layer decomposition, and an overlapping coordination is then applied (Haines and Macko, 1973). In other words, a functional decomposition at the first layer in one hierarchical structure and a geographical-hydrological decomposition at the first layer in another hierarchical structure might be integrated through an overlapping coordination between the two structures. This procedure frequently provides considerable insight into the system. Hydrological considerations are apparent from the need to concentrate on specific considerations within these groups. The temporal considerations are included because decisions may have entirely different and possibly converse impacts on the short term versus the long term planning horizons.

The first level of the second layer in the hierarchy takes into consideration the societal and economic goals. These societal and economic goals have been identified and decomposed into several major components. Each of the six earlier named activities and goals must be quantitatively analyzed with respect

to its benefits and utilities, cost to the public and environment, its impact on the hydrological, limnological, and ecological aspects of the lake and its basin over the short, intermediate, and long-term planning time horizons. In particular, all the information needed for analyzing and evaluating the trade-offs among all these activities will be provided at this level of the hierarchy. The trade-off analysis is conducted at the second level of the second layer by means of the multi-objective function analysis.

The major efforts associated with the first level relate to the identification of measures (decisions) that are aimed at enhancing the achievement of the economic and societal goals; the constructions of the corresponding objective functions which represent the earlier six stated activities and goals; the identification and construction of all the constraints - technical, physical, ecological, hydrological, economical, societal, political, legal, and others as related to the time domain; identification of all the needed data to be designed, collected, transferred, processed, and analyzed along with their associated cost and worth; and finally, provision of a basis for coupling all these economic and societal activities at the second level of the second layer in the hierarchy.

The development of utility functions, objective functions, and the systems input-output relationships, as well as the construction of the system constraints constitute the heart of the modeling efforts. This task is particularly difficult for large-scale and complex problems, such as a comprehensive planning effort involving Great Salt Lake and its basin. Here there are many competing, conflicting, and non-commensurable objectives and goals which may be difficult to quantify. These objectives and goals are functions of many variables including a dependency on the time and space dimensions.

The classical methodologies in cost-benefit analysis or, as often referred to, cost-effectiveness analyses, identify different classes of costs and benefits (primary, secondary, and tertiary). Tangible and intangible costs and benefits are generally quantified in terms of the same units so they can be analyzed and compared with each other. Weighting coefficients which transfer one unit of activity one to a commensurable unit of activity two have traditionally been introduced to facilitate the comparative analysis. This is the case, for example, in multiobjectives analyses when the parametric approach is being utilized.

In this study, a more realistic approach is advocated for the construction and evaluation of the various competing objectives and goals associated with the

planning for the development and management of Great Salt Lake and its basin. This approach recognizes the difficulties in commensurating environmental quality, for example, with economic terms (costs or benefits). Accordingly, the various societal and economic objectives and goals discussed in the previous sections are each modeled in its own unit and terms. Consequently, several non-commensurable objective functions are produced. These objectives are then evaluated at the highest level in the hierarchy by means of the surrogate worth trade-off method (SWT) (Haines and Hall, 1974). A major feature of the SWT method is its capability to quantitatively and systematically evaluate non-commensurable multiobjective functions in terms understood and acceptable to the decision-maker. The application of the SWT method is discussed in Chapter V of this report.

The models associated with each of the subsystems at each layer in the hierarchy are likely to be different from each other - both in structure, scope, and complexity. The models associated with the first layer in the hierarchy, for all three different decomposition schemes discussed (hydrological-geographical, temporal, and functional decomposition), are information oriented models - to distinguish from optimization oriented models. They are aimed at providing information and future prediction related to the specific aspect of the system that they (model) represent.

The models associated with the first level-second layer, in the hierarchy may be classified as both information oriented-predictive models and optimization oriented ones. The optimization procedure itself, by manipulating the control measures (both the technical and nontechnical ones), is carried on at the second level-second layer of the hierarchy.

The utility and objective functions and the system's constraints are all constructed at the first level-second layer of the hierarchy. For example, consider the recreation-tourism subsystem. A utility function or functions should be constructed which relates the desirable goals associated with this subsystem such as stable lake water level, low health hazard, and easy access to the control measures such as construction of dikes and tributary storage reservoirs, adequate sewage treatment, mosquito control, and the development of parks, beaches, and associated features.

Under the SWT approach utility functions are not necessarily expressed in monetary terms. They may be in units of level of the water in the lake, number of users of the recreation facilities, level of health hazard, sensitivity of water level in the lake to other control measures, such as flow of tributaries to the lake and reservoir operations. The construction of the

utility functions in non-commensurable terms to each other is made viable by the SWT method (Haines and Hall, 1974; Haines, Hall and Freedman, 1975). Thus, while these optimization oriented objective functions are constructed at the first level-second layer of the hierarchy, they will be all together (all from first level subsystems) analyzed and their trade-offs evaluated at the second level in the hierarchy in order to achieve a solution which is acceptable to the decision-makers.

As suggested by Figure 7, a comprehensive management of the water resources system of Great Salt Lake is necessarily based on a realistic and adequate representation of the physical aspects of the system (first layer). For this reason, the component subsystems at this level will be emphasized during the early stages of the study to develop a comprehensive model of the entire system depicted by Figure 7. As was indicated earlier, a close examination of any of the component subsystems shown by this figure would reveal the major internal processes. For example, with reference to the box of Figure 7 which indicates the "lake watershed," the hydrologic processes within this box logically could be represented by the typical block flow diagram of Figure 10. In this diagram the blocks represent storage locations within the subsystem and the lines represent various processes by means of which water is transferred from one storage location to another. Thus, the subsystem which represents the lake watershed is identified and the modeling process is able to continue. This same procedure will be followed in identifying the subsystems of the near shore and the lake itself and eventually for the entire system as shown by Figure 7. As the real world system is better understood, the conceptual model is adjusted to coincide more closely with the system of the real world. In this case, the filtering loss is lessened between the real world and the conceptual model, as indicated by Figure 3.

Watershed submodels

As indicated earlier, initial emphasis in model development under this project will be placed on the physical aspects of the lake system. The three major space units which are delineated for this portion of the total system are indicated by the three boxes at the bottom of the diagram of Figure 7. The lake watershed is composed primarily of the drainage basins of the Jordan, Weber, and Bear Rivers. Under previous projects at the Utah Water Research Laboratory (UWRL), hydrologic models of these three basins already have been developed (Israelsen et al., 1968; Hill et al., 1970; Wang et al.,

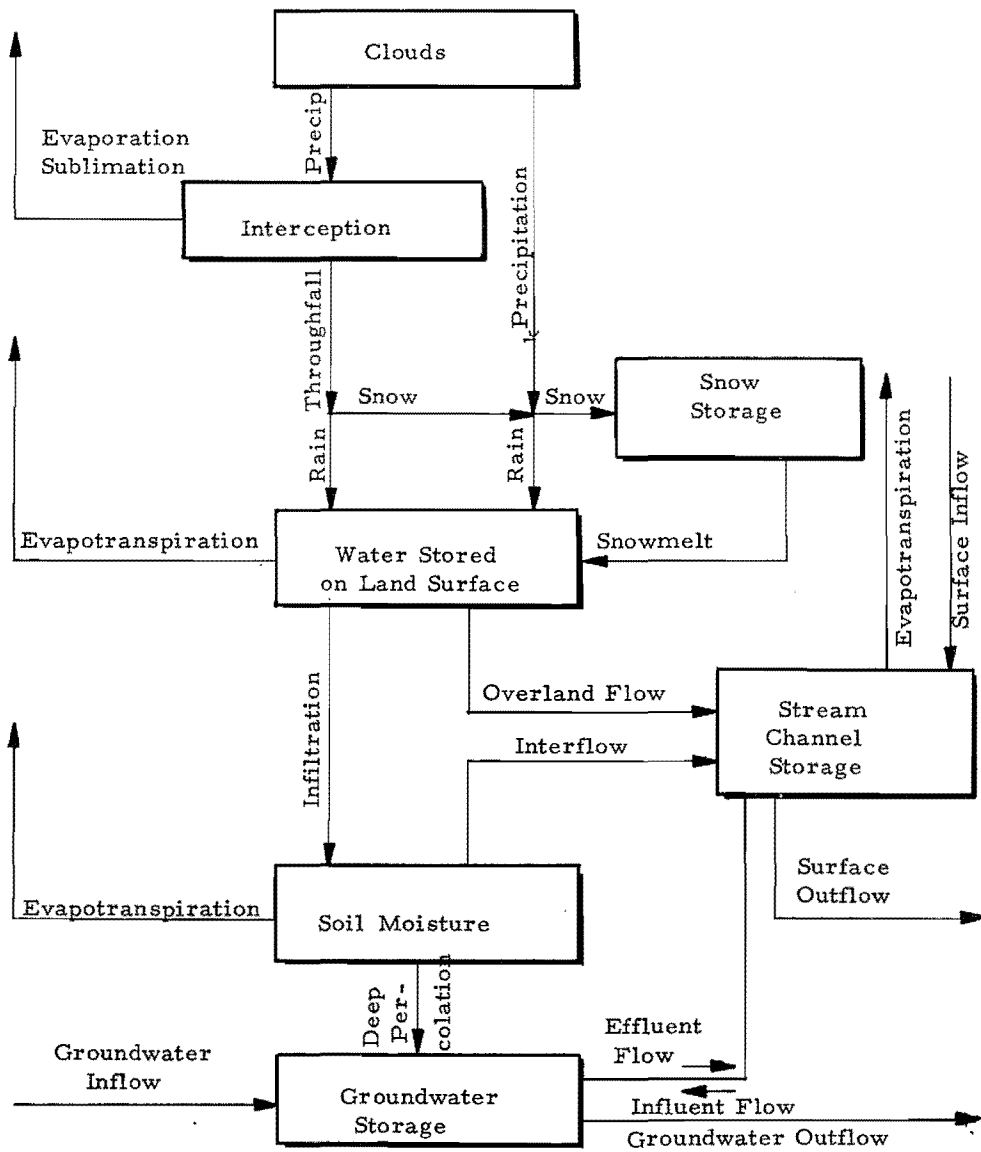

Figure 10. A flow diagram of the hydrologic system within a typical watershed area.

1973). These models are structured generally in accordance with the hydrologic flow diagram of Figure 10. In a subsequent study, the salinity dimension was added to the hydrologic model of the Bear River system (Hill et al., 1973). Under two current projects at the UWRL, multi-dimensional hydrologic-quality simulation models are being developed for parts of the three river drainage basins. These models cover the Weber-Ogden system from Park City and Kamas to the Great Salt Lake, the Jordan River from the Jordan Narrows to Great Salt Lake, and the Bear River from the Utah-Idaho border to Great Salt Lake.

Lake and near shore submodels

The immediate objective of this study, then, is to complete the submodel components of the first layer shown by Figure 7 by developing hydrologic and water quality models of the near shore and lake areas. The near shore area is envisioned as being the transition zone between the watershed and lake areas. Depending upon circumstances, this transition zone might be included in either one of the other two components. For example, the benchlands situated west of the mouth of the Weber River Canyon might be included in the watershed submodel, while the Willard Bay reservoir might be contained in the lake submodel. The near shore area also contains the mineral extraction industries. Effects which are introduced by this kind of activity can be considered as point inputs to the lake submodel.

The computer model of the hydrologic and water quality components of the lake subsystem will be developed by applying a finite difference technique, and employing a steady-state solution which will allow long-term (seasonal) gradients to be simulated. A model structure based on a linked node system developed by Chen and Orlob (1972) is shown by Figure 11. This structure has been used for modeling numerous lakes and estuaries. Dailey and Harleman (1972) and Hann and Young (1972) also have reported on similar models. The advantages of using the finite difference technique for the lake submodel in this case are as follows:

1. The method is now developed to the point where it is applicable as a practical tool for simulation.
2. The model will allow vertical and horizontal stratification to be investigated which is not possible if complete mixing is assumed. This will allow the refinement necessary for a management model.
3. The steady-state model is relatively inexpensive in computer time as compared with dynamic or time varying models, but is still of sufficient resolution (accuracy) to be a useful management tool.

4. The finite difference grid is sufficiently flexible to incorporate proposed as well as existing man-made barriers.

5. A two-dimensional grid of this type is superimposed upon the lake.

The grid has the flexibility to be able to incorporate islands and natural and man-made barriers. Concentrations of various water quality constituents are predicted at the nodes and transport among adjacent nodes is accomplished by the "linking-equations" which connect the nodes. Because of the importance of modeling the vertical stratifications of the lake, three horizontal grids will be applied:

1. A top grid to represent the less dense layer of water.
2. A lower grid to represent the dense layer of water.
3. A grid to represent the bottom characteristics.

Linking-equations will be provided for the vertical dimension as well as the horizontal dimension so that a three-dimensional model will result, as shown in Figure 12. Linking-equations in the horizontal grid will simulate advection, dispersion, and biochemical reactions occurring among constituents as follows:

$$\frac{\partial AC_i}{\partial t} = -\frac{\partial QC_i}{\partial x} + \frac{\partial}{\partial x} \left[AD \frac{\partial C_i}{\partial x} \right] + R_i + S_i \quad (1)$$

in which

- C_i = concentration of the i^{th} water quality constituent
- t = time
- x = horizontal distance between nodes
- A = cross-sectional area of a hypothetical channel between nodes
- Q = flow between nodes
- D = longitudinal dispersion coefficient
- R_i = a function representing the rate of loss or gain of constituent i due to biochemical reactions
- S_i = the rate of loss or gain of constituent i due to external sources and sinks

The linking-equations in the vertical dimension will simulate dispersion as follows:

$$\frac{\partial AC_i}{\partial t} = \frac{\partial}{\partial z} \left[AD \frac{\partial C_i}{\partial z} \right] \dots \dots \dots (2)$$

in which

- z = distance in the vertical dimension

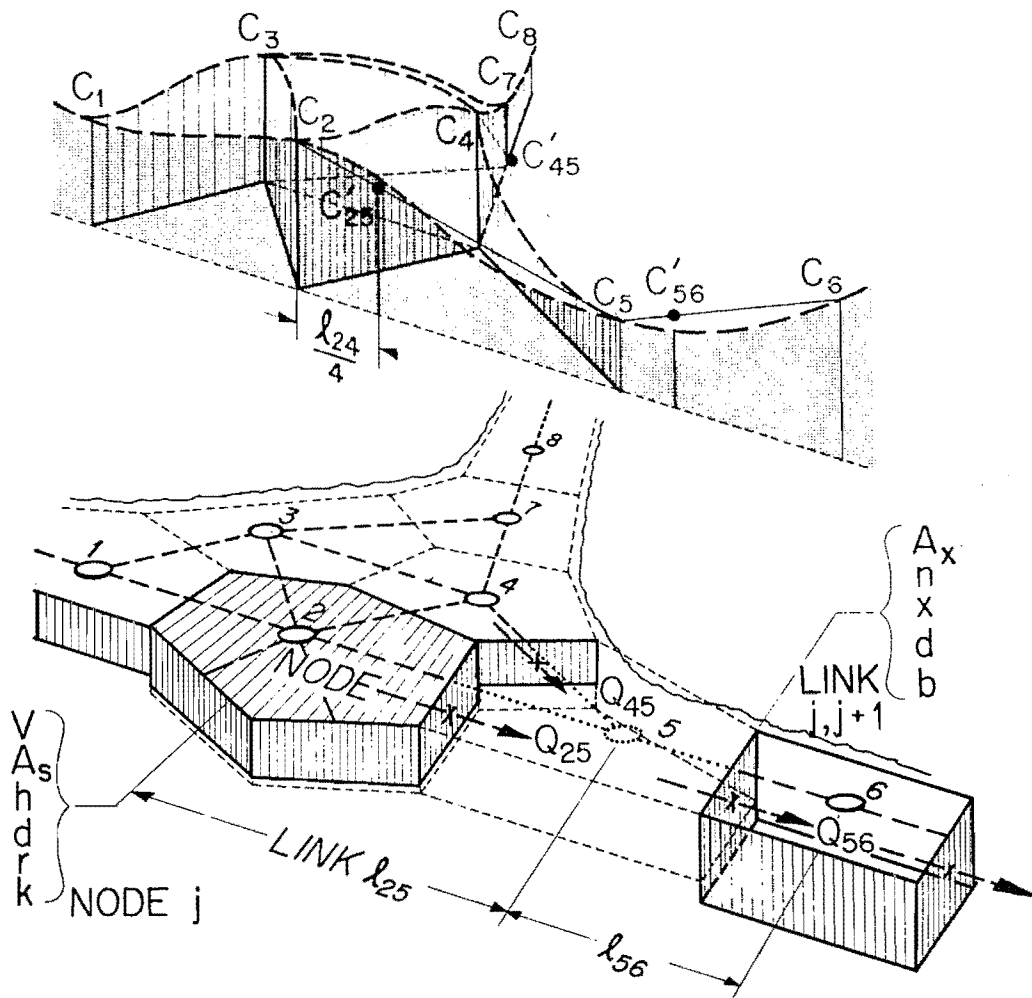

Figure 11. Diagram of the horizontal grid in a node-link model (after Chen and Orlob, 1972).

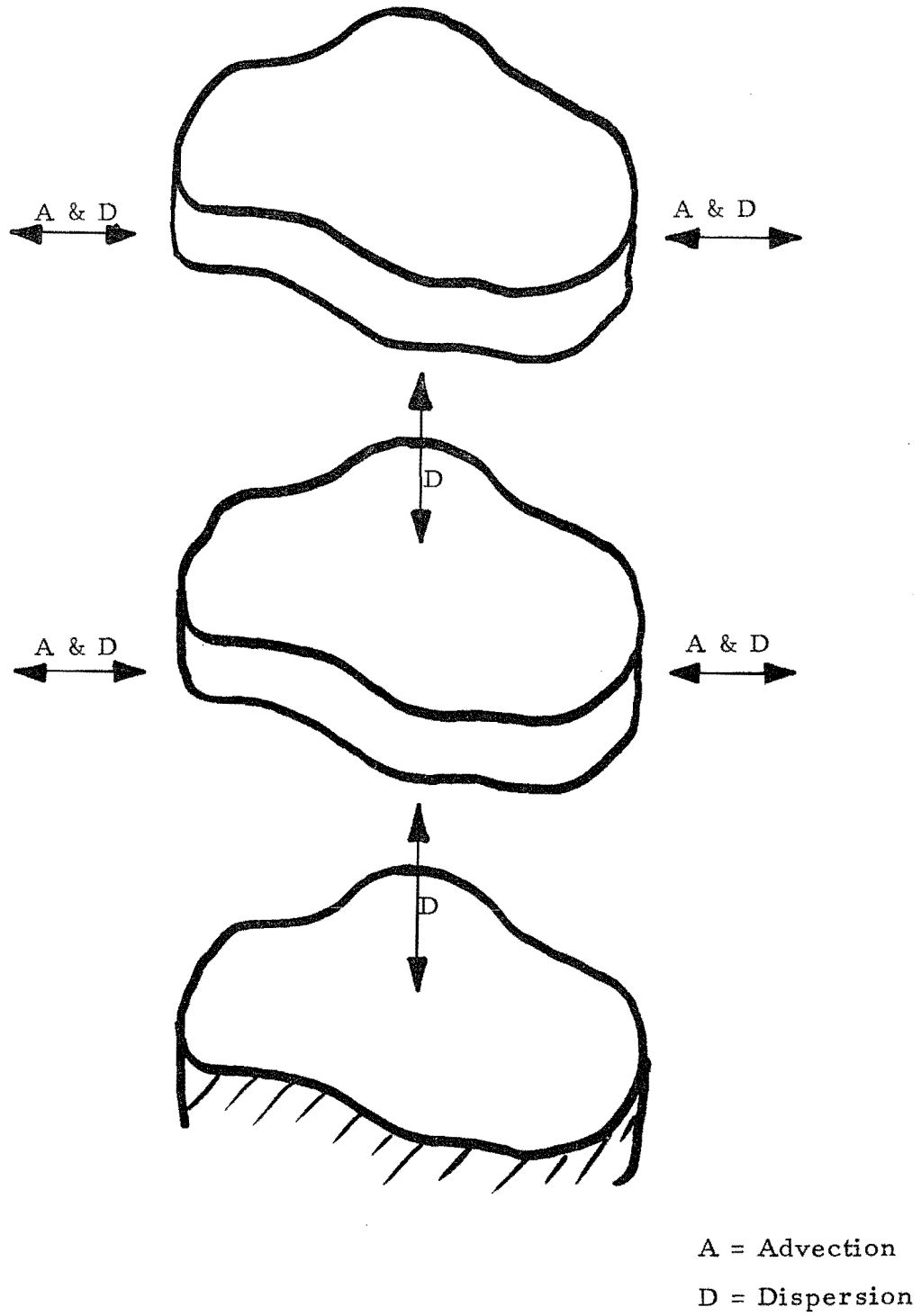

Figure 12. Diagram of one column of nodes in a three-dimensional node-link model.

The model will be developed to predict seasonal trends, rather than short term changes, within the lake system. Under this time resolution it is anticipated that distributions in the lake will approach steady-state conditions and that the rate change in concentrations with respect to time goes to zero.

If input flow and current patterns are those averaged over the season of interest, Equations 1 and 2 are further simplified to a system having constant coefficients. An efficient solution algorithm will be based on a stepwise procedure (Grenney and Bella, 1971) which incorporates both numerical and closed-solution techniques.

Besides being able to predict the effects of upstream (watershed) changes on the hydrologic and salinity aspects of the lake, the model will be capable of monitoring important water quality constituents, including:

- Ammonia - nitrogen may be a limiting factor in micro-organism growth
- Phosphorous - important in ecological systems and many leach out of bottom sediments
- Biological oxygen demand (BOD) - an important parameter in state water quality monitoring and an indicator of pollution levels
- Coliform bacteria - an important parameter in state water quality monitoring and an indicator of the presence of disease causing bacteria
- Temperature - an important parameter in determining the potential biological activity
- Dissolved oxygen (DO) - an important parameter in state water quality monitoring and important to the healthy state of important living organisms, such as brine shrimp

Model Verification

Computer synthesis

The basic premise of the approach discussed by this report is the representation of the Great Salt Lake and its surrounding basin by a hierarchy of mathematical models. The physical component of the overall system will be represented by describing and simulating the real physical system of the lake as accurately as is both possible and feasible. In particular, the coupling relationships among the various systems inputs, outputs, exogenous variables, and other decision variables are related and accounted for in the model.

A computer model of a water resource system is produced by programming on a computer the mathematical relationships and logic functions of the system model. The model does not directly simulate the real

physical system, but is analogous to the prototype because both systems are described by the same mathematical relationships. A mathematical function which describes a basic process, such as evapotranspiration, is applicable to many different hydrologic systems. The simulation program developed for the computer incorporates general equations of the various basic processes which occur within the system. The computer model, therefore, is free of the geometric restrictions which are encountered in simulation by means of network analyzers and physical models. The model is applied to a particular prototype system by establishing, through a verification procedure (sometimes called validation or parameter identification), appropriate values for the "constants" of the equations required by the system.

Model calibration and testing

A general model is applied to a particular system (often referred to as the prototype) through a verification procedure whereby the values of certain model parameters are established for that particular system. Verification of a simulation model is performed in two steps, namely, calibration (parameter identification), and testing of the model. Data from the prototype system are required in both phases of the verification process. Model calibration involves adjustment of the model parameters until a close fit is achieved between the model output and the corresponding observed output of the prototype system. It therefore follows that the accuracy of the model cannot exceed that provided by the historical data from the prototype system. Evaluation of the model parameters can follow any desired pattern, whether it be random or specified.

Model Operation

The model is, of course, operated during the verification procedure, and at this time comparisons are made to test the ability of the model to represent the system or subsystem of the real world. It is very possible that these tests will indicate that some adjustments are necessary, either in the need of more data on which the model is based, or in the structure of the model itself. The various options associated with this looping, or "feedback" procedure are indicated by the flow path labeled "compromises" on the diagram of Figure 4. When suitable model verification has been achieved, the model is ready for use as a technique for investigating the response of the system to various input conditions and management alternatives which might be imposed. In the case of this study, each component or subsystem model will be capable of operating either independently or in conjunction with the models of other components of the total system depicted by Figure 7.

Management Studies

This is the ultimate step in the modeling process where the model is used to study and evaluate a variety of management alternatives. Hopefully, the model is capable of answering many of the questions which were posed in the early stages of the study. If the mo-

del contains an optimizing procedure, it is then capable of producing system optimization estimates in terms of specific objective functions. When possible, the "loop" should be closed by the feedback of results from the implementation phase (solution alternative which eventually was developed) to the initial problem situation. This suggested feedback loop is illustrated by the diagram of Figure 4.



PART III: MANAGEMENT MODEL DEVELOPMENT

CHAPTER V

MULTIOBJECTIVE ANALYSES

Introduction

The Great Salt Lake will be modeled in the hierarchical structure in Figure 7, where six major societal and economic goals and considerations have been identified at the second layer. These six goals and considerations, (i) recreation and tourism, (ii) mineral extraction, (iii) oil drilling, (iv) brine shrimp harvesting, (v) transportation, and (vi) water supply, represent conflicting and noncommensurable objectives and goals. In particular, present strong societal and environmental preferences make any cost-effectiveness analysis which is solely based on economic considerations obsolete and unacceptable.

The hierarchical-multilevel approach (Haines, 1973a, b) recognizes the inherent nature of conflicting and often competing objectives that characterizes most physical systems. In the hierarchy of models used to analyze the Great Salt Lake (Figure 7), the higher level coordination provides the means and ways for analyzing the interactions among all lower level subsystems. There are several methods for developing the higher level coordination and control (Haines and Macko, 1973). Particularly worth noting with regard to this study are the multiobjective function analyses and the Surrogate Worth Trade-off (SWT) Method (Haines and Hall, 1974). As noted previously, the economic and societal goals modeled at the first level-second layer of the hierarchical structure are very likely to be both non-commensurable and in competition and conflict. The decision-maker (who may be at the level of the Utah State government, the state legislature, a regional commission, a local government, or a federal agency) will need to determine the kind and level of control measures that should be enacted to achieve specific societal objectives. For this purpose, he will need a means of evaluating quantitatively the trade-offs possible among all the goals and objectives as represented by the various objective functions. The SWT method recognizes and answers this need.

Construction of Objective Functions

A major task under Phase II of this study will be to quantify all objective functions, constraints, and system's input-output relationships. The task is both essential and critical, since the ultimate goal of this study is to analyze the Great Salt Lake system as a whole and to recommend a planning policy which takes into consideration quantitatively all the trade-offs among the various objectives. Before detailing how the Surrogate Worth Trade-off Method works, a brief discussion on constructing of the objective functions is in order.

A gigantic modeling effort which is responsive to all societal goals was initiated in a study known as the "Straw Man" (Peterson et al., 1971). They proposed a "structured hierarchical array of elements, beginning at the top with nine general goals successively described by expanding strata of subgoals which are eventually linked to potential water policy action variables through social indicators." We have adopted here methodologies and approaches from the "Straw Man" project which are applicable to the development of a management model of the Great Salt Lake. In particular, the concept of subgoals within a major goal is adopted in this study's hierarchical structure (Figure 7) where the SWT method plays the coordinating role between a major goal and its various subgoals. The subgoal formulation will be discussed later in this chapter.

A fundamental step in constructing the various objective functions is to identify the decision variables (control measures), state variables, exogeneous variables (also known as parameters), outputs, and input-output relationships. Let:

\underline{x} = n- dimensional state vector. The state vector describes the state of the system at any time.

\underline{u} = N- dimensional decision (control measures) vector

\underline{a} = k- dimensional vector of exogeneous variables (parameters)

\underline{y} = P- dimensional vector of outputs

$g_j(\underline{x}, \underline{u}, \underline{a})$ = the j^{th} constraint function;
 $j = 1, 2, \dots, J$

$f_i(\underline{x}, \underline{u}, \underline{a})$ = i^{th} objective function;
 $i = 1, 2, \dots, I$

Although, both the objective functions and the constraints depend on the output vector, \underline{y} , the latter does not appear explicitly as an argument in $f_i(\cdot)$ or $g_j(\cdot)$. This is due to the fact that the output vector, \underline{y} , is generally represented by a functional relationship of the form:

$$\underline{y} = \underline{H}(\underline{x}, \underline{u}, \underline{a})$$

(where $\underline{H}(\cdot)$ is a P- dimensional vector of differentiable functions). Consequently, \underline{y} can be substituted in terms of \underline{x} , \underline{u} , and \underline{a} in the functions $f_i(\cdot)$ or $g_j(\cdot)$.

The simplest functional relationship for $\underline{H}(\cdot)$ is a linear one:

$$\underline{y} = \underline{C}\underline{x} + \underline{D}\underline{u}$$

where C and D are matrices of coefficients.

The constraints $g_j(\cdot)$ can be generalized to include all equality and inequality constraints. Therefore, the general form

$$g_j(\underline{x}, \underline{u}, \underline{a}) \leq 0, j = 1, 2, \dots, J$$

will be used in this study. In this formulation, the exogeneous variables, \underline{a} , will be assumed known. In general, they are determined either by other models, or by a parameter estimation and system identification process. To clarify the above mathematical notation a simple example follows:

Consider the third objective in the hierarchical structure in Figure 7 to maximize oil production from the Great Salt Lake subject to all other environmental, societal, and other constraints and objectives. The following identification of variables in the oil drilling sub-model should not be considered all-inclusive but rather a selected sample for pedagogical purposes only:

- | | |
|-----------------------|---|
| \underline{x} = (i) | capacity of the crude oil natural reservoir |
| (ii) | pressure in the oil reservoir |
| (iii) | depth of oil formation |
| (iv) | water level in the Great Salt Lake |
| (v) | etc. |
| \underline{u} = (i) | production rate of crude oil |
| (ii) | location and number of drilling facilities |

- | | |
|-------|---------------------------------------|
| (iii) | pipng, or \$ investment |
| (iv) | methods of exploration and production |
| (v) | etc. |

- | | |
|-----------------------|---|
| \underline{a} = (i) | reservoir characteristics (e.g. transmissivity, storativity, etc.) |
| (ii) | price of crude oil |
| (iii) | other values for operation maintenance and replacement (OMR) cost or benefits |
| (iv) | demand for oil |
| (v) | etc. |

- | | |
|-----------------------|--|
| \underline{y} = (i) | oil production |
| (ii) | oil spill |
| (iii) | employment opportunities |
| (iv) | additional regional development due to this industry |
| (v) | etc. |

$$f_3(\underline{x}, \underline{u}, \underline{a}) = \text{Net benefits from oil production}$$

$$g_1(\underline{x}, \underline{u}, \underline{a}) = \text{Oil spill} \leq b_1$$

$$g_2(\underline{x}, \underline{u}, \underline{a}) = \text{Other ecological effects} \leq b_2$$

Note that the relationship between the output vector, \underline{y} , and all other variables (\underline{x} , \underline{u} , \underline{a}) through the functional relation, \underline{H} , permits a state variable to be also a decision variable as well as an output. Consider for example the linear relation (for the scalar case) $y = cx + du$ for $c = 0$, $d \neq 0$ then $y = du$, u = the production rate (bbl/day), d = number of production days (days), y = total production in (bbl).

Often, the state of the system changes with time. For example, the pressure in the reservoir will drop with continuing production (which in turn will result in a higher production cost), the water level in the Great Salt Lake will change, etc. These dynamic changes can be expressed in a system of differential equations. A first order linear system of differential equations can be written as follows:

$$\frac{dx}{dt} = \underline{A}\underline{x} + \underline{B}\underline{u}$$

With the initial conditions $\underline{x}(0) = \underline{x}_0$. Note that the vector \underline{x} , is a time variable vector, $\underline{x}(t)$. Higher order differential equations also can be assumed. It is common in that case to introduce the so-called state space notation for compact model formulation. Given for example a second order differential equation:

$$\frac{d^2x}{dt^2} = a_1 \frac{dx}{dt} + a_2x + bu \dots \dots \dots (7)$$

with the initial conditions

$$\frac{dx(0)}{dt} = \gamma_1$$

$$x(0) = \gamma_0$$

Define the following notation:

$$\text{Let } \dot{x} \triangleq \frac{dx}{dt}$$

$$x_1 \triangleq x$$

$$x_2 \triangleq \frac{dx}{dt}$$

$$\text{Then } \dot{x}_1 = \frac{dx}{dt}$$

$$\dot{x}_2 = \frac{d^2x}{dt^2}$$

and the one second order differential equation can now be written as two first order differential equations:

$$\dot{x}_1 = x_2$$

$$\dot{x}_2 = a_1x_2 + a_2x_1 + bu$$

with the initial conditions

$$x_1(0) = \gamma_0$$

$$x_2(0) = \gamma_1$$

The latter two differential equations can be written in a compact matrix form as follows:

$$\dot{\underline{x}} = A\underline{x} + Bu$$

$$\underline{x}(0) = \underline{\gamma}$$

$$\begin{bmatrix} x_1 \\ x_2 \end{bmatrix} = \begin{bmatrix} 0 & 1 \\ a_2 & a_1 \end{bmatrix} \begin{bmatrix} x_1 \\ x_2 \end{bmatrix} + \begin{bmatrix} 0 \\ 1 \end{bmatrix} u$$

$$\begin{bmatrix} x_1(0) \\ x_2(0) \end{bmatrix} = \begin{bmatrix} \gamma_0 \\ \gamma_1 \end{bmatrix}$$

$$\text{where, } A = \begin{bmatrix} 0 & 1 \\ a_2 & a_1 \end{bmatrix}, \text{ and } B = \begin{bmatrix} 0 \\ 1 \end{bmatrix}$$

In summary, the overall mathematical model for the k^{th} subsystem $k = 1, 2, \dots, 6$ (in the first level-second

layer) of the hierarchical structure can be written as follows:

$$\text{minimize } f_k(\underline{u}, \underline{x}, \underline{a})$$

Subject to

$$\dot{\underline{x}} = A\underline{x} + B\underline{u}$$

$$\underline{x}(0) = \underline{\gamma}$$

$$\underline{y} = C\underline{x} + D\underline{u} \text{ (assuming linear input-output relationships)}$$

$$\text{or } \underline{y} = \underline{H}(\underline{x}, \underline{u}, \underline{a}) \text{ (in a general case)}$$

$$\text{and } g_j(\underline{x}, \underline{u}, \underline{a}) \leq 0, j = 1, 2, \dots, J_k$$

The above functions will be constructed by integrating all the study's efforts. The proper construction of the functional relationships $f_i(\cdot)$, $g_j(\cdot)$, $H_k(\cdot)$ and $x_{\ell}(\cdot)$ will determine the worth of the overall management model developed in the study. The following section addresses the problem of decision-making when multiple objectives are in competition or conflict with one another. It is clear, however, that no matter how good the procedures are for analyzing trade-offs among all the objectives, the quality of the overall model will depend on the realism and proper representation in the construction of these functions.

The Surrogate Worth Trade-off Method

The purpose of this section is to present a rather general and qualitative discussion on the SWT Method as it relates to the hierarchical structure of Figure 7. In addition, basic definitions related to the concept of Pareto optimum will be introduced. For a detailed discussion on the SWT method, the reader is referred to Haimes and Hall (1974), or to Haimes, Hall, and Freedman (1975).

Assuming that there is one objective function associated with each of the six major goals and considerations (first level-second layer of the hierarchical structure). The overall multiobjective higher level optimization problem can be formulated as follows:

$$\text{maximize } \left\{ f_1(\underline{x}, \underline{u}, \underline{a}), f_2(\underline{x}, \underline{u}, \underline{a}), \dots, f_6(\underline{x}, \underline{u}, \underline{a}) \right\}$$

subject to the previously discussed system of constraints and input-output relationships.

Definition: Non-inferior solution

A non-inferior solution (also known as Pareto optimal solution) to the vector optimization problem is one in which no increase can be obtained in any of the objectives without causing a simultaneous decrease in at least one of the other objectives.

The vector \underline{u}^* is called non-inferior solution to the problem:

$$\max [f_1(\underline{x}, \underline{u}, \underline{a}), \dots, f_6(\underline{x}, \underline{u}, \underline{a})], \underline{u} \in U,$$

where U is the set of all feasible solutions, if and only if there does not exist any $\hat{\underline{u}} \in U$ such that $f_i(\underline{x}, \hat{\underline{u}}, \underline{a}) \geq f_i(\underline{x}, \underline{u}^*, \underline{a})$ and $f_j(\underline{x}, \hat{\underline{u}}, \underline{a}) > f_j(\underline{x}, \underline{u}^*, \underline{a})$ for some $i = 1, 2, \dots, 6$. This solution is obviously not unique. Consequently, any point at which no one objective function $f_i(\underline{x}, \underline{u}, \underline{a})$ can be improved without causing a degradation in some other objective function $f_j(\underline{x}, \underline{u}, \underline{a})$; $i \neq j$ is a non-inferior solution to the vector optimization problem.

Consider for example the following problem with two objective functions:

$$\underset{u}{\text{maximize}} \begin{bmatrix} f_1(\underline{x}, u, a) \\ f_2(\underline{x}, u, a) \end{bmatrix}$$

in which

$f_1(\cdot)$ = objective function for recreation and tourism (e.g. visitors/day)

$f_2(\cdot)$ = objective function for brine shrimp harvesting (e.g. tons/year)

u = scalar control measure - being the funds (\$) available for investment to promote both recreational tourism and brine shrimp harvesting. For example the funds which will stimulate economic activities that in turn affect algal growth in the lake

x_1 = state variable representing the level of nutrients feeding the algae (which in turn enhance the brine shrimp colony and detract from recreational use)

x_2 = water salinity

thus

\underline{x} = (x_1, x_2)

\underline{a} = exogeneous variables representing parameters such as population, weather conditions, etc.

Clearly, the two objective functions, enhancement of recreation and tourism, $f_1(\cdot)$, and enhancement of brine shrimp harvesting, $f_2(\cdot)$, are non-commensurable and in fact in conflict (see Figure 13).

From Figure 13, $f_1(x, u, a)$ achieves its maximum at u_1^* , where $f_2(x, u, a)$ achieves its maximum at u_2^* . Due to the concavity of these two functions any point u , between u_1^* and u_2^* ($u_1^* \leq u \leq u_2^*$) will improve one objective function at the expense or the degradation of the other. Thus, all these values of u are non-inferior points.

The SWT method selects only those solutions which belong to the non-inferior set, thus eliminating all inferior solutions from further consideration. Furthermore, the SWT method provides the decision-maker with the marginal trade-offs between any two objective functions. These trade-offs between the i^{th} and j^{th} objectives which are denoted by λ_{ij} , satisfy the following mathematical relationship

$$\lambda_{ij} = - \frac{\partial f_i(\cdot)}{\partial f_j(\cdot)}, i \neq j; i, j = 1, 2, \dots, 6$$

The trade-offs are determined on the basis of the duality theory in nonlinear programming.

Since all λ_{ij} can be determined computationally, the trade-offs between any two objective functions can be found as follows:

$$\frac{\partial f_i(\cdot)}{\partial f_j(\cdot)} = -\lambda_{ij}, i \neq j; i, j = 1, 2, \dots, 6$$

It can be shown that all $\lambda_{ij} = 0$ correspond to the inferior solution. Thus, since $\lambda_{ij} \geq 0$ (in order to satisfy the Kuhn-Tucker conditions), interest will be only in $\lambda_{ij} > 0$. These λ_{ij} are the Lagrange multipliers associated with the i^{th} objective function in the Lagrangian equation with the function $f_j(\cdot)$ acting as an active (binding) constraint. Once all the needed trade-off functions $\lambda_{ij}(\cdot)$ are determined, the surrogate worth functions $W_{ij}(\cdot)$ can be constructed in cooperation with the decision-maker. The surrogate worth function W_{ij} can be defined as a function of λ_{ij} that provides the desirability of the decision-maker in making a trade between two levels of $f_i(\cdot)$ and $f_j(\cdot)$.

Specifically:

$W_{ij} > 0$, when λ_{ij} marginal units of $f_i(\cdot)$ are preferred over one marginal unit of $f_j(\cdot)$ given the satisfaction of the other objectives at some given level.

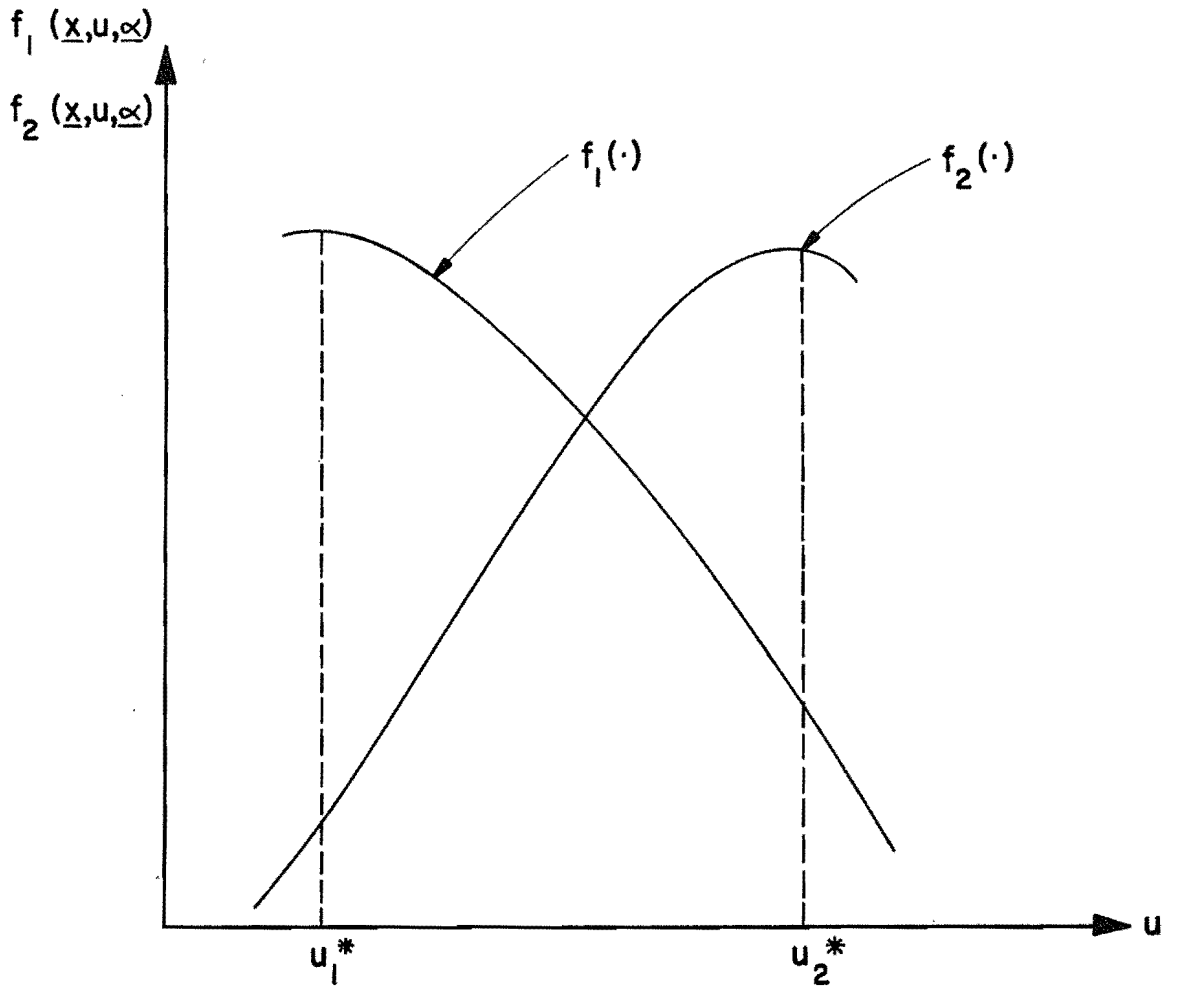

Figure 13. Two objective function representations – enhancement of recreation and tourism and enhancement of brine shrimp harvesting in the Great Salt Lake.

$W_{ij} < 0$, when λ_{ij} marginal units of $f_i(\cdot)$ are not preferred over one marginal unit $f_j(\cdot)$ given the satisfaction of the other objectives at a given level, and

$W_{ij} = 0$, when λ_{ij} marginal units of $f_i(\cdot)$ are equivalent to one marginal unit of $f_j(\cdot)$, given the satisfaction of the other objectives at a given level (for $W_{ij} = 0$ the decision-maker is said to be indifferent with respect to the trade-offs between the two objective functions).

The decision-maker is asked for his position on such trade-offs. His preference whether W_{ij} is negative, positive, or zero can be made on an ordinal scale of +10 to -10. Note that the decision-maker is responding to the various trade-offs with regard to a marginal improvement of one objective at the expense of a marginal degradation of the other. This fact, which is fundamental to the SWT method, gives him invaluable information, since his preferences are not made on the basis of the absolute value of the various objectives alone, but rather on the basis of the additional information from the marginal increments.

Once such an interaction with the decision-maker takes place, the λ_{ij}^* corresponding to $W_{ij} = 0$ can be interpolated. Subsequently, a nonlinear programming problem can be solved in order to determine the optimal decision vector \underline{u}^* (based on Everett [1963].) The ultimate optimal decision vector, \underline{u}^* , is associated with the policies to which the decision-maker is indifferent ($W_{ij} = 0$) with regard to trade-offs among all resultant values of the objectives being considered.

Sub-objective Decomposition

Each of the major six identified objectives can be further decomposed into sub-objectives (or into social indicators, Peterson et al., 1971). The importance of this decomposition is twofold:

- (i) It enables the planner to study and analyze each social indicator in more specific detail.
- (ii) It avoids the need for comparing the trade-offs between major objectives and sub-objectives. This distinction is especially important during comprehensive planning where a major objective may be to enhance the regional economic development (in units of million dollars) and a sub-objective may be to reduce the dissolved oxygen deficiency in a specific stream's reach (in units of ppm). The inherent order of magnitude that is associated with a sub-objective and a major objective makes the distinction

between them essential. Note that although the decision-maker will ultimately choose between trade-offs among a number of marginal units of one objective vs. one marginal unit of another objective (as is the case in the SWT method), the order of magnitude and the characteristics of these non-commensurable units should not be overlooked (e.g. the regional economic development vs. the number of visitors/day in a local recreation area).

In developing a management model for the Great Salt Lake, six major objectives were selected. It would have been possible, of course, to choose the four major ones advocated by the water resources council, namely the enhancement of: (1) national economic development, (2) regional economic development, (3) environmental quality, and (4) social well-being, and then associate the six presently identified major objectives as sub-objectives.

Alternatively, one might have chosen the nine major goals identified by Peterson et al. (1971), and associated the six objectives of the Great Salt Lake study with them. These nine general goals are divided into two major groups:

- | | | | |
|-----|----------------------------|--------|------------------------------------|
| (a) | Maintenance of Security | (i) | environmental security |
| | | (ii) | collective security |
| | | (iii) | individual security |
| (b) | Enhancement of Opportunity | (iv) | economic opportunity |
| | | (v) | recreational opportunity |
| | | (vi) | aesthetic opportunity |
| | | (vii) | cultural and community opportunity |
| | | (viii) | educational opportunity |
| | | (ix) | individual freedom and variety |

Since a decision as to whether an objective is a major objective or a sub-objective may be somewhat arbitrary, it is important that a quantitative coordination procedure be developed that relates trade-offs between the major objectives and the sub-objectives. This section addresses itself to the higher level coordination procedures between a major objective and its associated sub-objectives in a sub-hierarchy on the one hand, and the coordination among all the major objectives in the overall hierarchy on the other. The sub-objectives can be viewed as a lower hierarchical echelon. Furthermore, it is conceivable that additional decomposition of the sub-objectives may be needed and thus the identification of sub-sub-objectives may be required.

Sub-objective Coordination

In the following discussion, it is assumed that functional relationships (technical connections) can be derived for the major objectives and sub-objectives in terms of the control measures, state variables, and the exogenous variables. Should these functional derivations prove to be infeasible for some of the objectives, a more qualitative approach should be sought.

Recreation and tourism, one of the major objectives identified in this study (see Figure 7) will be used as a vehicle for demonstrating the proposed coordination mechanism between a major objective and its associated sub-objectives. The following are sub-objectives for recreation and tourism (see Figure 14).

- (i) stable water level
- (ii) fresh water bodies for water based activities (skiing, boating, swimming, fishing)
- (iii) easy access
- (iv) optimum use intensity
- (v) low health hazard
- (vi) low insect population (brine fly, deer fly, horse fly).

The coordination between higher and lower levels of a sub-hierarchy of a major objective and its associated sub-objectives is analogous to the same coordination in the overall hierarchy of multiple major objectives. Therefore, the surrogate worth trade-off method can be applied for the analysis and optimization of the trade-offs among the sub-objectives. An optimal policy in this sub-hierarchy means that at the corresponding levels of the sub-objectives the decision-maker is indifferent to any further marginal trade-offs among the sub-objectives. For convenience in notation let:

\hat{u}_1 = the vector of optimal control measures that corresponds to the six sub-objectives associated with recreation and tourism.

$\hat{f}_{11}(\cdot), \hat{f}_{12}(\cdot), \hat{f}_{13}(\cdot), \dots, \hat{f}_{16}(\cdot)$ = the values of the sub-objectives evaluated at the optimal control measures (corresponding to $W_{ij} = 0$).

Similar analysis can be made of all other sub-hierarchies associated with the remaining major objectives. The final product will be one or more opti-

mal control measures for each major objective as well as the corresponding indifference achievement level of the sub-objectives. Assuming there are six major objectives and five sub-objectives for each major objective, the total output from the sub-hierarchies is as follows (see Figure 15).

$$\begin{aligned} & \hat{u}_1, \hat{u}_2, \hat{u}_3, \hat{u}_4, \hat{u}_5, \hat{u}_6 \\ & \hat{f}_{11}(\cdot), \hat{f}_{12}(\cdot), \dots, \hat{f}_{15}(\cdot) \\ & \hat{f}_{61}(\cdot), \hat{f}_{62}(\cdot), \dots, \hat{f}_{65}(\cdot) \end{aligned}$$

Highest Level Coordination

The task here is to utilize all the information generated by the lower levels and to generate an overall optimal policy for the whole system. The information from the lower levels includes $\hat{u}_j, j = 1, 2, \dots, 6$ and $\hat{f}_{ij}(\cdot), i = 1, 2, \dots, 6; j = 1, 2, \dots, 5$. The highest level in the hierarchy generates a new optimal control vector, \underline{u}^* , for the entire system where the decision-maker is indifferent to any further trade-offs among the major objectives evaluated at \underline{u}^* . This is an iterative procedure where the problem of convergence needs a further study.

Computational Procedure

The problem of the highest level in the hierarchy can be mathematically written as follows:

$$\text{Max}_{\underline{u}} \begin{bmatrix} f_1(\cdot) \\ f_2(\cdot) \\ \vdots \\ f_6(\cdot) \end{bmatrix}$$

Subject to the constraints

$$\begin{aligned} g_k(\cdot) &\leq 0; \quad k = 1, 2, \dots, K \\ f_{ij}(\cdot) &\geq \epsilon_{ij}; \quad i = 1, 2, \dots, 6 \\ & \quad \quad \quad j = 1, 2, \dots, 5 \end{aligned}$$

where the SWT method can be applied to solve this problem. If no feasible solution can be generated, then some of the limits (\hat{f}_{ij}) of the binding constraints should be relaxed with some tolerance ϵ_{ij} . The corresponding Lagrange multipliers associated with the new bounds ϵ_{ij} should provide sufficient information on the trade-offs among the lower echelon sub-objectives and the higher echelon major objectives, and the procedure can be repeated.

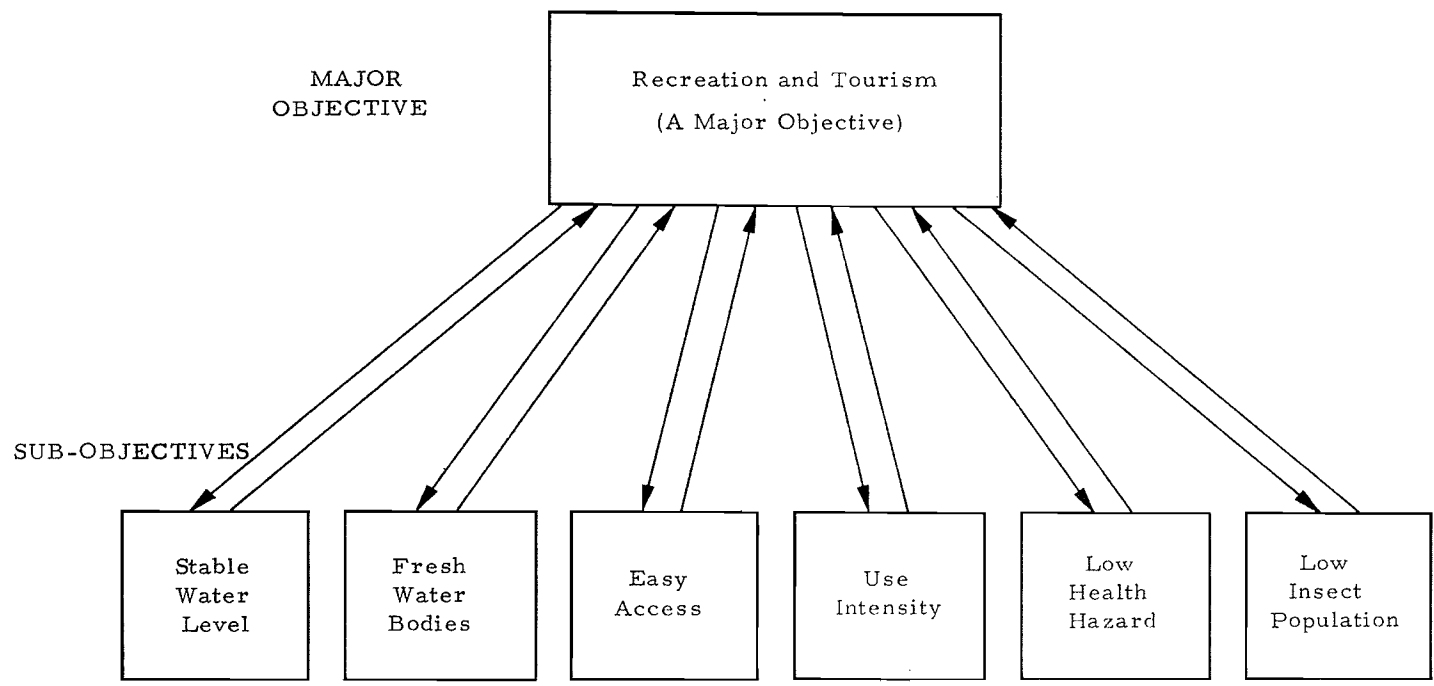

Figure 14. A sub-hierarchy for recreation and tourism sub-objectives.

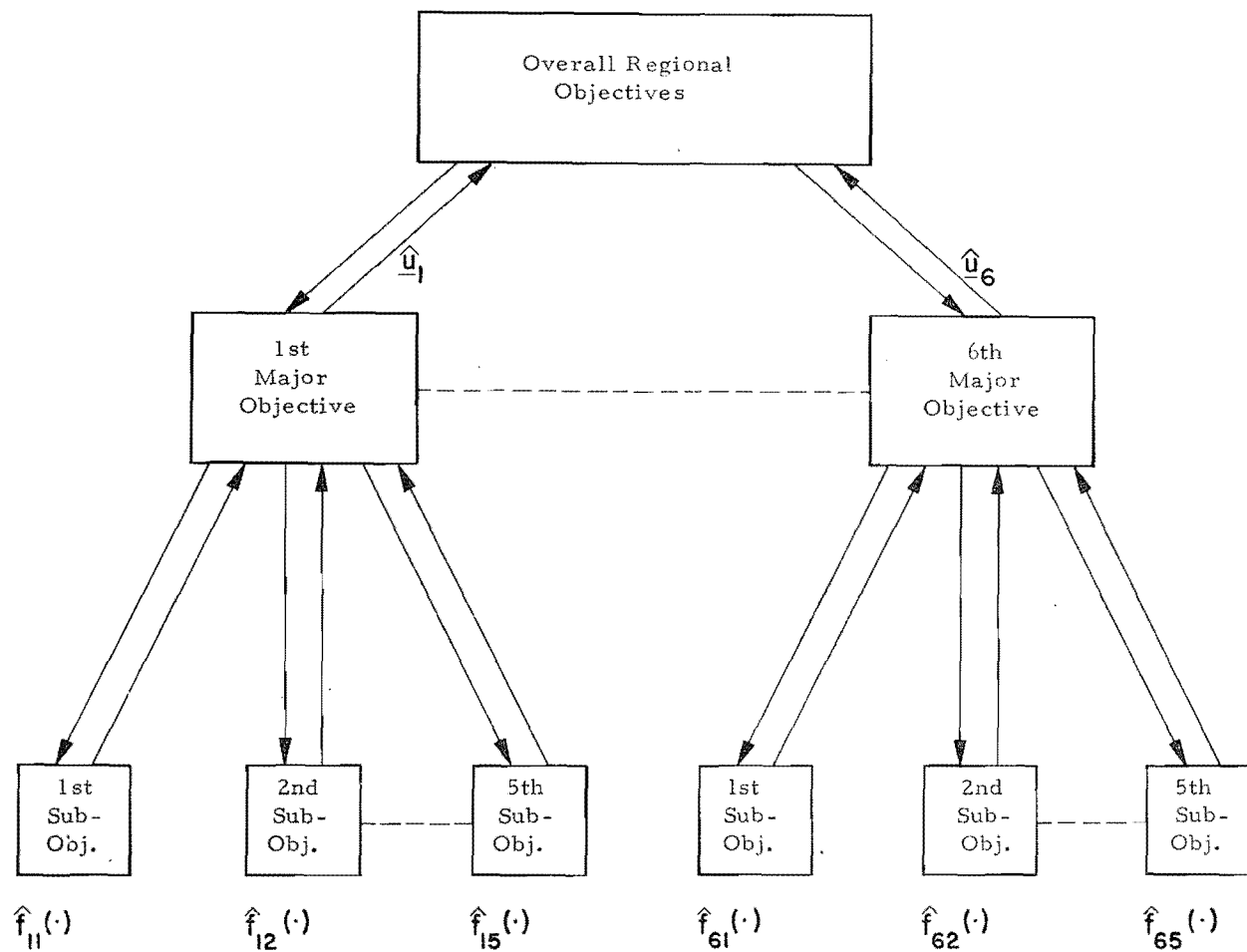

Figure 15. Generalized multiobjective hierarchical structure.

CHAPTER VI

CONTINUING MODEL DEVELOPMENT -- A SUMMARY

The development of a comprehensive management model, such as that proposed for the water resources system of Great Salt Lake, is a complex process involving the cooperation and close coordination of many groups, disciplines, and activities. Thus, modeling is a synthesis operation which involves the systematic "piecing together" of all relevant information about a system (Figure 16). The information is brought together in terms of appropriate time and space dimensions and in accordance with its relative importance to the functioning of the system as a whole. Because they possess both great problem solving potential and specific limitations, the capabilities of all models need to be clearly understood by those who use them.

In the Great Salt Lake system much information already has been developed (LAKE COM Report, 1973), yet additional information is still needed (Table 3). As was indicated earlier, the Economics Committee of the Utah State Legislature recently established a policy advisory committee and an interagency technical team to consider the overall problem of developing management objectives and procedures for Great Salt Lake. A description of the organizational structures and current membership of these two committees is given in Appendix A. The interagency technical team has been divided into a number of task groups, each of which has been assigned the responsibility of identifying both available and needed information in its particular area of activity. It is envisioned that the interagency technical team in particular will be highly involved in the model development project suggested by this report, and that the continuing and integrated efforts of this team will contribute directly to the comprehensive management model proposed for the water resource system of Great Salt Lake.

As previously indicated, the next major step which will be undertaken by the current USU Salt Lake project is to complete the physical component of the total system (first layer of the diagram of Figure 7). Information which is available from many earlier studies will considerably facilitate this activity. Examples are the recent model studies of the causeway by both the University of Utah and the U.S. Geological Survey. In addition, the work conducted by the U.S. Geologi-

cal Survey in completing a gross hydrologic model of the lake will provide considerable insight into the development of the high-resolution hydrologic-quality model of the lake which will be undertaken as the next step in the USU study.

Modeling is a continuous process for which it is difficult to establish a specific end-point. Modifications, extensions, and improvements are always possible, and modeling the water resource system of Great Salt Lake will be of no exception. However, in this process it usually is possible to identify specific stages which are associated with particular activities and certain levels of accomplishment. In the USU Salt Lake project, three basic phases were identified (Figure 17). Phase I has been concerned primarily with problem identification and definition of the direction and scope of activities in the remaining two phases. Phase II will involve model development. It is contemplated that a period of one year will be required to complete the subsystem models for the physical components of the total system. It is further estimated that an additional two years will be needed to add meaningful representations of some of the societal elements which are identified within the first level of the second layer of Figure 7. However, management studies using specific subsystem models will be possible as soon as these component models are developed. Thus, by June 30, 1975, it is expected that realistic predictions of the effects of particular management alternatives on the physical system of the lake will be available. For example, by means of the lake subsystem model, it should be possible to predict the effects of brine concentration levels at particular locations in the lake of the construction of dikes at given sites. The societal dimensions then will be added to the physical components of the model using the multi-objective optimization approach proposed by Haimes and Hall (1974), and discussed briefly in Chapter V of this report. The final activity phase shown by Figure 17 (Phase III) involves use of the overall model for specific management studies. As already indicated, however, management studies for particular subsystems will be initiated as soon as the subsystem models are completed, and in this sense there will be some overlapping between Phases II and III of the project. The overlapping and integrated kinds of activities which are

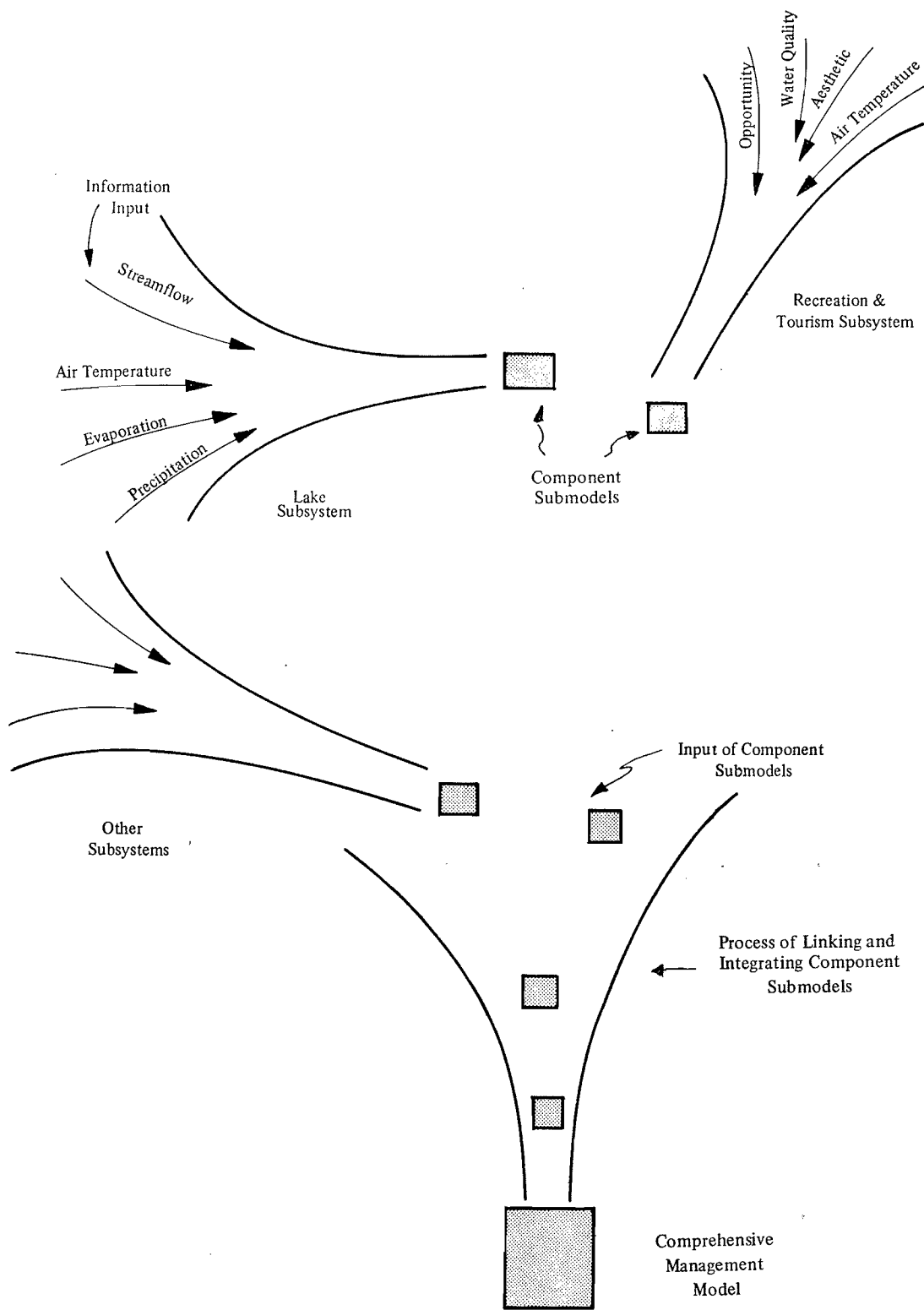

Figure 16. A representation of the process of developing a comprehensive management model consisting of linked and integrated submodels.

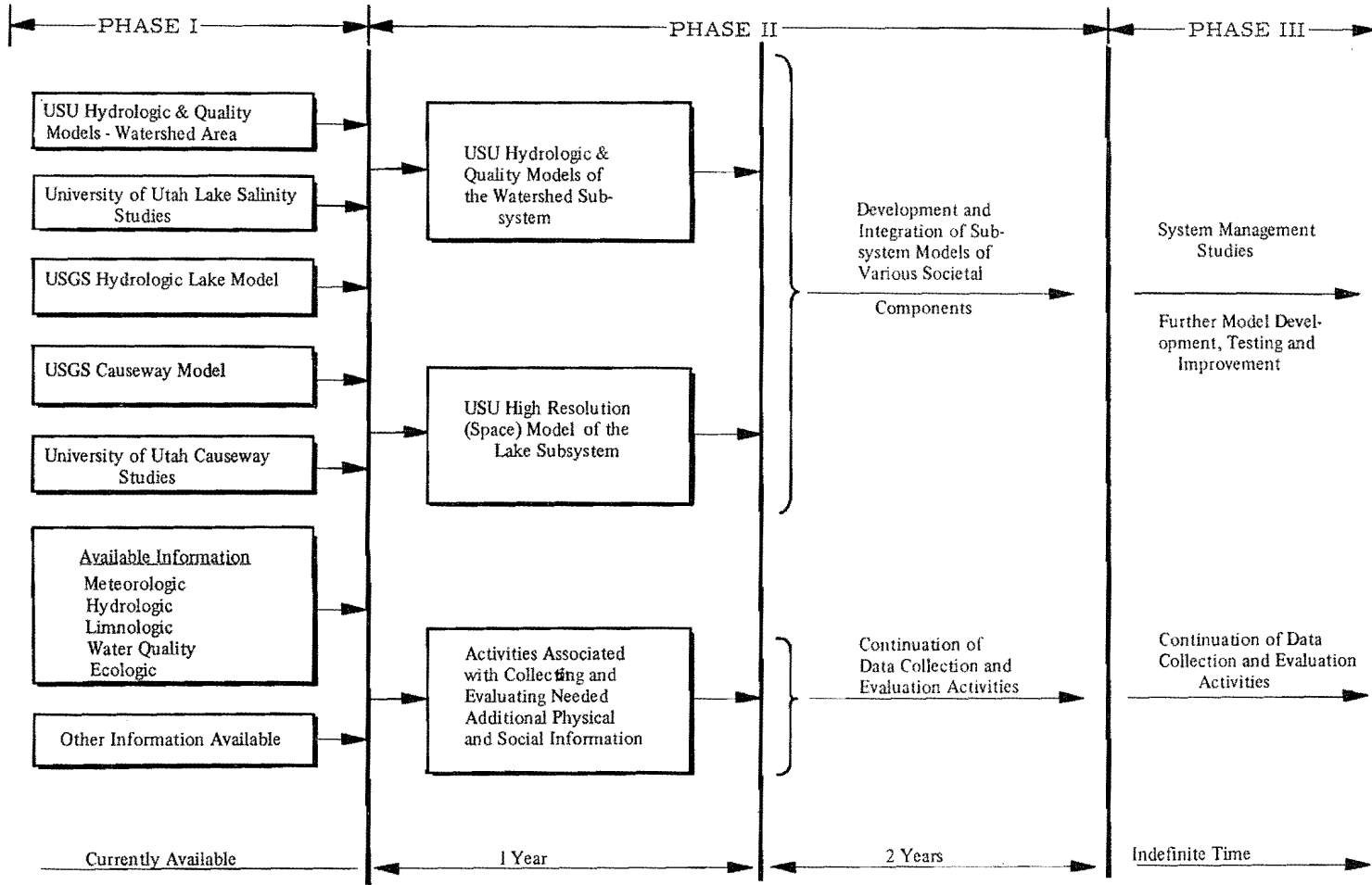

Figure 17. Schedule of phases in the project to develop a management model of the Great Salt Lake water resource system.

envisioned for the remaining Phases II and III are indicated by the project flow diagram of Figure 18.

Systems management is a dynamic process involving a continuous adjustment to changing physical characteristics and societal demands. The implementation of management decisions usually (but not always) produces changes and within the scope of these changes the various components of the system must be considered and accommodated. In some cases, this accommodation might involve a basic change in a particular use pattern, such as the relocation of mineral extraction plants bordering the Great Salt Lake. In

other cases, some adjustments in the proposed change itself might be possible so that negative impacts on specific use areas are reduced. Often a combination of these two approaches is indicated. Invariably, however, successful management involves the ability to select a particular plan from a set of feasible alternatives on the basis of the degree to which each potential plan meets specific and defined management objectives. In this situation computer modeling has great practical utility, particularly where large and complex systems are involved. For this reason, the modeling technique is proposed by this report as the basic framework of a management strategy for the water resource system of the Great Salt Lake.

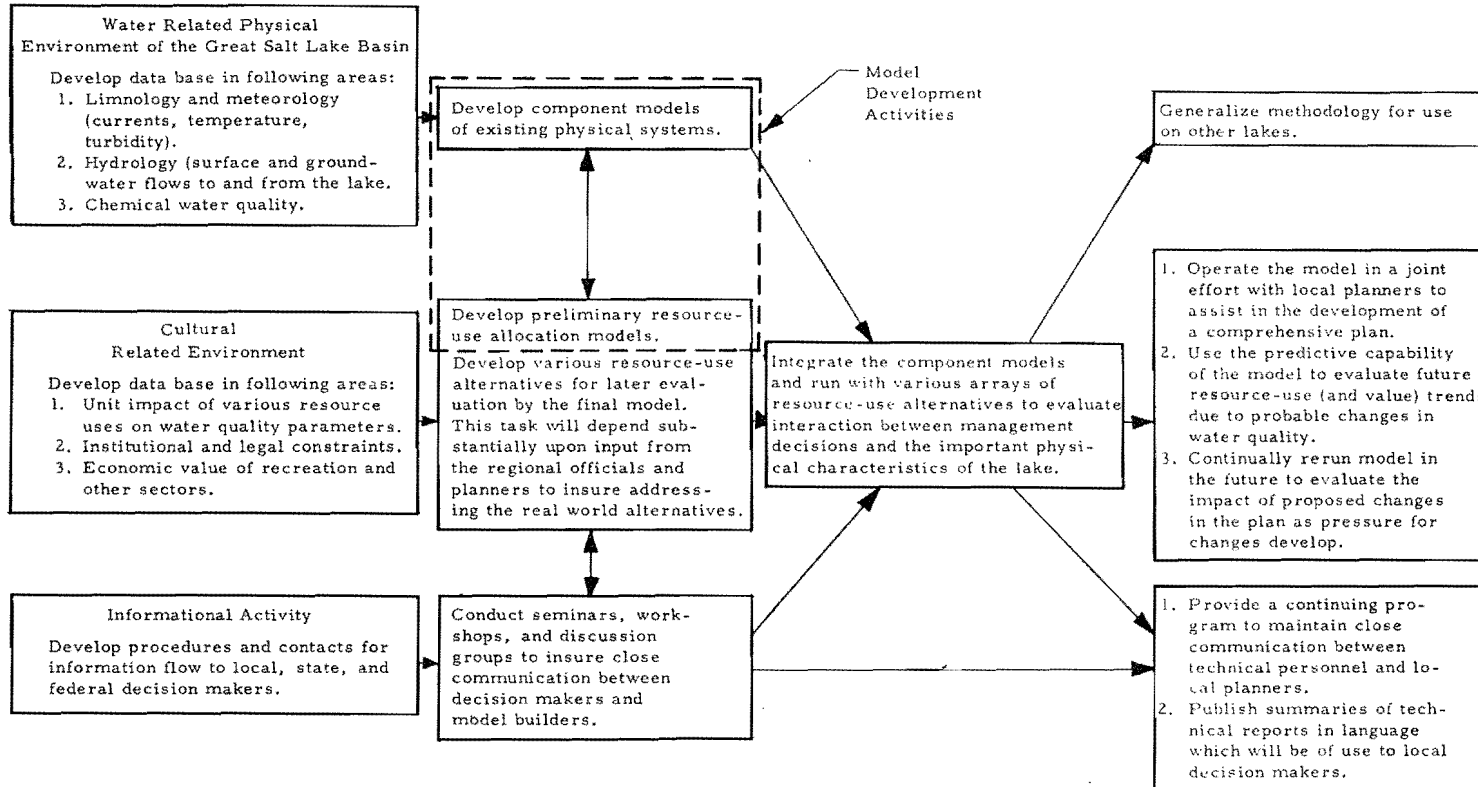
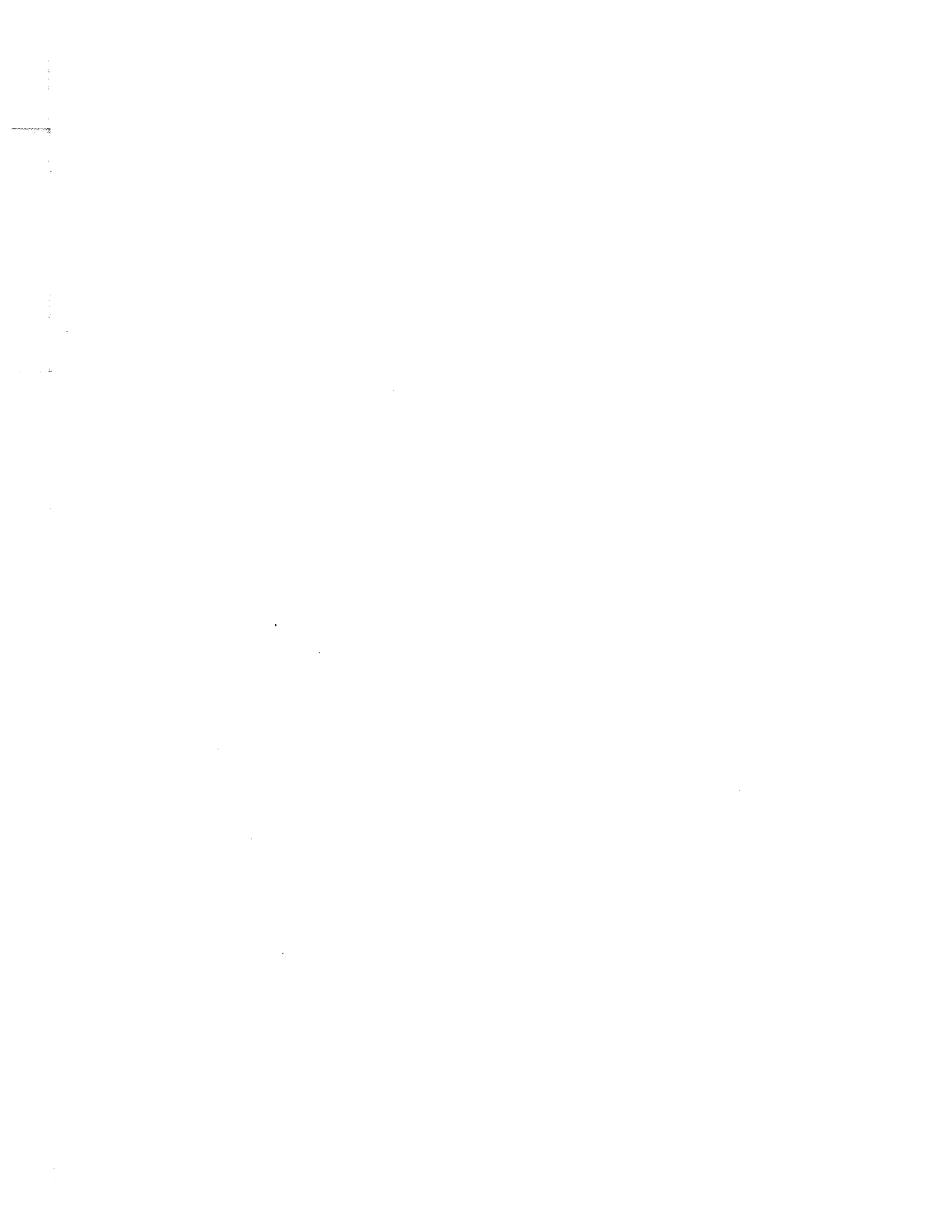

Figure 18. Great Salt Lake basin management study for Phases II and III - Project Flow Diagram.



REFERENCES

- Adams, T. C. 1964. Salt migration to the northwest body of Great Salt Lake, Utah. *Science*, 143(3610) March 6: 1027-1029.
- Caldwell, Richards and Sorenson, Inc., Consulting Engineers for the Great Salt Lake Authority. 1965. A preliminary master plan for the development of the Great Salt Lake - over a period of the next 75 years. January.
- Chen, Carl W., and Gerald T. Orlob. 1972. Ecologic simulation for aquatic environments. Final Report. Office of Water Resources Research, U.S. Department of the Interior.
- Cheng, Ralph Ta-Shun, and Min-Hsiung Hu. 1973. Brine movement through the causeway of Great Salt Lake. Presented at the 55th AGU Winter Meeting, Dec. 10-14, 1973 in San Francisco, Calif. (Submitted for publication in the *Journal of the Hydraulics Division of American Society of Civil Engineers*.)
- Christiansen, J. E., and J. B. Low. 1970. Water requirements of water fowl marshlands in Northern Utah. Utah Division of Fish and Game.
- Clyde, Criddle, and Woodward, Inc. 1970. The Great Salt Lake - physical conditions, brine movements and redistribution of salts. Unpublished report.
- Coburn, Alan A., and David N. Eckhoff. 1972. Pollution input from the Lower Jordan Basin to Antelope Island Estuary. (AWRA)
- Dailey, James E., and Donald R. F. Harleman. 1972. Numerical model for the prediction of transient water quality in estuary networks. Ralph M. Parsons Laboratory for Water Resources and Hydrodynamics.
- Dickson, D. R. 1962. Evaporation rates of the Great Salt Lake from August to December 1961. University of Utah, Dept. of Meteorology. (Unpublished private communication.)
- Dickson, D. R. and C. McCullom, Jr. 1965. Evaporation from the Great Salt Lake as computed from eddy flux techniques, In *Evaporation Studies, Great Salt Lake*. Utah Geological and Mineralogical Survey. *Water Resources Bulletin* 6, p. 15-25.
- Dickson, D. R., J. H. Yepsen, and J. V. Hales. 1961. Saturated vapor pressure over Great Salt Lake brine. Technical Report No. 1, Development Projects in Earth Sciences. University of Utah, Dept. of Meteorology.
- Dow Chemical Company. 1973. Industrial complex study for the Wasatch Front Area of the State of Utah. 117p. May.
- Eardley, A. J. 1938. Sediments of Great Salt Lake, Utah. *American Association of Petroleum Geologists Bulletin*, Vol. 22, pp. 1305-1411.
- Everett, H. 1963. Generalized Lagrange multipliers method for solving problems of optimum allocation of resources. *Operations Research*, 11, 398-417.
- Flowers, S. 1934. Vegetation of the Great Salt Lake region. *Botanical Gazette*, 9563:353-418.
- Foote, Gary L., R. W. Hill, and Daniel H. Hoggan. 1971. Hydrologic inventory of the Great Salt Lake desert area. Utah Water Research Laboratory, in cooperation with Utah Division of Water Resources, PRWG40-7, Utah State University, Logan, Utah.
- Grenney, W. J., and D. A. Bella. 1972. Field study and mathematical model of the slack-water buildup of a pollutant in a tidal river. *Limnology and Oceanography*. March.
- Hahl, D. C. 1968. Dissolved mineral inflow to Great Salt Lake and chemical characteristics of Salt Lake brine: Summary of water years 1960, 1961, and 1964. Utah Geological and Mineralogical Survey. *Water Resources Bulletin* 10.
- Hahl, D. C., and A. H. Handy. 1969. Great Salt Lake, Utah: Chemical and physical variation of the brine, 1963-1966. Utah Geological and Mineralogical Survey. *Water Resources Bulletin* 12.
- Hahl, D. C., and R. H. Langford. 1964. Dissolved mineral inflow to Great Salt Lake and chemical characteristics of the Salt Lake brine, Part II: Technical Report. Utah Geological and Mineralogical Survey. *Water Resources Bulletin* 3 - Part II.
- Hahl, D. C., and C. G. Mitchell. 1963. Dissolved mineral inflow to Great Salt Lake and chemical characteristics of the Salt Lake brine, Part I: Selected hydrologic data. Utah Geological and Mineralogical Survey. *Water Resources Bulletin* 3 - Part I.
- Haimes, Yacov Y., and Warren A. Hall. 1974. Multi-objectives in water resources systems analysis: The surrogate-worth trade-off method. *Water Resources Research*, 10:4, pp. 615-624.
- Haimes, Yacov Y., and D. Macko. 1973. Hierarchical structures in water resources systems management. *IEEE-Systems-Man and Cybernetics*, SMC-3, No. 4. pp. 369-402. July.
- Haimes, Yacov Y., W. A. Hall, and H. T. Freedman. 1975. Multiobjective optimization in water resources systems: The surrogate-worth trade-off method, Elsevier Scientific Publishing Company, The Netherlands.
- Harbeck, G. E., Jr. 1955. The effects of salinity on evaporation. U.S. Geological Survey Professional Paper 272A.
- Hann, Roy W., Jr., and Paul J. Young. 1972. Mathematical models of water quality parameters for rivers and estuaries. Texas Water Resources Institute. A-014-Tex.

- Haws, Frank W., and Trevor C. Hughes. 1973. Hydrologic inventory of the Bear River Study Unit. Utah Water Research Laboratory PRWG40-8. Utah State University, Logan, Utah.
- Haws, Frank W., Roland W. Jeppson, and A. Leon Huber. 1970. Hydrologic inventory of the Weber River Study Unit. Utah Water Research Laboratory PRWG40-6, Utah State University, Logan, Utah.
- Hely, Allen G., R. W. Mower, and C. Albert Harr. 1971. Water resources of Salt Lake County, Utah. Technical Publication No. 31 State of Utah Department of Natural Resources.
- Hill, Robert W., Eugene K. Israelsen, A. Leon Huber, and J. Paul Riley. 1970. A hydrologic model of the Bear River Basin. Utah Water Research Laboratory PRWG72-1, Utah State University, Logan, Utah.
- Hill, Robert W., J. Paul Riley, and Eugene K. Israelsen. 1973. Computer simulation of the hydrologic-salinity flow system within the Bear River Basin. Utah Water Research Laboratory PRWG104-1, Utah State University, Logan, Utah.
- Huntzinger, T. L. 1971. Future water use model of Utah Valley. M. S. Thesis, Colorado State University, Fort Collins, Colorado.
- Hyatt, M. Leon, Gaylord V. Skogerboe, Frank W. Haws, and Lloyd H. Austin. 1969. Hydrologic inventory of the Utah Lake Drainage Area. Utah Water Research Laboratory PRWG40-3, Utah State University, Logan, Utah.
- Israelsen, E. K., and J. Paul Riley. 1968. Application of an electronic analog computer to a study of water resources management (Weber Basin). Paper presented at Symposium on Analog and Digital Computers in Hydrology. Tucson, Arizona. December.
- Israelsen, Eugene K., J. Paul Riley, and A. Leon Huber. 1973. A computer simulation model of the water resource system within Salt Lake County. Utah Water Research Laboratory PRWG23-8, Utah State University, Logan, Utah.
- Keith, J. E., J. C. Andersen, A. B. King, M. H. Anderson, T. C. Andersen, C. G. Clyde, and D. H. Hoggan. 1973. Inter-regional planning at water resources allocations by system analysis approach: A Summary Report. Utah Water Research Laboratory PRWG100-4, Utah State University, Logan, Utah.
- Kirkpatrick, R. 1934. The life of Great Salt Lake with special reference to the algae. M. S. Thesis, University of Utah. Salt Lake City, Utah.
- LAKE COM. Report. 1973. Great Salt Lake study. Land Use and Water Committee. Wasatch Front Regional Council.
- Leopold, Luna B., Frank E. Clarke, Bruce B. Hanshaw, and James R. Balsley. 1971. A procedure for evaluating environmental impact. U. S. Geological Survey Circular 645.
- Lin, Anching, Po-Cheng Change, and Paul Sha. 1972. Some physical characteristics of the Great Salt Lake. Proceedings of the First Annual Conference of the Utah Section of AWRA. Utah Water Research Laboratory, Utah State University, Logan, Utah.
- Lin, Anching, and S. M. Lee. 1972. A heleshaw model study of seepage flow through the causeway of the Great Salt Lake. Proceedings of the First Annual Conference of the Utah Section of AWRA. Utah Water Research Laboratory, Utah State University, Logan, Utah.
- Lofgren, Ben E. 1954. Groundwater inflow into the Great Salt Lake. Utah Academy of Science, Arts, and Letters. Proceedings Vol. 31.
- Madison, R. J. 1970. Effects of a causeway on the chemistry of the brine in Great Salt Lake, Utah. Utah Geological and Mineralogical Survey. Water Resources Bulletin 14.
- Meide, J. V., and Paul S. Nicholes. 1972. A study of the distribution of coliform bacteria in the Farmington Bay Estuary of the Great Salt Lake. AWRA.
- Palmer, Roland. 1966. Hydrologic study of the Great Salt Lake. Utah Water and Power Board.
- Patrick, Ruth. 1936. Some diatoms of Great Salt Lake. Bulletin Torrey Botan. Clue, 63:157-166.
- Peck, E. L., and D. R. Dickson. 1965. Evaporation and groundwater Great Salt Lake. In Evaporation and Mineralogical Survey. Utah Geological and Mineralogical Survey. Water Resources Bulletin 6. p. 5-14.
- Peterson, D. F., editor, 1971. Water resources planning and social goals: Conceptualization toward a new methodology. Utah Water Research Laboratory PRWG94-1, Utah State University, Logan, Utah.
- Porcella, D. B., and J. A. Holman. 1972. Nutrients, algal growth, and culture of brine shrimp in the southern Great Salt Lake. Proceedings of the First Annual Conference of the Utah Section of AWRA. Utah Water Research Laboratory, Utah State University, Logan, Utah.
- Proceedings of the First Annual Conference, Utah Section. American Water Resources Association. November 30, 1972. Utah Water Research Laboratory, Utah State University, Logan, Utah.
- Rawley, Edwin V., and Bruce C. Johnson. 1974. The Great Salt Lake biotic system. State of Utah Department of Natural Resources, Division of Wildlife Resources, 74-13, September.
- Rees, Don M., Frank D. Arnold, Dean M. Anderson, and Glen C. Collett. 1966. Multipurpose management of reusable water in Utah. Report No. 4 Terminal. University of Utah. Inst. of Environmental Biology. February.
- Riley, J. Paul. 1970. Computer simulation of water resource systems. Proceedings of the Second International Seminar for Hydrology Professors. Utah State University.
- Searle, Reed T. 1973. A report about the Great Salt Lake comprehensive management study, associated problems and concerns - the background of those concerns and problems.
- Steed, James N. 1972. Water budget for the Great Salt Lake, Utah. Unpublished Masters Thesis, University of Utah Engineering Department.
- Suekawa, H. S. 1970. Study of the Kennecott Copper Corporation - Great Salt Lake Authority tailings test. Utah Geological and Mineralogical Survey, Special 28. 41 p.

- Utah State Road Commission - Advisory Committee. 1958. Great Salt Lake Diking Study. Reproduced by Utah State Highway Department.
- Waddell, K. M., and E. L. Bolke. 1973. The effects of restricted circulation on the salt balance of Great Salt Lake, Utah. Utah Geological and Mineralogical Survey. Water Resources Bulletin 18.
- Wang, Bi-Huei, James I. Felix, Rick L. Gold, Craig T. Jones, and J. Paul Riley. 1973. A water resource management model, Upper Jordan River Drainage. Utah. Utah Water Research Laboratory PRWG91-1, Utah State University, Logan, Utah.
- Wasatch Front Regional Council. 1973. Lake Committee Report. Land Use and Water Committee of Wasatch Front Regional Council.
- Whelan, J. A., and Norman Stauffer. 1972. Preliminary report on possible solutions to "fill effects" causing dilution of South Arm Brines and concentration of North Arm Brines, Great Salt Lake, Utah. Utah State Division of Water Resources. June. 12 p.
- ZoBell, C. E., D. Q. Anderson, and W. W. Smith. 1937. The bacteriostatic and bactericidal action of Great Salt Lake water. *Journal of Bacteria*. 33:253-262.

APPENDIX

**STUDY COMMITTEES ESTABLISHED BY THE ECONOMIC RESOURCES
COMMITTEE OF THE STATE LEGISLATURE
(As of August 1973)**

**ECONOMIC RESOURCES COMMITTEE
OF THE STATE LEGISLATURE
(As of August 1973)**

Rep. Farrell D. Anderson
RFD 1, Box 255
Tooele, Utah 84074

Rep. Eldon H. Barlow
79 Center Street
Clearfield, Utah 84015

Rep. Calvin Black
159 West Fifth South
Blanding, Utah 84511

Senator Donald G. Brooke
761 Roosevelt Avenue
Salt Lake City, Utah 84105

Senator E. LaMar Buckner, Ch.
1550 Country Hills Drive
Ogden, Utah 84403

Rep. Dallas H. Buckway, V. Ch.
5470 South 800 East
Ogden, Utah 84403

Senator Miles "Cap" Ferry
Box 70
Corinne, Utah 84307

Rep. James V. Hansen
399 East Oak Lane
Farmington, Utah 84025

Rep. W. Edward Kerr
East Tremonton
Utah 84337

Senator Carl E. Petterson
3170 Dayton
Magna, Utah 84044

Rep. Glad M. Sowards
380 West First South
Vernal, Utah 84078

Rep. Gerald L. Woodmansee
877 Catherine Street
Salt Lake City, Utah 84116

**GREAT SALT LAKE POLICY -
ADVISORY COMMITTEE
(As of August 1973)**

Rep. Farrell D. Anderson^a
RFD 1, Box 255
Tooele, Utah 84074

Rep. Eldon H. Barlow
79 Center Street
Clearfield, Utah 84015

Senator E. LaMar Buckner (Chairman)
1550 Country Hills Drive
Ogden, Utah 84403

Mr. George Buzianis
Tooele Country Commissioner
210 Tule Circle
Tooele, Utah 84074

Mr. Wayne Clark, Chairman
Department of Economics
302 Jesse Knight Building
Provo, Utah 84602

Mayor Stephen Dirks
City and County Building
Ogden, Utah 84401

Mr. Loren C. Dunn
Utah Industrial Promotion Board
c/o 47 East South Temple
Salt Lake City, Utah 84111

Commissioner Glen W. Flint^a
Davis County Commissioner
Davis County Courthouse
Farmington, Utah 84025

Mr. Dee C. Hansen
State Engineer
442 State Capitol
Salt Lake City, Utah 84114

Mr. John P. Holmgren, II
Box Elder County Commissioner
Bear River City
Utah 84301

Mr. Gilbert Moore
General Manager, Thiokol Corp.
P. O. Box 1497
Ogden, Utah 84402

Mr. George H. Smeath^a
Mountain Area Planners
Mountain Area Planners
362 East 300 South
Salt Lake City, Utah 84111

Mr. John E. Smith
143 South Hale
Grantsville, Utah 84029

Mr. Edward H. Southwick
Board of Water Resources
1483 Wall Avenue
Ogden, Utah 84404

Mr. Leland S. Swaner
Board of Wildlife Resources
1625 Pioneer Road
Salt Lake City, Utah 84104

Mr. Keith Warner
544 Barlow Street
Clearfield, Utah 84015

Rep. Gerald L. Woodmansee^a
877 Catherine Street
Salt Lake City, Utah 84116

^aMember of the Executive Group of the Policy -
Advisory Committee.

**GREAT SALT LAKE INTERAGENCY
TECHNICAL TEAM
(As of August 1973)**

Robert Anderson
U.S. Bureau of Land Management
125 South State Street
Salt Lake City, Utah 84111

Ted Arnow
U.S. Geological Survey
125 South State Street
Salt Lake City, Utah 84111
524-5663

Lloyd Austin
Division of Water Resources
435 State Capitol
Salt Lake City, Utah 84114
328-5401

Bill Backman
Salt Lake County Development and
Promotion Board
100 South West Temple
Salt Lake City, Utah 84101
521-2822

Earl M. Bay
U.S. Bureau of Reclamation
125 South State Street
Salt Lake City, Utah 84111
524-5537

Jim Berry
Utah Travel Council
Council Hall
Salt Lake City, Utah 84114
328-5681

Craig Bigler
Assoc. State Planning Coordinator
State Planning Coordinator's
Office
State Capitol Building
Salt Lake City, Utah 84114

Paul Burchell
Division of Oil and Gas Conservation
1588 West North Temple
Salt Lake City, Utah 84116
328-5771

Vee Call
Provo-Jordan River Parkway Authority
438 State Capitol
Salt Lake City, Utah 84114
328-5357

Dale Carpenter
Department of Natural Resources
438 State Capitol
Salt Lake City, Utah 84114

Biao Chang
Utah State Department of Highways
State Office Building
Salt Lake City, Utah 84114
328-5211

Kell Cloward
Utah Resident Office
Army Corps of Engineers
135 South State Street
Salt Lake City, Utah 84111
524-4264

Mark Crystal
Division of State Lands
105 State Capitol
Salt Lake City, Utah 84114
328-5381

Don Dickson
Department of Meteorology
University of Utah
Salt Lake City, Utah 84112
581-6136

Harold Donaldson
Division of Water Rights
442 State Capitol
Salt Lake City, Utah 84114
328-5881

Don Drage
1048 Sumac Drive
Logan, Utah 84321

Jack Dunlop
Division of Economic & Community
Research
University of Utah
Salt Lake City, Utah 84112
581-6333

Stan Elmer
Division of Parks & Recreation
1596 West North Temple
Salt Lake City, Utah 84116
328-5881

Austin Erickson
Soil Conservation Service
4012 Federal Building
Salt Lake City, Utah 84111
524-5663
524-5050

Fred Fields
U.S. Geological Survey
125 South State Street
Salt Lake City, Utah 84111
524-5663

Arden Gaufin
Department of Biology
University of Utah
Salt Lake City, Utah 84112

Joseph Glassett
Department of Chemical Engineering
Brigham Young University
Provo, Utah 84602
374-1211 Ext. 2586

Terry E. Green, Jr.
Outdoor Recreation Agency
438 State Capitol
Salt Lake City, Utah 84114
328-5691

William T. Helm
Department of Wildlife Science
Utah State University
Logan, Utah 84322
752-4100 Ext. 7928

John Hunt
Inst. for Study of Rec. & Travel
Utah State University
Logan, Utah 84322
752-4100 Ext. 7854

Dallin Jensen
Attorney General's Office
236 State Capitol
Salt Lake City, Utah 84114
328-5261

Bruce Kaliser
Utah Geological & Mineralogical
Survey
103 Utah Geological Survey Bldg.
University of Utah
Salt Lake City, Utah 84112
581-6381

Bruce Keating
Department of Geography
University of Utah
Salt Lake City, Utah 84112
581-8218

Doug Kirk
State Planning Coordinator's Office
118 State Capitol
Salt Lake City, Utah 84114
328-5246

Dr. Anching Lin
Department of Civil Engineering
3012 Merrill Engineering Bldg.
University of Utah
Salt Lake City, Utah 84112
581-8565 or 581-6931

David B. Madsen
State Archaeologist
Division of State History
603 East South Temple
Salt Lake City, Utah 84102
328-5755

Stephen McCool
Inst. for Study of Rec. & Travel
Utah State University
Logan, Utah 84322
752-4100 Ext. 7854

Lee McQuivey
Utah Resident Office
Army Corps of Engineers
135 South State Street
Salt Lake City, Utah 84111
524-4264

Jan Paegle
Department of Meteorology
University of Utah
Salt Lake City, Utah 84112
581-6136

James Palmer
American Salt Company
270 Cross Road Square
Salt Lake City, Utah 84115
297-6521

Dr. Don Porcella
Utah Water Research Laboratory
College of Engineering
Utah State University
Logan, Utah 84322
752-4100 Ext. 7821

Dave Price
Utah State Department of Highways
State Office Building
Salt Lake City, Utah 84114
328-5211

Carol Peterson
Utah Geological & Mineralogical
Survey
Utah Geological Survey Bldg.
University of Utah
Salt Lake City, Utah 84112
581-6381

Bill Raetz
National Weather Service
125 South State Street
Salt Lake City, Utah 84111
524-4005

Ed Rawley
Division of Wildlife Resources
1596 West North Temple
Salt Lake City, Utah 84116
328-5081

Dr. Don Reese
717 11th Avenue
Salt Lake City, Utah 94103

Paul Reimann
Attorney General's Office
236 State Capitol
Salt Lake City, Utah 84114
328-5261

Arlo Richardson
State Climatologist
Utah State University
Logan, Utah 84321
752-4100 Ext. 7181

Dr. J. Paul Riley
Utah Water Research Laboratory
College of Engineering
Utah State University
Logan, Utah 84322
752-4100 Ext. 7961

Grant Rogers
U.S. Bureau of Land Management
125 South State Street
Salt Lake City, Utah 84111
524-5348

Bill Schwab
Wasatch Front Regional Council
Farmington County Court House
Farmington, Utah
292-4469

Reed Searle
Utah Legislative Council
326 State Capitol
Salt Lake City, Utah 84114

Don Smith
Division of Wildlife Resources
1596 West North Temple
Salt Lake City, Utah 84116
328-5081

Gerald L. Smith
Department of Landscape Architecture
Utah State University
Logan, Utah 84322
752-4100 Ext. 7346

Sheldon Talbot
U.S. Bureau of Reclamation
125 South State Street
Salt Lake City, Utah 84111
524-5537

Lynn Thatcher
Bureau of Environmental Health
44 Medical Drive
Salt Lake City, Utah 84112
328-6121

Kidd Waddell
U.S. Geological Survey
125 South State Street
Salt Lake City, Utah 84111
524-5663

James Young
Bureau of Sports, Fisheries, and Wildlife
125 South State Street
Salt Lake City, Utah 84111
524-5637

**Core Group of the Great Salt Lake Interagency
Technical Team (as of August 1973)**

<u>Name</u>	<u>Occupation</u>
Lloyd H. Austin	Water Resources
James Christensen	Utah Legislative Council Study Coordinator - Great Salt Lake Study
Mark H. Crystal	State Land Board
T.E. Green, Jr.	State Outdoor Recreation Agency
J. Bruce Keating	University of Utah, Depart- ment of Geography
John Lord	State Planning Coordinator's Office
Ed Rawley	Wildlife Resources
Reed T. Searle	Executive Director - Great Salt Lake Study
James Whelan	Utah Geological & Mineral- ogical Survey

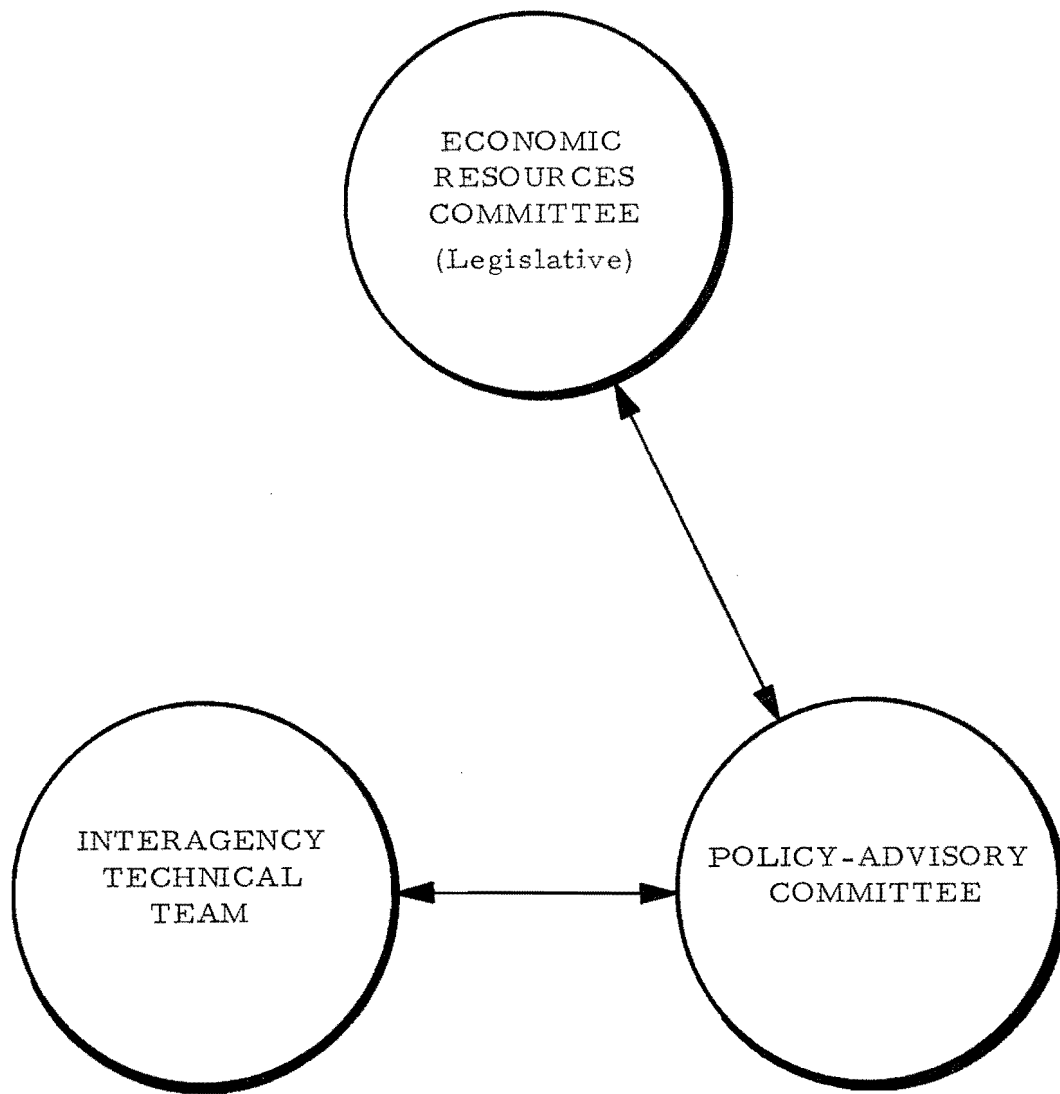

Figure A-1. Organizational structure for the Great Salt Lake study by the Economic Resources Committee of the State Legislature (adapted from information presented at a meeting of the Legislative Committee on Economic Resources at Ogden, Utah, August 17, 1973).