

Development of cement-based lightweight composites : part 1: mix design methodology and hardened properties

Citation for published version (APA):

Yu, Q., Spiesz, P. R., & Brouwers, H. J. H. (2013). Development of cement-based lightweight composites : part 1: mix design methodology and hardened properties. *Cement & Concrete Composites*, 44, 17-29.
<https://doi.org/10.1016/j.cemconcomp.2013.03.030>

DOI:

[10.1016/j.cemconcomp.2013.03.030](https://doi.org/10.1016/j.cemconcomp.2013.03.030)

Document status and date:

Published: 01/01/2013

Document Version:

Publisher's PDF, also known as Version of Record (includes final page, issue and volume numbers)

Please check the document version of this publication:

- A submitted manuscript is the version of the article upon submission and before peer-review. There can be important differences between the submitted version and the official published version of record. People interested in the research are advised to contact the author for the final version of the publication, or visit the DOI to the publisher's website.
- The final author version and the galley proof are versions of the publication after peer review.
- The final published version features the final layout of the paper including the volume, issue and page numbers.

[Link to publication](#)

General rights

Copyright and moral rights for the publications made accessible in the public portal are retained by the authors and/or other copyright owners and it is a condition of accessing publications that users recognise and abide by the legal requirements associated with these rights.

- Users may download and print one copy of any publication from the public portal for the purpose of private study or research.
- You may not further distribute the material or use it for any profit-making activity or commercial gain
- You may freely distribute the URL identifying the publication in the public portal.

If the publication is distributed under the terms of Article 25fa of the Dutch Copyright Act, indicated by the "Taverne" license above, please follow below link for the End User Agreement:

www.tue.nl/taverne

Take down policy

If you believe that this document breaches copyright please contact us at:

openaccess@tue.nl

providing details and we will investigate your claim.



Development of cement-based lightweight composites – Part 1: Mix design methodology and hardened properties



Q.L. Yu^{*}, P. Spiesz, H.J.H. Brouwers

Department of the Built Environment, Eindhoven University of Technology, P.O. Box 513, 5600 MB Eindhoven, The Netherlands

ARTICLE INFO

Article history:

Received 20 March 2012
Received in revised form 16 January 2013
Accepted 20 March 2013
Available online 28 April 2013

Keywords:

Cement-based lightweight composites
Recycled expanded glass
Mix design methodology
Porosity
Strength
Thermal conductivity

ABSTRACT

This article aims at the development of durable cement-based lightweight aggregate composites, with a good balance between the thermal and mechanical properties. The mixtures are developed with the optimized packing applying the modified Andreasen and Andersen model, to obtain the optimal target grading curve of all the solids in the mixture. A lightweight material produced from recycled glass is used as the lightweight aggregates (LWA) in order to obtain the desired low thermal conductivity.

The properties of the designed composites, including the flowability and relative viscosity in fresh state, and the porosity, strength and thermal properties in hardened state are investigated. The porosity of the developed composites is studied by both modeling and experiments. Results indicate that there is a certain amount of closed internal LWA pores in the composites, which contributes positively to a better thermal insulation property. The developed composites have a low thermal conductivity while still retaining sufficient strength. Therefore, the designed composite can be used monolithically as both load-bearing element and thermal insulator.

© 2013 Elsevier Ltd. All rights reserved.

1. Introduction

Concrete is the world's most used man-made building material, thanks to its excellent versatility, availability, durability and economical efficiency. Nevertheless, concrete is often limited to be used in structures such as high-rise or long-span buildings due to its high density, which could lead to a large space demand and a high cost. Instead, this drawback can be perfectly solved by lightweight concrete, as the decreased density can result in reduced member's sections, simplify construction and save space and cost.

Lightweight aggregates concrete (LWAC) has its roots in the ancient period about 3000 years ago when volcanic materials were used as lightweight aggregates [1]. Because of its many advantages such as low density, good thermal insulation and good fire resistance, LWAC has been widely developed and applied as both structural and nonstructural material recently. Among various types of lightweight aggregates (LWA), LWA produced from a special industrial process such as Leca (UK), Liapor (Germany) and Liaver (Germany) are widely used because of certain special features created during this production process [2]. Lightweight concretes are normally categorized into three grades: low density concrete with a dry density lower than 800 kg/m³, moderate strength concrete with a dry density between 800 kg/m³ and 1400 kg/m³ and struc-

tural concrete with a dry density between 1400 kg/m³ and 2000 kg/m³ [3].

Numerous investigations have been conducted on the lightweight concrete. Loudon [4] summarized the thermal properties of lightweight concrete, and reported that density and moisture content are the main factors affecting the thermal conductivity, while the aggregate material can affect the thermal conductivity up to 25%. Bomhard [5] reviewed the application of lightweight concrete and concluded that the relatively high price of lightweight aggregates concrete limits its application and often LWAC is used below its capabilities either because no adequate project or less confidence. Al-Noury et al. [6] studied the relationship between the density and compressive strength of lightweight mortar. They reported that the compressive strength of lightweight mortar can be predicted using an empirical formula, if the relative density of the lightweight mortar to normal weight mortar and the compressive strength of normal weight mortar are known. Zhang and Gjrrv [7] reported that the cement paste penetrates into lightweight aggregates during the mixing, but the amount highly depends on the microstructure of the surface layer of the aggregate, particle size distribution of cement and viscosity of the cement paste. Wasserman and Bentur [8] investigated the interfacial interactions in lightweight aggregate concretes and their influence on the concrete strength. Both physical and chemical characteristics of the LWA strongly affect the strength of the LWAC due to the processes taking place at the interfacial transition zone. The first is a physical process governed by the water absorption and later a

^{*} Corresponding author. Tel.: +31 (0)40 247 2371; fax: +31 (0)40 243 8595.
E-mail address: q.yu@bwk.tue.nl (Q.L. Yu).

Nomenclature

Roman

a_0	parameter (Eq. (8))
b_0	parameter (Eq. (8))
c	mass of the cement (g)
c_0	initial mass of the cement (g)
D	particle size (μm)
m	mass (g)
m_s	surface dried mass of water-saturated sample in air (g)
m_w	mass of water-saturated sample in water (g)
m_d	mass of oven dried sample (g)
n	hydration degree
q	distribution modulus
st_e	structural efficiency (N m/kg)
V	volume (dm^3)
w_0	initial mass of the water (g)
x	mass fraction

Greek

α_0	degree of carbonation of monosulfate phase
λ	thermal conductivity (W/(m K))
ρ	density (kg/m^3)

σ_c	compressive strength at 28 days (N/mm^2)
φ	volume fraction
v	specific volume (cm^3/g)

Subscript

CLC	CLC
C_3S	C_3S
C_2S	C_2S
C_3A	C_3A
C_4AF	C_4AF
CS	CS
d	compressed water
i	fraction size of the LWA
lwa	lightweight aggregates
max	maximum
min	minimum
p	water permeable
paste	cement paste
s	chemical shrinkage
w	capillary water
v	void fraction

chemical process via two possible routes of pozzolanic reaction between the aggregates and the alkaline pore solution, which penetrates into it or an impregnation process in which calcium hydroxide deposits in the pores of the aggregates. Alduaij et al. [9] researched lightweight concrete in hot coastal areas applying different types of LWA. With expanded clay as LWA, they reported a compressive strength of 15.5–29.0 N/mm² when increasing the cement content from 250 to 350 kg/m³, while keeping similar densities of about 1500 kg/m³. Chandra and Bertsson [1] summarized the research, technology and applications of lightweight aggregate concrete. They systematically reviewed the production and properties of the LWA, the production technique and properties of LWAC, including microstructure, physical properties, durability, fire resistance and applications of the LWAC. Demirboga and Gul [10] investigated the thermal conductivity and compressive strength of expanded perlite aggregate concrete with mineral admixtures. They reported that silica fume and fly ash as replacement for cement can decrease the thermal conductivity up to 15%, but the density and compressive strength of the concrete is also reduced, up to 30%. Choi et al. [11] investigated the relation between the flowability and mechanical properties of high-strength lightweight self-compacting concrete. They designed a lightweight self-compacting concrete with the density between 2000 and 2300 kg/m³ and found it is difficult to obtain a sufficient flowability with the increase of the lightweight fine aggregates in the mixture. Ünal et al. [12] developed a lightweight concrete block applying diatomite as LWA with a 28-day compressive strength of about 3.5–6.0 N/mm² and the densities of about 950–1200 kg/m³. A linear relation between the cement content and thermal conductivity of the LWAC was found, the thermal conductivity increased from 0.22 to 0.30 W/(m K) as the cement content increased from 250 to 400 kg/m³. Liu et al. [13] developed a lightweight aggregates concrete with high resistance to water and chloride-ion penetration. With the cement content of 500 kg/m³ and unit density of 1400 kg/m³, applying expanded clay and expanded glass as lightweight aggregates, the 28-day compressive strength of the LWAC reached 24 N/mm². In Liu et al. [13], Chia and Zhang [14], Nyame [15], Bentz [16] and Liu et al. [17], the durability of lightweight

concrete was addressed, but controversial findings with regard to the effect of LWA on permeability of concrete were reported.

Nevertheless, so far there is still no systematic study on LWAC regarding the mix design methodology. There are usually two objectives to the design of the LWAC, either to achieve as low thermal conductivity (or low density) as possible or to achieve as strong mechanical properties as possible, but no studies have yet been reported to obtain a LWAC with a low density while retaining sufficient mechanical properties. In addition, the available mix designs for lightweight concrete are targeted without taking into account its permeability, which is determined by the porosity and connectivity of the pores in the lightweight composites. Durability, in addition to the mechanical and thermal properties, is a very important factor determining the quality of lightweight composites.

The present study, therefore, addresses the development of lightweight cement-based composites, with excellent thermal properties, durability and sufficient mechanical properties. The designed composite is supposed to be used in monolithic concrete structures, on the one hand, as load-bearing structure, and on the other hand as thermal insulation material. Meanwhile, a good durability, i.e. low permeability assures a low water intake between the internal and external environment, which in turn promises again a good thermal comfort to the residents. This study is presented as two parts. As Part 1 of the present study, this article presents a mix design methodology of the cement-based lightweight composites and their hardened properties. Then in Part 2, the durability related properties of the developed composites are presented [18]. The present article consists of four sections. In Section 2, the mix design as well as the behavior of the developed cement-based lightweight composites (CLC) in their fresh state will be presented and analyzed. Two different types of CLC, including self-compacting cement-based lightweight composites (SCLC) and vibrated cement-based lightweight composite (VCLC), are developed to compare their properties and the applied mix design methodology. In Section 3, the properties of the designed composites in hardened state including porosity, mechanical properties and thermal properties are investigated. Finally brief conclusions are reached in Section 4.

2. Mix design

2.1. Materials

The cement used in this study is Ordinary Portland Cement (OPC) CEM I 52.5 N, provided by ENCI B.V. (The Netherlands). The lightweight aggregates used here are produced from recycled glass, via a special procedure. These LWA have internal cellular pore structures. Although in some extent the pores inside the particles are interconnected, most of them remain closed and separated, and the outer surfaces are rather closed, as can be seen in Fig. 1. The used LWA have very low particle densities, which provide great freedom to design lightweight concrete to desired low density, i.e. low thermal conductivity. On the other hand, the LWA still have relatively strong crushing resistance, up to 12 N/mm², which makes it possible to design structural lightweight concrete with these LWA [19]. However, as this type of LWA is produced from expanded glass, it can potentially cause alkali-silica reaction. Therefore, this will be investigated in the present study. Limestone powder is used as filler to adjust the powder amount in the mixture. Normal weight aggregates used are broken sands with two different fractions of 0–1 mm and 0–4 mm and micro-sand, containing a high amount of powder fraction (<125 μm), with the maximum particle size of 1 mm (Graniet-Import Benelux, The Netherlands). A polycarboxylic ether-based superplasticizer is used to adjust the workability. The used materials are summarized in Table 1 and Fig. 2.

The water absorption of LWA is normally an influential factor in the lightweight aggregates concrete design and production, since LWA absorb a certain amount of free water from the mixture before setting. It is shown that the water absorption of lightweight aggregates could have a negative influence on the workability, if mixing them with other materials under dry conditions prior to adding water [1,13,20,21]. However, this negative effect depends not only on the used amount of the lightweight aggregates, but also clearly on their type and production process. There are two mixing methods which are widely used to address this issue, i.e. to presoak the LWA in water for a certain period, usually 30 min to 1 h [1,22], or to add extra water which is calculated normally based on the 1 h water absorption [13]. Both methods have disadvantages especially regarding the LWA used in this work. The presoaked LWA should be surface dried before mixing with other materials for the concrete production. However, for the lightweight aggregates used here, this could cause considerable errors due to their very small particle size. Adding extra water from the beginning of the mixing process can easily cause segregation or bleeding of the mixture, especially in the case of self-compacting lightweight mortar or concrete. However, as listed in Table 2, the water

Table 1
Properties of materials used.

Material	Type	Specific density (kg/m ³)
Cement	CEM I 52.5 N	3180
Filler	Limestone powder	2710
Fine sand	Microsand	2720
Fine sand	Sand 0–1 mm	2650
Coarse sand	Sand 0–4 mm	2650
LWA	Expanded glass	310–810 ^a
Superplasticizer	Polycarboxylate ether	1100

^a See detailed information in Table 2.

absorption of the used LWA is quite low, especially in the first hour (approximately 1.0% by mass), due to their rather closed external surfaces (see Fig. 1). A more detailed analysis of the water absorption of the used LWA is presented in [23]. Hence, the applied LWA should not affect the workability significantly, and on the other hand, the absorbed free water reduces the water/cement ratio at the early stage after concrete casting, and as a consequence the micro-bleeding at the aggregates surfaces is prevented [19]. Moreover, the absorbed water also contributes to the hydration process in a later stage due to the so called internal curing effect. Therefore, in the present study, the LWA is applied in dry conditions directly to the mixture and no extra water is added.

2.2. Mix design

A good balance between the thermal and mechanical properties of the developed composite is the main design target. As shown in Fig. 3 [24], the optimal mix is reached by designing the mixture with a high porosity but low permeability at the same time. In order to produce a lightweight composite with low permeability, it is of vital importance to combine together proper LWA with a dense hardened paste, i.e. well bound to the aggregates. Contrary to other available researches, in the design approach followed in this study, a particle packing model is used to maximize the packing density of the granular solid materials. The mixes of the cement-based lightweight composite (CLC) are designed using a mix design tool applying the optimized packing methodology. Applying the optimized packing method, the particles can be better packed, which results in improved hardened properties as well as improved workability, since more water is available to act as lubricant between the particles [25]. In this mix design method, the modified Andreasen and Andersen (A&A) model, as shown in Eq. (1), acts as a target function for the subsequent granular optimization of the individual materials (detailed information is presented in [26]). The proportions of the individual

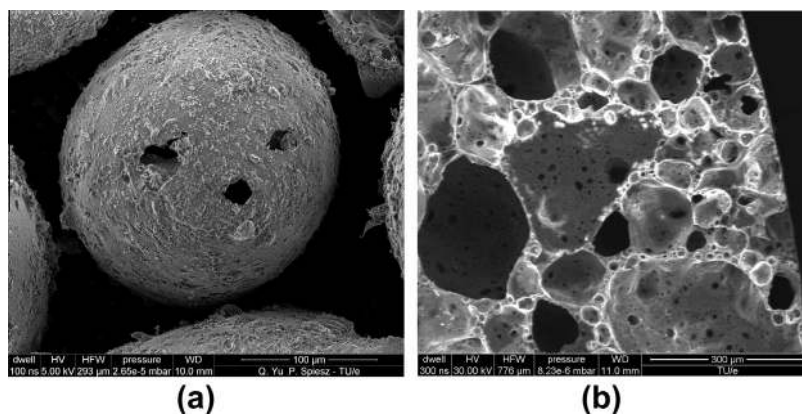

Fig. 1. SEM pictures of LWA: (a): open pores seen from outside; (b): interconnected pores.

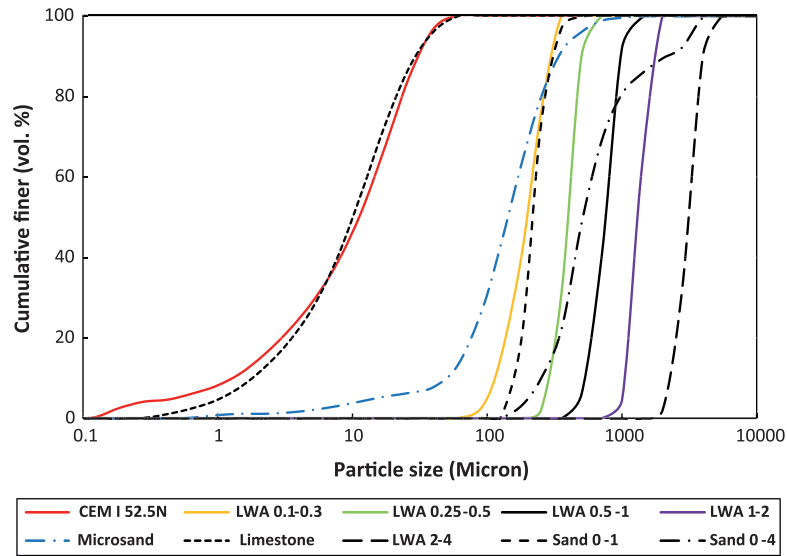

Fig. 2. Particle size distribution of the used materials.

Table 2
Characteristics of lightweight aggregates used.

LWA type	Particle size (mm)	Dry particle density ^a (kg/m ³)	1 h water absorption (wt.%)	24 h water absorption (wt.%)
LWA 0.1–0.3	0.1–0.3	810	1.06	2.81
LWA 0.25–0.5	0.25–0.5	540	0.88	3.90
LWA 0.5–1.0	0.5–1.0	450	1.59	8.50
LWA 1.0–2.0	1.0–2.0	350	1.71	7.63
LWA 2.0–4.0	2.0–4.0	310	0.55	7.80

^a Taken from the provider.

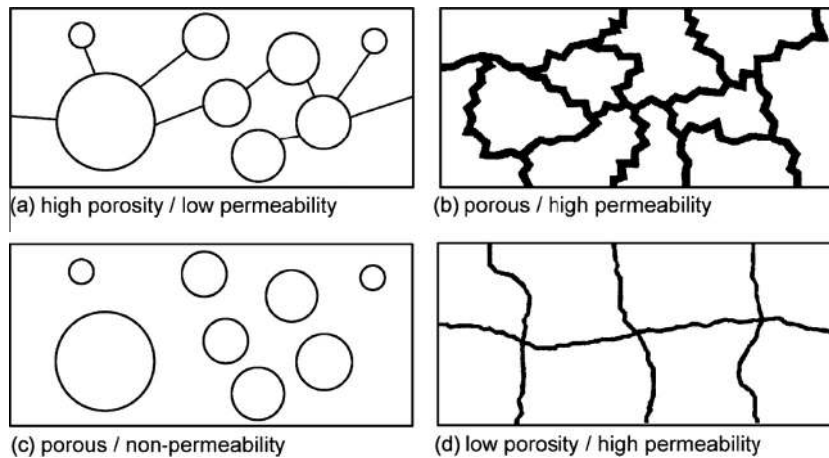

Fig. 3. Possible interrelations between porosity and permeability [24].

materials in the mix are adjusted until an optimum fit between the composed mix grading curve and the target curve is reached, using an optimization algorithm based on the Least Squares Method (LSM), i.e. the deviation between the target curve and the composed mix expressed by the sum of the squares of the residuals (RSS) at defined particle sizes is minimal [26,27,28]. Hence, the optimized mixture will possess a compact structure/matrix due to the optimal packing but also large value of non-interconnected pores, contributed by the LWA, which theoretically will lead to sufficient mechanical properties as well as good thermal insulation. So far this design methodology has not been addressed in the literature for the design of LWAC.

$$P(D) = \frac{D^q - D_{\min}^q}{D_{\max}^q - D_{\min}^q} \quad (1)$$

where $P(D)$ is a fraction of the total solids being smaller than size D , D is the particle size (μm), D_{\max} is the maximum particle size (μm), D_{\min} is the minimum particle size (μm) and q is the distribution modulus.

Densities of lightweight concrete are strongly linked with its thermal properties. Neville [20] reported that there is an almost linear relation between the thermal conductivity and the density of lightweight concrete produced with different types of lightweight aggregates such as pumice, perimite, vermiculite, cinders,

expanded shale and expanded slag. Loudon [4] also reported that, despite the effect of the type of the used lightweight aggregates, the thermal conductivity of lightweight concrete decreases when its density decreases. Therefore, here the effect of density on the investigated properties is taken into consideration. Two types of composites with different workability are developed, which are self-compacting and conventionally vibrated, to investigate the influence of the water content and the used distribution modulus. As from [20,29], the strength of concrete is related to the cement content. The compressive strength of lightweight concrete produced from expanded clay and sand increases from 12 to 25 N/mm² when the cement content increases from 250 to 480 kg/m³ [20]. Therefore, in the present study the used cement content is set as a fixed and economically acceptable value in order to minimize the effect of its dosage on the investigated targets.

It is recommended [30] that a water/powder ratio by volume of 0.85–1.10 is a suitable starting value for the water content determination in order to design self-compacting concrete, which is also confirmed by Hunger [31], who reported an optimal water/powder ratio by mass of 0.30. Due to the high fluidity, self-compacting concrete/mortar normally has a risk of segregation and bleeding, which can be prevented by the use of a sufficient amount of fines (defined as particles with a size smaller than 125 µm). Hence, in the present study, the water amount, i.e. water/powder ratio is chosen as one of the research topics, and different water contents are used to investigate their effect.

For the distribution modulus used in the modified A&A grading equation, Hunger [31] recommended a value of 0.25 for the design of self-compacting concrete. As discussed in [23,27], a smaller distribution modulus leads to a mixture with a larger amount of fine materials, which in turn results in a larger water demand if the same flowability is required. Hüsken [19] reported that the compressive strength decreases with the increase of the distribution modulus q and the decrease is larger with a q from 0.25 to 0.30 than with a q from 0.35 to 0.40. In [28], the effect of the distribution modulus q on the calcium sulfate-based lightweight composite was also investigated and a similar finding was reported, i.e. the increase of the q leads to a reduction of the compressive strength. Thus, here two different values of 0.25 and 0.32 are applied as the preliminary design values to study their effect. For the vibrated lightweight composite design, a larger distribution modulus value of 0.35 is used, which is usually suitable for conventional vibrated concrete design [32]. A much lower water content is chosen (water/cement ratio of 0.35 by mass), because on the one hand this value is common for conventional vibrated concrete, and on the other hand a comparable density of this mix to mix SCLC2 is set in order to study the relation between the density and other properties.

Therefore, applying the optimization algorithm, a preliminary design of the solid materials of three mixes is derived here. The designed grading curve as well as the PSDs of the used materials is shown in Fig. 4, using mix SCLC1 as an example (Table 3), with the absolute amount of all the materials ready to be varied by adjusting the water content and superplasticizer (SP) dosage in order to achieve the desired flowability.

2.3. Fresh state behavior

The fresh state behavior analysis of the designed mixtures, especially in the case of the self-compacting composites, is essential because only through this step the final water content as well as the dosage of the superplasticizer can be determined. To reach the desired workability, the designed mix must have an optimal balance between the water content and the SP dosage. Insufficient dosage of the SP results in insufficient flowability; however, overdosing the SP may lead to segregation, bleeding, blockage or to a

negative influence on the hydration process. For normal weight self-compacting mortar, two workability parameters are usually investigated, i.e. the slump flow and the funnel time, which are used to assess the flowability and relative viscosity of the mixture, respectively. In the present study, these two parameters are also employed for the mix development.

Normally, lightweight aggregates adsorb a certain amount of water due to their open pores, but the LWA used in the present study have a very low water absorption, especially in the early stage due to their rather closed external surfaces (Table 2). The water absorption of the LWA after contact with water for 6 min, which is about the time to perform the mini-slump flow and V-funnel test, is only approximately 0.2% by mass [23], which indicates that the influence of the water absorption on the measured slump flow spread and V-funnel time can be neglected.

The mini-slump flow test, performed in order to investigate the flowability of the designed lightweight composite, is carried out employing the Hägermann cone (see detailed test procedure presented in [28]). Tregger et al. [33] investigated the rheological properties of self-compacting cement paste using the mini-slump flow test, and reported that the spread of the sample becomes stable at the time of 20 s, which is in line with the duration of the measurement performed here. The relative viscosity and blocking behavior of the sample is investigated by carrying out the V-funnel test with sizes shown in Fig. 5, following the procedure described in EFNARC [30] for mixes with the maximum particle size smaller than 4 mm.

Varied slump flow values from 240 mm to 330 mm and V-funnel times from 4 s to 11 s are reported for self-compacting normal aggregates concrete [25,30,31,34–37]. Different from self-compacting normal aggregates concrete, a great amount of fines is needed to bound the LWA in order to avoid the segregation of the developed composite due to the low density of the LWA. Therefore, the viscosity of the mixture should be higher than for normal SCC. Hence, in the present study a slump flow value of 300 mm and V-funnel time value of 9–11 s are chosen as the target values.

By slightly modifying the proportion of the solid ingredients and changing the amount of SP or the water content, trial experiments are performed in order to achieve the above mentioned target values. A maximum effective SP dosage of 1.0% by mass of the cement is found here. Results show that the slump flow remains constant when increasing the SP amount from 1.0% up to 1.5% by mass of cement. Actually, this addition (1.0%) is also the recommended value by the SP producer. This is in line with [31], who reported that from a certain dosage of superplasticizer (1.5% based on the cement content), the mixture (self-compacting mortar) will not respond anymore with an increase of the slump flow. This indicates that an overdose of SP will not contribute to the flowability, but on the contrary it might cause problems such as segregation and delayed setting.

The water dosage is adjusted in order to reach the desired density and the target flowability. The spread flow increases from 250 mm to 300 mm and V-funnel time decreases from 11 s to 6 s when the water/cement ratio increases from 0.45 to 0.60 with a fixed SP dosage of 1.0% by mass of cement, and a water/cement ratio of 0.59 is finally selected to be used in the mix of SCLC1. The spread flow increases from 300 mm to 340 mm while the V-funnel time decreases from 16 s to 10 s when the water/cement ratio increases from 0.51 to 0.60 with a fixed SP dosage of 1.0% by mass of cement. A water/cement ratio of 0.54 is finally selected to be used in the mix of SCLC2 based on these results.

Hunger [31] reported a V-funnel value between 4 and 6 s for a self-compacting cement mortar using normal weight aggregates, and he reported that a V-funnel time of about 7.5 s already causes the blockage of the V-funnel, which apparently is shorter than the time obtained here, especially in the case of mix SCLC2. This can be

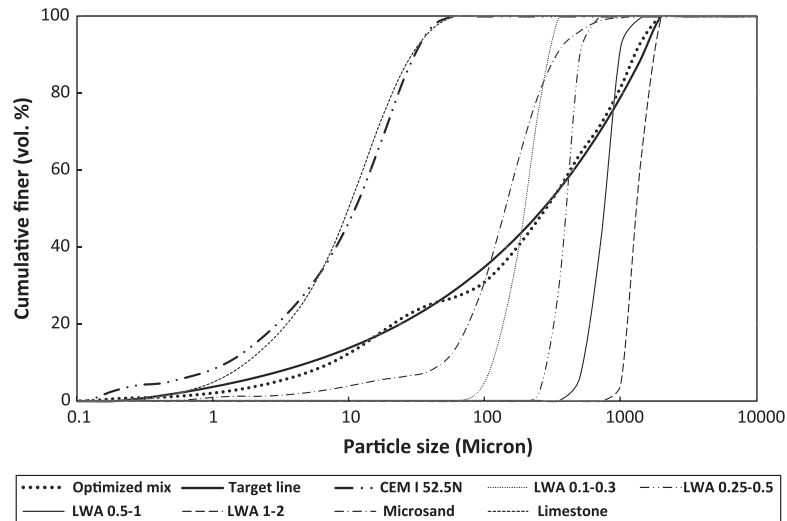

Fig. 4. Particle size distribution of the used materials and the composed mix SCLC1 and target line (with $q = 0.32$).

Table 3
Dosages of the developed mixes.

Material	SCLC1 (kg/m ³)	SCLC2 (kg/m ³)	VCLC (kg/m ³)
CEM I 52.5 N	425.3	423.5	419.7
Limestone powder	111.9	259.6	0
Sand 0–4	0	0	407.0
Sand 0–1	0	95.6	0
Microsand	381.5	424.6	306.0
LWA 0.1–0.3	56.0	68.3	0
LWA 0.25–0.5	44.8	0	0
LWA 0.5–1.0	56.0	54.9	0
LWA 1.0–2.0	44.8	39.4	63.6
LWA 2.0–4.0	0	0	71.6
Water	250.9	230.3	159.4
SP (% mass of cement)	1.0%	1.0%	0.8%
Water/cement ratio	0.59	0.54	0.38
Water/powder ratio	0.35	0.26	0.29
Distribution modulus	0.32	0.25	0.35

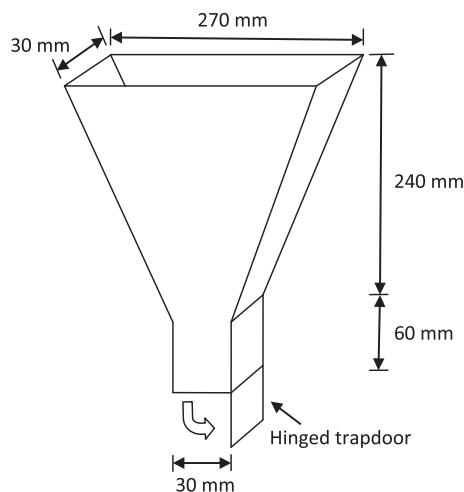

Fig. 5. Sizes of used V-funnel with the volume of 1.13 dm³.

of the mix SCLC2, which results in even larger powder content in this mix than that of SCLC1, as can be seen in Table 3. However, to use such a large amount of fine materials is necessary to avoid the segregation of the mixture. This also indicates that the low values recommended by [31] are less suitable for the design of self-compacting lightweight mortar.

For the VCLC, two target values are used here, i.e. the density and the flow determined on a jolting table. The target density of the VCLC is chosen to be similar to the SCLC2 in order to compare their properties in hardened state. The flow test is carried out using a Hägermann cone and a jolting table (15 jolts) with a target flow value of 150 mm. Based on these requirements, a final water/cement ratio of 0.38 is chosen and a SP dosage of 0.8% by mass of cement. Hence, the final determined mix proportions of these three composites are listed in Table 3.

3. Results and discussion

As the designed lightweight composites are supposed to be used in monolithic concrete structures, the porosity, density, strength, and thermal conductivity of the CLC in hardened state are essential to be evaluated. The porosity is addressed through both modeling and experimental measurements, while the thermal and mechanical properties are experimentally investigated.

explained by the large amount of powders used in these two mixes compared to the powder content used in the self-compacting mortar in [31]. The distribution modulus of 0.25 is used for the design

3.1. Porosity

3.1.1. Modeling

Fig. 6 shows the schematic diagram of the designed CLC. As can be seen, the CLC is composed of lightweight aggregates, cement paste, sand, inert filler and air. In the matrix, the porosity originates from both the internal porosity of LWA and from the porosity of the cement paste. Chandra and Berntsson [1] reported that the exchange of air and water during the water absorption results in a rim of air bubbles in the interfacial transition zone (ITZ) of the lightweight aggregates concrete. However, this does not seem to occur in the present study, as shown in Fig. 7. There it can be clearly seen from the SEM picture that no air bubbles are present in the interface zone of the CLC. So here the additional porosity of the interface zone in the composite is assumed to be very small and therefore not considered in the calculation.

The internal porosity of the LWA in the designed composite is calculated from

$$\varphi_{v,LWA} = \frac{\sum_{i=1}^n \left[V_{LWA,i} \times \left(1 - \frac{\rho_{lwa,i}}{\rho_{slwa}} \right) \right]}{\sum_{i=1}^n V_{LWA,i}} \quad (2)$$

where $\varphi_{v,LWA}$ is the porosity introduced by LWA in the designed composites, $\rho_{lwa,i}$ (g/cm³) is the apparent density of aggregate particles in fraction *i*, ρ_{slwa} (g/cm³) is the specific density of the aggregate raw material and $V_{LWA,i}$ is the volume of the LWA in fraction *i*.

The porosity resulting from the hydration of cement consists of two parts: the first part is the capillary porosity and the second part is the chemical shrinkage porosity due to cement hydration, which can be described using a model proposed by Brouwers [38], reading

$$\varphi_{v,paste} = \varphi_w + \varphi_s = \frac{\frac{w_0}{c_0} - n \left(\frac{w_d v_d}{v_w c} \right)}{\frac{v_c}{v_w} + \frac{w_0}{c_0}} \quad (3)$$

where φ is the volume fraction, w_0/c_0 is the initial water/cement ratio by mass, *c* is the hydrated cement content (g), v_d is the specific volume of the compressed water (here meaning gel water + non-evaporable water) (cm³/g), v_c is the specific volume of the cement (cm³/g) (here a value of 0.314 cm³/g is obtained from the specific density of the used cement, see Table 1), v_w is the specific volume of water (cm³/g) (here a value of 1.0 cm³/g is used), w_d is the mass of reacted water (g), *n* is the hydration degree, subscript *v* is the void fraction, paste is cement paste, *w* is the capillary water and *s* is the chemical shrinkage.

Brouwers [38,39] proposed an expression to compute $(w_d v_d)/(v_w c)$ in Eq. (3) under the assumption of a congruent and full hydration, reading

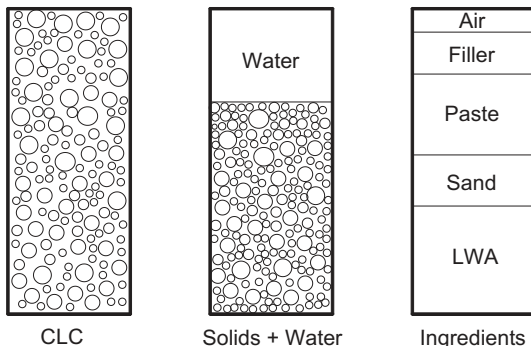

Fig. 6. Schematic diagram of the volume composition of CLC.

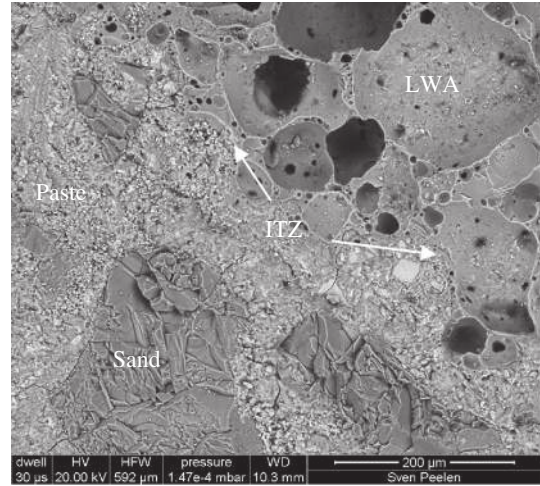

Fig. 7. SEM picture of the lightweight composite (the developed VCLC).

$$\frac{w_d v_d}{v_w c} = 0.284x_{C_3S} + 0.301x_{C_2S} + 1.141x_{C_3A} + 0.387x_{C_4AF} + (0.320\alpha_0 - 0.082)x_{C\bar{S}} \quad (4)$$

where *x* is the mass fraction, subscripts C₃S, C₂S, C₃A, C₄AF, C \bar{S} are alite, belite, aluminat, ferrite, and anhydrite respectively and α_0 is the degree of carbonation of the monosulfate phase. The mass fractions of the above mentioned five phases are calculated using the Bogue method and the chemical composition of the used cement obtained from the provider (shown in Table 4a) [40], and the results are listed in Table 4b. The degree of carbonation of the monosulfate phase (α_0) is assumed zero, due to the short curing period of 28 days. Hence, $(w_d v_d)/(v_w c)$ can be calculated using the given values, yielding 0.330.

Therefore, the porosity of the designed lightweight composites can be calculated from

$$\varphi_v = \varphi_{v,LWA} \times \varphi_{LWA} + \varphi_{v,paste} \times \varphi_{paste} \quad (5)$$

where φ_v is the porosity of the designed composites. The results are listed in Table 5. Here the hydration degree is assumed to be 0.7 for the curing age of 28 days [1].

Table 4

Chemical composition of CEM I 52.5 N: (a): oxides content; (b): phase content computed from the Bogue method.

Substance	Content (%)				
<i>(a)</i>					
LOI	1.56				
Na ₂ O	0.35				
MgO	1.99				
Al ₂ O ₃	4.80				
SiO ₂	19.64				
P ₂ O ₅	0.59				
SO ₃	2.87				
Cl	0.06				
K ₂ O	0.56				
CaO	63.34				
TiO ₂	0.34				
Fe ₂ O ₃	3.28				
Others	0.62				
<i>(b)</i>					
Cement type	x_{C_3S}	x_{C_2S}	x_{C_3A}	x_{C_4AF}	$x_{C\bar{S}}$
CEM I 52.5 N	0.571	0.142	0.082	0.091	0.039

Table 5
Theoretical porosity of the designed lightweight composites.

Mix	$\varphi_{v,paste}$ (%)	φ_{paste} (dm ³ /m ³)	$\varphi_{v,LWA}$ (%)	φ_{LWA} (dm ³ /m ³)	φ_v (%)
SCLC1	39.71	384.6	79.73	404.2	47.50
SCLC2	36.18	363.5	79.25	318.7	38.40
VCLC	21.47	291.4	86.67	412.6	42.01

3.1.2. Experiments

The vacuum-saturation technique is applied in order to saturate the accessible pores with water, as this technique is referred to as the most efficient saturation method [41]. Samples with a format of a disc (a height of 10–15 mm and a diameter of 100 mm) are extracted from the inner layer of three 150 mm cubes for each prepared lightweight composite.

The saturation is carried out on three samples for each mix, following the standards NT Build 492 [42] and ASTM C1202 [43]. The following test procedure is employed:

- Place the samples in a desiccator and apply a pressure of 40 mbar for 3 h.
- Fill in slowly the desiccator with water (with the pump still connected and running) until approximately 10 mm more than the top surface of the samples.
- Maintain the pressure for an additional hour, then turn the pump off.
- Let the samples soak in water for 18 h.
- Measure the mass of the surface dry samples in air.
- Measure the hydrostatic mass of the samples (in water).
- Dry the sample in an oven at 105 °C until a constant mass is reached, then measure the mass.

The water-permeable porosity is calculated as follows:

$$\varphi_{v,p} = \frac{m_s - m_d}{m_s - m_w} \times 100, \quad (6)$$

where $\varphi_{v,p}$ is the water-permeable porosity (%), m_s is the surface dried mass of the water-saturated sample in air (g), m_w is the mass of water-saturated sample in water (g), and m_d is the mass of the oven-dried sample (g).

The results of the measurements are listed in Table 6. It can be seen that all the obtained values are larger compared to conventional concrete, for instance [41] reported a porosity of 20.5% of the concrete produced with a water/cement ratio by mass of 0.60 employing the same measurement method, i.e. vacuum-saturation technique. This is attributed to the large internal porosity of the lightweight aggregates. Although the external shell of the used expanded glass lightweight aggregate is rather closed and impermeable, it still contains some openings which are interconnected (see Fig. 1), through which liquids can enter the aggregates. The inflow of water into the LWA is even more efficient during the vacuum-saturation process, however there is also a risk that the applied

low pressure could damage the outer shells of the aggregates, exposing the closed pores and increasing the real permeable porosity.

3.1.3. Discussion

The measured water-permeable porosities are similar for the two self-compacting composites, 34.31% and 34.97% in average for SCLC1 and SCLC2 respectively; while for the VCLC it is slightly lower, 30.65% in average, as shown in Table 6. Nevertheless, all the measured values of the permeable porosities are smaller than the calculated corresponding values, as listed in Table 5. This indicates that some of the pores in the used LWA are closed and not accessible to water transport.

The calculated total porosity of SCLC1 is larger than SCLC2 but their measured water-permeable porosities are similar. It is shown in Table 5 that both SCLC1 and SCLC2 have very similar porosities contributed by the paste due to the similar water/cement ratios used in these two mixes. However, as can be seen in Table 6, the internal pores of the LWA in SCLC2 are much more interconnected. The possible reason is attributed to the larger amount of the LWA 0.1–0.3 used in mix SCLC2. Apparently, the finest LWA fractions can be permeated by water easier than the coarser fractions, probably because the distance that water has to travel with the LWA is shorter. This size effect means that the probability of reaching a dead-end pore that hinders any further transport of water is lower in smaller particles.

The measured water-permeable porosity of VCLC is the smallest for all the three mixes, which can also be explained by the mix design. As shown in Table 3, only fractions of LWA with the large size of 1–2 mm and 2–4 mm are used in the VCLC. Therefore the interconnection possibilities between particles are reduced to some extent, and besides the water transport route is reduced also due to the small capillary porosity of the paste (low water/cement ratio, see Table 5). A more detailed analysis with regard to the understanding of the problems associated with the permeability of the composite is further presented in the Part 2 of this study [18].

3.2. Mechanical properties

Fig. 8 shows the compressive and flexural strength development of the lightweight aggregates composites as a function of the curing time. All these three mixes have a similar feature of a quite fast early stage strength development. The compressive strength of the mixes SCLC1 and SCLC2 after 24 h curing reaches 58.8% and 57.1% of their compressive strength at 28 days, respectively, while the compressive strength of VCLC reaches even 74.5% of its value at 28 days after 24 h curing.

This probably can be explained by the used lightweight aggregates. The relatively high strength at 1-day compared to its 28-day compressive strength probably does not mean the fast strength development, as the final strength in fact is not very high. It may only indicate that the final strength is significantly affected by

Table 6
Water permeable porosity measured using vacuum-saturation method.

Mix	Sample number	m_s (g)	m_w (g)	m_d (g)	Water-permeable porosity $\varphi_{v,p}$ (%)	Average $\varphi_{v,p}$ (st. dev.) (%)
SCLC1	1	140.78	56.74	111.42	34.94	34.31 (1.62)
	2	140.90	53.45	109.84	35.52	
	3	137.00	49.97	108.74	32.47	
SCLC2	1	180.28	81.72	145.37	35.42	34.97 (2.05)
	2	199.51	101.32	167.38	32.72	
	3	187.37	88.77	151.13	36.75	
VCLC	1	168.29	71.87	138.95	30.43	30.65 (0.26)
	2	168.61	72.72	138.94	30.94	
	3	172.67	74.86	142.75	30.59	

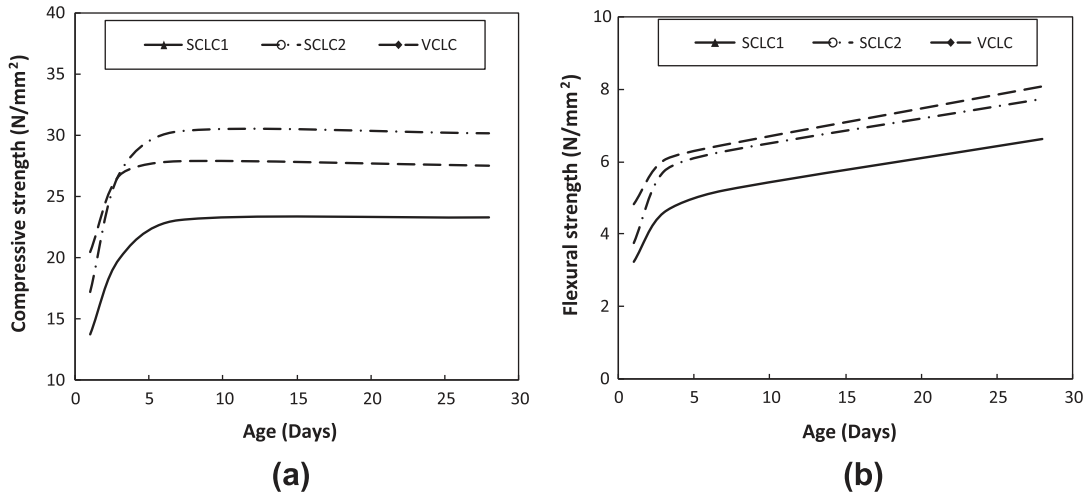

Fig. 8. Strength of the three lightweight aggregates composites ((a) compressive strength; (b) flexural strength).

the applied LWA, as will be discussed. Although, the porous structure of the used LWA allows absorption of water into their pores, so then the absorbed water can be used later on for “internal curing” during the hardening process [1].

Another remarkable finding is that the compressive strength of all the three mixes already reaches the maximum value at the age of only 7 days, as can be seen in Fig. 8a. This is confirmed by [17], who observed very similar phenomena using the same type of expanded glass as aggregates. A statistic comparison of the strength development of the lightweight concrete containing different types of LWA is presented here, and the results are shown in Fig. 9. It is clearly seen that the lightweight concrete, although produced from different types of LWA, has the similarity of fast strength development at early age. This feature becomes more significant especially in the case of the lightweight concrete with the 28-day compressive strength lower than 30 N/mm². This probably can be attributed to the effect of the lightweight aggregates, i.e. the compressive strength of the lightweight composites from one point is dominated by the strength of the used LWA and not by the strength of the cement matrix. This is also confirmed by the flexural strength results, as shown in Fig. 8b. It clearly shows that the flexural strength of the three mixes is continuously increasing until the age of 28 days, which indicates that the hydration process is still going on although the compressive strength does not increase anymore.

As discussed in the previous section, for lightweight concrete or mortars, the compressive strength is strongly linked with their density, i.e. the compressive strength decreases with the decrease of the density. Especially when applied in long-span or high-rise buildings, the density and strength of the lightweight concrete is crucial, i.e. to reach a high strength while retaining low density. This relation is usually investigated using the so called structural efficiency, which is calculated from the ratio of the compressive strength at 28 days to the density, as

$$ste = \frac{\sigma_c}{\rho} \quad (7)$$

where *ste* is the structural efficiency (N m/kg), σ_c is the compressive strength at 28 days (N/mm²) and ρ is the apparent density of the sample (kg/m³), respectively.

The structural efficiencies, as well as the densities of these three mixes and their relevant compressive strengths at 28 days are listed in Table 7. It can be clearly seen that, although the compressive strength and densities of the three mixes are different from each other, the calculated structural efficiencies are very similar.

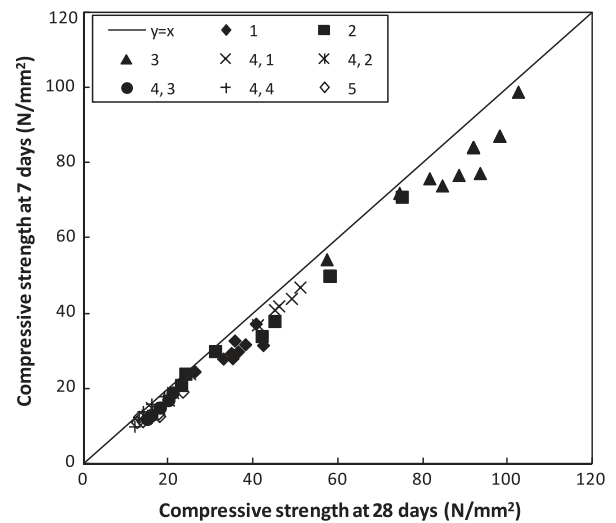

Fig. 9. Compressive strength comparison between the age of 7 days and 28 days of lightweight concrete/mortar using different types of LWA, note: 1: expanded clay [1]; 2: expanded clay [13]; 3: expanded clay [22]; 4.1: recycled stone [31]; 4.2: pumice [31]; 4.3: tuff [31]; 4.4: diatomite [31]; 5: expanded polystyrene [44].

This may be explained by the used cement content in the lightweight composites. As presented in Table 3, the cement content in the present study is kept at the same low level, around 420 kg/m³, for all the three mixes.

Further analysis of the structural efficiency is carried out using the lightweight aggregates concrete/mortar produced with different types of LWA, such as expanded clay, pumice, tuff, diatomite and recycled bricks [1,9,44,45], and the results are shown in Fig. 10. Surprisingly, it can be seen in Fig. 10a that the structural efficiency has a rather good linear relation with the compressive strength of the lightweight concrete, although produced from different types of LWA. However, the structural efficiency of the lightweight aggregates concrete does not have any clear relation with their density, as can be seen from Fig. 10b. This demonstrates that the compressive strength of lightweight concrete is not necessarily linked with its density, but more with the type of lightweight aggregates used. It also indicates that the structural efficiency is more dominated by the compressive strength than the density of the lightweight concrete/mortar. One can also conclude that the

Table 7
Compressive strength, density and calculated structural efficiency of the lightweight aggregates composites.

Mix	Compressive strength (N/mm ²)	Density (kg/m ³)	Structural efficiency (N m/kg)
SCLC1	23.3	1280	18,200
SCLC2	30.2	1490	20,260
VCLC	27.5	1460	18,456

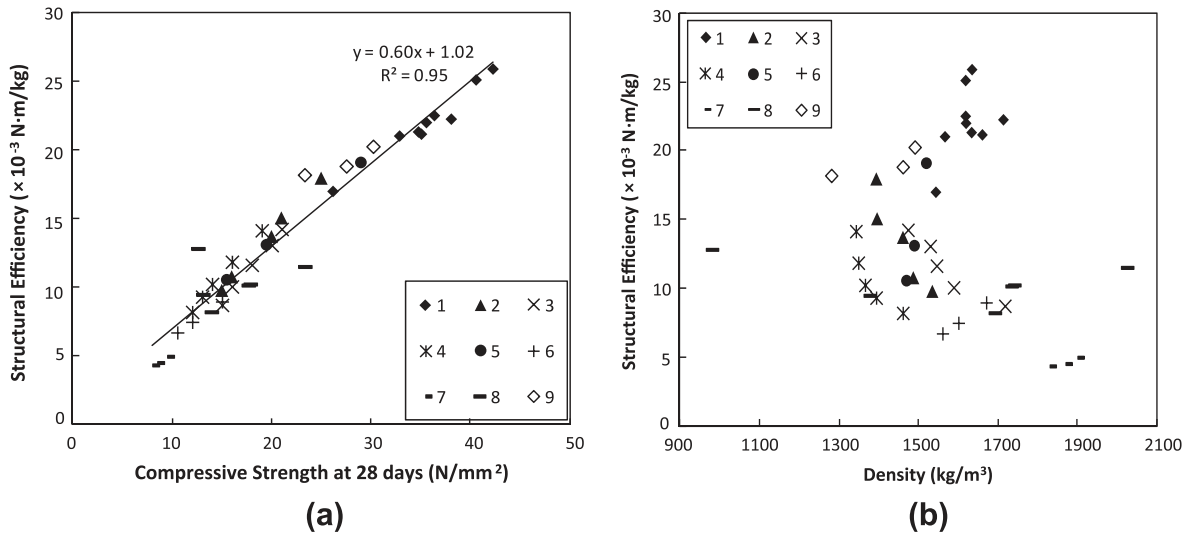

Fig. 10. Structural efficiency of lightweight concrete/mortar using different types of LWA ((a) versus compressive strength at 28 days; (b) versus density), note: 1: expanded clay [1]; 2: pumice [45]; 3: tuff [45]; 4: diatomite [45]; 5: expanded clay [9]; 6: recycled bricks [9]; 7: no fines [9]; 8: expanded polystyrene [44]; 9: present experimental results.

structural efficiency is not suitable to be used to compare the performance of the lightweight aggregates concrete produced with different types of LWA. Further investigation is still needed here. Nevertheless, the obtained structural efficiencies of the current lightweight composites are compared with the lightweight concrete [46,47] produced also from the same type of LWA used in the present study. In [46], five different types of lightweight concretes were developed and the structural efficiencies range from 13,333 to 16,000 N m/kg; while in [47] also five different concretes were designed and the structural efficiencies range from 13,605 to 16,667 N m/kg. It can be clearly seen from Table 7 that the three lightweight composites developed here have higher structural efficiency, which could be possibly explained by the applied mix design methodology.

3.3. Thermal properties

Thermal behavior is a key factor in the development and application of lightweight concrete. Thermal behavior of lightweight aggregates concrete is related to its thermal conductivity and its density, which in turn is influenced by its pore structure, i.e. the air-void system, aggregates and the matrix [1]. Therefore the thermal conductivity is addressed in the present study as well.

Table 8
Thermal physical properties of the lightweight aggregates composites.

Mix	Density (kg/m ³)	Thermal conductivity (W/(m K))
SCLC1	1280	0.485
SCLC2	1490	0.738
VCLC	1460	0.847
Reference ^a	2300	1.700

^a Reference self-compacting concrete prepared with normal weight aggregates.

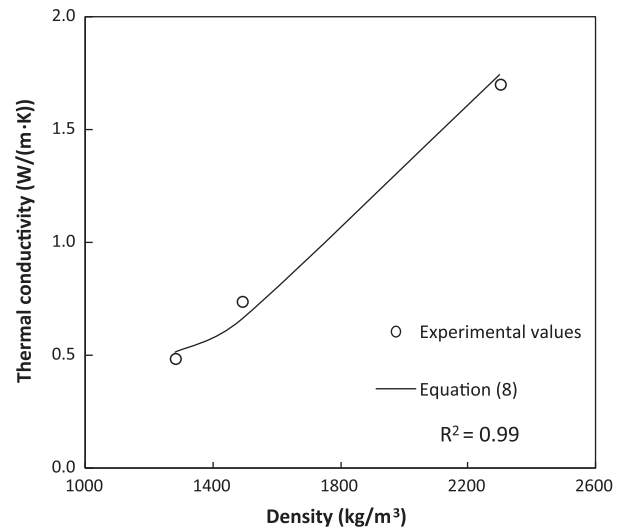

Fig. 11. The thermal conductivity versus density of the two SCLC ($a_0 = 0.11$ and $b_0 = 0.0012$).

The thermal conductivities of the three developed mixes are measured using a heat transfer analyzer (ISOMET Model 2104). A detailed description of the measurement methodology is presented in [48]. Here the samples are first dried in a ventilated oven at 105 °C until the mass becomes constant following the standard EN 12390-7:2009 [49], and then cooled down to room temperature for executing the thermal conductivity measurement. The average results are listed in Table 8.

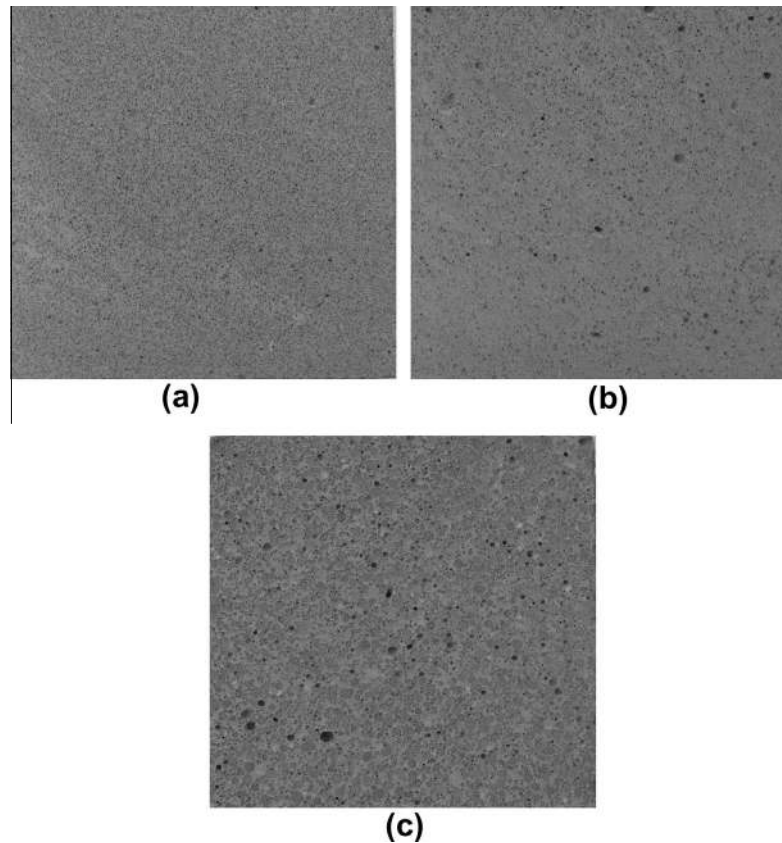

Fig. 12. Pictures of the cut surface of the three composites: (a) SCLC1; (b) SCLC2; (c) VCLC.

It can be seen that, with the increase of the density, the thermal conductivity of the two SCLC increases. ACI committee 213R-03 [3] and Topcu and Uygunoglu [45] reported that the relation between the thermal conductivity and density follows an exponential relationship, which reads as:

$$\lambda = a_0 \times e^{b_0 \times \rho} \quad (8)$$

where λ is the thermal conductivity (W/(m K)), ρ is the density (kg/m³), and a_0 and b_0 are parameters. ACI committee 213R-03 [3] proposed the values of 0.072 and 0.00125 for a_0 and b_0 respectively.

Using the experimental values from Table 8 for SCLC1, SCLC2 and reference self-compacting concrete, the values of a_0 and b_0 can be obtained employing the Solver function from Microsoft Excel®, yielding a_0 and b_0 of 0.11 and 0.0012 respectively, with the coefficient of determination (R^2) of 0.99. The results are shown in Fig. 11. It can be seen that the value of a_0 is larger than the recommended value from [3], but it is in line with the value reported by [45], who derived a_0 (0.1242) and b_0 (0.0011) also based on self-compacting lightweight concrete.

However, as already presented in [48], the thermal conductivity of a material is related not only to the porosity or density of the matrix, but also to the thermal conductivity and particle shape of all the materials in the matrix. Therefore, the proposed expression (Eq. (8)) can only be used to estimate the relation between the density and thermal conductivity, which is also in line with [1,4] who reported a significant influence of the LWA type on the thermal conductivity.

This is also confirmed by the thermal conductivity value of the VCLC, as listed in Table 8. With a density similar to SCLC2, the thermal conductivity of VCLC is 14.8% larger than that of SCLC2. This indicates that the Eq. (8) is not suitable to compare concretes/mortars of different types. The larger thermal conductivity of the VCLC can be explained by the used mix design. Although the total poros-

ities of SCLC2 and VCLC are comparable (See Table 5), it is obvious that the paste porosity of VCLC is much smaller, due to the low water/cement ratio used in the mix of VCLC (see Table 3). This results in a much faster transport route for heat. Despite the fact that the internal porosity of LWA in VCLC is larger than that of SCLC2, the LWA in SCLC2 are better distributed because they are smaller, which contributes finally to the lower heat transfer rate. This is confirmed by the pictures of cut surfaces of the three composites shown in Fig. 12, where it can be seen that the LWA are more densely distributed in the case of SCLC1.

3.4. Discussion

In the above sections, three mixes are developed and investigated. In order to study the effect of the density on strength and thermal conductivity, two self-compacting mixes (SCLC1 and SCLC2) and one vibrated mix (VCLC) are designed. Two mixes with self-compacting properties are designed applying different distribution moduli in order to study their influences.

The smaller distribution modulus applied in the design of mix SCLC2 compared to that in SCLC1 results in a smaller porosity (see Table 5) due to the larger amount of inert fines used in that mix (see Table 3). This smaller porosity should theoretically lead to a higher strength, which is confirmed by the experimental results, as shown in Fig. 7, and to a larger thermal conductivity which is also confirmed by the values listed in Table 7. Therefore, the selection of a suitable distribution modulus should be taken into consideration in order to obtain an optimal balance between the strength and thermal conductivity.

SCLC2 and VCLC, designed following different distribution moduli and using different materials, have comparable densities. Surprisingly, these two composites have quite different thermal conductivities, which is in conflict with the well accepted opinion,

i.e. the direct relation between the thermal conductivity and density (see Eq. (8)). However, this finding confirms the analysis presented in [48]. The difference in the measured thermal conductivity between these two mixes can actually be explained by the water-permeable porosity (see Table 6), i.e. the small permeable porosity of VCLC leads to a larger thermal conductivity, and also by the distribution of the lightweight aggregate particles in the matrix.

The LWA used is produced from the recycled glass. Therefore, the possibility of alkali–silica reactivity is taken into consideration because of the high content of amorphous SiO₂ in LWA (about 70% by mass). Ducman et al. [50] reported that although the expanded glass aggregates are reactive, they do not cause either expansion or crack in concrete. This is attributed to the very porous structure of the aggregates, which provides sufficient space for ASR products, which is also confirmed by [1]. Zhang and Gjorv [51] also reported that, although there is a certain degree of pozzolanic reaction between the cement paste and the LWA, which contain SiO₂, Al₂O₃, and Fe₂O₃ up to 85% in total, the effect is very small and can be neglected. However, the SEM experiments performed here (monitoring time up to 20 months after samples cast) indicate that there is no observed chemical reaction between the LWA and cement matrix. A more detailed analysis is presented in Part 2 of this study.

4. Conclusions

This article addresses the development of cement-based lightweight aggregates composites aiming at a good balance between a low thermal conductivity and good mechanical properties. The designed lightweight composites can be applied monolithically as concrete structure, as both structural load-bearing elements and thermal insulator. Based on the investigation presented above, the following conclusions are drawn:

- Applying the described design methodology, three lightweight aggregates composites are developed, with a good balance between the thermal properties and mechanical properties, can be used as both structural element and thermal insulation materials.
- The difference between the calculated total porosity and the measured water-permeable porosity indicate that the used LWA have a certain amount of closed internal pores, which contribute to a better thermal insulation of the developed composite.
- The final compressive strength of developed composites is strongly limited by the applied LWA. Although there is still hydration ongoing after 7 days, the compressive strength remains unchanged due to the weakness of the used LWA.
- The developed lightweight composites have similar structural efficiencies; and the analysis indicates that the structural efficiency is not suitable to be used to compare lightweight concrete produced with different types of lightweight aggregates.
- In the case of using the same type of LWA, the thermal conductivity of cement-based lightweight composite is linked directly with its density.
- The selection of finer LWA, which can be more homogeneously distributed in the matrix, leads to a lower thermal conductivity than selection of coarser LWA which are distributed more sparsely in the matrix.

Acknowledgements

The authors wish to express their gratitude the following sponsors of the Building Materials group at TU Eindhoven: Bouwdienst

Rijkswaterstaat, Graniet-Import Benelux, Kijlstra Betonmortel, Struyk Verwo, Attero, Enci, Provincie Overijssel, Rijkswaterstaat Directie Zeeland, A&G Maasvlakte, BTE, Alvon Bouwsystemen, V.d. Bosch Beton, Selor, Twee “R” Recycling, GMB, Schenk Concrete Consultancy, Geochem Research, Icopal, BN International, APP All Remove, Consensor, Eltomation, Knauf Gips, Hess AAC Systems, Kronos, and Joma International (chronological order of joining).

References

- [1] Chandra S, Berntsson L. *Lightweight aggregate concrete science, technology and applications*. Delhi, India: Standard Publishers Distributors; 2003.
- [2] EuroLightCon. *Light weight aggregates*. Document BE96-3942/R15, European Union – Brite EuRam III, 2000.
- [3] ACI Committee 213. *Guide for structural lightweight-aggregate, concrete*; 2003.
- [4] Loudon AG. The thermal properties of lightweight concretes. *Int J Lightweight Concrete* 1979;11(2):71–85.
- [5] Bomhard H. Lightweight concrete structures, potentialities, limits and realities. *Int J Lightweight Concr* 1980;2(4):193–209.
- [6] Al-Noury S, Mirza WH, Huq S. Density and strength characteristics of lightweight mortar. *Cem Concr Compos* 1990;12:79–86.
- [7] Zhang MH, Gjorv OE. Penetration of cement paste into lightweight aggregate. *Cem Concr Res* 1991;22:47–55.
- [8] Wasserman R, Bentur A. Interfacial interactions in lightweight aggregate concretes and their influence on the concrete strength. *Cem Concr Compos* 1996;18:67–76.
- [9] Alduaij J, Alshaleh K, Haque MN, Ellaithy K. Lightweight concrete in hot coastal areas. *Cem Concr Compos* 1999;21:453–8.
- [10] Demirboga R, Gul R. Thermal conductivity and compressive strength of expanded perlite aggregate concrete with mineral admixtures. *Energy Build* 2003;35:1155–9.
- [11] Choi YW, Kim YJ, Shin HC, Moon HY. An experimental research on the fluidity and mechanical properties of high-strength lightweight self-compacting concrete. *Cem Concr Res* 2006;36:1595–602.
- [12] Ünal O, Uygunoglu T, Yildiz A. Investigation of properties of low-strength lightweight concrete for thermal insulation. *Build Environ* 2007;42:584–90.
- [13] Liu X, Chia KS, Zhang MH. Development of lightweight concrete with high resistance to water and chloride-ion penetration. *Cem Concr Compos* 2010;32:757–66.
- [14] Chia KS, Zhang M-H. Water permeability and chloride penetrability of high-strength lightweight aggregate concrete. *Cem Concr Res* 2002;32:639–45.
- [15] Nyame BK. Permeability of normal and lightweight mortars. *Mag Concr Res* 1985;37(130):44–8.
- [16] Bentz DP. Influence of internal curing using lightweight aggregates on interfacial transition zone percolation and chloride ingress in mortars. *Cem Concr Compos* 2009;31:285–9.
- [17] Liu X, Chia KS, Zhang M-H. Water absorption, permeability, and resistance to chloride-ion penetration of lightweight aggregate concrete. *Const Build Mater* 2011;25:335–43.
- [18] Spiesz P, Yu QL, Brouwers HJH. Development of cement-based lightweight composites – Part 2: durability related properties. *Cem Concr Comp*, submitted for publication.
- [19] El Zareef MAM. *Conceptual and structural design of buildings made of lightweight and infra-lightweight concrete*. PhD Thesis, Berlin, Germany: Technical University Berlin; 2010.
- [20] Neville AM. *Properties of concrete*. 4th ed. Essex, England: Pearson Educational Limited; 2002.
- [21] EuroLightCon. *LWAC material properties state-of-the-art*. Document BE96-3942/R2, European Union – Brite EuRam III, 1998.
- [22] Zhang MH, Gjorv OE. Mechanical properties of high-strength lightweight concrete. *ACI Mater J*. 1991;240–7. May–June.
- [23] Yu QL. *Design of environmental friendly calcium sulfate based building materials – towards an improved indoor air quality*. PhD Thesis, Eindhoven, The Netherlands: Eindhoven University of Technology; 2012.
- [24] EuroLightCon. *LWAC material properties state-of-the-art*. In: *Economic design and construction with light weight aggregate concrete*. Brite-EuRam III. 1998.
- [25] Brouwers HJH, Radix HJ. Self-compacting concrete: theoretical and experimental study. *Cem Concr Res* 2005;35:2116–36.
- [26] Hüskes G. *A multifunctional design approach for sustainable concrete with application to concrete mass products*. PhD Thesis. Eindhoven, The Netherlands: Eindhoven University of Technology; 2010.
- [27] Hüskes G, Brouwers HJH. A new mix design concept for earth-moist concrete: a theoretical and experimental study. *Cem Concr Res* 2008;38:1246–59.
- [28] Yu QL, Brouwers HJH. Development of a self-compacting gypsum-based lightweight composite. *Cem Concr Compos* 2011;34:1033–43.
- [29] Lydon FD. *Concrete mix design*. 2nd ed. London, UK: Applied Science Publishers; 1982.
- [30] EFNARC. *The European guidelines for self-compacting concrete. Specification, production and use*. EFNARC; May, 2005.
- [31] Hunger M. *An integral design concept for ecological self-compacting concrete*. PhD thesis. Eindhoven, The Netherlands: Eindhoven University of Technology; 2010.

- [32] Villar J, Baret JF. Cementing slurry and method of designing a formulation. United States Patent 6153562; 1997.
- [33] Tregger N, Ferrara L, Shah SP. Identifying viscosity of cement paste from mini-slump-flow test. *ACI Mater J* 2008;558–66.
- [34] Walraven JC, Takada K, Pelova GI. Zelfverdichtend beton, hoe maak je dat? *Cement* 1999;3:68–72 [in Dutch].
- [35] Ankone SFA. Zelfverdichtend beton. Training period report. The Netherlands: University of Twente; 2000 [in Dutch].
- [36] BFBN. Cursushandboek Zelfverdichtend Beton, Bond van Fabrikanten van Betonproducten in Nederland (BFBN), Woerden, The Netherlands; 2001 [in Dutch].
- [37] EFNARC. Specification and guidelines for self-compacting concrete. EFNARC; 2002.
- [38] Brouwers HJH. The work of Powers and Brownard revisited: Part I. *Cem Concr Res* 2004;34:1697–716.
- [39] Brouwers HJH. A hydration model of Portland cement using the work of powers and Brownard. Portland Cement Association; 2011; <http://www.cement.org>.
- [40] Hunger M. ENCI B.V., Personal communication; 2012.
- [41] Safiuddin Md, Hearn N. Comparison of ASTM saturation techniques for measuring the permeable porosity of concrete. *Cem Concr Res* 2005;35:1008–13.
- [42] NT Build 492. Concrete, mortar and cement-based repair materials: chloride migration coefficient from non-steady-state migration experiments. Nord test method. Finland; 1999.
- [43] ASTM C1202. Standard Test Method for electrical indication of concrete's ability to resist chloride ion penetration. In: annual book of ASTM Standards. vol. 04.02. American Society for Testing and Materials, Philadelphia; July 2005.
- [44] Kan A, Demirboga R. A novel material for lightweight concrete production. *Cem Concr Compos* 2009;31:489–95.
- [45] Topcu IB, Uygunoglu T. Effect of aggregate type on properties of hardened self-consolidating lightweight concrete (SCLC). *Const Build Mater* 2010;24:1286–95.
- [46] <http://www.eco-serve.net/seminar/Hammer.pdf>
- [47] http://www.liapor.mk/Files/Liapor%20News%202009-Extra_LB%20eng.pdf
- [48] Yu QL, Brouwers HJH. Thermal properties and microstructure of gypsum board and its dehydration products: a theoretical and experimental investigation. *Fire Mater* 2012;27:293–304.
- [49] EN 12390-7:2009. Testing hardened concrete Part 7: density of hardened concrete. CEN; 2009.
- [50] Ducman V, Mladenovic A, Suput JS. Lightweight aggregate based on waste glass and its alkali-silica reactivity. *Cem Concr Res* 2002;32:223–6.
- [51] Zhang MH, Gjorv OE. Pozzolanic reactivity of lightweight aggregates. *Cem Concr Res* 1990;20:884–90.