



Discuss the Impairments of SC-FDMA System

Amal F*, Abd El-Samie FE, Salah k, Sameh N

Electronics and Communications Department, Faculty of Engineering, Tanta University, Egypt

Abstract: The Single-Carrier Frequency Division Multiple Access (SC-FDMA) system is a popular system in mobile communication systems because of its advantage of low Peak-to-Average-Power- Ratio (PAPR), and the use of frequency-domain equalizers techniques to reduce Inter-Symbol Interference (ISI) and Inter-Carrier Interference (ICI). This paper presents a comprehensive study of the SC-FDMA system with PAPR reduction using clipping and filtering in the presence of channel estimation errors for two different versions of SC-FDMA adopting the FFT and the DCT. The effect of peak power reduction and the channel estimation error on the system Bit Error Rate (BER) is investigated. Simulation results have proved that the BER performance is not much affected by the PAPR reduction.

Keywords: SC-FDMA; DFT-SC-FDMA; DCT-SC-FDMA

I. INTRODUCTION

In the earlier part of this century, some people wanted to emulate with each other. So, scientists discovered a telephone to enable them to communicate over large distances at a reasonable cost for the very first time. Thus, the demand for high-data-rate transmissions over bandwidth and power limited wireless channels was increased. So, researchers thought of a multicarrier technique named Orthogonal Frequency Division Multiplexing (OFDM) [1], which is commonly used for transmission of signals over the wireless channels [2]. This technique divides the available spectrum into a number of orthogonal sub-channels, each one being modulated by a low-rate data stream. This system avoids Inter-Symbol Interference (ISI) and Inter-Carrier Interference (ICI), but its disadvantage is that it has a large Peak-to-Average Power Ratio (PAPR), and we can think in reducing this issue by using Single-Carrier Frequency Division Multiple Access (SC-FDMA).

The Single-Carrier Frequency Division Multiple Access (SC-FDMA) is one of the Long Term Evaluation (LTE) standards for the uplink. For this reason, it is used to permit the utilization of an efficient power amplifier in order to save battery life [3]. Moreover, LTE expands the spectrum utilized to 20 MHz and increases system capacity. The single carrier nature of SC-FDMA produces low PAPR [4], increases the data rate and reduces the Bit Error Rate (BER) leading to an increase in Signal-to-Noise Ratio (SNR).

It is proved that in [5,6] that the large PAPR can push the Power Amplifiers (PAs) at the transmitter into saturation. So, interference will occur between the subcarriers which affects the BER performance and the spectrum of the signal deteriorates. Minimizing the average power of the signal might lead the PA to enter saturation. Therefore, this solution minimizes the SNR, and so the BER performance may deteriorate [5].

One of the best solutions to the PAPR problem is to utilize a transmit Power Amplifier (PA) with large enough linearity range and suitable back-off operating point. Several other schemes of PAPR reduction can be categorized into three major classes [7]; signal distortion mechanisms, multiple signaling and probabilistic mechanisms; and coding mechanisms. In this paper, we extend the application of the clipping and filtering technique to the SC-FDMA system for PAPR reduction. We investigate the effect of channel equalization in the presence of channel estimation error and PAPR reduction to develop an integrated framework for the operation of the SC-FDMA system in a real scenario.

II. SC-FDMA SYSTEM

The Third Group Project Partnership (3GPP) LTE is a driving force in the mobile communication industry. For high-data-rate wireless communications, multiuser (MU) transmission can be achieved through Orthogonal Frequency Division Multiple Access (OFDMA) and/or SC-FDMA. OFDMA has been chosen on the LTE downlink because of the spectral efficiency and robustness that it offers in the presence of multipath propagation [8]. This immunity is a direct result of the narrowband transmissions that occur on each of the orthogonal subcarriers [9]. The block diagram of the SC-FDMA system is illustrated in Figure 1.

International Journal of Advanced Research in Electrical, Electronics and Instrumentation Engineering

(An ISO 3297: 2007 Certified Organization)

Vol. 7, Issue 3, March 2017

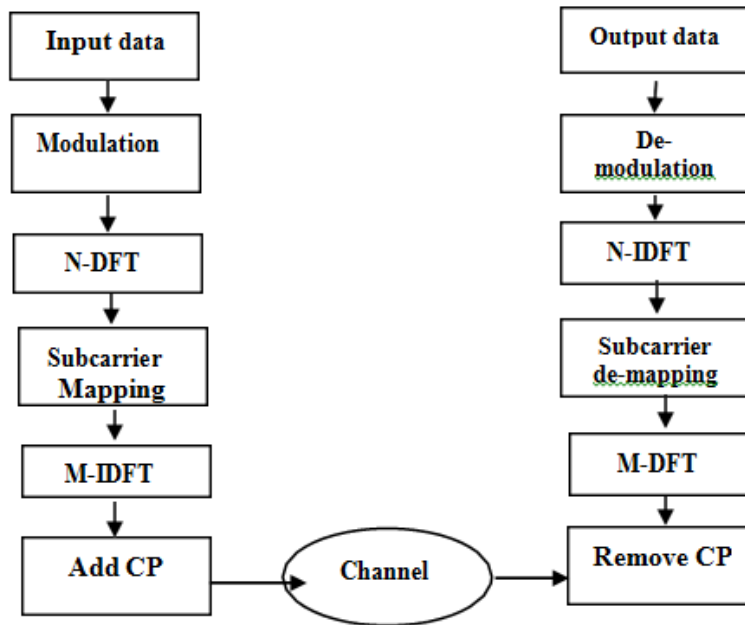

Figure 1: Simplified block diagram of the LTE SC wireless.

The SC-FDMA has a Discrete Fourier Transform (DFT) module and an Inverse Discrete Fourier Transform (IDFT) module, respectively in its transmitter and receiving ends. Signals are modulated and encoded, thereafter converted into multipath parallel signals through a serial to parallel transformation. Subcarriers mapping is applied after N points DFT. Multipath signals become a serial signal after parallel-to-serial transformation and M points IDFT, then Cyclic Prefix (CP) is added to the signal. Finally, the signal is transmitted over the wireless channel after Digital-to-Analogue Conversion (DAC) and Radio Frequency (RF). The receiving end has an opposite process. Figure 2 shows the SC-FDMA system with normal CP. The time-domain frame structure of SC-FDMA has a 10 ms length and it is equally divided into 20 time slots, each slot is 0.5ms, and it has 7 SC-FDMA symbols, while each slot has 12 sub-carriers, and each subcarrier bandwidth is 15 kHz in frequency domain [10].

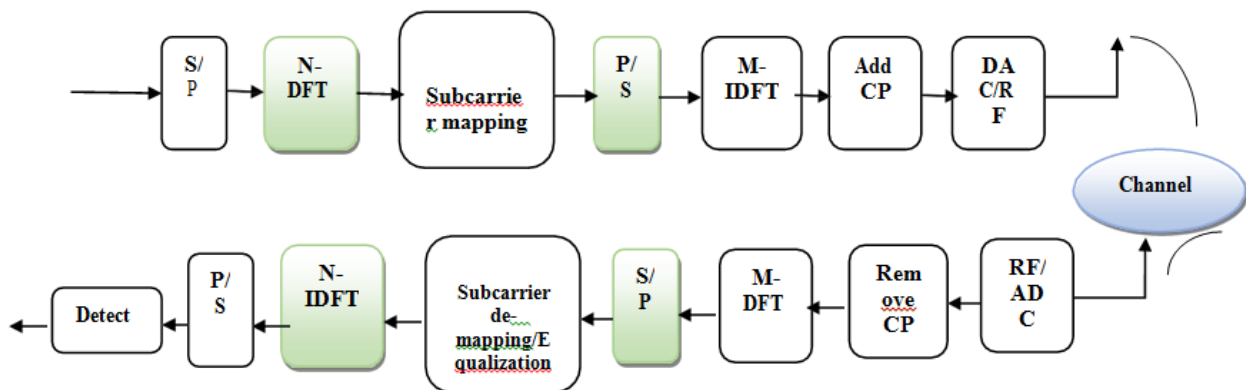

Figure 2: SC-FDMA transmit-receive system.

International Journal of Advanced Research in Electrical, Electronics and Instrumentation Engineering

(An ISO 3297: 2007 Certified Organization)

Vol. 7, Issue 3, March 2017

III. FAST FOURIER TRANSFORM BASED SC-FDMA

The FFT is a building block of the SC-FDMA system. It is expressed as follows:

$$X_k = \sum_{m=0}^{M-1} x_m e^{-\frac{j2\pi}{M}mk} \quad (1)$$

where M is the FFT length. After Inverse Fast Fourier Transform (IFFT), the signal can be expressed as follows (Figure 3):

$$y_n = \frac{1}{N} \sum_{l=0}^{N-1} x_l e^{\frac{j2\pi}{N}nl} \quad (2)$$

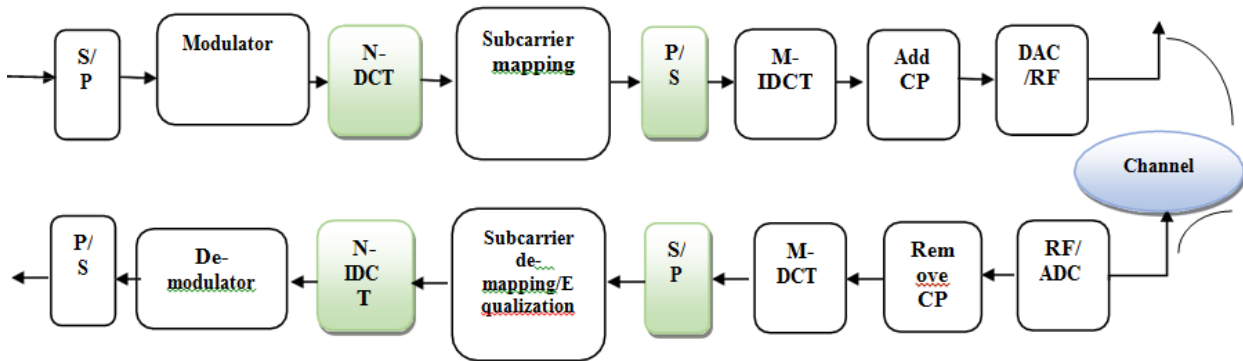

Figure 3: block diagram of the DFT-SC-FDMA system.

3.1. AT Transmitter

At the transmitter, the data is modulated through the modulator and then DFT is applied. The sub-carrier mapping has two methods localized and distributed mapping methods. The localized mapping method is usually used in LTE. Each user's data is transmitted with consecutive subcarriers, while in the distributed mapping method transmission; the user's data is transmitted with distributed subcarriers [11]. Then, the IFFT is applied on the output of mapping. After that, cyclic prefix is added to each symbol to prevent ISI and ICI. At the end of transmission, the data is converted from parallel to serial and converted from digital to analog to be suitable for RF radio transmission.

At the receiver, we make the inverse operation when receiving the RF radio signal. We convert it from analog to digital and from serial to parallel conversion, and then remove the cyclic prefix. After that, we apply on each symbol the subcarrier de-mapping. As well as, we apply equalization on the data to compensate for the loss that occurs on the channel. Finally, we apply IDFT and demodulator on the data to produce the original signal.

IV. DISCRETE COSINE TRANSFORM BASED SC-FDMA (DCT-SC-FDMA)

The Discrete Cosine Transform (DCT) is a real-valued transform as it uses real arithmetic operations [11]. Then the DCT transform for a sampled signal $x(\alpha)$, can be written as:

$$X(k) = \sqrt{\frac{2}{N}} \beta(k) \sum_{\alpha=0}^{N-1} X(\alpha) \cos\left(\frac{\pi k(2\alpha+1)}{2N}\right), k = 0, \dots, N-1 \quad (3)$$

$\beta(k)$ can be expressed as follows [9,8]:

$$\beta(k) = \begin{cases} 1^{0.707} & \text{at } k \in \{0, 1, 2, \dots, N-1\}^{at k=0} \end{cases}$$

International Journal of Advanced Research in Electrical, Electronics and Instrumentation Engineering

(An ISO 3297: 2007 Certified Organization)

Vol. 7, Issue 3, March 2017

The discrete time signal can be reconstruction via the Inverse Discrete Cosine Transform (IDCT) using the following relation [12,13]:

$$X(\alpha) = \sqrt{\frac{2}{N}} \beta(k) \sum_{\alpha=0}^{N-1} X(k) \cos(\pi k(2\alpha+1)/2N), \alpha = 0, \dots, N-1 \quad (4)$$

The DCT can be used instead of the FFT to facilitate the operation based on real arithmetic. Figure 4 introduces a system employing the DCT-SC-FDMA for multi-user communication with a central connection by different multipath fading channels. At the transmitter side, the modulated symbols are combined into blocks, each including N symbols, and an N-point DCT is performed. Then, the subcarriers are mapped. After that, the M-point IDCT is performed. At the receiver, frequency-domain equalization is applied [14-17].

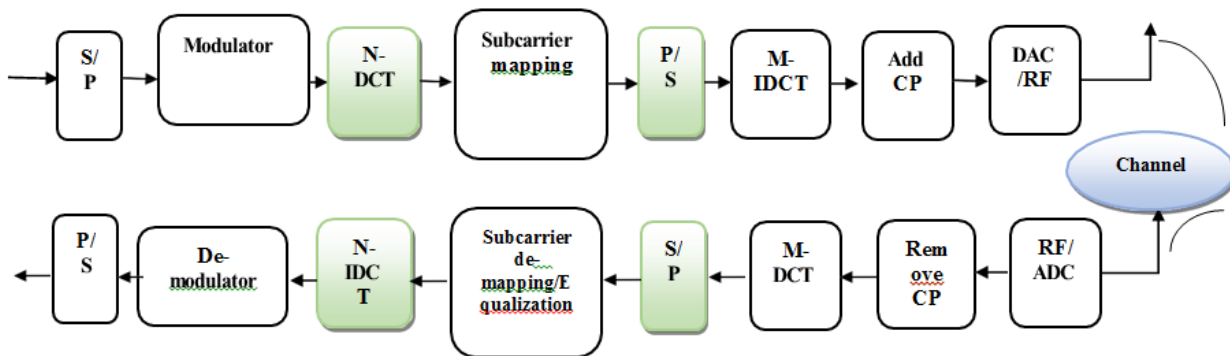

Figure 4: Structure of DCT-SC-FDMA system over a frequency-selective channel.

V. CHANNEL ESTIMATION ANDEQUALIZATION

This is the physical medium (free space, fiber, waveguides etc.) between the transmitter and the receiver through which the signal propagates [18]. So, we use equalization at the receiver to estimate the channel impulse response and explain the behavior of the channel. The channel behavior is well-used in modern radio communications. As a result, some algorithms are used to measure the behavior of the channel such as Minimum Mean Square Error (MMSE) estimator and Zero Forcing (ZF) estimator as shown in Figure 5.

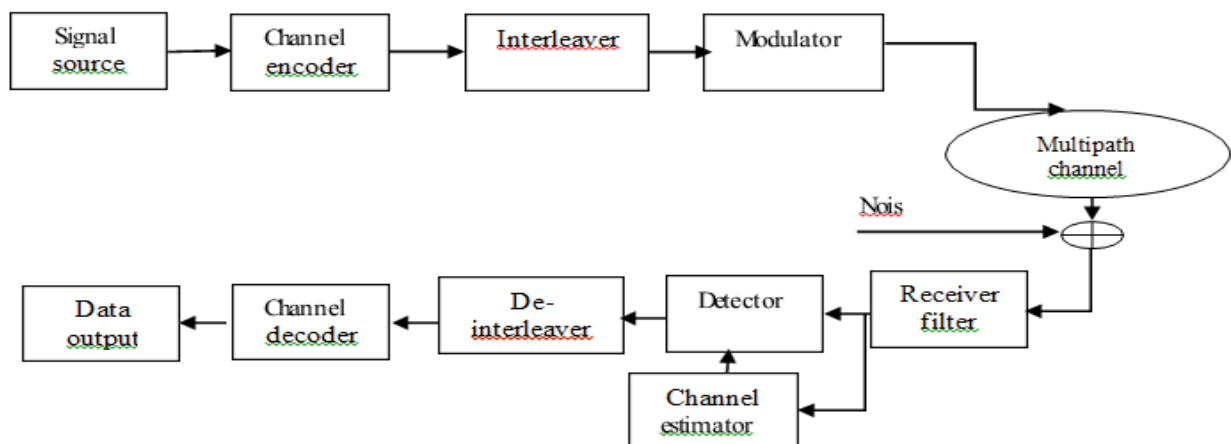

Figure 5: Block diagram for a system utilizing channel estimator and detection.

The minimum mean square error (MMSE) estimator employs the second order statistics of the channel conditions to minimize the mean-square error. The estimation based on the MMSE gauge is used to enhance accuracy with the information of channel estimation. The algorithm can be written in frequency domain as follows [19]:



International Journal of Advanced Research in Electrical, Electronics and Instrumentation Engineering

(An ISO 3297: 2007 Certified Organization)

Vol. 7, Issue 3, March 2017

$$h_{mmse} = R_{HH} R_{yy}^{-1} Y. \quad (5)$$

$$\text{Where } R_{Hy} = R_{HH} x^H \quad (6)$$

$$R_{yy} = x R_{HH} X^H + \sigma_e^2 I_G \quad (7)$$

σ_e^2 is the variance of additive white Gaussian noise, $R_{HH} = E H H^H$ is the autocorrelation matrix about channel response.

As a result, the frequency domain MMSE estimator can be written as:

$$h_{mmse} = R_{HH} \left(R_{HH} + \sigma_e^2 (x X^H)^{-1} \right)^{-1} h_{is}.$$

Zero-forcing (ZF) detection is the simplest signal detection technique that is used to extract the transmitted signal. The disadvantage of this technique is that it doesn't make correlation of the transmitter and the receiver, thus the highest error occurs. It cannot totally remove the inter-symbol interference. ZF is less complex compared to the other mechanisms [20]. The mean square error between equalized signal and the main sign will be eliminated by using equalizer coefficients $E(z)$ (Figure 6) [21].

The zero forcing (ZF) detection is

$$E(z) = 1/H(z), \quad z=0,1,2,\dots,N-1 \quad (9)$$

where $H(z)$ is the transfer function of the channel.

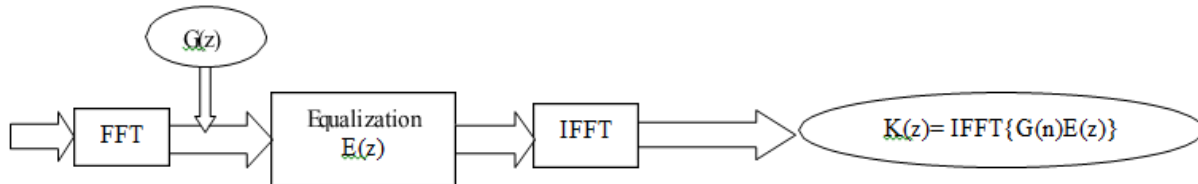

Figure 6: The process of channel equalization.

The equalizer is the inverse of the channel impulse response, linearly, because the channel characteristics may be unknown or variable with time. So, the aim of the equalizer is to reduce inter-symbol interference (ISI) to permit restoration of the transmit signs [22]. Moreover, the best equalizer structure is to be adaptive in nature. Classical equalization techniques employ a pre-assigned time slot (periodic for the time varying situation) where a training signal, known in anticipation by the recipient, is transmitted [23]. Zero forcing is a step-wise equalizer algorithm used in communication systems which applies the inverse of the channel frequency response to the received signal to restore the signal after the channel [24].

The aim of zero forcing is to damage inter symbol interference to zero in a noise free case, and we can express ZF in the following equation:

$$c(z) = \frac{1}{F(z)} \quad (10)$$

Where $C(z)$ is a zero forcing equalizer, $F(z)$ is a channel with frequency response (Figure 7).

International Journal of Advanced Research in Electrical, Electronics and Instrumentation Engineering

(An ISO 3297: 2007 Certified Organization)

Vol. 7, Issue 3, March 2017

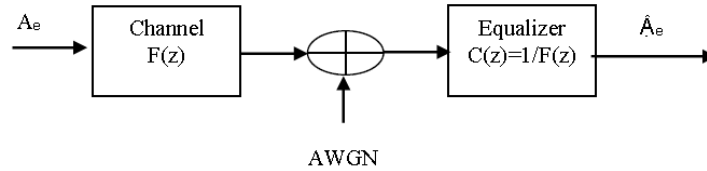

Figure 7: Zero Forcing Equalizer.

The minimum mean squared error (MMSE) equalizer is used to reduce ISI and additive noise effects. Once the SNR has increased values, the MMSE equalizer works as the Zero Forcing does, but when the SNR has lower values, the noise is enhanced [18].

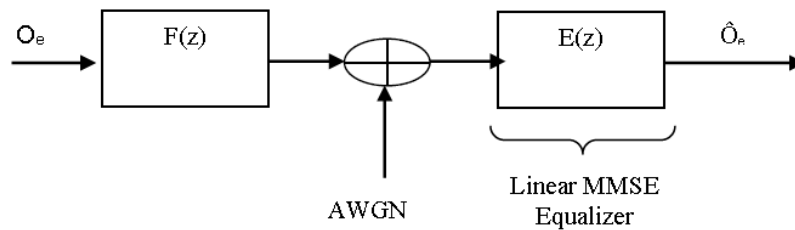

Figure 8: MMSE equalizer.

The variance between the two techniques in the case of deep null appears in the frequency response of the channel. The MMSE equalizer does not amplify the received signal just multiplying for the inverse of the channel (Figure 8).

VI. CLIPPING AND FILTERING

Clipping and filtering is an efficient PAPR reduction technique. The clipped signal is given by [23],

$$y[n] = \begin{cases} -CL, & \text{if } x[n] < -CL \\ x[n], & \text{if } -CL \leq x[n] \leq CL \\ CL, & \text{if } x[n] > CL \end{cases} \quad (11)$$

where $x[n]$ is the original signal, and CL is the clipping level.

We consider the clipping process as a source of noise because it is a nonlinear process. As a result, the distortion occurs in-band and out-of-band [24]. First, in-band distortion can break down the BER performance and cannot be reduced by filtering. Nevertheless, oversampling by taking for a longer time IFFT can reduce the in-band distortion effect as a portion of the noise is reshaped outside the signal band that can be rejected later by filtering [23]. Second, the out-of-band distortion causes spectral spreading that beats on to enhance BER rate performance by using filtering on the clipped signal.

6.1. The proposed SC-FDMA system

International Journal of Advanced Research in Electrical, Electronics and Instrumentation Engineering

(An ISO 3297: 2007 Certified Organization)

Vol. 7, Issue 3, March 2017

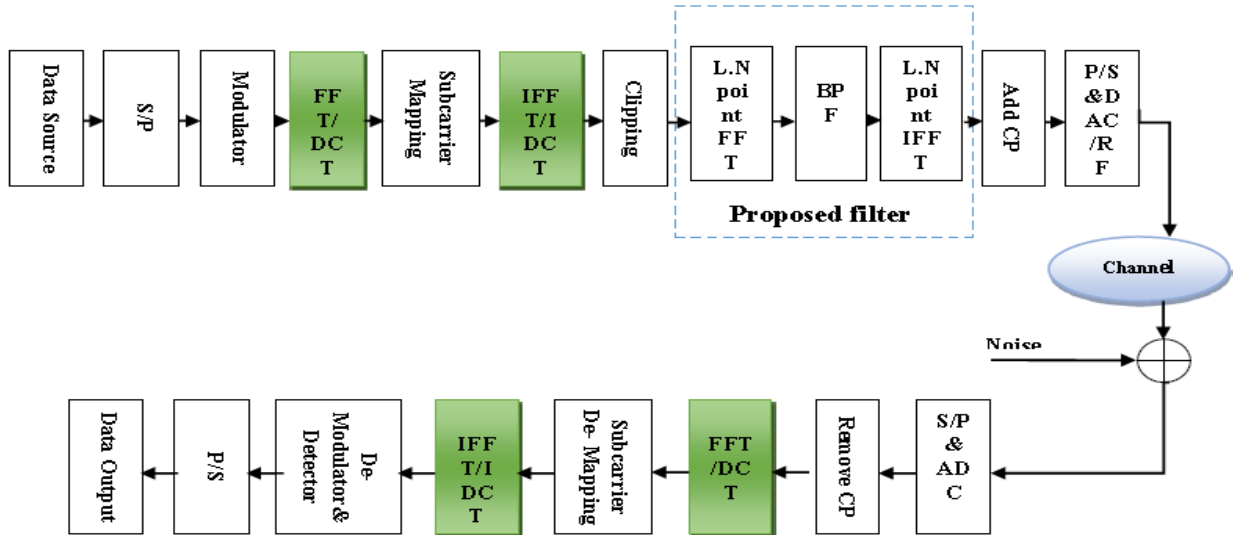
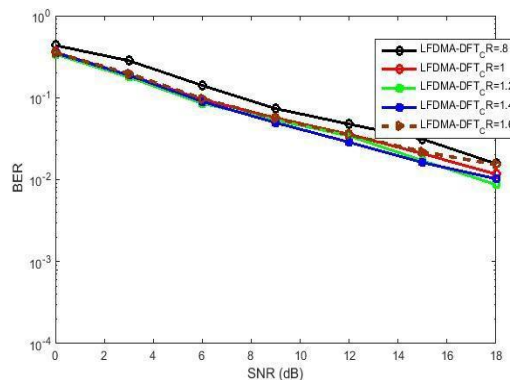

Figure 9: The proposed SC-FDMA with Clipping and filtering system.

The main objective in this paper is to enhance the SC-FDMA system performance by applying PAPR reduction simultaneously with channel equalization in the presence of channel estimation error (Figure 9).

6.2. Simulation Results

Simulation experiments have been carried to test the suggested framework for SC-FDMA system implemented with both FFT and DCT. The BER is used as the evaluation metric after PAPR reduction and channel estimation and equalization. The Vehicular A, Uniform, and SU13 channel models have been considered. QPSK modulation, FFT or DCT size of $N=512$, and code rate=0.5 have been adopted. Simulation results are illustrated in Figures 10-15. Simulation results reveal that although the PAPR reduction is achieved with the clipping and filtering method, we can maintain an acceptable BER performance through the utilization of channel estimation and efficient implementation of frequency domain equalization (Tables 1-6).



(a)

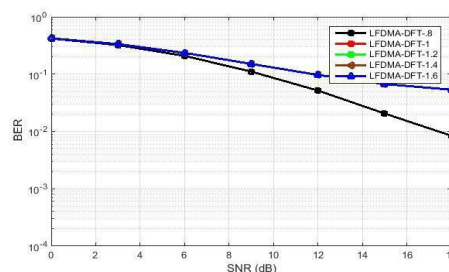

International Journal of Advanced Research in Electrical, Electronics and Instrumentation Engineering

(An ISO 3297: 2007 Certified Organization)

Vol. 7, Issue 3, March 2017

(b)

Figure 10: FFT results with Vech A channel (a) Clipping and filtering (b) Clipping only.

CR value	BER value (previous)	BER value (proposed)	Percentage enhancement
0.8	0.2085	0.141	32.4%
1	0.235	0.0951	59.5%
1.2	0.235	0.085	63.8%
1.4	0.235	0.0896	61.9%
1.6	0.235	0.0977	58.4%

Table 1: The measured BER values at SNR=6dB.

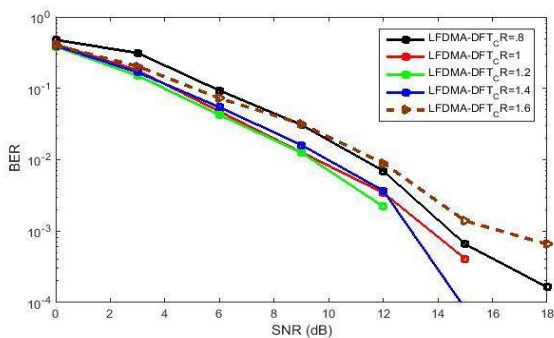

(a)

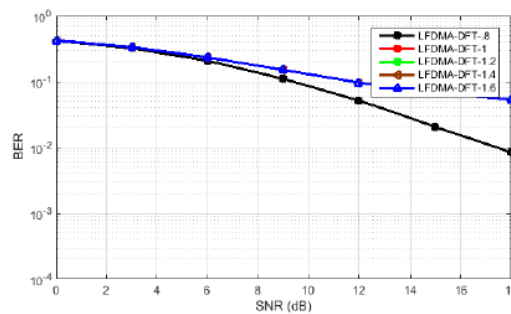

(b).

Figure 11: FFT results with uniform channel, a) Clipping and filtering b) Clipping only.

CR value	BER value (previous)	BER value (proposed)	Percentage enhancement
0.8	0.155	0.0930	40%
1	0.1888	0.0474	74.9%
1.2	0.1888	0.0424	77.5%
1.4	0.1888	0.0545	71.1%
1.6	0.1888	0.0725	61.6%

Table 2: The measured BER value at SNR=6dB.

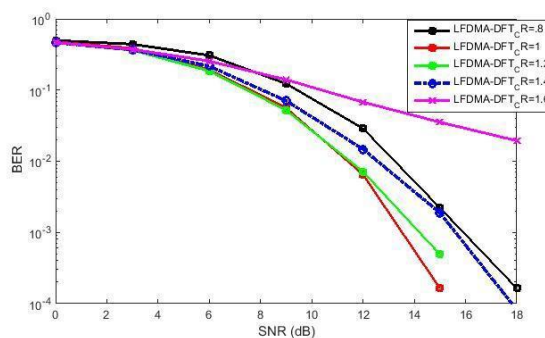

(a)

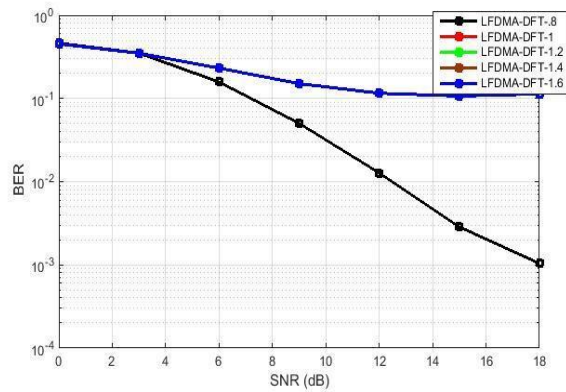

(b)

Figure 12: FFT results with SUI3 channel (a) Clipping and filtering (b) Clipping only.

CR value	BER value (previous)	BER value (proposed)	Percentage enhancement
0.8	0.1578	0.3066	-94.3%
1	0.2315	0.1923	16.9%
1.2	0.2315	0.1854	27.7%
1.4	0.2315	0.2166	6.4%
1.6	0.2315	0.2548	-10.1%

Table 3: The measured BER value at SNR=6dB.

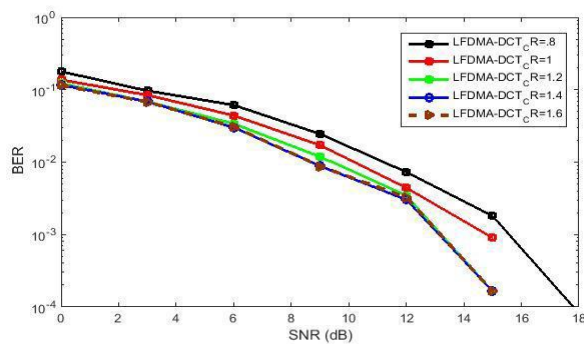

(a)

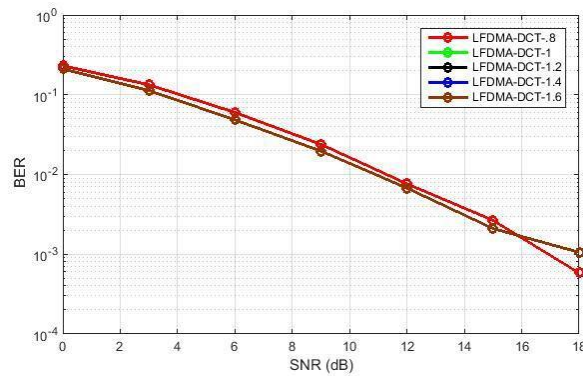

(b)

Figure 13: DCT results with Vech A channel (a) Clipping and filtering (b) Clipping only.

CR value	BER value (previous)	BER value (proposed)	Percentage enhancement
0.8	0.0599	0.06139	-9.2%
1	0.0484	0.0440	9.1%
1.2	0.0484	0.0339	29.96%
1.4	0.0484	0.0301	37.8%
1.6	0.0484	0.0307	36.6%

Table 4: The measured BER value at SNR=6dB.

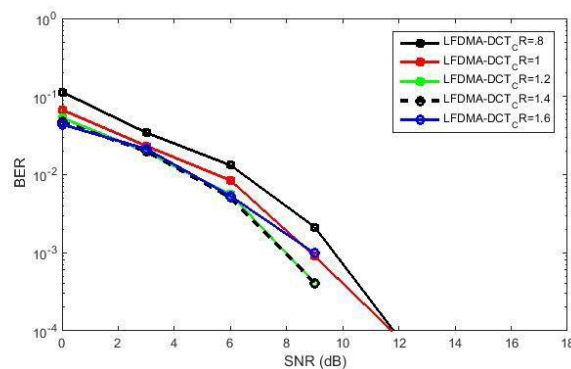

(a)

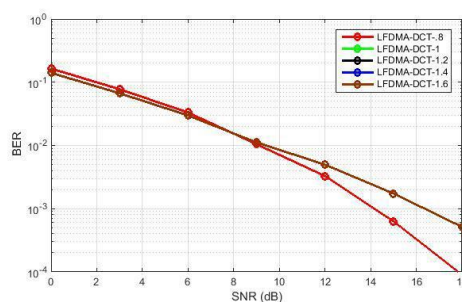

(b)

Figure 14: DCT results with Uniform channel (a) Clipping and filtering (b) Clipping only.

CR value	BER value (previous)	BER value (proposed)	Percentage enhancement
----------	----------------------	----------------------	------------------------



International Journal of Advanced Research in Electrical, Electronics and Instrumentation Engineering

(An ISO 3297: 2007 Certified Organization)

Vol. 7, Issue 3, March 2017

0.8	0.0332	0.0132	60.2%
1	0.0298	0.00844	71.7%
1.2	0.0298	0.00557	81.3%
1.4	0.0298	0.00508	82.95%
1.6	0.0298	0.00533	82.1%

Table 5: The measured BER value at SNR=6dB.

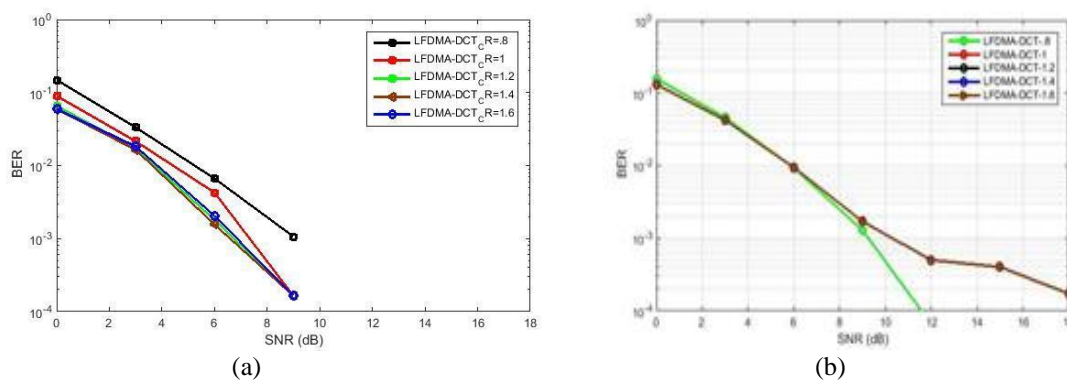

Figure 15: DCT results with SUI3 channel (a) Clipping and filtering (b) Clipping only.

CR value	BER value (previous)	BER value (proposed)	Percentage enhancement
0.8	0.0093	0.00664	28.6%
1	0.00946	0.00426	54.97%
1.2	0.00946	0.00180	80.97%
1.4	0.00946	0.00156	83.5%
1.6	0.00946	0.00205	78.3%

Table 6: The measured BER value at SNR=6dB.

VII. CONCLUSION

This paper presented a unified framework for SC-FDMA based on PAPR reduction and channel estimation and equalization. We have investigated the power reduction in SC-FDMA system and its effect of the system BER performance. We have investigated two different versions of OFDM with channel estimation and equalization. Simulation results have revealed that through clipping and filtering, we can maintain a good BER performance in the SC-FDMA scenario by applying a reliable channel estimation and equalization approach.

REFERENCES

1. Li-Wen Hsu, Dah-Chung Chang, 2*2 STBC MIMO OFDM Receiver design for WLAN with estimation of different transmits carrier frequency offsets. Int. J. Elec & Electr.Eng&Telecoms 2014; 3.
2. Sonia R, Manish K, Aurvey on channel estimation in MIMO-OFDM systems, international Journal of engineering and computer science 2015; 3.
3. Murtadha Ali N, Kuldip P, et al. Implementing SC-FDMA and OFDMA in matlab, International Journal of Computing and Corporate Research 2013; 3.
4. Saraswathi M, Babu SPK, A Novel Investigation on BER Measurement of SC-FDMA System with Combined Tomlinson-Harashima Precoding and Reed Solomon Coding', Indian Journal of science and technology 2015; 8.
5. Mamta B, Alok J, various techniques to reduce PAPR in OFDM systems: A survey, International Journal of Signal Processing, image Processing and Pattern Recognition, 2015; 8.
6. Munjure M, Yeakub A, et al. performance comparison of two clipping based filtering methods for PAPR reduction in OFDM signal, International Journal of Mobile Network Communications and Telematics 2014; 4.



ISSN (Print) : 2320 – 3765
ISSN (Online): 2278 – 8875

International Journal of Advanced Research in Electrical, Electronics and Instrumentation Engineering

(An ISO 3297: 2007 Certified Organization)

Vol. 7, Issue 3, March 2017

7. Rahmatallah Y, Mohan S, Peak-to-Average Power Ratio Reduction in OFDM System: A Survey and Taxonomy, IEEE Communication Surveys and Tutorials 2013; 15: 1567-1592.
8. Van Nee R, Prasad R, OFDM for Wireless Multimedia Communications, Artech House 2000.
9. Falconer D, Ariyavisitakul SL, et al. Frequency Domain Equalization for Single-Carrier Broadband Wireless Systems, IEEE Commun. Mag 2002; 40: 58-66.
10. Jianbin X, Songbai L, An SC-FDMA Channel Estimation Algorithm Research Based on Pilot Signals, Atlantis Press, Paris, France 2013.
11. Fathi EA, Faisal Al SK, et al. SC- FDMA mobile communications. Boca Roton London New York 2010.
12. Zhu X, Murch RD (2002) Novel frequency domain equalization Architectures for a single-carrier wireless MIMO system, in Proc. IEEE VTC 2002; 874-878.
13. Oppenheim AV, Schafer RW (1999) Discrete-Time Signal Processing, 2nd ed., Prentice Hall, Upper Saddle River, NJ 1999.
14. Rupul S, A Multipath Channel Estimation Algorithm using a Kalman filter, Department of Electrical Engineering and Computer Science 1997.
15. Neetha L, Vijay Kumar NVSV, Channel Estimation and Carrier Frequency Offset Estimation for Multiuser Uplink for OFDM System", International Journal of Engineering Research & Technology (IJERT) 2014; 3.
16. Edward K, Roman M, The Performance of LTE Advanced Uplink in Flat Rayleigh and Pedestrian Channels, elektrovrevue ISSN 1213-1539, VOL.4, NO.3, DECEMBER 2013. Raad Farhood Chisab, Member IEEE and Prof. (Dr.) C. K. Shukla"
17. Performance Evaluation of 4G-LTE-SCFDMA Scheme under SUI and ITU Channel Models. International Journal of Engineering & Technology IJET-IJENS 2014; 14.
18. Proakis J, Digital Communications. Chapter 11, 4th Edition, 2000.
19. Ferran CV, Antonio Macilio Pereira DL, Implementation Of Zero Forcing And Mmse Equalization Techniques In of dm, Fortaleza, Brasil, December 2104
20. Jon M, Weihua Z, Ch.4 , Wireless Communications and Networking. Prentice Hall 2003; 139.
21. Shilpa B, Sudhirkumar D, PAPR Reduction in OFDM system using clipping and filtering method. International Journal of Advanced Research in computer science and software Engineering 2015; 5.
22. J. Heiskala and J. Terry, OFDM Wireless LANs: A Theoretical and Practical Guide. Sams Publishing, 2002.
23. Rahmatallah Y, Seshadri M, Peak-To-Average Power Ratio Reduction in OFDM Systems: A Survey and Taxonomy. IEEE Communications surveys & tutorials 2013; 15.
24. Ochiai H, Imai H, On the clipping for peak power reduction of OFDM signals. in Proc. IEEE Global Communications Conference (GLOBECOM), San Francisco, USA, 2000; 731–735.