

Display of Bacterial Lipase on the *Escherichia coli* Cell Surface by Using FadL as an Anchoring Motif and Use of the Enzyme in Enantioselective Biocatalysis

Seung Hwan Lee,¹ Jong-Il Choi,¹ Si Jae Park,^{1†} Sang Yup Lee,^{1,2*} and Byoung Chul Park³

Metabolic and Biomolecular Engineering National Research Laboratory, Department of Chemical and Biomolecular Engineering and BioProcess Engineering Research Center,¹ and Department of BioSystems and Bioinformatics Research Center,² Korea Advanced Institute of Science and Technology, and Korea Research Institute of Bioscience and Biotechnology,³ Daejeon, Republic of Korea

Received 18 March 2004/Accepted 22 May 2004

We have developed a novel cell surface display system by employing FadL as an anchoring motif, which is an outer membrane protein involved in long-chain fatty acid transport in *Escherichia coli*. A thermostable *Bacillus* sp. strain TG43 lipase (44.5 kDa) could be successfully displayed on the cell surface of *E. coli* in an active form by C-terminal deletion-fusion of lipase at the ninth external loop of FadL. The localization of the truncated FadL-lipase fusion protein on the cell surface was confirmed by confocal microscopy and Western blot analysis. Lipase activity was mainly detected with whole cells, but not with the culture supernatant, suggesting that cell lysis was not a problem. The activity of cell surface-displayed lipase was examined at different temperatures and pHs and was found to be the highest at 50°C and pH 9 to 10. Cell surface-displayed lipase was quite stable, even at 60 and 70°C, and retained over 90% of the full activity after incubation at 50°C for a week. As a potential application, cell surface-displayed lipase was used as a whole-cell catalyst for kinetic resolution of racemic methyl mandelate. In 36 h of reaction, (*S*)-mandelic acid could be produced with the enantiomeric excess of 99% and the enantiomeric ratio of 292, which are remarkably higher than values obtained with crude lipase or cross-linked lipase crystal. These results suggest that FadL may be a useful anchoring motif for displaying enzymes on the cell surface of *E. coli* for whole-cell biocatalysis.

Cell surface display is a technique to display peptides or proteins on the surface of gram-negative and gram-positive bacteria, fungi, or even mammalian cells by appropriately fusing them to surface anchoring motifs (14, 21, 22, 31). The first surface expression system was developed by fusing bacteriophage coat protein with peptides and small proteins (27). This phage display has been widely used in screening of antibodies, epitopes, and high-affinity ligands. However, the size of foreign proteins that can be displayed on the surface of phage is rather limited (4, 7). As an alternative to phage display, microbial cell surface display has been developed. This technique has a wide range of biotechnological and industrial applications, including development of vaccines, peptide and antibody libraries, bioremediation, biocatalysis, and biosensors. Many different proteins, including outer membrane proteins, lipoproteins, autotransporters, subunits of surface appendages, and S-layer proteins, have been successfully employed as anchoring motifs in microbial cell surface display (14, 18, 21). Among these, outer membrane proteins have widely been used as anchoring motifs because they have unique membrane-spanning structures, which provide many potential fusion sites for target proteins. Several membrane proteins, including OmpA, OprF, OmpS, invasins, LamB, PhoE, OmpC, and Lpp-OmpA, have

been used as anchoring motifs for displaying relatively small-molecular-weight peptides, antibodies, domains, and receptors (4, 21, 25, 32).

FadL (48.8 kDa) is an outer membrane protein involved in the binding and transportation of long-chain fatty acids and also in the binding of bacteriophage T2 in *Escherichia coli* (5, 10). It has been reported that FadL is rich in β -structure and spans the outer membrane multiple times to form a long-chain fatty acid-specific channel. FadL consists of 20 antiparallel β -strands which produce a β -barrel structure and are connected by 9 internal loops and 10 external loops (9). These characteristics led us to examine the possibility of employing FadL as a novel anchoring motif for the display of proteins on the *E. coli* cell surface.

Recently, enzymatic chiral resolution has drawn much attention for obtaining enantiomerically enriched compounds by exploiting the selectivity of enzymes for one form of the enantiomers of a racemic molecule (8, 30). Although many kinds of enzymes can be used for the kinetic resolution of racemic compounds, enzymes including lipase, esterase, and protease have most frequently been used because of their merits such as broad substrate specificity, stability, and no requirement of cofactor (12, 15). Especially, lipase (triacylglycerol hydrolase; EC 3.1.1.3), which generally catalyzes hydrolysis of oils and transesterification of esters, is the most commonly used enzyme for this purpose because of its excellent enantioselectivity, commercial availability, broad substrate specificities to natural and unnatural esters of different structures, and good stability in various media ranging from aqueous to nonaqueous organic solvents (23, 29). Due to these advantages, lipase has

* Corresponding author. Mailing address: Department of Chemical and Biomolecular Engineering, Korea Advanced Institute of Science and Technology, 373-1 Guseong-dong, Yuseong-gu, Daejeon 305-701, Republic of Korea. Phone: 82-42-869-3930. Fax: 82-42-869-3910. E-mail: leesy@kaist.ac.kr.

† Present address: LG Chem, Ltd., Yuseong-gu, Daejeon 305-380, Republic of Korea.

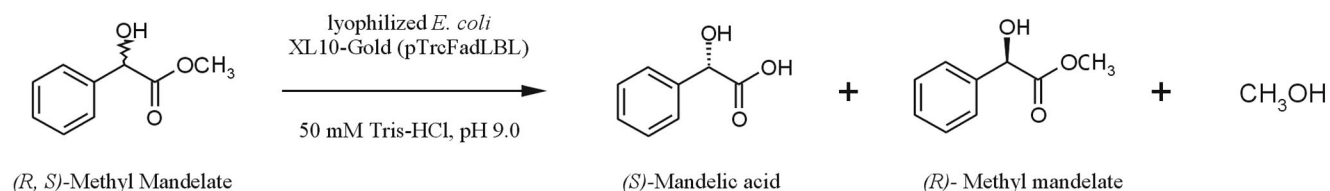

FIG. 1. Reaction scheme for enantioselective resolution of racemic methyl mandelate by using lyophilized cells of recombinant *E. coli* XL10-Gold displaying the FadL₁-lipase fusion protein.

been widely applied for the production of enantiomerically pure compounds, which are subsequently used for the synthesis of fine chemicals and drug intermediates. However, the reduced enantioselectivity and product yield and the presence of impurities are the common problems observed. The use of a highly purified enzyme or an immobilized enzyme can partially solve these problems, but the process becomes more expensive and instability problems can arise (20). Therefore, the development of efficient enzyme systems and processes has been an important research objective in this field.

In this paper, we investigated the display of a thermostable *Bacillus* sp. strain TG43 lipase (44.5 kDa) (28) in an active form on the *E. coli* cell surface by using FadL as an anchoring motif and its application in enantioselective biocatalysis. As an example, we examined enantioselective resolution of racemic methyl mandelate, as shown in Fig. 1.

MATERIALS AND METHODS

Bacterial strains and growth conditions. *E. coli* XL10-Gold (Stratagene cloning system; Stratagene, La Jolla, Calif.) was used as a host strain for general cloning work and gene expression studies. Recombinant cells were cultivated in Luria-Bertani medium (10 g of Bacto Tryptone/liter, 5 g of Bacto yeast extract/liter, and 5 g of NaCl/liter) supplemented with 50 mg of ampicillin/liter at 37°C and 250 rpm. When the optical density at 600 nm (OD₆₀₀) was 0.4, cells were induced with 0.1 mM isopropyl-β-D-thiogalactopyranoside (IPTG) for the production of recombinant proteins. After induction, cells were further cultured for 4 h and used for Western blotting and immunofluorescence microscopy.

Construction of plasmids. PCR was performed with the PCR thermal cycler MP (Takara Shuzo Co., Ltd., Shiga, Japan) using the Expand high-fidelity PCR system (Roche Molecular Biochemicals, Mannheim, Germany). DNA sequencing was carried out using the BigDye terminator cycle sequencing kit (Perkin-Elmer Co., Boston, Mass.), *Taq* polymerase, and an ABI Prism 377 DNA sequencer (Perkin-Elmer Co.). All DNA manipulations including restriction digestion, ligation, and agarose gel electrophoresis were carried out following standard procedures (24).

PCR primers used in this study are listed in Table 1. Primers for the amplification of the *E. coli* *fadL* and *Bacillus* sp. strain TG43 lipase genes were designed

based on the reported *E. coli* genome sequence (6) and the sequence of *Bacillus* sp. strain TG43 lipase (28) (GenBank accession no. AF141874), respectively.

Fractionation of outer membrane proteins. Culture broth (3 ml) was centrifuged at 3,500 × *g* for 5 min at 4°C, and the cell pellet was washed with 1 ml of 10 mM Na₂HPO₄ buffer (pH 7.2), followed by centrifugation at 3,500 × *g* for 5 min at 4°C. The cell pellet was resuspended in 0.5 ml of 10 mM Na₂HPO₄ buffer (pH 7.2). Crude extracts of recombinant *E. coli* cells were prepared by three cycles of sonication (each for 20 s at 15% of maximum output; high-intensity ultrasonic liquid processors; Sonics & Material Inc., Newtown, Conn.). Partially disrupted cells were first removed by centrifugation of sonicated samples at 12,000 × *g* for 2 min at room temperature. Membrane proteins and lipid layers were isolated by centrifugation at 12,000 × *g* for 30 min at 4°C, followed by resuspension in 0.5 ml of 10 mM Na₂HPO₄ buffer (pH 7.2). For sodium dodecyl sulfate-polyacrylamide gel electrophoresis (SDS-PAGE) and Western blotting experiments, 0.5% (wt/vol) sarcosyl was also added. After incubation at 37°C for 30 min, the insoluble pellet containing membrane proteins was obtained by centrifugation at 12,000 × *g* for 30 min at 4°C. Membrane proteins were obtained by washing the insoluble pellet with 10 mM Na₂HPO₄ buffer (pH 7.2) followed by resuspending in 50 μl of Tris-EDTA buffer (pH 8.0).

Western blotting. Since the antibody against the *Bacillus* sp. strain TG43 lipase was not available, we used anti-His antibody to probe the truncated FadL (FadL₁)-lipase-His₆ fusion protein. Whole-cell lysates and membrane fractions were analyzed by SDS-12% (wt/vol) PAGE. Western blot analysis was performed following standard protocols (24). For the immunodetection of the fusion protein, rabbit anti-His probe antibody (Santa Cruz Biotechnology, Santa Cruz, Calif.) and goat anti-rabbit immunoglobulin G (IgG)-horseradish peroxidase conjugate (Sigma, St. Louis, Mo.) were used. The light-emitting nonradioactive ECL kit (Amersham Life Sciences, Buckinghamshire, United Kingdom) was used for signal detection.

Immunofluorescence microscopy. For immunofluorescence microscopy, cells (1 ml) were harvested by centrifugation for 5 min at 3,500 × *g* and 4°C, washed with phosphate-buffered saline (PBS) solution, and resuspended in PBS solution supplemented with 3% (wt/wt) bovine serum albumin (Sigma). Cells were incubated with the rabbit anti-His probe antibody diluted (1:1,000) in PBS solution containing 3% (wt/wt) bovine serum albumin for 4 h at 4°C. After washing five times with PBS solution, the cell-antibody complex was incubated overnight at 4°C with goat anti-rabbit IgG conjugated with fluorescein isothiocyanate (FITC; Sigma) at a dilution of 1:3,000. Prior to microscopic observation, cells were washed five times with PBS solution to remove unbound goat anti-rabbit IgG conjugated with FITC. Cells were mounted on poly-L-lysine-coated microscopic slides and examined by confocal microscopy (Carl Zeiss, Jena, Germany). Pho-

TABLE 1. List of primers used in PCR experiments

Primer	Sequence ^a	Gene to be amplified	Template DNA used
Primer 1	5'-GGAATTCATGGTCATGAGCCAGAAAACC	Truncated <i>fadL</i>	<i>E. coli</i> W3110 chromosome
Primer 2	5'-GCTCTAGAACGATTCTGTGCAGGAAC		
Primer 1	5'-GGAATTCATGGTCATGAGCCAGAAAACC	Truncated <i>fadL</i> with stop codon	<i>E. coli</i> W3110 chromosome
Primer 3 ^b	5'-GCTCTAGATTAAACGATTCTGTGCAGGAAC		
Primer 4	5'-GCTCTAGAGCGGCTTCGCGAGCCAAT	<i>Bacillus</i> sp. strain TG43 lipase gene	<i>lipA</i> -pET26b
Primer 5	5'-CCCAAGCTTTTAAGGCCGCAAACCTCGC		
Primer 6	5'-CCCAAGCTTTTAATGGTGATGATGGTGATGAGGCCGCAAACCTCGC		

^a Restriction enzyme sites are shown in bold.

^b Underlined sequence was added for expression of the truncated *fadL* gene.

tographs were taken with a Carl Zeiss LSM 410. Samples were excited by a 488-nm argon laser, and images were filtered by a long-pass 505-nm filter.

Measurement of lipase activities. Cells were cultivated in a 250-ml flask containing 100 ml of Luria-Bertani medium at 37°C and 250 rpm. At an OD₆₀₀ of 0.4, cells were induced with 0.01, 0.1, or 1 mM IPTG for the production of recombinant proteins. After induction, cells were further cultured for 4 h. Cells were harvested by centrifugation for 5 min at 5,590 × g and 4°C, washed with distilled water, and lyophilized with a freeze dryer (TFD5505; Ilshin Lab., Gyeonggi-do, Korea) for 48 h.

Lipase activity was assayed by a spectrophotometric method using *p*-nitrophenyl decanoate as a substrate (19). The *p*-nitrophenyl decanoate was dissolved in acetonitrile at a concentration of 10 mM. Ethanol and 50 mM Tris-HCl (pH 8.0) were subsequently added to make a substrate solution having a volume ratio of 1:4:95 (10 mM *p*-nitrophenyl decanoate in acetonitrile-ethanol-Tris-HCl). Lyophilized cells (0.15 mg) or culture supernatant (500 μl) was added to 3 ml of substrate solution for the determination of lipase activity. After incubating the reaction mixture at 37°C for 10 min, the reaction was terminated by adding 2 μl of 0.5 M EDTA. The activity was assayed by detecting the product, *p*-nitrophenol, spectrophotometrically at 405 nm. One unit of lipase activity was defined as the amount of enzyme releasing one micromole of *p*-nitrophenol per minute (2). The specific activity was defined as the lipase activity per milligram of lyophilized cells. All measurements were carried out in triplicate.

The temperature-dependent lipase activities were examined in the same substrate solution described above at controlled temperatures from 16 to 70°C. The optimal pH was determined at 37°C using substrate solutions having a volume ratio of 1:4:95 (10 mM *p*-nitrophenyl decanoate in acetonitrile-ethanol-50 mM potassium phosphate or 50 mM Tris-HCl at various pHs ranging from 5 to 10). The effect of substrate chain length was determined by adding a 10 mM solution of *p*-nitrophenyl caproate or *p*-nitrophenyl palmitate instead of *p*-nitrophenyl decanoate. For the examination of thermal stability of cell surface-displayed lipase, 10 mg of lyophilized cells was resuspended in 10 ml of Tris-HCl (pH 8.0) and incubated at 37 or 50°C for a week. The 0.1-ml aliquots were taken, cooled to 37°C, and added to 1 ml of substrate solution for the measurement of residual activity at 37°C for 10 min. For the detection of cell lysis, we measured the OD₆₀₀ and the enzyme activity in the supernatant during the entire reaction.

Preparation of enantiomerically pure compound. For the enantioselective hydrolysis, 300 mg of lyophilized cells (prepared by inducing with 0.1 mM IPTG) was resuspended in 30 ml of 50 mM Tris-HCl (pH 9.0), into which 150 mg of racemic methyl mandelate (Aldrich, St. Louis, Mo.) was added. The reaction mixture was incubated at 37°C and 250 rpm. Small aliquots of reaction mixture were removed at 12, 24, and 36 h of the reaction, and the products were analyzed by high-performance liquid chromatography (HPLC; 1100 HPLC system; Agilent, Palo Alto, Calif.).

Analytical methods. Cell growth was monitored by measuring the OD₆₀₀ with a spectrophotometer (DU650; Beckman, Fullerton, Calif.). The yield and optical purity of substrate (racemic methyl mandelate) were analyzed by using the HPLC apparatus equipped with a chiral column (Chiralcel OJ-H column; Daicel Chemical Industries, Osaka, Japan). A mixture of hexane and isopropanol having a volume ratio of 90:10 was used as a mobile phase at a flow rate of 1.0 ml/min. For the analysis of product [(*S*)-mandelic acid], a Chiralcel OD-H column (Daicel) was employed using a mixture of hexane, isopropanol, and trifluoroacetic acid at a volume ratio of 80:20:1 as a mobile phase at a flow rate of 0.5 ml/min. Reaction products and substrates were detected by measuring the absorbance at 230 nm using a diode array detector (1100 HPLC DAD; Agilent).

RESULTS

Construction of cell surface display system. Based on the predicted structure of FadL (9), two trypsin cleavage sites following Arg⁹³ and Arg³⁸⁴ are exposed at the external face of the outer membrane and are located at the second and ninth loops from the N terminus, respectively. Therefore, these points were considered the potential fusion sites. Between these two fusion sites, the ninth external loop was selected because the ninth loop is the second-to-the-last external loop and, therefore, is not likely to disrupt most of the FadL β-barrel structure.

The truncated *fadL* (*fadL*_t) gene encoding the first 384 amino acids from the N terminus was amplified by PCR using primers 1 and 2 and was cloned into the EcoRI and XbaI sites

of pTrc99A to make pTrcFadL (Fig. 2). One arginine was additionally inserted at the C terminus by introducing the XbaI site at the 3' end of the *fadL*_t gene. The *Bacillus* sp. strain TG43 lipase gene amplified using primers 4 and 5 was then cloned into the XbaI and HindIII sites of pTrcFadL to make pTrcFadLBL (Fig. 2). For the expression of the *fadL*_t gene without fusion, the *fadL*_t gene containing the stop codon was amplified using primers 1 and 3 and cloned into the EcoRI and XbaI sites of pTrc99A to make pTrcFadLE (Fig. 2). For the immunofluorescence detection of surface-displayed protein, the *Bacillus* sp. strain TG43 lipase gene fused to a DNA fragment encoding six histidines (His₆) at the C terminus was amplified using primers 4 and 6 and was cloned into the XbaI and HindIII sites of pTrcFadL to make pTrcFadLBLH (Fig. 2). The His₆ was introduced to serve as an epitope for the rabbit anti-His probe antibody. For the intracellular expression of lipase, the *Bacillus* sp. strain TG43 lipase gene amplified using primers 4 and 5 was cloned into the XbaI and HindIII sites of pTrc99A to make pTrcBL (Fig. 2).

Confirmation of lipase display on the cell surface. To examine whether lipase was successfully displayed on the cell surface, the whole-cell lysate and outer membrane fraction of recombinant *E. coli* producing FadL_t-lipase fusion protein were analyzed by SDS-PAGE. However, the fusion protein could hardly be detected by Coomassie blue staining, because its expression level was rather low (Fig. 3A). Therefore, Western blot analysis of FadL_t-lipase-His₆ was carried out using the rabbit anti-His probe antibody, which was subsequently detected with horseradish peroxidase-conjugated goat anti-rabbit IgG (Fig. 3B). The bands corresponding to the 84.2-kDa fusion protein were detected in whole-cell lysates and the outer membrane fraction (Fig. 3B, lanes 2 and 3). No signal was detected in whole-cell lysates of *E. coli* XL10-Gold (pTrcFadLE) cells producing the FadL_t protein (Fig. 3B, lane 1).

The display of lipase on the cell surface could be more directly confirmed by immunofluorescence microscopy. As shown in Fig. 4, *E. coli* XL10-Gold cells expressing the FadL_t-lipase-His₆ fusion protein became fluorescent due to the binding of anti-His probe antibody followed by binding of FITC-conjugated secondary antibody, indicating that lipase was successfully displayed on the cell surface (Fig. 4B). On the other hand, *E. coli* XL10-Gold cells expressing FadL_t were not fluorescent at all (Fig. 4A).

After confirming that lipase was successfully displayed on the *E. coli* cell surface, we next examined whether the displayed lipases were active. Whole-cell lipase activities of 71.2 ± 7.9 (mean ± standard deviation), 104.9 ± 9.9, and 66.2 ± 8.1 U were obtained using lyophilized XL10-Gold (pTrcFadLBL) cells prepared by inducing with 0.01, 0.1, and 1 mM IPTG, respectively, while only 3.2 ± 0.6, 3.3 ± 0.92, and 5.4 ± 1.1 U of lipase activity, respectively, was detected in the supernatant. The maximum specific activities of lyophilized XL10-Gold (pTrcBL), XL10-Gold (pTrcFadLBL), and purified *Bacillus* sp. strain TG43 lipase were 200 U/mg, 2,800 U/mg of lyophilized cells, and 726,700 U/mg of lipase, respectively, which indicated that the expression level of lipase was 0.4% of total cell weight at least (28). To estimate the actual expression level of lipase in each fraction, the activities of whole-cell, soluble, and membrane fractions were compared. The activity of the membrane fraction was 80% of whole-cell activity. The activity

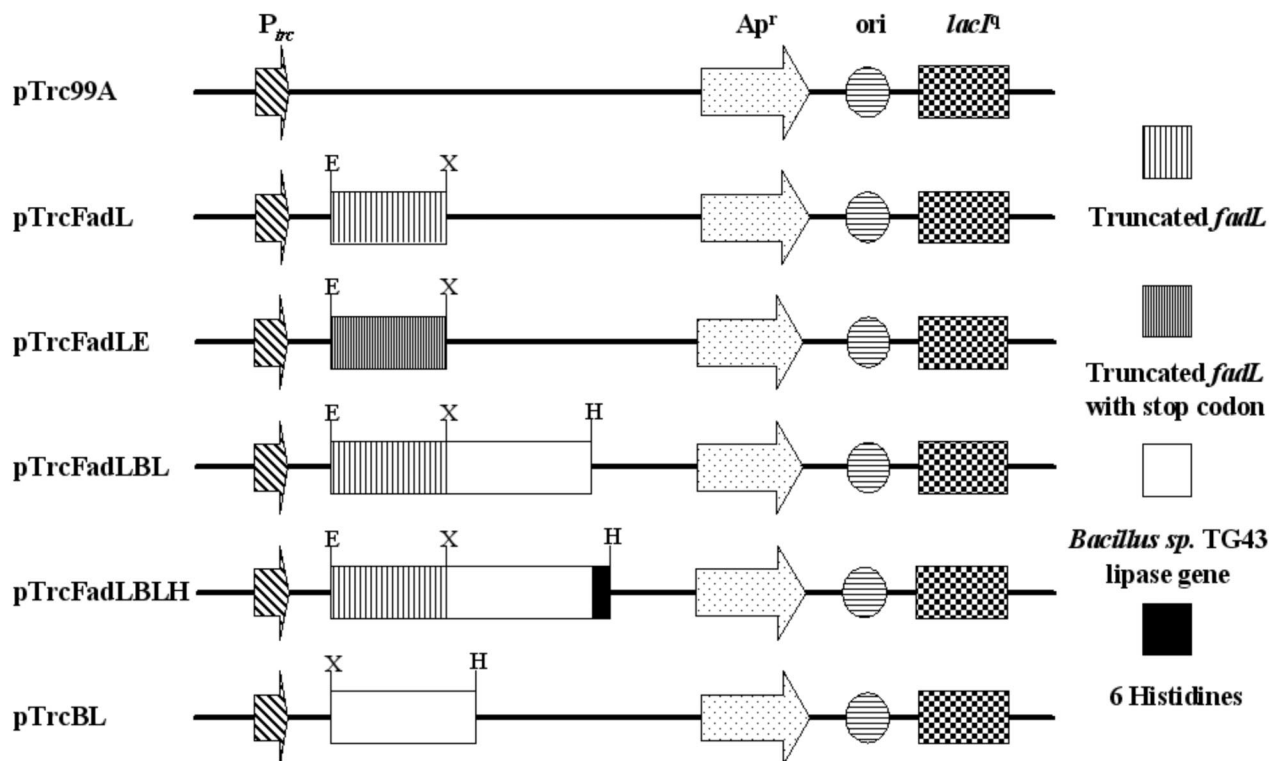

FIG. 2. Plasmids used for the display of lipase: pTrc99A (Pharmacia Biotech, Uppsala, Sweden), pTrcFadL, truncated *fadL* of *E. coli*; pTrcFadLE, truncated *fadL* of *E. coli* containing the stop codon; pTrcFadLBL, truncated *fadL*-*Bacillus* sp. strain TG43 lipase gene; pTrcFadLBLH, truncated *fadL*-*Bacillus* sp. strain TG43 lipase-His₆ fusion gene at the C terminal; pTrcBL, *Bacillus* sp. strain TG43 lipase. Abbreviations: E, EcoRI; X, XbaI; H, HindIII; P_{trc}, *trc* promoter; Ap^r, β-lactamase gene.

of the soluble fraction was below 10% of whole-cell activity. These results suggest that lipases were successfully displayed in an active form by using FadL_t as an anchoring motif.

Activity and stability of cell surface-displayed lipase. To determine the optimal conditions of cell surface-displayed lipase, reactions were carried out at various temperatures ranging from 16 to 70°C and pHs of 5 to 10. The results are shown

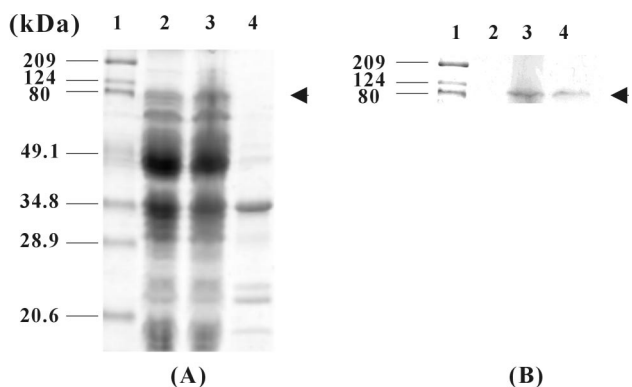

FIG. 3. SDS-PAGE analysis (A) and immunoblotting (B) of recombinant *E. coli* XL10-Gold cells expressing FadL_t and FadL_t-lipase-His₆ fusion proteins. Lane 1, molecular mass standards; lane 2, whole-cell lysates of *E. coli* XL10-Gold harboring pTrcFadLE; lane 3, whole-cell lysates of *E. coli* XL10-Gold harboring pTrcFadLBLH; lane 4, outer membrane fraction of *E. coli* XL10-Gold harboring pTrcFadLBLH.

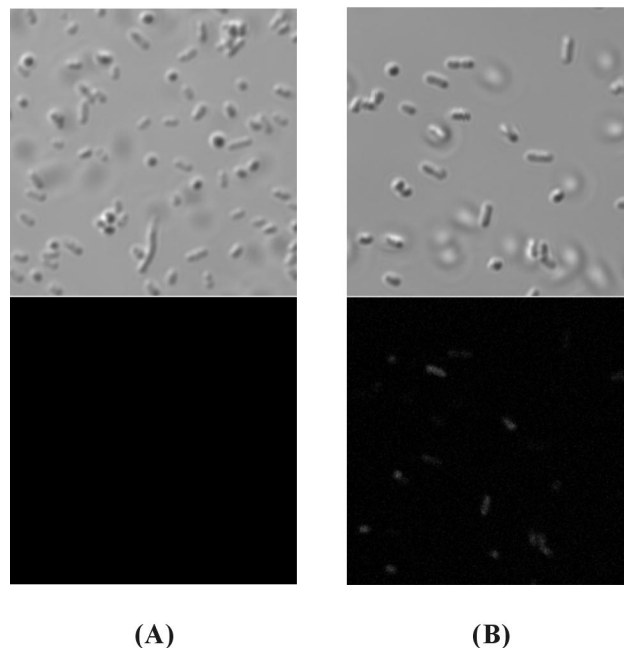

FIG. 4. Differential interference micrographs (upper) and immunofluorescence micrographs (lower) of XL10-Gold cells harboring pTrcFadLE (A) and pTrcFadLBLH (B). Cells were incubated with rabbit anti-His probe antibody followed by probing with goat anti-rabbit IgG-FITC conjugate.

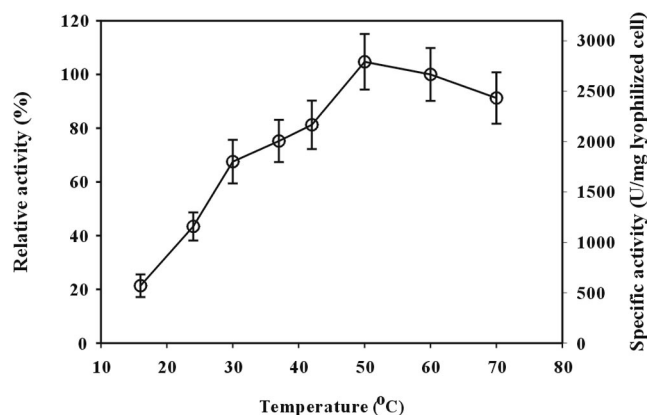

FIG. 5. Effect of temperature on lipase activity of *E. coli* XL10-Gold (pTrcFadLBL). The enzyme activity was determined at pH 8.0 by using *p*-nitrophenyl decanoate as the substrate. Relative activity was calculated by assuming the activity obtained at 60°C was 100%.

in Fig. 5 and 6. Cell surface-displayed lipase showed the maximum activity at 50°C. In the temperature range of 40 to 70°C, the activity was higher than 80% of the maximum activity. The activity of cell surface-displayed lipase was higher under alkaline conditions and was the highest at pH 9. After the optimization of reaction conditions, thermal stability was examined, as it is important for industrial applications. Cell surface-displayed lipase was incubated at 37 and 50°C for 1 week, and the whole-cell activity was measured periodically during the week. As shown in Fig. 7, the cell surface-displayed lipase was quite stable against heat and did not show much loss of activity (less than 10%) at either temperature. When we measured the cell density (OD₆₀₀) during the reaction, the change of OD₆₀₀ was negligible during the entire reaction period. Furthermore, the activities in the supernatants were negligible, which indicated that cell lysis did not occur. Finally, substrate specificity was examined using three *p*-nitrophenyl esters, of caproate, decanoate, and palmitate, having different carbon chain lengths. The lipase used in this study showed the highest activity to-

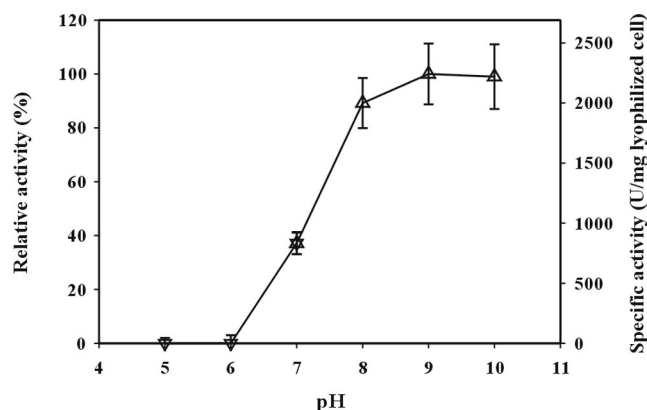

FIG. 6. Effect of pH on lipase activity of *E. coli* XL10-Gold (pTrcFadLBL). The enzyme activity was determined at 37°C by using *p*-nitrophenyl decanoate as the substrate. Buffers used were 50 mM potassium phosphate buffer (▽) and 50 mM Tris-HCl (△). Relative activity was calculated by assuming the activity obtained at pH 9.0 was 100%.

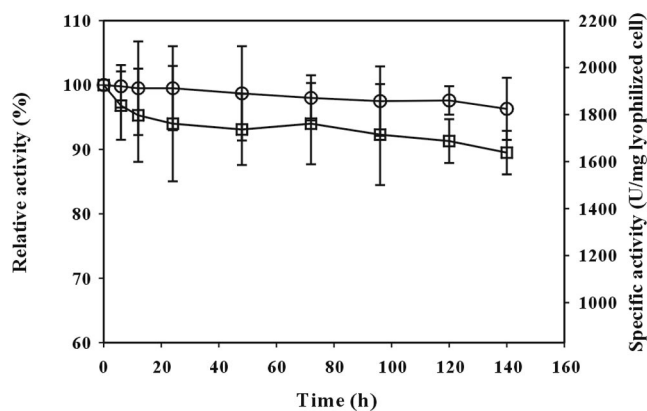

FIG. 7. Stability of lipase displayed on the cell surface of *E. coli* XL10-Gold (pTrcFadLBL) cells during prolonged incubation at pH 8.0 and 37°C (○) or 50°C (□). The enzyme activity was determined at 37°C by using *p*-nitrophenyl decanoate as the substrate. Relative activity was calculated by assuming the initial activity was 100%.

wards *p*-nitrophenyl octanoate (C₈) when it is used in the free form. The activity towards *p*-nitrophenyl palmitate (C₁₆) or *p*-nitrophenyl butyrate (C₄) was below 50% of the highest activity (28). As shown in Table 2, the activity obtained with *p*-nitrophenyl palmitate was below half of that obtained with *p*-nitrophenyl decanoate or *p*-nitrophenyl caproate. These results suggest that the enzymatic characteristics of the cell surface-displayed lipase were similar to those of free enzyme (3, 28).

Enantioselective resolution of racemic methyl mandelate by using cell surface-displayed lipase. As a potential application, we investigated the possibility of enantioselective resolution of racemic compounds by using cell surface-displayed lipase. Racemic methyl mandelate was used as a model substrate. The scheme for enantioselective resolution with cell surface-displayed lipase is shown in Fig. 1. After 36 h, the enantiomeric excesses of the remaining methyl mandelate and the product, (*S*)-mandelic acid, reached 33 and 99%, respectively (Table 3). Also, high enantioselectivity (*E* value of >250) was obtained (Table 3). These results suggest that the lipase displayed on the *E. coli* cell surface can be used for efficient chiral resolution of racemic compounds.

DISCUSSION

The microbial cell surface display system can be used in a wide range of applications as described earlier. Especially,

TABLE 2. Effect of substrate chain length on activity of cell surface-displayed lipase

Activity parameter	<i>p</i> -Nitrophenyl caproate	<i>p</i> -Nitrophenyl decanoate	<i>p</i> -Nitrophenyl palmitate
Activity (U) ^a	96.9 ± 10.2	105 ± 10.6	43.3 ± 10.6
Specific activity (U/mg of lyophilized cells)	1,940 ± 200	2,000 ± 200	870 ± 200
Relative activity (%) ^b	92.3 ± 9.72	100 ± 10.2	41.2 ± 10.1

^a Activity was assayed by adding 0.15 mg of lyophilized cells into the substrate solution consisting of 10 mM substrate in acetonitrile, ethanol, and 50 mM Tris-HCl (pH 8.0) at the volume ratio of 1:4:95.

^b Relative activity was calculated by assuming the activity obtained with *p*-nitrophenyl decanoate as 100%.

TABLE 3. Enantioselective hydrolysis of racemic methyl mandelate by cell surface-displayed lipase

Time (h)	Enantiomeric excess (%) ^a		Conversion (%) ^b	Enantiomeric ratio ^c
	Remaining ester	Product		
12	0	ND ^d	0	
24	23.2 ± 1.6	99.0	19.0 ± 1.0	250
36	39.1 ± 2.5	99.0	28.3 ± 1.3	292

^a Enantiomeric excess (ee) = 100 × (A - B)/(A + B), where A and B are enantiomers and A is greater than B.

^b Percentage of conversion (c) = ee_s/(ee_s + ee_p), where subscripts s and p represent remaining ester and product, respectively.

^c Enantiomeric ratio (E) = ln[1 - c(1 + ee_p)]/ln[1 - c(1 - ee_p)].

^d ND, not detected.

display of active enzyme has been intensively pursued for its potential to be used as a whole-cell biocatalyst in the fields of pharmaceutical, fine chemical, and agrochemical production. To date, however, only a few enzymes, including levansucrase, organophosphorous hydrolase, lipase, dimeric bovine adrenodoxin, and carboxymethylcellulase, have been displayed on the cell surface by using only a small number of different anchoring motifs (17, 18, 21, 26). With an aim to develop a novel system for the display of enzymes, we examined the *E. coli* outer membrane protein FadL as a potential anchoring motif. Several strategies have been developed to fuse target proteins to the anchoring motif: N-terminal fusion, sandwich fusion, and C-terminal fusion (11, 16, 26, 32). Among them, we employed a C-terminal deletion-fusion strategy, as it allows display of relatively large proteins of up to 60 kDa (21). Successful display of the 44.5-kDa *Bacillus* sp. strain TG43 lipase by using FadL as an anchoring motif was confirmed by whole-cell activity measurement, immunofluorescence microscopy, and Western blot analysis.

As shown in Fig. 5, 6, and 7, cell surface-displayed lipase showed good enzymatic characteristics. This performance seems to have been due to the displayed pure lipase being stably anchored at the cellular outer membrane in active form, behaving like an immobilized enzyme system. The most remarkable finding with the FadL surface display system is the heat stability. Lyophilized cells displaying lipase were very stable at high temperature (50°C) and retained 90% of full activity after incubation at 50°C for a week (Fig. 7). Display of enzyme on the cell surface often causes instability of the membrane, which consequently causes cell growth defects, lysis, and/or inactivation of cell surface-displayed enzyme (26). However, the lipase displayed by using FadL as an anchor motif showed high heat stability, with no sign of cell growth defects, lysis, or thermal inactivation.

To apply cell surface-displayed lipase in the production of chiral compounds, we carried out enantioselective hydrolysis of racemic methyl mandelate as an example. During the hydrolysis reaction, no significant cell lysis was observed at 37°C (the change of OD₆₀₀ and supernatant activity during the reaction were negligible), indicating that hydrolysis of methyl mandelate was carried out by cell surface-displayed lipase, not by the free lipase released. As shown in Table 3 optically pure (*S*)-mandelic acid could be obtained with an enantiomeric excess of 99% and an *E* value of 292. These results are remarkably higher than those obtained with crude lipase or cross-linked lipase crystal (1, 20). It has been reported that the substrate

structure and the origin of lipase mainly determine the reactivity and selectivity in a lipase-catalyzed reaction (13). This is also true for the cell surface-displayed lipase, because (*S*)-methyl mandelate is the preferred substrate in this reaction. This further suggests that higher reactivity and selectivity for a desired substrate can be achieved by displaying a different lipase highly active towards that substrate.

In this study, we demonstrated that *E. coli* FadL can be used as an efficient anchoring motif for the display of a relatively large enzyme (44.5 kDa). Also, displayed lipase could be used for enantioselective biocatalysis with high reactivity, enantioselectivity, and enhanced thermal stability. Moreover, because cell surface-displayed lipase can be simply prepared by cultivation and harvesting of recombinant cells, no additional steps for the purification and immobilization of lipase are required. In conclusion, the cell surface-displayed lipase and, more generally, cell surface-displayed enzyme can be used as a cost-effective system for various biocatalytic reactions in the fields of pharmaceuticals, fine chemicals, agrochemicals, and other demanding industries.

ACKNOWLEDGMENTS

We thank Peter L. Bergquist, Macquarie University, New South Wales, Australia, for kindly providing the plasmid *lipA*-pET26b.

This work was supported by MOCIE grants from the Intelligence Bioinformatics and Application Center (TGW10011093) at the KRIBB, the Center for Ultramicrochemical Process Systems sponsored by KOSEF, an LG Chem Chair Professorship, and by the BK21 project. Further support from IBM through the Shared University Research Program is appreciated.

REFERENCES

- Ahmed, S. N., R. J. Kazlauskas, A. H. Morinville, P. Grochulski, J. D. Schrag, and M. W. Cygler. 1994. Enantioselectivity of *Candida rugosa* lipase toward carboxylic acids: a predictive rule from substrate mapping and X-ray crystallography. *Biocatalysis* **9**:209–225.
- Ahn, J. H., J. G. Pan, and J. S. Rhee. 1999. Identification of the *tlDEF* ABC transporter specific for lipase in *Pseudomonas fluorescens* SIK W1. *J. Bacteriol.* **181**:1847–1852.
- Bell, P. J. L., H. Nevalainen, H. W. Morgan, and P. L. Bergquist. 1999. Rapid cloning of thermoalkalophilic lipases from *Bacillus* spp. using PCR. *Biotechnol. Lett.* **21**:1003–1006.
- Benhar, I. 2001. Biotechnological applications of phage and cell display. *Biotechnol. Adv.* **19**:1–33.
- Black, P. N. 1988. The *fadL* gene product of *Escherichia coli* is an outer membrane protein required for uptake of long-chain fatty acids and involved in sensitivity to bacteriophage T2. *J. Bacteriol.* **170**:2850–2854.
- Blattner, F. R., G. Plunkett, C. A. Bloch, N. T. Perna, V. Burland, M. Riley, J. Collado-Vides, J. D. Glasner, K. Rode, G. F. Mayhew, J. Gregor, N. W. Davis, H. A. Kirkpatrick, M. A. Goeden, D. J. Rose, B. Mau, and Y. Shao. 1997. The complete genome sequence of *Escherichia coli* K-12. *Science* **277**:1453–1462.
- Boder, E. T., and K. D. Wittrup. 1997. Yeast surface display for screening combinatorial polypeptide libraries. *Nat. Biotechnol.* **15**:553–557.
- Burton, S. G., D. A. Cowan, and J. M. Woodley. 2002. The search for the ideal biocatalyst. *Nat. Biotechnol.* **20**:37–45.
- Cristalli, G., C. C. DiRusso, and P. N. Black. 2000. The amino-terminal region of the long-chain fatty acid transport protein FadL contains an externally exposed domain required for bacteriophage T2 binding. *Arch. Biochem. Biophys.* **377**:324–333.
- DiRusso, C. C., P. N. Black, and J. D. Weimar. 1999. Molecular inroads into the regulation and metabolism of fatty acids, lessons from bacteria. *Prog. Lipid Res.* **38**:129–197.
- Dröge, M. J., C. J. Rüggeberg, A. M. van der Sloot, J. Schimmel, D. S. Dijkstra, R. M. D. Verhaert, M. T. Reetz, and W. J. Quax. 2003. Binding of phage displayed *Bacillus subtilis* lipase A to a phosphonate suicide inhibitor. *J. Biotechnol.* **101**:19–28.
- Faber, K., and M. C. R. Frassen. 1993. Prospects for the increased application of biocatalysts in organic transformations. *Trends Biotechnol.* **11**:461–470.
- Gais, H. J., and F. Theil. 2002. Hydrolysis and formation of carboxylic acid esters, p. 335–578. *In* K. Drauz and H. Waldmann (ed.), *Enzyme catalysis in*

- organic synthesis: a comprehensive handbook, 2nd ed. Wiley-VCH Verlag GmbH, Weinheim, Germany.
14. **Georgiou, G., C. Stathopoulos, P. S. Daugherty, A. R. Nayak, B. L. Iverson, and R. I. Curtiss.** 1997. Display of heterologous proteins on the surface of microorganisms: from the screening of combinatorial libraries to live recombinant vaccines. *Nat. Biotechnol.* **15**:29–34.
 15. **Jaeger, K. E., B. W. Dijkstra, and M. T. Reetz.** 1999. Bacterial biocatalysts: molecular biology, three-dimensional structures, and biotechnological applications of lipase. *Annu. Rev. Microbiol.* **53**:315–351.
 16. **Jose, J., R. Bernhardt, and F. Hannemann.** 2001. Functional display of active bovine adrenodoxin on the surface of *E. coli* by chemical incorporation of the [2Fe-2S] cluster. *ChemBioChem* **2**:695–701.
 17. **Jose, J., R. Bernhardt, and F. Hannemann.** 2002. Cellular surface display of dimeric Adx and whole cell P450-mediated steroid synthesis on *E. coli*. *J. Biotechnol.* **95**:257–268.
 18. **Jung, H. C., J. M. Lebeault, and J. G. Pan.** 1998. Surface display of *Zymomonas mobilis* levansucrase by using the ice-nucleation protein of *Pseudomonas syringae*. *Nat. Biotechnol.* **16**:576–580.
 19. **Kouker, G., and K. E. Jaeger.** 1987. Specific and sensitive plate assay for bacterial lipases. *Appl. Environ. Microbiol.* **53**:211–213.
 20. **Lalonde, J. J., M. A. Navia, and A. L. Margolin.** 1997. Cross-linked enzyme crystals of lipases as catalysts for kinetic resolution of acids and alcohols. *Methods Enzymol.* **286**:443–464.
 21. **Lee, S. Y., J. H. Choi, and Z. Xu.** 2003. Microbial cell surface display. *Trends Biotechnol.* **21**:45–52.
 22. **Li, M.** 2000. Applications of display technology in protein analysis. *Nat. Biotechnol.* **18**:1251–1256.
 23. **Reetz, M. T.** 2002. Lipases as practical biocatalysts. *Curr. Opin. Chem. Biol.* **6**:145–150.
 24. **Sambrook, J., and D. W. Russell.** 2001. *Molecular cloning: a laboratory manual*, 3rd ed. Cold Spring Harbor Laboratory Press, Cold Spring Harbor, N.Y.
 25. **Samuelson, P., E. Gunneriusson, P. A. Nygren, and S. Ståhl.** 2002. Display of proteins on bacteria. *J. Biotechnol.* **96**:129–154.
 26. **Shimazu, M., A. Mulchandani, and W. Chen.** 2001. Cell surface display of organophosphorus hydrolase using ice nucleation protein. *Biotechnol. Prog.* **17**:76–80.
 27. **Smith, G. P.** 1985. Filamentous fusion phage: novel expression vectors that display cloned antigens on the virion surface. *Science* **228**:1315–1317.
 28. **Sunna, A., L. Hunter, C. A. Hutton, and P. L. Bergquist.** 2002. Biochemical characterization of a recombinant thermoalkalophilic lipase and assessment of its substrate enantioselectivity. *Enzyme Microbiol. Technol.* **31**:472–476.
 29. **Svendsen, A.** 2000. Lipase protein engineering. *Biochim. Biophys. Acta* **1543**:223–238.
 30. **Thomas, S. M., R. DiCosimo, and V. Nagarajan.** 2002. Biocatalysis: applications and potentials for the chemical industry. *Trends Biotechnol.* **20**:238–242.
 31. **Wittrup, K. D.** 2001. Protein engineering by cell-surface display. *Curr. Opin. Biotechnol.* **12**:395–399.
 32. **Xu, Z., and S. Y. Lee.** 1999. Display of polyhistidine peptides on the *Escherichia coli* cell surface by using outer membrane protein C as an anchoring motif. *Appl. Environ. Microbiol.* **65**:5142–5147.