

# Dynamic Assignment Protocols for Multi- wavelength Gigabit-PONs

Ali Gliwan

*A thesis submitted in partial fulfilment of the requirements of the  
University of Hertfordshire for the degree of Doctor of Philosophy*

The programme of research was carried out in the Science and  
Technology Research Institute (STRI), University of Hertfordshire,  
United Kingdom.

October 2010

# Abstract

---

The research initiatives addressed in this thesis are geared towards improving the performance of passive optical networks through the development of advanced dynamic bandwidth allocation protocols. In particular, the aim of the research undertaken is to enhance the quality of service offered by standard passive optical networks with reduced network costs.

To that extent, a dynamic multi-wavelength protocol has been developed to increase the network upstream bandwidth and introduce multiple service levels to a fibre to the home-based giga-bit passive optical network. Simulation results have confirmed the reduction of the mean packet delay by adjusting the ITU-T standard G984 giga-bit passive optical network frame format by means of the introduction of extended wavelength band overlay based on the ITU-T Coarse-Wavelength Division Multiplexing grid to support the multi-wavelength functionality. To evaluate the multi-wavelength upstream operation of the newly implemented models in OPNET, 2-dimensional Dynamic Bandwidth Allocation algorithms have been introduced to manage the network resources in both the time and wavelength domains.

Furthermore, the enhanced traffic allocation among the supported wavelengths in new protocol confirmed a performance improvement in the network total capacity and the mean packet delay, which demonstrates the

network reliability and improves the quality of the provided service according to the subscriber service level agreement, with a minimum guaranteed bandwidth of 100 Mbit/s to fulfil applications and associated bandwidth requirements for the next generation access network.

# Acknowledgements

---

I am very grateful to my mother and my wife, for the support provided by the former and the understanding and help from the latter.

I would also like to state my gratitude to my supervisors, Professor John M. Senior and Dr. Pandelis Kourtessis, for their guidance and help during my research years.

I would like to thank my friend and colleague Mr. Fabien Delestre for his help and enjoyable time during my time at UH.

Finally I would like to thank all staff, colleagues, and classmates in the School for helping me during my research life over the past years.

# Contents

---

|   |              |
|---|--------------|
| <b>ABSTRACT</b> .....                                     | <b>I</b>     |
| <b>ACKNOWLEDGEMENTS</b> .....                             | <b>III</b>   |
| <b>CONTENTS</b> .....                                     | <b>IV</b>    |
| <b>LIST OF FIGURES</b> .....                              | <b>VIII</b>  |
| <b>LIST OF TABLES</b> .....                               | <b>XIII</b>  |
| <b>ABBREVIATIONS:</b> .....                               | <b>XIV</b>   |
| <b>DECLARATION:</b> .....                                 | <b>XVIII</b> |
| <b>1 INTRODUCTION</b> .....                               | <b>1</b>     |
| 1.1 OVERVIEW OF ACCESS NETWORKS .....                     | 1            |
| 1.2 FTTX DEPLOYMENT WORLDWIDE.....                        | 5            |
| 1.3 CONTRIBUTION TO KNOWLEDGE .....                       | 6            |
| 1.4 THESIS OUTLINE.....                                   | 11           |
| <b>2 PASSIVE OPTICAL NETWORKS (PON)</b> .....             | <b>13</b>    |
| 2.1 INTRODUCTION.....                                     | 13           |
| 2.2 PON ARCHITECTURES: .....                              | 14           |
| 2.3 PASSIVE OPTICAL NETWORK STANDARDS .....               | 18           |
| 2.4 TDM BANDWIDTH ALLOCATION PROTOCOLS.....               | 23           |
| 2.4.1 EPON Medium Access Control (MAC) .....              | 24           |
| 2.4.2 GPON Medium Access Control (MAC).....               | 28           |
| 2.4.3 Dynamic Minimum Bandwidth (DMB) algorithm .....     | 28           |
| 2.5 MULTI-WAVELENGTH BANDWIDTH ALLOCATION PROTOCOLS ..... | 31           |
| 2.6 NEXT-GENERATION OPTICAL ACCESS NETWORKS.....          | 33           |

|          |   |           |
|----------|---|-----------|
| 2.7      | SUMMARY .....   | 36        |
| <b>3</b> | <b>GPON ENHANCEMENT FOR MULTI-WAVELENGTH OPERATION .....</b>      | <b>38</b> |
| 3.1      | INTRODUCTION .....  | 38        |
| 3.2      | MULTI-WAVELENGTH PON ARCHITECTURES .....                          | 39        |
| 3.3      | STANDARD GPON FRAME FORMAT ADJUSTMENT .....                       | 42        |
| 3.3.1    | Transmission Convergence Layer .....                              | 44        |
| 3.3.2    | Upstream map frame format Adjustment .....                        | 46        |
| 3.3.3    | Registration and Reporting Frame format Adjustment .....          | 48        |
| 3.4      | DYNAMIC MULTI-WAVELENGTH (DMW) PROTOCOL .....                     | 51        |
| 3.4.1    | Dynamic Multi-Wavelength Protocol Aims .....                      | 51        |
| 3.4.2    | Dynamic Multi-Wavelength Protocol basics .....                    | 52        |
| 3.5      | SUMMARY .....   | 57        |
| <b>4</b> | <b>MULTI-WAVELENGTH NETWORK SIMULATION MODEL.....</b>             | <b>58</b> |
| 4.1      | INTRODUCTION .....  | 58        |
| 4.2      | THE MULTI-WAVELENGTH PON PROJECT MODEL.....                       | 62        |
| 4.3      | OLT NODE MODEL .....  | 64        |
| 4.4      | ONU NODE MODEL .....  | 67        |
| 4.5      | SPLITTER NODE MODEL .....   | 70        |
| 4.6      | LINK MODEL .....  | 73        |
| 4.7      | DMW OPNET FRAME FORMAT.....                                       | 74        |
| 4.8      | OPNET SIMULATION TEST-BED .....                                   | 75        |
| 4.8.1    | DMB-GPON Modelling and Simulation Results.....                    | 78        |
| 4.8.2    | Multi-Wavelength PON Modelling and Simulation Results.....        | 83        |
| 4.9      | SUMMARY .....   | 85        |
| <b>5</b> | <b>DMW PROTOCOL WITH SERIAL WAVELENGTH ALLOCATION (SWA) .....</b> | <b>87</b> |
| 5.1      | INTRODUCTION.....   | 87        |
| 5.2      | DEVELOPMENT OF A DMW-SWA PROTOCOL.....                            | 89        |
| 5.2.1    | The Bandwidth Allocation Mechanism .....                          | 93        |

|          |  |            |
|----------|--|------------|
| 5.3      | THE DMW-SWA MODEL: IMPLEMENTATION AND ANALYSIS .....                     | 95         |
| 5.3.1    | Simulations and Performance evaluation.....                              | 97         |
| 5.4      | SUMMARY .....  | 113        |
| <b>6</b> | <b>DMW-SWA PROTOCOL ENHANCEMENTS .....</b>                               | <b>114</b> |
| 6.1      | INTRODUCTION.....  | 114        |
| 6.2      | ADVANCED DYNAMIC MULTI-WAVELENGTH (ADMW) PROTOCOL.....                   | 115        |
| 6.2.1    | Protocol Development and Bandwidth Allocation Mechanism .....            | 116        |
| 6.2.2    | Implementation analysis, and Performance evaluation.....                 | 118        |
| 6.3      | EXTENDED-BANDWIDTH DMW (EBDMW) PROTOCOL.....                             | 122        |
| 6.3.1    | Protocol development and the Bandwidth Allocation Mechanism .....        | 123        |
| 6.3.2    | Implementation analysis, and Performance evaluation.....                 | 125        |
| 6.4      | SUMMARY .....  | 132        |
| <b>7</b> | <b>DMW PROTOCOL WITH PARALLEL WAVELENGTH ALLOCATION (PWA) .</b>          | <b>133</b> |
| 7.1      | INTRODUCTION.....  | 133        |
| 7.2      | DEVELOPMENT OF THE DMW-PWA PROTOCOL.....                                 | 134        |
| 7.3      | DMW-PWA BANDWIDTH ALLOCATION MECHANISMS .....                            | 136        |
| 7.4      | MODEL IMPLEMENTATION AND ANALYSIS.....                                   | 138        |
| 7.5      | SIMULATIONS AND PERFORMANCE EVALUATION .....                             | 138        |
| 7.6      | SUMMARY .....  | 151        |
| <b>8</b> | <b>CONCLUSIONS AND FUTURE WORK.....</b>                                  | <b>152</b> |
| 8.1      | REVIEW OF RESEARCH OUTCOMES.....   | 152        |
| 8.2      | SUMMARY OF RESULTS .....   | 154        |
| 8.3      | xDMW PROTOCOL APPLICATIONS IN VIEW OF RECENT STANDARDISATION INITIATIVES | 156        |
| 8.4      | FUTURE xDMW PROTOCOL DEVELOPMENTS .....                                  | 157        |
| 8.4.1    | xDMW protocol supported by Class of Service Differentiation.....         | 158        |
| 8.4.2    | Bidirectional -DMW (Bi-DMW) protocol.....                                | 160        |

**REFERENCES..... 161**

**APPENDIX: OPNET SIMULATION MODEL'S ATTRIBUTES..... 172**



# List of Figures

---

|  |    |
|--|----|
| FIGURE 1-1: EVALUATION OF ACCESS NETWORK TRENDS IN JAPAN .....           | 3  |
| FIGURE 2-1: FIBRE TO THE X (FTTx) .....                                  | 15 |
| FIGURE 2-2: POINT TO MULTI-POINT (P2MP) DOWNSTREAM TRANSMISSION .....    | 16 |
| FIGURE 2-3: UPSTREAM TRANSMISSION .....                                  | 17 |
| FIGURE 2-4: WDM-PON .....  | 21 |
| FIGURE 2-5: HYBRID WDM/TDM-PON .....                                     | 22 |
| FIGURE 2-6: CONSTANT TIME-SLOT TDM MAC POLLING DIAGRAM.....              | 23 |
| FIGURE 2-7: DYNAMIC TDM MAC POLLING DIAGRAM .....                        | 26 |
| FIGURE 2-8: IPACT POLLING DIAGRAM .....                                  | 27 |
| FIGURE 2-9: DMB POLLING DIAGRAM .....                                    | 29 |
| FIGURE 2-10: BROADBAND HOUSEHOLDS BY NOMINAL DATA RATE .....             | 34 |
| FIGURE 3-1: SUCCESS-DWA PON ARCHITECTURE .....                           | 39 |
| FIGURE 3-2: MULTI-PON ARCHITECTURE .....                                 | 41 |
| FIGURE 3-3: DYNAMIC MULTI-WAVELENGTH PON ARCHITECTURE .....              | 42 |
| FIGURE 3-4: CWDM GRID WITH GPON TRANSMISSION BANDS.....                  | 43 |
| FIGURE 3-5: ITU-T G 984.3 PHYSICAL CONTROL BLOCK DOWNSTREAM (PCBD) ..... | 44 |
| FIGURE 3-6: ITU-T G 984.3 PCBD US BW MAP .....                           | 45 |
| FIGURE 3-7: DMW-GPON UPSTREAM MAP ADJUSTMENT .....                       | 46 |
| FIGURE 3-8: DMW OPERATING CWDM WAVELENGTHS .....                         | 47 |
| FIGURE 3-9: GPON REPORTING FRAME FORMAT ADJUSTMENTS .....                | 50 |
| FIGURE 3-10: DMW PRINCIPLE OF OPERATION.....                             | 53 |
| FIGURE 4-1: OPNET MODEL LEVELS .....                                     | 60 |
| FIGURE 4-2: OVERALL NETWORK MODEL.....                                   | 63 |
| FIGURE 4-3: OLT NODE MODEL.....  | 65 |
| FIGURE 4-4: OLT PROCESS MODEL.....                                       | 66 |

|  |     |
|--|-----|
| FIGURE 4-5: ONU NODE MODEL.....  | 68  |
| FIGURE 4-6: ONU PROCESS MODEL.....   | 69  |
| FIGURE 4-7: SPLITTER NODE MODEL .....  | 72  |
| FIGURE 4-8: SPLITTER PROCESS MODEL .....   | 73  |
| FIGURE 4-9: SIMULATION DMW GATE PACKET .....   | 74  |
| FIGURE 4-10: SIMULATION DMW SUPPORTED WAVELENGTH REGISTRATION PACKET .....                     | 74  |
| FIGURE 4-11: SIMULATION DMW ONU REPORT PACKET .....  | 75  |
| FIGURE 4-12: SIMULATION DMW DATA PACKET.....   | 75  |
| FIGURE 4-13: DMB-GPON THROUGHPUT .....   | 81  |
| FIGURE 4-14: SIMULATED PACKET DELAY PERFORMANCE WITH FOUR SLA DMB-GPON .....                   | 82  |
| FIGURE 4-15: MULTI-WAVELENGTH GPON THROUGHPUT .....  | 84  |
| FIGURE 4-16: MEAN PACKET DELAY PERFORMANCE FOR MULTI-WAVELENGTH GPON .....                     | 85  |
| FIGURE 5-1: PONs UPSTREAM BANDWIDTH ALLOCATION SCHEMES .....                                   | 88  |
| FIGURE 5-2: SERIAL WAVELENGTH ALLOCATION MECHANISM.....  | 89  |
| FIGURE 5-3: MULTI-WAVELENGTH ONU TRAFFIC ALLOCATION WITHOUT TIME-LIMIT CONTROL....             | 91  |
| FIGURE 5-4: MULTI-WAVELENGTH ONU TRAFFIC ALLOCATION WITH TIME-LIMIT CONTROL .....              | 92  |
| FIGURE 5-5: ONU TRAFFIC ALLOCATION WITH A SAFETY MARGIN .....                                  | 93  |
| FIGURE 5-6: CHANNEL THROUGHPUT FOR DMB AND DMW PROTOCOLS.....                                  | 97  |
| FIGURE 5-7: PACKET DELAY FOR FOUR SERVICE LEVELS FOR DMB AND DMW PROTOCOLS.....                | 98  |
| FIGURE 5-8: MEAN PACKET DELAY FOR DMB AND DMW PROTOCOLS .....                                  | 99  |
| FIGURE 5-9: TOTAL NETWORK ONU'S PACKET LOSS FOR DMB AND DMW PROTOCOLS .....                    | 100 |
| FIGURE 5-10: IDLE BANDWIDTH BETWEEN CYCLES FOR DMB AND DMW ALGORITHMS.....                     | 101 |
| FIGURE 5-11: AVERAGE CHANNEL THROUGHPUT FOR DMW UNDER DIFFERENT SAFETY MARGIN<br>VALUES .....  | 102 |
| FIGURE 5-12: MEAN PACKET DELAY FOR DMW UNDER DIFFERENT SAFETY MARGIN VALUES.....               | 103 |
| FIGURE 5-13: AVERAGE CHANNEL THROUGHPUT FOR DMW UNDER DIFFERENT SIMULATED TIME<br>VALUES ..... | 104 |
| FIGURE 5-14: MEAN PACKRAT DELAY FOR DMW UNDER DIFFERENT SIMULATED TIME VALUES...               | 104 |

|  |     |
|--|-----|
| FIGURE 5-15: AVERAGE CHANNEL THROUGHPUT FOR DMW UNDER VARIOUS NUMBER OF ONUS IN EACH SERVICE LEVEL .....   | 105 |
| FIGURE 5-16: MEAN PACKET DELAY FOR DMW UNDER VARIOUS NUMBER OF ONUS IN EACH SERVICE LEVEL.....   | 106 |
| FIGURE 5-17: PACKET DELAY PERFORMANCE FOR DMW-GPON WHEN THE PROPORTIONAL OF THE ONUS IN EACH SERVICE LEVEL FROM LOW TO HIGH IS SET TO 16:8:4:4 ..... | 107 |
| FIGURE 5-18: PACKET DELAY PERFORMANCE FOR DMW-GPON WHEN THE PROPORTIONAL OF THE ONUS IN EACH SERVICE LEVEL FROM LOW TO HIGH IS SET TO 18:8:4:2 ..... | 108 |
| FIGURE 5-19: PACKET DELAY PERFORMANCE FOR DMW-GPON WHEN THE PROPORTIONAL OF THE ONUS IN EACH SERVICE LEVEL FROM LOW TO HIGH IS SET TO 20:7:3:2 ..... | 108 |
| FIGURE 5-20: AVERAGE CHANNEL THROUGHPUT FOR DMW UNDER DIFFERENT MAXIMUM CYCLE TIME VALUES.....   | 109 |
| FIGURE 5-21: MEAN PACKET DELAY FOR DMW UNDER DIFFERENT MAXIMUM CYCLE TIME VALUES .....   | 110 |
| FIGURE 5-22: AVERAGE CHANNEL THROUGHPUT FOR DMW UNDER DIFFERENT ONU BUFFER SIZE VALUES .....   | 111 |
| FIGURE 5-23: MEAN PACKET DELAY FOR DMW UNDER DIFFERENT ONU BUFFER SIZE VALUES ...  | 112 |
| FIGURE 5-24: TOTAL NETWORK ONU'S PACKET LOSS FOR DMW UNDER DIFFERENT ONU BUFFER SIZE VALUES .....  | 112 |
| FIGURE 6-1: ONU TRAFFIC ALLOCATION IN VIEW OF THE ADMW ALGORITHM .....   | 117 |
| FIGURE 6-2: AVERAGE IDLE BANDWIDTH BETWEEN CYCLES FOR THE DMW AND ADMW ALGORITHMS.....   | 119 |
| FIGURE 6-3: THROUGHPUT PERFORMANCE FOR ADMW-GPON .....   | 120 |
| FIGURE 6-4: PACKET DELAY PERFORMANCE OF THE ADMW-GPON FOR DIFFERENT SERVICE LEVELS .....   | 121 |
| FIGURE 6-5: TOTAL IDLE BANDWIDTH PER CYCLE FOR ADMW AND DMW ALGORITHMS .....   | 122 |
| FIGURE 6-6: ONU TRAFFIC ALLOCATION WITH THE EBDMW ALGORITHM .....  | 124 |
| FIGURE 6-7: AVERAGE IDLE BANDWIDTH BETWEEN CYCLES FOR THE ADMW AND EBDMW ALGORITHMS.....   | 126 |

|   |     |
|---|-----|
| FIGURE 6-8: THROUGHPUT PERFORMANCE FOR EBDMW-GPON .....   | 127 |
| FIGURE 6-9: PACKET DELAY PERFORMANCE FOR EBDMW-GPON FOR DIFFERENT SERVICE LEVELS<br>.....   | 128 |
| FIGURE 6-10: WASTED BANDWIDTH PER EACH CYCLE FOR ADMW AND EBDMW ALGORITHM... 129  |     |
| FIGURE 6-11: WASTED BANDWIDTH BETWEEN CYCLES FOR DMB AND EBDMW ALGORITHMS ... 130   |     |
| FIGURE 6-12: THROUGHPUT PERFORMANCE FOR DMB AND EBDMW GPON .....  | 131 |
| FIGURE 6-13: MEAN PACKET DELAY PERFORMANCE FOR DMB AND EBDMW GPON.....  | 131 |
| FIGURE 7-1: PARALLEL WAVELENGTH ALLOCATION MECHANISM.....   | 135 |
| FIGURE 7-2: ONU'S TRAFFIC ALLOCATION UNDER LOW NETWORK TRAFFIC, (A) FOR SERIAL<br>WAVELENGTH ALLOCATION (SWA), AND (B) FOR PARALLEL WAVELENGTH ALLOCATION<br>(PWA). ..... | 136 |
| FIGURE 7-3: AVERAGE IDLE BANDWIDTH BETWEEN CYCLES FOR THE ADMW ALGORITHM WITH<br>PWA.....   | 139 |
| FIGURE 7-4: THROUGHPUT PERFORMANCE FOR ADMW-GPON WITH PWA.....  | 140 |
| FIGURE 7-5: PACKET DELAY PERFORMANCE FOR ADMW-GPON WITH PWA FOR DIFFERENT<br>SERVICE LEVELS .....   | 140 |
| FIGURE 7-6: AVERAGE IDLE BANDWIDTH BETWEEN CYCLES FOR EBDMW ALGORITHM WITH PWA<br>.....   | 142 |
| FIGURE 7-7: THROUGHPUT PERFORMANCE FOR EBDMW-GPON WITH PWA.....   | 143 |
| FIGURE 7-8: PACKET DELAY PERFORMANCE FOR EBDMW-GPON WITH PWA FOR DIFFERENT<br>SERVICE LEVELS .....  | 144 |
| FIGURE 7-9: AVERAGE IDLE BANDWIDTH BETWEEN CYCLES FOR ADMW AND EBDMW<br>ALGORITHMS WITH PWA .....   | 145 |
| FIGURE 7-10: THROUGHPUT FOR ADMW AND EBDMW GPON WITH PWA.....   | 145 |
| FIGURE 7-11: MEAN PACKET DELAY FOR ADMW AND EBDMW GPON WITH PWA .....   | 146 |
| FIGURE 7-12: AVERAGE IDLE BANDWIDTH BETWEEN CYCLES FOR SWA AND PWA WITH ADMW<br>PROTOCOL.....   | 147 |
| FIGURE 7-13: THROUGHPUT FOR SWA AND PWA WITH ADMW PROTOCOL .....  | 147 |
| FIGURE 7-14: MEAN PACKET DELAY FOR SWA AND PWA WITH ADMW PROTOCOL.....  | 148 |

|   |     |
|---|-----|
| FIGURE 7-15: AVERAGE IDLE BANDWIDTH BETWEEN CYCLES FOR SWA AND PWA WITH EBDMW<br>PROTOCOL ..... | 149 |
| FIGURE 7-16: THROUGHPUT FOR SWA AND PWA WITH EBDMW PROTOCOL .....                               | 149 |
| FIGURE 7-17: MEAN PACKET DELAY FOR SWA AND PWA WITH EBDMW PROTOCOL .....                        | 150 |
| FIGURE 8-1: xDMW PROTOCOL WITH COS .....  | 159 |
| FIGURE 8-2: xDMW PROTOCOL WITH EARLY COS REPORTING.....   | 160 |
| FIGURE 8-3: OLT UPSTREAM DIRECTION RECEIVER ATTRIBUTES.....                                     | 172 |
| FIGURE 8-4: OLT DOWNSTREAM TRANSMITTER ATTRIBUTES.....  | 173 |
| FIGURE 8-5: ONU NODE ATTRIBUTES .....   | 173 |
| FIGURE 8-6: ONU UPSTREAM DIRECTION TRANSMITTER ATTRIBUTES .....                                 | 174 |
| FIGURE 8-7: ONU DOWNSTREAM DIRECTION RECEIVER ATTRIBUTES .....                                  | 174 |
| FIGURE 8-8: SPLITTER UPSTREAM DIRECTION RECEIVER ATTRIBUTES .....                               | 175 |
| FIGURE 8-9: SPLITTER DOWNSTREAM DIRECTION TRANSMITTER ATTRIBUTES .....                          | 175 |
| FIGURE 8-10: ONE WAVELENGTH DOWNSTREAM LINK ATTRIBUTES .....                                    | 176 |
| FIGURE 8-11: FIVE WAVELENGTHS UPSTREAM LINK ATTRIBUTES.....                                     | 176 |

# List of Tables

---

|  |    |
|--|----|
| TABLE 1-1: BANDWIDTH/USER AND MAXIMUM REACH OF VARIOUS ACCESS TECHNOLOGIES .....     | 4  |
| TABLE 2-1: RESIDENTIAL SERVICE REQUIREMENTS .....                                    | 18 |
| TABLE 2-2: TDM-PON TECHNOLOGIES COMPARAISON .....                                    | 20 |
| TABLE 2-3: NEXT-GENERATION PON REQUIREMENTS .....                                    | 35 |
| TABLE 2-4: COMPARISON OF THE KEY CHARACTERISTICS OF NEXT-GENERATION PON OPTIONS..... | 36 |
| TABLE 3-1: DMW-GPON GRANT MASSAGE TYPES.....   | 47 |
| TABLE 3-2: DMW GPON REPORTING TYPES.....   | 48 |
| TABLE 3-3: OLT LOOKUP TABLE .....  | 55 |
| TABLE 3-4: DBA TABLE.....  | 56 |
| TABLE 4-1: OLT PROCESS STATES .....  | 67 |
| TABLE 4-2: ONU PROCESS STATES .....  | 70 |
| TABLE 4-3: RECOMMENDED ALLOCATION OF BURST MODE OVERHEAD TIME FOR OLT .....          | 77 |

# Abbreviations:

---

|          |  |
|----------|--|
| 10G-EPON | 10 Gbit/s Ethernet Passive Optical Network |
| 10GPON   | 10 Gbit/s PON                              |
| ADMB     | Advantage Dynamic Minimum Bandwidth        |
| ADMW     | Advanced Dynamic Multi-Wavelength          |
| ADSL     | Asymmetric Digital Subscriber Line         |
| APON     | ATM-PON                                    |
| ATM      | Asynchronous Transfer Mode                 |
| AWG      | Arrayed Waveguide Grating                  |
| BE       | Best Effort                                |
| Bi-DMW   | Bidirectional –DMW                         |
| BPON     | Broadband Passive Optical Network          |
| CATV     | Community Antenna Television               |
| CDMA     | Code Division Multiple Access              |
| CPE      | Current Processing Environment             |
| CO       | Central Office                             |
| CoS      | Class of Service                           |
| CRC      | Cyclic Redundancy Check                    |
| CWDM     | Coarse WDM                                 |
| DBA      | Dynamic Bandwidth Allocation               |
| DBRu     | Dynamic Bandwidth Report upstream          |
| DMB      | Dynamic Minimum Bandwidth                  |
| DMW-PON  | Dynamic Multi-Wavelength PON               |

|         |  |
|---------|--|
| DMW-PWA | Dynamic Multi-Wavelength with Parallel Wavelength Allocation |
| DMW-SWA | Dynamic Multi-Wavelength with Serial Wavelength Allocation   |
| DSL     | Digital Subscriber Line                                      |
| DWA     | Dynamic Wavelength Allocation                                |
| DWBA    | Dynamic Wavelength and Bandwidth Allocation                  |
| DWDM    | Dense WDM  |
| EBDMW   | Extended Bandwidth Dynamic Multi-Wavelength                  |
| EDFA    | Erbium-Doped Fibre Amplifier                                 |
| EPON    | Ethernet PON   |
| ERDMW   | Early Reporting DMW  |
| FEC     | Forward Error Correction                                     |
| FIFO    | First In First Out   |
| FP-LD   | Fabry-Perot Laser Diode                                      |
| FTTB    | Fibre To The Building  |
| FTTC    | Fibre To The Curb  |
| FTTH    | Fibre To The Home  |
| FTTN    | Fibre To The Node  |
| FTTx    | Fibre To The (Building, Curb or Home)                        |
| FSAN    | Full Service Access Network                                  |
| GEM     | GPON Encapsulation Method                                    |
| GPON    | Gigabit-PON  |
| HDTV    | High Definition Television                                   |
| HFC     | Hybrid Fibre Coaxial   |
| IEEE    | Institute of Electrical and Electronic Engineers             |
| IP      | Internet Protocol  |



|        |   |
|--------|---|
| IPACT  | Interleaved Polling with Adaptive Cycle Time                      |
| ISP    | Internet Service Provider   |
| ITU-T  | International Telecommunication Union- Telecommunication division |
| ISDN   | Integrated Services Digital Network                               |
| LTE    | Long-Term Evolution   |
| MAC    | Medium Access Control   |
| MP2P   | Multi-Point to Point  |
| MPCP   | Multi-Point Control Protocol                                      |
| NGAN   | Next Generation Access Network                                    |
| NG-PON | Next Generation PON   |
| OLT    | Optical Line Terminal   |
| ONU    | Optical Network Unit  |
| OPEX   | Operational Expenditure   |
| P2MP   | Point to Multi Point  |
| P2P    | Point to Point  |
| PCBd   | Physical Control Block download                                   |
| PDC    | Perfect Difference Code   |
| PLI    | Payload Length Indicator  |
| PLOu   | Physical Layer Overhead upstream                                  |
| PLOAMu | Physical Layer Operations Administration and Maintenance Upstream |
| PON    | Passive Optical Network   |
| POTS   | Plain Old Telephone Service                                       |
| PTI    | Payload Type Indicator  |
| PSTN   | Public Switched Telephone Network                                 |
| PWA    | Parallel Wavelength Allocation                                    |

|       |   |
|-------|---|
| QoS   | Quality of Service                              |
| RAM   | Random Access Memory                            |
| RN    | Remote Node                                     |
| RSOA  | Reflective Semiconductor Optical Amplifier      |
| RTT   | Round Trip Time                                 |
| SCM   | Subscriber Carrier Modulation                   |
| SLA   | Service Level Agreement                         |
| SOA   | Semiconductor Optical Amplifier                 |
| SWA   | Serial Wavelength Allocation                    |
| TC    | Transmission Convergence                        |
| TDM   | Time Division Multiplexing                      |
| TDMA  | Time Division Multiple Access                   |
| TL    | Tunable Laser                                   |
| VCSEL | Vertical Cavity Surface Emitting Laser          |
| VDSL  | Very High bit-rate DSL                          |
| VoD   | Video on Demand                                 |
| VoIP  | Voice over Internet Protocol                    |
| VPN   | Virtual Private Network                         |
| US-BW | Upstream Bandwidth                              |
| WDM   | Wavelength Division Multiplexing                |
| WiMax | Worldwide Interoperability for Microwave Access |

# Declaration:

---

The following papers have been published and parts of their materials are included in the thesis:

## ***Published Papers:***

1. A. Gliwan, C.-H. Chang, Y. Shachaf, P. Kourtessis, and J. M. Senior, "Upstream Format Map Enhancements for Multi-Wavelength GPONs", in 13<sup>th</sup> European Conference on Networks and Optical Communications (NOC), Austria, Krems, 2008, pp. 75-82.
2. A. Gliwan, P. Kourtessis, and J. M. Senior, "GPON Extended Wavelength Band Overlay", in 14<sup>th</sup> European Conference on Networks and Optical Communications (NOC), Spain, Valladolid, 2009.
3. M. Milosavljevic, P. Kourtessis, A. Gliwan, and J. M. Senior, "Advanced PON topologies with wireless connectivity," in *11th International Conference on Transparent Optical Networks, ICTON 09*, Island of São Miguel, Azores, Portugal 2009, pp. 1-4.
4. A. Gliwan, P. Kourtessis, and J. M. Senior, "Dynamic Multi-Wavelength GPON (DMW-GPON) Protocol", in *London Communications Symposium 2009* UK, London: University College London, 2009.
5. M. Milosavljevic, A. Gliwan, P. Kourtessis, and J. M. Senior, "Multi-Wavelength Wireless-PON", in *12th International Conference on Transparent Optical Networks, ICTON 10*, Munich, Germany 2010.

6. A. Gliwan, P. Kourtessis, and J.M. Senior, "A G.984 GPON Exhibiting Multi-Wavelength Protocol", in *7th International ICST Conference on Broadband Communications Networks and Systems, BROADNETS2010*, Greece, Athens, 2010.

# 1 Introduction

---

This chapter provides an overview of the recent developments in access networks, leading to Passive Optical Networks (PONs) being the focus of research. In particular the Gigabit-capable PON (GPON) architecture and worldwide deployment are presented as an introduction to multi-wavelength PON topologies, the development of Medium Access Control protocols of which define this work's contribution to research. Then, in a third part, contribution of the undertaken research in GPONs is analytically demonstrated. The chapter resumes with a thesis outline.

## 1.1 *Overview of Access Networks*

While the access network or the so called last mile network, defines the connection between the end-user and the aggregation network, the access network is the bottleneck between the end-user and the core network to achieve the higher data-rates offered by the core network through the aggregation network. In some cases, the aggregation network is combined with any one of the other two networks (core and metropolitan) to reduce the infrastructure and the maintenance costs. To effectively process the very high rates available at the core network edge nodes, the existing access network needs to be improved.

Although intended for analogue voice communication over twisted-pair copper cables, the public switched telephone network (PSTN) is not developed itself to deliver transmission of data. Effectively starting from 56 Kbit/s

downstream rates, using the dialup V9.0 [1] and V9.2 modems [2] over the same voice channel, while the Integrated Services Digital Network (ISDN) [3] provided in succession a digital connection to the end-user with practical rates of at least three times the dialup speed connection. This was achieved by using one or two twisted pairs.

Aiming to provide users access to a real broadband connections, the Asymmetric Digital Subscriber Loop (ADSL) [4, 5] and Community Antenna Television (CATV) or the Hybrid Fibre Coaxial (HFC) [6, 7] technologies are capable of delivering slow Mbit/s speeds. Depending on architecture and flavour, in the case of xDSL, the coverage range for these technologies is limited from less than one kilometre from the central office (CO), with the Very High bit-rate DSL (VDSL) [6, 7] achieving a maximum of 50 Mbit/s downstream bandwidth to a few kilometres achieved with the most widely deployed ADSL [4, 5]. The fact that all these technologies were based on infrastructure built initially to carry voice or analogue TV signals and not to carry data [8, 9] is the main reason behind these limitations. As seen in Figure 1-1, DSL technology deployments in Japan for example have steadily increased in the last several years with current deployment counts topping over 14 million [10], while in USA it reached 200 million lines by the end of 2007[11].

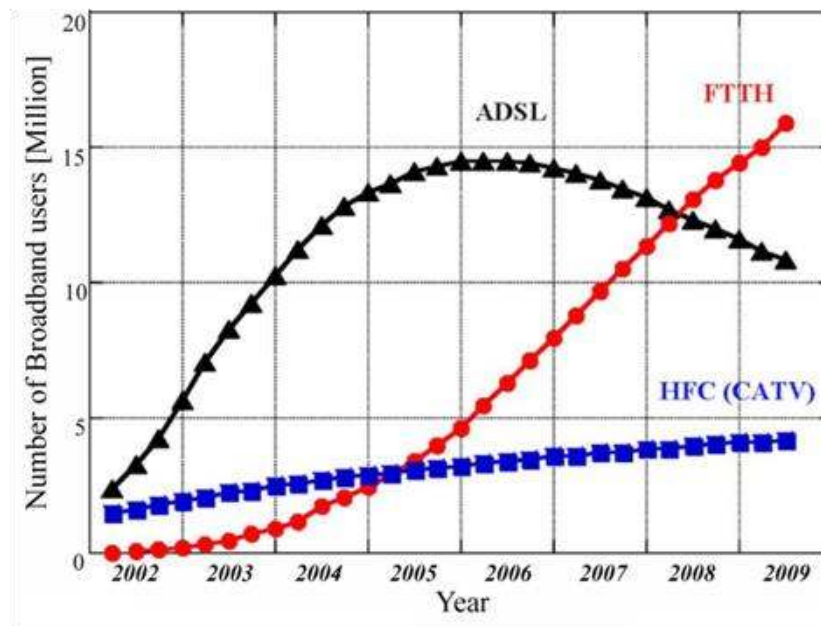


Figure 1-1: Evaluation of access network trends in Japan [10, 12]

On the other hand, passive optical network (PON) technologies have been rapidly improved to provide simplicity and to extend the achieved bandwidth in access network architectures by employing passive optical devices in the field such as passive splitters to connect the optical line terminal (OLT) in the local exchange with multiple residential and business customers [13]. PONs are expected to preserve very low operational expenditure (OPEX) as there is no need to maintain active components operation and no need to avoid malfunctions.

Compared to xDSL, Passive Optical Access Networks (PONs) could achieve aggregate rates of multiple Gbit/s for up to 20 km distances from the Central Office (CO) depending on individual standards and architectures as shown in Table 1-1 with the EPON and GPON currently, the 10GEPON and 10GPON in the short term and the WDM-PON in the future. In addition, PONs only utilise

passive components in the field to distribute or aggregate data form to the feeder fibre reducing implementation and maintenance cost. The use of a single feeder fibre between CO and the remote node (RN) also helps to reduce the infrastructure cost. Table 1 gives a comparison between the different access networks.

**Table 1-1: Bandwidth/User and Maximum reach of Various Access Technologies [14, 15]**

| Service      | Bandwidth/user | Max. Reach | Comments |
|--------------|----------------|------------|----------|
|              | Mbit/s         | Km         |          |
| <b>ADSL</b>  | 2              | 5.5        | Typical  |
| <b>VDSL</b>  | 20             | 1          | Typical  |
| <b>Coax</b>  | 2*             | 0.5        |          |
| <b>WiMax</b> | 28             | 15         | Max.     |
| <b>EPON</b>  | 60*            | 20         |          |
| <b>GPON</b>  | 40*            | 20         |          |

\*Bandwidth depends on number of users

Worldwide Interoperability for Microwave Access (WiMax) [16] and most recently Long-term evolution (LTE) and LTE advanced [17] have been considered to formulate next generation access networks for mobile end-user only for the first, and wireless and core network for the second, since they can offer to end-users flexible bandwidth and fast link adaptation [18]. Since these wireless technologies enable low-cost mobile broadband applications, further reductions in the access network infrastructure costs, in comparison to PONs [19], and the possibility for mobile and fixed broadband applications in a single air interface,



exceeding the capacity supplied currently by the fixed access ADSL networks, makes them strong competition to PONs [20-22].

## 1.2 *FTTx deployment worldwide*

The latest 2010 report from IDATE regarding Fibre To The (Building, Curb or Home) (FTTx) [23] is expected to grow steadily in the coming years to reach close to 150 million subscribers around the globe by 2014. By the end of 2009, throughout the Western, Eastern and Central Europe, there are 4.6 million FTTx subscribers, with an increase of 19% in FTTH/B subscribers between December 2008 and June 2009 in Western Europe. On the other hand, in Eastern and Central Europe the FTTH/B subscriber growth rates are higher reaching 23.5% for the same period. Currently, as a result of regulatory uncertainties, there are several fibre deployment projects in Europe, initiated both by new network operators and incumbents, mostly located in Austria, Portugal, France, and Switzerland.

The IDATE reported a noticeable number of subscribers in Asia compared to Europe with a total number of 43 million, with an increase of 15.5% in FTTH/B subscribers between 2008 and 2009, and 77.5% of the global FTTx subscribers. With 15.5 million FTTx subscribers in Japan, although initially FTTH was used only for Internet access in Japan, at present, network providers employ mainly EPON systems to provide up to 100 Mbit/s per customer focusing on triple-play services as the main drive to full-scale FTTH. With 8 million FTTx subscribers, South Korea takes second place in Asia, with triple-play services in excess of 50 Mbit/s. According to bandwidth demand, cost and future

upgradeability, wavelength division multiplexing (WDM)-PON based FTTH has been chosen to be deployed primarily although it has not been standardised yet, in contrast to the rest of Asia and the United States, capable of delivering triple-play services at symmetrical bandwidths of 155 Mbit/s per subscriber [24]. The WDM-PON provides virtual point to point connections through designated wavelengths allowing for dedicated bandwidth per subscriber, protocol transparency and increased security [25].

As of mid-2009, there were close to 6.4 million FTTx subscribers in the United States, of which 4.8 million via FTTH. In terms of subscriber numbers, this puts the USA in the third spot, behind Japan and South Korea, with an increase rate of the existing customers close to 27% in FTTH subscribers in the first half of 2009.

### 1.3 *Contribution to Knowledge*

Independently of the PON topology to be deployed in a network scenario, FTTH, FTTB, or FTTC [26, 27], a passive RN in the form of a splitter/combiner is used to broadcast downstream data to Optical Network Units (ONUs) in typical Time Division Multiplexing (TDM) PONs. Nevertheless, because of the random burst nature of each ONU transmission in the upstream direction, data collisions may occur in the shared medium between the RN and the OLT [28]. With the aim of eliminating data collisions and optimise the network occupancy, Medium Access Control (MAC) protocols are employed to supply channel access control mechanisms. Consequently and in order to manage data transmission more effectively, MAC protocols have been adopted by GPON standards. However,

they only designate the utilized MAC method, allowing for individual development and implementation of the detailed algorithms [29, 30].

In addition, the increased demand for bandwidth has accelerated the need to expand the current PON network bandwidth to 10 Gbit/s [31, 32] in line with the Next Generation Access (NGA) network requirements. In the downstream TDM-PONs use broadcasting and as a result it will be possible to increase the bit-rate to 10 Gbit/s [33-38]. However, in upstream and due to the burst nature of transmission, it will not be straightforward reaching more than 2.5 Gbit/s in the near future [39]. In that direction, the standard buddies have lately introduced their 10 Gbit/s PONs to support those demands [13, 37, 40].

Increasing network bandwidth has been achieved in various ways so far, the common one is by the application of Wavelength Division Multiplexing (WDM) [41] by means of Coarse-WDM PONs (CWDM-PONs) [24, 42], Dense-DWDM PONs (DWDM-PONs) [43, 44], or hybrids [45, 46]. In that direction, the recent ITU-T recommendation toward increasing the single-wavelength GPON capacity, G.984.5 [47], by the means of enhancing the GPON band by introducing WDM to it.

To follow the research activities toward increasing the upstream capacity, the focus of the research presented in this thesis is on data link layer of multi-wavelength GPONs with the objective to explore and develop suitable dynamic bandwidth allocation (DBA) algorithms. From the MAC Layer point of view in the main concern in WDM-PONs is the allocation of wavelengths among the network ONUs that have to be dynamic and on demand rather than static [33, 48-

53] and be able to reflect various WDM-PON architectures. While in static WDM-PONs, the entire network's ONUs are not sharing their wavelengths leading to fact that the network's wavelengths is not fully accessed and utilised by the network's ONUs. As a result, the network utilisation is limited. In order to achieve a maximum network utilisation, the network's ONUs upstream-downstream time-slot needs to be dynamically allocated in time and wavelength by the OLT.

It is rather challenging to deal concurrently with dynamic time and wavelength allocation. The main obstacle lies with the fact that ONUs can generally either transmit data on one wavelength-at-a-time or to more than one wavelength simultaneously within the time required for the laser to switch between wavelengths. The network utilisation will be improved by enabling ONUs to transmit over multiple wavelengths at a time, but that will result in increasing cost of each ONU and the OLT. In addition to the multi-wavelength MAC protocol for GPON standard compatibility implementation, and reducing the network cost as much as possible, the dynamic multi-wavelength (DMW) algorithm introduces an original bandwidth allocation among the wavelengths to achieve a maximum network utilisation. Moreover, this also provides a low mean packet delay with the lowest ONU/OLT implementation costs.

To that extent, the dynamic multi-wavelength (DMW) protocol has been developed to increase the network upstream bandwidth and introduced a multiple service levels to a FTTH-based GPON. Simulation results have confirmed a reduction of the mean packet delay by adjusting the International

Telecommunication Union-Telecommunication (ITU-T) standard GPON frame format to support the multi-wavelength function, and by contrasting the proposed scheme with the adapted Dynamic Minimum Bandwidth (DMB) GPON DMB-GPON algorithm [54, 55]. In addition, the confirmed network performance in packet delay of high service level subscribers has continued to be maintained by increasing the traffic which demonstrates the network reliability and improves the quality of the provided service according to the subscriber service level agreement (SLA).

The upstream transmission time-slots for each ONU are assigned by means of grant messages according to the report messages sent by each ONU to inform the OLT about their buffer queuing status. For the purpose of Quality of Service (QoS) optimisation and SLA performance in DMW-GPON with serial wavelength allocation (first wavelength filled first), the upstream transmission order of ONU's transmission time-slots in each transmission cycle has been dynamically modified. The purpose of this modification is to increase the upstream channel utilization rate by overlapping the last ONU (for each operating wavelength) at the end of the upstream transmission cycle. Furthermore, in that direction, in order to increase the network performance, an ONU with higher allocated bandwidth is assigned at the end of each cycle in each supported wavelength which results in reducing packet waiting time in each ONU. However, with the DMW algorithm, performance evaluation results have shown remarkable bandwidth efficiency with a significant reduction in mean packet delay and packet

loss-rate that allows efficient provisioning of high-bandwidth and time-sensitive multi-media services.

The ONUs allocated bandwidth in the DMW algorithm among the supported wavelengths is not symmetrical because of the differences in the requested bandwidth and SLA for each ONU, as a result, the maximum network utilisation is not achieved. In order to achieve the maximum network utilisation, the Extended Bandwidth DMW (EBDMW) algorithm is introduced to assign the idle time per transmission cycle in each wavelength to its assigned ONUs, which leads to increasing the assigned bandwidth width for each ONU in that wavelength by studying the EBDMW algorithm performance. Evaluation results show maximum wavelength and network utilisation with further reductions in mean packet delay and packet loss-rate.

Even supposing that the DMW algorithm with serial wavelength allocation is an efficient way to reduce the network resource usage at low network traffic, it fixes the mean packet delay for all SLA ONUs at around the maximum cycle time after the first wavelength has been fully used. In order to reduce the mean packet delay to support low delay applications such as call handover [56, 57], a DMW algorithm with parallel wavelength allocation (all wavelengths are available for service at the same time in every cycle) is implemented in the same manner. The simulation results have shown a decrease in mean packet delay at low network offered load, with a significant improvement in terms of channel utilisation rate compared to the DMW algorithm with serial wavelength allocation.

## 1.4 *Thesis Outline*

Following this introduction, chapter 2 provides a detailed review of existing PONs then focuses on the MAC layer advances in algorithm development. The GPON frame format adjustments to support multi-wavelength operation in the upstream direction over standard GPON are discussed in chapter 3. The industrial standard simulation platform OPNET Modeler [58, 59] is introduced in chapter 4 to design a platform for DBA algorithm scheduling, and accordingly implementing and evaluating the devised protocols at realistic TDM and multi-wavelength PON network traffic conditions.

The DMW algorithm and protocol evaluation demonstrating dynamicity with respect to maximum network capacity and ONU service level and buffer queuing status are described in chapter 5. At this stage, this is done by modelling a serial wavelength allocation procedure to allocate the ONU's allowed bandwidth for the coming cycle among the supported wavelengths. With the objective of enhancing the channel utilisation and of utilising the whole cycle bandwidth, the association between ONU upstream transmission order and frame idle periods is further examined in chapter 6 to establish an advanced extended bandwidth algorithm to reduce the ONU packet queuing time at upstream buffers in each data communication cycle.

To be able to achieve a fair utilization among the network wavelengths, the parallel wavelength allocation performance is introduced in chapter 7. Moreover, in order to get a better network utilization, and packet delay, the

advanced and extended bandwidth algorithms are used to allocate the ONU's traffic among the network wavelengths in a parallel manner this time.

Finally, chapter 8 presents a summary of the aspirations, contribution and developments of the research presented in this thesis followed by immediate and future research with particular emphasis on supporting class of service (CoS) over DMW-PON with improved reporting mechanisms to reduce the queuing delay.



## 2 Passive Optical Networks (PON)

---

This chapter provides a review of the existing PON standards and DBA protocols for TDM as well as multi-wavelength PON operation. Following a short introduction, the current bandwidth allocation protocols for EPONs and primarily GPONs are presented, and contrasted. Consequently, existing multi-wavelength PON protocols are explored by outlining their dynamic allocation properties to lead to the definition of the next-generation access network requirements, employed in the development of the MAC protocols presented in this thesis.

### 2.1 *Introduction*

Owing to the multi point-to-point (MP2P) upstream transmission nature of the standard TDM-PON, and in order to avoid collisions among the ONUs traffic over the feeder portion of the network, TDM-PONs need an appropriate MAC protocol to provide fair access to all ONUs. Latest studies concerning DBA algorithm development in PONs, have reported an increase in the network utilisation and a decrease of the mean packet delay with SLA [60-62]. However, the bandwidth provision per end-user is still limited due to time-sharing of a single-wavelength channel between network's ONUs.

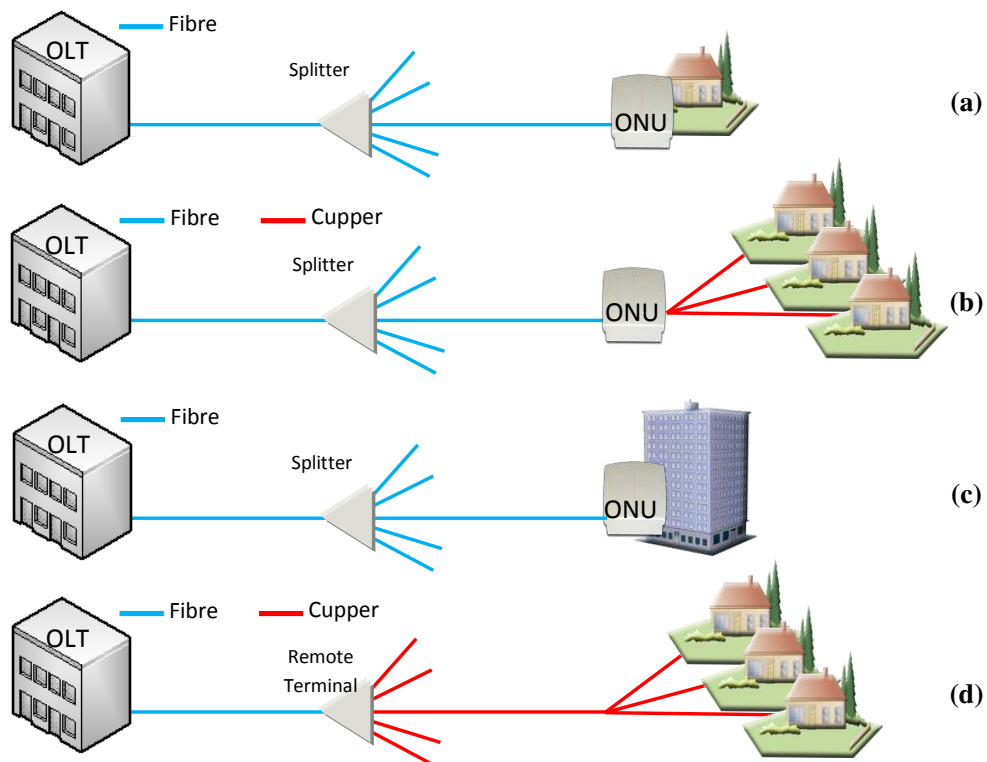
In contrast, WDM-PON forms logical point-to-point link connections between the OLT and ONUs. In addition, WDM-PONs, which are not standardised up to now [63], have been introduced as a promising technique to offer giga-bit capacity

and beyond to each ONU, increased security through the virtual point-to-point transmission links, and a guaranteed QoS. Such performance can be achieved either by using CWDM or DWDM [25]. In order to get a cost effective solution, CWDM has been recommended [42, 44, 49]. With the aim of gaining the advantage of the full potential of WDM-PON architectures to improve service provision in real time domain, and to employ the network bandwidth to its maximum, latest research on multi-wavelength GPON standard by the ITU-T has shown the possibility of increasing the upstream capacity by enabling the WDM technology by introducing the GPON recommendation G.984.5 (Enhancement band for gigabit capable optical access networks) to increase the network bandwidth [47]. In an extension to the above, the Dynamic Wavelength Assignment, (DWA) protocol has also been investigated [47] to the opposite of the static-wavelength access and at the expense of considerable increase of cost at both the OLT and ONU network elements. Accordingly, an increased-research interest in signifying dynamic access network topologies displays an increased bandwidth utilisation and network access for multiple services, scalability, and cost reductions compared to the existing infrastructures [64-66].

## 2.2 *PON architectures:*

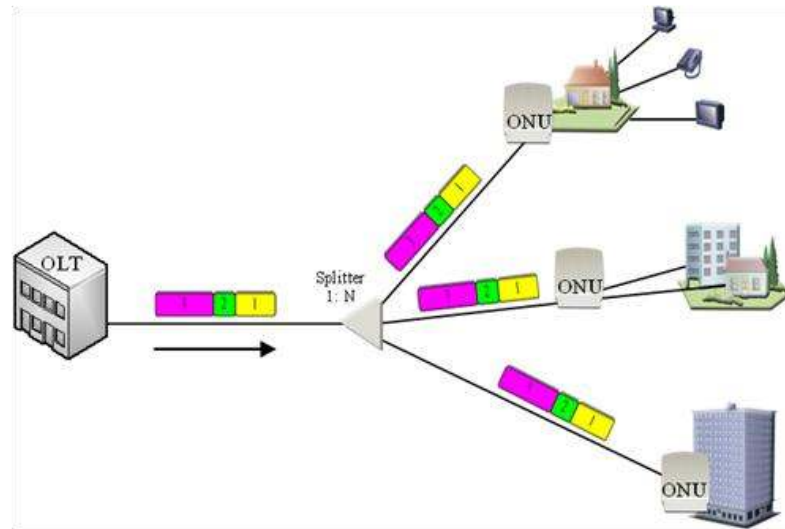
Depending on the feeder fibre penetration towards the end user, PONs can be deployed in various topologies including Fibre-to-the-home (FTTH) Figure 2-1(a), Fibre-to-the-Curb (FTTC) Figure 2-1(b), Fibre-to-the-Building (FTTB) Figure 2-1(c), Fibre-to-the-Node (FTTN) Figure 2-1(d) [28]. Although in all PON standards scenarios can provide the end-users with differential services, triple play

[67], at low costs due to the passive nature of the components used in the field [29], the total cost and end user capacity is increasingly associated with the proximity of the RN to the premises.



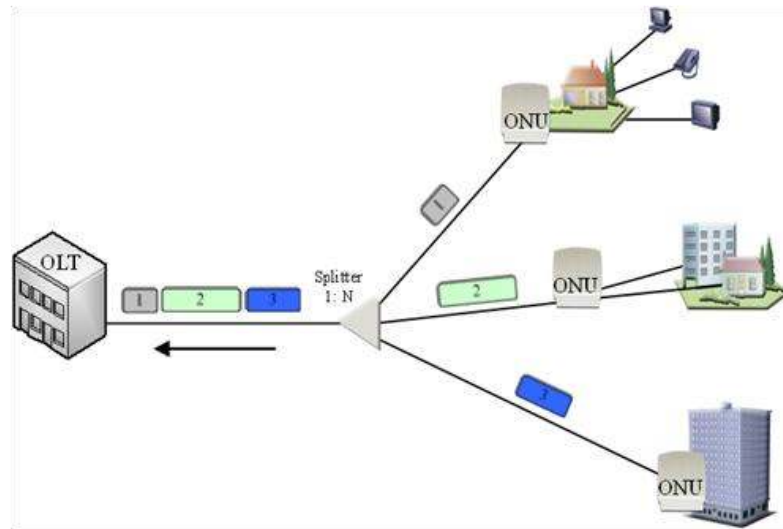
**Figure 2-1: Fibre to The X (FTTx)**

The transmission mechanism between the OLT and the network ONUs and vice versa is divided into two communication elements; the downstream transmission and the upstream transmission. The downstream transmission is represented in a broadcasting transmission from the OLT to the Network ONUs as seen in Figure 2-2. This is because it represents a Point to Multi-Point (P2MP) transmission. As a result, each ONU receives the same incoming data and only its own addressed data will be processed and the rest will be ignored [68, 69].



**Figure 2-2: Point to multi-point (P2MP) downstream transmission**

Conversely, the upstream connection represents the transmission from the Network ONUs to the OLT as seen in Figure 2-3. Due to the fact, that the fibre between the remote node RN (Splitter) and the OLT is shared in the upstream transmission among the Network ONUs, a collision may occur between ONUs upstream-data. To avoid data collision in that direction, time division multiplexing (TDM) is used to share the medium among the ONUs. At the same time, suitable MAC protocols are employed to use the upstream transmission in a more efficient way [70].



**Figure 2-3: Upstream transmission**

As shown in Table 2-1, the minimum recommended downstream bandwidth for a single residential customer to a Full Service Access Network (FSAN) with triple-play services is set at 100 Mbit/s. This includes three high-definition television (HDTV) channels of 20 Mbit/s each, symmetrical 20 Mbit/s for online gaming, three symmetrical VoIP telephone lines with 100 Kbit/s each, symmetrical 10 Mbit/s high-speed internet access, and 14 Mbit/s for Video on Demand (VoD) [71]. In contrast, the minimum required bandwidth of a residential customer upstream is about 30 Mbit/s for the current applications [71]. The required symmetrical bandwidth for a single residential customer or small business is likely to be increased to up to 100 Mbit/s in the near future [71] and this will be achieved by adding forthcoming services such as remote backup and Web 2.0 applications, while for large businesses they will require access to high symmetric bandwidths (e.g., up to 10 Gbit/s) for Virtual Private Network (VPN), disaster recovery, database storage, etc. [71, 72].

**Table 2-1: Residential Service Requirements[71, 72]**

| <b>Application</b>        | <b>Downstream<br/>requirement</b> | <b>Upstream<br/>requirement</b> | <b>Comments</b>                                  |
|---------------------------|-----------------------------------|---------------------------------|--|
| <b>HDTV</b>               | 60 Mbit/s                         | < 1Mbit/s                       | 3 HDTV per home at 20 Mbit/s<br>each             |
| <b>Online Gaming</b>      | (2 – 20) Mbit/s                   | (2 – 20) Mbit/s                 |  |
| <b>VoIP<br/>Telephone</b> | 0.3 Mbit/s                        | 0.3 Mbit/s                      | 3 Telephone lines per home at<br>100 Kbit/s each |
| <b>Data/ Email<br/>et</b> | 10 Mbit/s                         | 10 Mbit/s                       |  |
| <b>VoD</b>                | 14 Mbit/s                         | < 1Mbit/s                       | Assume DVD download must<br>take < 10 minute     |
| <b>Total</b>              | ~ 100 Mbit/s                      | ~ 30 Mbit/s                     |  |

From the potential FTTx topologies outlined in this section FTTH in particular is widely expected to meet the previously mentioned requirements in the access network for the near future, [71] especially when compared to current installed-base technologies and architectures such as ADSL and CATV, as shown in Figure 1-1.

### 2.3 *Passive Optical Network Standards*

Asynchronous Transfer Mode ATM-PON (APON) was first introduced by FSAN in mid 1990s. APONs could only support Asynchronous Transfer Mode (ATM) transmission. ITU-T standardized APONs in view of the Broadband-PON (BPON) G.983 specification series [73, 74]. BPONs use TDM to multiplex ATM

cells upstream, with 155 Mbit/s and 622 Mbit/s reported in upstream and downstream respectively. Voice and data traffic are broadcasted and multiplexed in the downstream and upstream respectively at 1491 nm and 1311 nm. A separate wavelength at 1551 nm is used to broadcast video traffic downstream [14, 75, 76]. BPONs can supply a maximum of 32 ONUs, and it can cover up to 20 km distances between the OLT and the ONUs. BPON can maintain a high level of QoS due to the propagation of ATM cells and the use of TDM multiplexing [69].

The Ethernet-PON (EPON) was first standardized by Institute of Electrical and Electronics Engineers (IEEE) in the IEEE 802.3ah standard [77]. Alongside using Ethernet frame transmission [77, 78]. EPONs to their advantage utilise IP networking audio and video streaming, at symmetrically 1.25 Gbit/s. Like BPONs, EPONs are configured in a tree topology and can cover distances up to 20 km with a maximum of 16 ONUs without using a FEC.

Gigabit PONs (GPONs) has been introduced by the ITU-T to increase the network bandwidth and decrease the cost per ONU [77]. ITU-T introduced the recommendation series G.984 for GPON [79] to overcome the limitations of BPONs. These limitations included the aggregate speed, frame format, which support for ATM cells only, and the restrictive number of ONUs. The general architecture of GPONs is the same as that of BPONs. It can support up to 64 ONUs which is the maximum physical splitting-ratio (logically can reach up to 128 ONU). The upstream bit-rate can be 155Mbit/s, 622Mbit/s, 1.244Gbit/s, or even 2.488Gbit/s, while the downstream bit-rate can be 1.244Gbit/s, or 2.488Gbit/s [69, 80-82]. Instead of employing only ATM transmission, GPONs

benefit from the GPON Encapsulation Method (GEM) [80-82] to accommodate all types of data formats (e.g. ATM, TDM, and Ethernet) [83]. Similar to BPONs, the 1480 to 1500 nm wavelength range is specified for downstream voice and data transmission and the 1260 to 1360 nm for upstream. The wavelength range 1550 to 1560 nm can also be used for RF video downstream Broadcasting. GPON transmission distances are from 10 to 20 km [81]. In summary Table 2-2 shows the key features and data transmission protocols of the major TDM-PON technologies:

**Table 2-2: TDM-PON Technologies Comparaison [69, 76, 81]**

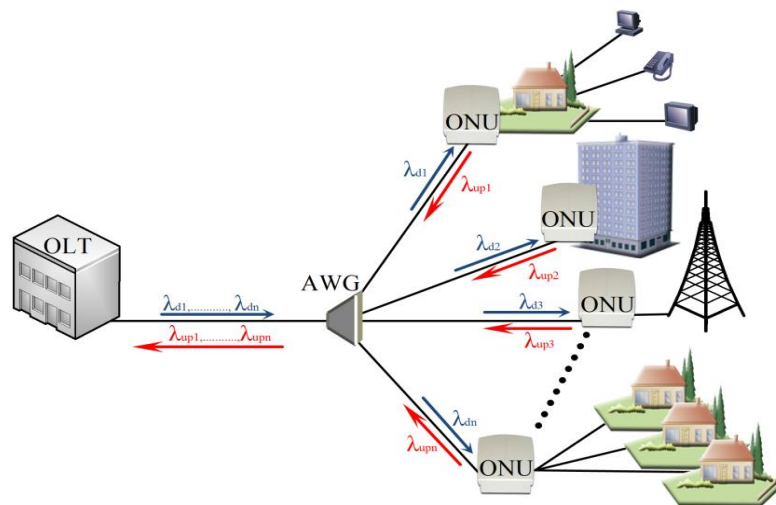
|  | <b>BPON</b> | <b>EPON</b>  | <b>GPON</b> |
|--|-------------|--------------|-------------|
| <i>Standards Family</i>                    | ITU-T G.983 | IEEE 802.3ah | ITU-T G.984 |
| <i>Frame Format</i>                        | ATM         | Ethernet     | GEM /ATM    |
| <i>Max. Upstream Speeds<br/>(Mbit/s)</i>   | 622         | 1000         | 2488        |
| <i>Max. Downstream Speeds<br/>(Mbit/s)</i> | 1244        | 1000         | 2488        |
| <i>Video</i>                               | RF          | RF/IP        | RF/IP       |
| <i>Reach (Km)</i>                          | 20          | 10           | 20          |
| <i>Split Ratio (Users)</i>                 | 32          | 16           | 64          |

Following the developments in core networks, the use of WDM in the access network has been widely considered and extensively researched [24, 25, 42]. WDM-PONs are capable of providing giga-bit capacity to each ONU, and virtual point-to-point transmission links with guaranteed QoS [16]. In particular



such performance can be achieved by using CWDM [24, 25] routing instead of DWDM [42, 84] which adds a cost-effective element to this approach.

As it can be seen in Figure 2-4, a WDM PON consists of a shared feeder fibre, between the OLT and RN, and dedicated distribution fibres connecting the individual subscribers to the RN, similar to TDM-PON architectures. The remote node consists of a wavelength multiplexer/demultiplexer implemented by a passive Arrayed-Waveguide Grating (AWG) [25]. Each subscriber is generally assigned two unique wavelengths; one for downstream and one for upstream [42, 85]. In the OLT, the WDM-PON has an array of optical transmitters and receivers with one TX/RX for each ONU.

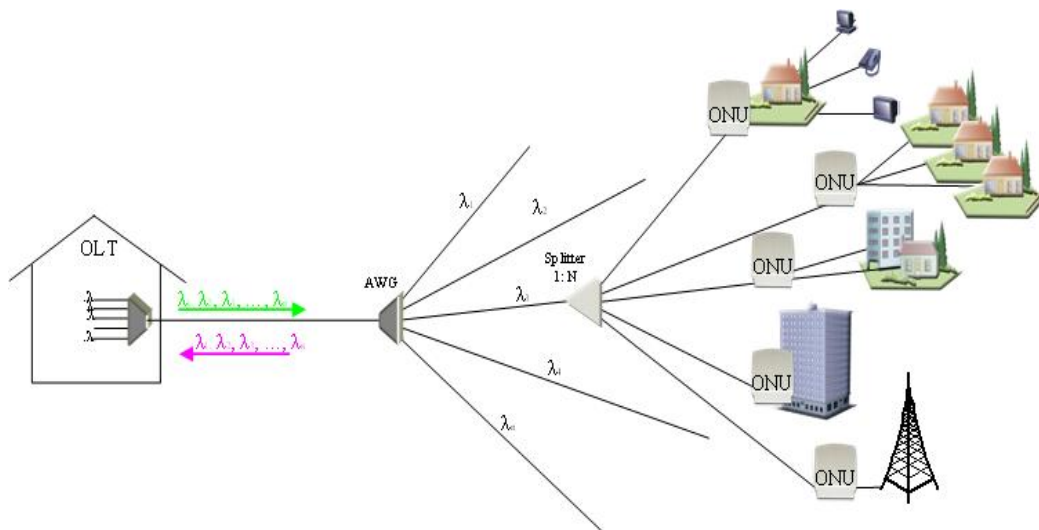


**Figure 2-4: WDM-PON**

Despite the fact that WDM PONs have many advantages such as security and high data-rate, and inevitably increase in the number of end-user supported by the network compared to TDM-PON [44], it is considered costly when it comes to practical deployment. This is mainly because of the extra costs associated with the

installation and maintenance of the wavelength-selected components such as the lasers required in the ONUs [43, 86]. To relax the requirements in DWDM PON tenability and consequently maintain lower cost ONUs CWDM could be applied [45]. The downside of this option of course would be a limitation of the network growth in terms of subscribers supported [87].

To obtain a fair compromise between the two, Hybrid WDM/TDM-PON architectures have been proposed [46] as shown in Figure 2-5.



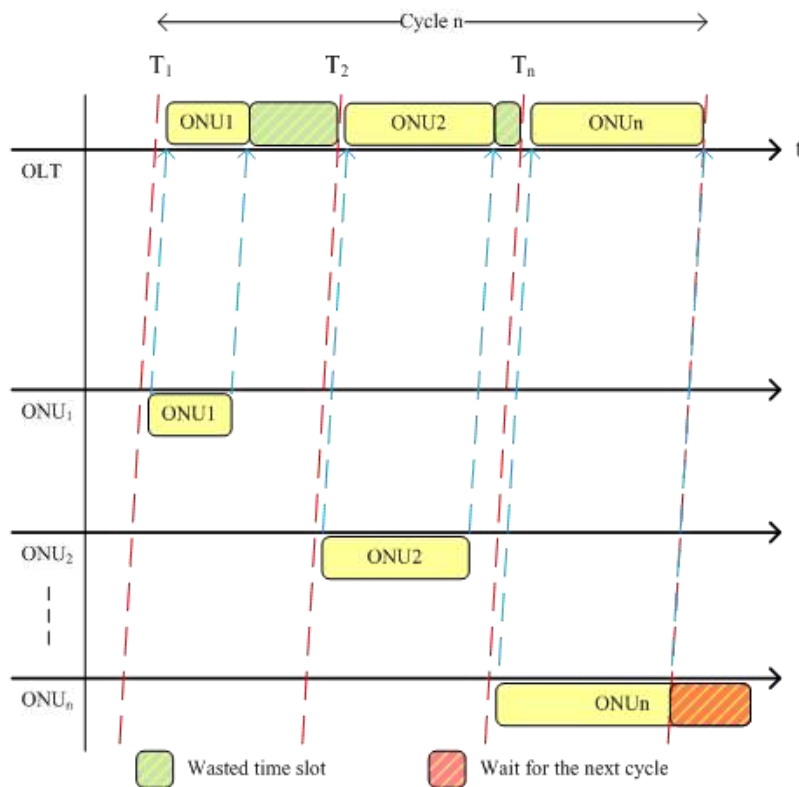
**Figure 2-5: Hybrid WDM/TDM-PON**

The OLT could allocate two wavelengths to each supported TDM-PON through a common AWG for both upstream and downstream transmission [88], in this way each TDM-PON will occupy two wavelengths from the WDM spectrum. In another approach reflective ONU are implemented based on Semiconductor Optical Amplifiers (SOA) [49-51, 89] that has a direct effect on reducing

implementation costs. This results in colourless ONUs, also providing dynamic upstream/downstream bandwidth allocation [90, 91].

## 2.4 TDM Bandwidth Allocation Protocols

The essential functionality of a TDM-MAC protocol is to assign regular time-slots to each ONU at regular periods regardless of its bandwidth requirements.



**Figure 2-6: Constant time-slot TDM MAC polling diagram**

As shown in Figure 2-6, the OLT will allocate a fixed transmission window for each ONU, which means that  $ONU_1$  can transmit between  $T_1$  and  $T_2$ , while  $ONU_2$  has the  $T_2$ - $T_3$  transmission window and so on, a practical limitation of

constant TDM protocols is the inefficiency in time-slot assignment, because it is independent of whether the ONUs are silent, or displaying low traffic load, or using moderate buffer queuing performance. Constant transmission time-slots are assigned at each cycle of operation, allowing fractions of the allocated time-slots to remain idle, while not being able to be being transferred to high bit-rate required ONUs.

It has been found that random packets will have to be buffered for various polling cycles as their capacity requirement exceeds the relative assigned bandwidth [92-97]. To defeat these drawbacks, TDM-DBA protocols have been developed by increasing the transmission efficiency and reducing the packet delay by dynamically allocating upstream time-slots according to ONUs' bandwidth demands and overall network capacity [98, 99].

#### **2.4.1 EPON Medium Access Control (MAC)**

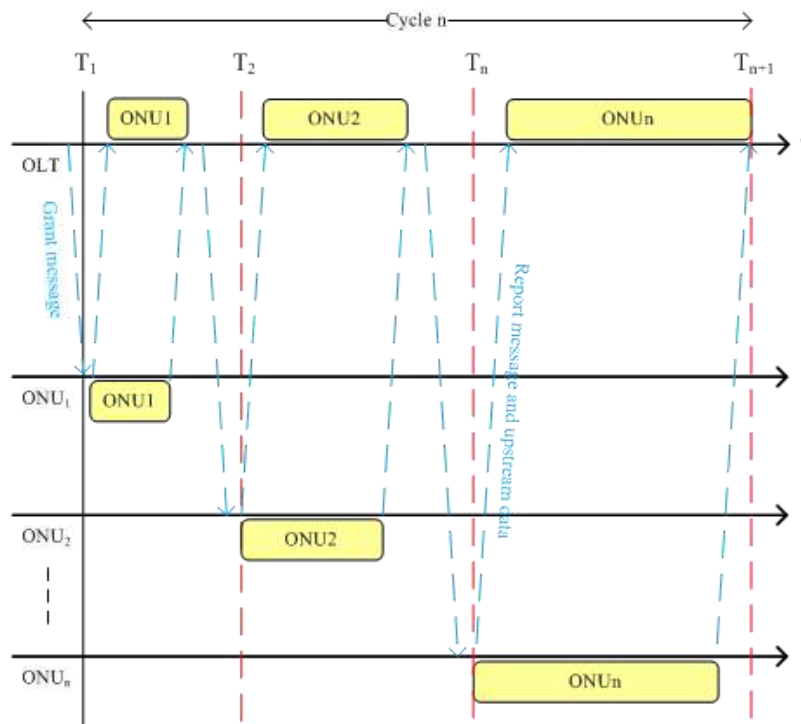
The fact that IEEE did not define any MAC protocol to be used with EPONs indicates that research and development of a standard for the EPON data link layer are left open. TDM is traditionally used to share the upstream transmission, whereby the network's ONUs have fixed time slots to transmit.

Even with fixed time-slot allocation, which gives the network ONUs fair feeder fibre access and provides QoS (since bandwidth is guaranteed to each ONU), poor network-utilisation is achieved which leads to the use of Time Division Multiple Access (TDMA) instead of TDM. Therefore, different size time-slots can be assigned to each ONU to enhance the network-utilisation [57, 99-102].

TDMA is currently the accepted MAC method for EPONs to provide FTTx services [74]. This technique relies on transmitting dedicated time slots to each subscriber. Each subscriber can then use the full upstream bandwidth of the optical link for the whole duration of its allocated time slot [103, 104]. DBA techniques have been proposed to maximize the use of the network-bandwidth to increase the ONUs bandwidth in order to reduce the transmission delay, and to provide QoS.

To schedule the upstream time-slots among ONUs accurately, a grant message is used by the OLT to inform the ONUs of the dispensed upstream time-slots which are assigned relying on the report messages sent by ONUs to inform the OLT about their buffer queuing status [105]. Nonetheless, the propagation delay of grant and report messages may impose additional bandwidth misuse that could potentially be of higher altitude to constant MAC protocols bandwidth inefficiency [99, 106-109].

As can be deduced from Figure 2-7, considerable bandwidth could be misused in each polling cycle. With the aim of increasing the upstream channel utilisation rate, an OLT-based polling scheme, known as interleaved polling with adaptive cycle time (IPACT), has been proposed for EPONs to introduce time-overlapping between the grant and report messages propagation among OLT and ONUs [99, 110].

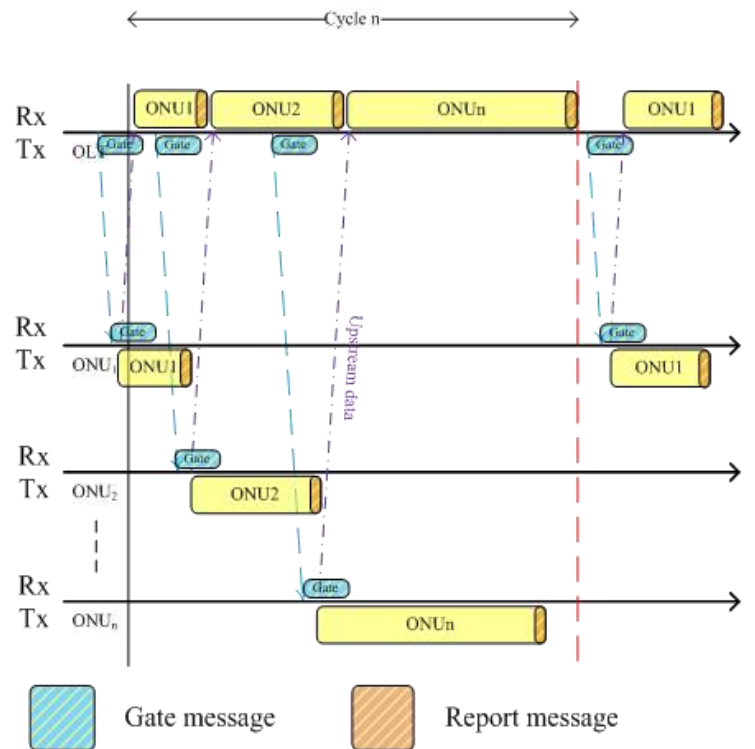


**Figure 2-7: Dynamic TDM MAC polling diagram**

IPACT [98, 99] DBA protocol as explained before and seen in Figure 2-8, is one of the protocols that is employed to direct the communication traffic between the ONUs and the OLT. It can manage the shared upstream bandwidth between the entire ONUs in order to avoid the collision between ONUs upstream data (since there are no problems in the downstream direction). Furthermore, it will help to offer a better bandwidth operation instead of using the fixed time-slot TDM-PON [98, 99, 109, 111-113].

It is known that report messages in IPACT which are representing each ONU contain information of their buffer queuing status and their RTT. According to this information, when for example, the report message from ONU<sub>1</sub> is received; the OLT estimates its upstream transmission period and the propagation delay of

the grant message for ONU. For that reason, the grant message can be transmitted and reach ONU<sub>2</sub>, before ONU<sub>1</sub> has completed its upstream transmission, which will help to prevent gathering grant and report messages intercommunication time [98, 114].



**Figure 2-8: IPACT polling diagram**

As it can be seen in Figure 2-8, the opening bits of ONU<sub>2</sub> user data in a current cycle arrive at the OLT, directly after ONU<sub>1</sub> has finished its upstream transmission with a guard time interval in between their transmission windows. Besides, IPACT limits the maximum transmission window for each ONU in order to avoid any heavy loading ONU that may occupy the medium. Accordingly, the OLT in each cycle can assign bandwidth as requested for data transmission as long as individual ONU requests do not achieve their highest limit [98, 99].

### 2.4.2 GPON Medium Access Control (MAC)

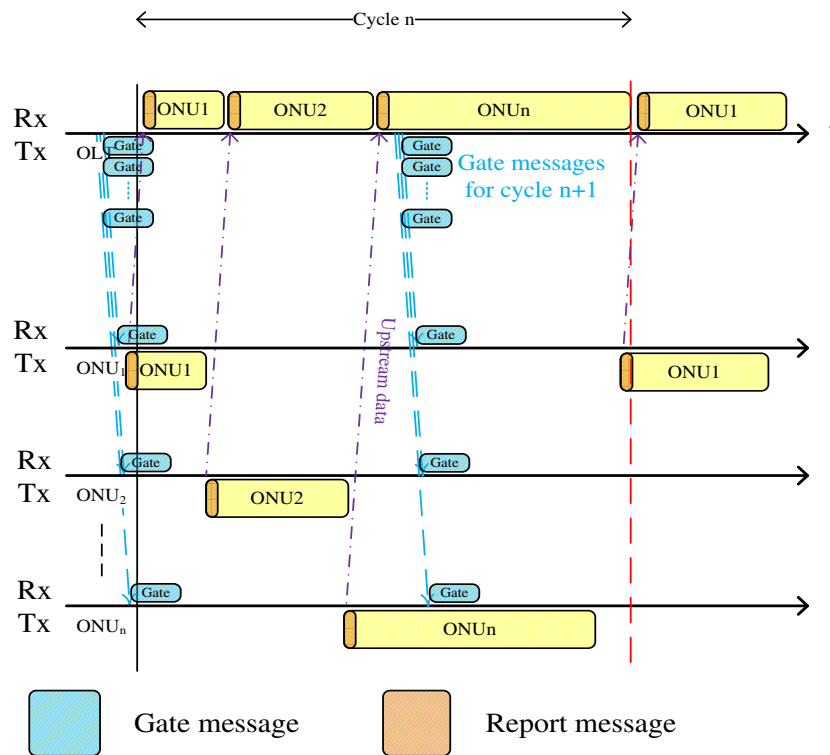
Similarly to EPONs, QoS and SLA are not defined in the GPON standard [111, 113]. For this reason, DBA protocols have been also proposed to enhance the network utilisation of GPONs [57]. For instance, there have been proposals to adapt IPACT to be applied to GPON networks [31, 57, 62, 101, 115], as a straightforward step to provide a measure of QoS and SLA. The IPACT, which offers DBA to EPONs, experiences the problem of having some limitation regarding to the QoS and the SLA. This problem leads to the fact that it can only introduce poor QoS, which causes an increase in the packet delay. On the other hand, the IPACT algorithm does not offer any SLA that it is designed for fixed aggregate bit-rate.

### 2.4.3 Dynamic Minimum Bandwidth (DMB) algorithm

The Dynamic Minimum Bandwidth (DMB) algorithm was established to provide GPONs with effective QoS and three levels of SLA based on a FTTH topology [116-118]. The operation of the DMB algorithm is offers three SLAs with bit-rates of 50, 70 and 100 Mbit/s to limited number of 16 ONUs; 14 ONUs at  $SLA_0$ , 1 at  $SLA_1$ , and 1 at  $SLA_2$  from low to high SLA respectively. As shown in Figure 2-9, time slots are distributed in two stages; at the first stage, and after the OLT has received all the ONU reports (the queuing status of each ONU), the OLT in each cycle will assign a guaranteed minimum bandwidth to each ONU according to its service level and the queuing status. If the queue length is less than the guaranteed minimum bandwidth, the OLT will supply only the queue length, and if the required bandwidth is more than the maximum bandwidth for



that ONU, the ONU will be provided with the guaranteed minimum bandwidth for its service level [57].



**Figure 2-9: DMB polling diagram**

At the second stage, the OLT will estimate the extra unused bandwidth by the ONUs and assign it to each ONU according to its service level and queuing status. That can only happen if some ONUs request less bandwidth than their maximum allowed bandwidth, which leads to allocate the extra available bandwidth the network ONUs which they require more than their maximum bandwidth by dividing it between these ONUs according to their extra bandwidth required.

At the final stage, the OLT will communicate gate messages which contain the start and stop time of each transmitting ONU to all network ONUs and at the

same time inform them of when to start transmitting and for how long, based on each ONU is assigned bandwidth [57]. By using the DMB algorithm, in addition to offering QoS and three SLAs, GPONs have demonstrated considerable packet-delay decrease compared to the IPACT algorithm [57].

As shown in Figure 2-9, the OLT in DMB algorithm starts calculating the required bandwidth after having received the last report message, at the beginning of the last ONU transmission. Because of this procedure, it has an advantage compared to IPACT since in the later; the algorithm needs to wait until the last ONU's transmission has been terminated before it receives its report message. It is after that, the OLT starts calculating the allowed bandwidth and communicates the gate messages that unavoidably will increase the idle time between cycles.

Nevertheless, even when the report messages arrive at the beginning of each ONU transmission window, another problem occurs due to the fact, that the ONU allocation order is random. That would indicate that in most cases the last ONU transmission time would be less than the sum of the time required by the OLT report processing plus the Round Trip Time (RTT), plus the ONU Gate/Grant message processing time. Consequently, this would lead to poor network-utilisation. In order to solve this problem, an advanced DMB protocol (ADMB) has been defined to additionally manage the transmission order of the ONUs by arranging the highest-traffic ONUs ( $SLA_0$ ) to transmit their data last at every transmission cycle. This procedure will lead in minimising the idle time between cycles, increasing the network utilization and of course decreasing the mean packet delay [57].

In [61, 62] the authors introduced a scheduling algorithm for GPON networks that can offer efficient operation, combining QoS differentiation with high network utilization to achieve an improved performance by making use of both fixed and dynamic bandwidth allocations along with predictive allocations based on offset-based scheduling with flexible intervals. While in [117, 119] the authors introduced a dynamic bandwidth assignment MAC protocol to facilitate the upstream channel resource sharing and to support differentiated services over GPON by using a new procedure for bandwidth reporting mechanism incorporated with bandwidth assignment protocol focusing in GPON Class of Service (CoS) improvement. In this work DMB is used as reference to implement the DMW protocol, since it offers better DBA allocation and network performance compared to the other two.

## ***2.5 Multi-wavelength Bandwidth Allocation Protocols***

It is known that WDM-PONs do not need a MAC protocol to administer the upstream transmission because of the fixed wavelength assigned to each P2P link between the OLT and ONU. The limitation in view of these established P2P links [57], would rise from the fact that the total network capacity might not be efficiently utilised in the scenario when a specific wavelength channel is not fully occupied while another wavelength may be reaching its limit or being overloaded [25, 46]. In addition, wavelengths are fixed per ONU not allowing for wavelength reuse if available and as result dynamicity. These limitations would imply a Dynamic Wavelength Allocation (DWA) protocol would be required that apart

from the already inherited QoS will allow for SLA and CoS differentiation to be considered.

Research in WDM-PONs has been primarily focusing on the physical layer targeting the reduction of cost and the enhancement of network transmission rates [42] and scalability by increasing the network split ratio [27, 120]. Although, network dynamicity will be the outcome of an efficient MAC protocol that will employ the network resources more profitably and contribute this way to the reduction of cost as well as service differentiation [25, 94].

In general, the protocols proposed [45, 49] are based on the use of tunable transmitter and receivers or the use of different groups of wavelengths assigned to each ONU which do not allow plug and play functionalities. However, the use of Reflective Semiconductor Optical Amplifiers (RSOAs) at the ONU can offer colourless ONUs and dynamic bandwidth allocation [42] at the expense of limiting bit-rates and the use of AWGs that restrict network flexibility. In such cases resource sharing in general does not follow the trend of dynamically utilising bandwidth between ONUs, but due to the network reflectivity dynamic allocation is exhibited among each ONU's upstream and downstream transmissions [26, 27, 90].

In a different approach, in [42, 121], the authors have investigated a scheduling algorithm, known as online-scheduling, based on allocating upstream transmission timeslots to each ONU, on reception of their report messages, by using a grant-on-the-fly process. The OLT assigns a transmission window for the next cycle for each ONU as soon as it has received report messages from each

ONU, not having to wait for all the report packets to arrive. While the online-scheduling algorithm does not suffer from the generation of idle times by waiting for all the report messages to arrive, it assigns bandwidth based on a prediction technique that estimates the total required traffic for the next cycle based on - all network ONUs. That leads to unfair bandwidth distribution between the ONUs.

Another DWA algorithm, which is introduced in [122], uses IPACT with modifications to account for 2-dimensional scheduling [64, 93, 122-124]. WDM-IPACT or so called WDM-EPON [65, 125, 126] classifies the network ONUs according to their SLA, and collects ONUs into groups with the same SLA to share a specific wavelength. Each wavelength stands for a specific SLA. Furthermore, it provides the option to service providers to choose between tunable components or fixed arrays for transmission. Dividing ONUs into wavelengths groups according to their SLA leads to resource optimisation limitations since ONUs cannot access all existing wavelengths. On the other hand, the WDM-IPACT suffers from the limitations present in IPACT itself as outlined in previous sections and as a result still provides poor QoS and fixed aggregate data -rates.

## ***2.6 Next-Generation Optical Access Networks***

The need for next-generation PONs (NG-PON or Ng-PON) is increasing with the bandwidth demand by the end-user. This demand was maintained by the multimedia services such as HDTV, VoD, online gaming and high speed internet. To predict the bandwidth requirements for the NG-PON, the growth of the residential broadband speed demand has been approximated for the near future

[64]. As can be seen in Figure 2-10, demand per user is predicted to increase above the currently calculated 100 Mbit/s soon after 2010.

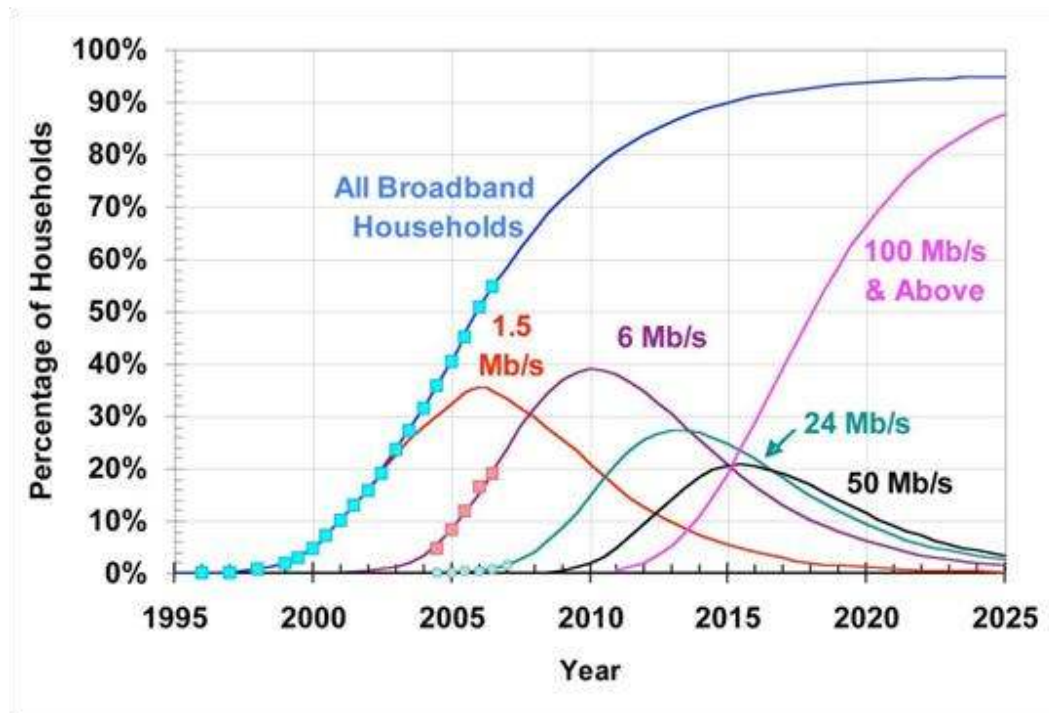


Figure 2-10: Broadband Households by Nominal Data Rate[127]

Existing PONs will not be able to support this bandwidth demand unless the service providers reduce the split ratio per PON. This would automatically increase OPEX making it an unbearable business model. In order to reach the targeted bandwidth requirements, the NG-PON has to focus on longer-term generations of PONs, bearing that in mind, the main features that define a highly scalable NG-PON [127, 128] are stated in Table 2-3. An additional point to address is that some operators are already suffering from a legacy PON problem in finding a way to upgrade their networks from BPON, GPON, or GE-PON to NG-PON, and how that will affect the existing network architectures.

**Table 2-3: Next-Generation PON requirements**

| <b>Parameter</b>           | <b>Recommended</b> | <b>Comments</b>                                     |
|----------------------------|--------------------|---|
| <b>Splitting Ratio</b>     | > 64               | Passive and high split ratio                        |
| <b>Speed</b>               | > 1 Gbit/s         | High  |
| <b>Bandwidth per User</b>  | > 100Mbit/s        | Bidirectional, Symmetrical                          |
| <b>Reach</b>               | > 20 Km            | Single fibre interface and long reach               |
| <b>Resource Allocation</b> | Dynamic            | Basic protection incorporated Simple upgradeability |

As stated in [129], a summary of the NG-PON approaches together with the key attributes is given in Table 2-4. Pure 10G PON is a realistic practical option in the future that will require effort in the optics industry to achieve the rates and the necessary optical budget. Other multi-rate 10G PON options should be able to move to an operation mode that is very close to the performance of 10G PON. On the other hand, Pure WDM has actually some interesting characteristics but requires a technology that is still expensive and relatively more complex. As a result, pure WDM PON is considered as a long-term possibility, while the wavelength stacked GPON options have many attractive features.

These are the only approaches that could effectively scale the entire installed base GPON ONUs into NG-PONs. They are cost effective, built on a known technology, and they can be implemented with only minor changes to the GPON standard. It is supposed that the last option, as shown in Table 2, presumably a DWDM stacked GPON, will be adopted by GPON operators in the near future.

**Table 2-4: Comparison of the key characteristics of next-generation PON options[129]**

| <b>Option</b>                     | <b>Bandwidth<br/>(Up/Down)</b> | <b>Changes in RN</b>                      | <b>Co-existence<br/>impact</b> |
|-----------------------------------|--------------------------------|---|--------------------------------|
| <b>Pure 10G PON</b>               | 1-10/10 Gbit/s                 | No change                                 | No                             |
| <b>Multi-rate 10G PON</b>         | 1-10/10 Gbit/s                 | No change                                 | Yes                            |
| <b>Pure WDM PON</b>               | 0.1-1Gbit/s<br>per subscriber  | WDM splitter                              | No                             |
| <b>Wavelength staked<br/>GPON</b> | 1.25/10 Gbit/s                 | Hybrid power splitter<br>and WDM splitter | Yes                            |

Consequently, and to support the next-generation optical access network, the IEEE and the ITU-T-FSAN Group have commissioned studies on the next generation of optical access networks. The results of these studies are the IEEE 802.3av 10G-EPON [40] in late 2009 and the XG-PON [36-38] with both types XG-PON1 and XG-PON2 from the ITU-T in the beginning of 2010. While both standards are sharing most of the common requirements, the upstream downstream wavelength band and the total network bit-rate, they have not defined the MAC protocol yet [13, 130-132]. Such definition process is need to wait for the Transmission Convergence (TC) layer and the frame format to be defined first to give the researchers the ability to put into practice their supported protocols.

## 2.7 Summary

This chapter presented a review of the existing TDM-PON standards e.g. EPON, GPON and their implemented MAC mechanisms to manage the upstream



data transmission. Because of the better network utilisation and lower mean packet delay compared to these mechanisms, the DMB protocol has been presented in detail as it is expected to form the basis of an original, dynamic multi-wavelength protocol to be defined and explored in this thesis.

Various solutions were reported concentrating on their principal characteristics and limitations. A MAC protocol providing network transparency, scalability and smooth migration to future access networks with dynamicity, flexibility and service differentiation should be the focus of development.

Finally, the standardisation initiatives for developing next-generation PONs, have been identified, with emphasis paid at IEEE 802.3av 10G-EPON, the ITU-T XG-PON1, and XG-PON2 to identify the key specifications to be considered when defining the protocol topology.

# 3 GPON Enhancement for Multi-Wavelength Operation

---

This chapter starts by introducing the state-of-the-art multi-wavelength PON architectures, leading to the analysis of a proposed scheme in support of Dynamic Multi-Wavelength (DMW) operation based on standard Gigabit-PONs. Successively the GPON upstream frame-format map is explored with the aim to support DMW operation in the presence of multiple service levels. Finally, a basic DMW algorithm is presented to demonstrate the protocol's feasibility in allocating bandwidth in both the time and wavelength domains.

## 3.1 *Introduction*

Dynamic multi-wavelength (DMW) operation in the PON infrastructure can be achieved by one of two possible scenarios; either by introducing a completely new DMW-PON infrastructure, or by upgrading the existing single-wavelength PONs. For the later, the GPON or EPON scalability to multi-wavelength operation should be performed on an ONU per ONU basis following individual end-user request or service provider initiatives. As a result, smooth network upgrading can be realised with the minimum disruptions to service provision in addition to providing the convergence sought by providers for economic reasons between legacy PONs and next generation networks [25, 48].

This thesis is looking into the provision of several Gbit/s bandwidth to each subscriber and the development of protocols and algorithms capable of achieving that service differentiation. Dynamicity in the wavelength allocation between ONUs is of critical importance and a fully multi-wavelength network should be implemented, the new DMW-PON infrastructure will be presented.

### 3.2 *Multi-wavelength PON Architectures*

Crucial in enabling dynamic wavelength allocation among network ONUs in WDM-PONs is to maintain low network complexity and low costs. One of the first hybrid TDM/WDM architectures is the one known as the Stanford University Access Network with Dynamic Wavelength Allocation (SUCCESS-DWA) PON architecture [72].

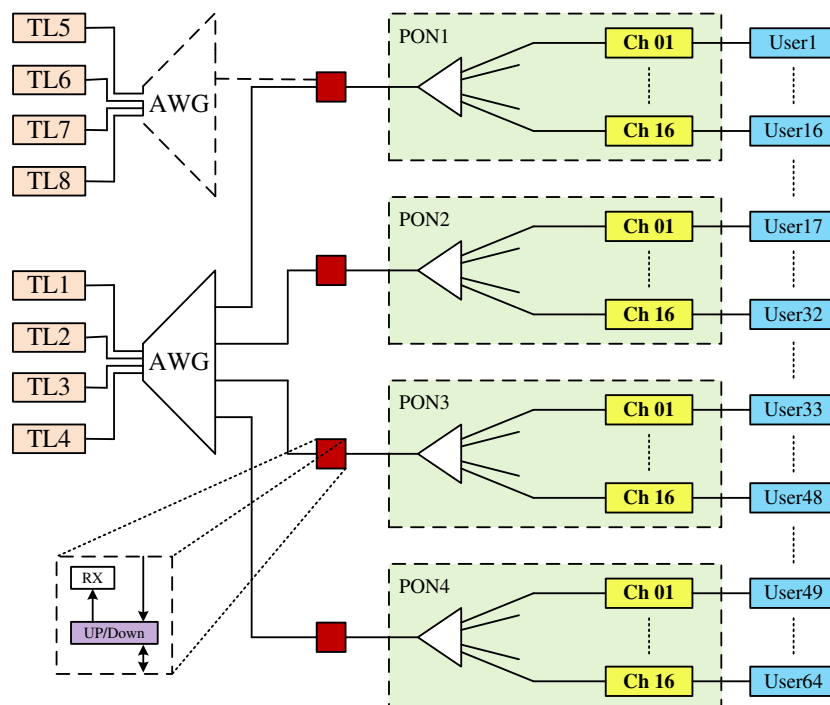


Figure 3-1: SUCCESS-DWA PON architecture [17]

The SUCCESS-DWA PON uses tunable lasers at the OLT and a tunable filter at the ONU, as can be seen in Figure 3-1, so that the OLT reaches any ONU, and each ONU can reach the OLT by hopping the wavelength between ONUs.

Even though the network throughput is increased, this is achieved at the expense of a tunable laser at the OLT and more importantly tunable filters at the ONU. Using tunable lasers puts a limit on flexibility since it indicates time-sharing of the OLT resources between the ONUs resulting to a network inefficiency.

While in [50], the authors suggested another architecture, named a Multi-PON access network based on using a coarse AWG to provide a smooth migration from TDM to WDM PON. The Multi-PON access network in Figure 3-2 is utilising CWDM to route multiple physical PON locations to a common OLT. Hence, the network will exhibit centralised wavelength assignment in the OLT; to route multiple TDM and WDM-PONs by means of a single tunable laser (TL) and receiver (RX), to manage network resources across multiple physical PONs according to traffic penetration and requirement in bandwidth. The network architecture exhibits a single 4×4 coarse AWG with a total of 16 ONUs per PON. The use of a TL in the OLT allows for cross-operation integration management of network load by dynamically assigning downstream-transmission wavelengths to each PON in tandem with continuous waves to be used by the RSOAs for upstream transmission.

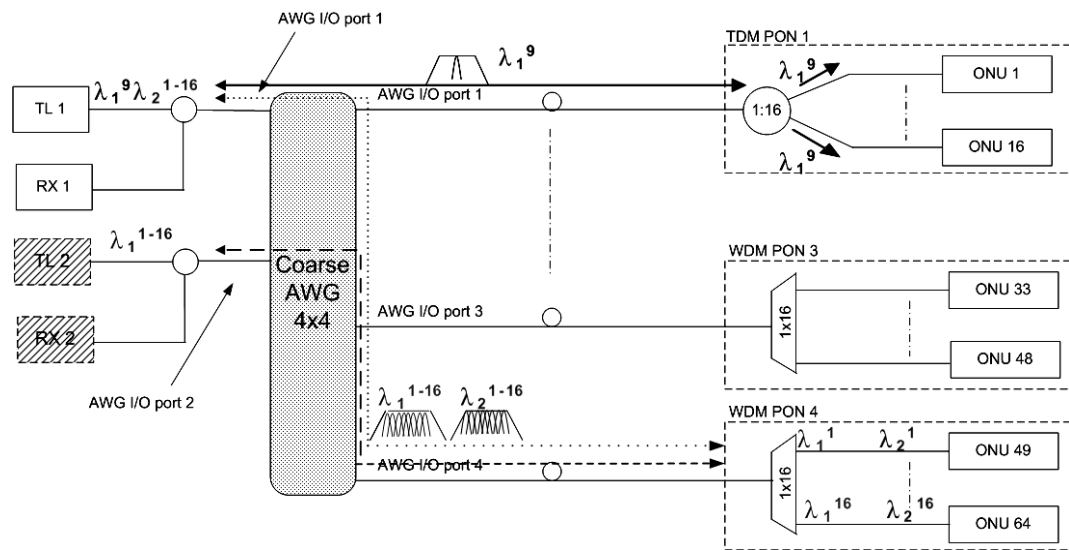
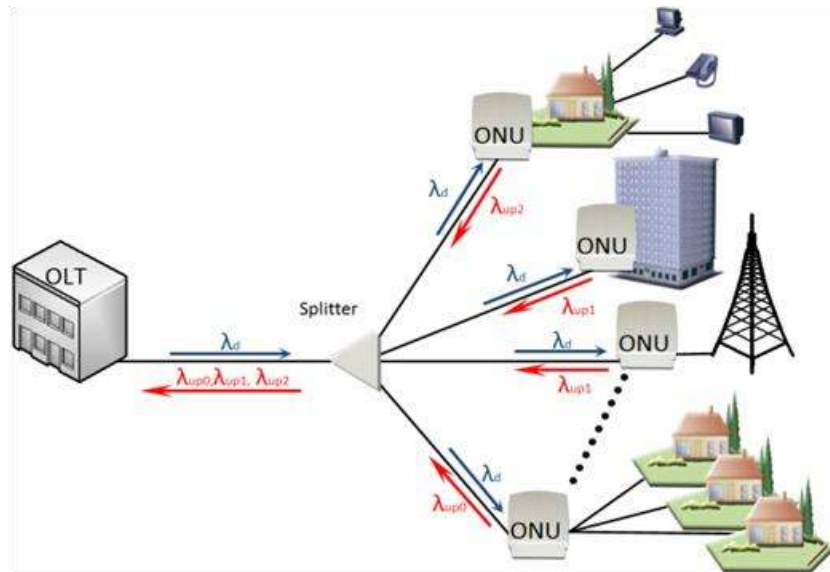


Figure 3-2: Multi-PON architecture [50]

While the use of Multi-PON architecture to upgrade the TDM-PONs to support more ONU number, and dynamic downstream/upstream ONU bandwidth were achieved, it does not provide a smooth upgrade in form of network elements, at the same time the dynamicity in the bandwidth sharing is within the ONU itself and not throughout the network wavelengths.

In Figure 3-3, the DMW-PON architecture proposed in this thesis deploys the same tree topology as in legacy PONs. An optical power splitter is still employed at the RN instead of a selective filter such as an AWG, leading to cost reductions since it maintains largely the existing PON infrastructure. Moreover, it enhances flexibility enormously since ONUs can benefit from any supported upstream wavelength without needing modifications in the remote node.



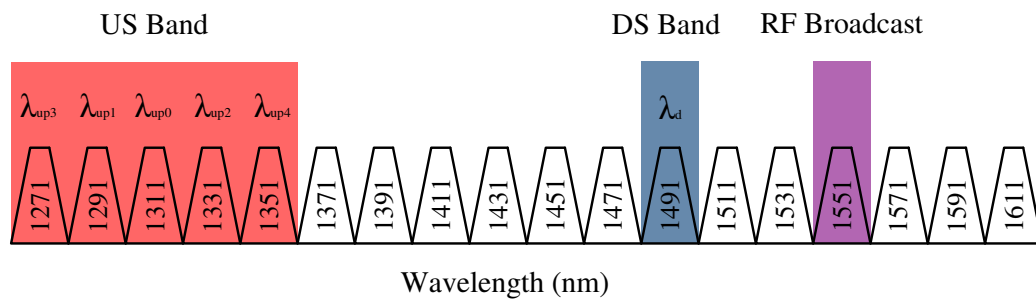
**Figure 3-3: Dynamic Multi-Wavelength PON architecture**

The standard GPON has been chosen here as the foundation protocol to develop the new DMW scheme due to its combined speed, utilization, split-ratio, and compatibility compared to other TDM-PONs [133-135]. Additionally, the GPON technology has shown a significant reduction in the power consumption and the carbon dioxide emission compared to other access networks [136, 137]. It should be noted at this stage that the 10GPON standard [36-38, 40] was not published until the very end of this work.

### 3.3 *Standard GPON frame format Adjustment*

In order to achieve multi-wavelength operations in GPONs, the upstream line-width between 1261 nm to 1361 nm defined in the GPON standard [35], was initially revised in association with the CWDM ITU-T grid [138] and DWDM ITU-T grid [139]. In this work, the CWDM grid is considered as its DWDM counterpart to demonstrate a solution with a significant reduction in the network

implementation and maintenance cost in addition to ONU complexity. It needs to be noticed that five possible CWDM upstream wavelengths from 1261nm to 1361nm can be used to support the multi-wavelength operation by overlaying the GPON upstream line-width over the ITU-T CWDM grid, as shown in Figure 3-4. The capacity enhancement offered by these five wavelengths can comfortably address the bandwidth and service requirements of FSAN with regards to Next Generation Access Network (NGAN) [128, 131, 132] as presented in the previous chapters.



**Figure 3-4: CWDM grid with GPON transmission bands**

Having identified the maximum number of the supported wavelengths for each ONU in upstream, a corresponding laser array transmitter should be implemented in each ONU's equipment. To reduce the cost, a Vertical Cavity Surface Emitting Laser (VCSEL) arrays may be used instead of Laser arrays [85]. One of these transmitters can transmit at a time in upstream at any wavelength from the supported band. For downstream, each ONU will utilise only one receiver since a single-wavelength is broadcasted similar to the standard GPON, as it can be seen in Figure 3-4. At the OLT side, instead of having a time-shared optical receiver, an array of five time-shared optical receivers will be required,

while the OLT downstream transmitter stays the same. As already mentioned, network dynamicity and scaling simplicity is acquired by keeping the power splitter in the RN.

To comply with the GPON standard, any additional fields required for DMW operation should fit within the GPON frame format. The main modifications made to that extent, was with relevance to the gate/grant packets in support of DMW functionalities as well as the reporting mechanism used to register the supported wavelength of ONUs during their registration process or when ONUs go online.

### 3.3.1 Transmission Convergence Layer

A GPON downstream frame format, which has a fixed 125- $\mu$ s length, is shown in Figure 3-5 [140, 141]. The frame consists of a downstream Physical Control Block (PCBd) and the payload, which is composed of a pure ATM segment, followed by a GPON Encapsulation Method (GEM) segment. The PCBd section contains the physical layer overhead information that is used to control and manage the network.

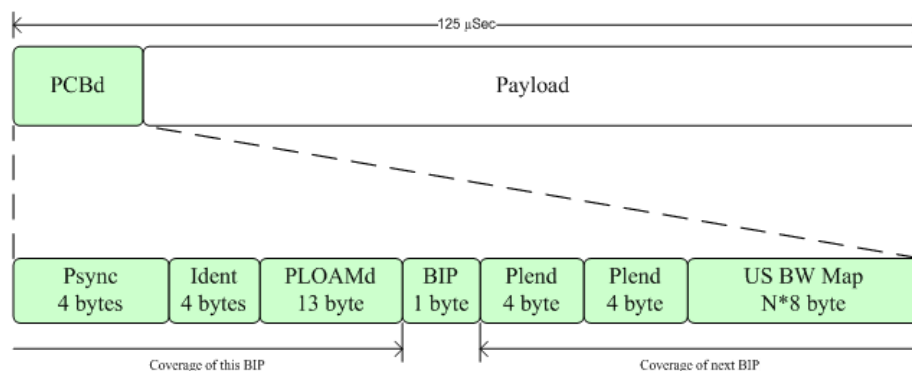
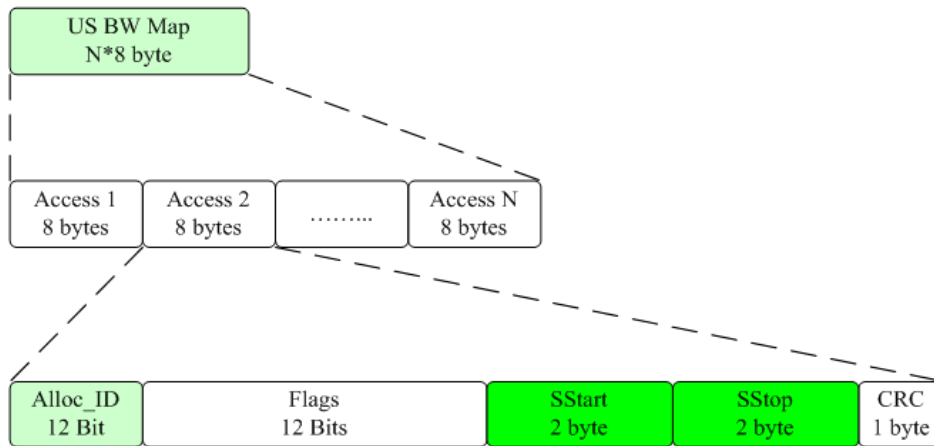


Figure 3-5: ITU-T G 984.3 Physical Control Block downstream ( PCBd) [8]



The PCBd is very important for the GPON MAC protocol because of the Upstream Bandwidth (US-BW) map which is used to allocate the N upstream transmission time slots to the operating ONUs ( For the purpose of this work, the only important field is the US-BW) as seen Figure 3-6.



**Figure 3-6: ITU-T G 984.3 PCBd US BW Map [8]**

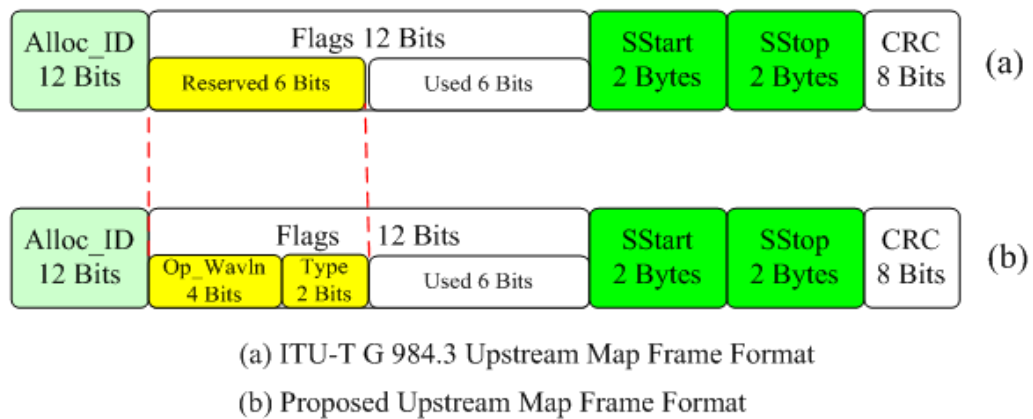
The US-BW map contains N entries associated with N time-slot allocation identifications for the ONU's buffer. As Figure 3-6 shows, each entry in the US-BW Map or in the access structure consists of:

- A 12-bit Allocation identifier (Alloc\_ID) that is assigned to an ONU.
- 12-bit Flags that allow the upstream transmission of physical layer overhead blocks for a designated ONU, only 6 bits are used.
- A 2-byte Start pointer (SStart) that indicates when the upstream transmission window starts. This time is measured in bytes.
- A 2-byte Stop pointer (SStop) that indicates when the upstream transmission window stops.

- A 1-byte Cyclic Redundancy Check (CRC) that provides 2-bits error detection and 1-bit error correction on the bandwidth allocation field.

### 3.3.2 Upstream map frame format Adjustment

To support DMW operation, two extra fields were introduced in addition to the existing field in the GPON upstream map, (Gate/Grant message). The first defines the operating wavelength, for each ONU for the coming cycle. The second field is associated with the type of packet communicated from the OLT to each ONU as seen in Figure 3-7.



**Figure 3-7: DMW-GPON upstream map adjustment**

The ONU should be able to distinguish between a gate packet, registration request, or data which is used for simulation purposes. In the proposed Upstream Map frame format shown in Figure 3-7 (b) the additional fields have utilised, while the first six bits are reserved in the twelve bits flags field of the GPON format, the “*Op\_Wavln*” field occupying 4 bits, offering 16 possibilities for CWDM multiplexing as seen in Figure 3-8(b) “*Op\_Wavln*” 0000 is represents the

basic 1311 nm operating wavelength used in single-wavelength GPONs [82]. The “Type” field is defined as shown in Table 3-1.

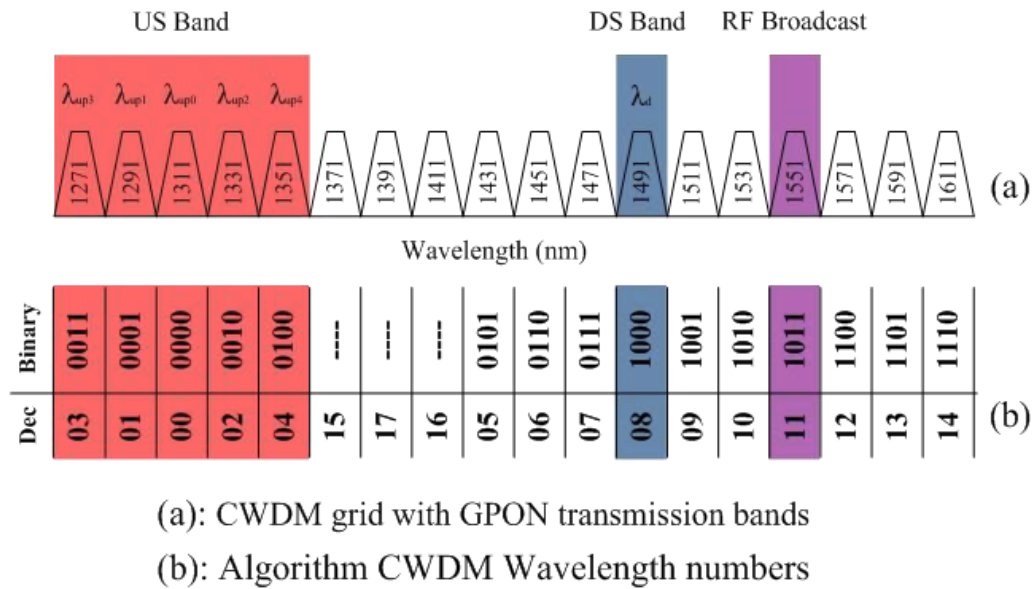


Figure 3-8: DMW operating CWDM wavelengths

Table 3-1: DMW-GPON Grant Message Types

| Type Header             | Comments  |
|-------------------------|---|
| 00 Gate                 | Used to inform the ONU about its operating wavelength and the start and the stop transmission time for the coming cycle |
| 01 Request first DBA    | Used to request the first ONU report message  |
| 10 Registration request | Used to request the ONU to transmit for the first time its supported wavelengths and the SLA                            |
| 11 Downstream Data      | Represent downstream data   |

### 3.3.3 Registration and Reporting Frame format Adjustment

The reporting mechanism between the network ONUs and OLT is revised to accommodate multi-wavelength operation. Clarification among the report message types received by the OLT in the DMW GPON is performed by means of the “*Type*” field as seen in Figure 3-9 each incoming report message as seen in Table 3-2:

**Table 3-2: DMW GPON Reporting Types**

| Type | Report Message Type                            |
|------|--|
| 00   | DBA  |
| 01   | ONU Distance ( at the beginning of simulation) |
| 10   | ONU Supported Wavelengths                      |
| 11   | Not used                                       |

Because of the fact that the distance between the OLT and the ONUs is not fixed, this option will need to be used during the simulation to make the simulated network nearer to the real network and to enable the OLT, after receiving all the report messages from the network ONUs, to calculate the normalized RTT that will be used during the simulation as seen in Figure 3-9(b).

Following the sequence of events in the reporting stage, during the ONU registration, an ONU will need to inform the OLT about its supported wavelengths. By using the GPON report message “*Type*” 10, beside the use of two bits to use for the ONU’s SLA, the registration report message will provide six fields of four bits each to register the ONU wavelengths; This adjustment will

allow each ONU to support logically an array of six wavelengths out of the sixteen CWDM wavelengths spectrum as describe in Figure 3-9 (c).

In Figure 3-9 (d), by setting the report message type to zero to respond to the received Gate packet by the ONU from the OLT, the ONU responds by collecting its queue status and sending the total queue length in bytes in the length field at the beginning of the ONU transmission window. Moreover, when a report message with type zero representing a DBA is sent, the length field will be used to record the requested bandwidth by the ONU. Then based on this information, the OLT will calculate to assign the allowed bandwidth to each ONU for the coming cycle.

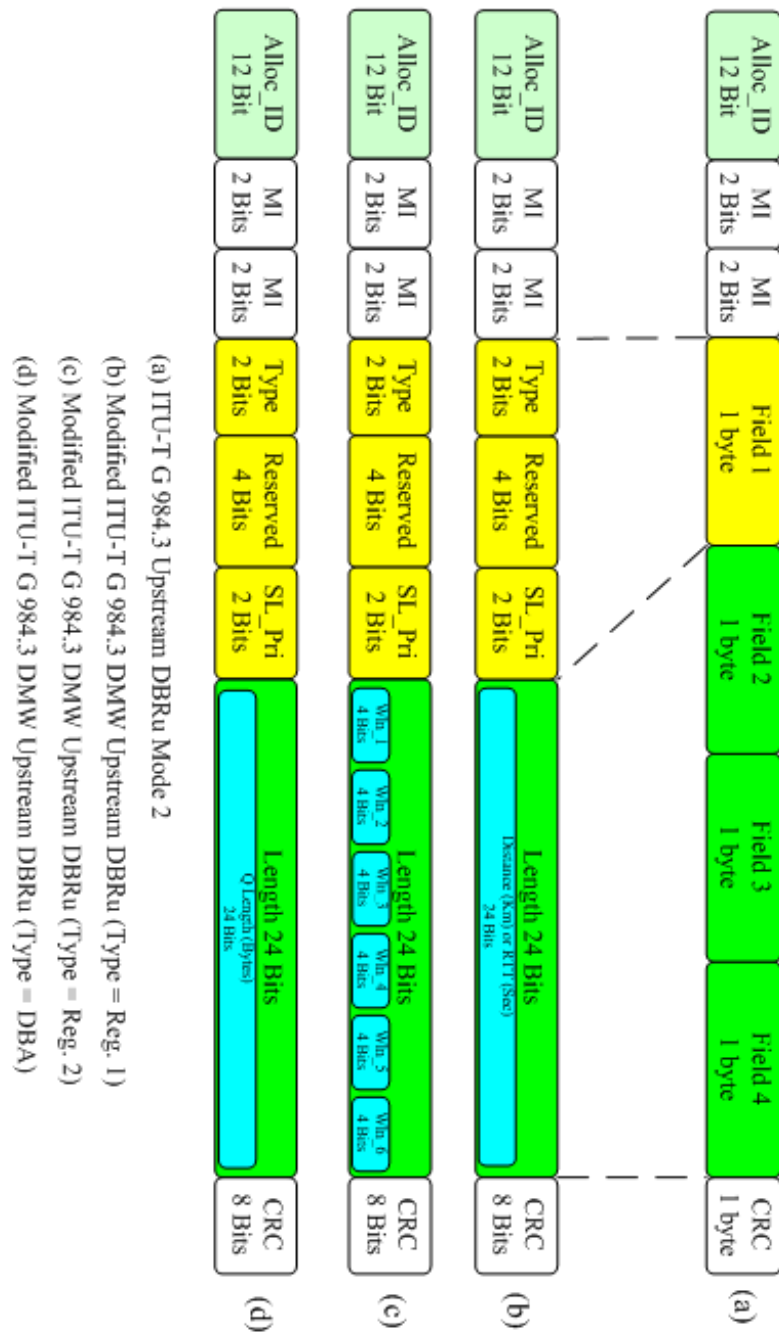


Figure 3-9: GPON Reporting Frame Format Adjustments

### 3.4 *Dynamic Multi-Wavelength (DMW) Protocol*

#### 3.4.1 **Dynamic Multi-Wavelength Protocol Aims**

Despite the fact that the downstream transmission in the DMW protocol is still based on broadcasting, it could be straightforwardly updated to support next-generation PONs operating at 10 Gbit/s aggregate rates [81]. However, achieving 10 Gbit/s in upstream is much more complicated due to the nature of burst transmission [39]. A maximum 2.5 Gbit/s in the upstream is feasible without the need of a complex and expensive ONU. To aim higher, in view of the next-generation PON requirements, multi-wavelength operation in the upstream has been researched [64, 89, 142] and supported by the standardisation bodies such as the ITU-T [36, 37, 47] and IEEE [40, 77].

Since the new DMW, protocol would be required to dynamically allocate the upstream bandwidth in the wavelength and time domain, utilisation and enhancement of state-of-the-art protocols developed for GPONs would be a sufficient starting point. High network utilisation and low mean packet delay are still in the front of this development but should be achieved at increased upstream rates and at another dimension. To that extent, the DMB and ADMB protocols [40, 143] fully implemented and evaluated with top performance figures have formed the basis of the new protocols innovatively enhanced to account for wavelength allocation.

These protocols demonstrate three service levels ( $t$ ) at different weights ( $W'$ ), assigning to each ONU a guaranteed minimum bandwidth, ( $B'_{\min}$ ) from the

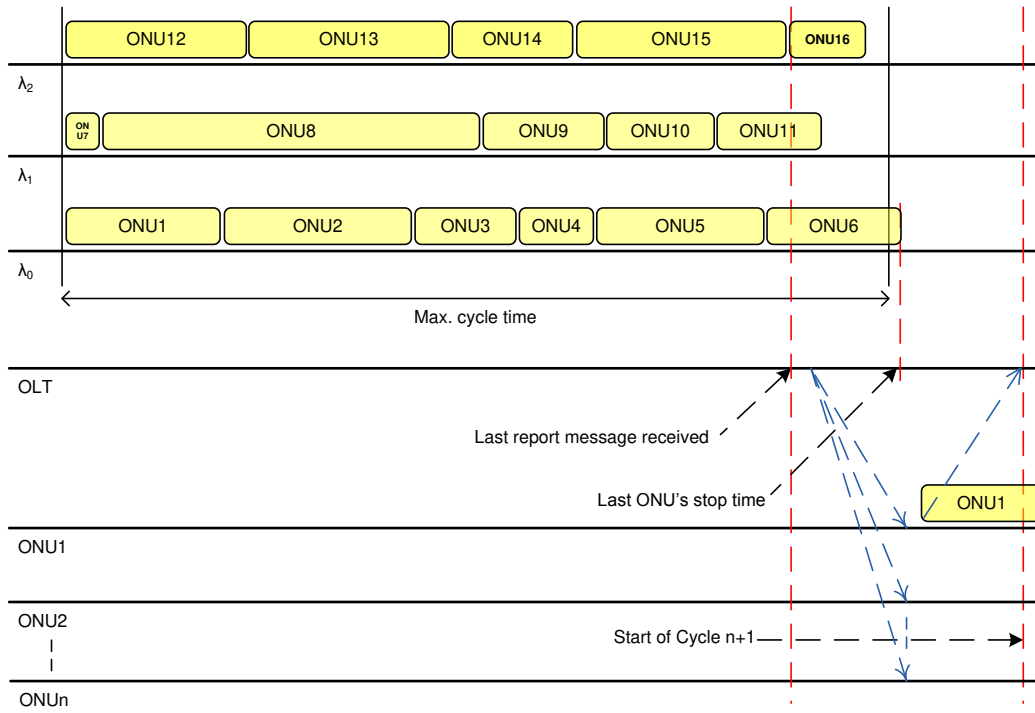
overall network capacity to suit their basic service requirements, and additional assignment of an extra bandwidth is on demand considering their SLA.

Instead of only employing three service level bandwidth agreements over a single-wavelength, a fourth service level is introduced to specify a finer ONU service requirement, and to provide an extra level of flexibility in assigning each ONU to maximum bandwidths allowed ( $B'_{\max}$ ) by means of the multiple wavelengths. A DWM protocol with three upstream wavelengths and sixteen ONU are used as an example is utilised throughout this thesis as presented in Figure 3-10.

### **3.4.2 Dynamic Multi-Wavelength Protocol basics**

The DMW protocol operates in two phases; the ONU registration phase and the transmission phase. During the registration phase that is triggered when the ONU goes online, a two-step protocol process is conducted. At first, the OLT will request that all ONUs report their supported wavelengths and SLA. This process has to be repeated each time an ONU is registered to the network (going Online). The OLT stores the reported information in a polling table, shown in Table 3-3. During step two of registration, the OLT will request each ONU to report its distance. The distance figure and the propagation delay incurred in the single mode fibre will be used to calculate each ONU's RTT and the normalized RTT for all ONUs. Having updated the polling table information filling step two, the OLT has successfully completed the registration of the network ONUs and will be able to initiate the upstream transmission scheduling.





**Figure 3-10: DMW Principle of operation**

Successively the OLT will calculate the total available bit-rate ( $R_{total}$ ) for the network based on the supported operating wavelengths and the maximum bit-rate of each wavelength ( $R_{Max}^\lambda$ ), as shown in equation (3-1).

$$R_{total} = \sum_{\lambda=0}^n R_{Max}^\lambda \tag{3-1}$$

Equation (3-2) defines the total available bit-rate ( $R_{Available}$ ) as a function of the time gap ( $R_{gap}^{GPON}$ ) required between the upstream bursts of the total network ONUs (N) and the maximum bite-rate.

$$R_{Available} = R_{total} - \sum_0^{N-1} R_{gap}^{GPON} \tag{3-2}$$

Afterwards, the OLT will calculate the maximum bit-rate allowed ( $B_{\max}^t$ ) for each ONU based on its SLA and the number of ONUs ( $ONU_{SLA}^t$ ) assigned to the same SLA.

$$B_{\max}^t = t \times \frac{R_{Available}}{ONU_{SLA}^t} \quad (3-3)$$

All these figures will be saved by the OLT in its polling table as seen in Table 3-3.

Having determined the network parameters, the OLT will request the first DBA report from each ONU to start scheduling the next cycles by assigning the total bandwidth among the ONUs. After receiving the last report message of the first DBA cycle, the OLT will calculate the total requested bandwidth ( $B_{total}^{req}$ ) from its ONUs using equation (3-4).

$$B_{total}^{req} = \sum_{ONU=0}^N B_{req}^{ONU} \quad (3-4)$$

Next, the OLT will check the total requested bandwidth ( $B_{total}^{req}$ ) from the entire registered ONUs, which indicates the latest queue length for each ONU in the polling table, and will compare it with the total available bandwidth ( $R_{Available}$ ) that is offered by the network for the upstream transmission (for all the wavelengths together). At that moment, the OLT will examine if the requested bandwidth from all ONUs is less than or equal to the total bandwidth (all wavelengths). If it is less, each ONU will get its requested bandwidth. If the total requested bandwidth is more than the available network bandwidth, the DMB [144] protocol will be applied to distribute the available bandwidth between the

ONUs. As a result, each ONU will get the maximum allocated bandwidth ( $B_{allowed}^t$ ) and later the algorithm will sort the ONUs to each wavelength as presented in Figure 3-10.

$$B_{allowed}^t = \begin{cases} B_{req}^{ONU} & \text{if } B_{total}^{req} \leq R_{Availavle} \\ B_{max}^t & \text{if } B_{total}^{req} > R_{Availavle} \end{cases} \quad (3-5)$$

Each time the OLT receives all report messages from ONUs, the requested bandwidth column in the OLT lookup table in Table 3-3 will be updated to be used by the OLT for the coming cycle bandwidth request. While the registered information such as ONU supported wavelengths, SLA, and the maximum bandwidth allowed per SLA, remains unchanged, every time a new ONU is added to the network or an existing ONU is registered to the Network (going online), the registration information for that ONU will be added to the lookup table, and the lookup table updated.

**Table 3-3: OLT lookup table**

| ONU_No. | SLA | Supported Wavelengths |   |   |   |   |   | Req_BW | BW_max | BW_rem | BW_ex_need | ONU <sub>SLA0</sub> | ONU <sub>SLA1</sub> | ONU <sub>SLA2</sub> | ONU <sub>SLA3</sub> |
|---------|-----|-----------------------|---|---|---|---|---|--------|--------|--------|------------|---------------------|---------------------|---------------------|---------------------|
|         |     | 0                     | 1 | 2 | 3 | 4 | 5 |        |        |        |            |                     |                     |                     |                     |
|         | 1   | 2                     | 3 | 4 | 5 | 6 | 7 | 8      | 9      | 10     | 11         | 12                  | 13                  | 14                  | 15                  |
|         |     |                       |   |   |   |   |   | Σ      | Σ      | Σ      | Σ          | Σ                   | Σ                   | Σ                   | Σ                   |
| 1       |     |                       |   |   |   |   |   |        |        |        |            |                     |                     |                     |                     |
| N       |     |                       |   |   |   |   |   |        |        |        |            |                     |                     |                     |                     |

After the OLT finishes the ONU's bandwidth/wavelength allocation, the DBA table as seen in Table 3-4, will be filled by the OLT by the operating wavelength and the start and stop times of each ONU for the coming cycle, then later after all ONUs upstream Map (Grant/Gate) messages are filled based on DBA table, the OLT will broadcast them to the network's ONUs in the downstream direction.

**Table 3-4: DBA Table**

| <i>ONU_Add</i> | <i>Op_Wavln</i> | <i>Up_Start_Time</i> | <i>Up_Stop_Time</i> |
|----------------|-----------------|----------------------|---------------------|
| <i>1</i>       |                 |                      |                     |
| <i>N</i>       |                 |                      |                     |

Having all these information at the OLT side, will allow the OLT to first to register every new installed-ONU or go-online-ONU, adjust the available ONU bandwidth based on the registered ONUs to the network, leading to optimising the SLA to maximise the network utilisation. In that direction, and to minimise the OLT used memory size, the allocated bits needed to store these ONU's related data in the OLT, the new introduced fields such as operating wavelength, has been considered to the minimum, while the other fields size followed the GPON requirements [80].

### 3.5 *Summary*

A number of notable initiatives have been carried out to investigate the application of multiple wavelength operation over standard splitter-based GPONs by extending the dynamic bandwidth algorithms to include allocation in the wavelength domain. For this purpose, a DMW protocol methodology and some corresponding enhancements in the GPON upstream format map have been presented to accommodate multi-wavelength operation by means of smoothly upgrading the existing single-wavelength GPON infrastructures. This has been achieved by utilising additional bits in the frame fields to define operating wavelength and packet type transfer for each ONU in addition to the SLA and buffer queuing status information provided by the already existing DBA algorithms. Therefore, the protocol is providing each ONU with the flexibility to possess normal single wavelength GPON operation as well as multi-wavelength operation.

# 4 Multi-Wavelength Network

## Simulation Model

---

Chapter 4 analyses the multi-wavelength GPON network simulation's parameters including the node and process models that are composed to implement a complete network platform over which the developed DMW algorithms are to be evaluated. In that direction, the industrial standard OPNET Modeler is utilised to design the individual network elements, packet formats and traffic models. The performance and reliability of the preliminary proposed DMW protocol presented in this chapter have been contrasted to the known single-wavelength DMB protocol to provide the feasibility study for the MAC enhancements to follow.

### 4.1 *Introduction*

The advances in photonic communication networking have been increasingly calling in the last years for sophisticated models and consequently simulation tools to be able to cope with their continuously increasing requirements [16, 71]. Reliable models with extensive modelling parameters resembling deployed networks are of escalating value in modern research for the professional concept of new solutions before implementing test-beds and

conducting field trials. Major performance improvements are often obtained in this field by mixing and joining analytic approaches with pure simulation techniques as a permanent procedure.

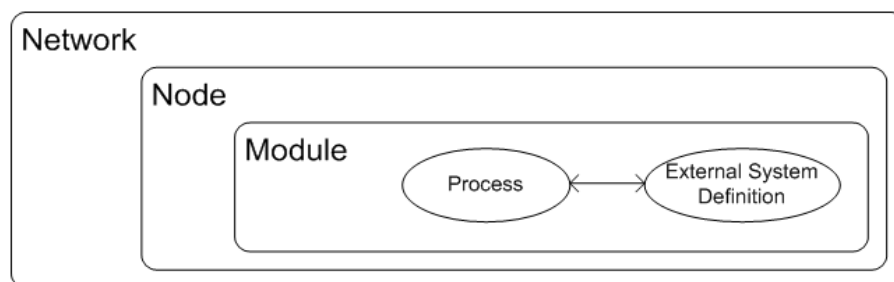
Moreover, this chapter describes the characteristics and properties of the industrial standard simulation package OPNET Modeler [116] to model typical DMW-PON logical infrastructures and subsequently assess them quantitatively by means of performing MAC algorithm simulations in the presence of GPON formatted traffic.

The most important advantage of using such an industrial standard is the opportunity for a readily available, fully deployable network and individual network's element operation characteristics that can be defined in detail with improved confidence preceding its performance evaluation. This becomes of even higher importance in networks research where real system dimensions would mean either employment of a full-scale network in the form of a test-bed or the disturbance and reconfiguration of an industrial network, which is significantly inefficient or even not possible to achieve.

There are, on the other hand, additional criteria that might affect the significance of simulations such as the cost to device a test-bed over which the developed algorithms will have to be programmed in time to give directions for network operation. In addition, a simulation platform allows the rapid re-configurability of the network architecture, time saving due to its capability to perform parallel simulations and directly applied protocol modifications. The measurability in the presence of rarely occurring effects and the reproducibility of

results in case of random measurement errors allows the replication of the exact measurement conditions that makes troubleshooting simpler.

OPNET is built on top of a separate event system and has been used as a communication network simulation platform throughout various research programmes [63]. One of its apparent advantages is that it provides a detailed modelling tool to simulate network principles by modelling each occurring event and providing the freedom to user define network elements and events alongside its inherited model libraries As it can be seen in Figure 4-1, OPNET employs a hierarchical domain structure including the project editor in the network domain to provide network connectivity, the node domain where the network node models are defined and the process domain where individual node models are programmed by means of equivalent process models to conduct specific operations.



**Figure 4-1: OPNET model levels [63]**

To start with, system designers need to define the protocol packet formats to be used in transmission in the packet editor, the transition mechanism in each process model in the process editor, the transceiver modules are used in each node in the node editor, adjust and modify the link parameters in the link editor, and



finally connect the nodes to each other using the links in the network editor. The OPNET project editor is used at the top level to complete networks which are modelled in the network domain using a combination of sub-networks, nodes and links.

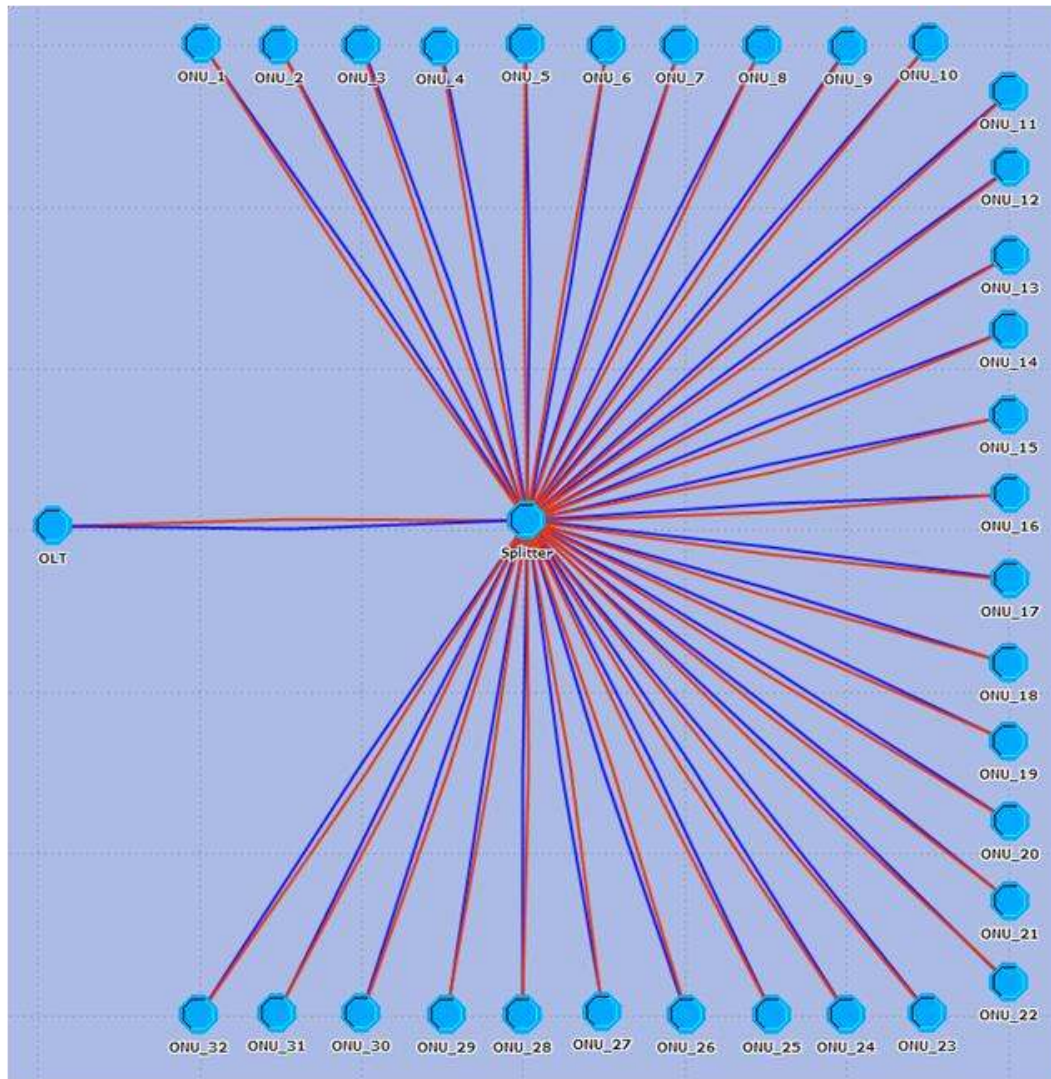
The function of each node and link are specified in the OPNET node and link editors respectively. Each node model comprises several modules that integrate various operations in a node. Some of these modules are programmed in the process domain and edited in the OPNET process editor by using C programming or by being added directly from the OPNET library. The network, node, and process modelling environments, because of their domain architecture and programmable capacity, supply users with the flexibility to easily modify network operation principles by only reprogramming or redesigning the element of significance across layers [145].

The DMB protocol presented in the previous chapter has been initially simulated and evaluated to establish a standard GPON simulation model in the OPNET network domain capable of incorporating successively a variety of processing models in the form of the later developed MAC algorithms. This was considered necessary at this stage to provide a direct comparison between the developed node models and those of the DMB protocol models adding confidence in the programming skills gained and the effectiveness particular of the OLT and ONU node models which are core to further protocol enhancements, Although the DMB protocol is intended for single-wavelength PON (GPON) applications, the associated algorithms have been directly applied to assess the

bandwidth allocation performance of the OPNET models implemented in this work, operating initially in a single-wavelength mode. This was done by redesigning the frame format and readjusting the time to transmit the grant and report messages between the OLT and ONUs according to the GPON standard [57].

#### ***4.2 The Multi-Wavelength PON project Model***

The project editor in OPNET provides the interface for network simulations by implementing the test architecture using the available network element libraries or user-defined sub-models while providing the statistics for performance evaluation. These operations are effectively compiled only in the presence of fully functional node and process editors. An example of a project editor environment is shown in Figure 4-2 displaying the logical topology representation of a standard DMW-GPON tree architecture where independent links comprising one channel and time-shared channels are used to model broadcasting in downstream and multiplexing in upstream respectively. The individual nodes presented include the OLT, ONUs and the optical power splitter. Due to the fact, the protocols investigated in this thesis are mainly focused on the management of upstream data transmission; no downstream data is generated at this stage to simplify the network simulator. As a result, only grant messages are incorporated into the OLT model, necessary to notify ONUs about their upstream transmission windows. It can also be noticed in Figure 4-2 that all the node models of the OLT, splitter and the 32 ONUs are connected to each other by using the link models for the downstream and the upstream directions.



**Figure 4-2: Overall network Model**

The functions of the basic network elements are summarised as below:

*The OLT node model:* The major functions of this node include the definition of the ONUs connected to the network, processing of the integrated MAC protocol for data exchange and finally gathering of the transfer statistics at the end of each simulation.

*The Downstream/upstream links:* These links are used to model the transmission characteristics of the feeder fibre. Specifications such as the operating data rate and propagation delay can be defined through the “attribute interface” provided by the standard OPNET library.

*The optical splitter model:* it comprises a simple mechanism by which the MAC protocol assists the splitter to deliver arriving packets to the right destination port without any delay.

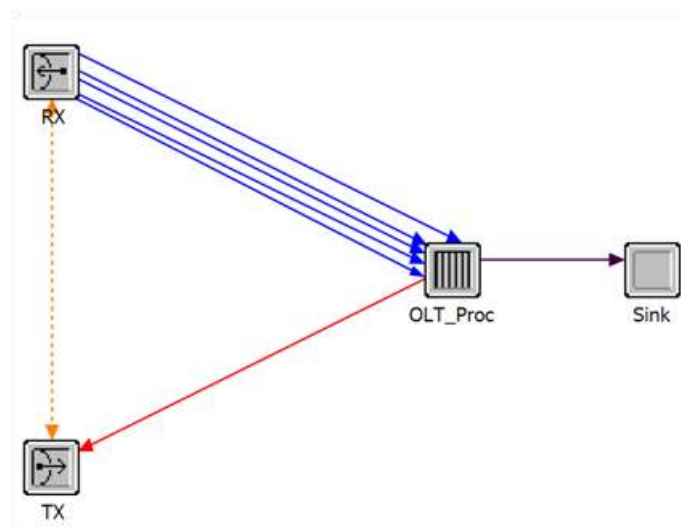
*The ONU node model:* it is designed to record the buffer queuing status and transmit data at designated upstream time-slots in addition to gathering Current Processing Environment (CPE) statistics. Depending on the network application, each ONU node model, with the assistance of the OPNET data generator module, can be programmed to sustain various traffic characteristics. For example the node model parameter known as attributes, helps initialise each ONU, identify each ONU and control its SLA as it can be seen in the appendix. To that extent, the *ONU\_ID*, *Supported Wavelengths*, and *SLA* attributes are assigned manually to each ONU in the network editor to have the ability to change these values manually as seen in the appendix Figure 8-3.

### 4.3 *OLT Node Model*

Figure 4-3 shows the OLT node structure as developed in OPNET. It includes an array of five burst-mode receivers for upstream reception to comply with the CWDM recommendation [84]. These receivers are applied to the process

model through five stream interfaces. In downstream only one transmitter is used, receiving its downstream packet from the process model.

To achieve practical multi-wavelength operation in upstream, a multi-channel receiver is used, the attributes is shown in the appendix Figure 8-3. Each channel acts individually and set to transmit at the maximum bit-rate of 1.244 Gbit/s, while in the downstream only one transmitter channel at the maximum bit-rate of 2.488 Gbit/s is used, its the attributes is shown in the appendix Figure 8-4.



**Figure 4-3: OLT node Model**

The OLT process model comprises what are known as states, each state invokes when its interrupt is called, some interrupts are based on events such as arriving packet from the ONUs, and other interrupts are based on another state code call, as shown in Figure 4-4, while the responsibility of each state is briefly described in Table 4-1.

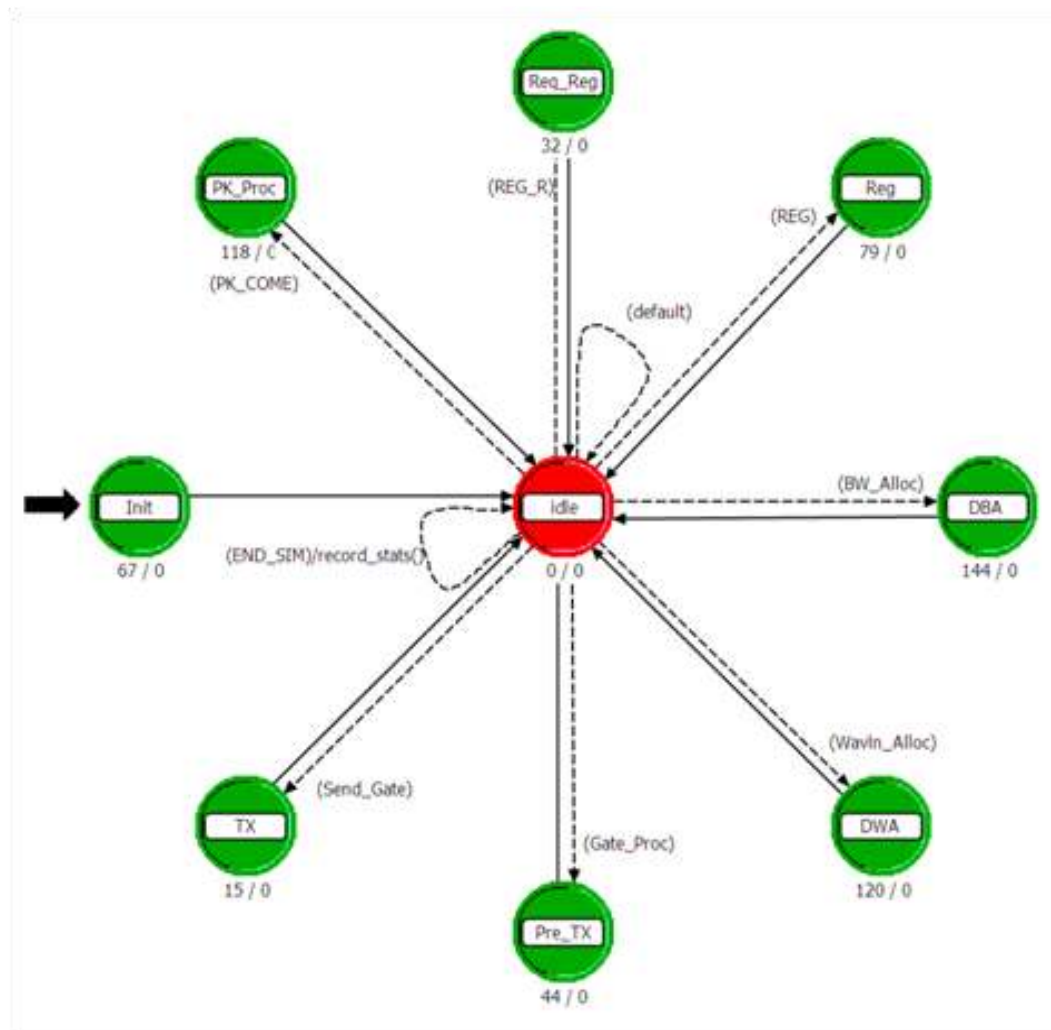


Figure 4-4: OLT process Model

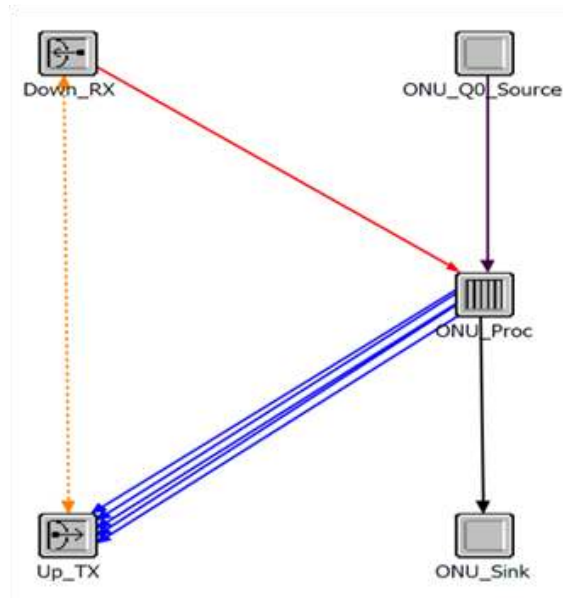
**Table 4-1: OLT Process States**

| <b>State</b>   | <b>Execution</b>  | <b>Comments</b>   |
|----------------|---|---|
| <b>Int.</b>    | Starts at the beginning of the simulation                 | Initial all values  |
| <b>PK_Proc</b> | Every time the packet arrives to the OLT                  | collecting statistics information about the arriving packets                        |
| <b>Req_Reg</b> | Start after Int. state                                    | Requesting the ONU to register their Supported wavelengths and SLA                  |
| <b>Reg</b>     | Starts after receiving the last registration report       | Calculates the total available bandwidth, and the maximum allowed bandwidth per ONU |
| <b>DBA</b>     | Starts every cycle after receiving the last report Packet | Calculates the allowed bandwidth for each ONU                                       |
| <b>DWA</b>     | Starts after DBA state every cycle                        | Assign each ONU traffic to wavelength according to its supported wavelengths        |
| <b>Pre_TX</b>  | Starts after DWA every cycle                              | Fills the gate packets  |
| <b>TX</b>      | Starts after Pre_TX every cycle                           | Sends the gate list on the downstream wavelength                                    |

#### 4.4 *ONU Node Model*

Similarly, to the OLT, Figure 4-5 outlines each ONU node structure. It comprises one multi-channel transmitter with five channels available for upstream transmission, the attributes is shown in the appendix Figure 8-6. These are designed to comply with the CWDM recommendation [84] with only one channel

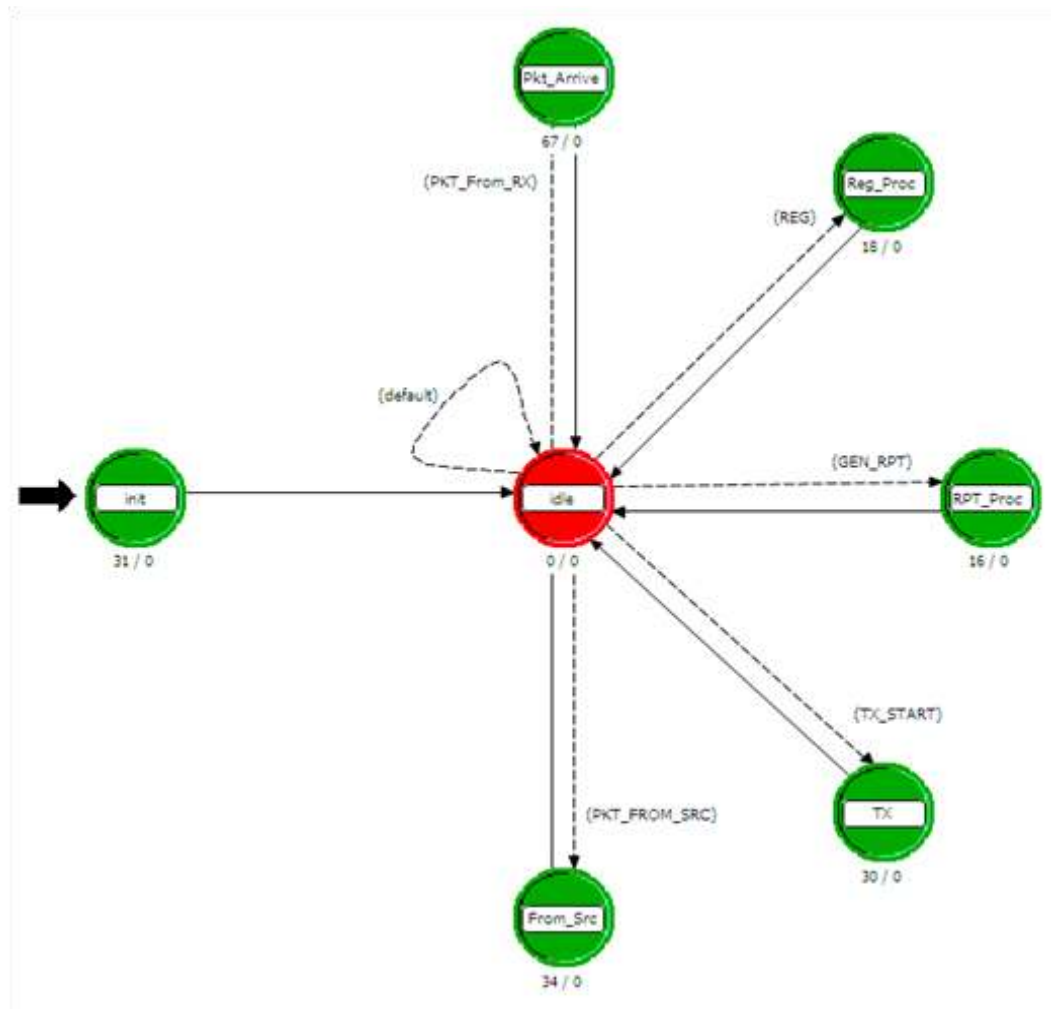
receiver required in downstream, the attributes is shown in the appendix Figure 8-7.



**Figure 4-5: ONU node Model**

In addition to the multi-channel transmitter and single receiver, the ONU functionalities include discarding of any unsaved packets when the ONU buffer reaches its capacity in addition to generating real end-user traffic with the help of a self-similar traffic source to with typical Hurst parameter 0.8, which is widely used in literature to simulate the long tailed on/off traffics representing internet traffic [146, 147].





**Figure 4-6: ONU process Model**

Progressively the ONU process block is responsible for driving all operations inside each ONU node. Figure 4-6 shows the process model and its states each time a packet arrives. The functionalities included in each state can be described in Table 4-2.

Table 4-2: ONU Process States

| State             | Execution   | Comments  |
|-------------------|---|---|
| <b>Int.</b>       | Starts at the beginning of the simulation   | Initial all values  |
| <b>PKt_Arrive</b> | Every time the packet arrives to the ONU  | Collecting statistics information and save the start and finish transmission time                         |
| <b>Reg_Proc</b>   | Start after registration request from the OLT                                       | Reads the ONU attributes and send them to the OLT to register its Supported wavelengths and SLA           |
| <b>RPT_Proc</b>   | Starts after before the ONU transmission time starts by (process time ) every cycle | Calculates the ONU buffer size and sends out the DBA report at the beginning of the ONU transmission time |
| <b>TX</b>         | Starts when the ONU transmission time starts on the assigned wavelength every cycle | Will stop the transmission at the ONU stop transmission time  |
| <b>From_Src</b>   | Starts every time a packet arrived from the source                                  | Checks the buffer if not full and puts the packet at the buffer end                                       |

#### 4.5 *Splitter Node Model*

Owing to the fact that the electrical and optical characteristics of optical power splitters do not have any effect on the data link layer, while targeting a 32-port optical power splitter, an array of 32 transmitters and 32 receivers was used

to conduct the passive splitter ports at the ONUs' side. In contrast, a pair of transmitters/receivers was used for the same purpose at the OLT side; the passive splitter model is shown in Figure 4-7.

As portrayed in appendix Figure 8-8 the attributes of each receiver port at the ONU side utilises five channels to route the upstream wavelengths toward the OLT. Each one of these five channels is routed by the splitter process model to the same channel in at the splitter output in the OLT side. Remaining in splitter, the receiver in the OLT-side receives the packets from the OLT and these packets are broadcasted by the splitter process among the 32 Splitter transmitters in the ONU side as seen below:

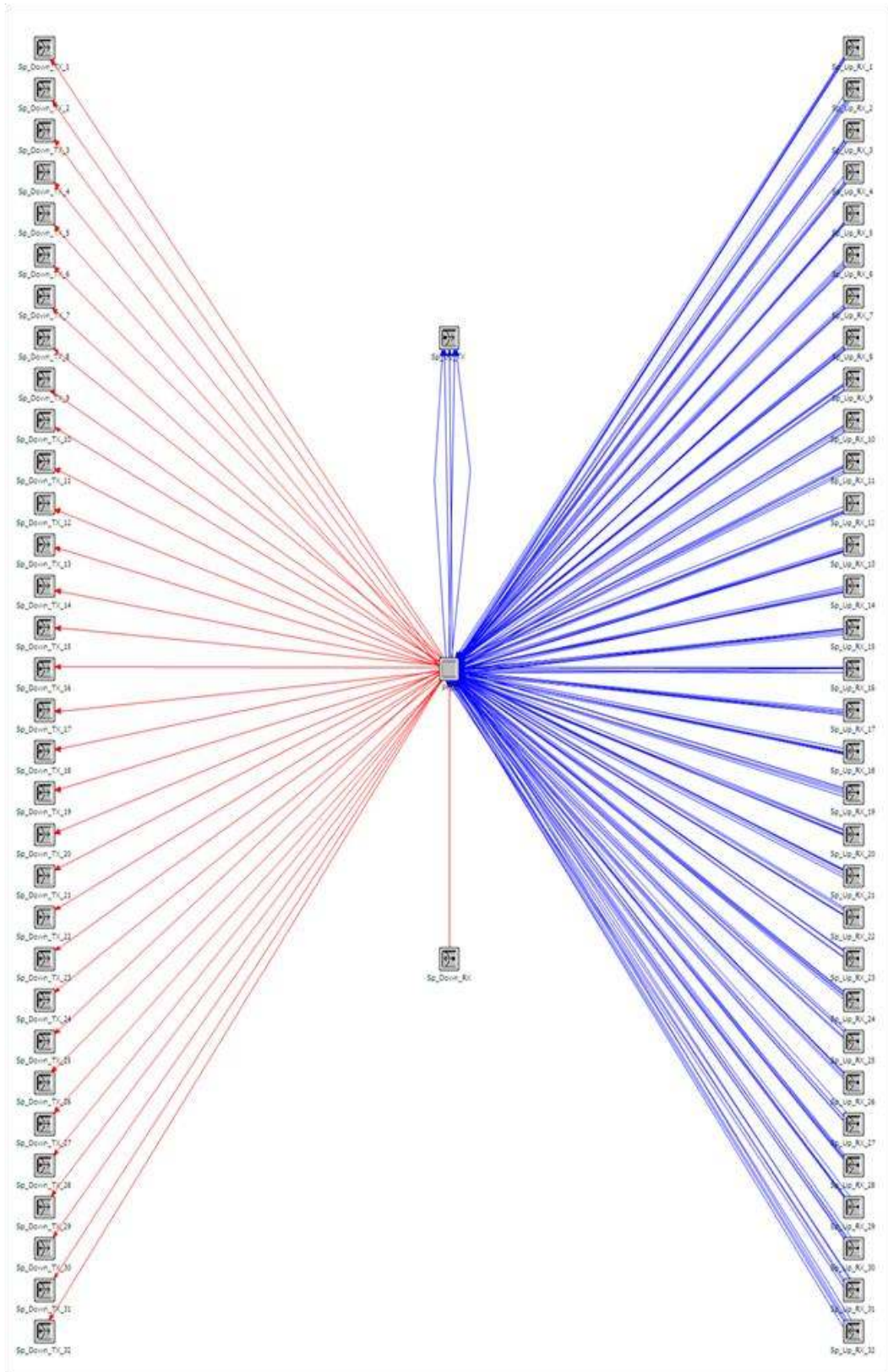
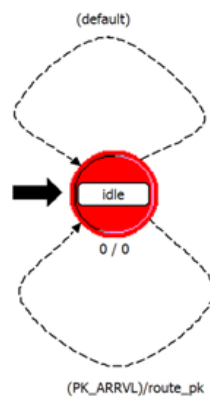


Figure 4-7: Splitter node Model

While the bit-rate attributes of Splitter transmitters are all set to 1.244 Gbit/s and 2.488 Gbit/s for the upstream and the downstream respectively, the attributes bit-rate of Splitter receivers are all set to 1.244 Gbit/s and 2.488 Gbit/s for the upstream and the downstream as seen in appendix Figure 8-9.

Subsequently packet transmission is controlled by the process model in Figure 4-8, being responsible to route packets to its appropriate destination with a zero processing delay as required to simulate the practical passive optical power splitters.



**Figure 4-8: Splitter process Model**

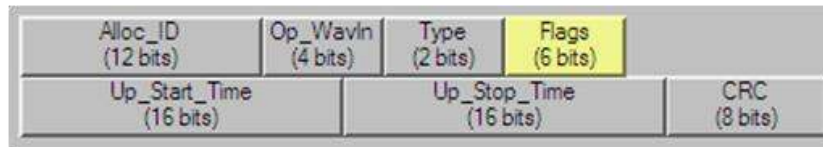
#### 4.6 *Link Model*

Two of one directional optical links were implemented to provide physical connections between the OLT, splitter and the ONUs. As expected, the downstream link utilises one channel (single-wavelength) operating at a bit-rate of 2.448Gbit/s as shown in appendix Figure 8-10. In contrast, the upstream link comprises five wavelengths at 1.244 Gbit/s each handled by the algorithm as a separate channel as seen in appendix Figure 8-11. To simplify the link model, the

propagation delay for both upstream and downstream directions is considered zero and the distance between the OLT and the ONUs is fixed to simplify the model.

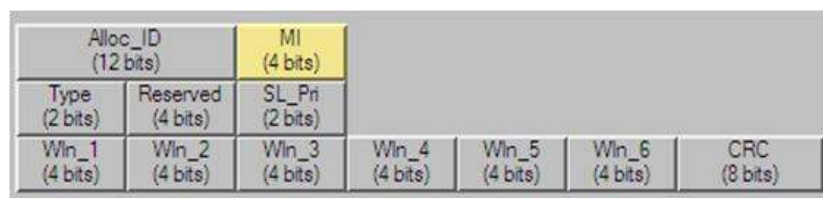
#### 4.7 DMW OPNET Frame Format

The modifications on the GPON frame format are necessary to incorporate DMW operation and provide the DMW-GPON frame format were presented in the previous chapter. The Figures below portray the implementation of these frames in OPNET with the help of the simulator's Packet Editor.



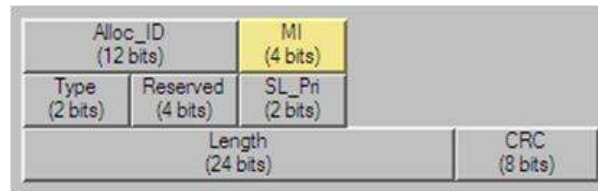
**Figure 4-9: Simulation DMW Gate Packet**

Figure 4-9 shows the simulated upstream Map (Grant/Gate) packet with its field which is used to inform the individual ONUs regarding its operating wavelength, the start and the stop of the transmission time during the simulation. While Figure 4-10 shows the registration report message packet with its SLA priority, and supported wavelengths fields, which is used at the beginning of the simulation when the ONUs go online.



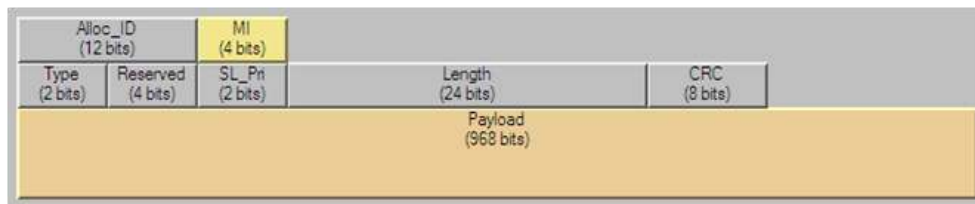
**Figure 4-10: Simulation DMW Supported Wavelength Registration Packet**

In Figure 4-11, the simulated DBA report message packet is isolated with its length field that is used by the ONU to inform the OLT about its queuing status every cycle.



**Figure 4-11: Simulation DMW ONU Report Packet**

In Figure 4-12, the simulation Data frame is seen, this frame is used by the source to randomly generate Ethernet frames in each ONU to be stored in the ONU buffer, transmitted during the transmission window of that ONU and used by the OLT later to analyse the traffic and measure the network performances.



**Figure 4-12: Simulation DMW Data Packet**

#### 4.8 *OPNET Simulation Test-Bed*

Having developed a complete OPNET model and defined a new protocol, an algorithm would have to be utilised to simulate the transmission of data and provide a valid assessment of the developed models. For this purpose, a preliminary set of simulation results were obtained in the following stages, as

already justified in the previous chapter; the application of the DMB algorithm [148]. These results were subsequently compared to the performance measures presented in literature, taking into consideration that the DMB algorithm was devised for single-wavelength GPON applications. To contrast the recorded results against published performance characteristics, the implemented network models were operated in a single wavelength mode. Having established a network performance comparison with the literature would enable the OPNET models to account for multi-wavelength operation while upgrading the DMB and ADMB algorithms into DMW algorithms with confidence.

In developing the DMW algorithms, accurate computation of the ONUs' upstream time-slot transmission, as defined in the DMB-GPON MAC, would have to be performed by determining the values of the maximum polling cycle time, the guard time between two upstream time-slots, and the RTT which are defined by the GPON standard [82]. In TDM-DBA algorithms, the maximum polling cycle time denotes the longest period ONUs would need to wait before being granted an access. If the cycle time is longer than the maximum polling cycle this would result in an increased delay in all packets, including time sensitive packets. In contrast, a short cycle time would imply unused bandwidth which in conjunction with a constant guard time, as it will be explained later, would expect to decrease the channel utilisation rate. To optimise the network packet delay and utilisation rate, the maximum polling cycle time should not exceed a typical value of 2 ms [47, 147] which is common in most published TDM-DBA protocols.



In establishing and terminating communication between the OLT and each ONU, network transceivers require time to be turned on or off, implying the requirement of a vacant time interval known as the guard-time to synchronise packet transmission and define the initiation of burst mode operation [99, 146, 147, 149] and also provide a safe guard for distorted signals. While the worst case scenario value of the guard-time in the IPACT protocol [147] for example is set at 5  $\mu$ s, GPONs operating at multiple data rates, practically require variable guard-times to match each transmission speed [98, 99]. As shown in Table 4-3, individual guard-times in GPONs are denoted in each case as “Total Time”, in units of bits, and correspond to the addition of a preamble-time, a delimiter-time and a “guard-time”. It should be noted that the term “guard-time” here is employed only to describe the time required to turn on or off the transceivers.

**Table 4-3: Recommended allocation of burst mode overhead time for OLT[150]**

| Upstream<br>data-rate<br>Mbit/s | Guard Time<br>(bits) | Preamble Time<br>(bits) | Delimiter Time<br>(bits) | Total Time<br>(bits) |
|---------------------------------|----------------------|-------------------------|--------------------------|----------------------|
| 155.52                          | <b>6</b>             | <b>10</b>               | <b>16</b>                | <b>32</b>            |
| 622.08                          | <b>16</b>            | <b>28</b>               | <b>20</b>                | <b>64</b>            |
| 1244.16                         | <b>32</b>            | <b>44</b>               | <b>20</b>                | <b>96</b>            |
| 2488.32                         | <b>64</b>            | <b>108</b>              | <b>20</b>                | <b>192</b>           |
| Notes                           | <b>Minimum</b>       | <b>Suggested</b>        | <b>Suggested</b>         | <b>Mandatory</b>     |

Having established an appropriate guard time, depending on the parameters outlined below, the RTT should be critically considered to ensure that

each upstream packet from  $ONU_i$  reaches the OLT exactly at the end of its specified RTT time. Consequently, the first packet from the following  $ONU_i$ ,  $ONU_{i+1}$  will reach the OLT with only a guard time interval delay following the last bit of information received from  $ONU_i$ . The RTT used in the simulations is calculated by taking the optical fibre propagation delay ( $T_{pd}$ ) and OLT and ONU signal processing times ( $T_s$ ) into consideration. While the optical fibre propagation delay is determined by the distance between two transceivers, the signal processing times ( $T_s$ ) in the OLT and each ONU are measured by determining the optical-to-electronic signal conversion-time ( $T_{oe}$ ) and electronic-to-optical signal conversion-time ( $T_{eo}$ ). This is specified in the GPON standard to be equal to  $(T_{oe} + T_{eo} + 2 \times T_{pd})$  with a maximum value of less than  $50\mu\text{s}$  [150].

To summarise, the GPON maximum polling cycle time is 2 ms while the guard time depends on the upstream aggregate data-rate, which can be 96 bit for 1.24 Gbit/s or 192 bits for 2.48 Gbit/s, and RTT 200  $\mu\text{s}$  for 20Km where the protocol has been applied to perform dynamic bandwidth allocation.

#### 4.8.1 DMB-GPON Modelling and Simulation Results

According to the DMB algorithm, presented in section 2.4.3, each ONU is assigned a minimum guaranteed bandwidth to satisfy its basic needs and the remaining network bandwidth is allocated to each ONU according to its SLA and queue report. This process suggests that if the bandwidth request from an ONU is less than the maximum allowed bandwidth figure, the OLT will have successfully

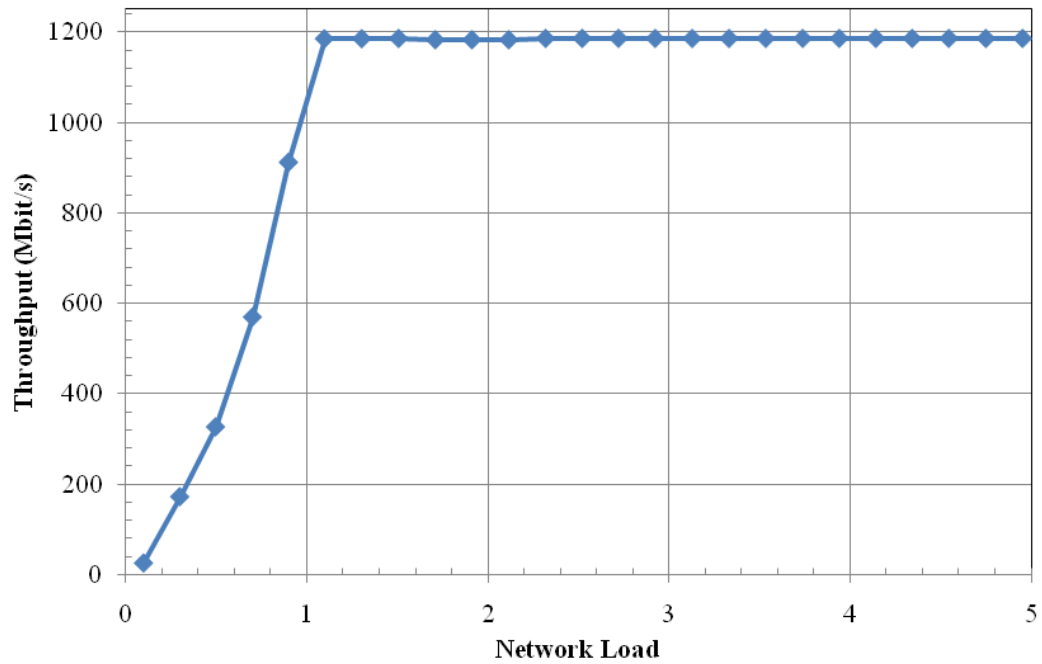
satisfied that ONU's requirements. In contrast any ONU with further demand will suffer from limited service, restricted in all cases to the maximum allowed bandwidth [147].

While the DMB in [57] utilises 16 ONUs and three SLAs, network deployment scenarios suggest the ONU number in more recent investigations should increase to 32. The types of SLAs should be also increased to four (SLA<sub>0</sub>, SLA<sub>1</sub>, SLA<sub>2</sub>, and SLA<sub>3</sub>) from low to high respectively to provide subscribers with more choice, following UK's broadband service provisioning [57]. As a result the OPNET editor comprises a single OLT and 32 ONUs with 1.24416 Gbit/s aggregate data-rates available for the upstream and 2.48832Gbit/s in downstream with link lengths set to 20 km. In addition, the maximum cycle period is set to 1.5 ms, the guard time to 96 bits, the ONU buffer size to 10 Mbit, and the gate/report process time in the ONU/OLT is set to 10  $\mu$ s as defined in the GPON standard [80, 82, 150]. Significantly, network traffic is generated based on a Pareto self-similar traffic model with a typical Hurst parameter of 0.8 to achieve increased accuracy according to real deployments [57, 144]. The maximum ONU channel capacity is set to 100 Mbit/s to effectively simulate the bandwidth requirement of representative network services in the short-term future [99, 144, 148].

The recorded channel throughput and mean packet delay versus network offered load figures obtained through simulation are shown in Figure 4-13 and Figure 4-14 respectively. It is important to note that since the reported DMB [34, 35, 73, 151] utilises a smaller number of ONUs, compared to the DMB algorithm

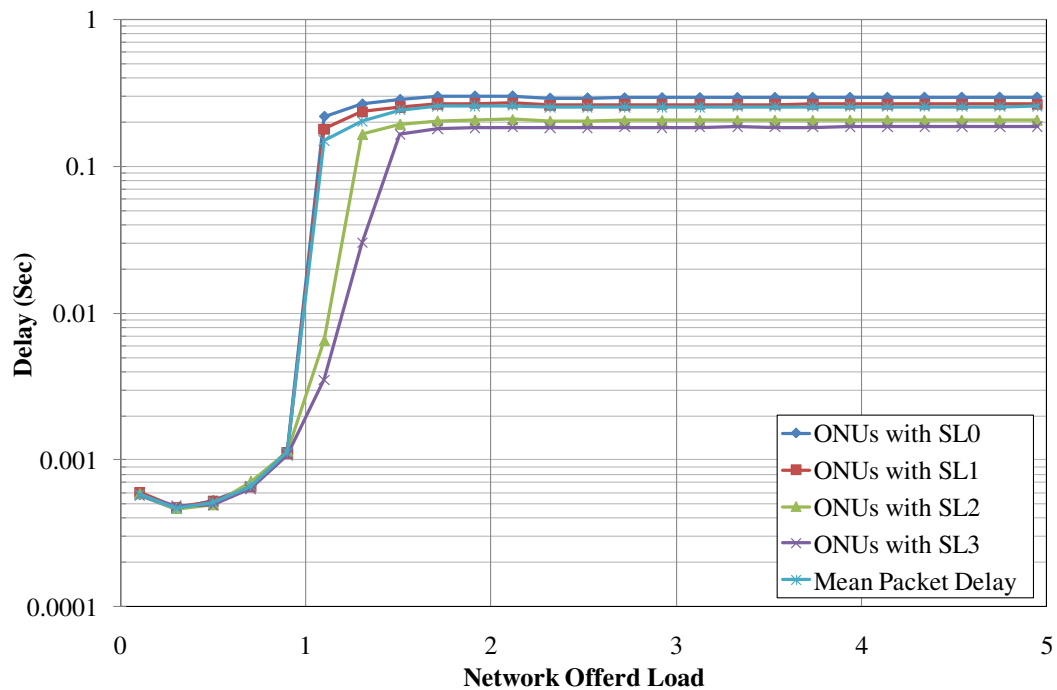
implemented here, an increase guard time would be expected in each cycle time, and a reduction in the maximum allowed bandwidth for each ONU. This leads to smaller transmission windows, higher delay and a lower network utilisation.

Therefore, the maximum channel throughput by using DMB protocol is affected by two factors, the adjacent cycles idle time, and the adjacent ONU's guard time; while the adjacent ONU's guard time is a factor of the ONUs number, which is added-up in each polling cycle with a total of 961 bits ( $31 \times 96$  bits); this shows a slight reduction of the upstream total bit-rate to approximately 0.64 Mbit/s in each polling cycle. The adjacent cycle's idle time between the neighbour cycles results a big idle-time (wasted bandwidth), which comes from the time needed to process the reports in the OLT in addition to RTT, this unused bandwidth will be described in detail in the next chapter. Taking into consideration the aggregate network transmission rate and the unused time-slots resulting to around 1185.5 Mbit/s maximum channel throughput, it can be seen Figure 4-13 that only a fraction of the assigned bandwidth is fully utilised.



**Figure 4-13: DMB-GPON throughput**

Figure 4-14 presents the simulated mean packet delay performance for the different service level agreements versus the network offered load and packet delay. The simulated trace follows quite closely the performance of the DMB protocol as presented in literature in both the high and low network load regions [57]. As already explained, four SLAs are used currently with a distribution of 16 ONU at  $SLA_0$ , 8 ONU at  $SLA_1$ , 4 ONU at  $SLA_2$ , and 4 ONU at  $SLA_3$ . This scenario, apart from portraying reasonable network utilisation as will be seen the next chapter, supports multiple service providers for future investigation utilising the same PON.



**Figure 4-14: Simulated packet delay performance with four SLA DMB-GPON**

It is a clear in Figure 4-14 that when the overall network offered load exceeds the supported wavelength's capacity, which is one wavelength capacity of 1.244 Gbit/s, excess upstream packets would have to be buffered in the ONU side, at the same time, the allocated basic bandwidth in case of DMB with 32 ONUs and 4 SLAs is 30 Mbit/s. In that sense, when the network loading overstep the network capacity of one wavelength load, a significant increase in packet delay appears achieving 0.2 s for the highest SLA ONUs, which again reflect a reliable values and same behaviour of the results that simulated in reported DMB protocol for single-wavelength GPON [57, 144].

### 4.8.2 Multi-Wavelength PON Modelling and Simulation Results

As already indicated the design methodology employed in developing the models, protocols and consequently the algorithms of this work has based on the principle the single-wavelength DMB-GPON presented in the previous section is a special case scenario with regards to the Multi-Wavelength-GPON (MW-GPON) where a single upstream wavelength has been utilised. To transfer from the DMB-GPON project editor to its MW-GPON counterpart, the data frame formats and the transmission mechanism of the grant and report messages between the OLT and ONUs are fully utilised to account for all the fields and process models presented in previous sections.

As described in section 3.3.2, the GPON frame format is adjusted to support the multi wavelength operation as seen in Figure 3-7 and Figure 3-9. To summarise, five upstream transmitters are added to the ONU, five shared receivers are added to the OLT to simulate the grant, and report messages respectively. Furthermore, the number of supported wavelengths in upstream is increased to five with the necessary adjustments performed to the splitter model to account for these dimensions.

For the evaluation of the MW-GPON network, 32 ONUs are also used to comply with the DMB set-up, with a total of initially three wavelengths rather than five at 1.24 Gbit/s aggregate data-rate capability each, for simulation purposes. The OPNET models presented in previous sections of this chapter are utilised here but this time in a multi-wavelength mode in view of the basic algorithm developed in section 3.4.2.

As shown in Figure 4-15 and Figure 4-16, the performance of the network throughput and the mean packet delay versus network offered load, recorded for the MW-GPON network model, are significantly similar to the performance measures of the DMB-GPON. Regarding the network throughput, this is expected since, as confirmed by Figure 4-15, the total network throughput is the accumulation of three wavelengths, with each wavelength exhibiting equivalent capacity to the total single-wavelength DMB-GPON. However, the mean packet delay as seen in Figure 4-16 is showing a reduction in the low and high network loads compared to the DMB algorithm. This reduction is the outcome of a minimum of 100 Mbit/s allocated bandwidth to each ONU in the MW-GPON, while it is only 35 Mbit/s maximum allocated bandwidth to the ONU in the DMB-GPON for the same number of network ONUs.

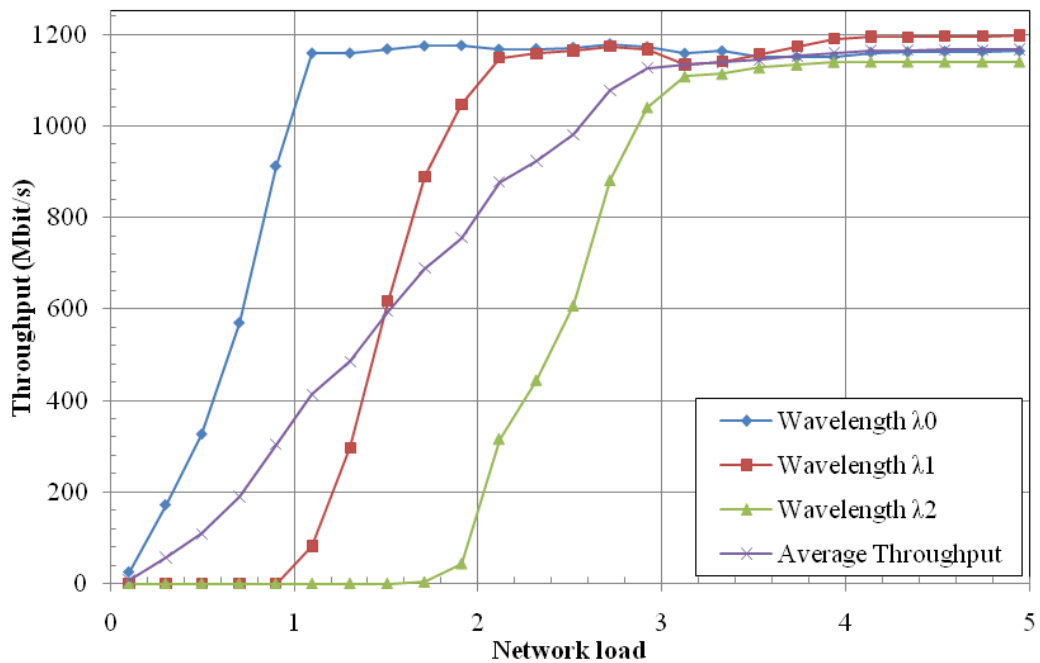
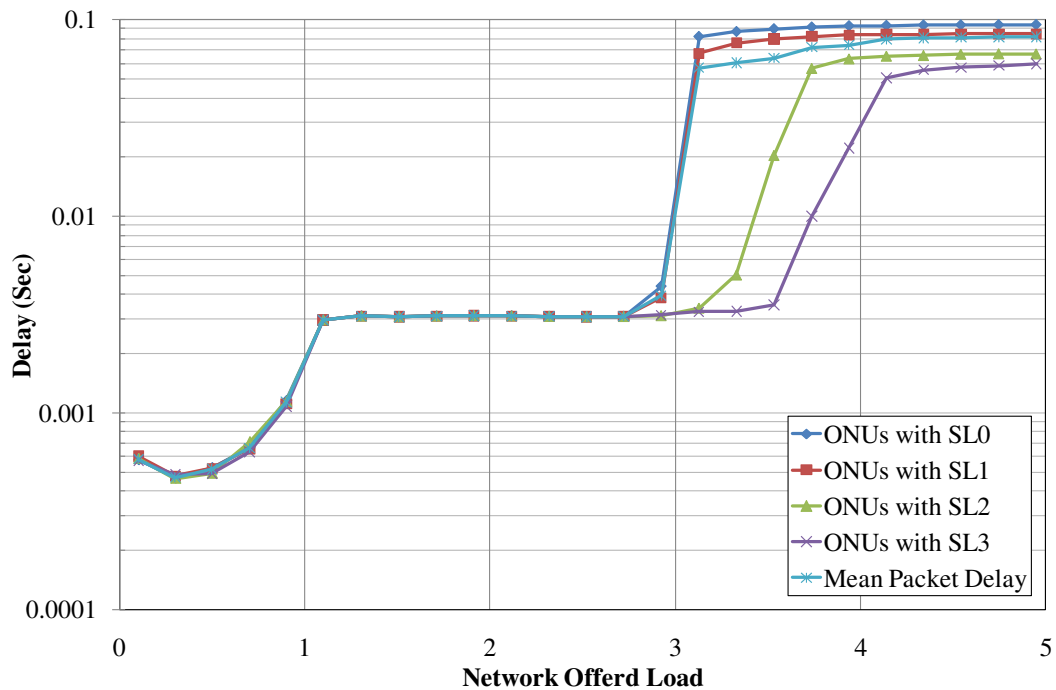


Figure 4-15: Multi-wavelength GPON Throughput





**Figure 4-16: Mean packet delay performance for Multi-wavelength GPON**

## 4.9 Summary

Industrial standard network simulation software, OPNET Modeler, has been used to develop a GPON model for the implementation of the proposed DBA protocols presented in the successive chapters. OPNET allows users to employ existing libraries of network elements, such as transceivers, and extensive traffic models. This considerably speeds up the modelling implementation process, while offering confidence, research-output value, since practical simulations represent real network performances. Subsequently characteristics of channel throughput, packet delay or buffer size under heavy or low network loading conditions can be obtained with no limitations. It is also important that once a simulation platform for a specific technology has been constructed as a modification of network conditions or evaluation of different algorithms becomes straightforward since it

requires simply the adaptation of the OLT and ONU process models to reflect the corresponding algorithms and the complete re-utilisation of the node and network modules.

To achieve MW-GPON operation, the already published DBA protocol for GPON has been introduced, and adjusted to account for multi-wavelength operation by initially enhancing the OPNET model. Although DMB is intended for single-wavelength GPON applications, the same polling scheme is successfully applied to allocate bandwidth in an MW-GPON mode, by redesigning the frame format to support multi-wavelength operation and readjusting the time to transmit the grant and report messages between the OLT and ONUs. Following network simulations, the characteristics of the channel throughput and packet delay under light and heavy network loading conditions are obtained to evaluate the accuracy by which the MW-GPON model has approximated the DMB-GPON performance. In addition, the observed resemblance in the bandwidth utilisation between the two models has established the validity of employing the DMB algorithm as a reference for assessing the developed MW-GPON protocol when extended in wavelength count.

# 5 DMW Protocol with Serial Wavelength Allocation (SWA)

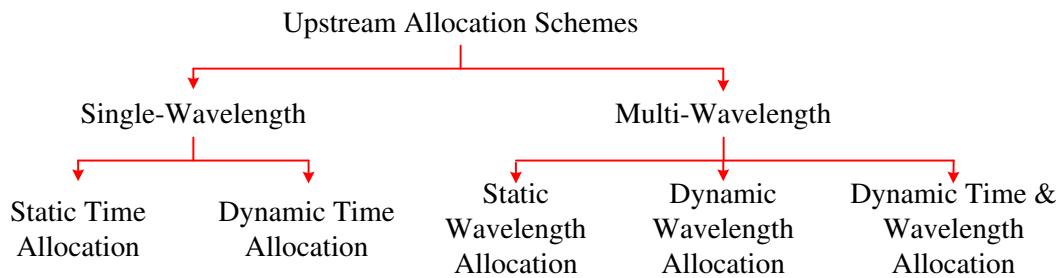
---

In this chapter, following a brief description of the most significant WDM/TDM allocation schemes to date; a dynamic multi-wavelength DMW algorithm is described which are to overcome the existing limitations and to improve network performance. The multi-wavelength GPON simulation platform presented in chapter 4 is implemented, improved, and employed as a stable DMW protocol with various service levels for GPON network ONUs. The DMW protocol has demonstrated a minimum 100 Mbit/s bandwidth provision for each of 32 Optical Network Units (ONUs) with a maximum 0.09 s packet delay for the lower SLA ONUs.

## 5.1 *Introduction*

While in TDM-PONs static or dynamic bandwidth allocation, e.g. IPACT [99] its various flavours or DMB [57], does not depend on the network architecture, in WDM-PONs the degree to which an upstream bandwidth allocation can be considered static or dynamic, e.g. fully or partially static or dynamic depends heavily on the network architecture. Figure 5-1

outlines the various solutions of the allocation mechanisms which has been used in GPON standards or heavily investigated, displaying also the route of progression towards the currently researched scenarios.



**Figure 5-1: PONs upstream bandwidth allocation schemes**

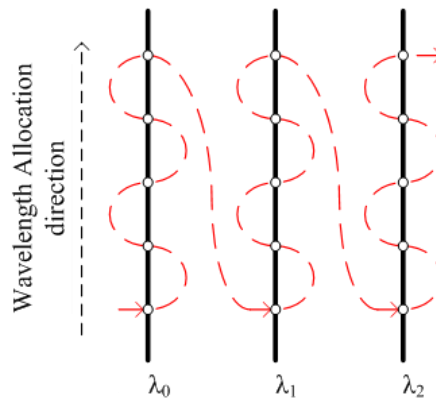
Although dynamic time and wavelength allocation protocols are currently in the form due to the flexibility and smooth migration from deployed standards, static wavelength allocation PONs in form of DWDM-PONs with a unique wavelength assigned to each ONU are considered by a few to be the ultimate future proof solutions for access networks [25]. Alternatively, allocating wavelengths dynamically to the network ONUs using a cyclic AWG at the RN and reflective ONUs [91] can present colourless customer equipment while time sharing of each ONU's upstream/downstream transmission within a single wavelength channel.

A Dynamic Wavelength and Bandwidth Allocation (*DWBA*) scheme would assign both bandwidth to wavelengths as well as wavelengths themselves to ONUs dynamically to satisfy more flexibly and much higher requested bandwidth while enhancing considerably the network QoS [66]. Providing that the DWBA can also utilise both multiplexing of ONUs to a single wavelength (intra-channel)

or more than one wavelength to one ONU (inter-channel), the DWBA scheme affords more efficient bandwidth allocation than the static wavelength allocation scheme.

## 5.2 *Development of a DMW-SWA Protocol*

Since this work is based on offline bandwidth allocation, two main allocation mechanisms could be implemented to allocate ONU traffic among the supported wavelengths; serial and parallel wavelength allocations.



**Figure 5-2: Serial wavelength allocation mechanism**

As shown in Figure 5-2, the serial ONU allocation mechanism, which will be considered from this point on in this chapter, assigns network ONUs to operating wavelengths by populating, in each cycle, each wavelength in sequence, starting from  $\lambda_0$  and finishing at  $\lambda_n$ , where  $(n+1)$  is the total number of supported wavelengths. The serial ONU allocation mechanism benefits from simplicity and cost reduction when implemented in practise, particularly at low network traffic conditions since only one laser would need to be switched on at a time and only the total number of wavelengths needed to satisfy the overall bandwidth demand

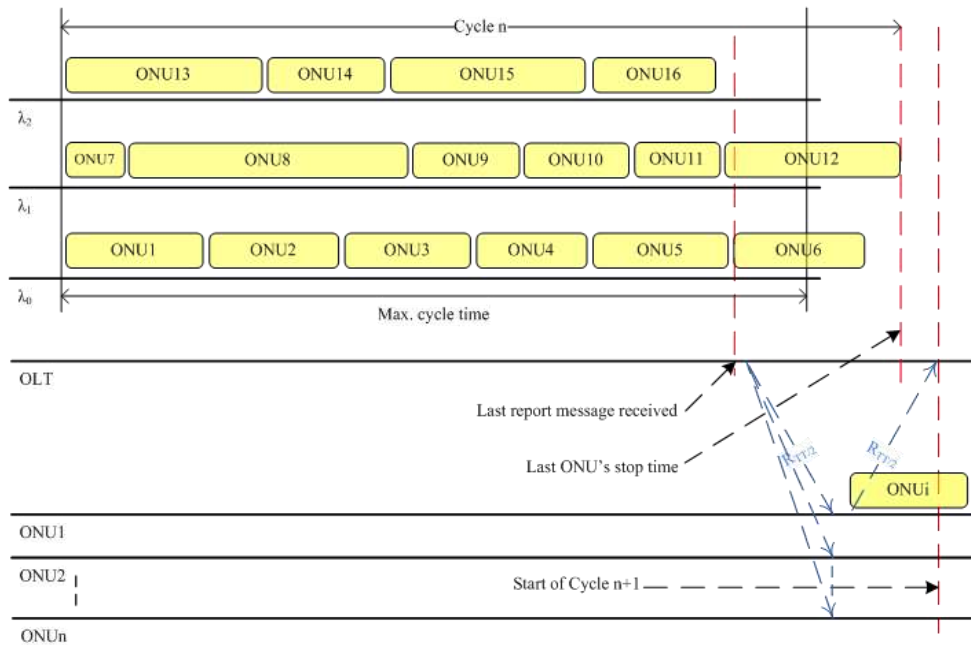
will need to be used. For example, in case of a network with five wavelengths, if only two wavelengths are needed in total, the other three wavelengths in the OLT/ONUs will not be used and therefore remain switched off.

Since ONUs transmit data on only one wavelength from their supported spectrums at a time, they will have to transmit their traffic on only one wavelength in each cycle time. While this approach helps in reducing the ONU cost in the physical layer as already suggested, it raises an issue with the bandwidth allocation process from the MAC prospective.

After the OLT has calculated the total ONU requested bandwidth, it proceeds with each ONU allocation taking into consideration their SLA. The worst-case scenario arises when the total requested bandwidth is equal or above the total network available bandwidth (including all wavelengths), as seen in Figure 5-3. Allocating ONU traffic among the supported wavelengths, in the OLT will be limited in each cycle by the single wavelength transmission property of the mechanism.

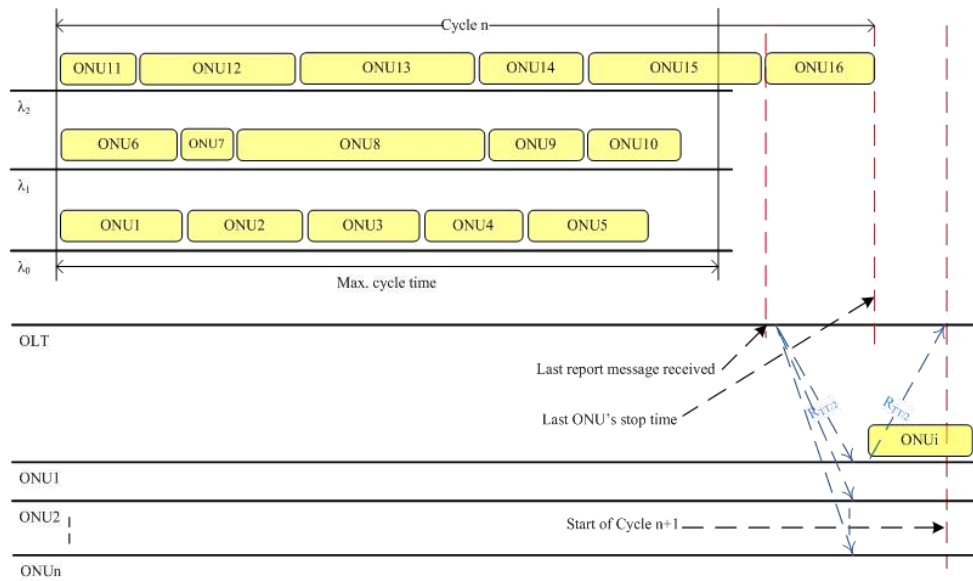
Figure 5-3 shows a random ONU's time slot allocation among the supported wavelengths ( $\lambda_0 - \lambda_2$ ), even though the OLT calculates the total available bandwidth, when it assigns the ONU's time slots to their wavelengths, it can be the case, when the ONU's time slot stops after the Maximum cycle limit, as in case of ONU<sub>6</sub> and ONU<sub>12</sub>, that is a result of limiting the ONU transmission only on one wavelength-at-a-cycle time. The MAC layer limitation is associated with the standard maximum cycle time limitation [82]. To that extent, no transmission

is allowed after the maximum cycle time, which is limited to 2 ms in most PON standards, in order to minimise the mean packet delay.



**Figure 5-3: Multi-wavelength ONU traffic allocation without time-limit control**

Conversely, as can be seen in Figure 5-4, if the OLT controls the ONU traffic allocation by limiting the ONU transmission time to less than the maximum cycle time at the first two wavelengths, it will have an effect on the third and final wavelength. This will be either by having to increase its associated cycle time as shown in the figure to accommodate ONU 15 and 16 time-slots or by limiting wavelength-3-transmission-time to the maximum cycle time disregarding ONU 16 while partly allocating ONU15 bandwidth.

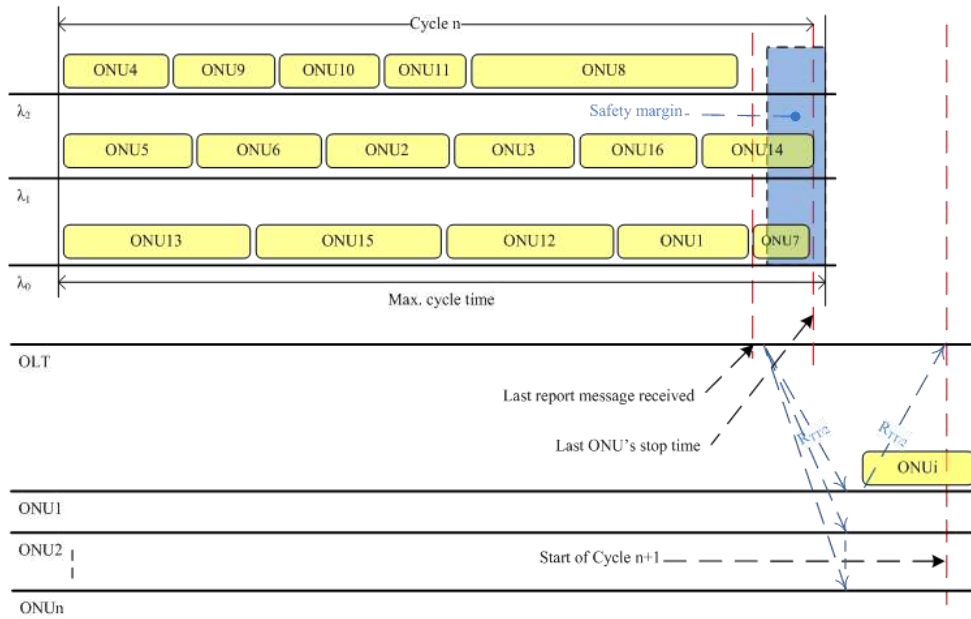


**Figure 5-4: Multi-wavelength ONU traffic allocation with time-limit control**

Both approaches will normally result in a delay by increasing the cycle time because of the random allocation, which leads to increase the queuing delay, and the network throughput will be also affected, because of the idle time between the adjacent cycles; the QoS of some ONUs will be compromised particularly in the second case.

To avoid the misuse of bandwidth, in view of the random distribution of ONUs' traffic among the wavelengths, a safety margin is introduced at the end of each cycle time as indicated in Figure 5-5. The aim of such safety margin is to create a virtual maximum cycle-time that is less than the actual maximum cycle time by 3% when three wavelengths are used, the choice of this value will be explained later in this chapter.





**Figure 5-5: ONU traffic allocation with a safety margin**

While the virtual maximum cycle time is used to calculate the available network bandwidth, determining the allowed bandwidth for each ONU, the actual maximum cycle time is used by the OLT to limit each ONU traffic allocation. Using the safety margin at the end of each cycle-time guarantees that each ONU's allocated traffic stays within the maximum cycle time. It takes into consideration the ONU transmission over one wavelength per cycle to minimise the ONU/OLT costs as stated in chapter 3, that will lead a decrease in the network mean packet delay while increasing the network throughput, as it will be discussed later in this chapter.

### 5.2.1 The Bandwidth Allocation Mechanism

As repeatedly stated, the DMW protocol and its later algorithm implementation has been originally achieved by developing the DMB algorithm

[116] and modifying the GPON frame format to support multi-wavelength operation. The DMB algorithm facilitates three SLAs to assign each ONU with a guaranteed minimum bandwidth to satisfy their basic service requirements together with an additional allocation of extra bandwidth on demand, based on the assigned SLA. In the DMW algorithm presented here, a fourth service level is introduced to meet the terms of the modern service level provided [152] and to offer a greater user experience and network flexibility. In addition, an extra upstream wavelength is considered, bringing the total to five, out of sixteen CWDM wavelengths, to scale-up wavelength assignment in view of the ITU-T G.984.5 standard [47].

The OLT initially requests each ONU to confirm their supported wavelengths during the ONU registration process. This procedure is crucial to distinguish different network sectors and bandwidth among ONUs. The OLT assigns the available upstream bandwidth in every polling-cycle in three stages. Following reception of the requested bandwidth from each ONU, in the first stage, the OLT calculates a safety margin to limit the maximum cycle-time for bandwidth allocation independently for each wavelength. Since the safety margin is determined as a percentage of the overall network bandwidth, it provides a considerable decrease in idle time slots. In that case, the total network capacity, ( $B_{total}$ ), would be a function of the safety margin explained above and the bandwidth per wavelength as seen in equation (5-1).

$$B_{total} = \sum_{\lambda=0}^n B^{\lambda} - \text{Safety Margin} \quad (5-1)$$

The allocated bandwidth for  $ONU_{Allocated}^i$  is then calculated and assigned according to the DMW algorithm basics using equation (3-5) as explained in section 3.4.2.

As shown in Figure 5-5, once the first stage is completed, the second stage embraces management of the network's bandwidth allocation process by omitting the random distribution of ONU traffic among the different wavelengths, presented in previous figures, to avoid exceeding the maximum available cycle-time. At this stage, the OLT specifies the ONU with the allocated bandwidth, positions it at the end of the cycle, like in the DMB algorithm, and distributes the remaining ONUs in sequence from those with higher allocated bandwidth to those of low. In the final stage, the OLT assigns the ONU time-slots to different wavelengths, following the serial wavelength allocation approach as already indicated, starting from  $\lambda_{up0}$ , finishing with  $\lambda_{up2}$ . This process allows the OLT to guarantee that the last ONU time-slot in  $\lambda_{up2}$  can fit within the safety margin as shown in Figure 5-5. Figure 5-5 only displays 3 wavelengths and 16 ONUs just for algorithm demonstration purposes. As it will be demonstrated in following sections, this approach produces a shorter polling cycle length and achieves a reduction in the waiting-time of the ONU upstream packet in proceeding cycles, resulting in increased network utilization.

### 5.3 *The DMW-SWA Model: Implementation and Analysis*

With the purpose of evaluating the performance of the proposed algorithm, a multi-wavelength FTTH oriented GPON network was modelled using the OPNET v.14.5 platform, including a single multi-wavelength OLT and 32 multi-

wavelength ONUs with varying weights representing different service levels at the upstream transmission with 1.24416 Gbit/s upstream and 2.488 Gbit/s downstream data-rates utilised for link lengths up to 20 km. Additionally, a 2 ms maximum cycle period and 96 bits guard time are chosen to establish upstream data transfer between the OLT and ONUs in order to offer a comparable platform with published algorithms [57, 60, 62]. Network traffic is generated according to the Pareto self-similar traffic model with typical Hurst parameter of 0.8 to provide increased accuracy concerning real deployments [57, 148]. The ONU basic bandwidth,  $B_{basic}$  for each of the four service levels for single-wavelength and multi-wavelength operation are set to 30 Mbit/s and 100 Mbit/s respectively to efficiently simulate realistic network usage as previously explained. The safety margin used in the case of multi-wavelength operation is set to 3% of the maximum cycle-time, since this figure produced the best performance results as will be confirmed later in this chapter.

In practical networks, the number of end users subscribed to high service plans is currently lacking the low service plan provision [152]. Therefore, the algorithm was organised to apply service level agreement diversity from high to low with 4 ONUs assigned at  $SLA_3$ , 4 ONUs at  $SLA_2$ , 8 ONUs at  $SLA_1$ , and 16 ONUs at  $SLA_0$ . Furthermore, with the intention of examining the algorithm's potential to resourcefully assign bandwidth when the number of ONUs in each service level is changed, a second simulation scenario was developed by which the proportion of subscribers assigned to each service level, from high to low has been extensively changed from 4:4:8:16 to 2:4:8:18 and 2:3:7:20.

### 5.3.1 Simulations and Performance evaluation

With regards to the first simulation scenario, shown in Figure 5-6, it can be concluded that in contrasting the DMW network performance with that of the DMB-GPON protocol, the overall network capacity has been increased by a factor equal to the number of wavelengths employed. Although, this result was expected, the DMW protocol performance characteristic was achieved at 100 Mbit/s minimum data-rate per ONU for 32 ONUs as opposed to the 30 Mbit/s basic bandwidth per ONU for the same number of ONUs in the DMB-GPON. Besides, the use of the 3%, safety margin has not limited any of the wavelength's channel-throughput which achieved 1175 Mbit/s in average for DMW protocol compared to 1160 Mbit/s for the single wavelength capacity achieved in DMB, due to the more effective use of the available time slots.

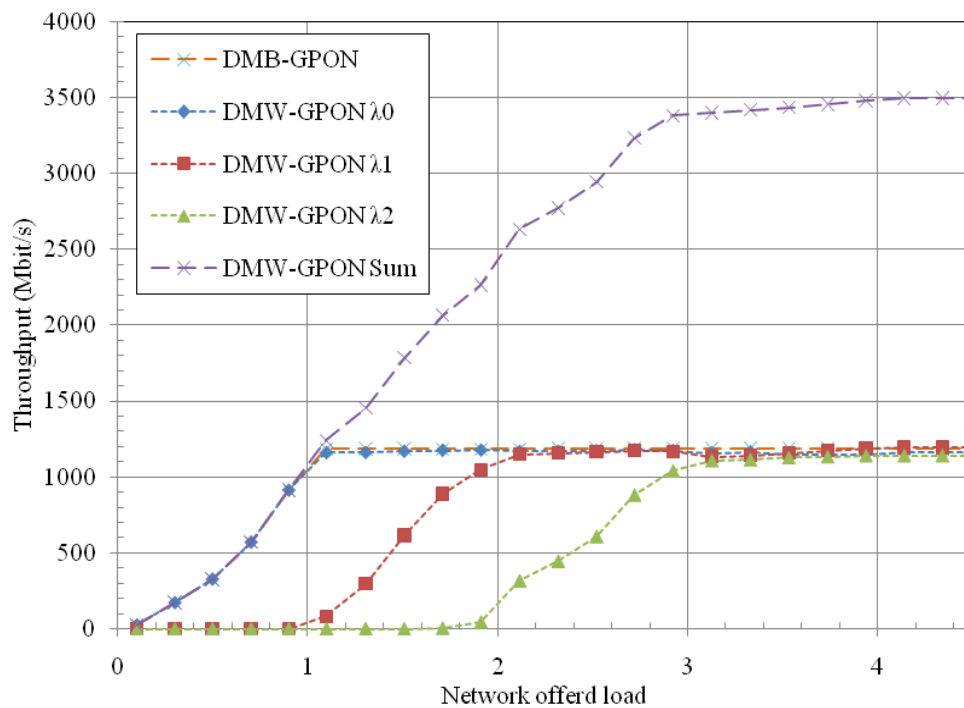


Figure 5-6: Channel throughput for DMB and DMW protocols

Reflecting at the next performance evaluation measure, as the mean packet delay of all SLAs utilising a single-wavelength overcome 0.1 s, when the total network load achieves one wavelength capacity at 1.244 Gbit/s, the DMW protocol offers a remarkably diminished packet delay with 0.003 s remaining constant up until the total network load reaches three wavelengths capacity. This characteristic is shown in Figure 5-7. This result allows for the non obstructive transmission of interactive applications since it satisfies the recommended one-way delay requirement for these applications as defined by the ITU-T recommendation G.1010 [56]. Accordingly, the DMW protocol allows for real time service propagation at the stringiest requirements of service provisioning such as conversational voice and videophone, increased ONU basic bandwidth at 100 Mbit/s and increased ONU volume.

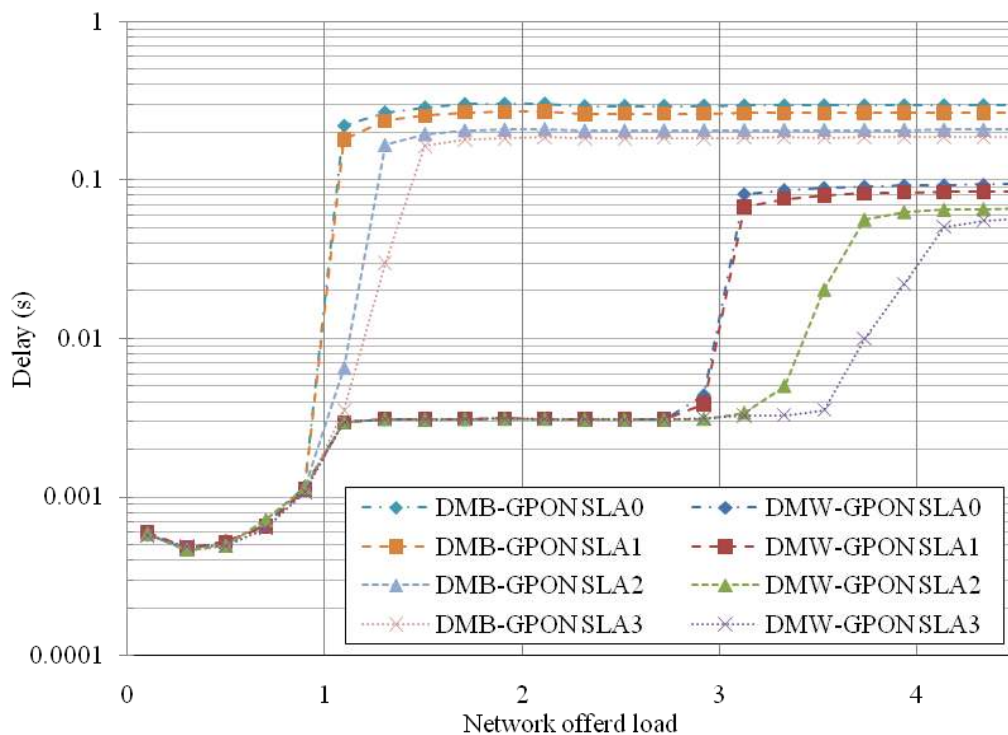
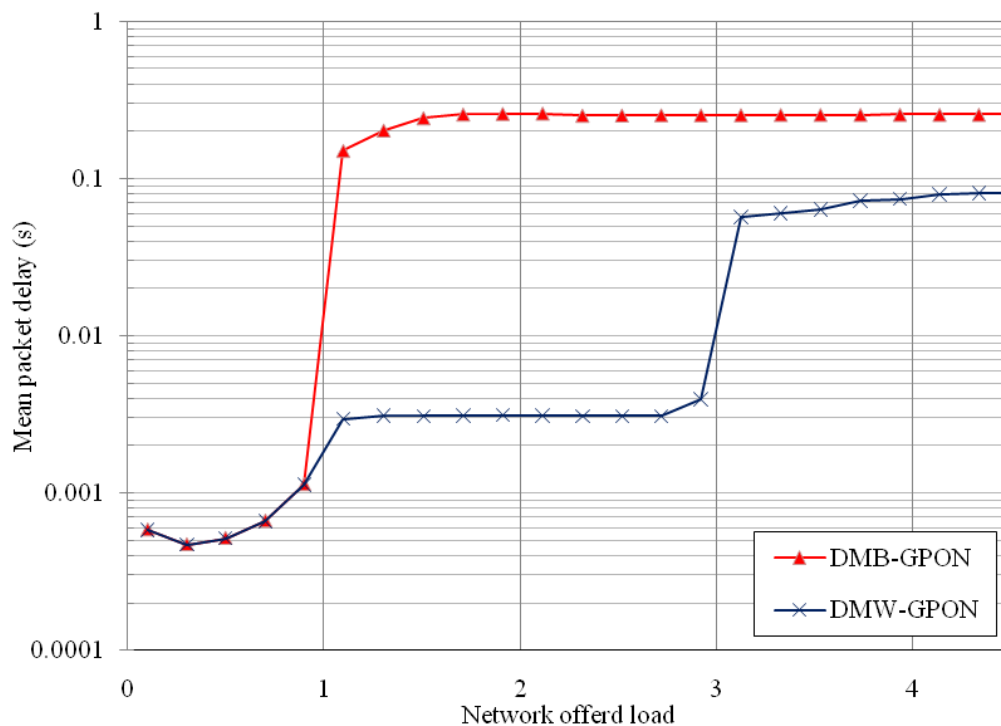


Figure 5-7: Packet delay for four service levels for DMB and DMW protocols

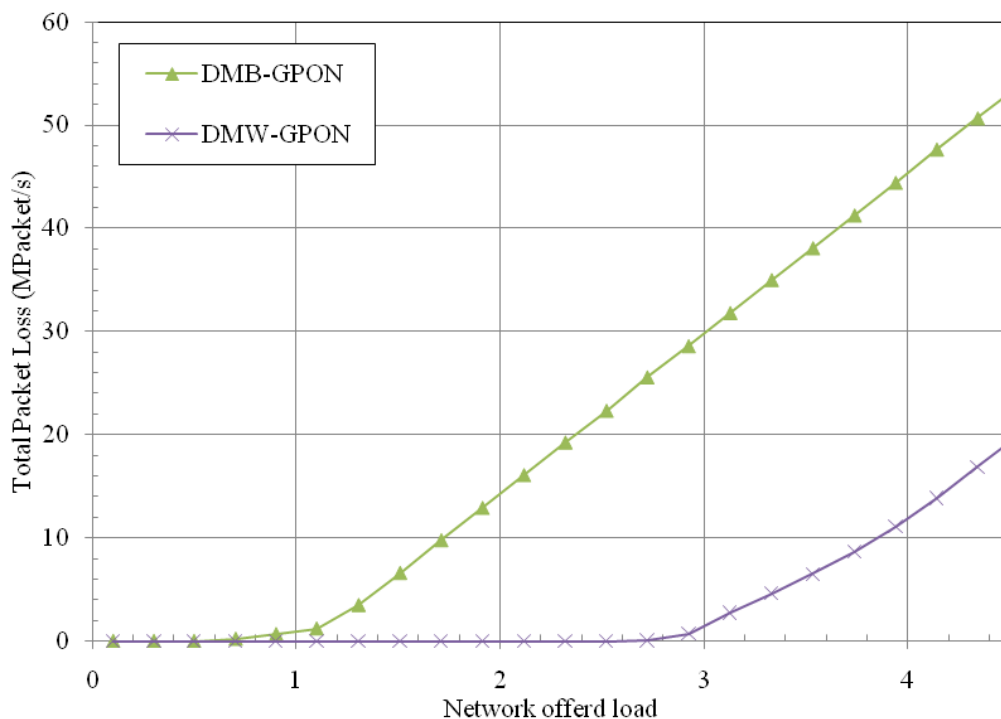
In addition, Figure 5-8 confirms that, even at higher network load, reaching up to 3.72 Gbit/s, where the mean packet delay of the single-wavelength DMB network continues to display higher delay values compared to the DMW network, the delay of the later remains below 0.1 s which allows scope for further scalability to ONU provision and service advancements.



**Figure 5-8: Mean packet delay for DMB and DMW protocols**

In spite of the fact that the packet loss comes into view only in the ONU side, and the packet drop rate in the channel is assumed to be zero, the measured packets' loss represents the total packet loss in the entire network for all ONUs. At the same time, the average packet loss per second is measured to show the difference between single-wavelength operation in the presence of the DMB algorithm and multi-wavelength operation in view of the DMW algorithm, as seen

in Figure 5-9. The loss rate of the packets in the single-wavelength GPON starts immediately before the network offered load reaches one wavelength capacity, while in case a three wavelength network is employed, the starting point of increased packet losses is defined at almost at three times the single-wavelength value.

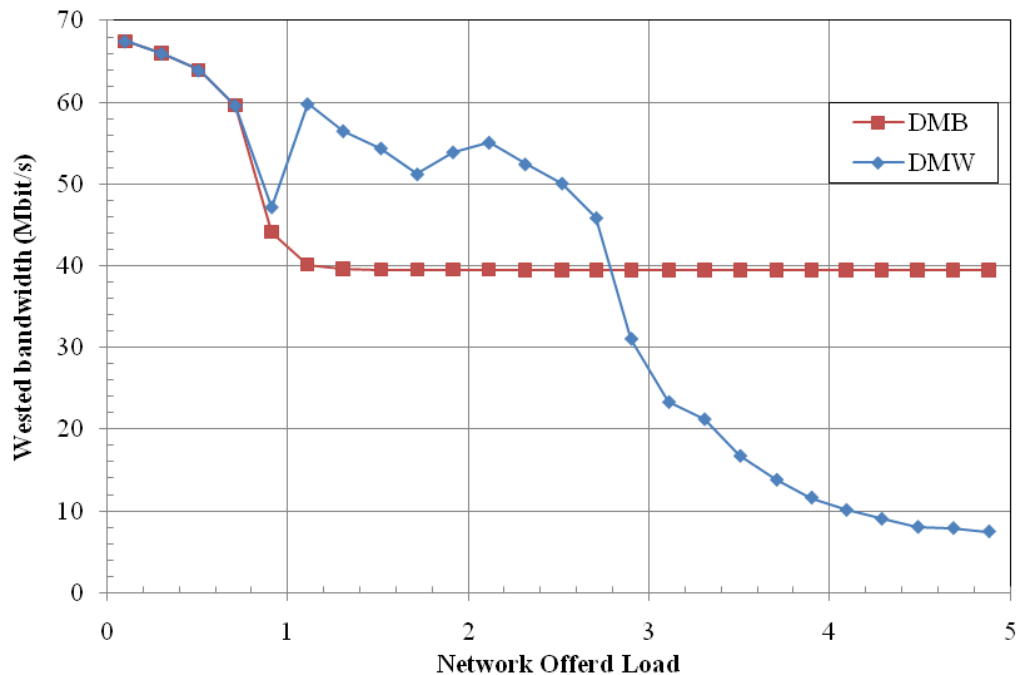


**Figure 5-9: Total network ONU's packet loss for DMB and DMW protocols**

A new characteristic measure, that of the adjacent cycle's idle time (or non-used bandwidth), is introduced to exhibit the DMW's protocol improvement in bandwidth utilisation over DMB. In particular, it allows clearly observing and optimising the report-grant mechanism. The same characteristic will prove to be very useful in comparing later the various flavours of the DMW protocol. As seen in Figure 5-10. The idle bandwidth of the single-wavelength GPON starts just



below 70 Mbit/s at lower network offered load and reaches its minimum value of 40 Mbit/s when the network offered load reaches the capacity of one wavelength. At the same time for the DMW GPON, the idle bandwidth portrays the same behaviour for values of network capacity below the equivalent of one wavelength. As soon as the second wavelength starts being occupied, the idle bandwidth increases and subsequently decreases as the assignment process progresses, following a similar pattern with minimum idle bandwidth measured at 7 Mbit/s at very high network offered load.



**Figure 5-10: Idle bandwidth between cycles for DMB and DMW algorithms**

Introducing the safety margin factor raises the question of limiting the available bandwidth per wavelength that may reduce the total available bandwidth. For that purpose, and to study the effect of using the safety margin, different values of the safety margin were simulated to select the one matching

best the network parameters. As seen in Figure 5-11 and Figure 5-12, while increasing the safety margin, the mean packet delay especially at high network offered loads is not affected since it depends on the buffer size of the ONU and not the transmission cycle. In order to optimise the intermediate offered load range as displayed in Figure 5-11, a 3% margin has been used in this work in case of using three wavelengths. This will offer a good compromise between the non application of a margin and as a result wasting of bandwidth and the over application of a safety margin that increases the packet delay more rapidly as confirmed by the following figures.

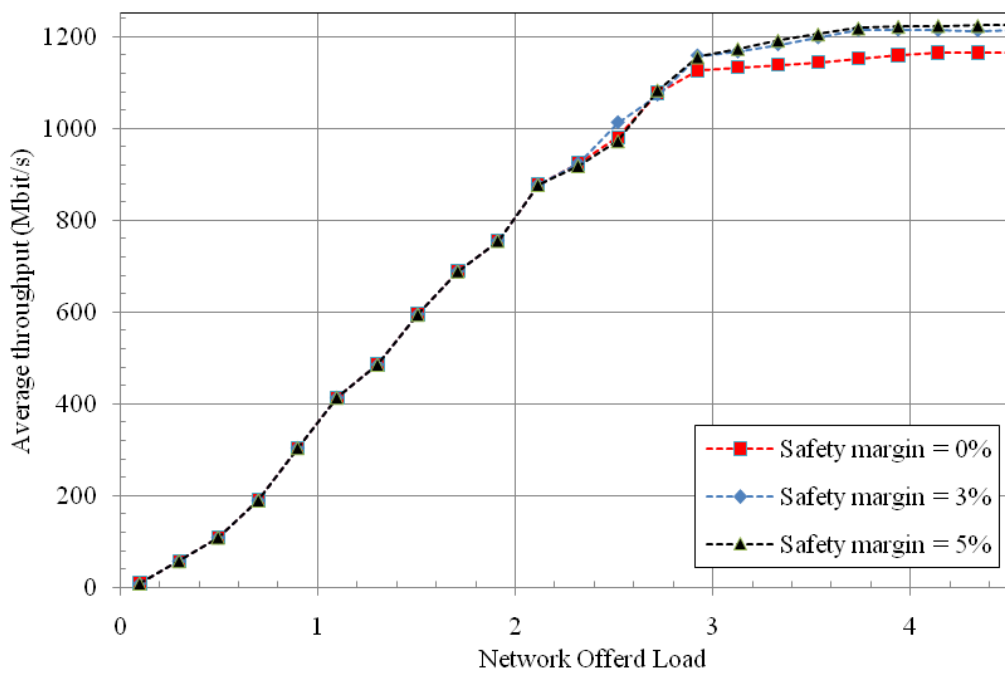
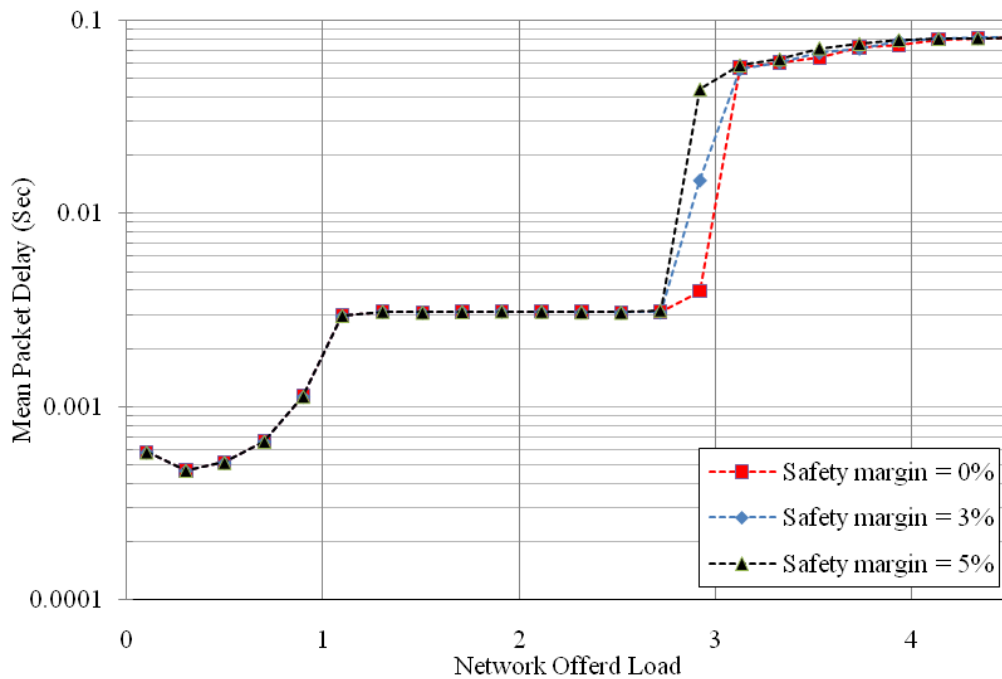


Figure 5-11: Average channel throughput for DMW under different safety margin values



**Figure 5-12: Mean packet delay for DMW under different safety margin values**

Due to the fact that the DMW-GPON network model comprises 34 nodes (32 ONUs, one OLT, and one splitter), and each ONU generates and buffers its traffic in individual queues, and the OPNET modeller considers each channel (wavelength) as an individual queue when it comes to transmitting, in addition to the event based processing mechanism, running single values in a curve requires good computer processor performance, Random Access Memory (RAM), and long simulation time. Even by using quad processor with 4-Gbyte RAM computer, the achieved maximum simulated time is 15 seconds which takes a running time of about two days for each single value in the curve. As seen in Figure 5-13 and Figure 5-14, the use of different simulated times does not show noticeable changes on the network performances and for this reason the simulated time used during this work was 10 seconds.

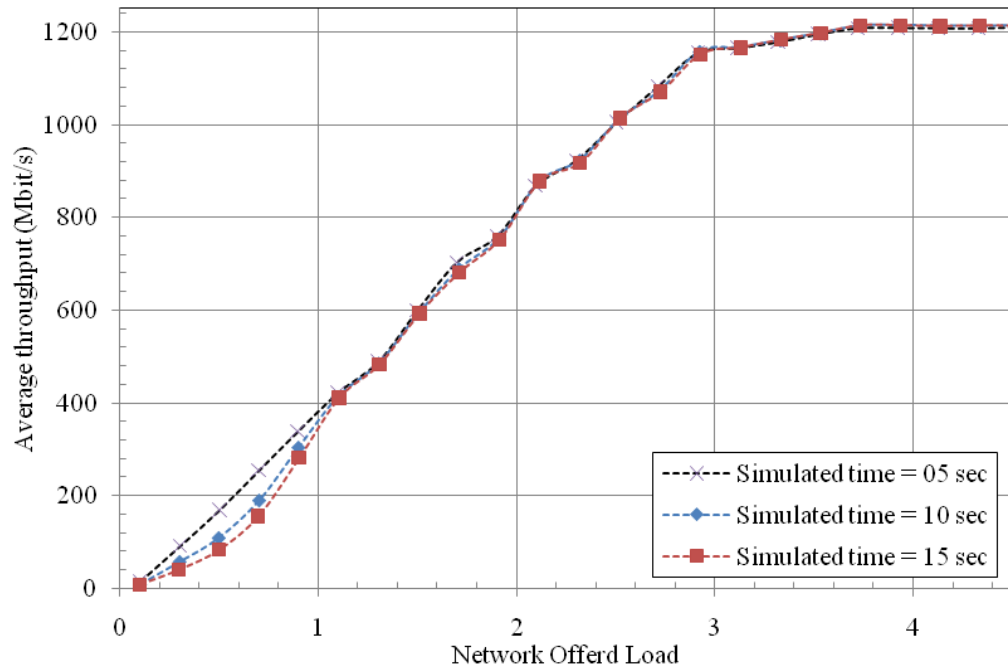


Figure 5-13: Average channel throughput for DMW under different simulated time values

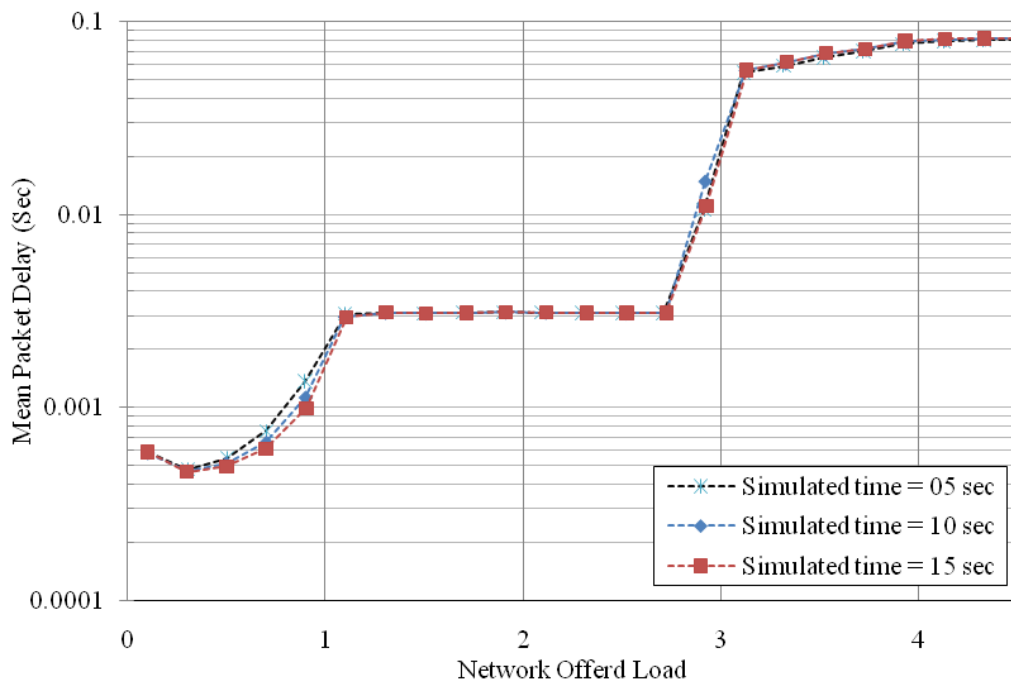
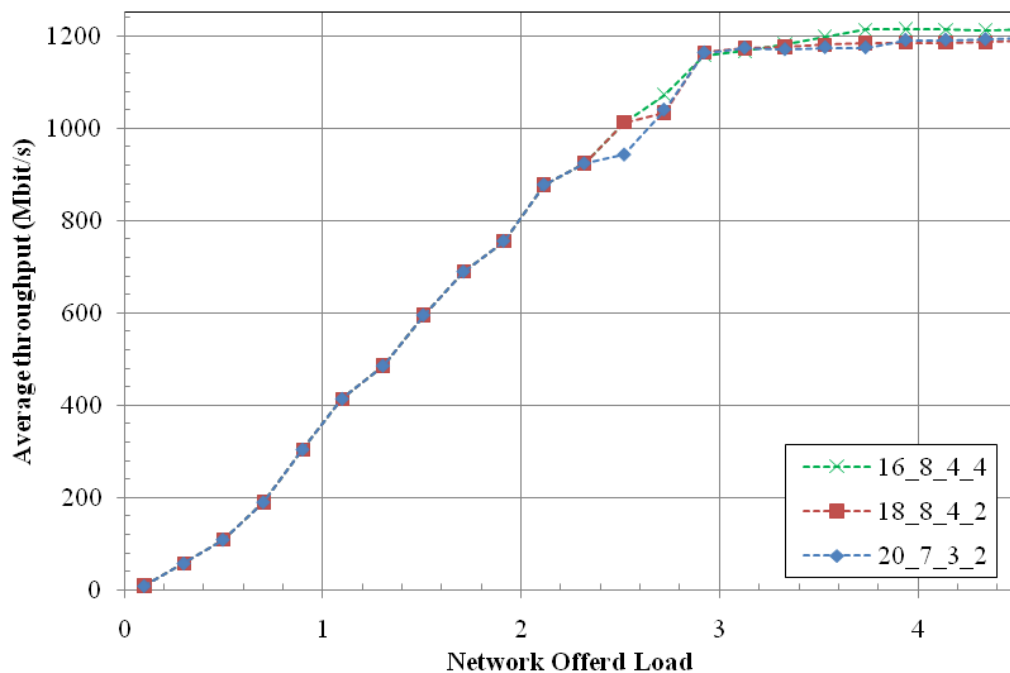
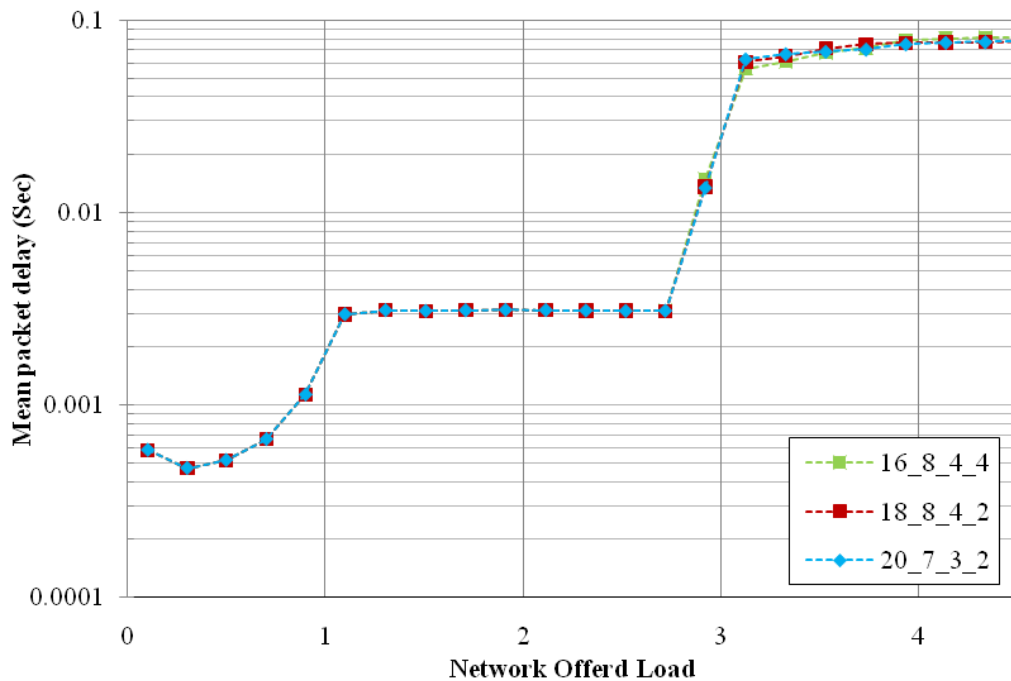


Figure 5-14: Mean packrat delay for DMW under different simulated time values

For analysing the performance of the DMW algorithm concerning automatically adjusting the assigned bandwidth according to SLA, as already discussed, the number of ONUs in each service level was adjusted from low to high following the configurations, 16-8-4-4, 18-8-4-2, and 20-7-3-2. Figure 5-17 and Figure 5-18 demonstrate the average channel throughput and mean network packet delay performance figures for several of these scenarios. It is concluded that the simulation results demonstrate the same channel throughput and mean packet delay independently of the assigned configuration of ONUs to SLA type, confirming the ability of the protocol to maintain a steady overall network performance when the network penetration of the subscriber ratios per service level is changed.



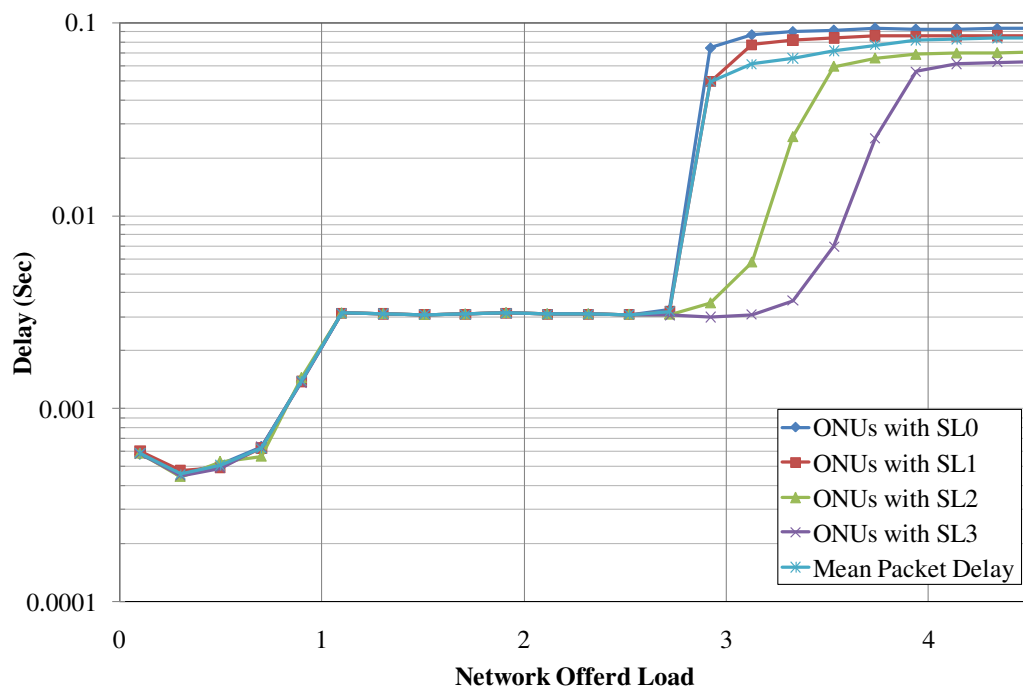
**Figure 5-15: Average channel throughput for DMW under various number of ONUs in each service level**



**Figure 5-16: Mean packet delay for DMW under various number of ONUs in each service level**

While the main two performance parameters of the network are kept unchanged, the packet delay for each service level is changed when modifying the ONU number in each service level as confirmed by Figure 5-17 to Figure 6-6. These differences are the result of the implemented algorithm that offers each ONU a basic bandwidth, and subsequently divide the remaining bandwidth according to the individual service level types. As presented in Figure 5-17, the first set of results represents a fair ONU distribution scenario whereby four ONUs have been attributed to  $SL_3$  and  $SL_2$ , eight ONUs to  $SL_1$  and the remaining ONUs to the lower service level  $SL_0$ . This scenario results in a maximum bandwidth allocation of 146 Mbit/s, 134 Mbit/s, 110 Mbit/s and 101 Mbit/s from high to low respectively. In case of an 18-8-4-2 ONU distribution, more ONUs have

subscribed to the higher SLA and as a result they will predominantly share the available bandwidth resulting in a decrease in their mean packet delay. On the other hand, the lower service level ONUs will experience an increase in their mean packet delay as seen in Figure 5-18. The maximum bandwidth allocation to ONU in this scenario will comprise of 194 Mbit/s, 134 Mbit/s, 110 Mbit/s, and 100 Mbit/s respectively from high to low SLA. Finally, using a 20-7-3-2 allocation will reduce the mean packet delay of the higher service level ONUs by increasing their bandwidth share while assigning only the basic bandwidth to the lower service level ONU as seen in Figure 5-19. In this case, the maximum bandwidth allocation to each ONUs will be 194 Mbit/s, 146 Mbit/s, 111 Mbit/s, and 100 Mbit/s from high to low SLA.



**Figure 5-17: Packet delay performance for DMW-GPON when the proportional of the ONUs in each service level from low to high is set to 16:8:4:4**

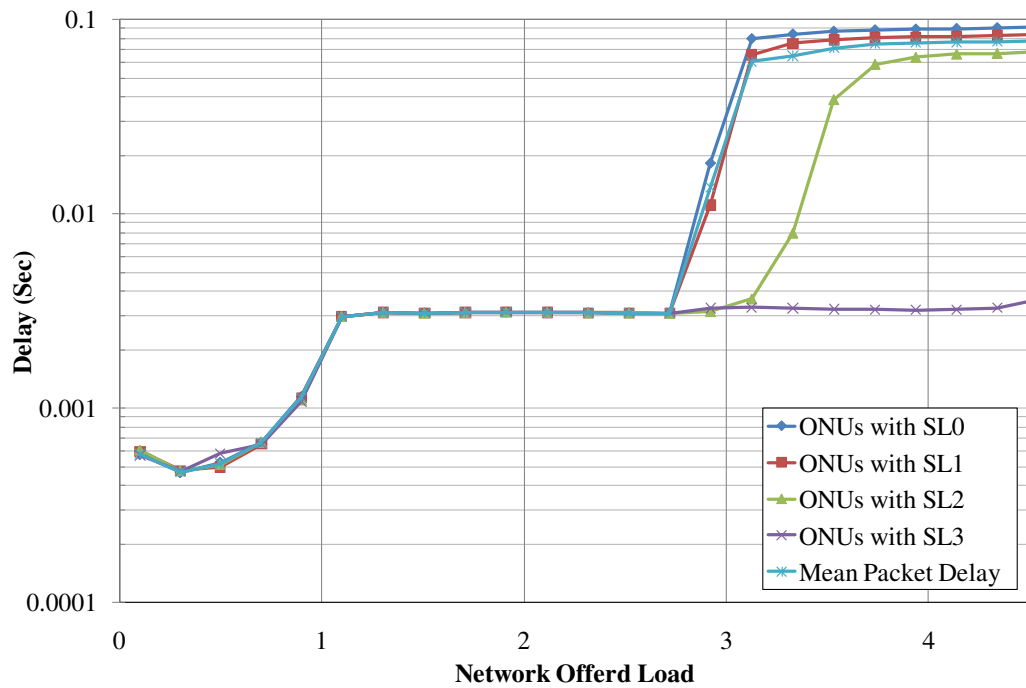


Figure 5-18: Packet delay performance for DMW-GPON when the proportional of the ONUs in each service level from low to high is set to 18:8:4:2

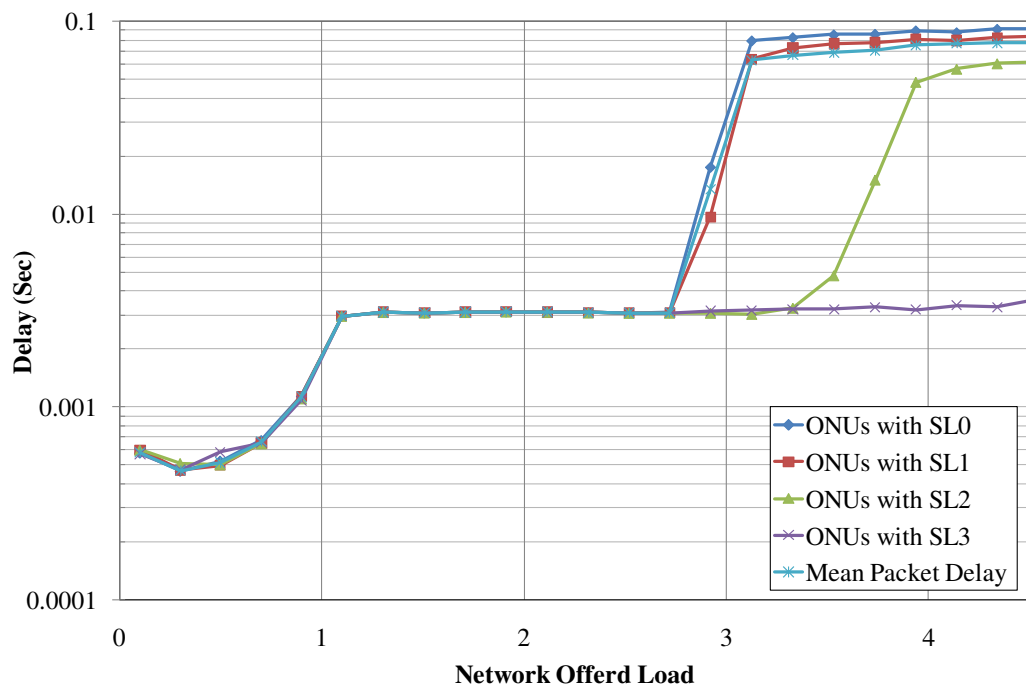
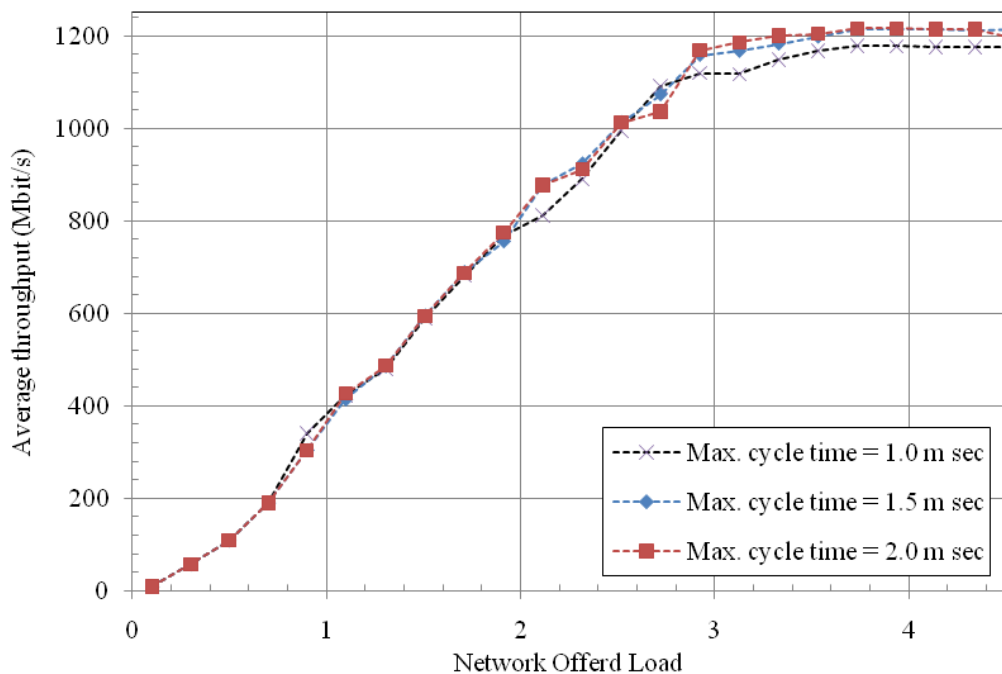


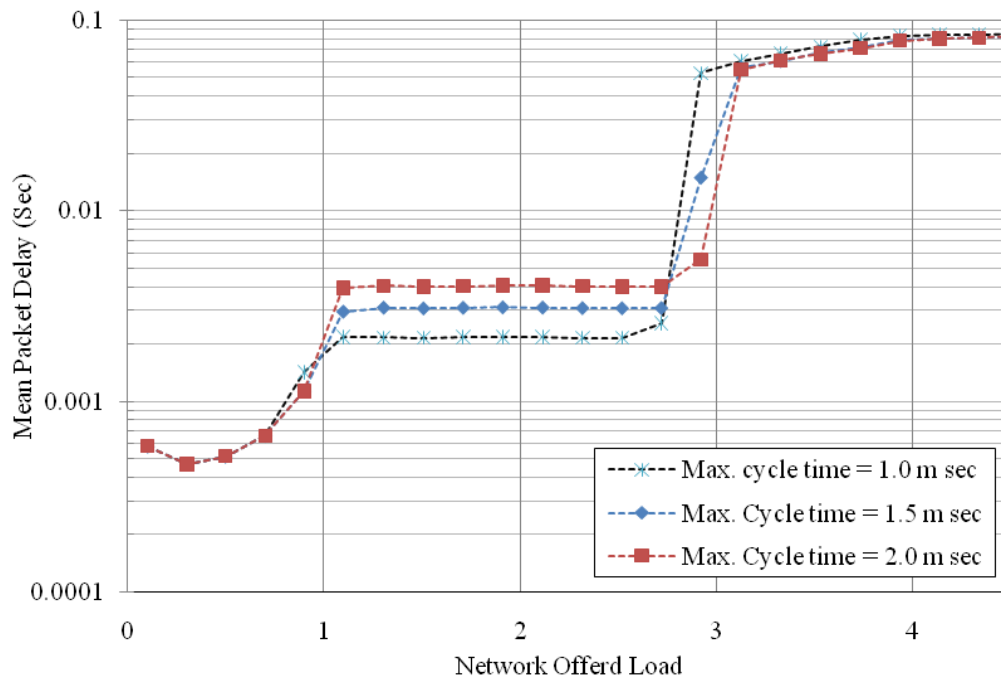
Figure 5-19: Packet delay performance for DMW-GPON when the proportional of the ONUs in each service level from low to high is set to 20:7:3:2



The effect of changing the cycle-time duration on the network performance is presented in Figure 5-20 and Figure 5-21. As it can be seen in Figure 5-20 decreasing the cycle time will result in a decreased average channel throughput at high network offered load. This in turn which will result in a reduction in the mean packet delay under low network offered load as confirmed by Figure 5-21. The average channel throughput degradation is a result of the increase in time between the report processing time plus the RTT (which measures the transmission start time for the cycle  $n+1$ ) and the cycle time duration itself. However, reducing the cycle time will cause a lower queuing mean packet delay which leads to a decrease of the total mean packet delay which can be clearly observed in Figure 69 in the area of network load corresponding to full capacity wavelengths 1 and 2.

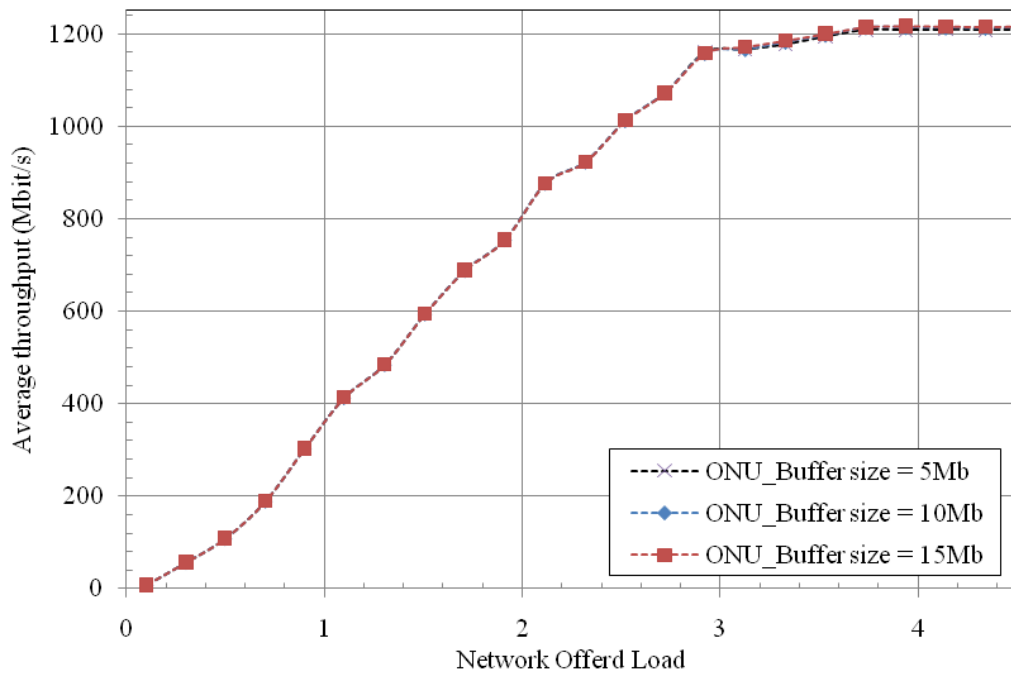


**Figure 5-20: Average channel throughput for DMW under different maximum cycle time values**



**Figure 5-21: Mean packet delay for DMW under different maximum cycle time values**

Finally, the effect of changing the ONU First-In-Firs-Out (FIFO) buffer size on the network performance is presented in Figure 5-22 to Figure 5-24. As seen in Figure 5-22, the average channel throughput characteristic suggests independence between the ONU buffer size and the channel throughput. Since the buffer size is an ONU parameter, its effect becomes noticeable only in view of the mean packet delay traces as seen in Figure 5-23 and Figure 5-24, as well as the total network packet loss rate displayed in Figure 5-24.



**Figure 5-22: Average channel throughput for DMW under different ONU buffer size values**

It can be argued that limiting the ONU buffer size to its minimum will result in decreasing the mean packet delay as a result of almost eliminating the packet queuing time at higher offered load. Moreover, limiting the buffer size will result in an increment in the packet loss rate compared to a higher ONU buffer size as seen in Figure 5-24.

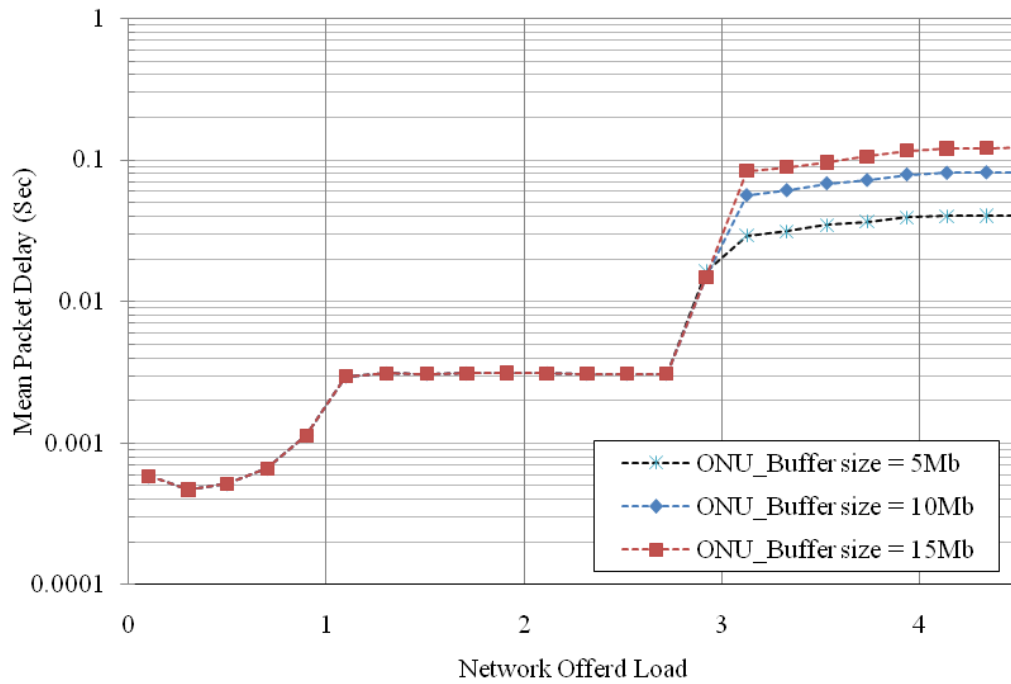


Figure 5-23: Mean packet delay for DMW under different ONU buffer size values

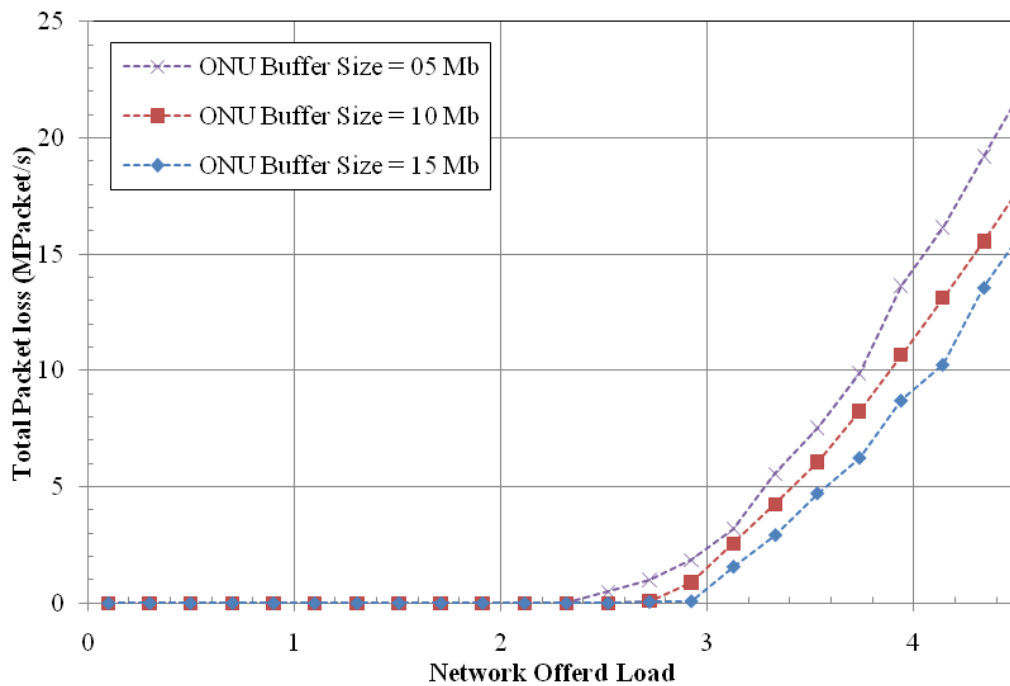


Figure 5-24: Total network ONU's packet loss for DMW under different ONU buffer size values

To achieve better network performances out of the above results, the best network parameter for 3 wavelengths, 32 ONUs, and 20km ONU/OLT distance based network will be with 3% safety margin, the number of ONUs in each service level set to 16-8-4-4 from low to high, 1.5 ms the maximum cycle time, and the ONU buffer size set to 10 Mbit.

#### 5.4 *Summary*

The DMW algorithm methodology and the corresponding protocol enhancements have been presented to accommodate multi-wavelength operation over splitter-based GPONs by means of smoothly upgrading the existing single-wavelength network infrastructure. This upgrade has been achieved by allocating the ONUs traffic serially among the supported wavelengths by using the additional bits in the frame fields of the GPON upstream format map to define the operating wavelength and packet type transfer for each ONU. The performance benefits of the multi-wavelength operation include aggregated transmission bit-rate about 3.7 Gbit/s in the presence of 3 wavelengths and 32 ONUs, 100 Mbit/s minimum bandwidth per ONU, and a considerable reduction in the mean packet delay in comparison with a resourceful single-wavelength GPON topology. The 0.003 s packet delay at typical network utilisation rates and the worst case 0.1 s at heavy loading, allow for undisruptive communication of the highest specification interactive services even at increased, ONU penetration and reach capabilities.

# 6 DMW-SWA Protocol Enhancements

---

This chapter starts by providing, the possible limitations associated with the dynamic-multi-wavelength protocol presented in the previous chapter and potential solutions. Consequently an Advanced Dynamic Multi-Wavelength (ADMW) algorithm is introduced aiming mainly to minimise the network mean packet delay by 1 msec. Improving the protocol performance further to be the so called Extended Bandwidth Dynamic Multi-Wavelength (EBDMW) algorithm is introduced to demonstrate 1240 Mbit/s throughput for each network channel.

## 6.1 *Introduction*

To summarise in succession the principal properties and enhancements in bandwidth allocation achieved by the application and development of the algorithms presented so far, the DMB algorithm selects one of the ONUs with the highest SLA and allocates it at the end of the transmission cycle providing in this manner the biggest transmission window for that ONU. Nevertheless, in real network scenarios the individual ONU bandwidth demand is variable from one cycle to another. Consequently, the DMW algorithm, after the OLT allocates  $ONU_{Allocated}^i$  to each ONU, will select the highest allocated bandwidth ONU at each cycle and locate it at the end of the cycle-time.

Even though the DMW algorithm exhibits superior traffic allocation management over the DMB, the multi-wavelength domain operation raises additional challenges that would need to be addressed for optimum protocol performance. The first challenge is synchronisation between wavelengths, as the OLT will need to wait until after the last network ONU report message has arrived before it starts calculating and allocating bandwidth. The issue raised here is the time difference between the last arriving report message and the last transmission ONU. In the case of single-wavelength operation, the last transmission interval belongs to the last transmitting ONU. In multi-wavelength operation though, the last transmission interval in a wavelength is not necessarily related to the last transmitting ONU in the network, as seen in Figure 5-5, since the OLT manages bandwidth in the network as a whole and not on a wavelength basis.

Secondly and equally important, the intra-cycle bandwidth management process followed in the DMW algorithm by limiting the ONU upstream transmission to only one wavelength at a time, for the purpose of reducing the ONU cost, even when using the safety margin is limiting the cycle duration to the maximum cycle limit. To that extent, it could easily be the case that one of the wavelengths for example is fully utilised while the remaining underused. This chapter attempts to address and provide solutions to these issues.

## ***6.2 Advanced Dynamic Multi-Wavelength (ADMW) Protocol***

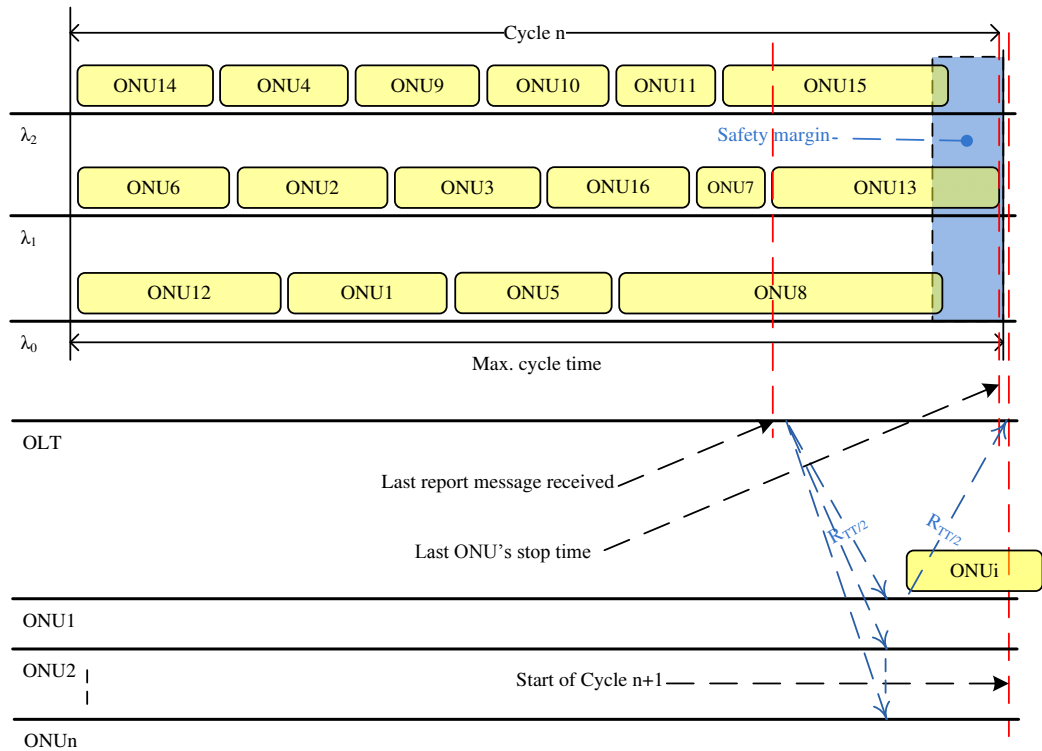
Two approaches can be applied to improve the network utilisation and to reduce the idle time between adjacent cycles. The first approach would be dealing with each wavelength separately in a form of multiple single-wavelength

protocols running in parallel by the OLT. Although this would provide a solution to the synchronisation issue, it would overcomplicate the devised protocol by means of complex algorithms. These would need to firstly manage the individual wavelength DBA algorithms, secondly, assign ONUs among the supported wavelengths, and finally deal with the start and the end times of each wavelength's cycle. In contrast, a new advanced-DMW (ADMW) could be implemented as will be analysed in the following sections.

### **6.2.1 Protocol Development and Bandwidth Allocation Mechanism**

While in the DMW algorithm the ONU with the highest allocated bandwidth is positioned first and at the end of the transmission cycle, in the ADMW algorithm, the OLT will select and assign the  $n$  (where  $n$  is the number of supported wavelengths) ONUs with the highest allocated bandwidth at the transmission tail of each wavelength as shown in Figure 6-1.





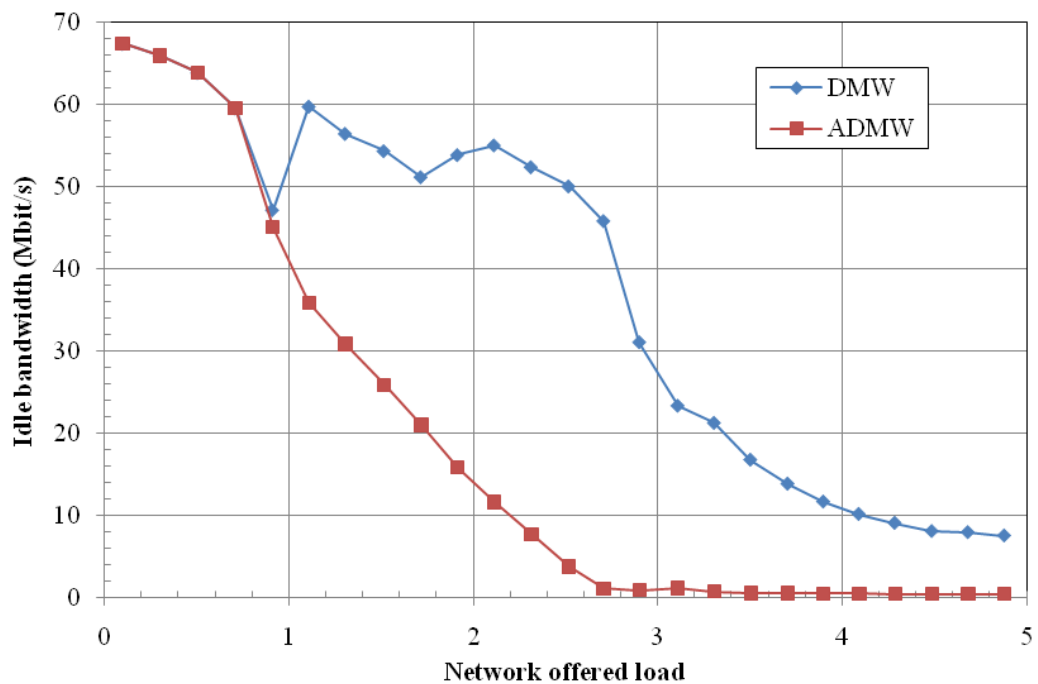
**Figure 6-1: ONU traffic allocation in view of the ADMW algorithm**

In contrast to the DMW algorithm, the OLT in ADMW first sorts the bandwidth allocated bandwidth to ONUs in order, from high to low, and then it selects the first  $n$  (where  $n=1,2,\dots$  the supported wavelengths) highest ONUs and assigns each one of them randomly to the end of each wavelength cycle. Consequently, the remaining DMW algorithm processes apply as described in chapter 5. The application of the ADMW algorithm is expected to reduce the idle times between cycles for each of the supported wavelengths and as a result in a uniform wavelength throughput utilisation as will be confirmed by the forthcoming results.

### 6.2.2 Implementation analysis, and Performance evaluation

Implementation of the ADMW-SWA protocol requires modifications to the OPNET network models although at the very slightest. In particular, the OLT process model would need to reflect the ADMW requirement in assigning the selected highest ONUs at the end of each wavelength in every cycle. This was achieved by only changing the code in the OLT process model.

As a first measure of the new protocol performance, the adjacent cycles' idle time (or bandwidth) profile is shown in Figure 6-2. Contrasted to the DMW algorithm a clear reduction in the overall network idle intervals is portrayed with a much smoother, continuously decreasing characteristic drawn for the ADMW algorithm from very low values of network load corresponding to less than wavelength occupancy. This becomes obvious if thought that the highest bandwidth ONUs are assigned first and while the load increases, the second highest bandwidth occupancy ONUs are assigned to available time slots for each wavelength not leaving empty slots. Finally the idle-time (wasted-bandwidth) recorded under higher network offered load for the DMW algorithm reaches its minimum value at around 7 Mbit/s. The equivalent value for the ADMW algorithm is less than 1 Mbit/s.



**Figure 6-2: Average idle bandwidth between cycles for the DMW and ADMW algorithms**

As seen in Figure 6-3, the throughput performance of the ADMW-GPON resembles that of the DMW concerning the fact that when the operating wavelengths reach their maximum capacity in succession, a serial wavelength loading approach is still utilised. It is worth noticing though that each wavelength has recorded 10 to 20 Mbit/s increase in throughput compared to the individual wavelengths with the DMW algorithm.

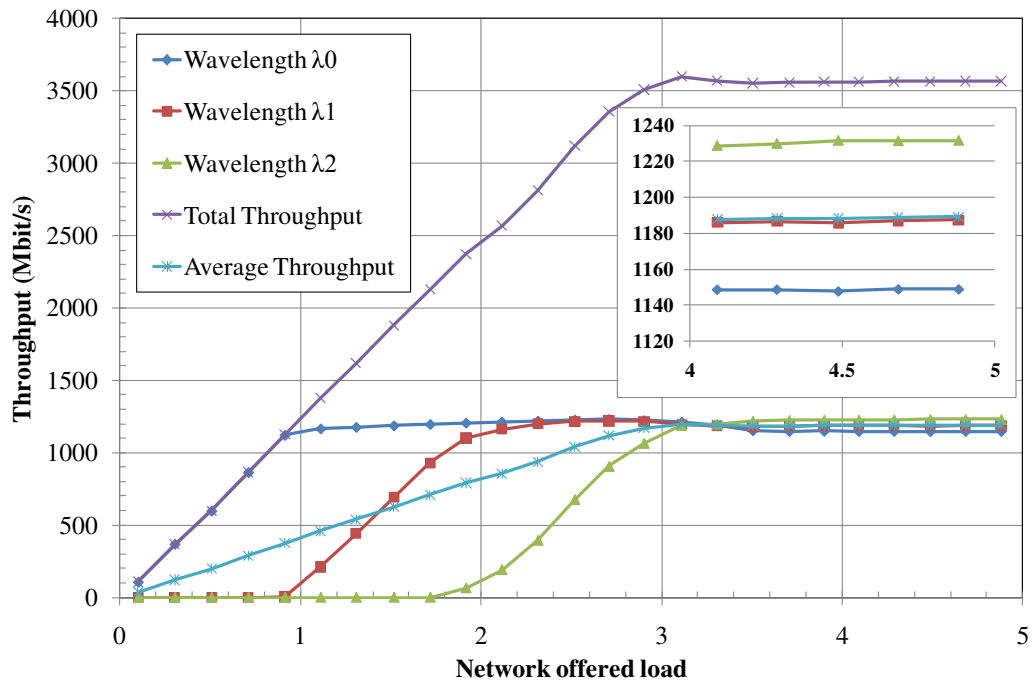
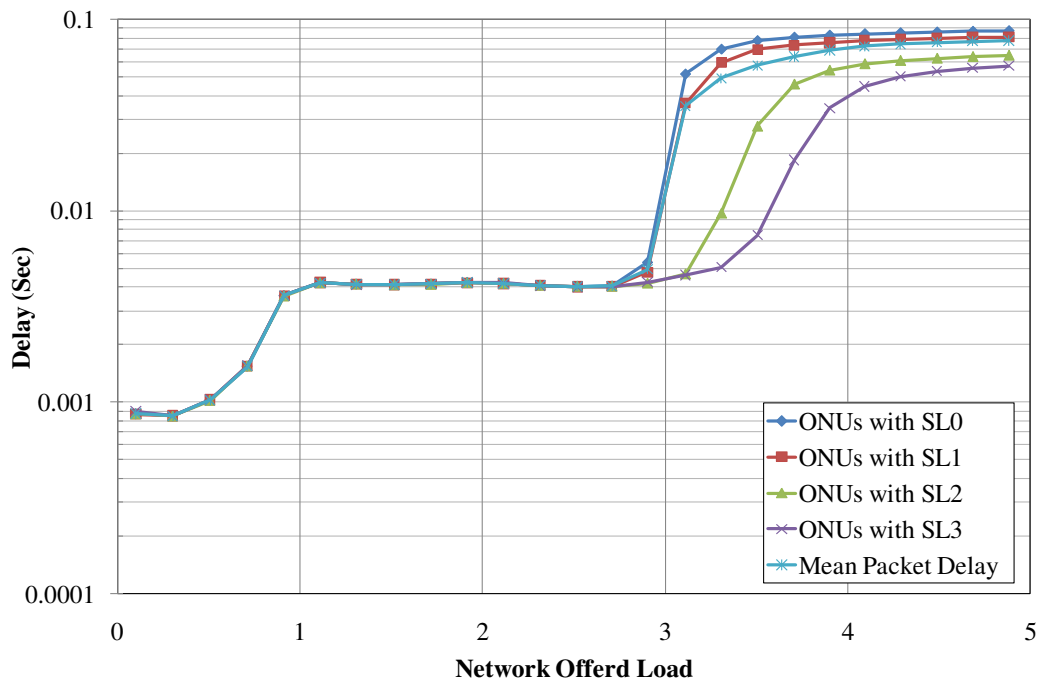


Figure 6-3: Throughput performance for ADMW-GPON

The decreased adjacent-cycles' idle time is expected to reduce the buffering time in the ONUs, that will result a less waiting-time for the stored packets for the next cycle to be transmitted. This is reflected in Figure 6-4, where the ADMW packet delay performance displays a reduction of 1 ms at high network load compared to the DMW protocol, that will provide a relaxed accommodation for delay sensitive application [56, 153] at the higher network load.



**Figure 6-4: Packet delay performance of the ADMW-GPON for different service levels**

An additional performance characteristic is introduced at this point to compare between the two algorithms, known as the intra-cycle's idle time (or bandwidth). The intra-idle time's maximum value is reported at the beginning of each wavelength's utilisation, decreasing progressively till the OLT introduces another wavelength and soon. Although there is not significant performance variation between the DMW and the ADMW algorithms since they both populate wavelengths in succession, this performance criterion will be proven extremely important in evaluating the current protocols with the one to be described later. Also it was not necessary to compare between the DMW and the single-wavelength DMB algorithms in previous chapters given that the idle-time (wasted bandwidth) figure within the cycle is not applicable for single-wavelength DBAs.

As shown in Figure 6-5 though, the ADMW shows less intra-cycle idle bandwidth compared to the DMW algorithm especially during the second and third wavelength population processes as a result of the decreased cycle time. This is because of the ONU's allocation mechanism in ADMW, and the limited idle time within the cycle, compared to longer cycle time in DMW which results more idle time within the cycle especially below the full network load. This reduction adds to the adjacent-cycle idle time figure to increase the total network throughput.

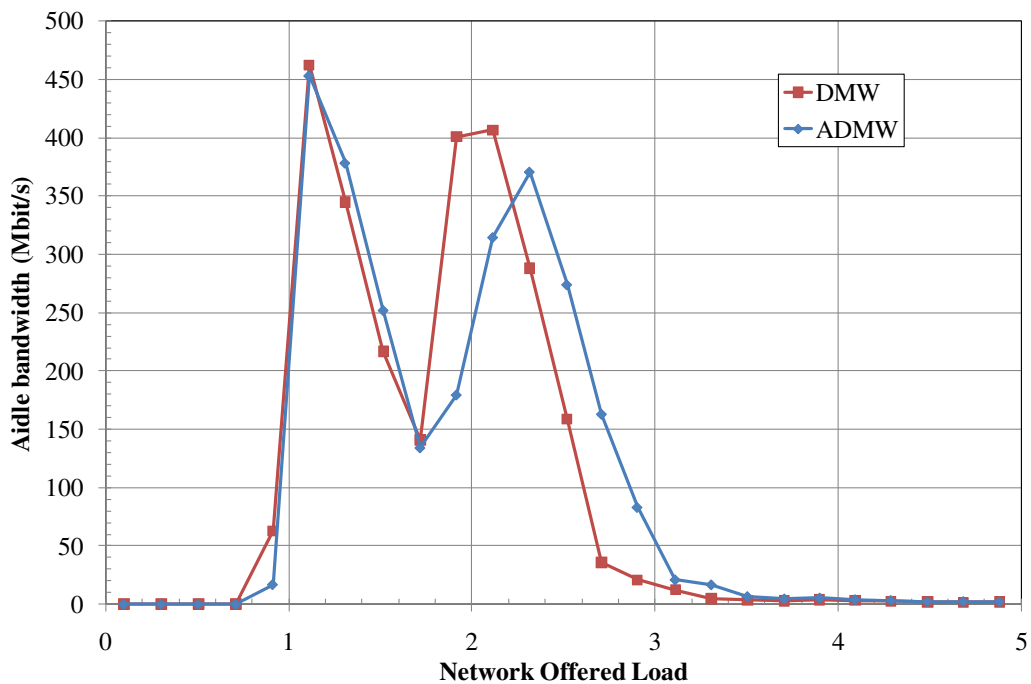


Figure 6-5: total idle bandwidth per cycle for ADMW and DMW algorithms

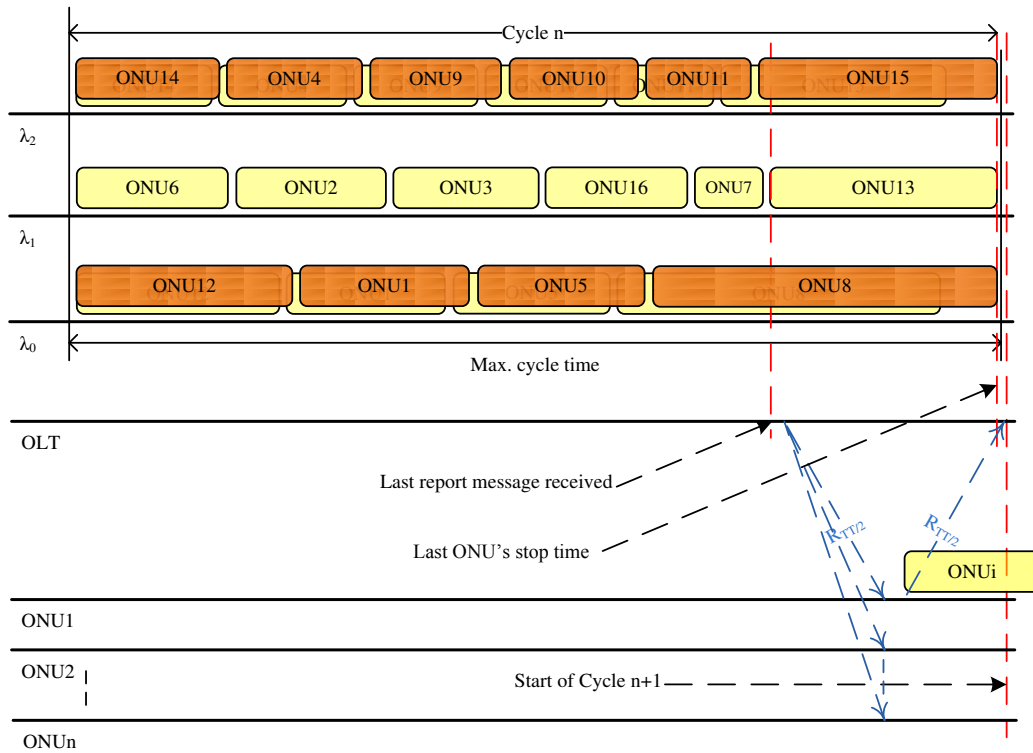
### 6.3 *Extended-Bandwidth DMW (EBDMW) Protocol*

By transmitting upstream traffic on only one wavelength at a time, each cycle is more likely to result in unutilised slots in one or another of the supported wavelengths. To resolve this issue, ONUs and OLTs could be modified to allow

for multiple wavelength propagation in each cycle resulting of course in more laborious network elements and therefore increased cost at the physical layer. Alternatively, this issue could be resolved at the MAC layer with the introduction of a more sophisticated protocol and associated algorithms. To that extent the EBDMW algorithm is described next.

### **6.3.1 Protocol development and the Bandwidth Allocation Mechanism**

Normally in the DMW and ADMW algorithms, the OLT allocates the requested or maximum allowed bandwidth to each ONU during each cycle, while the ONU buffer still receives data still expected to be transmitted alongside the already stored packets based on which the bandwidth allocation process is based. As a result and this is very common fact in real networks, an ONU's buffer size is expected to be bigger at the time of sending the gate messages from the OLT.



**Figure 6-6: ONU traffic allocation with the EBDMW algorithm**

Figure 6-6 describes the operation of the EBDMW algorithm, where the OLT initially assigns the allocated bandwidth to its supported wavelengths similarly to the ADMW algorithm, and in succession it calculates the unused bandwidth per wavelength ( $B_{\lambda}^{unused}$ ), then divides this bandwidth equally between the total number of ONUs assigned to each wavelength ( $ONU_{\lambda}^{total}$ ) to determine the extra bandwidth for each ONU ( $B_{Extra}^{\lambda}$ ). As seen in Equation (6-1) defines this operation.

$$B_{Extra}^{\lambda} = \frac{B_{\lambda}^{unused}}{ONU_{\lambda}^{total}} \quad (6-1)$$

The final allocated ONU bandwidth ( $ONU_{Final\_Allocated}^i$ ) will be calculated by the OLT using equation (6-2) which optimises each individual wavelength's



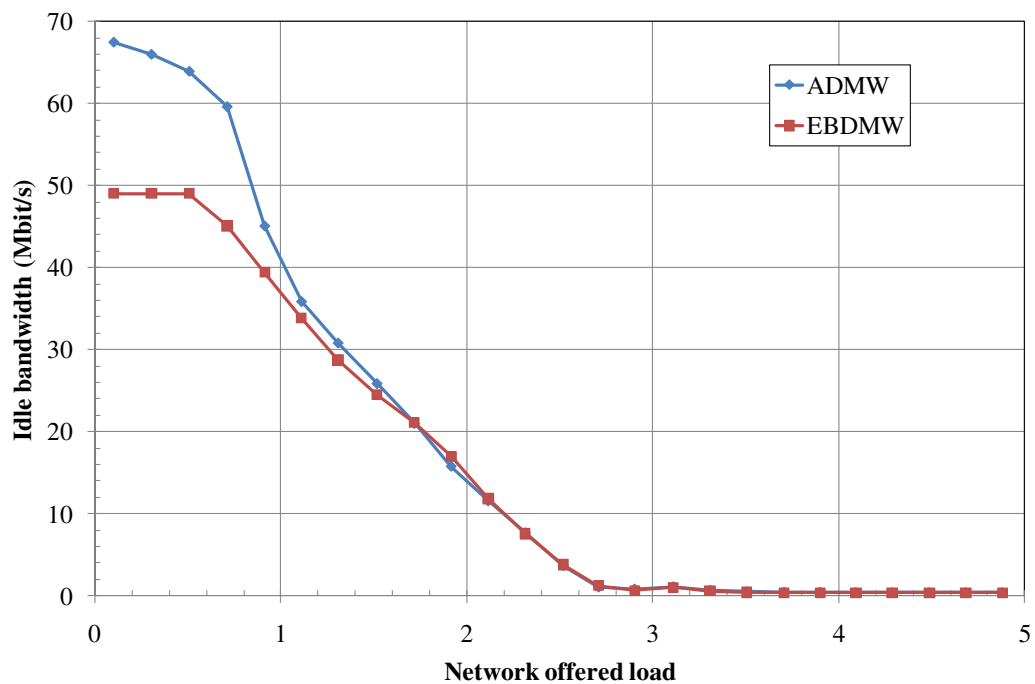
utilisation by adding an extra bandwidth  $B_{Extra}^\lambda$  to its original allocated bandwidth  $ONU_{Allocated}^i$ . This signifies a lower packet delay especially under higher network offered load compared to the previous DMW and ADMW algorithms as will be confirmed by the simulation results to follow.

$$ONU_{Final\_Allocated}^i = ONU_{Allocated}^i + B_{Extra}^\lambda \quad (6-2)$$

### 6.3.2 Implementation analysis, and Performance evaluation

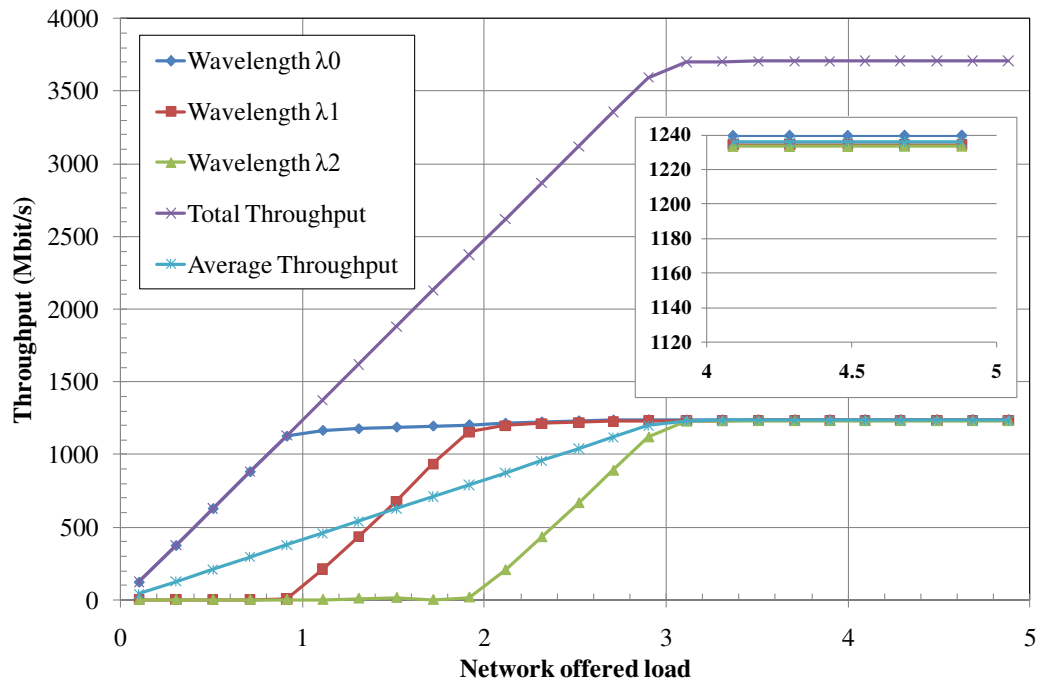
Once again, the OLT process model is modified and adjusted to account for the EBDMW protocol functionalities with regards to reallocating the unused bandwidth in each wavelength to its assigned ONUs before sending the corresponding gate messages.

The same performance figures were plotted as with previous algorithms for clarity and comparison purposes. The adjacent cycle's idle time performance is shown in Figure 6-7. A further reduction of approximately 20 Mbit/s compared to the ADMW algorithm is monitored in use of the new algorithm. This applies only at lower network load, corresponding to assigning bandwidth below one wavelength's capacity.



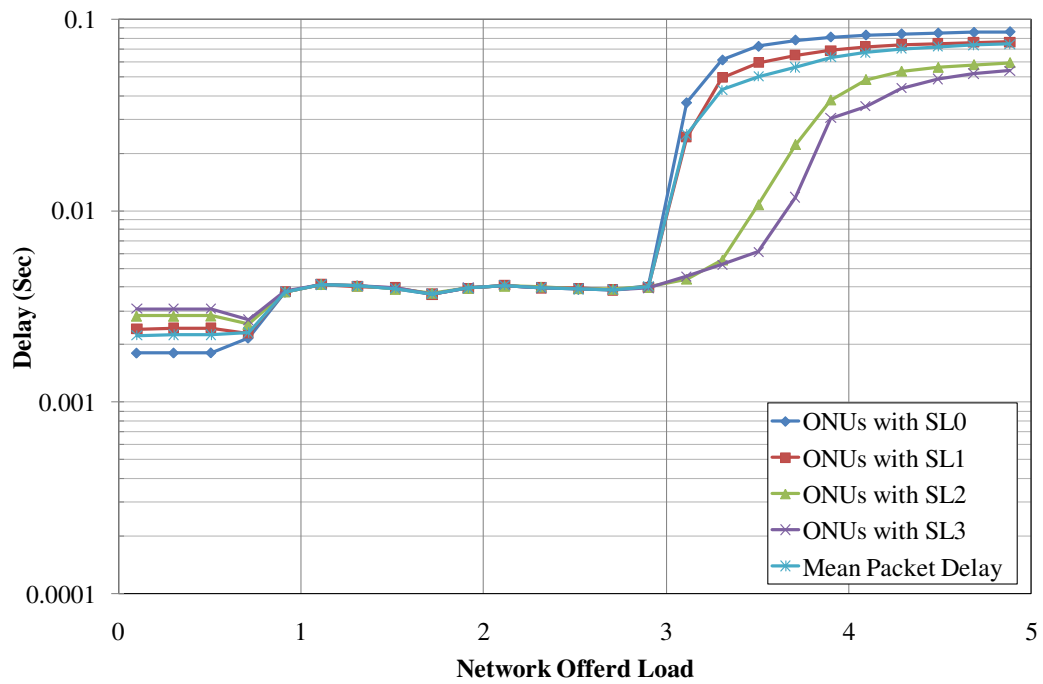
**Figure 6-7: Average idle bandwidth between cycles for the ADMW and EBDMW algorithms**

Following, as seen in Figure 6-8, the throughput figure of the EBDMW-GPON confirms clearly that individual wavelength channels reach their maximum throughput between 1235 Mbit/s and 1240 Mbit/s, which leads to a network utilisation higher to the preceding algorithms by 60 Mbit/s per each wavelength at worst case, bringing in total a minimum of 180 Mbit/s throughput improvement over DMW.



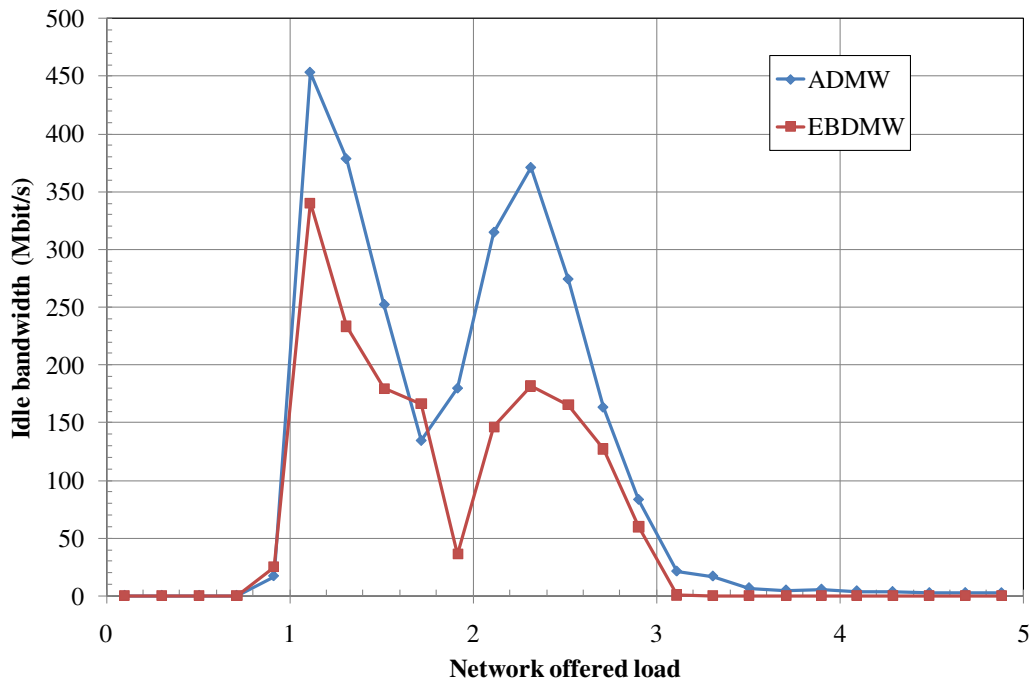
**Figure 6-8: Throughput performance for EBDMW-GPON**

Furthermore, the mean packet delay performance in Figure 6-9 follows the same pattern compared to the ADMW protocol in Figure 6-4 except for the area below one wavelength load where all network's ONUs are sharing one wavelength since the transmission cycle time is increased. Since the EBDMW algorithm divides the unused bandwidth equally between ONUs, the higher SLA ONUs get less extra bandwidth compared to the lower SLA ONUs which result in a higher delay. Even with this increased delay below one wavelength load compared to ADMW algorithm though, the mean packet delay for the EBDMW-GPON is still below 3 ms, allowing for the successfully transmission of real time applications at low and high traffic.



**Figure 6-9: Packet delay performance for EBDMW-GPON for different service levels**

Finally the total intra-cycle idle time trace, shown in Figure 6-10, confirms a much more robust bandwidth utilisation for each wavelength, expected due to the extra calculation and reassignment of the idle time slots. This is particularly obvious in wavelengths under low load where bandwidth wasting is more probable to occur.



**Figure 6-10: Wasted bandwidth per each cycle for ADMW and EBDMW algorithm**

To give a more general picture, of the performance merits of the DMW protocols, at its various flavours, developed in this thesis, a comparison with the DMB protocol is attempted. The various characteristics are plotted in Figure 6-11 to Figure 6-13. In Figure 6-11, the average idle bandwidth between adjacent cycles is recorded at 40 Mbit/s at higher network load using the DMB algorithm, while the equivalent value in view of the EBDMW algorithm is below 1 Mbit/s. The individual wavelength throughput performance for the EBDMW-GPON in Figure 84 reaches 1240 Mbit/s for each wavelength, while the channel throughput for the DMB is limited to 1160 Mbit/s for the same number of ONUs. Significantly the mean packet delay performance, exhibited in Figure 6-13, shows a reduction of 150 ms at high network offered load when the EBDMW protocol is applied compared to its DMB competitor, which gives the application with low

delay requirements [56] the ability to be transmitted smoothly even over higher network load.

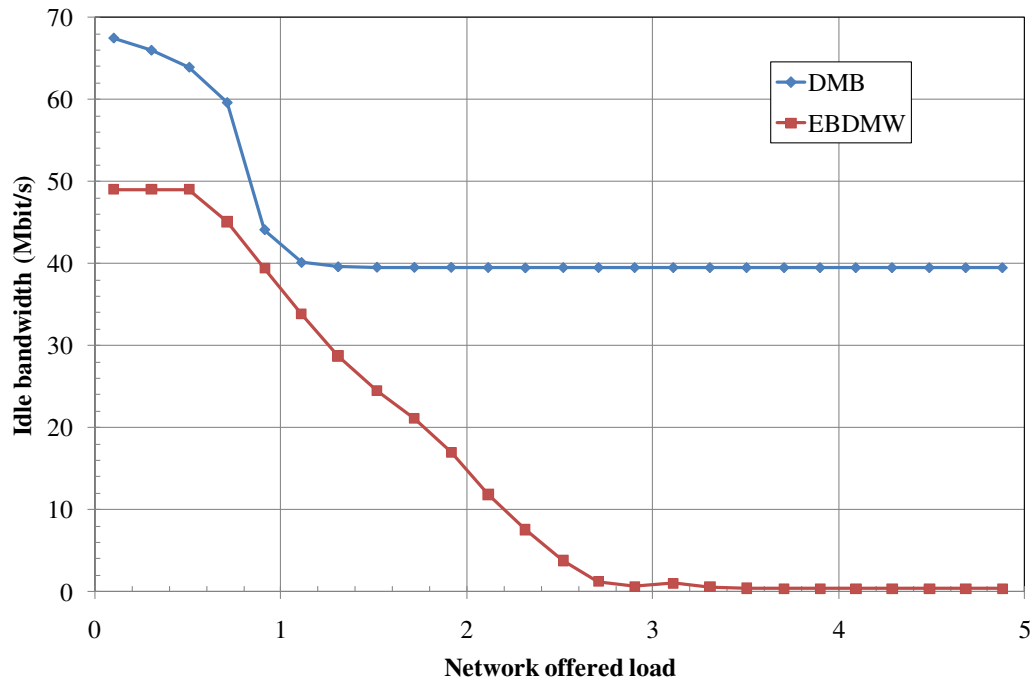


Figure 6-11: Wasted bandwidth between cycles for DMB and EBDMW algorithms

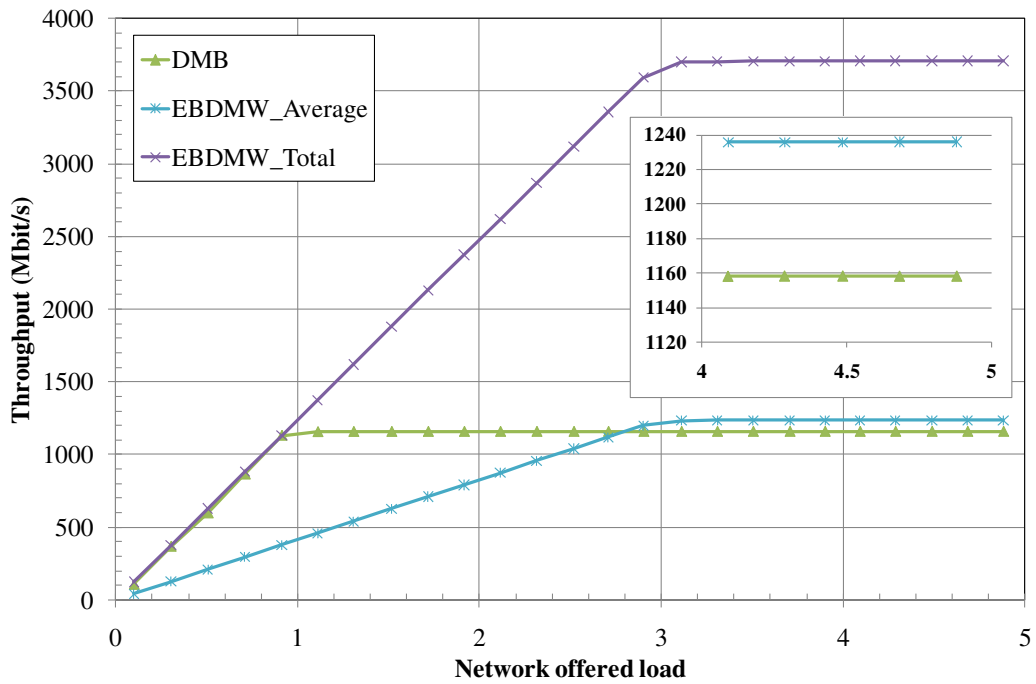


Figure 6-12: Throughput performance for DMB and EBDMW GPON

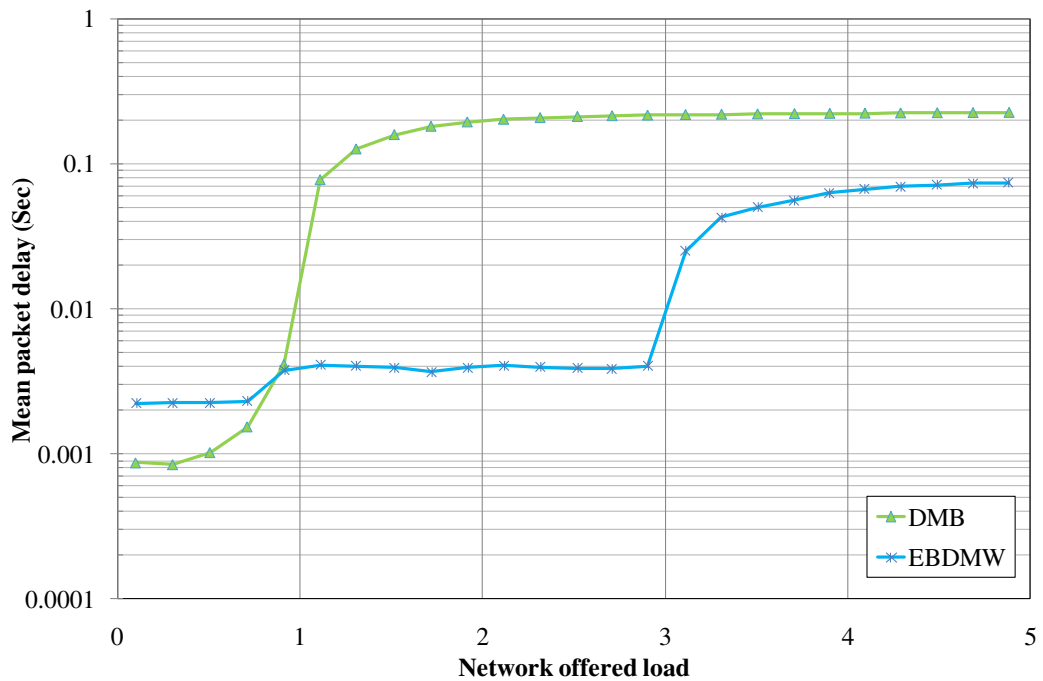


Figure 6-13: Mean packet delay performance for DMB and EBDMW GPON

## 6.4 *Summary*

Improving the DMW algorithm to resolve the limitation associated with dynamic multi-wavelength operation in form of transmission over one wavelength every cycle to reduce the ONU/OLT costs, can be achieved by developing new MAC protocols and their corresponding algorithms without any need to increase the network hardware cost and as a result greatly maintain the network models.

The ADMW algorithm improves the network utilisation while reducing the mean packet delay by allocating the highest traffic ONUs at the end of each wavelength transmission. With the aim of optimising the bandwidth allocation to reach a better channel throughput, the EBDMW algorithm uses the unemployed bandwidth per each wavelength to extend the allocated ONU bandwidth, which provides a maximum wavelength channel throughput compared to previous approaches.



# 7 DMW Protocol with Parallel Wavelength Allocation (PWA)

---

This chapter introduces a new DMW algorithm to assign ONU traffic among the supported network wavelengths by enhancing the recent two well performing ADMW and EBDMW protocols with a Parallel Wavelength Allocation (PWA) mechanism. If the ADMW-PWA algorithm is applied, a shorter cycle-window and reduced mean packet delay is achieved before the network is fully loaded with a minimum idle time between the adjacent cycles. Finally, the EBDMW-PWA algorithm performance characteristics are investigated and analysed.

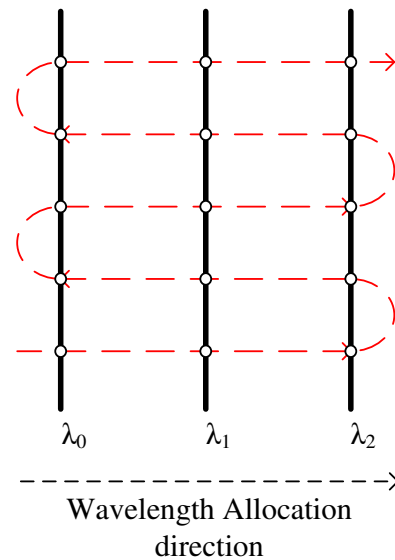
## 7.1 *Introduction*

Using the Serial Wavelength Allocation (SWA) mechanism to allocate ONU traffic in each cycle, as presented in the previous chapters, can help saving some of the operational life-time of the optical transmitter and receiver in both the OLT and ONU. This saving in particular occurs at low network load by employing the only needed wavelength from the network supported wavelength band to handle the total requested bandwidth. Although moderate, the cycle duration associated with SWA, presented in the results in preceding chapters, could result in a relatively high packet delay for some applications which is almost equal to the cycle duration time plus a small ONU queuing delay. An

example of these applications can be found in the use of a PON network to connect the base stations in wireless mobile networks [154, 155]. While delay is set to be low during the normal call-handover process between the neighbouring cell base stations [59], the PON network needs to provide a lower delay because the mobile base station requires to exchange more than ten control packets at a short time to complete the call-handover process [59]. Therefore, to adjust the DMW-GPON to be able to support wireless backhauling [154, 155], a PWA is needed as will be evaluated in this chapter to primarily reduce the cycle duration and consequently to minimise the overall packet delay.

## ***7.2 Development of the DMW-PWA protocol***

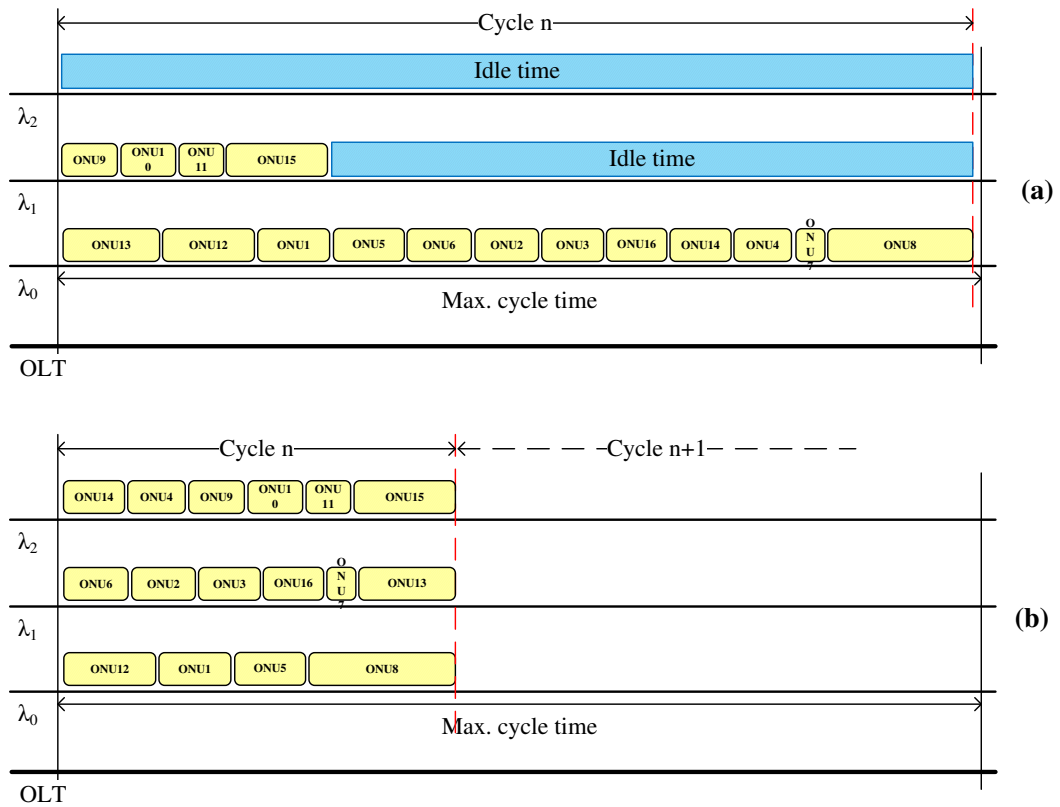
Instead of populating the supported wavelengths in sequence, as demonstrated with SWA, the PWA mechanism, presented in Figure 7-1 assigns the network ONUs to operating wavelengths for the coming cycle by assigning the first considered ONU to  $\lambda_0$ , second considered ONU to  $\lambda_1$ , third to  $\lambda_2$ , reaching up to  $\lambda_n$  and then the (n+1) ONU also assigned to  $\lambda_n$ , progressing this time downwards and so on till all ONUs are assigned to wavelengths.



**Figure 7-1: Parallel wavelength allocation mechanism**

As shown in Figure 7-2(a), if a DMW-SWA network is generally unutilised but at more than one wavelength equivalent capacity, the full use of the first wavelength will force the cycle duration to reach its maximum and as a result since the remaining wavelengths will display the same cycle duration, massive idle times will be recorded. The characteristic performance of the idle bandwidth can be seen in Figure 6-5 and Figure 6-10 in chapter 6.

Using PWA to assign the ONUs, as seen in Figure 7-2(b), will not only reduce the cycle time duration under low network load, but it will also eliminate the idle bandwidth in each cycle, maintained by the SWA. Similarly to SWA, the PWA mechanism still assigns the allowed bandwidth to each ONU based on its requested bandwidth and SLA.



**Figure 7-2: ONU's traffic allocation under low network traffic, (a) for Serial Wavelength Allocation (SWA), and (b) for Parallel Wavelength Allocation (PWA).**

### 7.3 DMW-PWA Bandwidth Allocation Mechanisms

To transfer to the new wavelength allocation mechanism, the protocol bandwidth assignment stages need to be modified, starting by calculating and assigning the available bandwidth to allocating ONUs to wavelengths. In the first stage, after the OLT receives the requested bandwidth from each ONU, it assigns the allocated bandwidth to  $ONU_i$  ( $ONU_{Allocated}^i$ ). Consequently, and to split the ONUs into  $n$  ( $n$  is the supported wavelength number) groups during the wavelength assignment, a virtual total bandwidth ( $B_{total}^v$ ) limit is introduced, as defined in equation (7-1).

$$B_{total}^v = \sum_{i=1}^N ONU_{Allocated}^i + Safety\ Margin \quad (7-1)$$

The virtual total bandwidth ( $B_{total}^v$ ), will be used to calculate the virtual maximum bandwidth limit for each wavelength ( $B_{\lambda}^v$ ), which is used as a threshold during the wavelength allocation of ONU traffic, and is given by equation (7-2):

$$B_{\lambda}^v = \frac{B_{total}^v}{n} \quad (7-2)$$

As explained earlier in chapter 6, the second stage is introduced to manage the network bandwidth allocation process in a more efficient manner either by using the ADMW algorithm to allocate the highest ONUs traffic at the end of each wavelength reducing the adjacent cycles idle time, or by allocating the unused bandwidth within a cycle in each wavelength to its assigned ONUs, using the EBDMW algorithm. In the final stage, the OLT assigns the ONU time-slots to different wavelengths in parallel, by filling the first wavelength  $\lambda_0$  until the total wavelength assigned bandwidth is equal, or less than the virtual maximum bandwidth limit ( $B_{\lambda_0}^v$ ). When it is full, the OLT starts filling the next wavelength in the same way until it reaches  $\lambda_n$ . This process allows the OLT to guarantee that ONU traffic is assigned fairly between the supported wavelengths. This approach potentially produces a shorter polling cycle length at low network utilisation resulting in a reduction in the ONU upstream packet waiting-time in the proceeding cycles, and hence decreasing the mean packet delay at low traffic.

#### 7.4 *Model Implementation and Analysis*

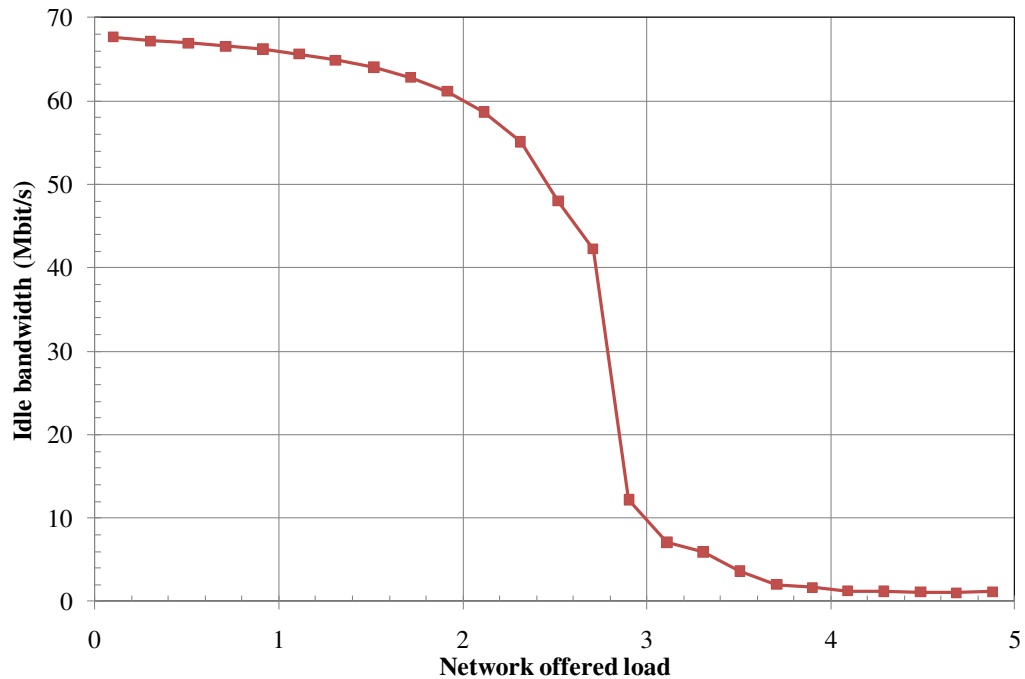
A DMW-GPON with a PWA scheme is modelled using the OPNET v.14.5 platform, including a single multi-wavelength OLT and 32 multi-wavelength ONUs with varying weights representing different service levels at 1.24416 Gbit/s upstream and 2.488 Gbit/s downstream and 20 km link lengths. In addition, a 2 ms maximum cycle period and 96 bits guard-time are chosen to match the upstream data-rate. Network traffic is generated based on a Pareto self-similar traffic model with typical Hurst parameter of 0.8. Moreover, the ONU basic bandwidth for each service level,  $B_{basic}$  is set to 100 Mbit/s for four service levels. As previously explained, the safety margin used during the simulation of a network with three wavelengths is set to 3% of the maximum cycle time. The service level agreement diversity from high to low comprises 4 ONUs assigned at  $SLA_3$ , 4 ONUs at  $SLA_2$ , 8 ONUs at  $SLA_1$ , and 16 ONUs at  $SLA_0$ , to simulate a progressive network usage.

#### 7.5 *Simulations and Performance evaluation*

The PWA mechanism was tested in view of the application of both the ADMW and EBDMW algorithms. Apart from comparing the algorithms, the performance characteristics among the wavelength allocation mechanisms are expected to be of increased interest.

Figure 7-3 exhibits the average idle bandwidth between adjacent cycles for the ADMW-PWA algorithm. The trace starts at 68 Mbit/s, slightly decreasing to

reach 60 Mbit/s at two wavelengths equivalent network load, with a dramatic drop thereafter to reach less than 2 Mbit/s at high network traffic



**Figure 7-3: Average idle bandwidth between cycles for the ADMW algorithm with PWA**

By observing its throughput performance in Figure 7-4, it can be clearly noticed that the parallel wavelength assignment mechanism achieves all the supported wavelengths sharing the network load. While the individual wavelengths are equally utilised at lower network offered load, they are quite distinguished at higher network load, ranging between 1120 Mbit/s and 1240 Mbit/s, achieving an average channel throughput of 1195 Mbit/s.

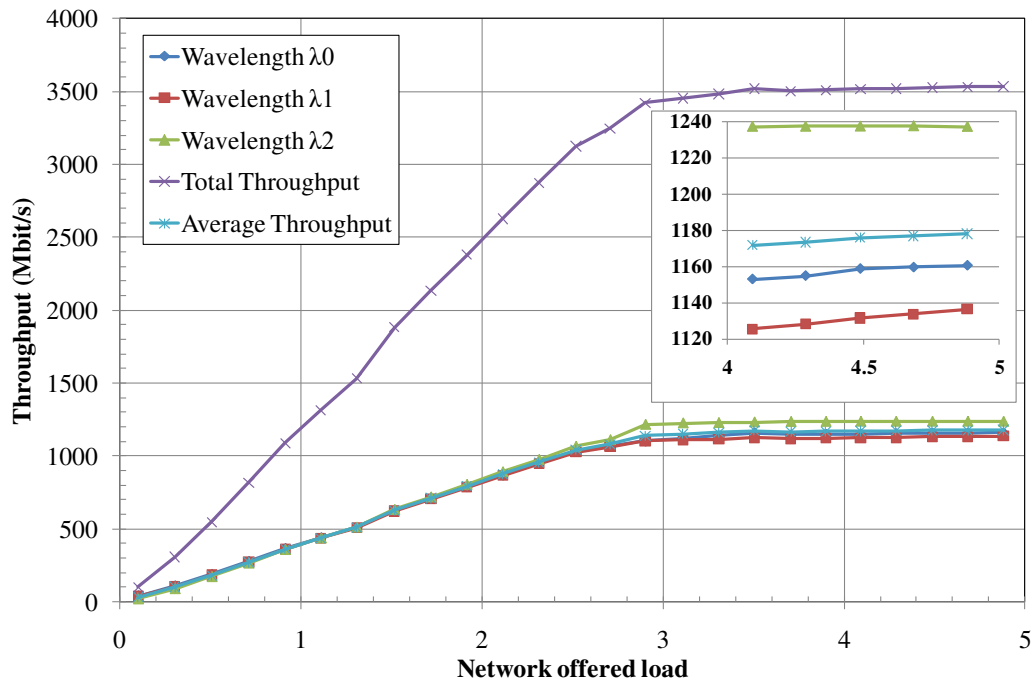


Figure 7-4: Throughput performance for ADMW-GPON with PWA

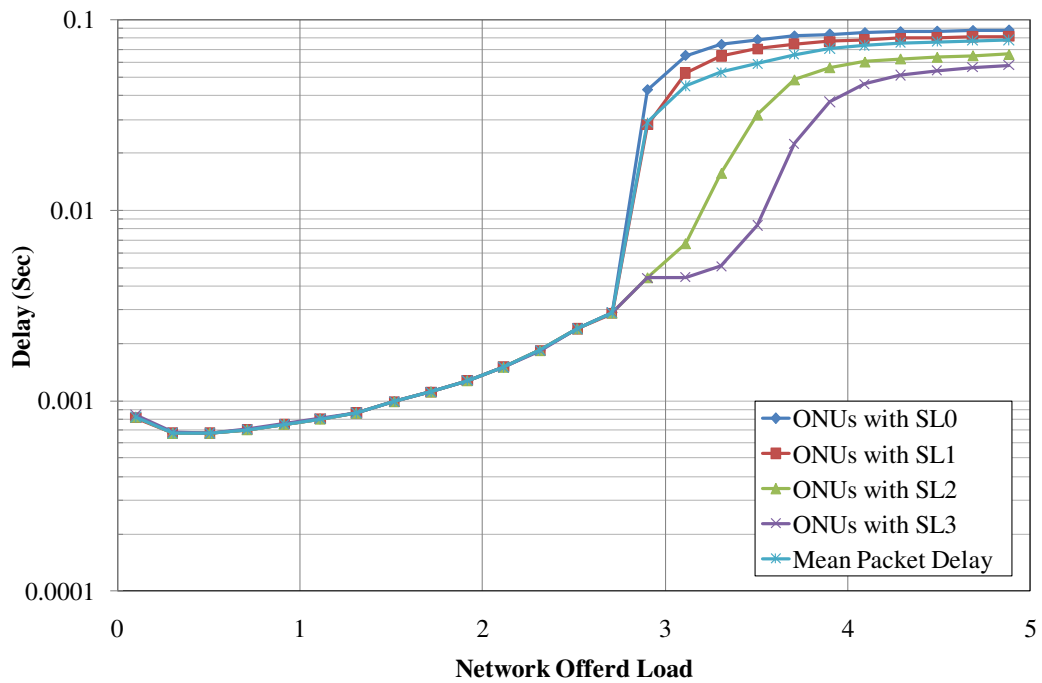
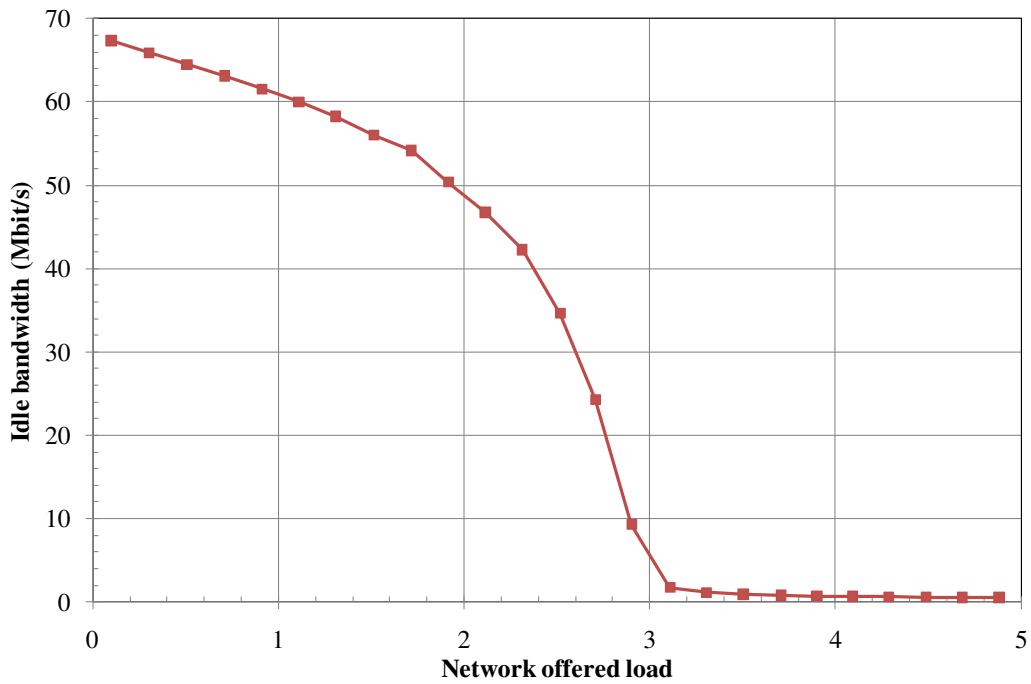


Figure 7-5: Packet delay performance for ADMW-GPON with PWA for different service levels



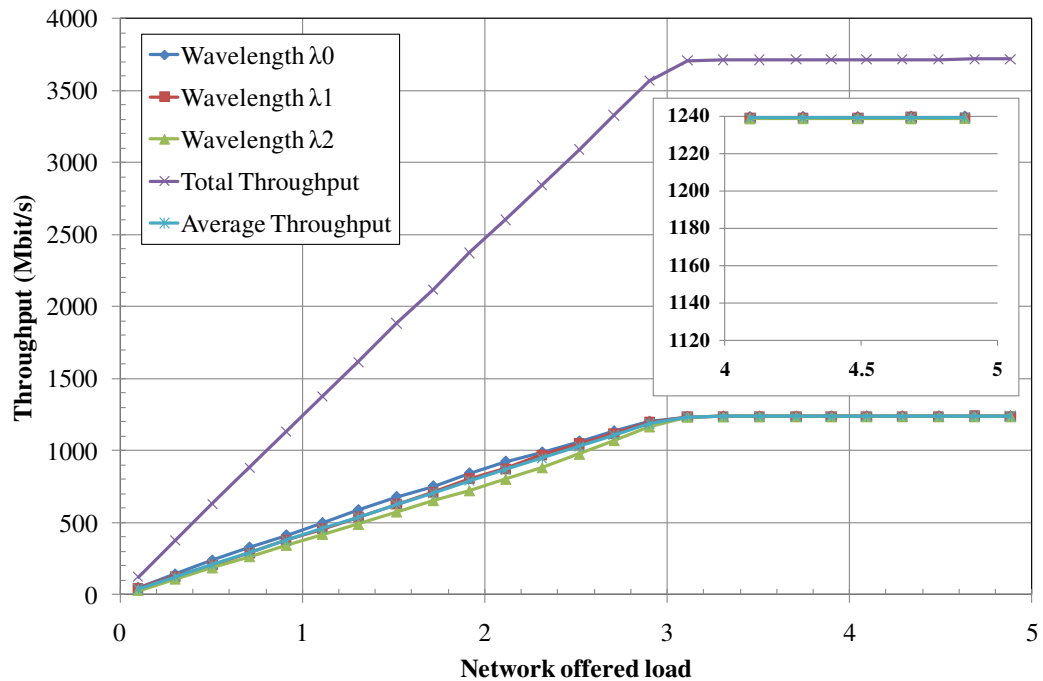
With respect to the packet delay performance evaluation, as seen in Figure 7-5 and as a result of minimising the cycle duration by using parallel wavelength allocation, the mean packet delay at low network offered load is decreased to reach 0.7 ms, Consequently the characteristic increases following the network load(the cycle duration is increased as well) displaying a pattern similar to the SWA when the network load reaches a capacity equivalent of three wavelengths. It should be noticed though that the highest delayed SLA ONUs,  $SLA_0$  remain below 0.09 s.

The same performance characteristics were plotted in view of the EBDMW algorithm with a PWA mechanism. Figure 7-6, displays the average idle bandwidth between adjacent cycles reaching down to less than 2 Mbit/s at three wavelengths equivalent network load, remaining steady thereafter even for increasing network load.



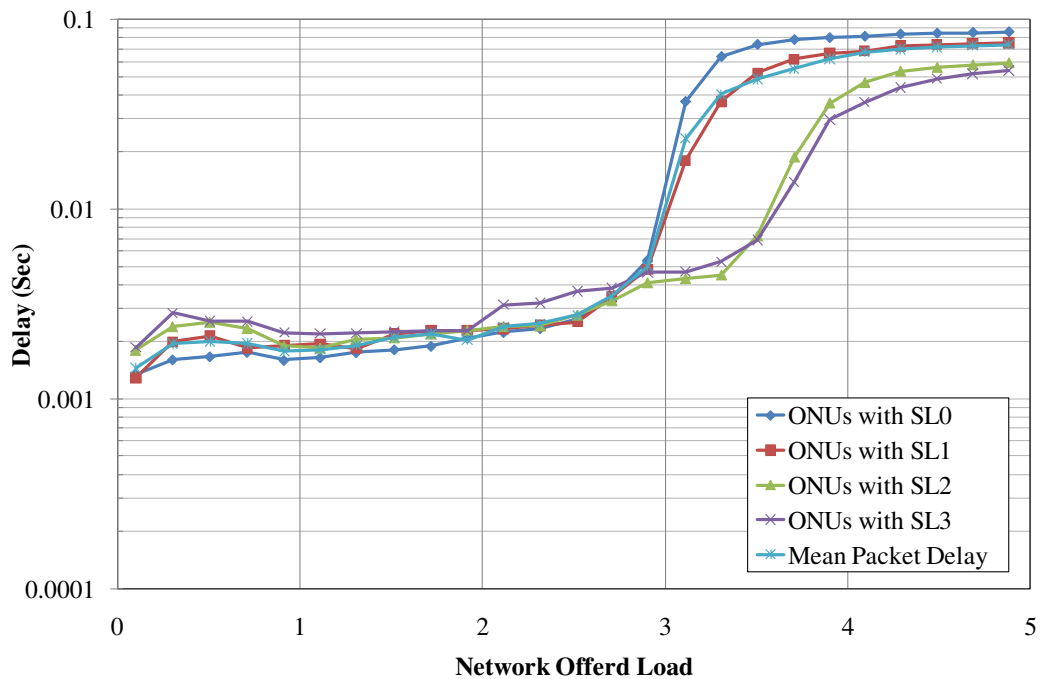
**Figure 7-6: Average idle bandwidth between cycles for EBDMW algorithm with PWA**

The throughput performance in Figure 7-7 indicates that the throughput of individual wavelengths is not exactly equal under low network load, as opposed to higher network load that they were fully utilised at 1240 Mbit/s each, due to the fact that the different SLA ONU groups share the same wavelength. A total throughput of 3720 Mbit/s has been achieved



**Figure 7-7: Throughput performance for EBDMW-GPON with PWA**

As can be seen in Figure 7-8, the packet delay for different service level ONUs is increased comparing between the EBDMW and ADMW algorithms, which was predicted previously because of the equal split of the unused bandwidth between the ONUs sharing the same wavelength. It could be argued that from that point of view the service level differences between ONUs is not considered (to reduce the algorithm complexity), and as a result the higher SLA ONUs do not benefit as expected at lower network offered load since it is at low traffic where extra bandwidth will be available. At high traffic, due to the simplified approach employed, network allocation will comfort to SLA more accurately.



**Figure 7-8: Packet delay performance for EBDMW-GPON with PWA for different service levels**

To summarise the performance of the PWA mechanism, Figure 7-9, Figure 7-10, and Figure 7-11 show a comparison between the ADMW and EBDMW algorithms. While Figure 7-9 shows a reduction in the adjacent cycle's idle bandwidth, Figure 7-10 shows an increase of 130Mbit/s in the total network throughput of the EBDMW compared to the ADMW algorithm. Finally, in Figure 7-11, while the mean packet delay of ADMW is less than that of EBDMW at low network offered load, the EBDMW algorithm shows a decreased mean packet delay at high network load compared to the ADMW algorithm allowing for network optimisation if potentially in a single operation.

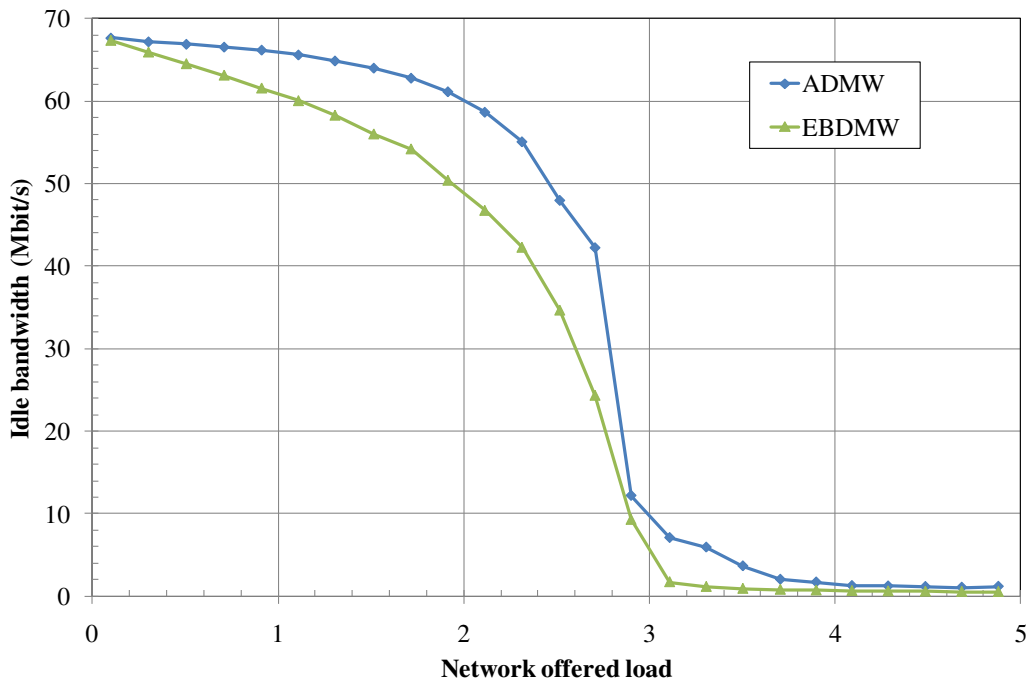


Figure 7-9: Average idle bandwidth between cycles for ADMW and EBDMW algorithms with PWA

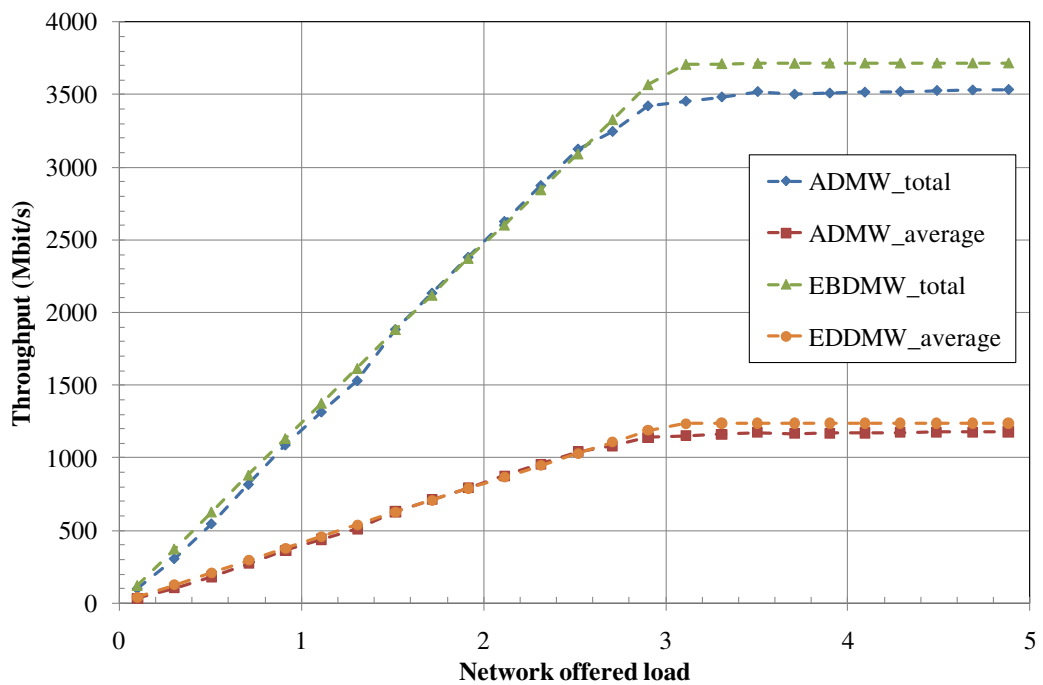
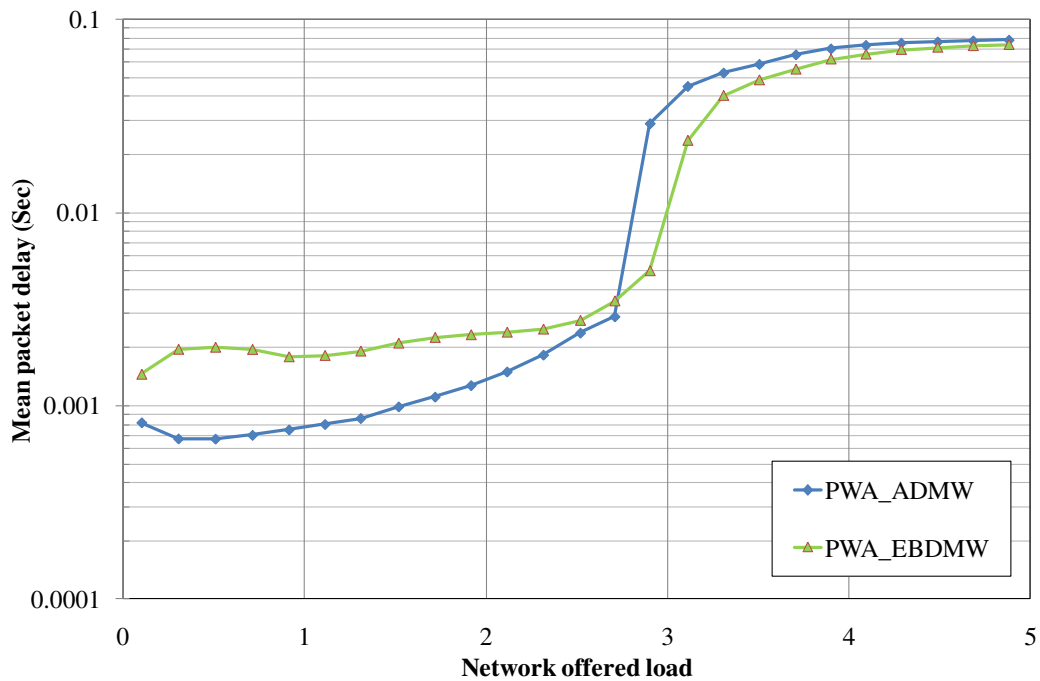


Figure 7-10: Throughput for ADMW and EBDMW GPON with PWA



**Figure 7-11: Mean packet delay for ADMW and EBDMW GPON with PWA**

To portray clearly the merits of the two wavelengths allocation mechanisms, a comparison is performed between them by using the ADMW algorithm with to draw Figure 7-12, Figure 7-13, and Figure 7-14, and the EBDMW algorithm for Figure 7-15, Figure 7-16, and Figure 7-17.

In Figure 7-12, SWA shows a reduced adjacent cycle's idle bandwidth because of the short cycle's duration in PWA, while in Figure 7-13, SWA shows a slight increase in the total network throughput compared to PWA. In Figure 7-14 though, PWA shows a major reduction in the mean packet delay compared to SWA because of the short cycles associated with parallel wavelength allocation during low offered load.

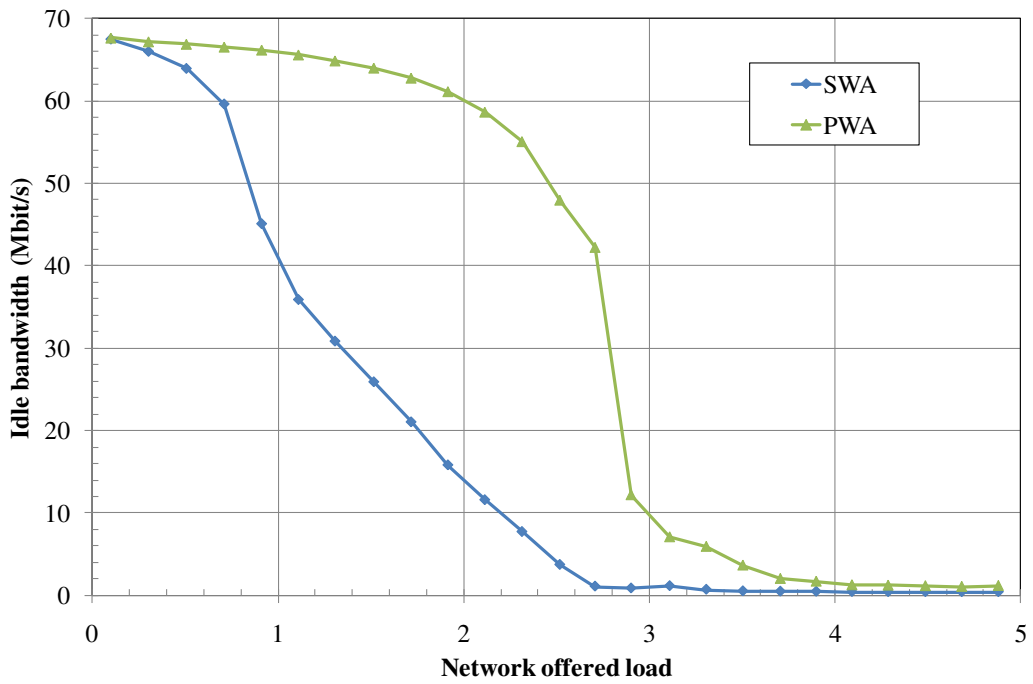


Figure 7-12: Average idle bandwidth between cycles for SWA and PWA with ADMW protocol

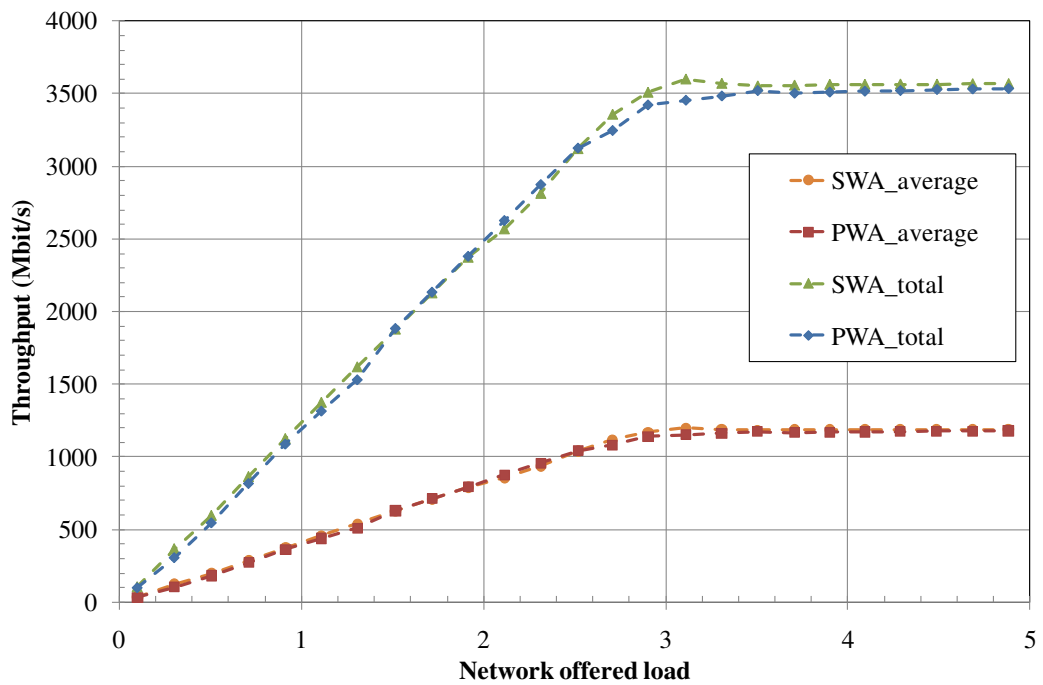
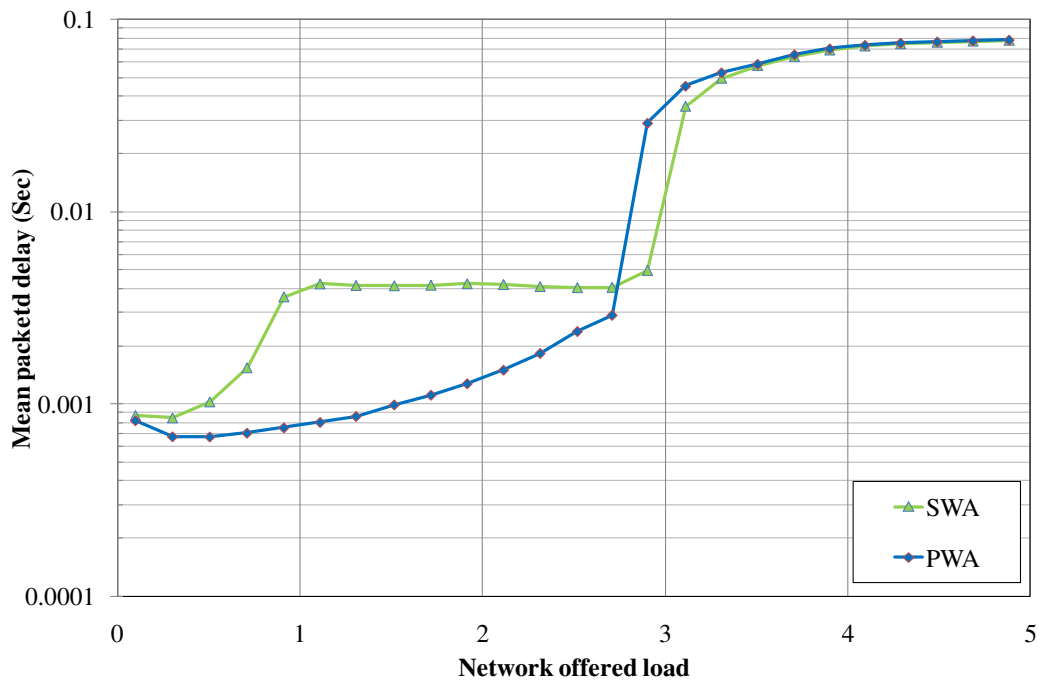


Figure 7-13: Throughput for SWA and PWA with ADMW protocol



**Figure 7-14: Mean packet delay for SWA and PWA with ADMW protocol**

Alternatively, using the EBDMW algorithm, Figure 7-15 shows a noticeable reduction again in the adjacent cycle's idle bandwidth of SWA compared to PWA for the reason the short cycle's duration in the PWA starts at 18 Mbit/s at low network load. However, in Figure 7-16, PWA this time displays a slight increase in the total network throughput compared to SWA. In Figure 7-17, PWA still shows a reduction in the mean packet delay compared to SWA for the same reasons outlined before. PWA and SWA display similar performances at higher network offered load.



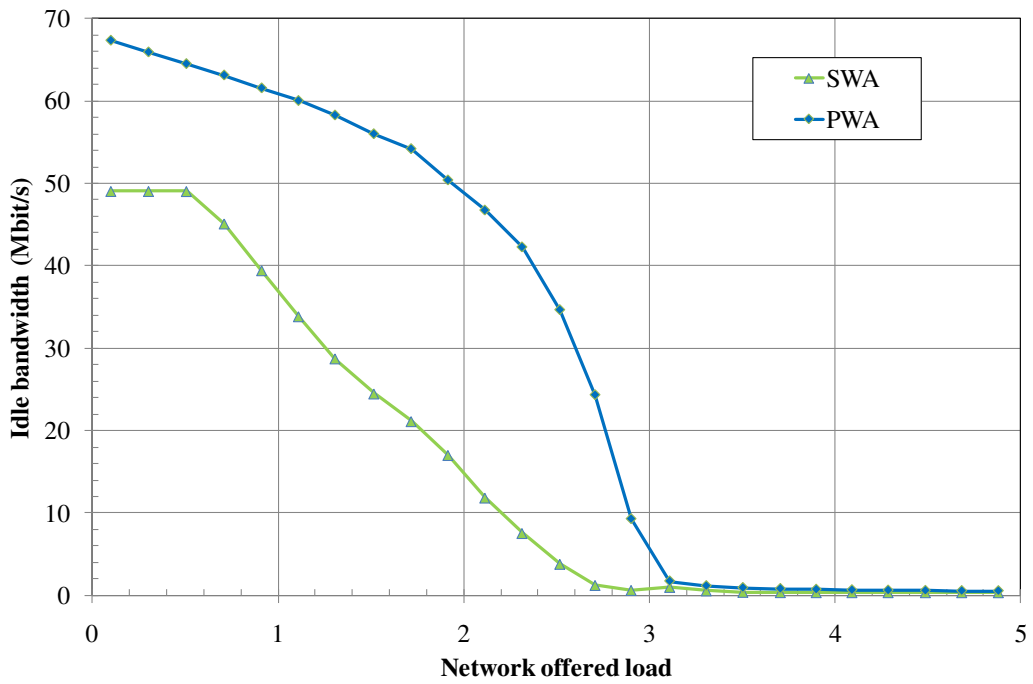


Figure 7-15: Average idle bandwidth between cycles for SWA and PWA with EBDMW protocol

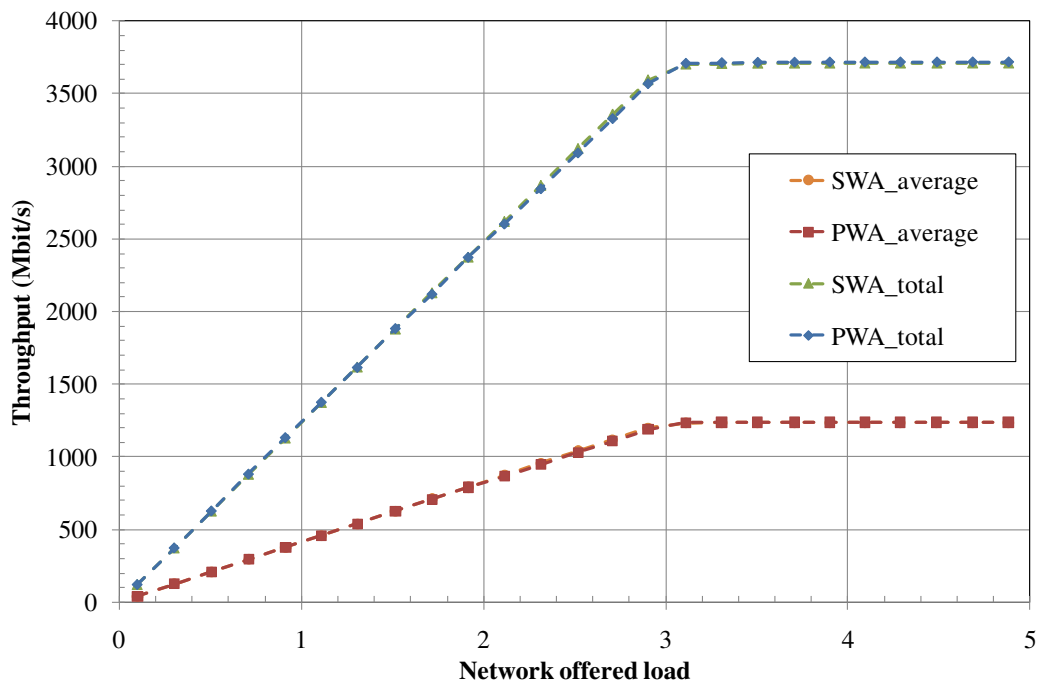
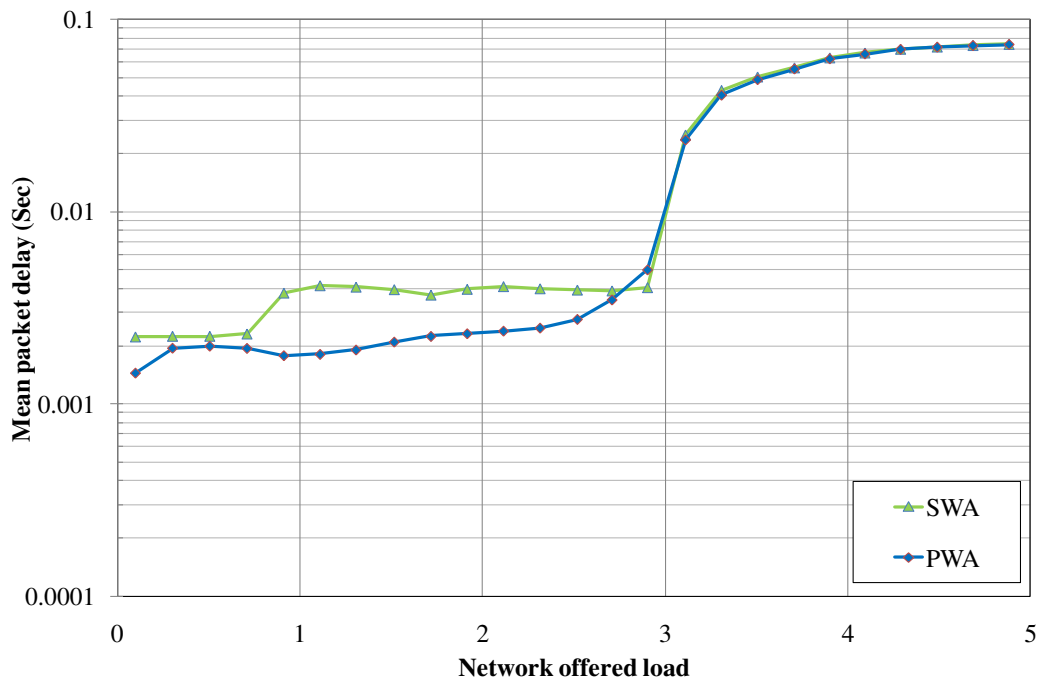


Figure 7-16: Throughput for SWA and PWA with EBDMW protocol



**Figure 7-17: Mean packet delay for SWA and PWA with EBDMW protocol**

In conclusion, the use or the choice between SWA or PWA approaches is based on the application, while SWA offers saving in the wavelength usage at low network traffic, which result a reduction in operating costs, PWA offers a lower mean packet delay if it is utilised at low network load, which makes PWA a good candidate to support time sensitive applications.

The choice between the ADMW protocol and EBDMW depends also on the service provider needs, if the service provider's network utilising mainly high network load, the EBDMW protocol is considered to be the right candidate. While the service provider's network is experiencing lower network load, the ADMW protocol is the right one, since the EBDMW protocol has an increased mean packet delay at low network load compared to ADMW.

## 7.6 *Summary*

While the idle-time between adjacent cycles was reduced by implementing the ADMW algorithm, applying the EBDMW algorithm results in a small reduction in the intra-cycle idle-time. To eliminate the intra-cycle idle-time associated with DMW-SWA algorithms, the PWA mechanism is introduced by fairly conducting the ONU traffic assignment among the supported wavelengths.

The application of PWA and the corresponding protocol enhancements have been presented to accommodate multi-wavelength operation over splitter-based GPONs by means of changing the ONUs wavelength assignment mechanism from serial to parallel in view of both ADMW algorithm and EBDMW algorithm. The performance benefits of the PWA operation include a reduction in the cycle duration which causes a noticeable lower mean packet delay of 0.07 ms at low network offered load compared to the SWA mechanism.

# 8 Conclusions and Future Work

---

This chapter summarises the work in a research programme aiming to establish original contributions with respect to multi-wavelength splitter-PON modelled in OPNET, based on dynamic bandwidth and wavelength assignment over GPON G.984 standards by developing the appropriate MAC protocols. The chapter concludes with possible protocol enhancements and application scenarios forming future work for this research programme.

## 8.1 *Review of research outcomes*

The demand of new bandwidth-intensive applications articulated by distance learning, online gaming, Web 2.0 and 3D movies delivery, by means of High-Definition (HD) video have justified the necessity of upgrading the access network infrastructure. This upgrade requires PONs to provide, in the very near-future, fat-bandwidth pipelines to subscriber proximity with potential connection speeds of 100 Mbit/s and beyond [16]. PON-based access networks have been envisaged to demonstrate scalability to allow gradual deployment of time and wavelength multiplexed architectures in a single-platform without changing the fibre infrastructure and also with a highly-efficient bandwidth allocation for service provision and upgrade on-demand.

This thesis has presented and evaluated novel multi-wavelength bandwidth allocation protocols based on standard GPON [2] infrastructures. Due to the fact

that there are still limitations associated with upgrading the GPON upstream aggregate rates, the presented protocols focus on the application of CWDM wavelengths to enhance the GPON upstream bandwidth map [3]. This is done by keeping the optical power splitter in the GPON remote node, which provides a smooth upgrade while minimising the infrastructure, ONU, and OLT costs.

The frame-format of the grant and report messages of legacy GPONs were investigated and redeveloped starting by adjusting the single-wavelength GPON frame format to support multi-wavelength operation. This has been achieved by employing the reserved bits in the frame's Flags field, allowing the grant messages to account for multi-wavelength operation for each ONU. A total of five CWDM wavelengths utilised upstream has allowed the new network to support the NG-PON requirements [71], with an increased ONU number of 32 ONUs, compared to single-wavelength PON protocols in literature utilising only 16 ONU [144]. 100 Mbit/s a minimum-guaranteed bandwidth has been demonstrated following the provision of 4 service levels, offering end-users service flexibility.

Subsequently a DMW MAC protocol was implemented by introducing a safety margin at the end of each wavelength transmission cycle before allocating ONU traffic among the supported wavelength. To confirm superior performance of the DMW protocol by means of the application of the safety margin scheme, it was contrasted to the well defined single wavelength DMD-GPON [144]. Progressively, the DMW protocol was improved by rearranging ONU assignment among the supported wavelengths in the sense of allocating the highest bandwidth ONUs in each transmission cycle at the end of each wavelength time slots. This

allocation mechanism demonstrated a significant reduction in the adjacent cycle's idle-time, and as a result, superior bandwidth utilisation and reduced packet delay compared to the random ONU's traffic allocation are initially implemented.

In order to improve the network utilisation further, the EBDMW protocol is introduced. To that extent, algorithms were developed to partition any unused time slots to ONUs with increasing requirements in bandwidth in consideration of their SLA and buffer queuing status. As expected that would have an effect on the management of idle-time slots, randomly forming on individual wavelengths, allowing their drastic reduction.

While the above protocols were implemented using a serial ONU allocation methodology to utilise the network supported wavelengths, an alternative scheme was developed based on parallel wavelength assignment where high profile ONUs in each transmission cycle were assigned simultaneously to different wavelengths. A laborious performance evaluation between the two schemes for all the developed protocols was conducted by means of their achieved network throughput, packet delays and average wasted bandwidth between successive transmission cycles as well as within each cycle. These performance evaluation outcomes are summarised below.

## 8.2 *Summary of results*

The suitable architecture to support dynamic wavelength allocation with fewer changes to the existing PONs was defined, followed by identifying the MAC protocol requirements to support multi-wavelength operation over standard

PON. The GPON upstream map frame format has been adjusted, by utilising the additional bits in the frame fields to define operating wavelength for each ONU, which provides the ability to accommodate multi-wavelength operation by means of smoothly upgrading the existing single-wavelength GPON infrastructures. That leads to the result that a five CWDM wavelength can be supported by each ONU. Later, a basic DMW protocol test-bed was implemented in OPNET platform in form of PON network elements, and the adjusted GPON frame format to support the multi-wavelength operation, and tested against the already published GPON DBA protocol to confirm the performance behaviour of the DMW protocol.

By introducing the safety margin to DMW, the performance benefits resulted in an aggregated transmission bit-rate about 3.7 Gbit/s in the presence of 3 wavelengths and 32 ONUs, 100 Mbit/s a minimum bandwidth per ONU, and a considerable reduction in the mean packet delay in comparison with a resourceful single-wavelength GPON topology. While the 0.003 s packet delay at typical network utilisation rates and the worst case 0.1 s at heavy loading, allow for undisruptive communication of the highest specification interactive services even at increased, ONU penetration and reach capabilities.

The idle-time slot per each wavelength, which is a result of the limitation associated with dynamic multi-wavelength operation in form of transmitting over one wavelength every cycle to reduce the ONU/OLT costs, is solved by improving the DMW algorithm by using ADMW algorithm. This results in an enhanced network utilisation and reduces the mean packet delay by allocating the highest traffic ONUs at the end of each wavelength transmission. While the

EBDMW algorithm uses the unemployed bandwidth per each wavelength to extend the allocated ONU bandwidth, it provides a maximum wavelength channel throughput compared to previous approaches.

To eliminate the intra-cycle' idle-time associated with DMW-SWA algorithms, the PWA mechanism is introduced by fairly conducting the ONU traffic assignment among the supported wavelengths. By changing the ONU's wavelength assignment mechanism from serial to parallel in view of both ADMW algorithm and EBDMW algorithm, the performance benefits a reduction in the cycle duration which causes a noticeable lower mean packet delay at low network offered load compared to the SWA mechanism.

### ***8.3 xDMW protocol applications in view of recent standardisation initiatives***

While the implementation of the complete DMW model, protocol developments and newly introduced algorithms were initiated in 2006 with the objective to provide multi-wavelengths to increase the standard splitter GPON's upstream capacity, in 2007, ITU-T introduced the G.984.5 Enhancement band for gigabit capable optical access networks recommendation for GPON [47], practically confirming support towards this thesis's objectives. Very recently (at the beginning of 2010), the G.987 10-Gigabit-capable passive optical networks (10G-PON) standard [37] was released to increase the GPON capacity to reach 10 Gbit/s. A MAC protocol in support of these new developments was not particularly defined, apart from the provision of some definitions that resemble



the current legacy GPON. While the DMW protocol and its variants explicitly address the requirements of the G.984.5 standard as already derived, the 10G-PON Transmission convergence layer specification specified by ITU-T, could also be successfully supported by the DMW protocols since they address QoS and SLA provision. That would be achieved by adjusting the transmission-acknowledgement packet formats of the DMW protocols to suit the 10G-PON standard rates and associated propagation figures [37].

#### 8.4 *Future xDMW protocol developments*

Based on the fact that the latest IEEE/ ITU-T Next-Generation PON standards [37, 40] are defining the use of multi-wavelength operation to support 10 Gbit/s, it is anticipated that the further research developments in the area of multi-wavelength MAC protocols and algorithms will continue to be widely sought by the sector and industry seeking cost-free, effective bandwidth provision to their end users.

In that direction, the various protocol enhancements from the DMW to the ADMW, the EBDMW developed in this thesis and the two distinctive ONU allocation mechanisms portrayed by the SWA and PWA schemes offer plenty of options and synergy possibilities that depending on the network utilisation, network volume and service classification, could satisfy the requirements of NGPONS. For example, while SWA offers safety on wavelength usage at low network traffic, causing a reduction on operating costs, PWA offers lower mean packet delay if utilised at low network load, which understandably promotes PWA as a good candidate to support time sensitive application.

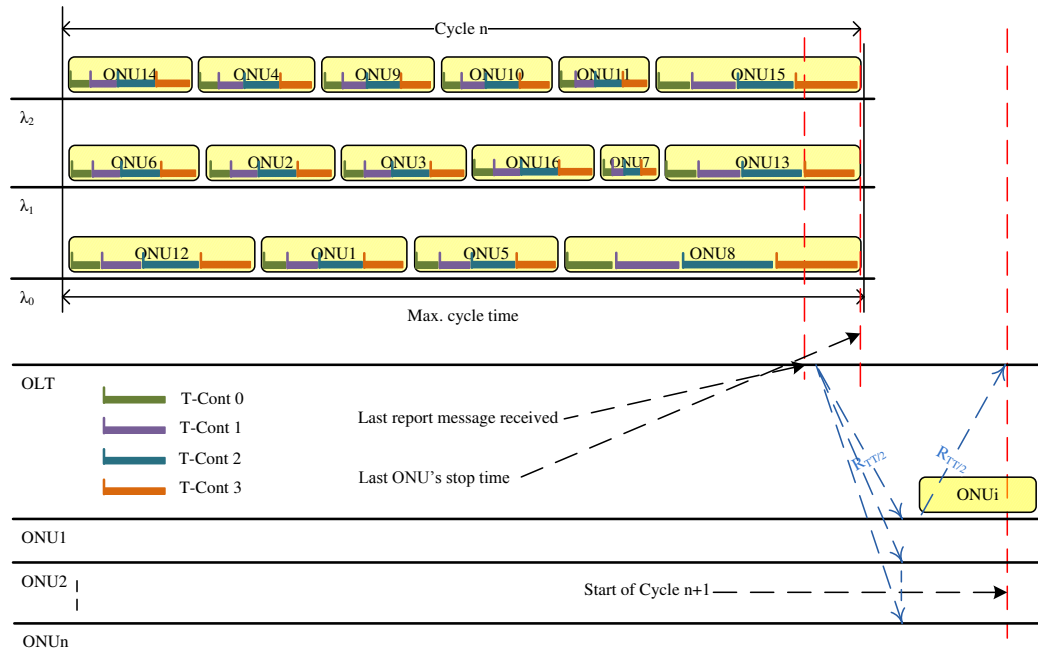
On the other hand, the choice between ADMW protocol and EBDMW depends heavily on service operator needs. If a service provider maintains in average high network load support, the EBDMW protocol would be the right candidate. In contrast, at low network traffic scenarios, the application of the ADMW protocol would be more efficient, since the EBDMW protocol demonstrates increased mean packet delay at low network load compared to the ADMW. To that extent, a potential synergy between the ADMW and EBDMW protocols, by applying the former at low traffic conditions switching to the latter at full network capacity, would provide low mean packet delay at moderate network use and maximum channel throughput when the network traffic peaks up.

#### **8.4.1 xDMW protocol supported by Class of Service Differentiation**

While the xDMW protocol in general considers only one queue to serve the different application services in the ONU, GPON has the ability of serving dynamically four services queues to enable all possible end-user's applications. In contrary, the standard GPON trades each T-CONT as an individual queue, while the current DMW protocol does not distinguish between the different services and trades the ONU traffic based only on SLA only.

By applying the Class of Service differentiation, at the xDMW protocol based on the GPON standard mechanism, the transmission window for each T-CONT/queue will be reduced compared to the total ONU transmission window with single CoS ONU as seen in Figure 8-1. On the other hand, in view of reduced ONU transmission windows, an increase of the idle gap between cycles would

occur which is expected to lead to increase the mean packet delay and decrease network throughput.



**Figure 8-1: xDMW Protocol with CoS**

The xDMW protocol can be improved by supporting CoS and enhancing the network performance, by means of an Early Reporting DMW (ERDMW) scheme as shown in Figure 8-2. While in standard GPON's MAC protocols the queuing report is communicated at the start/end of the T-CONT transmission window, the aim of the ERDMW protocol would be to report the entire ONUs' queuing status to the OLT at the beginning of the ONU transmission window. As explained in Figure 8-2, the ERDMW approach expected to reduce the idle time between the cycles to the minimum leading to a better network performance.

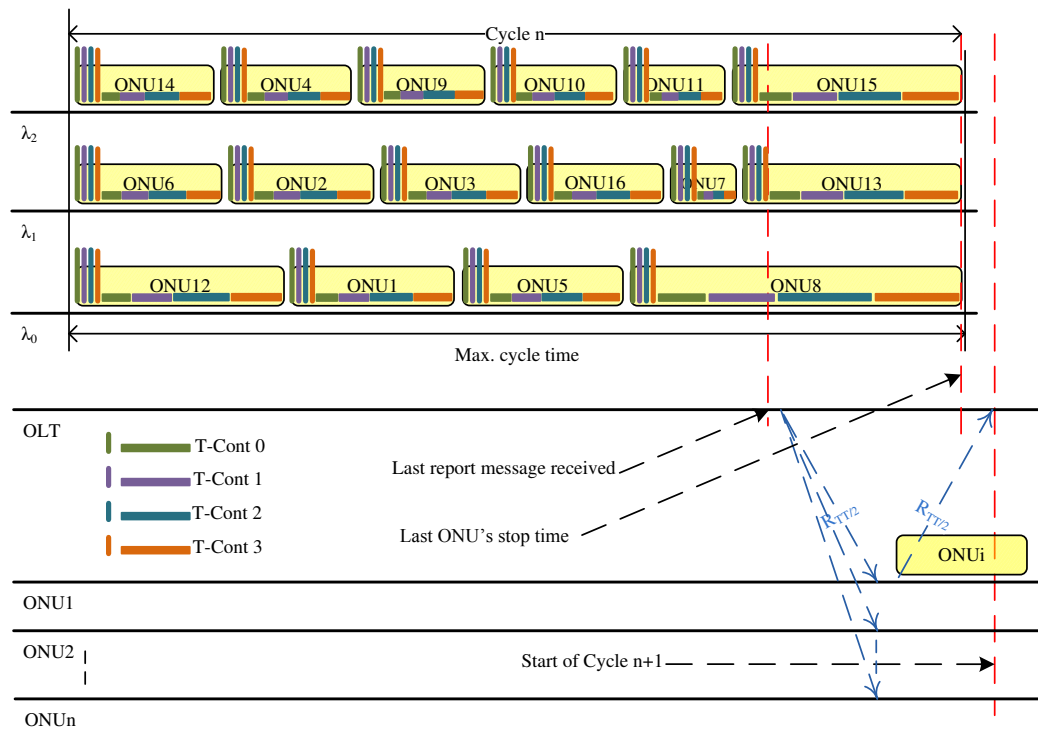


Figure 8-2: xDMW protocol with early CoS reporting

#### 8.4.2 Bidirectional -DMW (Bi-DMW) protocol

While the main concern in PON MAC's protocols is generally the upstream transmission, downstream transmission although is based on broadcasting mechanism, still needs to provide fair bandwidth utilisation with SLA contracts being valid for both the upstream and downstream.

By introducing multi-wavelength operation in the downstream, and dynamically allocating the ONU downstream transmission windows among the supported wavelengths, the network flexibility, and capacity between upstream and downstream are expected to increase symmetrically with a decrease in the mean packet delay. Such a scenario would be able to support 2-ways time-sensitive applications [56, 153].

---

# References

---

- [1] ITU-T, "V.90: A digital modem and analogue modem pair for use on the Public Switched Telephone Network (PSTN) at data signalling rates of up to 56Kbit/s downstream and up to 33.6 Kbit/s upstream," ITU-T, Ed.: ITU-T, 1998.
- [2] ITU-T, "V.92: Enhancements to Recommendation V.90," ITU-T, Ed.: ITU-T, 2000.
- [3] ITU-T, "G.960: Access digital section for ISDN basic rate access," ITU-T, Ed.: ITU-T, 1993.
- [4] ITU-T, "G.995.1: Overview of digital subscriber line (DSL) Recommendations ", ITU-T, Ed.: ITU-T, 2001.
- [5] ITU-T, "G.992.3: Asymmetric digital subscriber line transceivers 2 (ADSL2) ", ITU-T, Ed.: ITU-T, 2009.
- [6] T. Kos, M. Grgic, and L. Mandic, "CATV broadband technologies," in *Video/Image Processing and Multimedia Communications, 2003. 4th EURASIP Conference focused on*, 2003, pp. 829-834 vol.2.
- [7] J. W. Eng and J. F. Mollenauer, "IEEE Project 802.14: standards for digital convergence," *Communications Magazine, IEEE*, vol. 33, pp. 20-23, 1995.
- [8] ITU-T, "G.993.1: Very high speed digital subscriber line (VDSL) transceivers," ITU-T, Ed.: ITU-T, 2004.
- [9] ITU-T, "G.993.2: Very high speed digital subscriber line transceivers 2 (VDSL2) ", ITU-T, Ed.: ITU-T, 2006.
- [10] P. W. Shumate, "Fiber-to-the-home: 1977-2007," *Journal of Lightwave Technology*, vol. 26, pp. 1093-1103, May-Jun 2008.
- [11] S. A. Valcourt, "DSL: From A to V and back again (invited paper)," in *Second International Conference on Access Networks & Workshops, 2007. AccessNets '07.* , 2007, pp. 1-5.
- [12] T. Koonen, "Fiber to the Home/Fiber to the Premises: What, Where, and When?," *Proceedings of the IEEE*, vol. 94, pp. 911-934, 2006.
- [13] K. Tanaka, A. Agata, and Y. Horiuchi, "IEEE 802.3av 10G-EPON Standardization and Its Research and Development Status," *Journal of Lightwave Technology*, vol. 28, pp. 651-661, 2010.
- [14] B. Mukherjee, *Optical WDM Networks*. New York, USA: Springer, 2006.
- [15] T. Kos, N. Sprljan, and B. Zovko-Cihlar, "Comparison of broadband network technologies," in *EUROCON 2003. Computer as a Tool. The IEEE Region 8*, 2003, pp. 178-182 vol.1.
- [16] L. G. Kazovsky, W.-T. Shaw, D. Gutierrez, N. Cheng, and S.-W. Wong, "Next-Generation Optical Access Networks," *JOURNAL OF LIGHTWAVE TECHNOLOGY*, vol. 25, pp. 3428-3442, 2007.
- [17] M. Sawahashi, Y. Kishiyama, H. Taoka, M. Tanno, and T. Nakamura, "Broadband radio access: LTE and LTE-advanced," in *International*

- Symposium on Intelligent Signal Processing and Communication Systems, 2009. ISPACS 2009.*, 2009, pp. 224-227.
- [18] IEEE, "IEEE Standard for Local and metropolitan area networks Part 16: Air Interface for Broadband Wireless Access Systems," *IEEE Std 802.16-2009 (Revision of IEEE Std 802.16-2004)*, pp. C1-2004, 2009.
- [19] X. Fernando, "Broadband Access Networks," in *International Conference on Signal Processing, Communications and Networking, 2008. ICSCN '08.*, 2008, pp. 380-383.
- [20] Z. Abichar, P. Yanlin, and J. M. Chang, "WiMax: The Emergence of Wireless Broadband," *IT Professional*, vol. 8, pp. 44-48, 2006.
- [21] S. Ahmadi, "An overview of next-generation mobile WiMAX technology," *Communications Magazine, IEEE*, vol. 47, pp. 84-98, 2009.
- [22] K. Etemad, "Overview of mobile WiMAX technology and evolution," *Communications Magazine, IEEE*, vol. 46, pp. 31-40, 2008.
- [23] "FTTx 2010." vol. 2010.
- [24] C.-H. Lee, S.-M. Lee, K.-M. Choi, J.-H. Moon, S.-G. Mun, K.-T. Jeong, J. H. Kim, and B. Kim, "WDM-PON experiences in Korea [Invited]," *JOURNAL OF OPTICAL NETWORKING*, vol. 6, pp. 451-464, 2007.
- [25] M. Maier, "WDM Passive Optical Networks and Beyond: the Road Ahead [Invited]," *Journal of Optical Communications and Networking, IEEE/OSA* vol. 1, pp. C1-C16, 2009.
- [26] E. Wong, K. L. Lee, and T. Anderson, "Low-cost WDM passive optical network with directly-modulated self-seeding reflective SOA," *Electronics Letters*, vol. 42, pp. 299-301, 2006.
- [27] T. Jayasinghe, C. J. Chae, and R. S. Tucker, "Scalability of RSOA-based multiwavelength Ethernet PON architecture with dual feeder fiber," *JOURNAL OF OPTICAL NETWORKING*, vol. 6, pp. 1025-1040, 2007.
- [28] Y. Maeda, K. Okada, and D. Faulkner, "FSAN OAN-WG and future issues for broadband optical access networks," *Communications Magazine, IEEE*, vol. 39, pp. 126-132, 2001.
- [29] L. Chang-Hee, "Passive optical networks for FTTx applications," in *Optical Fiber Communication Conference, Anaheim, USA, 2005*, p. 3 pp.
- [30] X. Jing, J. Shengming, and J. Yuming, "A dynamic bandwidth allocation scheme for differentiated services in EPONs," *IEEE Communications Magazine*, vol. 42, pp. S32-S39, 2004.
- [31] J. D. Angelopoulos, H. C. Leligou, T. Argyriou, S. Zontos, E. Ringoot, and T. Van Caenegem, "Efficient transport of packets with QoS in an FSAN-aligned GPON," *IEEE Communications Magazine* vol. 42, pp. 92-98, 2004.
- [32] S. Smith, "Business class services over a GPON network," in *Optical Fiber Communication Conference, and the National Fiber Optic Engineers Conference. OFC2006, 2006*, p. 10 pp.
- [33] K. M. Choi, S. M. Lee, M. H. Kim, and C. H. Lee, "An Efficient Evolution Method From TDM-PON to Next-Generation PON," *IEEE Photonics Technology Letters*, vol. 19, pp. 647-649, 2007.

- [34] S. Hornung, R. Davey, D. Payne, and D. Nasset, "Evolution to next generation optical access networks," in *The 20th Annual Meeting of the IEEE Lasers and Electro-Optics Society, LEOS2007.*, 2007, pp. 939-940.
- [35] L. Hutcheson, "FTTx: Current Status and the Future," *Communications Magazine, IEEE*, vol. 46, pp. 90-95, 2008.
- [36] ITU-T, "G.987: 10-Gigabit-capable passive optical network (XG-PON) systems: Definitions, Abbreviations, and Acronyms", ITU-T, Ed.: ITU-T, 2010.
- [37] ITU-T, "G.987.1: 10-Gigabit-capable passive optical networks (XG-PON): General requirements," ITU-T, Ed.: ITU-T, 2010.
- [38] ITU-T, "G.987.2: 10-Gigabit-capable passive optical networks (XG-PON): Physical media dependent (PMD) layer specification," ITU-T, Ed.: ITU-T, 2010.
- [39] M. Rasztoivits-Wiech, A. Stadler, S. Gianordoli, and K. Kloppe, "Is a 10/2.5Gbit/s Extra-Large PON far from Reality," in *9th International Conference on Transparent Optical Networks, 2007. ICTON '07.*, 2007, pp. 283-286.
- [40] IEEE, "IEEE 802.3av-2009: IEEE Standard for Information technology - Telecommunications and information exchange between systems - Local and metropolitan area networks - Specific requirements Part 3: Carrier Sense Multiple Access with Collision Detection (CSMA/CD) Access Method and Physical Layer Specifications Amendment 1: Physical Layer Specifications and Management Parameters for 10 Gb/s Passive Optical Networks," *IEEE Std 802.3av-2009 (Amendment to IEEE Std 802.3-2008)*, pp. c1-214, 2009.
- [41] M. Attygalle, Y. J. Wen, J. Shankar, A. Nirmalathas, X. Cheng, and Y. Wang, "Increasing upstream capacity in TDM-PON with multiple-wavelength transmission using Fabry-Perot laser diodes," *OPTICS EXPRESS*, vol. 15, pp. 10247-10252, 2007.
- [42] A. Banerjee, Y. Park, F. Clarke, H. Song, S. Yang, G. Kramer, K. Kim, and B. Mukherjee, "Wavelength-division-multiplexed passive optical network (WDM-PON) technologies for broadband access: a review," *JOURNAL OF OPTICAL NETWORKING*, vol. 4, pp. 737-758, November 2005.
- [43] J. Inghoff, "Athermal AWG devices for WDM-PON architectures," in *19th Annual Meeting of the IEEE Lasers and Electro-Optics Society, LEOS2006* 2006, pp. 26-27.
- [44] Y. C. Chung, "Challenges Toward Practical WDM PON," in *OptoElectronics and Communications Conference (OECC)*, 2006, pp. 6C4-1-1-6C4-1-1.
- [45] L. Sang-Mook, M. Sil-Gu, and L. Chang-Hee, "Consolidation of a Metro Network into an Access Network Based on Long-Reach DWDM-PON," in *Optical Fiber Communication Conference and Exposition and The National Fiber Optic Engineers Conference*, 2006, p. NWA2.
- [46] K. D. Langer, J. Vathke, K. Habel, and C. Arellano, "Recent Developments in WDM-PON Technology," in *International Conference on Transparent Optical Networks*, Nottingham, UK, 2006, pp. 12-13.

- [47] ITU-T, "G.984.5: Enhancement band for gigabit capable optical access networks," ITU-T, Ed.: ITU-T, 2007.
- [48] L. Sungkuen, K. Eallae, L. Yongwon, L. Sangrok, J. Daekwang, H. Seongtaek, O. Yunje, and P. Jinwoo, "A Design of WDM/TDM-PON Provisioning for Future Optical Access Network Upgrade," *IEICE TRANSACTIONS on Communications*, vol. E90-B, pp. 2456-2463, 1 Sep. 2007
- [49] G. Talli and P. D. Townsend, "Hybrid DWDM-TDM long-reach PON for next-generation optical access," *Lightwave Technology, Journal of*, vol. 24, pp. 2827-2834, 2006.
- [50] Y. Shachaf, C. H. Chang, P. Kourtessis, and J. M. Senior, "Multi-PON access network using a coarse AWG for smooth migration from TDM to WDM PON," *OPTICS EXPRESS*, vol. 15, pp. 7840-7844, 2007.
- [51] S. V. Kartalopoulos, "Next generation hierarchical CWDM/TDM-PON network with scalable bandwidth deliverability to the premises," *Optical Switching and Networking*, vol. 2, pp. 163-175, 2005.
- [52] G. Klaus and E. Jörg-Peter, "PON Evolution from TDMA to WDM-PON," in *National Fiber Optic Engineers Conference*, 2008, p. NThD6.
- [53] C. Chang-Joon and O. Nam-Hyun, "WDM/TDM PON system employing a wavelength-selective filter and a continuous-wave shared light source," *IEEE Photonics Technology Letters*, vol. 10, pp. 1325-1327, 1998.
- [54] S. Huan, P. Youngil, A. Banerjee, and B. Mukherjee, "Shared-Wavelength WDM-PON Access Network --- Bursty Traffic Accommodation and User-defined SLA Support," in *The Joint International Conference on Optical Internet and Next Generation Network, COIN-NGNCON 2006* 2006, pp. 383-385.
- [55] S. Huan, B. Mukherjee, P. Youngil, and Y. Sunhee, "Shared-wavelength WDM-PON access network for supporting downstream traffic with QoS," in *Optical Fiber Communication Conference, 2006 and the 2006 National Fiber Optic Engineers Conference. OFC 2006*, 2006, p. 3 pp.
- [56] ITU-T, "G.1010: End-user multimedia QoS categories," ITU-T, Ed.: ITU-T, 2001.
- [57] C. H. Chang, P. Kourtessis, and J. M. Senior, "GPON service level agreement based dynamic bandwidth assignment protocol," *IET Electronics Letters*, vol. 42, pp. 1173-1174, 2006.
- [58] J. Park, J. Chung, and Y. Park, "Application of 2W-PON in fairness and priority environments," *JOURNAL OF OPTICAL NETWORKING*, vol. 6, pp. 1236-1243, 2007.
- [59] J. Chung, J. Park, B. Choi, Y. Park, J. Yoo, and B.-W. Kim, "Application of 2W-PON to the backhaul of a wireless network," *JOURNAL OF OPTICAL NETWORKING*, vol. 7, pp. 905-913, 2008.
- [60] C. H. Chang, N. M. Alvarez, P. Kourtessis, R. M. Lorenzo, and J. M. Senior, "Full-Service MAC Protocol for Metro-Reach GPONs," *Journal of Lightwave Technology*, vol. 28, pp. 1016-1022, 2010.
- [61] K. Kanonakis and I. Tomkos, "Offset-Based Scheduling With Flexible Intervals for Evolving GPON Networks," *J. Lightwave Technol.*, vol. 27, pp. 3259-3268, 2009.



- [62] K. Kanonakis and I. Tomkos, "Efficient scheduling disciplines for next generation QoS-aware GPON networks," in *10th Anniversary International Conference on Transparent Optical Networks, 2008. ICTON 2008.*, 2008, pp. 135-138.
- [63] "OPNET Modeler," 14.5 ed Bethesda: OPNET Technologies, 2008.
- [64] Z. Zhiwei, R. Yang, H. Hongbin, and L. Weiping, "An Enhanced Dynamic Wavelength and Bandwidth Allocation Method in WDM-EPON," in *Asia Communications and Photonics Conference and Exhibition*, 2009, p. FZ5.
- [65] A. P. Singh and D. Chadha, "Quality of Service Issues in WDM-EPON Systems," in *International Conference on Signal Processing, Communications and Networking, ICSCN'08*, 2008, pp. 194-198.
- [66] A. R. Dhaini, C. M. Assi, M. Maier, and A. Shami, "Dynamic Wavelength and Bandwidth Allocation in Hybrid TDM/WDM EPON Networks," *Journal of Lightwave Technology*, vol. 25, pp. 277-286, 2007.
- [67] J. P. R. Pereira, "A cost model for broadband access networks: FTTx versus WiMAX," in *Access Networks & Workshops, 2007. AccessNets '07. Second International Conference on*, 2007, pp. 1-8.
- [68] ITU-T, "G.983.4: A broadband optical access system with increased service capability using dynamic bandwidth assignment", ITU-T, Ed.: ITU-T, 2001.
- [69] G. Keiser, *FTTX Concepts and Applications*: Wiley-IEEE Press, 2006.
- [70] F. Effenberger, D. Clearly, O. Haran, G. Kramer, L. Ruo Ding, M. Oron, and T. Pfeiffer, "An introduction to PON technologies [Topics in Optical Communications]," *Communications Magazine, IEEE*, vol. 45, pp. S17-S25, 2007.
- [71] M. J. O'Mahony, C. Politi, D. Klonidis, R. Nejabati, and D. Simeonidou, "Future Optical Networks," *J. Lightwave Technol.*, vol. 24, pp. 4684-4696, 2006.
- [72] J. Prat, P. Chanclou, R. Davey, J. M. Finochietto, G. Franzl, A. M. J. Koonen, and S. Walker, "Long-term evolution of passive optical networks," in *Proceedings of the 1st international conference on Access networks* Athens, Greece: ACM, 2006.
- [73] L. Chang-Hee and C. Ki-Man, "Fiber to the Home," in *Lasers and Electro-Optics Society, 2007. LEOS 2007. The 20th Annual Meeting of the IEEE*, 2007, pp. 937-938.
- [74] C. H. Lee, W. V. Sorin, and B. Y. Kim, "Fiber to the Home Using a PON Infrastructure," *Journal of Lightwave Technology*, vol. 24, pp. 4568-4583, 2006.
- [75] ITU-T, "G.983.1: Broadband optical access systems based on Passive Optical Networks (PON)," ITU-T, Ed.: ITU-T, 2005.
- [76] ITUT, "G.983.1 Broadband optical access systems based on Passive Optical Networks (PON)," ITU-T 2005.
- [77] IEEE, "IEEE 802.3ah-2004: IEEE Standard for Information Technology-Telecommunications and Information Exchange Between Systems- Local and Metropolitan Area Networks- Specific Requirements Part 3: Carrier Sense Multiple Access With Collision Detection (CSMA/CD) Access Method and Physical Layer Specifications Amendment: Media Access

- Control Parameters, Physical Layers, and Management Parameters for Subscriber Access Networks," *IEEE Std 802.3ah-2004*, pp. 0\_1-623, 2004.
- [78] IEEE, "IEEE802.3ah: Ethernet in the First Mile Task Force," IEEE, Ed., 2004.
- [79] S. Iallukka and P. Raatikainen, "Link utilization and comparison of EPON and GPON access network cost," 2005, p. 5 pp.
- [80] ITU-T, "G.984.1: Gigabit-capable passive optical networks (GPON): General characteristics," ITU-T, Ed.: ITU-T, 2008.
- [81] ITUT, "G.984.3 Gigabit-capable Passive Optical Networks (G-PON): Transmission convergence layer specification " ITU-T 2004.
- [82] ITU-T, "G.984.3: Gigabit-capable Passive Optical Networks (G-PON): Transmission convergence layer specification," ITU-T, Ed.: ITU-T, 2008.
- [83] ITU-T, "G.7041: Generic framing procedure (GFP)," ITU-T, Ed.: ITU-T, 2008.
- [84] ITU-T, "G.694.2: Spectral grids for WDM applications: CWDM wavelength grid ", ITU-T, Ed.: ITU-T, 2003.
- [85] ITU-T, "G.694.1: Spectral grids for WDM applications: DWDM frequency grid," ITU-T, Ed.: ITU-T, 2002.
- [86] L. Lasse, B. Martin, G. N. Jesper, I. Husain, and I. Jan, "Athermal AWGs for Colourless WDM-PON with -40oC to +70oC and Underwater Operation," in *Optical Fiber Communication Conference and Exposition and The National Fiber Optic Engineers Conference*, 2006, p. PDP31.
- [87] P. Hyung-Jin, Y. Hosung, P. Taesang, P. Soo-Jin, and K. Jin Hee, "Recent Research Activities of WDM-PON in Korea," in *Conference on Optical Fiber Communication and the National Fiber Optic Engineers Conference, 2007. OFC/NFOEC 2007.*, 2007, pp. 1-3.
- [88] K.-E. Han, Y. He, S.-H. Lee, B. Mukherjee, and Y.-C. Kim, "Design and Performance Evaluation of WDM/TDMA-Based MAC Protocol in AWG-Based WDM-PON " *NETWORKING 2005*, vol. 3462, pp. 1426-1429, May 02 2005.
- [89] G. Das, B. Lannoo, H. D. Jung, T. Koonen, D. Colle, M. Pickavet, and P. Demeester, "A new architecture and MAC protocol for fully flexible hybrid WDM/TDM PON," in *35th European Conference on Optical Communication, 2009. ECOC '09.* , 2009, pp. 1-2.
- [90] C. Arellano, C. Bock, J. Prat, and K. D. langer, "RSOA-based optical network units for WDM-PON," in *Optical Fiber Communication Conference, and the National Fiber Optic Engineers Conference. OFC2006*, 2006, p. 3 pp.
- [91] K. Tae-Young and H. Sang-Kook, "Reflective SOA-Based Bidirectional WDM-PON Sharing Optical Source for Up/Downlink Data and Broadcasting Transmission," *IEEE Photonics Technology Letters*, vol. 18, pp. 2350-2352, 2006.
- [92] K. Hyowon, H. Junho, and Y. Myungsik, "A Cost-Efficient WDM-PON Architecture Supporting Dynamic Wavelength and Time Slot Allocation," in *The 9th International Conference on Advanced Communication Technology 2007*, pp. 1564-1568.

- [93] M. P. McGarry, M. Reisslein, M. Maier, and A. Keha, "Bandwidth management for WDM EPONs," *Journal of Optical Networking*, vol. 5, pp. 637-654, Sep. 2006.
- [94] E. Wong and S. Chan, "Dynamic Wavelength Allocation Schemes in WDM-PON," in *PhotonicsGlobal@Singapore, 2008. IPGC 2008. IEEE*, 2008, pp. 1-4.
- [95] L. Hye, C. Hyunseung, L. Tae-jin, and C. Min, "Group-synchronized polling algorithm in WDM-EPON," *Communications Letters, IEEE*, vol. 13, pp. 199-201, 2009.
- [96] I. S. Hwang, Z.-D. Shyu, C.-C. Chang, and J.-Y. Lee, "Fault-tolerant architecture with dynamic wavelength and bandwidth allocation scheme in WDM-EPON," *Photonic Network Communications*, vol. 18, pp. 160-173, October 2009.
- [97] Y. Xin, C. M. Assi, and M. A. Ali, "Integrated Bandwidth Allocation and Wavelength Assignment in WDM-PON Networks," in *Sarnoff Symposium, 2008 IEEE*, 2008, pp. 1-5.
- [98] G. Kramer, B. Mukherjee, and G. Pesavento, "IPACT a dynamic protocol for an Ethernet PON (EPON)," *IEEE Communications Magazine*, vol. 40, pp. 74-80, 2002.
- [99] G. Kramer, B. Mukherjee, and G. Pesavento, "Interleaved Polling with Adaptive Cycle Time (IPACT): A Dynamic Bandwidth Distribution Scheme in an Optical Access Network," *Photonic Network Communications*, vol. 4, pp. 89-107, 2002.
- [100] T. Chia-Sheng and T. Chia-Sheng, "Bandwidth allocation schemes for FTTH networks," in *IFIP International Conference on Wireless and Optical Communications Networks.*, 2006, p. 4 pp.
- [101] C. L. K. K. J. D. A. T. O. H. C. Leligou, "Efficient medium arbitration of FSAN-compliant GPONs," *International Journal of Communication Systems*, vol. 19, pp. 603-617, 2006.
- [102] A. R. Dhaini, C. M. Assi, M. Maier, and A. Shami, "Admission Control in Ethernet Passive Optical Networks (EPONs)," in *IEEE International Conference on Communications, ICC'07.*, 2007, pp. 2162-2167.
- [103] G. Kramer and G. Pesavento, "Ethernet passive optical network (EPON): building a next-generation optical access network," *Communications Magazine, IEEE*, vol. 40, pp. 66-73, 2002.
- [104] K. M. Choi, S. M. Lee, M. H. Kim, and C. H. Lee, "An efficient evolution method from TDM-PON to next-generation PON," *Ieee Photonics Technology Letters*, vol. 19, pp. 647-649, May-Jun 2007.
- [105] L. Chang-Hee, "Passive optical networks for FTTx applications," 2005, p. 3 pp. Vol. 3.
- [106] C. Assi, Y. Yinghua, and D. Sudhir, "Support of QoS in IP-based Ethernet-PON," in *IEEE Global Telecommunications Conference, GLOBECOM '03*, 2003, pp. 3737-3741.
- [107] C. M. Assi, Y. Yinghua, D. Sudhir, and M. A. Ali, "Dynamic bandwidth allocation for quality-of-service over Ethernet PONs," *IEEE Journal on Selected Areas in Communications*, vol. 21, pp. 1467-1477, 2003.

- [108] M. P. McGarry, M. Maier, and M. Reisslein, "Ethernet PONs: a survey of dynamic bandwidth allocation (DBA) algorithms," *IEEE Communications Magazine*, vol. 42, pp. S8-15, 2004.
- [109] Z. Yongqing and M. Maode, "IPACT With Grant Estimation (IPACT-GE) Scheme for Ethernet Passive Optical Networks," *Journal of Lightwave Technology*, vol. 26, pp. 2055-2063, 2008.
- [110] M. McGarry, M. Reisslein, and M. Maier, "Ethernet passive optical network architectures and dynamic bandwidth allocation algorithms," *IEEE Communications Surveys & Tutorials* vol. 10, pp. 46-60, 2008.
- [111] S. Bhatia, D. Garbuzov, and R. Bartos, "Analysis of the Gated IPACT Scheme for EPONs," in *IEEE International Conference on Communications, ICC '06.*, 2006, pp. 2693-2698.
- [112] Z. Yongqing, M. Maode, and C. Tee Hiang, "IPACT with Grant Estimation for EPON," in *10th IEEE Singapore International Conference on Communication systems, ICCS 2006.* , 2006, pp. 1-5.
- [113] J. Lee, B. Kim, and J. Shin, "Performance Analysis of IPACT Media Access Control Protocols for Gigabit Ethernet-PONs," *IEICE Trans Commun*, vol. E90-B, pp. 845-855, April 1 2007.
- [114] M. P. McGarry, M. Maier, and M. Reisslein, "Ethernet PONs: a survey of dynamic bandwidth allocation (DBA) algorithms," *Communications Magazine, IEEE*, vol. 42, pp. S8-15, 2004.
- [115] M.-S. Han, H. Yoo, B.-Y. Yoon, B. Kim, and J.-S. Koh, "Efficient dynamic bandwidth allocation for FSAN-compliant GPON," *JOURNAL OF OPTICAL NETWORKING*, vol. 7, pp. 783-795, 2008.
- [116] C. H. Chang, P. Kourtessis, and J. M. Senior, "GPON service level agreement based dynamic bandwidth assignment protocol," *Electronics Letters*, vol. 42, pp. 1173-1174, 2006.
- [117] J. Jiang, M. R. Handley, and J. M. Senior, "Dynamic bandwidth assignment MAC protocol for differentiated services over GPON," *Electronics Letters*, vol. 42, pp. 653-655, 2006.
- [118] S. Smith, "Business class services over a GPON network," 2006, p. 10 pp.
- [119] J. Jiang, M. R. Handley, and J. M. Senior, "GPON dynamic MAC protocol to support differentiated services," in *The 2nd Institution of Engineering and Technology International Conference on Access Technologies 2006*, pp. 89-92.
- [120] M. Attygalle, Y. J. Wen, J. Shankar, A. Nirmalathas, X. Cheng, and Y. Wang, "Increasing upstream capacity in TDM-PON with multiple-wavelength transmission using Fabry-Perot laser diodes," *Optics Express*, vol. 15, p. 6, 2007/08/06 2007.
- [121] C. Arellano, C. Bock, J. Prat, and K. D. langer, "RSOA-based optical network units for WDM-PON," 2006, p. 3 pp.
- [122] M. P. McGarry, M. Reisslein, and M. Maier, "WDM Ethernet passive optical networks," *Communications Magazine, IEEE*, vol. 44, pp. 15-22, 2006.
- [123] F. Clarke, S. Sarkar, and B. Mukherjee, "Simultaneous and interleaved polling: an upstream protocol for WDM-PON," in *Optical Fiber*

- Communication Conference, and the National Fiber Optic Engineers Conference. OFC2006, Anaheim, USA, 2006, p. 3 pp.*
- [124] A. P. Singh and D. Chadha, "Quality of Service Issues in WDM-EPON Systems," in *Signal Processing, Communications and Networking, 2008. ICSCN '08. International Conference on*, 2008, pp. 194-198.
- [125] Z.-D. S. I-Shyan Hwang, and Chun-Che Chang, "A Novel Dynamic Wavelength and Bandwidth Allocation Scheme for WDM-EPON with Survivable Network Architectures," *International Journal of Computer Science IAENG* vol. 35, 21 aug. 2008.
- [126] A. Rafiq, S. M. H. Zaidi, and M. Ramzan, "Comparative Analysis of Scheduling Frameworks for Efficient Wavelength Utilization in WDM EPONs," in *International Conference on Electrical Engineering, ICEE '07.*, 2007, pp. 1-6.
- [127] Lawrence K. Vanston and a. R. L. Hodges, "Forecasts for the US Telecommunications Network," *Telecommunications Forecasting*, vol. 3/4, pp. 18-28, 2008.
- [128] F. J. Effenberger, "Next generation PON: lessons learned from G-PON and GE-PON," in *35th European Conference on Optical Communication, 2009. ECOC '09.*, 2009, pp. 1-3.
- [129] T. P. D. T. v. V. J. S. S. S. P. Ronald W. Heron, "Technology innovations and architecture solutions for the next-generation optical access network," *Bell Labs Technical Journal*, vol. 13, pp. 163-181, 2008.
- [130] J. i. Kani, F. Bourgart, A. Cui, A. Rafel, M. Campbell, R. Davey, and S. Rodrigues, "Next-generation PON-part I: Technology roadmap and general requirements," *Communications Magazine, IEEE*, vol. 47, pp. 43-49, 2009.
- [131] F. Effenberger, H. Mukai, P. Soojin, and T. Pfeiffer, "Next-generation PON-part II: Candidate systems for next-generation PON," *Communications Magazine, IEEE*, vol. 47, pp. 50-57, 2009.
- [132] F. Effenberger, H. Mukai, J. i. Kani, and M. Rasztoivits-Wiech, "Next-generation PON-part III: System specifications for XP-PON," *Communications Magazine, IEEE*, vol. 47, pp. 58-64, 2009.
- [133] K. Kyeong Soo, D. Gutierrez, A. Fu-Tai, and L. G. Kazovsky, "Design and performance analysis of scheduling algorithms for WDM-PON under SUCCESS-HPON architecture," *Journal of Lightwave Technology*, vol. 23, pp. 3716-3731, 2005.
- [134] H. Yu-Li, M. S. Rogge, S. Yamamoto, and L. G. Kazovsky, "A highly flexible and efficient passive optical network employing dynamic wavelength allocation," *Journal of Lightwave Technology*, vol. 23, pp. 277-286, 2005.
- [135] A. Fu-Tai, D. Gutierrez, K. Kyeong Soo, L. Jung Woo, and L. G. Kazovsky, "SUCCESS-HPON: A next-generation optical access architecture for smooth migration from TDM-PON to WDM-PON," *IEEE Communications Magazine*, vol. 43, pp. S40-S47, 2005.
- [136] F. Effenberger, D. Cleary, O. Haran, R. D. Li, M. Oron, and T. Pfeiffer, "An introduction to PON technologies," *Ieee Communications Magazine*, pp. S17-S25, Mar 2007.

- [137] M. Hajduczenia, H. J. da Silva, and P. P. Monteiro, "EPON versus APON and GPON: a detailed performance comparison," *J. Opt. Netw.*, vol. 5, pp. 298-319, 2006.
- [138] ITUT, "G.984.1: Gigabit-capable Passive Optical Networks (GPON): General characteristics " 2003.
- [139] ITUT, "G.694.2 :Spectral grids for WDM applications: CWDM wavelength grid Series G: Transmission Systems and Media, Digital Systems and Networks Transmission media characteristics - Characteristics of optical components and subsystems," ITU-T December 2003.
- [140] F. Koyama, "Recent advances of VCSEL photonics," *Journal of Lightwave Technology*, vol. 24, pp. 4502-4513, 2006.
- [141] W. Hofmann, M. Gorblich, G. Bohm, M. Ortsiefer, L. Xie, M. C. Amann, and Ieee, "Long-Wavelength 2-D VCSEL arrays for Optical Interconnects," in *Conference on Lasers and Electro-Optics/Quantum Electronics and Laser Science Conference*, San Jose, CA, 2008, pp. 744-745.
- [142] K. Kanonakis and I. Tomkos, "Online upstream scheduling and wavelength assignment algorithms for WDM-EPON networks," in *35th European Conference on Optical Communication, 2009. ECOC '09.* , 2009, pp. 1-2.
- [143] M. Hajduczenia and H. J. A. da Silva, "Next generation PON systems - Current status," in *11th International Conference on Transparent Optical Networks, 2009. ICTON '09.* , 2009, pp. 1-8.
- [144] C. H. Chang, P. Kourtessis, and J. M. Senior, "Dynamic Bandwidth assignment for Multi-service access in GPON," in *12th European Conference on Networks and Optical Communications (NOC)*, Stockholm, Sweden, 2007.
- [145] "OPNET Modeler 14.5 Manual," 14.5 ed Bethesda: OPNET Technologies, 2008.
- [146] ITU-T, "G.984.1 Gigabit-capable Passive Optical Networks (GPON): General characteristics," ITU-T, Ed.: ITU-T, 2003.
- [147] ITU-T, "G.984.3 Gigabit-capable Passive Optical Networks (G-PON): Transmission convergence layer specification ", ITU-T, Ed.: ITU-T, 2004.
- [148] E. C. Mark and B. Azer, "Self-similarity in World Wide Web traffic: evidence and possible causes," *IEEE/ACM Trans. Netw.*, vol. 5, pp. 835-846, 1997.
- [149] S.-i. Choi, "Cyclic Polling-Based Dynamic Bandwidth Allocation for Differentiated Classes of Service in Ethernet Passive Optical Networks," *Photonic Network Communications*, vol. 7, pp. 87-96, 2004.
- [150] ITU-T, "G.984.2: Gigabit-capable Passive Optical Networks (G-PON): Physical media dependent (PMD) layer specification," ITU-T, Ed.: ITU-T, 2003.
- [151] A. Cauvin, A. Tofanelli, J. Lorentzen, J. Brannan, A. Templin, P. Taesang, and K. Saito, "Common technical specification of the G-PON system among major worldwide access carriers," *Communications Magazine, IEEE*, vol. 44, pp. 34-40, 2006.

- [152] "Super Fast Broadband ". vol. 2008.
- [153] ITU-T, "G.114: One-way transmission time," ITU-T, Ed.: ITU-T, 2003.
- [154] T. Yamada and P. Thanh Hoa, "High-speed infrastructure cellular network for vehicular users," in *International Conference on Ultra Modern Telecommunications & Workshops, 2009. ICUMT '09.*, 2009, pp. 1-5.
- [155] P. Chowdhury, B. Mukherjee, S. Sarkar, G. Kramer, and S. Dixit, "Hybrid wireless-optical broadband access network(woban) : prototype development and research challenges," *IEEE Network.* , vol. 23, pp. 41-48, 2009.

# Appendix: OPNET Simulation Model's Attributes

The OPNET simulation model Attribute values are shown the below figures:

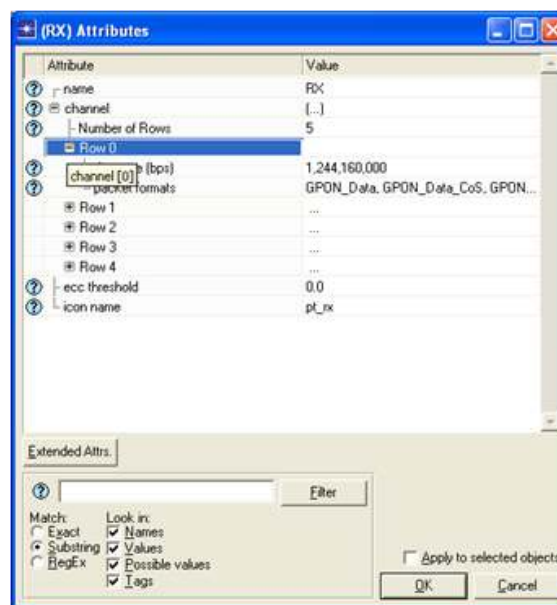


Figure 8-3: OLT Upstream Direction Receiver Attributes



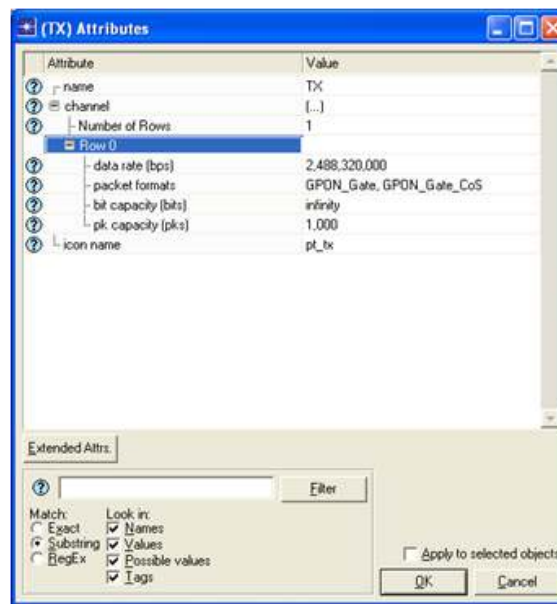


Figure 8-4: OLT Downstream Transmitter Attributes

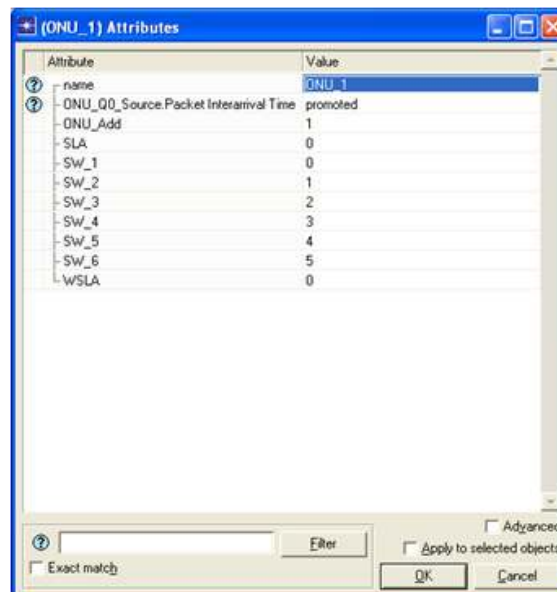


Figure 8-5: ONU Node Attributes

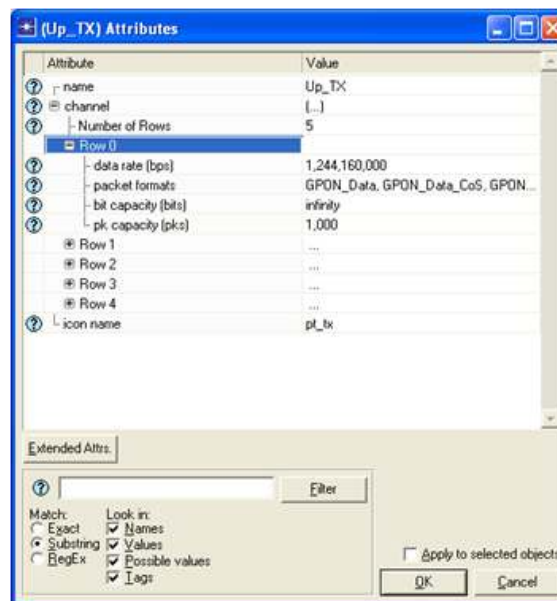


Figure 8-6: ONU Upstream Direction Transmitter Attributes

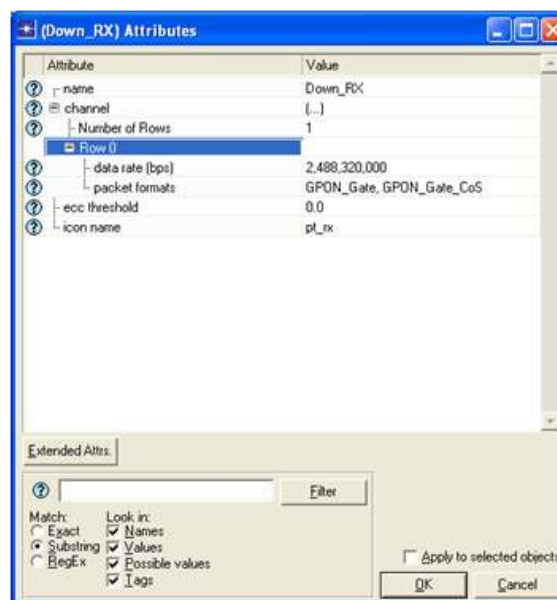


Figure 8-7: ONU Downstream Direction Receiver Attributes

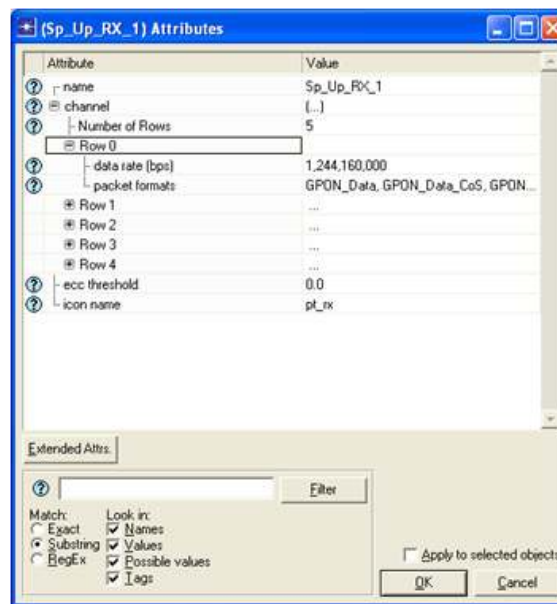


Figure 8-8: Splitter Upstream Direction Receiver Attributes

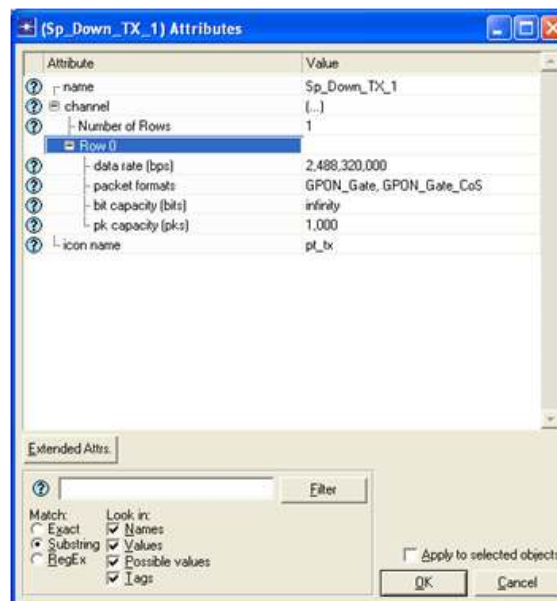


Figure 8-9: Splitter Downstream Direction Transmitter Attributes

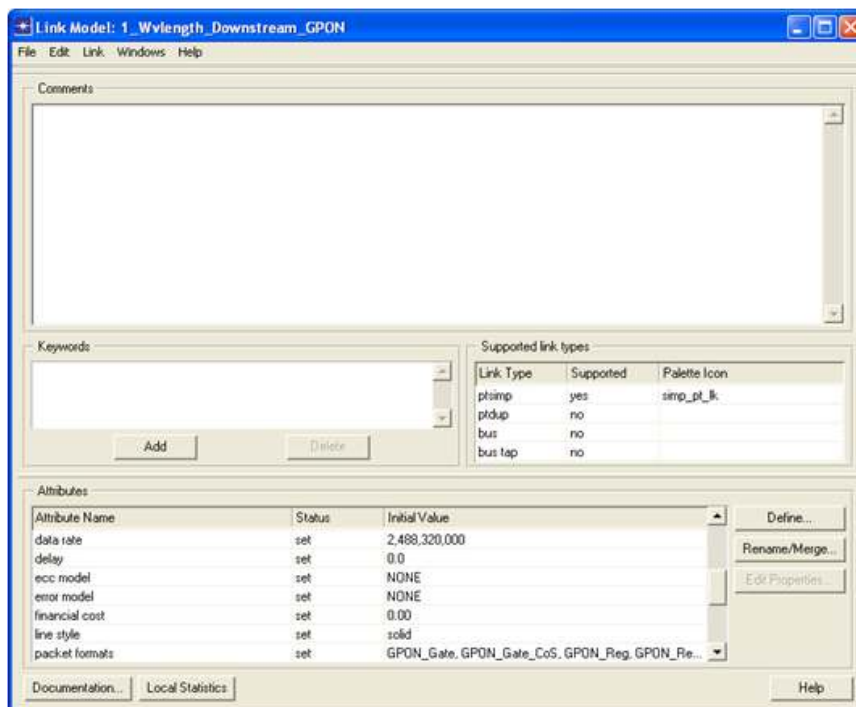


Figure 8-10: One Wavelength Downstream Link Attributes

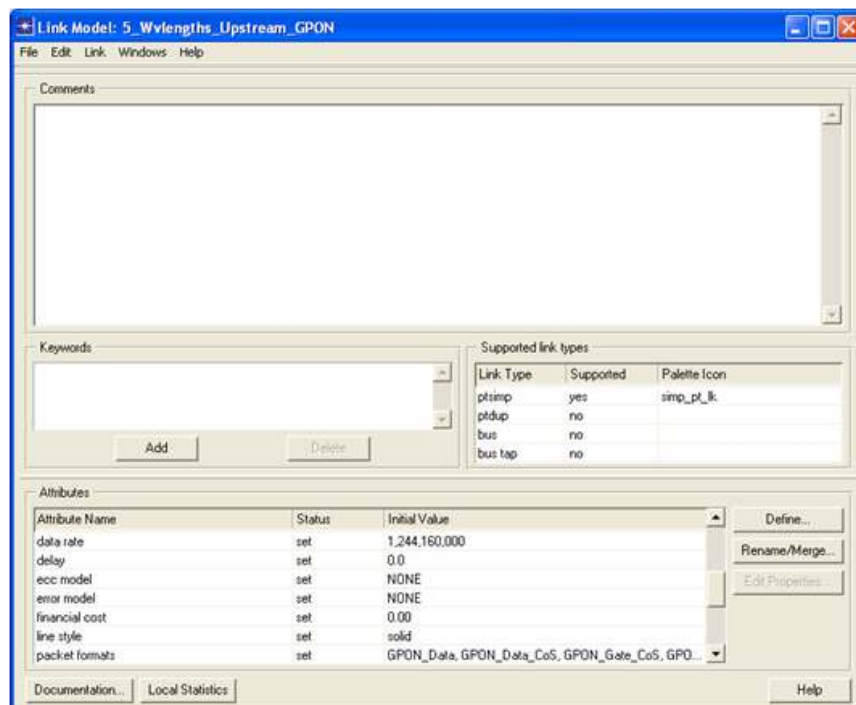


Figure 8-11: Five Wavelengths Upstream Link Attributes