

Dynamic nonlinear analysis of pile foundations using finite element method in the time domain

Guoxi Wu and W.D. Liam Finn

Abstract: A quasi-three-dimensional method of analysis is presented for the nonlinear dynamic analysis of single piles and pile groups. The analysis is performed in the time domain using strain-dependent moduli and damping, yielding at failure, and a no-tension cutoff. The analysis has been incorporated into the computer program PILE-3D and has been validated using data from centrifuge tests on a single pile and a 2×2 pile group under simulated earthquake loading. Analyses of the centrifuge tests demonstrated a significant reduction in soil moduli around the piles during strong shaking and a corresponding reduction in pile stiffnesses. The time-dependent shear modulus distribution in soil around the pile is obtained as part of the output. This allows the time variation of dynamic impedances of pile foundations during shaking to be established and allows a realistic assessment of the single-valued stiffnesses and damping factors usually incorporated into commercial structural analysis programs for the seismic analysis of pile-supported structures. The analysis also demonstrates the importance of inertial interaction between foundation and structure.

Key words: piles, dynamic, nonlinear, impedances, finite element, seismic response.

Résumé : Une méthode d'éléments finis quasi-tridimensionnelle est proposée pour analyser la réponse dynamique non linéaire des pieux isolés et des groupes de pieux. L'analyse est faite dans le domaine temps en utilisant des modules et des amortissements dépendants de la déformation, un écoulement à la rupture et un seuil de non-tension. L'analyse a été incorporée dans le programme PILE-3D et a été validée grâce à des essais en centrifugeuse sur un pieu isolé et sur un groupe de quatre pieux (2×2) dans des conditions de chargement sismique simulées. L'analyse des essais en centrifugeuse a montré qu'il y avait une réduction importante des modules autour des pieux pendant une sollicitation violente, accompagnée d'une réduction des raideurs dans les pieux. La répartition des modules de cisaillement en fonction du temps dans le sol entourant le pieu est obtenue comme résultat du calcul. Ceci permet d'établir la variation dans le temps des impedances dynamiques des pieux pendant la sollicitation et fournit une évaluation réaliste de la valeur unique des raideurs et des coefficients d'amortissement qui est habituellement introduite dans les programmes d'analyse de structures disponibles dans le commerce pour l'étude sismique des ouvrages fondés sur pieux. L'analyse démontre aussi l'importance de l'interaction inertielle entre la fondation et la structure.

Mots clés : pieux, dynamique, non-linéaire, impédance, éléments finis, réponse sismique.
[Traduit par la rédaction]

Introduction

This paper describes a method for the analysis of the nonlinear seismic response of pile foundations. The response is nonlinear because of the shear-strain dependence of soil moduli and damping ratios. Other factors that have a major impact on seismic response are seismically induced pore-water pressures, kinematic interaction between piles and foundation soils, and inertial interaction between the superstructure and foundation. At present there is no effective comprehensive practical method for the analyses of pile foundations that can take all these factors into account at the same time.

There are two main approaches to the analysis of pile foundations in practice: one analytical and the other semi-empirical. Typical of the analytical approach is elastic analysis using the program DYNA3 (Novak et al. 1990) with a somewhat arbitrary

reduction in shear modulus to account for nonlinear response. A good estimate for the reduced moduli is the free-field moduli compatible with the input motion as determined by a SHAKE analysis (Schnabel et al. 1972). This analysis neglects the effects of the additional strains caused by the kinematic and inertial interactions of the piles on soil moduli. The semi-empirical approach represents the interaction between pile and soil by nonlinear springs and dashpots. For design purposes, the pile head stiffnesses in this case are determined for specified displacements of the pile head. When using both of these methods for pile group analysis, dynamic pile-soil-pile interaction is approximated by elastic interaction factors. The static interaction factors of Poulos and Davis (1980) are usually used, except in the case of DYNA3 in which the elastic dynamic interaction factors (Kaynia and Kausel 1982) are used. These factors, however, are available only for a limited range of pile groups.

These two approaches are described in a report to the Department of Transportation of the State of Washington, U.S.A. (Crouse 1992). Two examples are given: (1) analyze the pile foundation using computer program DYNA3 (Novak et al. 1990) but reduce the initial soil shear moduli by 50% and (2) use p - y curves (nonlinear springs) and dashpots to simulate the

Received February 17, 1996. Accepted October 17, 1996.

G. Wu. Agra Earth & Environmental Ltd., 2227 Douglas Road, Burnaby, BC V5C 5A9, Canada.

W.D.L. Finn. Department of Civil Engineering, The University of British Columbia, Vancouver, BC V6T 1Z4, Canada.

nonlinearity of the soil response. For design purposes, lateral pile head stiffness in the latter case is to be evaluated at a displacement of 25 mm (1.0 in.) at the pile head. The pile head stiffness from the p - y approach can be much less than that from the DYNA3 analysis.

The method presented here, which is incorporated in the program PILE-3D (Wu and Finn 1994a), deals realistically and comprehensively with all these factors except seismic pore-water pressures. A modification of the method is now under development to cope with these factors.

Nonlinear dynamic analysis in the time domain

The method for nonlinear analysis is an extension of the method for elastic analysis presented by Wu and Finn (1997). Therefore only a brief summary of the general approach will be given here. The extension to nonlinear behaviour is described in detail.

Finite element formulation

Under vertically propagating shear waves (Fig. 1) the soil undergoes primarily shearing deformations in XOY plane, except in the area near the pile where extensive compressional deformations develop in the direction of shaking. The compressional deformations also generate shearing deformations in YOZ plane. Therefore, assumptions are made that dynamic response is governed by the shear waves in the XOY and YOZ planes, and the compressional waves in the direction of shaking, Y . Deformations in the vertical direction and normal to the direction of shaking are neglected. Comparisons with full three-dimensional (3D) elastic solutions confirm that these deformations are relatively unimportant for horizontal shaking (Wu and Finn 1997). Applying dynamic equilibrium in the Y direction, the dynamic governing equation under free vibration of the soil continuum is written as

$$[1] \quad \rho_s \frac{\partial^2 v}{\partial t^2} = G \frac{\partial^2 v}{\partial x^2} + \theta G \frac{\partial^2 v}{\partial y^2} + G \frac{\partial^2 v}{\partial z^2}$$

where v is the displacement in the Y direction, G is the shear modulus of the soil, ρ_s is the mass density of the soil, and $\theta = 2/(1 - \mu)$ based on equilibrium of the model in the direction of shaking.

Piles are modelled using the ordinary Eulerian beam theory. Bending of the piles occurs only in the direction of shaking. Dynamic soil-pile interaction is maintained by enforcing displacement compatibility between the pile and soils.

A quasi-3D finite element program PILE-3D (Wu and Finn 1994a) has been developed for the analysis of dynamic soil-pile-structure interaction. An eight-node brick element is used to represent soil, and a two-node beam element is used to simulate the piles. Following the general procedures used for the finite element method, the mass and stiffness matrices of a soil element are obtained from eq. [1]. The global dynamic equilibrium equations are written in matrix form as

$$[2] \quad [M]\{\ddot{v}\} + [C]\{\dot{v}\} + [K]\{v\} = -[M]\{I\}\ddot{v}_0(t)$$

in which $\ddot{v}_0(t)$ is the base acceleration, $\{I\}$ is a unit column vector, and $\{\ddot{v}\}$, $\{\dot{v}\}$, and $\{v\}$ are the relative nodal acceleration, velocity, and displacement, respectively. $[M]$, $[C]$, and $[K]$ are the mass, damping, and stiffness matrices, respectively. Direct

Fig. 1. The principle of the quasi-3D dynamic analysis of the pile-soil-structure interaction.

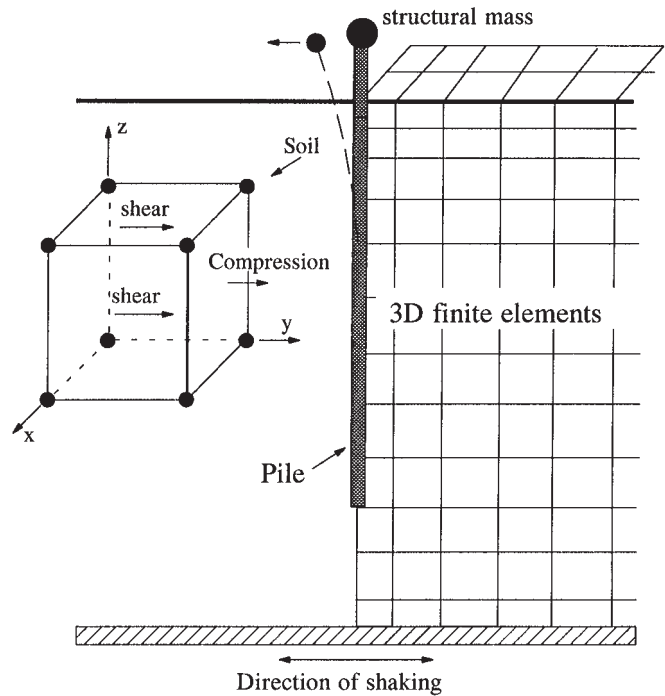

step-by-step integration using the Wilson θ method is employed in PILE-3D to solve the equations of motion in eq. [2].

The nonlinear hysteretic behaviour of the soil is modelled by using a variation of the equivalent linear method in the SHAKE program (Schnabel et al. 1972). Additional features such as tension cutoff and yielding are incorporated in the program to simulate the possible gapping between the soil and pile near the soil surface and yielding in the near field. These features are described below.

Simulation of soil nonlinear stress-strain response

An equivalent linear method is employed in PILE-3D to model the nonlinear hysteretic behaviour of soil. The basis of this method is the assumption that the hysteretic behaviour of soil can be approximated by a set of secant shear moduli and viscous damping ratios that are compatible with current levels of shear strain. Typical relationships among the shear modulus, damping ratio, and effective shear strain can be found in Seed and Idriss (1970) and Seed et al. (1986). This method has been widely accepted in engineering practice. The method has been incorporated in the computer code SHAKE (Schnabel et al. 1972) for one-dimensional ground motion analyses and in QUAD-4 (Idriss et al. 1973) for two-dimensional plane strain analyses.

In current practice this approach has been incorporated by assigning a constant effective secant shear modulus and damping ratio to a soil element for the entire duration of shaking to represent the time variation of shear modulus in an iteration procedure for analysis. The effective shear strain is commonly set to be 65% of the maximum shear strain experienced by the soil element during the previous iteration.

To approximate better the nonlinear behaviour of soil under strong shaking, in PILE-3D compatibility among the secant

Fig. 2. A mechanical model used for the analysis of a pile group with a rigid pile cap.

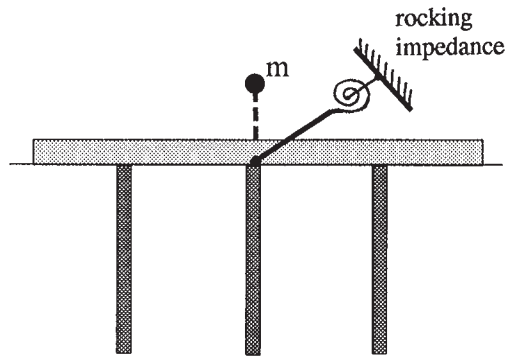

shear modulus, damping ratio, and shear strain may be enforced at each time step during the integration of equations of motions. This ensures that the time histories of moduli and damping ratios in each soil element are followed during the analysis, in contrast with the equivalent linear approach described earlier in which a single effective value is used to represent the entire time history.

In a practical PILE-3D analysis, the shear moduli and damping ratios are updated at specified time intervals ranging from each time step for integration to intervals that balance accuracy and computational time. For the analyses presented herein, it was sufficient to update the soil properties every 0.5 s based on the peak strain levels from the previous time interval. This value was selected on the basis of preliminary analyses using different time intervals.

Equivalent viscous damping

The hysteretic damping ratio λ of soil is included by using equivalent viscous damping. A procedure for estimating viscous damping coefficients for each individual element proposed by Idriss et al. (1974) is employed in PILE-3D. The main advantage of this procedure is that a different degree of damping can be applied in each finite element according to its shear strain level. The damping is essentially of the Rayleigh type, which is both mass and stiffness dependent.

The damping matrix $[C]_{\text{elem}}$ for a soil element is given by

$$[3] \quad [C]_{\text{elem}} = \lambda_{\text{elem}} \left(\omega_1 [M]_{\text{elem}} + \frac{[K]_{\text{elem}}}{\omega_1} \right)$$

where ω_1 is the fundamental frequency of the pile-soil system and is applied to each element. The frequency ω_1 is obtained by solving the corresponding eigenvalue problem. The hysteretic damping ratio, λ_{elem} , is prescribed as a function of element shear strain (Seed et al. 1986).

Yielding and tension

The soil model in PILE-3D incorporates soil yielding and potential gapping between the pile and attached soil. In this context, yielding means that soil continues to deform at a constant stress representative of the shear strength of the soil. Gapping is taken into account by not allowing any tension to occur between the pile and soil. This is accomplished by ensuring that the normal stress in the direction of shaking does not exceed the assigned tensile strength (normally zero for sand) of a soil element (Wu 1994).

Fig. 3. The layout of the centrifuge test for a single pile. C.G., centre of gravity; L.E.D., light emitting device.

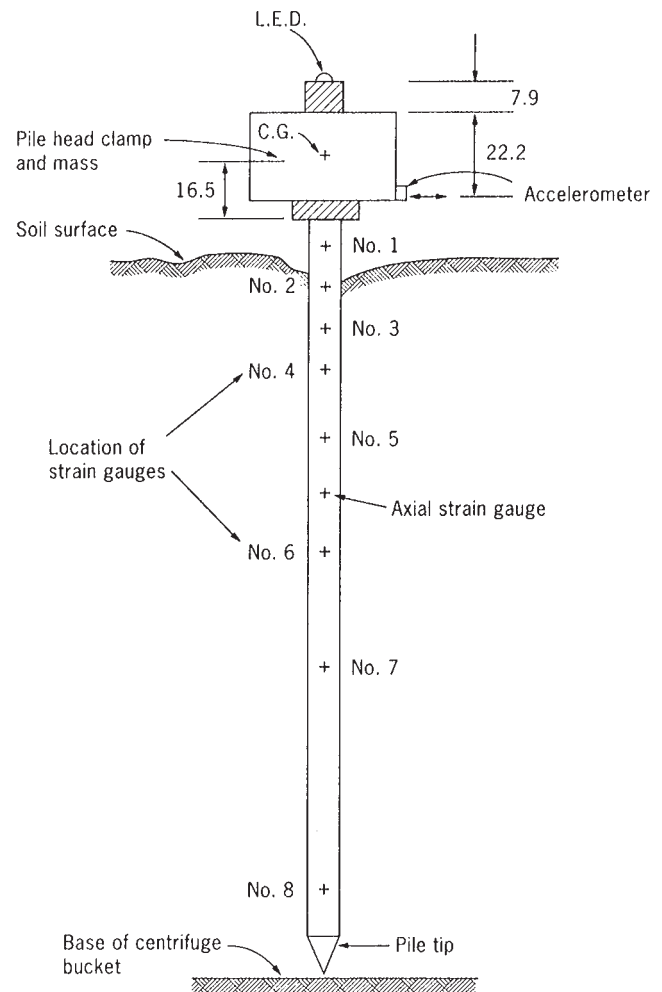

Analysis of a pile group

The program PILE-3D has the capability of simulating the dynamic response of a pile group supporting a rigid pile cap. The rigid pile cap is represented by a concentrated mass at the centre of gravity of the pile cap, and the mass is rigidly connected to the piles by a massless rigid bar.

This procedure ensures that the pile head nodes have the same lateral displacements and rotations as the pile cap does. Therefore any pile head node can be used to represent the motions of all pile head nodes or of the pile cap. The mass of the pile cap is then connected to the representative pile head node.

The response of the pile group to seismic excitation by shear waves propagating vertically is analyzed using the model in Fig. 2. The rocking stiffness of the pile cap, which is primarily due to the vertical resistance of the piles, is represented by a rotational spring. The spring stiffness is updated at selected time intervals during the seismic response analysis. This is done by running PILE-3D in the vertical mode using the soil properties current at the time. The new rocking stiffness is returned to PILE-3D operating in the horizontal mode and the analysis continues.

Fig. 4. The prototype model of the single pile test.

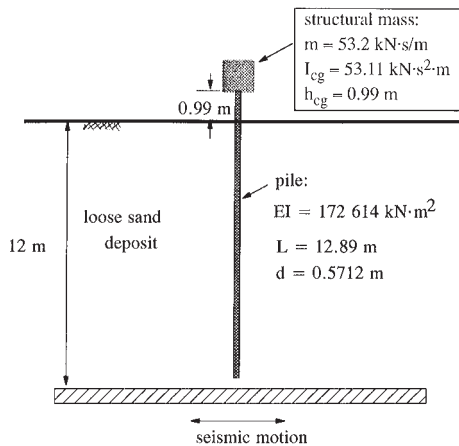
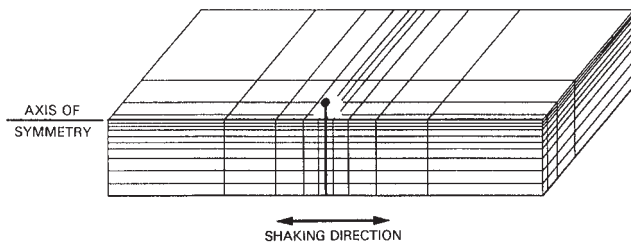

Fig. 5. The finite element modelling of the single pile.



Seismic response of a single pile

PILE-3D is used to analyze the seismic response of a single pile in a centrifuge test carried out on the California Institute of Technology (Caltech) centrifuge by W.B. Gohl (1991). Details of the test may also be found in a paper by Finn and Gohl (1987). A horizontal acceleration record with a peak value of 0.158g was input at the base of the system. Figure 3 shows the instrumented model pile used in the test. The test was conducted in a radial gravity field of 60g. The corresponding prototype parameters for the single pile test are shown in Fig. 4. The sand used in this test is a dry sand with a void ratio $e_0 = 0.78$, a unit weight of $\gamma = 14.72 \text{ kN/m}^3$, and a friction angle of $\phi = 30^\circ$.

The finite element model used for the analysis is shown in Fig. 5. The mesh consists of 666 nodes and 456 elements. Because of symmetry, the analysis can be conducted on half the pile foundation. This greatly reduces the scope of the analysis. The sand deposit is divided into 11 layers. Layer thickness is reduced as the soil surface is approached to allow more detailed modelling of the stress and strain field where lateral soil–pile interaction is strongest. The pile is modelled using 15 beam elements including 5 elements above the soil surface. The superstructure mass is a rigid body, and its motion is represented by a concentrated mass at its centre of gravity. The model mass is maintained at the correct height above the pile head by a very stiff beam element with flexural rigidity 1000 times that of the pile.

The finite element analysis is carried out in the time domain. Nonlinear analysis is performed to account for the changes in shear moduli and damping ratios due to dynamic

Fig. 6. The relationships between shear modulus, damping, and the shear strain for the loose sand.

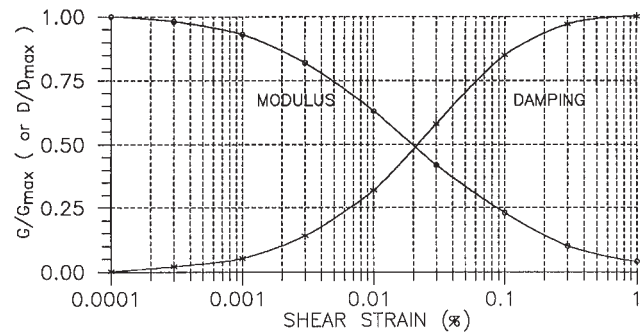
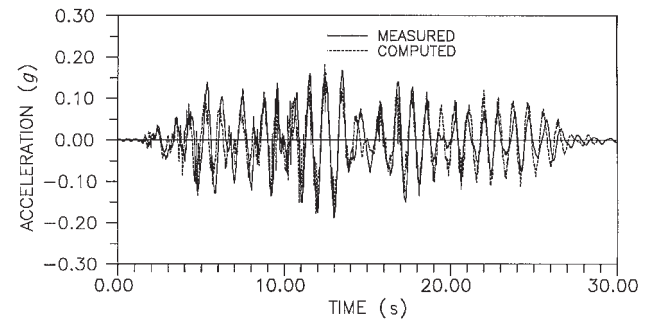

Fig. 7. The computed versus measured acceleration response at the pile head of the single pile.



shear strains. The shear-strain dependent shear moduli and damping ratios used in the analysis are shown in Fig. 6. The maximum damping ratio of the loose sand is taken as $D_{\max} = 25\%$ (Gohl 1991). The low strain shear moduli G_{\max} are determined using the equation proposed by Hardin and Black (1968), which gives G_{\max} as a function of void ratio and effective mean normal stress. A lateral stress coefficient $K_0 = 0.4$ is used in determining the effective mean normal stresses. Gohl (1991) measured the distribution of shear moduli with depth in the model foundation using Bender elements, while the centrifuge was operating at 60g, and verified the applicability of the Hardin and Black equation for the centrifuge tests.

The computed acceleration response at the pile head is plotted against the measured response in Fig. 7. Fairly good agreement between the measured and the computed accelerations is observed in the region of strong shaking. The computed time history of moments in the pile at a depth of 3 m (near point of maximum moment) is plotted against the recorded time history in Fig. 8. There is satisfactory agreement between the computed and measured moments in the range of larger moments. The computed and measured moment distributions along the pile at the instant of peak pile head deflection are shown in Fig. 9. The computed moments agree quite well with the measured moments except near the bottom of the pile where the measured moments show an abrupt change in response that hardly seems consistent with likely pile behaviour. Possibly there may have been some technical problems with the second gauge station from the bottom. The moments along the pile have same signs at any instant of time, suggesting that the inertial interaction caused by the pile head mass dominates response and the pile is vibrating in its first mode. The peak

Fig. 8. The computed versus measured moment response at depth $D = 3$ m of the single pile.

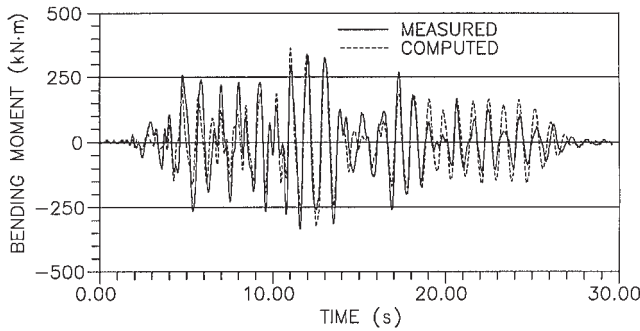
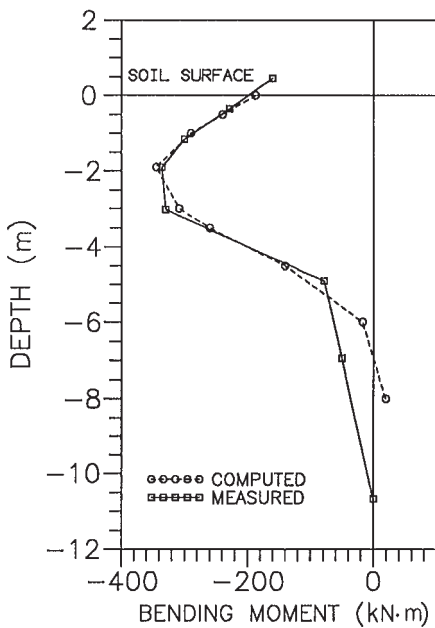

Fig. 9. Comparison between measured and computed bending moments at peak pile deflection for the single pile.



moment predicted by the quasi-3D finite element analysis is 344 kN·m, compared with a measured peak value of 325 kN·m.

Seismic response analysis of a pile group

The seismic response of a four pile group in a centrifuge test (Gohl 1991; Finn and Gohl 1987) is next analyzed using the program PILE-3D. The piles are set in a 2×2 arrangement at a centre to centre spacing of 2 pile diameters as shown in Fig. 10. The properties of each pile are identical to those of the single pile described earlier. The group piles were rigidly clamped to a stiff pile cap, and four cylindrical masses were bolted to the cap to simulate the inertia of a superstructure. The instrumentation on the pile cap assembly is also shown in Fig. 10. The displacements were tracked by means of an LED mounted on the pile cap assembly as in the case of the single pile test. The accelerations were recorded by an accelerometer mounted on the pile cap itself.

After conversion to prototype scale, the pile cap has a mass of 220.64 Mg and a mass moment of inertia about its centre of

Fig. 10. Layout of centrifuge test for a four-pile group.

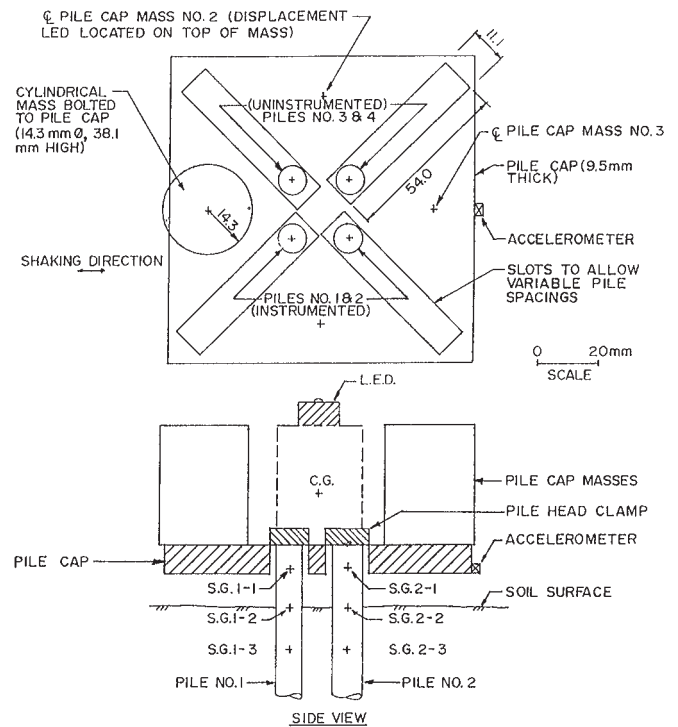

gravity of $I_{cg} = 715.39 \text{ Mg}\cdot\text{m}^2$. The centre of mass of the total pile cap assembly is 0.96 m above the top of the pile cap, and the free-standing pile length is 1.21 m (Gohl 1991).

The sand used for the pile-group test is a dry dense sand with a void ratio of $e_0 = 0.57$, a unit weight of $\gamma = 16.68 \text{ kN/m}^3$, and a friction angle of $\phi = 45^\circ$. The small strain shear moduli G_{max} are evaluated using the Hardin and Black (1968) equation with a lateral stress coefficient of $K_0 = 0.6$. The maximum hysteretic damping ratio of the sand foundation is taken as $D_{max} = 25\%$ (Gohl 1991).

The four pile group was shaken by a simulated earthquake acceleration motion. Peak horizontal accelerations of up to 0.14g were applied to the base of the foundation. Predominant frequencies were in the range of 0 to 5 Hz. The free-field accelerations were strongly amplified through the sand deposit to values of up to 0.26g at the surface. Pile cap accelerations of up to 0.24g and displacements up to 60 mm were recorded during the test. Residual displacements of up to 10 mm remained at the end of earthquake motion.

The finite element mesh used to analyze the pile group is shown in Fig. 11. It consists of 947 nodes and 691 elements. A refined mesh is used around the pile near the surface where soil experiences the greatest strains and contributes most to the lateral resistance of the pile. The foundation is modelled by 11 horizontal layers with a smaller thickness toward the sand surface. Each pile is modelled using 15 beam elements, including 5 elements for each part above soil surface. A very stiff massless beam element, simulating the pile cap, is used to connect the pile cap mass to the pile heads.

Figure 12 shows the computed acceleration response at the pile cap versus the measured acceleration response. There is fairly good agreement between the measured and the computed accelerations. The computed peak acceleration at the

Fig. 11. Finite element modelling of the four-pile group.

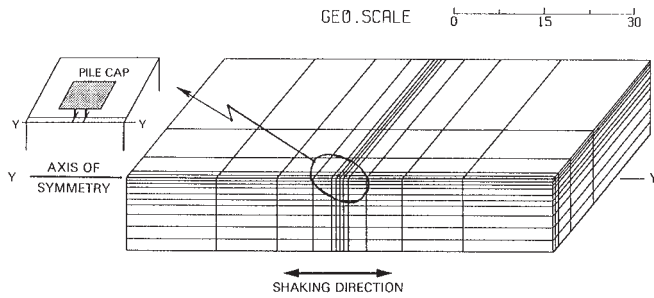
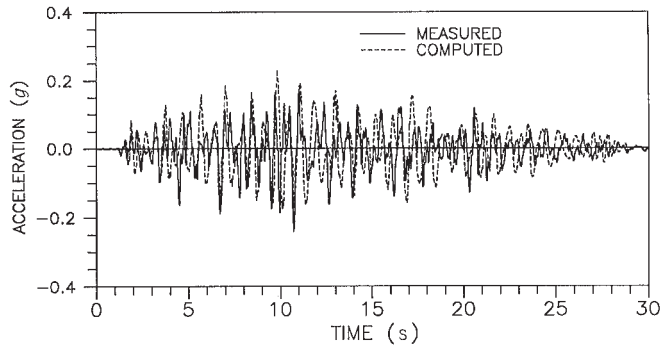

Fig. 12. The computed versus measured acceleration response at the pile cap of the four-pile group.



pile cap is 0.23g, which agrees very well with the measured peak acceleration of 0.24g.

The computed displacement at the top of the structural mass matches fairly well with the measured displacement in the first 11 s of motion (Fig. 13). The computed displacement response does not show any residual displacement since the analysis is carried out using the equivalent linear elastic approach. The measured displacement response shows a residual displacement of about 10 mm at the end of earthquake motion. The increase in permanent deformation during shaking leads to the measured and computed cycles of dynamic displacement being out of phase.

The computed moment time history in the instrumented pile at a depth of 2.63 m in the location of maximum moment is plotted against the measured moment time history in Fig. 14. There is good agreement between the measured and the computed moments. The distribution of computed and measured bending moments along the pile at the instant of peak pile cap displacement are shown in Fig. 15. The computed moments agree reasonably well with the measured moments, especially in the range of maximum moments. The computed peak moment is 203 kN·m, compared with a measured peak moment of 220 kN·m.

Nonlinear pile impedances

Dynamic stiffness of the single pile

The estimation of pile impedances under nonlinear conditions using PILE-3D will be explained here using the centrifuge tests on the single pile shown in Fig. 3. The shear moduli and damping ratios of the soil are both space and time dependent.

Fig. 13. The computed versus measured displacement response at the top of structural mass of the four-pile group.

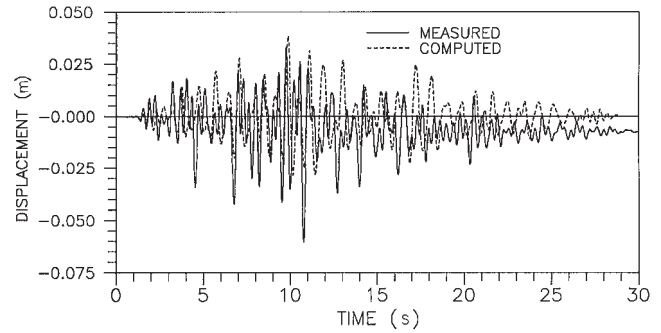
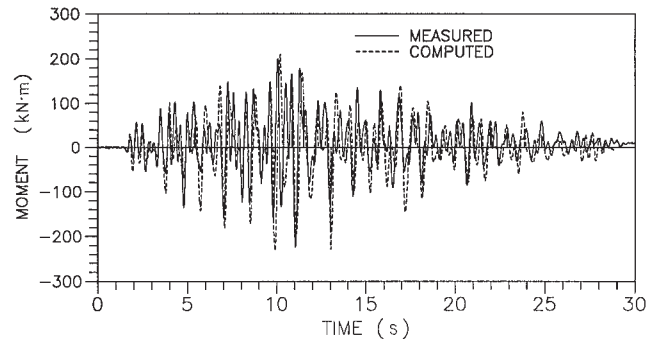

Fig. 14. The computed versus measured moment response at depth $D = 2.63$ m of the four-pile group.



The PILE-3D analysis is capable of tracing these variations of soil properties during shaking. As an example of the space distribution, soil shear moduli at depths of 0.25 and 2.10 m in the soil around the pile at a time $t = 12.58$ s are shown in Fig. 16. The space distribution of moduli and damping ratios at time t allows the instantaneous stiffness and damping of the pile foundation to be determined at time t . This allows the dynamic impedances to be computed as functions of time. The calculations are done by applying harmonic loads at the pile head and solving the resulting equations to obtain the complex valued pile head impedances corresponding to unit displacements or unit rotations. For cases presented here, the impedances were evaluated at the ground surface using PILIMP (Wu and Finn 1994b), specifically designed to calculate pile impedance for given space distribution of moduli and damping ratios.

At the excitation frequency $f = 1.91$ Hz, the dynamic stiffnesses (real part of dynamic impedance) of the pile decrease dramatically as the level of shaking increases (Fig. 17a). The dynamic stiffnesses experienced their lowest values in the 10 to 14 s range when the largest displacements occurred at the pile head (Fig. 17b). It can be seen that the translational stiffness k_{vv} decreased more than the rotational stiffness $k_{\theta\theta}$ or the cross-coupling stiffness $k_{v\theta}$. At their lowest levels, k_{vv} decreased to 20 000 kN/m, which is only 13.8% of its initial value of 145 000 kN/m, $k_{v\theta}$ decreased to 45 000 kN/rad, which is 36% of its initial value of 125 000 kN/rad, and $k_{\theta\theta}$ showed the least effect of shear strain, as it decreased to 138 000 kN·m/rad, which is 63.6% of its initial stiffness of 217 000 kN·m/rad. The stiffnesses recovered when the level of displacement decreased with time. Representative values of

Fig. 15. Comparison between measured and computed bending moments at peak pile cap displacement for the four-pile group.

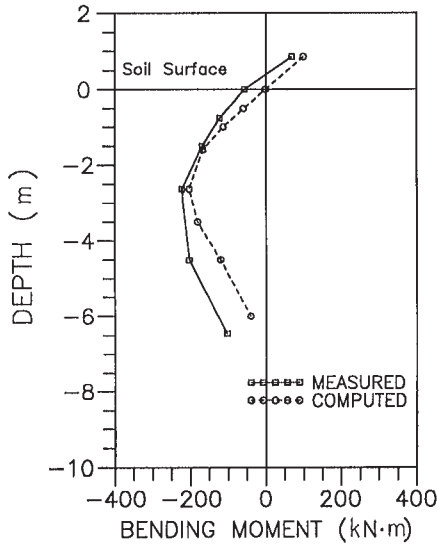
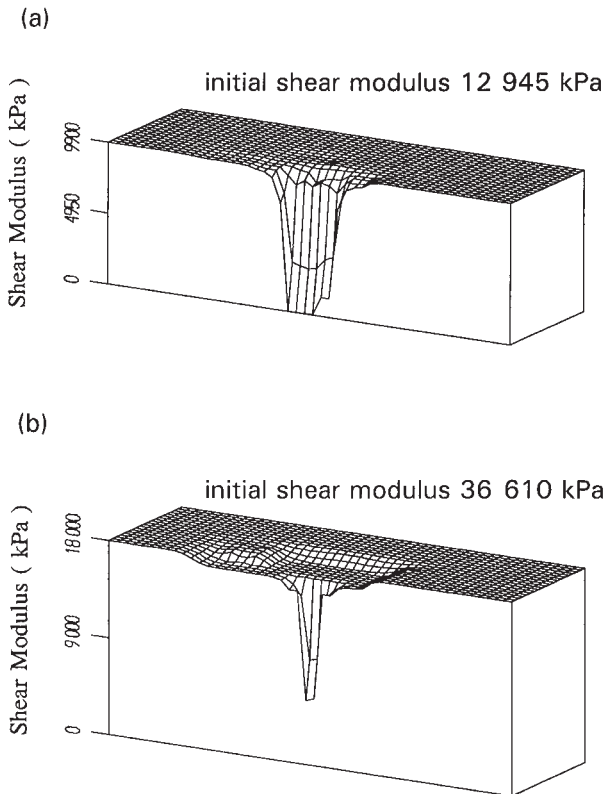
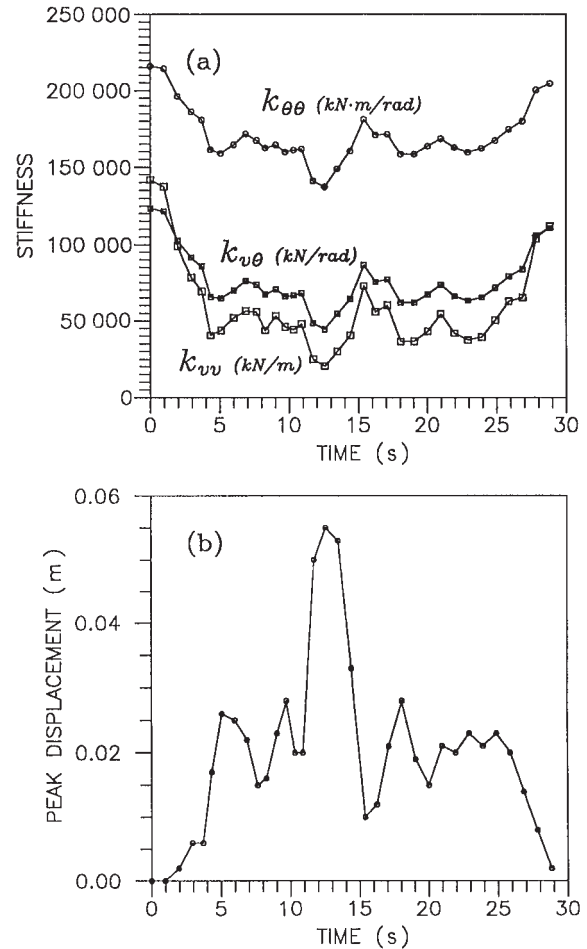

Fig. 16. Three-dimensional plots of the distribution of shear moduli at $t = 12.58$ s from the single pile analysis: (a) at a depth of 0.25 m, and (b) at a depth of 2.10 m.



the pile stiffnesses k_{vv} , $k_{v\theta}$, and $k_{\theta\theta}$ for incorporation as discrete springs into a commercial finite element program for structural analysis of the superstructure might be selected as 40 000 kN/m, 65 000 kN/rad, and 160 000 kN·m/rad, respectively, on the basis of the time histories shown in Fig. 17. These stiffnesses are 27.6, 52, and 73.7% of their original stiffnesses.

Fig. 17. Variation with time of (a) pile head stiffnesses k_{vv} , $k_{v\theta}$, and $k_{\theta\theta}$ at $f = 1.91$ Hz and (b) peak pile head displacements.



The variations of translational stiffness k_{vv} and rotational stiffness $k_{\theta\theta}$ with time at different excitation frequencies are shown in Fig. 18. It can be seen that the excitation frequency has little influence on the dynamic stiffness of the pile foundation for frequencies less than 10 Hz. Therefore, the dynamic stiffnesses of the pile foundation may be considered independent of frequency under seismic loading.

Dynamic stiffness of the four-pile group

The same technique is used to determine dynamic impedances of the four-pile group in Fig. 10. The variations of stiffnesses k_{vv} and $k_{v\theta}$ of the four-pile group with time are shown in Fig. 19a at an excitation frequency $f = 1.91$ Hz. It can be seen that stiffnesses k_{vv} and $k_{v\theta}$ decreased dramatically at times when the largest displacements occurred (Fig. 19b), and they recovered later with lower levels of displacement. The stiffness k_{vv} decreased to 80 000 kN/m from its initial stiffness of 460 000 kN/m; whereas $k_{v\theta}$ decreased to 160 000 kN/rad from its initial stiffness of 420 000 kN/rad. At maximum shaking intensity, the stiffnesses k_{vv} and $k_{v\theta}$ were reduced to about 17 and 38% of their initial values, respectively.

Effect of structural mass on pile impedances

In the analyses described above, the effect of the structural mass on dynamic impedances has been included. Studies were

Fig. 18. Variation of stiffnesses k_{vv} and $k_{\theta\theta}$ of the single pile with time under different excitation frequency.

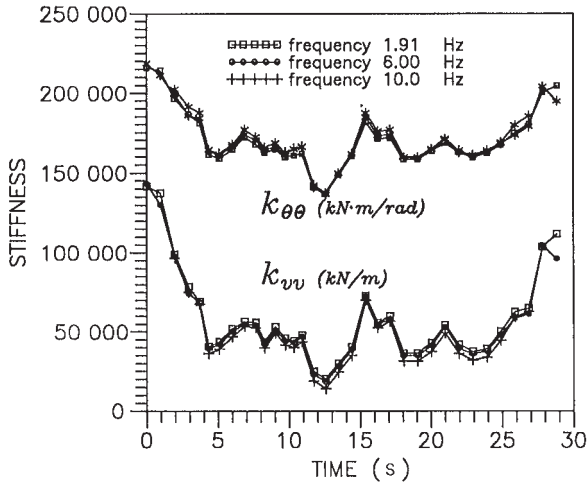
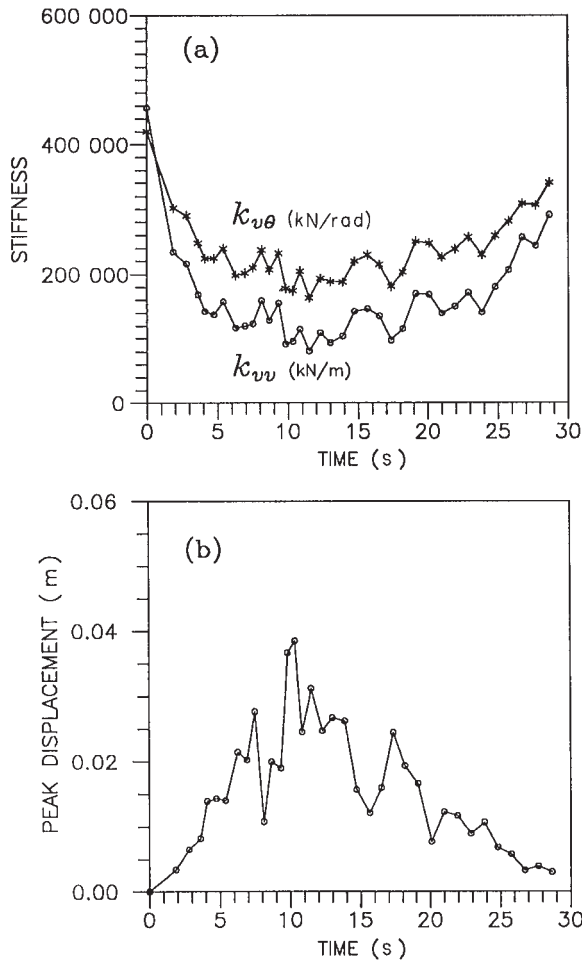
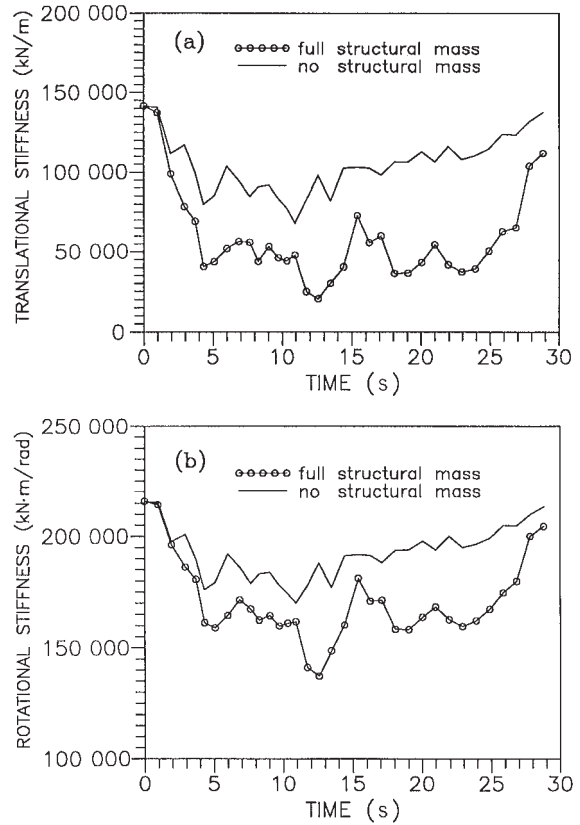

Fig. 19. Variation with time of (a) stiffnesses k_{vv} and $k_{v\theta}$ of the four-pile group at $f=1.91$ Hz, and (b) peak displacements at the pile cap.



conducted to explore the effect of structural mass on dynamic stiffnesses of pile foundations. The centrifuge tests of the single pile presented earlier were reanalyzed without taking the structural mass into account. A set of time-dependent shear

Fig. 20. Comparison of dynamic stiffnesses of the single pile with and without structural mass: (a) translational stiffness k_{vv} (b) rotational stiffness $k_{\theta\theta}$.



moduli and damping ratios of soil were obtained. Dynamic impedances of the pile foundation were computed again using the new sets of soil properties. The effect of the structural mass on dynamic stiffnesses of the pile foundation can be seen by comparing the translational and rotational stiffnesses of the pile foundation with and without the structural mass shown in Figs. 20a and 20b.

The heavy structural mass significantly increased the shear strain of soil in the near field, which reduced the soil modulus further and thus significantly changed the dynamic impedances. In such instances it is important to include inertial interaction in the foundation analysis. This may not necessarily be true in all cases because structural mass also changes the natural period of the foundation. However, it is clearly desirable to check whether the inertial interaction is important or not for a given case.

Computational time

The nonlinear analysis was carried out in the time domain. The average CPU time using a PC-486 (33 MHz) computer needed to complete one step of integration is 7.0 s for the finite element grid shown in Fig. 5, and 3 h of CPU time are required for an input record of 1550 steps. The computation time is much shorter for a linear elastic analysis, when the shear moduli of soil foundation remain constant through the time domain.

The average computational time for computing the dynamic impedances using PILIMP is 50 s for one set of soil

properties. The total computational time required to generate curves as shown in Fig. 17 is about 30 min. The analyses can be conducted in reasonable time on an IBM compatible PC. The analyses described herein were done on a 33 MHz machine. Recent Pentium Chip based machines could reduce the time requirements up to a factor of 5.

Conclusions and discussion

A quasi-3D method for nonlinear dynamic analysis of pile foundations has been presented. The method uses a simplified wave equation for describing soil response in a 3D half space. The method has been formulated in the time domain using the finite element method. The time-domain analysis allows modelling the variations of soil shear moduli and damping with time under earthquake loading.

Centrifuge tests of a single pile and a 2×2 pile group have been analyzed using the proposed quasi-3D finite element method of analysis. The ability of the program PILE-3D to model the seismic response adequately suggests that the modified equivalent linear approach may be effective for engineering purposes.

In addition to providing time histories of accelerations, displacements, and pile moments, PILE-3D is also capable of computing time-dependent dynamic impedances of pile foundation during an earthquake. The results of analyses showed that stiffnesses of the pile foundations decrease with the level of shaking. In a seismic event, the translational stiffness k_{vv} decreases the most due to the shear-strain dependency of soil stiffness; the rotational stiffness $k_{\theta\theta}$ shows the least effect of shear strain. The proposed quasi-3D method directly takes into account both the nonlinear pile-soil-pile kinematic interaction of pile groups and the superstructure-foundation inertial interaction. The time variation of dynamic impedances of pile foundations allows a realistic selection of the representative discrete stiffnesses and damping ratios required by commercial structural analysis programs.

A major advantage of the quasi-3D method is that solutions can be readily obtained on IBM compatible PC computers in a very short time compared to full 3D analysis.

Acknowledgement

The postgraduate fellowship awarded by the Natural Sciences and Engineering Research Council of Canada (NSERC) to the lead author is acknowledged. This work is also supported in part by a grant from NSERC to the second author.

References

Crouse, C.B. 1992. Effects of foundation-soil interaction. *Report by*

- Dames & Moore, Seattle, Wash., to the Washington State Department of Transportation, Olympia.
- Finn, W.D.L., and Gohl, W.B. 1987. Centrifuge model studies of piles under simulated earthquake loading. *In* Dynamic response of pile foundations—experiment, analysis and observation. American Society of Civil Engineers, Geotechnical Special Publication No. 11, pp. 21–38.
- Gohl, W.B. 1991. Response of pile foundations to simulated earthquake loading: Experimental and analytical results. Ph.D. thesis, Department of Civil Engineering, The University of British Columbia, Vancouver.
- Hardin, B.O., and Black, W.L. 1968. Vibration modulus of normally consolidated clay. *Journal of Soil Mechanics and Foundations, ASCE*, **98**: 667–692.
- Idriss, I.M., Lysmer, J., Hwang, R., and Seed, H.B. 1973. QUAD-4: A computer program for evaluating the seismic response of soil-structures by variable damping finite element procedures. Earthquake Engineering Research Centre, University of California, Berkeley, Report No. EERC 73-16.
- Idriss, I.M., Seed, H.B., and Serff, N. 1974. Seismic response by variable damping finite elements. *Journal of the Geotechnical Engineering Division, ASCE*, **100**: 1–13.
- Kaynia, A.M., and Kausel, E. 1982. Dynamic stiffnesses and seismic response of pile groups. Department of Civil Engineering, Massachusetts Institute of Technology, Cambridge, Report R 82-03.
- Novak, M., Sheta, M., El-Hifnawy, L., El-Marsafawi, H., and Ramadan, O. 1990. DYNA3: A computer program for calculation of foundation response to dynamic loads. Geotechnical Research Centre, the University of Western Ontario, London.
- Poulos, H.G., and Davis, E.H. 1980. Pile foundation analysis and design. John Wiley & Sons, Inc., New York.
- Schnabel, P.B., Lysmer, J., and Seed, H.B. 1972. SHAKE: A computer program for earthquake response analysis of horizontally layered sites. Earthquake Engineering Research Centre, University of California, Berkeley, Report No. EERC 72-12.
- Seed, H.B., and Idriss, I.M. 1970. Soil moduli and damping factors for dynamic response analyses. Earthquake Engineering Research Center, University of California, Berkeley, Report No. EERC 70-10.
- Seed, H.B., Wong, R.T., Idriss, I.M., and Tokimatsu, K. 1986. Moduli and damping factors for dynamic analyses of cohesionless soils. *Journal of Geotechnical Engineering, ASCE*, **112**: 1016–1032.
- Wu, G. 1994. Dynamic soil-structure interaction: Pile foundations and retaining structures. Ph.D. thesis, Department of Civil Engineering, The University of British Columbia, Vancouver.
- Wu, G., and Finn, W.D.L. 1994a. PILE-3-D: A computer program for quasi-3-D non-linear dynamic analysis of single piles and pile groups. Department of Civil Engineering, The University of British Columbia, Vancouver.
- Wu, G., and Finn, W.D.L. 1994b. PILIMP: A computer program for determining dynamic impedances of single piles and pile groups. Department of Civil Engineering, The University of British Columbia, Vancouver.
- Wu, G., and Finn, W.D.L. 1997. Dynamic elastic analysis of pile foundations using finite element method in the frequency domain. *Canadian Geotechnical Journal*, **34**: 34–43.