

Dynamic Peak Based Threshold Estimation Method for Mitigating Impulsive Noise in Powerline Communication Systems

Emad Alsusa, *Senior Member, IEEE*, Khaled M. Rabie, *Student Member, IEEE*

Abstract—Impulsive noise (IN) is one of the most dominant factors responsible for degrading the performance of powerline communication systems. One of the common techniques for mitigating IN is blanking which is applied at the front end of the receiver to zero the incoming signal when it exceeds a certain threshold. Determining the optimal blanking threshold (OBT) is however key for achieving the best performance. Most reported work to find the OBT are based on the availability of the long term characteristics of IN at the receiver. In this paper we consider orthogonal frequency-division multiplexing (OFDM) based powerline communications and propose a method for finding the OBT without requiring any knowledge about the IN. We show that there is a direct relationship between the OBT and the peak to average power value of the OFDM symbol and utilize it to identify the OBT. The results reveal that the proposed technique not only eliminates the need to prior knowledge about the characteristics of IN but also achieves a gain between 0.5–2.5dB depending on the accuracy of the signal peak to average estimate. It will also be shown how the performance of the proposed method can be further enhanced by employing some basic signal per-processing at the transmitter.

Index Terms—Blanking, impulsive noise, Middleton class-A noise, OFDM, PAPR, powerline communications (PLC), SINR, SNR.

I. INTRODUCTION

POWERLINES have always been the means to distribute electrical power. However, with the rising dependence on communications, powerline networks were seen as a possible medium for delivering data. This technology is commonly known as powerline communications (PLC). The main advantage of PLC is obviously the fact that they can exploit a pre-installed infrastructure of wiring networks hence additional cabling installation can be avoided and costs can be saved in addition to the ease of accessing the outlets which are distributed throughout any building [1].

On the other hand, using powerlines to transmit data signals requires overcoming a number of challenges [2]. In addition to varying impedance and high levels of frequency dependent attenuation [3], noise is the most crucial element influencing the communication signals over powerline networks [4]. Noise in powerline channels is typified into two categories [5] colored background noise and impulsive noise (IN). The latter is the most dominant factor that degrades the communication signals. In [6], it was experimentally found that the power spectral density (PSD) of IN always exceeds the PSD of background noise by at least 10 – 15dB and may reach as much as 50dB.

The authors are with the School of Electrical & Electronic Engineering, the University of Manchester, Manchester, M13 9PL, UK. (e-mails: {e.alsusa, khaled.rabie}@manchester.ac.uk).

To study the impact of IN on powerline communication systems, different methods have been suggested in the literature to model IN analytically and empirically [7]–[9]. The Middleton class-A model [7], [10] has been the most widely accepted in evaluating and analyzing PLC systems and therefore it will be adopted in this work for system performance evaluation. It is worthwhile mentioning that Middleton expounded his Class-A model with the assumption of IN being of a wideband shorter than that of the receiver.

Orthogonal frequency division multiplexing (OFDM) systems [11], have been proposed for PLC in [12] as they are less sensitive to IN than single carrier systems. However, if IN energy exceeds a certain threshold, this could turn into a disadvantage [13]. A number of IN mitigation methods with varying degrees of performance and complexity have been reported in the literature [14], [15]. The simplest of such methods is to precede the conventional OFDM demodulator with a blanker or a clipper [16], [17]. This method is widely used in practice because of its simplicity and ease of implementation [18]–[20]. Theoretical performance analysis and optimization of blanking was first investigated by Zhidkov in [21], [22] where a closed-form expression for the signal to noise ration (SNR) at the output of the blanker was derived and the problem of blanking threshold selection in the presence of IN was addressed.

To date, most studies on this topic are based on the fact that the long-term IN characteristics can be made available at the receiver from which the optimal blanking threshold (OBT) is determined. However, IN short-term variations may lead to misestimating the OBT which can degrade system performance significantly. To our knowledge, the impact of short-term variations of the IN on this method, referred to here as the conventional optimal blanking (COB) method, has not been addressed previously. Therefore the contribution of this paper is twofold. First we will assess the impact of short-term variations of IN on the COB method and then propose a different criterion for estimating the OBT independently of the IN characteristics. In contrast to previous studies, a direct relationship between OBT and the peak to average power ratio (PAPR) of the OFDM symbols is found and utilized for enhancing the performance of the blanking technique. This method will be referred to as dynamic peak based threshold estimation (DPTE) method. The results show that the proposed not only completely eliminates the need to prior knowledge about the short-term/long-term characteristics of IN but also achieves a gain between 0.5–2.5dB depending on the accuracy of the signal peak to average estimate. In addition, it will be shown that the performance can be further improved by

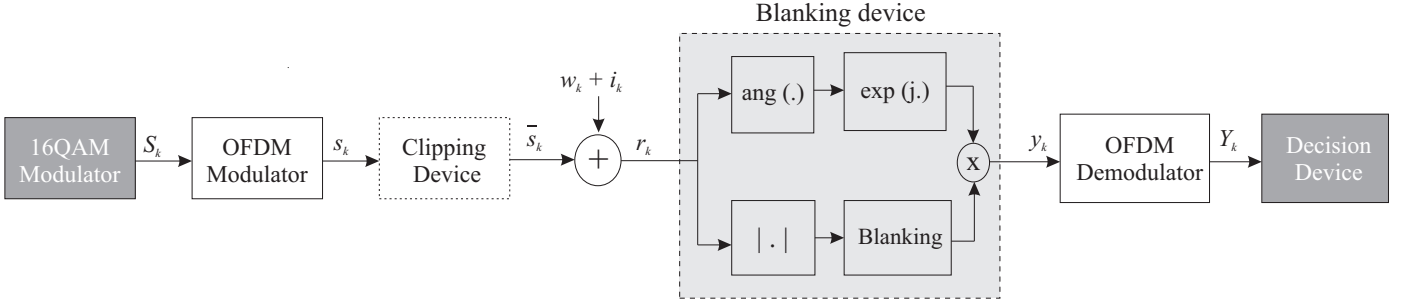

Fig. 1: Block diagram of OFDM system with blanking device at the receiver.

applying some basic preprocessing at the transmitter.

The rest of the paper is organized as follows. In Section II, the system model is described. The performance loss due to IN estimation errors for the COB method is investigated in Section III. In Section IV, the proposed technique is presented and the relationship between OBT and peaks of OFDM symbols is discussed. The simulation results are presented in Section V. Finally, conclusions are drawn in Section VI.

II. SYSTEM MODEL

The basic system model used is shown in Fig. 1. First the information bits are mapped into 16 quadrature amplitude modulation (16QAM) base band symbols S_k . Then, the 16QAM signal is passed through an OFDM modulator to produce a time domain signal, $s_k(t)$ defined as

$$s(t) = \frac{1}{\sqrt{N}} \sum_{k=0}^{N-1} S_k e^{j2\pi kt/T_s}, \quad 0 < t < T_s \quad (1)$$

where S_k is the complex constellations of the data symbols, N is number of sub-carriers and T_s is the active symbol interval. Using this definition, the PAPR of the transmitted signal is given by

$$\text{PAPR} = 10 \log_{10} \left(\frac{\max |s(t)|^2}{E[|s(t)|^2]} \right) \quad (2)$$

where $E[\cdot]$ is the expectation function. We assume that the signal power is normalized to unity and hence the PAPR simply indicates the peak value of the signal given by $peak = 10 \log_{10}(\max |s(t)|)$.

According to Middleton in [7], [10], IN is categorized into two classes A and B. However, PLC researchers consider IN over powerlines as Middleton class-A type, [23]–[25], with probability density function (PDF)

$$p(z) = \sum_{m=0}^{\infty} \frac{e^{-A} A^m}{m!} \cdot \frac{1}{\sqrt{2\pi\sigma_m^2}} e^{-\frac{z^2}{2\sigma_m^2}} \quad (3)$$

where

$$\sigma_m^2 = \sigma^2 \left(\frac{m}{A} + \Gamma \right) \quad (4)$$

$$\sigma^2 = \sigma_G^2 + \sigma_I^2 \quad (5)$$

$$\Gamma = \frac{\sigma_G^2}{\sigma_I^2} \quad (6)$$

While A measures the average number of impulses over the signal period and is referred to as impulsive index, σ^2 is the total noise power, σ_G^2 is the Gaussian noise power and σ_I^2 is the impulsive (non-Gaussian) noise power.

For the sake of simplicity, in this work a special case of Middleton class-A noise model is used in which IN is modeled as a Bernoulli-Gaussian random process [13]. This is referred to as two-component mixture-Gaussian model and is given by

$$n_k = w_k + i_k \quad (7)$$

where

$$i_k = b_k g_k, \quad k = 0, 1, 2, \dots, N-1 \quad (8)$$

n_k is the total noise component, w_k is the additive white Gaussian noise (AWGN), i_k is the IN, g_k is complex white Gaussian noise with mean zero and b_k is the Bernoulli process with probability mass function

$$\Pr(b_k) = \begin{cases} p, & b_k = 1 \\ 0, & b_k = 0 \end{cases} \quad k = 0, 1, \dots, N-1 \quad (9)$$

where p is referred to as the IN probability of occurrence. The PDF of the total noise can be expressed as

$$P_{n_k}(n_k) = (1-p) \mathcal{G}(n_k, 0, \sigma_w^2) + p \mathcal{G}(n_k, 0, \sigma_w^2 + \sigma_i^2) \quad (10)$$

$\mathcal{G}(\cdot)$ is the Gaussian PDF and is given by (11). σ_w^2 and σ_i^2 are the AWGN and IN variances, respectively. These variances define the input SNR and SINR as in (12) and (13), respectively.

$$\mathcal{G}(x, \mu, \sigma_x^2) = \frac{1}{\sqrt{2\pi\sigma_x^2}} e^{-\frac{(x-\mu)^2}{2\sigma_x^2}} \quad (11)$$

$$\text{SNR} = 10 \log_{10} \left(\frac{1}{\sigma_w^2} \right) \quad (12)$$

$$\text{SINR} = 10 \log_{10} \left(\frac{1}{\sigma_i^2} \right) \quad (13)$$

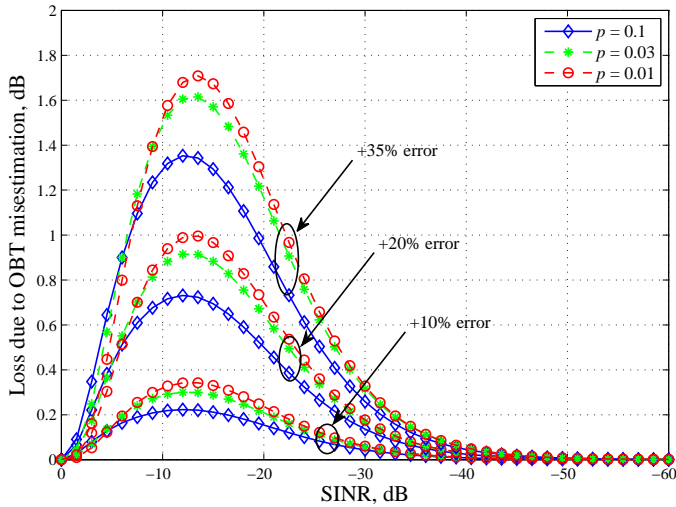

Fig. 2: The loss in output SNR caused by misestimating OBT by +10%, +20% and +35%, SNR = 25dB.

Under perfect synchronization condition, the received signal can be expressed as

$$r_k = s_k + w_k + i_k, \quad k = 0, 1, 2, \dots, N - 1 \quad (14)$$

where $s_k = s(kT_s/N)$; s_k , w_k and i_k are assumed to be mutually independent.

At the receiver, before the OFDM demodulator, blanking is applied, see Fig. 1. The basic principle of the blanking device [16], [21] follows

$$y_k = \begin{cases} r_k, & |r_k| \leq T \\ 0, & |r_k| > T \end{cases} \quad k = 0, 1, \dots, N - 1 \quad (15)$$

where T is the blanking threshold, r_k and y_k are the input and output of the blanker, respectively. If T is too small, most of the received samples of the OFDM signal will be set to zero resulting in poor bit error rate performance. On the other hand, for very large T , blanking will have a negligible effect on the received signal allowing most of the IN to be part of the detected signal hence degrading performance. Thus, the blanking threshold must be carefully chosen. In [21], theoretical expressions for OBT (T_{opt}) and output SNR for the COB method were derived as a function of IN parameters which are given by (16) and (17), respectively.

$$\text{SNR}_{COB} = \frac{2}{E[A_n^2]} \quad (17)$$

where $E[A_n^2]$ is defined as in (18). It was shown that these expressions work well when the IN characteristics are accurately known a priori. These expressions will be utilized in our comparative analysis to verify the accuracy of our simulation model.

III. PERFORMANCE LOSS DUE TO ESTIMATION ERRORS FOR COB METHOD

In this section the effect of using the non OBT on the output SNR when using the COB method is investigated. It is worth highlighting that estimation errors of the IN parameters could

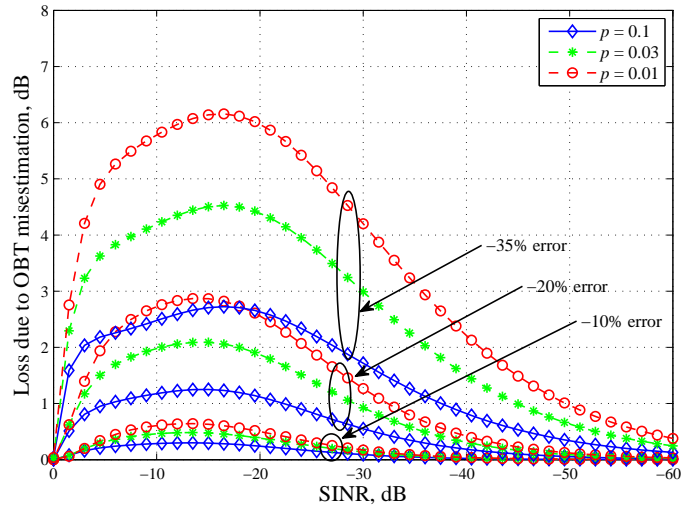

Fig. 3: The loss in output SNR caused by misestimating OBT by -10%, -20% and -35%, SNR = 25dB.

arise due to short-term channel time variations as well as noisy estimates. Fig. 2 and Fig. 3 show the loss in the output SNR due to misestimation of OBT for different values of p . These results are obtained as

$$L = 10 \log_{10} \left(\frac{\text{SNR}_{COB}}{\text{SNR}_{COB}^e} \right) \quad (19)$$

where SNR_{COB}^e is obtained from (17) by replacing T_{opt} with $(T_{opt} \pm e T_{opt})$ in (18) and (e) is the estimation error.

It is clear that as the deviation from the exact OBT increases, the loss in the output SNR becomes greater and more so for negative errors. For instance, for $p = 0.01$ and an error of +35% from the exact OBT value, the worst case scenario will be a loss of about 2.25dB at SINR = -15dB, whereas for an error of -35% the highest loss will be about 8.5dB at SINR = -20dB. The intuitive explanation of this phenomena is that as the blanking threshold goes below the OBT, more of the useful signal energy will be blanked whereas when it is above, less signal energy is blanked; this phenomena can also be extracted from the output SNR versus threshold value results obtained by the COB method in [21], [22] where it is obvious that the output SNR curves slope is higher (more sensitive to errors) in the region below the OBT than that of above the OBT.

It is also obvious that there is always more loss in the intermediate SINR region which clearly states that this region is the most sensitive to OBT misestimations. This is because of the fact that in this region, the IN values are slightly higher than the signal values and therefore any slight misestimation of the OBT will result in a significant change on the output SNR. On the other hand, however, it is interesting to note that for extremely low SINR values, the effect of the deviation from OBT on the output SNR becomes less serious especially for the positive errors.

IV. THE PROPOSED METHOD

The drawback of the COB method is its sensitivity to the short-term variations of IN which could lead to significant performance losses as illustrated in the previous section. Therefore,

$$T_{opt} = \sqrt{\frac{2(1 + \sigma_w^2)(1 + \sigma_w^2 + \sigma_i^2)}{\sigma_i^2} \ln \left(\left[\frac{1 + \sigma_w^2 + \sigma_i^2}{1 + \sigma_w^2} \right]^2 \frac{(1 - \sigma_w^2)}{(1 - \sigma_w^2 - \sigma_i^2)} \frac{(p - 1)}{p} \right)} \quad (16)$$

$$E[A_n^2] = 2(1 - p) \left[\sigma_w^2 (1 - \sigma_w^2) \left(\frac{T^2}{2(1 + \sigma_w^2)} + 1 \right) e^{-\frac{T^2}{2(1 + \sigma_w^2)}} \right] + 2p \left[(\sigma_w^2 + \sigma_i^2) + (1 - \sigma_w^2 - \sigma_i^2) \left(\frac{T^2}{2(1 + \sigma_w^2 + \sigma_i^2)} + 1 \right) e^{-\frac{T^2}{2(1 + \sigma_w^2 + \sigma_i^2)}} \right] \quad (18)$$

in this paper we propose to avoid relying on IN measurements and instead use estimates of the transmitted signals' peak to average power ratio. It is intuitive to think that there is a direct relationship between the OBT and the OFDM peak signal values as anything that exceeds the signal peak signifies unwanted noise or interference. To evaluate this relationship we conducted an extensive search for the OBT for signals with different PAPR values as presented in the flowchart in Fig. 4. The number of OFDM symbols considered in this investigation is ($n = 10^6$ symbols) with 256 subcarriers. An OFDM symbol is first generated $\{s^{(j)}\}$ and its peak value is calculated $Peak(j)$ before it is passed through the PLC channel where the noise vector $\{n^{(j)}\}$ is added to it to produce $\{r^{(j)}\}$. $\{s^{(j)}\}$, $\{n^{(j)}\}$ and $\{r^{(j)}\}$ are vectors each of length 256 and $j = 0, 1, \dots, n$. Blanking is applied on the j^{th} received symbol with blanking threshold T being varied from 0 to 10 using the index $\{t\}$ in step of 0.01 and the corresponding SNR (t) is determined. After that the blanking threshold $T(t)$ that maximizes the output SNR of the j^{th} OFDM symbol is assigned to $T_{opt}(j)$. This procedure is repeated for all the symbols and finally the vector T_{opt} is plotted versus the vector $Peak$ in Figs. 5 and 6 in the absence and presence of AWGN, respectively.

It is found that there exists a one-to-one linear relation between the signal peaks and the OBT. This implies that if the peak of every individual OFDM symbol can be determined accurately at the receiver, it will be possible to optimally blank IN on symbol by symbol basis without the need to know the IN characteristics. It is clear from these figures that the OBT is equal to the peak signal value. However, since it is practically infeasible to determine the exact peak for every single OFDM symbol at the receiver, the complementary cumulative distribution function (CCDF) should be used in practice. The CCDF of the PAPR of OFDM signal with N subcarriers denotes the probability that the PAPR of a data block exceeds a given threshold $PAPR_o$. This paper adopts a simple approximate expression derived, in [26], for the CCDF of the PAPR of a multicarrier signal with Nyquist rate sampling. This expression can be written in terms of peaks instead of PAPR as

$$CCDF = \Pr(peak > peak_o) = 1 - \left(1 - e^{(-peak_o)}\right)^N \quad (20)$$

A plot of (20) is shown in Fig. 7 for OFDM signals with 64, 256 and 1024 sub-carriers. Simulation results for CCDF are also obtained and it is clear that both the analytical and simulation

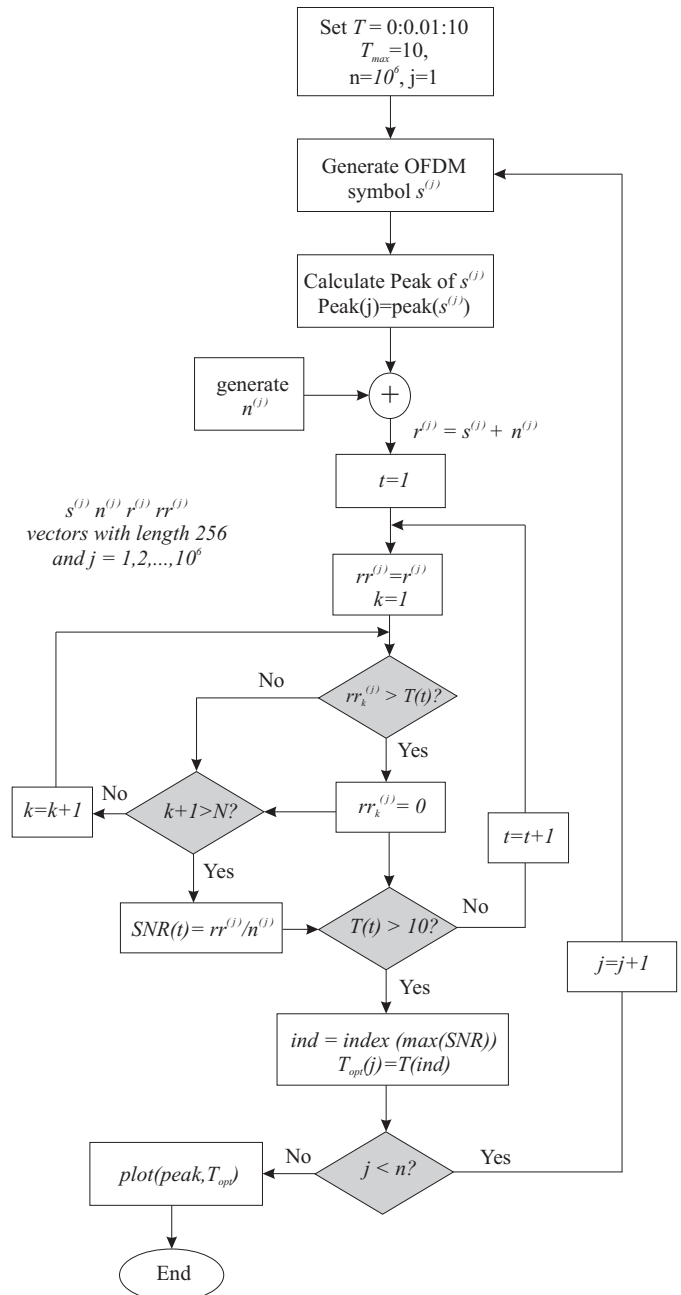

Fig. 4: The flowchart for finding the relationship between the OBT and signal peaks.

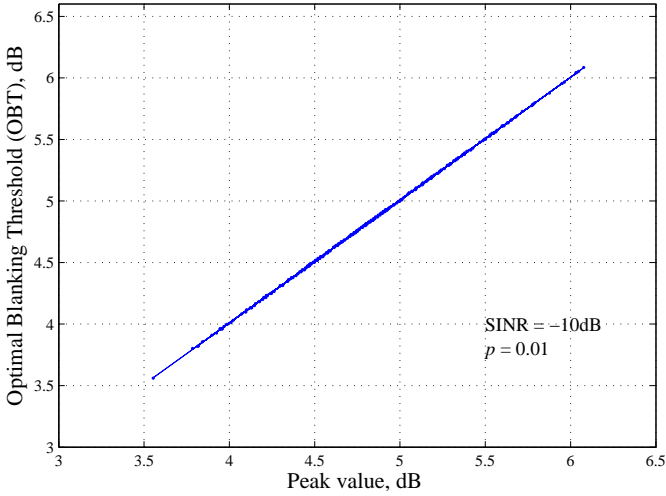

Fig. 5: The relationship between OBT and peaks of OFDM symbols in the absence of AWGN.

results are in a good agreement. While this expression is not precise on a symbol-by-symbol basis, it will be shown later that the average system performance will not be affected significantly.

Moreover, the proposed systems can be improved further if the signal is pre-processed at the transmitter to maintain the OFDM peaks below a certain threshold. A simple technique for doing this is to clip the OFDM signal before transmission, [27], as

$$\bar{s}_k = \begin{cases} s_k, & |s_k| \leq T_c \\ T_c e^{j \arg(s_k)}, & |s_k| > T_c \end{cases} \quad k = 0, 1, \dots, N-1 \quad (21)$$

where T_c is the clipping threshold. If T_c is too small most of the OFDM signal will be clipped whereas if it is too large no clipping will take place; therefore, an optimal clipping threshold exists as investigated in the next section.

V. SIMULATION RESULTS

In this section, computer simulations are conducted to analyze the gain in terms of SNR at the output of the blanker, in the presence of IN. These simulations are based on an OFDM system consisting of $N = 256$ subcarriers with 16QAM modulation. It is assumed that the transmitter and receiver are synchronized. The number of OFDM symbols considered in our study is 10^5 and the OFDM signal power is normalized to unity $\sigma_s^2 = (1/2) E[|s_k|^2] = 1$. The output SNR for the DPTE technique is defined as

$$\text{SNR}_{DPTE} = \frac{E[|s_k|^2]}{E[|y_k - s_k|^2]} \quad (22)$$

The noise is generated as in (10) and the noise variances are given as $\sigma_w^2 = (1/2) E[|w_k|^2]$ and $\sigma_i^2 = (1/2) E[|i_k|^2]$. Various IN probabilities are considered $p = 0.1, 0.03, 0.01$ and 0.003 which implies that 10%, 3%, 1% and 0.3% of the received OFDM samples will be affected by IN, respectively.

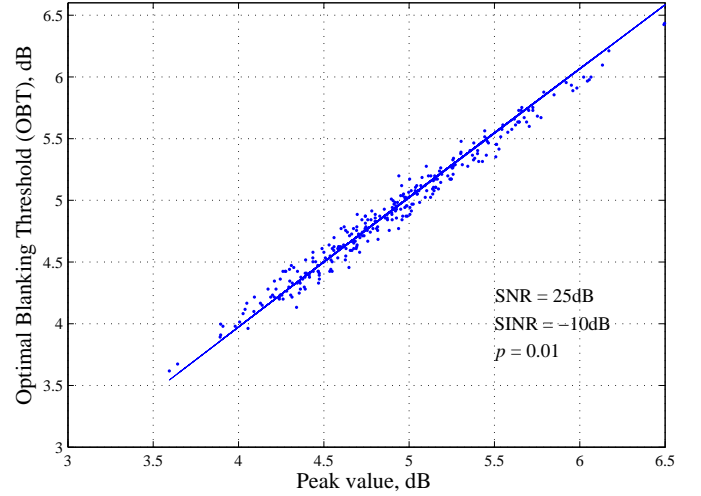

Fig. 6: The relationship between OBT and peaks of OFDM symbols in the presence of AWGN.

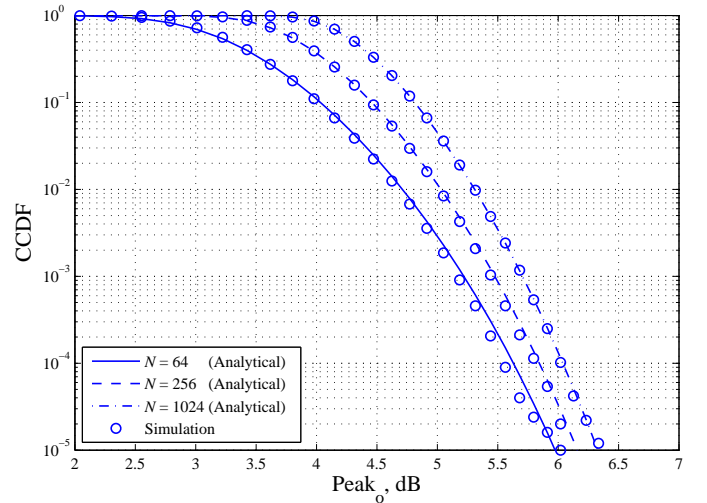

Fig. 7: Analytical and simulated results of CCDF for $N = 64, 256, 1024$.

Therefore, in this system with 256 subcarriers, the average number of IN pulses received within each OFDM symbol will be (pN) , i.e. about 26, 8, 3 and 1 IN pulses per OFDM symbol when $p = 0.1, 0.03, 0.01$ and 0.003 , respectively.

It is also worthwhile mentioning that the positions of IN pulses vary randomly within the OFDM symbols.

A. Gain Obtained by DPTE Technique Over COB Method

To establish the lower bound performance of this method we initially assume that the peak of each OFDM symbol is known accurately at the receiver. Under such assumption, Fig. 8 illustrates the output SNRs using both DPTE and COB methods for various probabilities p . It is clear that in case of COB method the simulation results closely match the analytical ones obtained from (17) and this verifies the accuracy of our simulation model. It is also observed that the DPTE method always outperforms the COB. This improvement increases as p decreases as clearly shown in Fig. 9. This gain is referred to as relative gain (G_R) and is expressed as

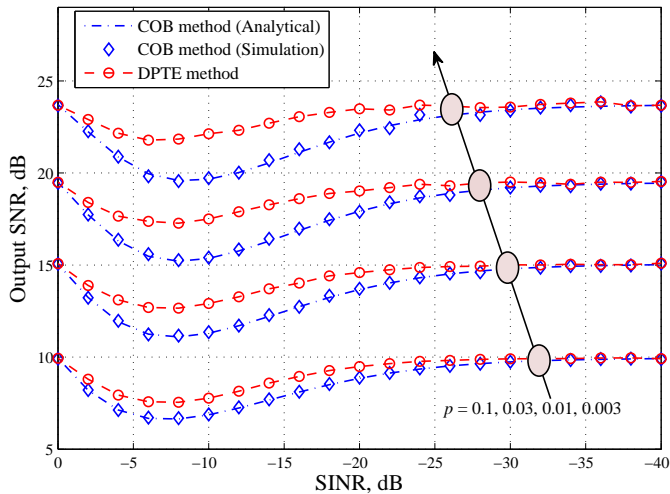

Fig. 8: Maximum achievable SNR of COB and DPTE methods at the output of the blanker versus SINR, SNR = 25dB.

$$G_R = 10 \log_{10} \left(\frac{\text{SNR}_{DPTE}}{\text{SNR}_{COB}} \right) \quad (23)$$

It is obvious that the highest G_R for all the probabilities p is always within the intermediate region of SINR. For instance, when $p = 0.003$, there is a gain of about 2.5dB over using COB scheme at SINR = -10dB and about 0.8dB of gain for high impulse probability $p = 0.1$ at the same SINR.

It is more appropriate to refer to the term 'relative gain' as relative loss when it is less than 0dB which is the case in the rest of this section. Fig. 10 depicts the relative loss in the output SNR due to the impracticality of using the exact OFDM symbol peaks and using the probabilistic model (20) instead for different blanking thresholds 5dB, 6dB, 7dB and 8dB. It is clear that the smallest loss occurs when the blanking threshold is 6dB where the loss is always less than 1dB for most the given impulse probabilities and this threshold corresponds to CCDF of 10^{-5} as illustrated in Fig. 7.

Although there is a loss of less than 1dB, this method is still very attractive as it is independent of the IN characteristics. On the other hand, the loss in COB method could be up to about 9dB for $p = 0.01$ if OBT was estimated wrongly by -35% as shown in Fig. 3. From Fig. 10, it is seen that the behavior of relative loss can be divided into two regions during which if the loss is high in one region in the other it is low and vice versa. These regions can be defined as intermediate SINR region from -5dB to -15dB and low SINR region from about -30dB to $-\infty$. To make this trade-off clearer, relative loss is plotted versus blanking threshold for intermediate and low SINR values as presented in Fig. 11a and Fig. 11b, respectively. From these figures, we can clearly see that the blanking threshold that gives the least loss, less than 1dB, in both regions for most impulse probabilities under study, is 6dB.

B. Gain obtained by DPTE Technique Over COB Method When Clipping is Employed at the Transmitter

DPTE technique can be improved by preprocessing (clipping) the signal at the transmitter to ensure that the PAPR

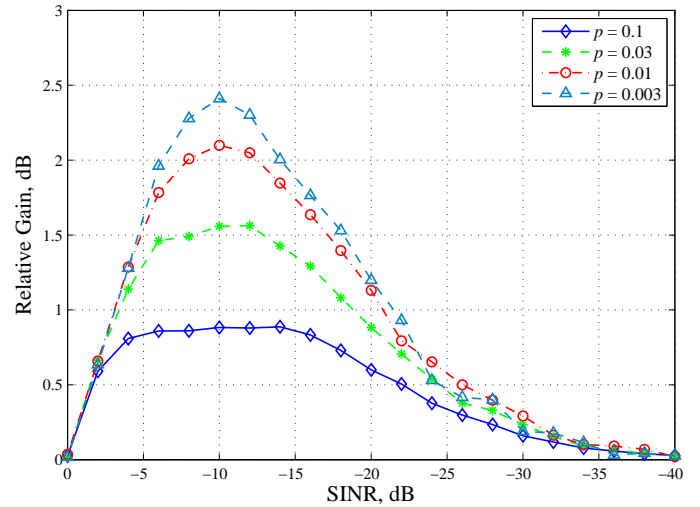

Fig. 9: The SNR gain of DPTE technique relative to COB method versus SINR, SNR = 25dB.

remains under a certain threshold level. It is important to point out that clipping threshold at the transmitter is used as blanking threshold at the receiver. Fig. 12 shows the gain of DPTE method over COB method when the OFDM signal is clipped at the transmitter for different clipping thresholds 5dB, 5.5dB, 6dB and 6.5dB. It can be seen that the optimal clipping threshold is 6dB. Furthermore, it is interesting to note that there is a gain of about 0.5dB in the intermediate SINR region for some impulse probabilities.

Similarly as in the previous section, we can see that there is a trade-off between the system behavior in the intermediate and low SINR regions. To make this clearer, the relative gain is plotted in Fig. 13 versus clipping threshold for an intermediate and a low SINR values. However, it is important to stress the fact that clipping the signal at the transmitter will add distortion and therefore, more appropriate PAPR reduction techniques should be used in practice to prevent any unwanted signal distortion.

VI. CONCLUSION

In this paper, we investigated the impact of estimation errors on the COB technique in terms of its effect on the output SNR of the blanking device. It was found that using this method may result in a dramatic degradation of SNR at the output of the blanker if the IN characteristics can not be accurately obtained at the receiver. Furthermore, this paper showed that there is a direct relationship between the peaks of OFDM symbols and OBT. It was also found that our proposed method is not only independent of IN measurements, but also can provide about 2.5dB if the peak of each OFDM symbol can be determined at the receiver. However, as it is not practical to know the exact OFDM symbol peaks, the CCDF is used instead and was found that there is still about 0.5dB improvement in the output SNR if some per-processing is performed at the transmitter side.

REFERENCES

- [1] T. Esmailian, F. R. Kschischang, and P. G. Gulak, "An in-building power line channel simulator," *Proc. of the International Symposium on Power Line Communication and its Applications*, pp. 2-3, 2002.

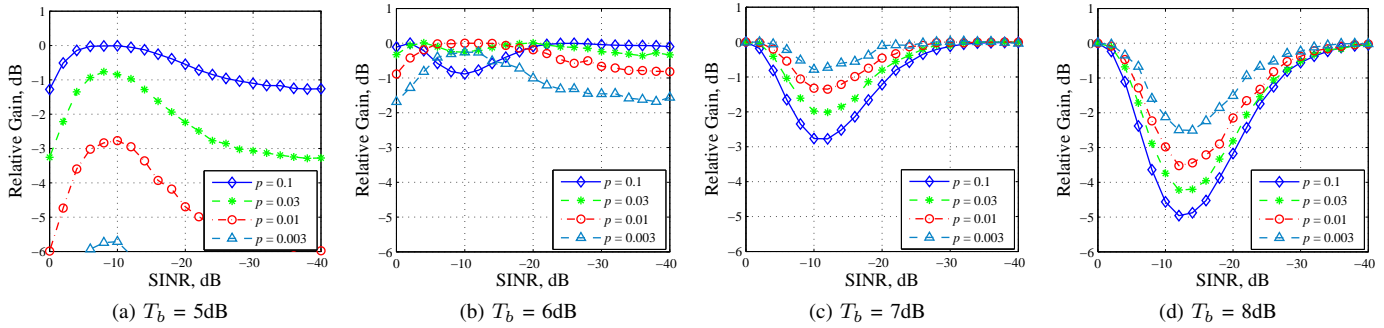

Fig. 10: The SNR loss relative to COB method versus SINR for different blanking thresholds (16QAM-OFDM), SNR = 25dB.

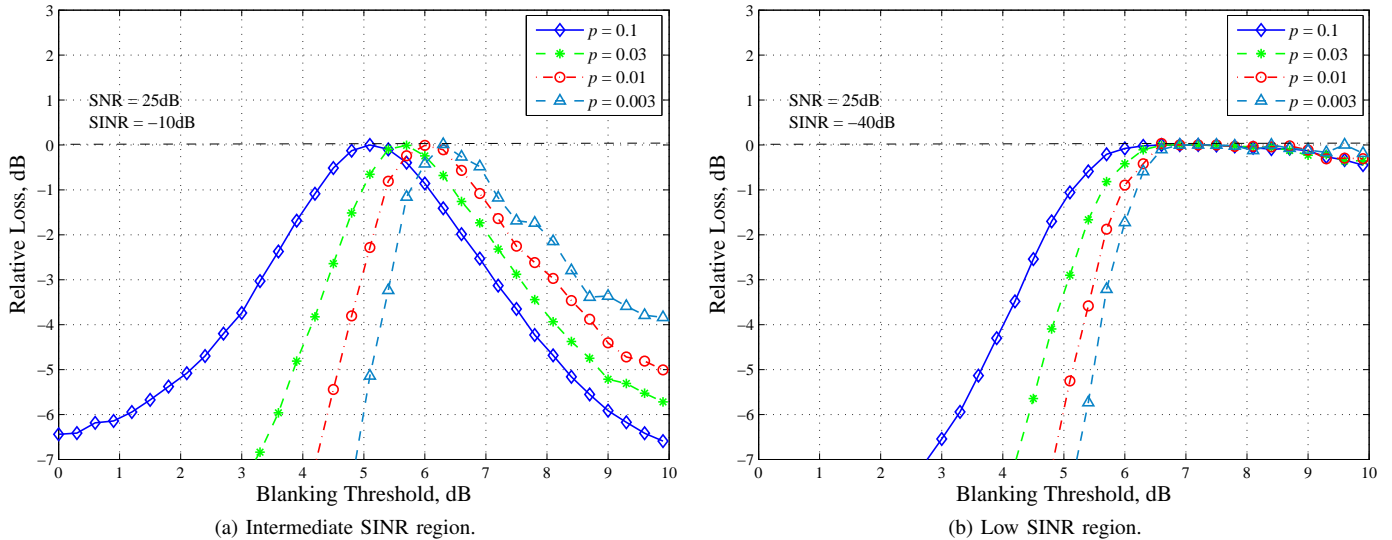

Fig. 11: The SNR loss relative to COB method versus blanking threshold for different values of SINR (16QAM-OFDM)

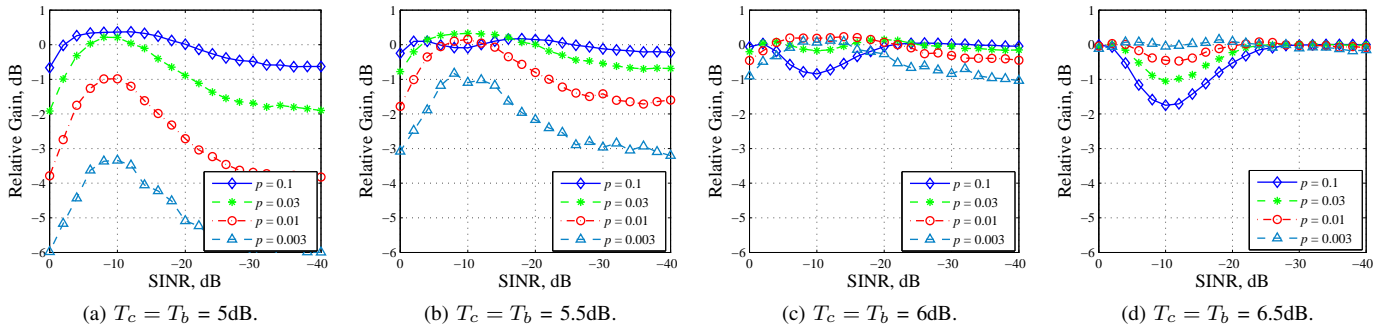
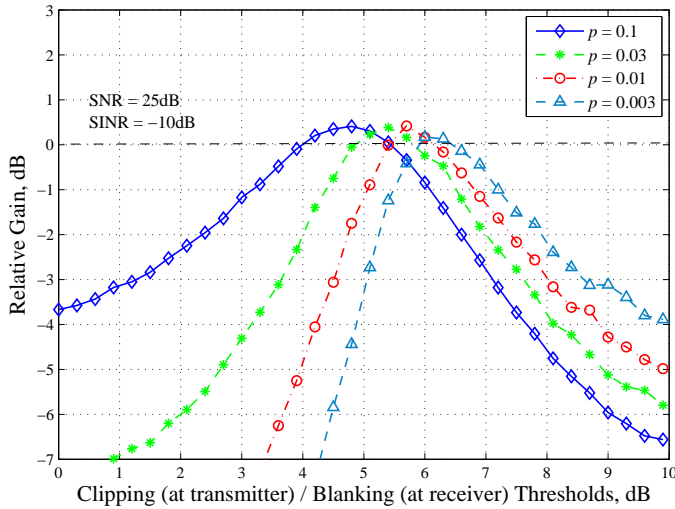
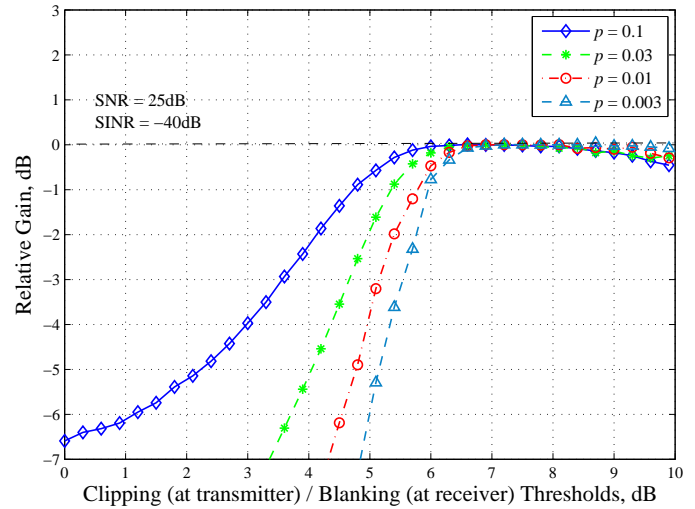

Fig. 12: The SNR gain relative to COB method versus SINR for different clipping / blanking thresholds (16QAM-OFDM), SNR = 25dB.

- [2] H. Meng, Y. L. Guan, and S. Chen, "Modeling and analysis of noise effects on broadband power-line communications," *IEEE Trans. Power Del.*, vol. 20, no. 2, pp. 630–637, Apr. 2005.
- [3] D. Anastasiadou and T. Antonakopoulos, "Multipath characterization of indoor power-line networks," *IEEE Trans. Power Del.*, vol. 20, no. 1, pp. 90–99, Jan. 2005.
- [4] P. Cuntic and A. Bazant, "Analysis of modulation methods for data communications over the low-voltage grid," in *Proc. of the 7th Int. Conference on Telecommunications, 2003. ConTEL 2003*, vol. 2, Jun. 2003, pp. 643 – 648.
- [5] H. Philipps, "Development of a statistical model for powerline communication channels," in *IEEE International Symposium on Power Line Communications and its Applications, ISPLC'00*, Limerick, Ireland, Apr. 2000, pp. 153–160.
- [6] M. Zimmermann and K. Dostert, "Analysis and modeling of impulsive noise in broad-band powerline communications," *IEEE Trans. Electromagn. Compat.*, vol. 44, pp. 249–258, Feb. 2002.
- [7] D. Middleton, "Canonical and quasi-canonical probability models of class A interference," *IEEE Trans. Electromagn. Compat.*, vol. EMC-25, pp. 76–106, May 1983.
- [8] —, "Non-gaussian noise models in signal processing for telecommunications: new methods and results for class A and class B noise models," *IEEE Trans. Inform. Theory*, vol. 45, no. 4, pp. 1129–1149, May 1999.
- [9] M. G. Sanchez, L. de Haro, M. C. Ramon, A. Mansilla, C. M. Ortega, and D. Oliver, "Impulsive noise measurements and characterization in a UHF digital TV channel," *IEEE Trans. Electromagn. Compat.*, vol. 41, no. 2, pp. 124–136, May 1999.
- [10] D. Middleton, "Statistical-physical models of electromagnetic interfer-



(a) Low SINR region.



(b) Intermediate SINR region.

Fig. 13: The SNR gain relative to COB method versus blanking / clipping thresholds for different values of SINR (16QAM-OFDM)

- ence," *IEEE Trans. Electromagn. Compat.*, vol. EMC-19, no. 3, pp. 106–127, Aug. 1977.
- [11] J. A. C. Bingham, "Multicarrier modulation for data transmission: An idea whose time has come," *IEEE Commun. Mag.*, vol. 28, no. 5, pp. 5–14, May 1990.
- [12] E. Del Re, R. Fantacci, S. Morosi, and R. Seravalle, "Comparison of CDMA and OFDM techniques for downstream power-line communications on low voltage grid," *IEEE Trans. Power Del.*, vol. 18, no. 4, pp. 1104–1109, Oct. 2003.
- [13] M. Ghosh, "Analysis of the effect of impulse noise on multicarrier and single carrier QAM systems," *IEEE Trans. Commun.*, vol. 44, no. 2, pp. 145–147, Feb. 1996.
- [14] J. Haring and A. J. H. Vinck, "Iterative decoding of codes over complex numbers for impulsive noise channels," *IEEE Trans. Inf. Theory*, vol. 49, no. 5, pp. 1251–1260, May 2003.
- [15] S. V. Zhidkov, "Impulsive noise suppression in OFDM-based communication systems," *IEEE Trans. Consum. Electron.*, vol. 49, no. 4, pp. 944–948, Nov. 2003.
- [16] O. P. H. et al., "Detection and removal of clipping in multicarrier receivers," *European patent application EP1043874*, Oct. 2011.
- [17] N. P. Cowley, A. Payne, and M. Dawkins, "COFDM tuner with impulse noise reduction," *Eur. Patent Application EP1180851*, Feb. 2002.
- [18] K. S. Vastola, "Threshold detection in narrow-band non-gaussian noise," *IEEE Trans. Commun.*, vol. COM-32, no. 2, pp. 134–139, Feb. 1984.
- [19] R. Ingram, "Performance of the locally optimum threshold receiver and several suboptimal nonlinear receivers for ELF noise," *IEEE J. Ocean. Eng.*, vol. 9, no. 3, pp. 202–208, Jul. 1984.
- [20] A. D. Spaulding, "Locally optimum and suboptimum detector performance in a non-gaussian interference environment," *IEEE Trans. Commun.*, vol. COM-33, pp. 509–517, Jun. 1985.
- [21] S. V. Zhidkov, "On the analysis of OFDM receiver with blanking nonlinearity in impulsive noise channels," *Intelligent Signal Processing and Communication Systems, 2004. ISPACS 2004. Proceedings of 2004 International Symposium on*, pp. 492–496, Nov. 2004.
- [22] —, "Performance analysis and optimization of OFDM receiver with blanking nonlinearity in impulsive noise environment," *IEEE Trans. Veh. Technol.*, vol. 55, no. 1, pp. 234–242, Jan. 2006.
- [23] G. Ndo, P. Siohan, and M. Hamon, "Adaptive noise mitigation in impulsive environment: Application to power-line communications," *IEEE Trans. Power Del.*, vol. 25, no. 2, pp. 647–656, 2010.
- [24] H. Nguyen and T. Bui, "Bit-interleaved coded modulation with iterative decoding in impulsive noise," *IEEE Trans. Power Del.*, vol. 22, no. 1, pp. 151–160, 2007.
- [25] P. Amirshahi, S. Navidpour, and M. Kavehrad, "Performance analysis of uncoded and coded ofdm broadband transmission over low voltage power-

- line channels with impulsive noise," *IEEE Trans. Power Del.*, vol. 21, no. 4, pp. 1927–1934, 2006.
- [26] R. van Nee and R. Prasad, "OFDM for wireless multimedia communications," *Artech House*, 2000.
- [27] R. O'Neill and L. B. Lopes, "Envelope variations and spectral splatter in clipped multicarrier signals," in *Proc. PIMRC*, vol. 1, Toronto, Canada, Sept. 1995, pp. 71–75.



Emad Alsusa (M'06-SM'07) received a Ph.D. degree in electrical and electronic engineering from Bath University, Bath in 2000. Following his PhD he joined the School of Engineering and Electronics at Edinburgh University as a MobileVCE Postdoctoral Research Fellow, working on industrially led projects on link enhancement techniques for future high data rate wireless communication systems. In 2003, he joined the University of Manchester as an academic member of the school of Electrical and Electronic Engineering, where he lectures on communication engineering subjects. His research interests include signal processing and analysis of wireless communication networks, with particular focus on modulation and multiple access, channel estimation, coding, interference mitigation, multiuser detection, MIMO techniques and spectrum sensing techniques for cognitive radio applications. He served as a technical program committee member on numerous IEEE flagship conferences and chaired the Manchester EEE postgraduate conference in 2010.



Khaled M. Rabie (S'12) received the B.Sc. degree in electrical and electronic engineering from the University of Tripoli, Tripoli, Libya, in 2008. He then received the M.Sc. degree (with Distinction) in communication engineering from the University of Manchester, Manchester, UK, in 2010. He is currently pursuing a Ph.D degree with the microwave and communications systems (MACS) group of the University of Manchester. His current research interests lie in the field of powerline communications including powerline channel modeling, interference and impulsive noise mitigation for smart grid applications as well as MIMO systems.