

NASA TECHNICAL NOTE

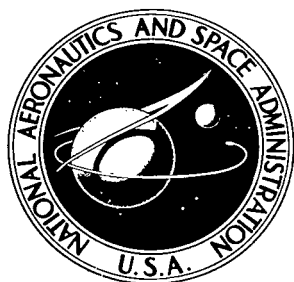

NASA TN D-5131

c. 1

NASA TN D-5131



**LOAN COPY: RETURN TO
AFWL (WLIL-2)
KIRTLAND AFB, N MEX**

EFFECT OF ULTRASONIC VIBRATION ON PRECIPITATION HARDENING OF STEELS AND SUPERALLOYS

by Stanley G. Young and L. Leonard

Lewis Research Center

Cleveland, Ohio

ERRATA

NASA Technical Note D-5131

EFFECT OF ULTRASONIC VIBRATION ON PRECIPITATION

HARDENING OF STEELS AND SUPERALLOYS

by Stanley G. Young and L. Leonard

March 1969

*Completed
30 July 69 SW*

The following references should be added at the end of the report:

15. Decker, R. F.; Eash, J. T.; and Goldman, A. J.: 18% Nickel Maraging Steel. Trans. ASM, vol. 55, no. 1, Mar. 1962, pp. 58-76.
16. Contractor, G. P.: The Marvel of Maraging. J. Metals, vol. 18, no. 8, Aug. 1966, pp. 938-946.
17. Anon.: Precipitation Hardenable Stainless Steels. Bull. 1223R4 75 C 1262, Republic Steel Corp., 1962.
18. Anon.: Haynes Alloy No. R-41. Haynes Stellite Bull. No. F-30, 155 B, Union Carbide Stellite Co., Apr. 1963.
19. Sandrock, Gary D.; and Leonard, L.: Cold Reduction as a Means of Reducing Embrittlement of a Cobalt-Base Alloy (L-605). NASA TN D-3528, 1966.
20. Young, Stanley G.; and Johnston, James R.: Accelerated Cavitation Damage of Steels and Superalloys in Liquid Metals. NASA TN D-3426, 1966.
21. Smith, Jack L.: Use of Phase-Locked-Loop Control for Driving Ultrasonic Transducers. NASA TN D-3567, 1966.
22. Neppiras, E. A.: Techniques and Equipment for Fatigue Testing at Very High Frequencies. Proc. ASTM, vol. 59, 1959, pp. 691-710.
23. Thiruvengadam, A.: High Frequency Fatigue of Metals and their Cavitation Damage Resistance. Rep. TR-233-6, Hydronautics, Inc., Dec. 1964. (Available from DDC as AD-456365.)
24. Zemskov, G. V.; Dombrovskaya, E. V.; Yarkina, V. T.; Gushchin, L. K.; and Parfenov, A. K.: Nitriding of Steel Intensified by Ultrasound. Henry Brucher Translation no. 6183, 1964.

25. Anon. : Vasxomax 300 CVM. Data Sheet 2000-1-62 FL, Vanadium-Alloy Steels Co. , 1962.
26. Anon. : Haynes Alloy No. 25. Haynes Stellite Bull. F30-041D, Union Carbide Stellite Co. , Feb. 1967.



EFFECT OF ULTRASONIC VIBRATION ON PRECIPITATION
HARDENING OF STEELS AND SUPERALLOYS

By Stanley G. Young and L. Leonard

Lewis Research Center
Cleveland, Ohio

NATIONAL AERONAUTICS AND SPACE ADMINISTRATION

For sale by the Clearinghouse for Federal Scientific and Technical Information
Springfield, Virginia 22151 - CFSTI price \$3.00

ABSTRACT

Specimens of a 300 grade maraging steel, 17-4 PH steel, A-286, René 41, and L-605 were subjected to ultrasonic vibration during aging. Ultrasonic vibration increased the hardening rate but did not increase the maximum hardness above that of statically aged specimens. The heat treating environment (which included sodium, chloride salts, and air) was found to influence the observed hardening rates of vibrated aged specimens.

EFFECT OF ULTRASONIC VIBRATION ON PRECIPITATION HARDENING OF STEELS AND SUPERALLOYS

by Stanley G. Young and L. Leonard*

Lewis Research Center

SUMMARY

Effects of ultrasonic vibration on the precipitation hardening of a 300 grade maraging steel, 17-4 PH steel, A-286, René 41, and L-605, were studied. A magnetostrictive vibrator was coupled directly to specimens of these alloys and they were vibrated at their natural resonant frequency while undergoing standard aging heat treatments.

Specimen peak-to-peak vibration displacements ranged from 0.8 to 6.4 mils (2.0×10^{-2} to 16.3×10^{-2} mm) at a frequency of 25 000 hertz. Material properties were compared with those of nonvibrated specimens given similar aging treatments.

Application of ultrasonic vibration resulted in some increase in the hardening rate for most of the alloys tested; however, the maximum hardness obtained by ultrasonic vibration did not exceed that obtainable by statically aging any of the alloys. The tensile and yield strengths of vibrated specimens of the 300 grade maraging steel increased by approximately 1 and 2 percent above their values in the static aged condition at the recommended aging temperatures and times. Stress level did not consistently or appreciably affect the aging results.

Metallographic examination of precipitates in vibrated L-605 specimens showed no differences from the precipitate distribution in statically aged specimens.

The observed increase in hardening rate due to vibration was less than that reported by previous investigators. It is believed that the heat-treating environments used in the earlier investigations permitted the vibrated specimens to reach temperatures in excess of the desired heat-treating temperature and that is the most likely cause of the increased hardening rates reported previously.

*Assistant Professor, Department of Metallurgy, Case Western Reserve University, Cleveland, Ohio.

INTRODUCTION

In alloy systems in which the solid solubility decreases with decreasing temperature, the precipitation of a second phase from a solid solution can be accompanied by a marked change in mechanical properties. In some alloys the hardness and strength decrease during precipitation but in certain (age hardening) alloys there is a substantial increase in hardness and strength. The subject is extensively covered in references 1 to 4.

Because precipitation is dependent to a large extent on diffusion, temperature is very important in determining the rate and amount of precipitation hardening. If the temperature is very high, precipitate growth is rapid and alloys overage quickly. If the temperature is low, diffusion is slow and longer aging times are required. Most alloy systems, however, have shown higher peaks in mechanical properties when aged at low temperatures for very long times (ref. 3). Alloy heat treatments usually are compromises between aging time and temperature to achieve a high hardness in a reasonably short time. Any process that can shorten the time of aging and yet provide optimum mechanical properties would obviously be of great value. The application of ultrasonic vibration to alloys during the aging treatment has been found by some (refs. 5 to 9) to be such a process; however, widely differing results have been reported. Some investigators found that the application of ultrasonic energy to aluminum base alloys increased the rate of hardening by a factor of 12 to 80 times that observed in an ordinary static aging procedure (refs. 5 and 6). Others have shown a 20 fold increase in the rate of hardening of a nickel base alloy (ref. 7). Still others found only slight increases in the rate of hardening for aluminum alloys (ref. 8) and a beryllium-bronze alloy (ref. 9). Also, different maximum hardness values have been reported for vibrated specimens as compared to statically aged specimens. Thus, higher, similar, and even lower hardness peaks have been reported for vibrated specimens than for statically aged specimens (refs. 5, 8, 10, and 11). It should be noted, however, that the alloys and types of equipment used varied among these investigations and this could account for the large differences in the reported effects of ultrasonic vibration. In general, most previous investigators found that ultrasonic vibration applied during the aging of materials increased the aging rate and improved the mechanical properties of alloys. These improvements can be attributed to lattice stretching and increased diffusion (refs. 5 and 11 to 14).

The purposes of this investigation were: (1) to apply ultrasonic vibration during the aging of certain steels and superalloys, in order to determine if their hardening and strengthening responses were influenced by vibration, and (2) to attempt to explain the wide differences in results reported by various investigators. A magnetostrictive apparatus was used to vibrate specimens at a frequency of 25 000 hertz while they were being subjected to age hardening heat treatments. The materials studied were a 300 grade maraging steel, 17-4 PH steel, A-286, René 41, and L-605. Heat treating temperatures

were in the range of the manufacturer's recommended optimum aging temperatures for each material. The effects of vibration on hardness, tensile properties, and distribution of precipitates within the structure, were determined for specific alloys. The effect of heat treating environments was also considered. In all cases, results obtained from statically aged control specimens were compared with results obtained with vibrated specimens.

MATERIALS, APPARATUS, AND PROCEDURE

Materials

Specimens. - The materials investigated were the iron-base alloys, 300 grade maraging steel, 17-4 PH steel, and A-286; the nickel-base alloy René 41; and the cobalt-base alloy L-605. The nominal chemical composition of each alloy is listed in table I. The recommended heat treatments and nominal mechanical properties of these alloys are listed in table II.

The 300 grade maraging steel has demonstrated a very wide range in degree of age hardening (refs. 15 and 16). The hardness of this alloy can increase on aging from approximately Rockwell C 30 to 50 or higher. 17-4 PH steel is a martensitic precipitation hardening steel and A-286 a highly alloyed precipitation hardenable iron-base material with an austenitic structure (ref. 17). René 41 is a precipitation hardening nickel-base alloy that has high strength at temperatures in the range of 1200^o to 1800^o F (922 to 1255 K) (ref. 18). L-605 is a cobalt-base alloy and was included because the precipitate in this alloy can normally be seen by optical microscopy after relatively short aging times (ref. 19) and was, therefore, considered to be particularly useful for metallographic study.

Heat treating environments. - Three different environments were used for heat treatment of the alloy specimens both statically and while they were subjected to ultrasonic vibration: a sodium bath, a commercial chloride salt bath, and air.

The sodium bath was used to heat treat the 300 grade maraging and 17-4 PH steels in the temperature range of 800^o to 1000^o F (700 to 811 K). Sodium was selected as a heat-treating solution because a facility for handling liquid alkali metals was available and because of its desirable properties compared to other media. Lead, which has been used as a heat-treating medium by other investigators, has a high density which would significantly dampen the vibration of the ultrasonically treated specimens. Sodium with a density of only 0.97 gram per cubic centimeter was much more advantageous in this respect. The high heat conductivity of sodium also helped to reduce local temperature gradients that resulted from specimen vibration.

TABLE I. - NOMINAL COMPOSITIONS OF ALLOYS TESTED, WEIGHT PERCENT

Material	Iron	Nickel	Cobalt	Chromium	Molybdenum	Tungsten	Titanium	Aluminum	Boron	Carbon	Silicon	Manganese	Sulfur	Phosphorus	Other
300 Grade maraging steel ^a	Balance	18.5	9.0	----	4.8	--	0.60	0.10	0.003	^b 0.03	^b 0.10	^b 0.10	^b 0.010	^b 0.010	0.2 Zr .05 Ca
17-4 PH steel ^c	Balance	4	----	16.5	----	--	----	----	----	^b .07	^b 1.0	^b 1.0	^b .03	^b .04	^b .04 Cu ^b .04 N .3 Cb + Ta
A-286 ^c	Balance	25.5	----	15.0	1.25	--	2.15	^b .35	.006	^b .08	.7	1.5	^b .03	^b .04	.3 Va
René 41 ^d	^b 5	Balance	11	19	9.75	--	3.15	1.5	.007	^b .12	^b .5	^b .10	^b .015	-----	-----
L-605 (HS-25) ^e	^b 3	10	Balance	20	----	15	----	----	----	.10	^b 1.0	1.5	^b .030	^b .030	-----

^aRef. 25.^bMaximum.^cRef. 17.^dRef. 18.^eRef. 26.

TABLE II. - RECOMMENDED HEAT TREATMENTS AND NOMINAL MECHANICAL

PROPERTIES OF ALLOYS AT ROOM TEMPERATURE

Material	Heat treatment as received	Aging		Nominal mechanical properties							
		Temperature, °F (K)	Time, hr	Condition	Hardness	Yield strength (0.2 percent)		Tensile strength		Elonga- tion, percent	Reduc- tion in area, percent
						psi	N/m ²	psi	N/m ²		
300 Grade maraging steel ^a	Solution annealed at 1475 ^o to 1525 ^o F (1074 to 1102 K) for 1 hour, air cool	875 to 925 (741 to 769), air cool	3 to 6	Annealed (as received)	RC-31	110 000	7.6×10 ⁸	150 000	1.03×10 ⁹	18	72
				Aged	RC-54.3	283 000	1.95×10 ⁹	294 000	2.03×10 ⁹	12	55
17-4 PH steel ^b	Solution annealed at 1900 ^o F (1311 K), air cool	900 (755), air cool	1	Annealed (as received)	BHN 332 (RC-36)	110 000	7.6×10 ⁸	150 000	1.03×10 ⁹	10	45
				Aged	RC-44	170 000	1.17×10 ⁹	190 000	1.31×10 ⁹	10	40
A-286 ^b	Solution annealed at 1800 ^o F (1255 K) for 1 hour, water/oil quench	1300 (977), air cool	16	Annealed (as received)	RB-75	36 000	2.48×10 ⁸	93 000	6.41×10 ⁸	48	70
				Aged	RC-29	100 000	6.9×10 ⁸	145 000	1.0×10 ⁹	24	37
René 41 ^c	Solution annealed at 1950 ^o F (1339 K) for 4 hours, air cool	1400 (1033), air cool	16	Annealed (as received)	^d RC-21	90 000	6.2×10 ⁸	-----	-----	--	--
				Aged	^d RC-40	154 000	1.06×10 ⁹	206 000	1.42×10 ⁹	14	--
L-605 (HS-25) ^e	Solution annealed at 2250 ^o to 2265 ^o F (1505 to 1513 K), water quench	(f)	(f)	Annealed (as received)	RC-24	70 000	4.82×10 ⁸	150 000	1.03×10 ⁹	65.0	--

^aRef. 25.^bRef. 17.^cRef. 18.^dMeasured on round specimen.^eRef. 26.^fGenerally used in the annealed condition.

A commercial chloride salt bath was used to heat treat A-286, René 41, and L-605 in the temperature range from 1300^o to 1600^o F (978 to 1144 K). The melting point of the salt bath was approximately 1100^o F (856 K). The chloride salt bath was chosen for the high temperature aging studies because it is relatively inert, nontoxic and has a wide temperature range between melting and boiling.

Finally, air was used as the heat-treating medium for the 300 grade maraging steel at 800^o F (700 K). The air test was conducted to determine the differences in aging response that could result from applying ultrasonic vibration to a specimen in an environment with relatively low heat transfer properties. A gas environment has previously been used by other investigators (refs. 6 and 7).

Apparatus

A photograph of the facility used is shown in figure 1. This facility was originally constructed to investigate cavitation damage of materials in liquid metal environments (ref. 20). The photograph shows the vacuum dry box and associated electronics and control equipment.

A schematic diagram of the magnetostrictive vibration apparatus and heat treating test chamber is shown in figure 2. The dry box and test chamber were designed to be evacuated to a pressure of approximately 10⁻³ torr (0.13 N/m²). When sodium was used as the heat treating medium, the dry box was filled with high purity argon to prevent oxidation of the sodium. When chloride salt was used as the heat-treating solution, air was used as the cover gas. Glove ports were provided on the dry box to enable the operator to work within the argon atmosphere.

A schematic diagram of the transducer assembly is shown in figure 3. The specimen was attached to the end of the resonant system consisting of the transducer and amplifying horn. The transducer was a commercial unit modified for use within the vacuum dry box. The horn served as a displacement amplifier and provided a convenient attachment for a nodal flange vapor seal. All of the components of this system were designed so that at the test frequency the length of each part was a multiple of one-half the wavelength. This design makes it possible for the entire system to vibrate as a standing wave of the resonant frequency.

The displacement and frequency of vibration were detected by a magnetic pickup indicated in figure 2. A sine wave signal was sent from the pickup to an oscilloscope and to an automatic feedback system that maintained a constant displacement irrespective of variations in the resonant frequency induced by temperature changes. The electronic drive feedback system is described in reference 21. A schematic diagram of the control system is shown in figure 4.

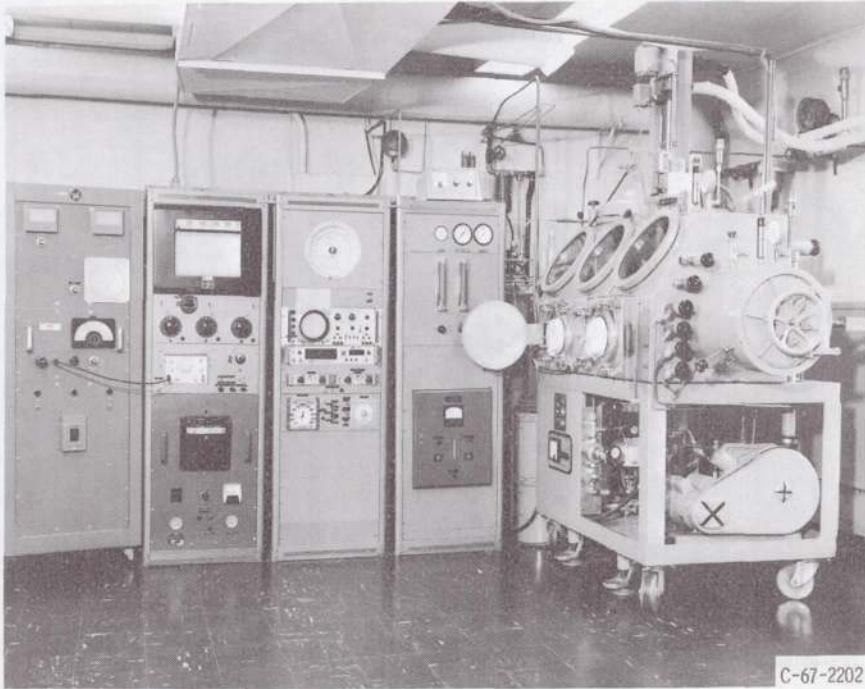

C-67-2202

Figure 1. - Ultrasonic vibration heat treating facility.

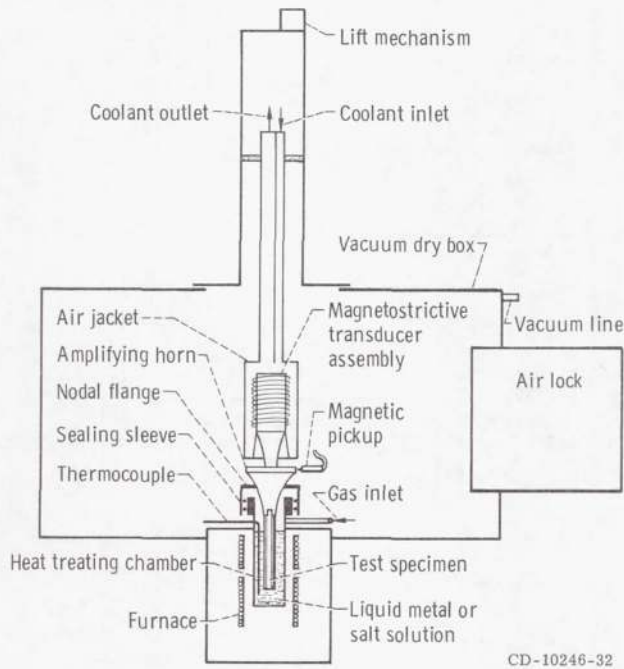

CD-10246-32

Figure 2. - Schematic diagram of magnetostrictive vibration apparatus and heat treating test chamber.

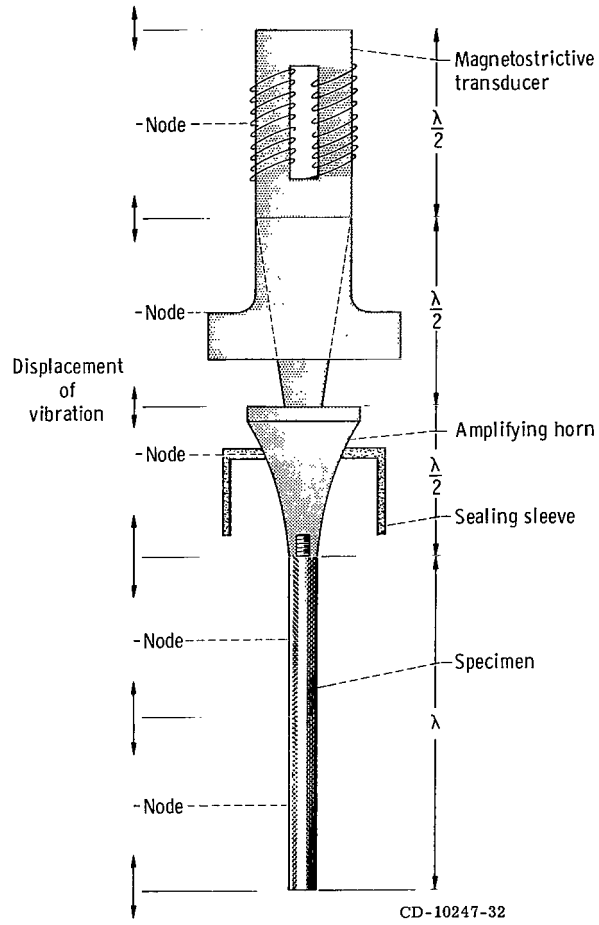

Figure 3. - Schematic diagram of transducer assembly.

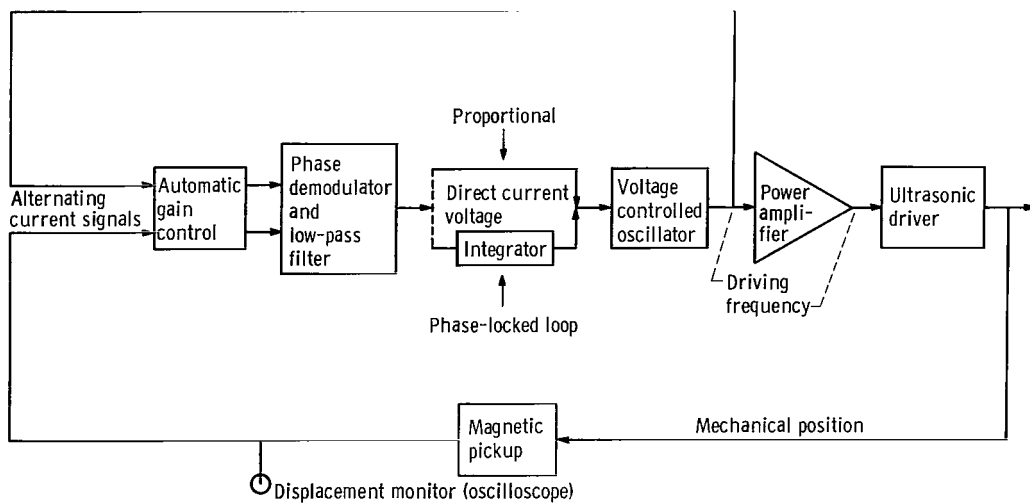

Figure 4. - Block diagram of proportional and phase-locked-loop control systems.

The sine wave signal viewed on the oscilloscope was calibrated against optical measurements of the specimen displacement. A 200-power microscope with a split-image measuring eyepiece was used. The accuracy of measurement with this eyepiece was ± 0.00002 inch (5.1×10^{-4} mm).

Figure 5 is a schematic drawing of the relative positions of the heater, test chamber, heat-treating liquid, specimen, and thermocouples. Temperature profiles were taken both in the liquid baths and on the surface of statically aged specimens at all aging temperatures. These will be discussed in the section dealing with test conditions. The experimental setup for static aging in air is shown in figure 6. This photograph shows the 3-zone resistance-heater furnace and a thermocoupled specimen used to measure the temperature gradients.

Thermocoupled specimens could not be used during any of the vibration tests because the thermocouples did not remain intact or in place while the specimen was vibrated. Under these circumstances only the furnace environment temperature was measured. An optical pyrometer was used to determine the temperature rise in a specimen due to vibration when it was vibrated in air without the surrounding furnace.

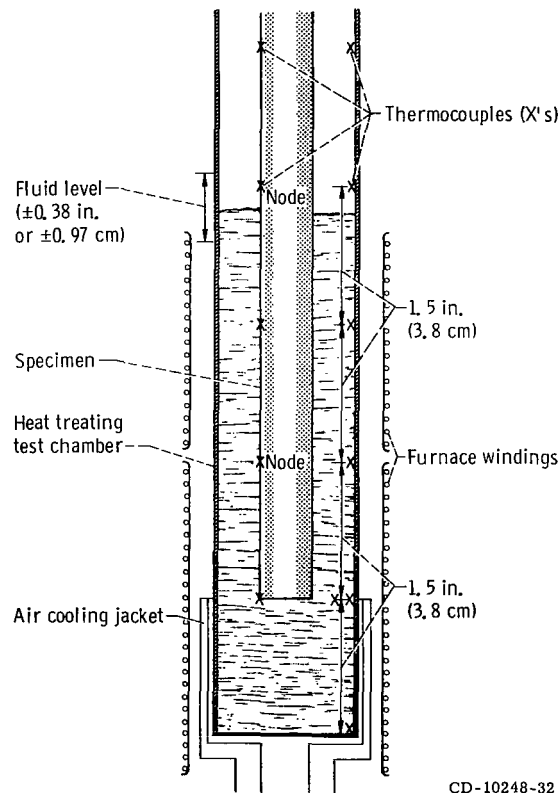

Figure 5. - Schematic diagram showing relative positions of test components, specimen, and thermocouples.

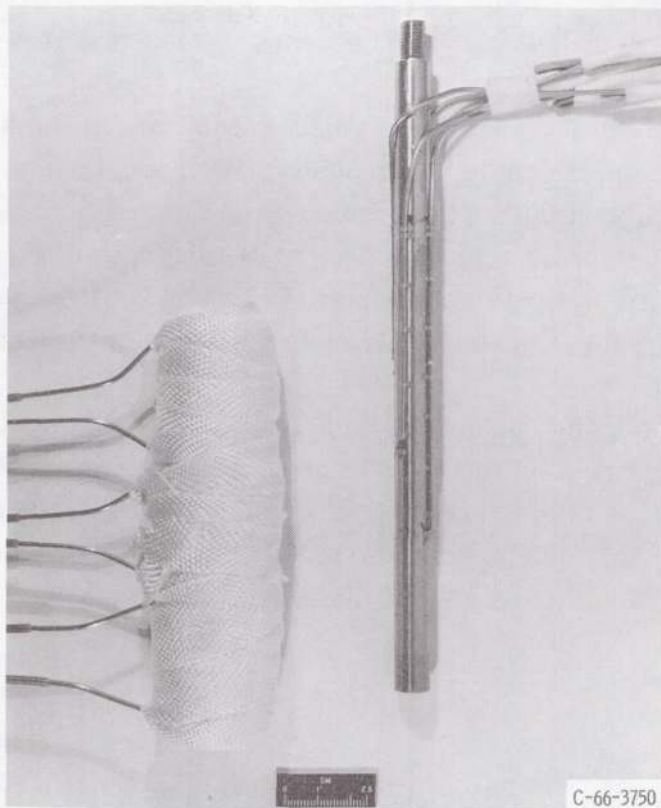

Figure 6. - Relative vertical positions three-zone heat treating furnace and thermocoupled straight bar specimen used for air environment aging tests.

Specimen Design

Two types of specimens shown in figure 7 were used - a straight bar and a tapered specimen. The bulk of tests were conducted with the straight bar specimen shown in figure 7(a). This specimen was designed so that at 25 000 hertz a standing ultrasonic wave was maintained during the test. The length of each straight bar specimen was determined by the wave length of the 25 000 hertz wave in each specific material. A sample calculation of the wavelength of the 25 000 hertz wave in 300 grade maraging steel is given in appendix A.

An idealized example of the displacement, stress, and strain relations for a straight bar specimen is shown in figure 8. In the portions of the standing longitudinal wave where the vibration is maximum, the strain and corresponding stress are minimum. Where the displacement is minimum (at the nodes) the stress and strain are maximum. The equations for stress and strain based on displacement and distance from the node are given in appendix B. A sample calculation of stress and strain for a straight bar 300

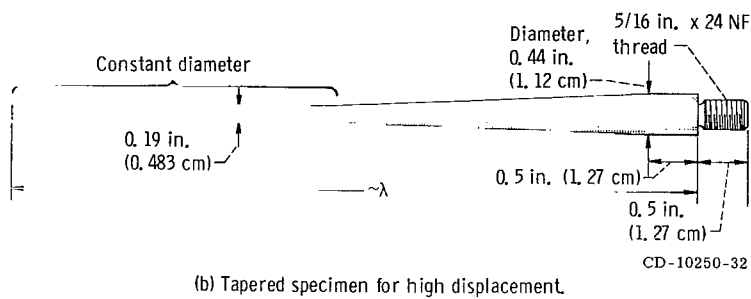
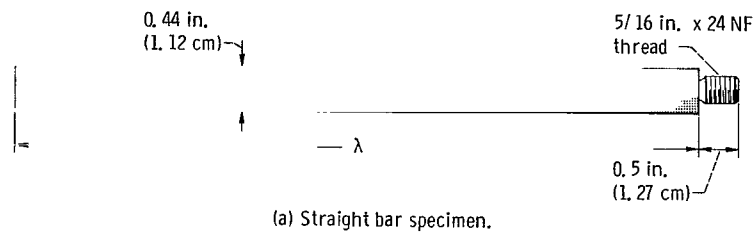

Figure 7. - Specimen designs used for ultrasonic vibration aging studies.

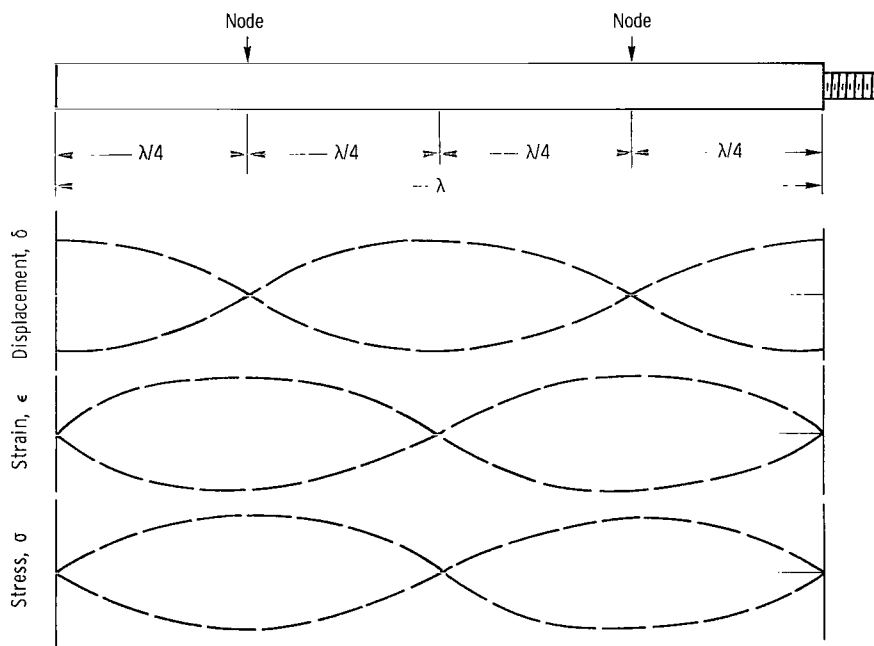

Figure 8. - Specimen displacement, stress, and strain profiles.

TABLE III. - TEST CONDITIONS

Material	Temperature		Displacement		Stress (max)		Test times, min	
	°F	K	mils	mm	psi	N/m ²		
300 Grade maraging steel	800	700	0	0	0	0	15, 60, 180, 360	
			2.0	.051	22 500	1.55×10 ⁸	15, 60, 180, 360	
			3.0	.076	33 800	2.33×10 ⁸	15, 30	
	900	755	0	0	0	0	5, 60, 240, 360	
			2.0	.051	22 500	1.55×10 ⁸	5, 60, 240, 360	
			0	0	0	0	16	
			6.4	.163	72 100	4.97×10 ⁸	16	
	1000	811	0	0	0	0	5, 30, 120, 240, 360	
			2.0	.051	22 500	1.55×10 ⁸	5, 30, 120, 240, 360	
	17-4 PH steel	900	755	0	0	0	0	5, 15, 30, 60, 120, 360
				2.0	.051	22 950	1.58×10 ⁸	5, 15, 30, 60, 120, 360
				0	0	0	0	5
5.0				.127	57 400	3.96×10 ⁸	5	
A-286	1300	978	0	0	0	0	5, 30, 120	
			.8	.020	9 280	6.40×10 ⁷	5, 30, 120	
			1.5	.038	17 400	1.20×10 ⁸	30	
			2.0	.051	23 200	1.60×10 ⁸	5	
René 41	1400	1033	0	0	0	0	5, 18, 120, 240	
			1.0	.025	12 250	8.45×10 ⁷	5, 18, 120, 240	
			2.0	.051	24 500	1.69×10 ⁸	5, 18	
L-605 (HS-25)	1600	1144	0	0	0	0	600	
			.8	.020	10 450	7.20×10 ⁷	600	
			1.4	.036	18 300	1.26×10 ⁸	10 (vibration), 600 (static)	

grade maraging steel specimen with a 2-mil (5.1×10^{-2} mm) peak-to-peak displacement is also included. All values of maximum cyclic stress for all the materials tested were calculated and are given in table III.

The second type of specimen used is shown in figure 7(b). In the tapered specimen the displacement of vibration was higher in the portion of the specimen with constant smaller diameter. High stresses up to the fatigue failure level were generated in this portion of tapered specimens of the 300 grade maraging steel and 17-4 PH steel. The design of ultrasonic fatigue specimens is discussed in references 22 and 23.

Test Conditions

The test conditions for each material are listed in table III. For all materials that were subjected to ultrasonic vibration a control sample was given a static aging treatment at an equivalent temperature in the heat-treating chamber (fig. 2). Both the static and vibrated specimens were heat treated for the time intervals shown, checked for hardness, and then returned to the heat-treating chamber for the next time interval. The specimens were heat treated separately so that vibration would not be transmitted from the ultrasonically vibrated specimen to the statically aged control specimen.

The test temperatures for the alloys were the manufacturers' recommended aging temperatures. The 300 grade maraging steel was also heat treated 100°F (55.6 K) above and 100°F (55.6 K) below the recommended aging temperature.

Temperatures of the heat-treating bath were measured with thermocouples attached to the specimens during static tests (figs. 5 and 6), and also by several thermocouples in the bath during both the static and vibratory tests. Bath temperatures agreed to within $\pm 3^{\circ}\text{F}$ (1.7 K) of the measured specimen temperatures in static tests. Typical temperature distributions along the lengths of static specimens at the heat-treating temperatures considered are shown in figure 9.

Several different vibration displacements were applied to determine the effect of stress on aging. Specimens vibrated at maximum displacements of more than 3 mils ($7.62 \times 10^{-2}\text{ mm}$) were of the tapered type described in the previous section.

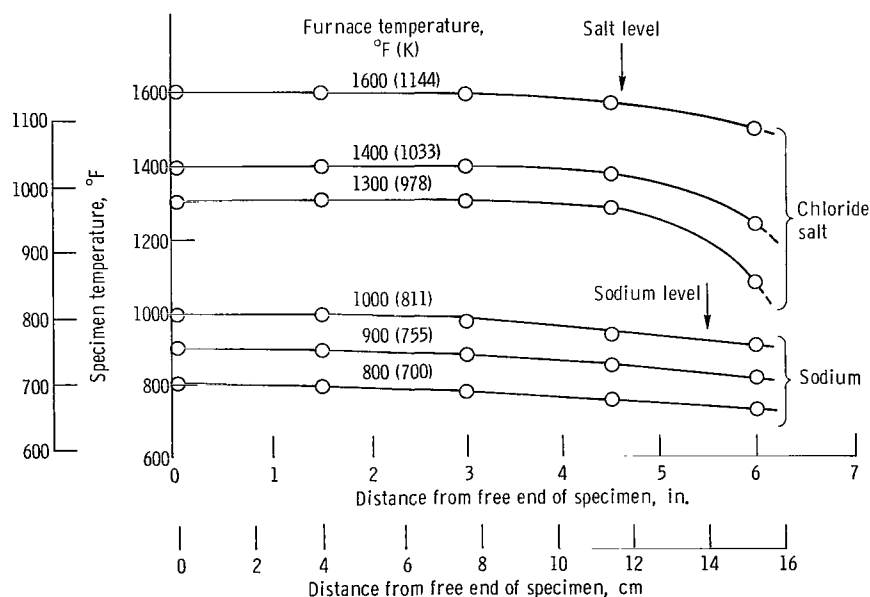

Figure 9. - Typical temperature distributions in static specimens at various furnace chamber temperatures.

Test Procedure

The heat-treating bath was brought to the desired test temperature before inserting the test specimen. A temperature drop was observed in the bath upon immersion but the desired test temperature was usually attained in less than 10 minutes. The test time was measured from the time when the temperature of the lower 1/2 wavelength region of the specimen was within 20° F (11.1 K) of the desired test temperature.

A hardness traverse was made on each specimen in the solution treated condition for reference purposes. The hardness tester was equipped with an adapter to handle cylindrical specimens. Measurements on tapered specimens were taken along the constant diameter portion using a similar type of adapter. Hardness measurements were reproducible within ±0.5 unit on the Rockwell C scale and ±1.0 unit on the Rockwell B scale. After each incremental aging treatment (table III) the specimen was removed, air cooled, cleaned, and hardness measurements were taken along the specimen length. Specimens heat treated in sodium were cleaned first with alcohol, then water, and dried with cleaning tissue. Specimens treated in salt were cleaned by polishing until all the salt scale was removed. Bearing surfaces were always polished to remove any metal raised by previous Rockwell impressions.

After aging for 6 hours, tensile tests were conducted with specimens cut from both static and vibrated 300 grade maraging steel straight bar specimens. Figure 10 shows a drawing of the standard tensile specimen used for these tests. It was cut from the lower 1/2 wavelength portion of each bar specimen in such a way that the nodal portion of the test bar was approximately in the center of the tensile specimen.

Metallographic examinations were made of L-605 specimens to determine the distribution of visible precipitates resulting from both the static and the ultrasonic vibration aging.

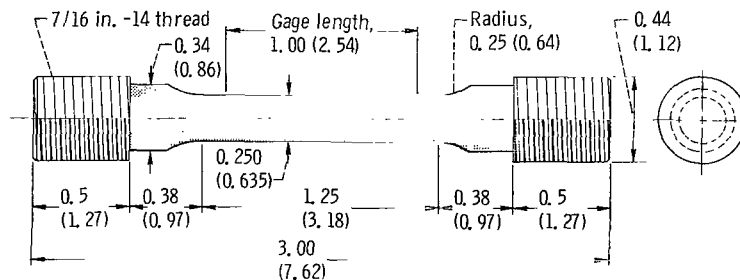

CD-10249-32

Figure 10. - Standard tensile specimen cut from nodal portion of aged straight bar specimens. (All dimensions in inches (cm).)

RESULTS AND DISCUSSION

Comparison of Hardness After Static Aging and Ultrasonic Vibration Aging

The hardness distribution along the length of static and vibrated straight bar specimens treated at different temperatures are presented in figures 11 to 14. The static and vibrated specimens are compared at various time intervals from 5 to 360 minutes. Solid lines represent specimens that were heat treated with no vibration, and the dotted lines represent specimens that were vibrated ultrasonically while they were being heat treated. Generally, the maximum hardness reached by vibrated specimens was the same as that reached by statically aged specimens. Also, the ultrasonically vibrated specimens usually reached maximum hardness sooner than specimens that were statically aged. Overaging was observed earlier for ultrasonically vibrated than for statically aged alloys.

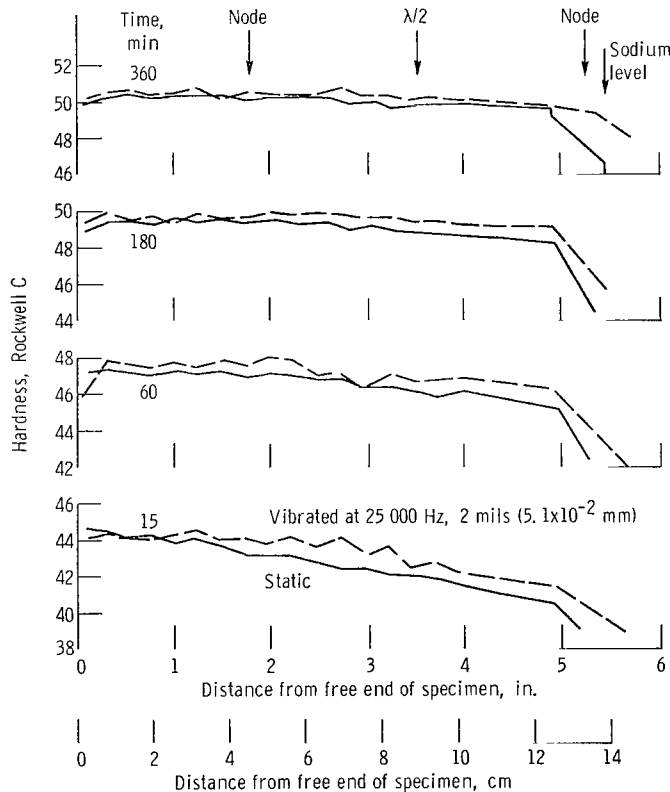

(a) Temperature, 800° F (700 K). Hardness at 0 time: RC 29.6 to 30.8.

Figure 11. - Comparison of hardness results between static aging and ultrasonic vibration aging at various times for 300 grade maraging steel. Heat treating medium, sodium.

300 grade maraging steel. - The hardness curves for the 300 grade maraging steel specimens aged at 800^o, 900^o, and 1000^o F (700, 755, and 811 K) are presented in figure 11. The distance from 0 to 3 inches (7.5 cm) from the free end of the specimen is the most significant portion of each of the hardness curves because the heat-treating bath temperature was most uniform in this zone. For the vibrated specimen treated at 800^o F (700 K) (fig. 11(a)), a slight increase in hardness over the statically aged specimen was observed at 60 minutes, but after 180 minutes exposure, the two specimens exhibited nearly equal hardness values. The maximum increase in hardness of the vibrated over the static specimen was approximately 1.5 points on the Rockwell C hardness scale at any specified time. At 900^o F (755 K) (fig. 11(b)), the vibrated specimen showed a slight (about 1 point) hardness increase over the statically aged specimen from 5 to 60 minutes, but nearly the same hardness beyond 240 minutes.

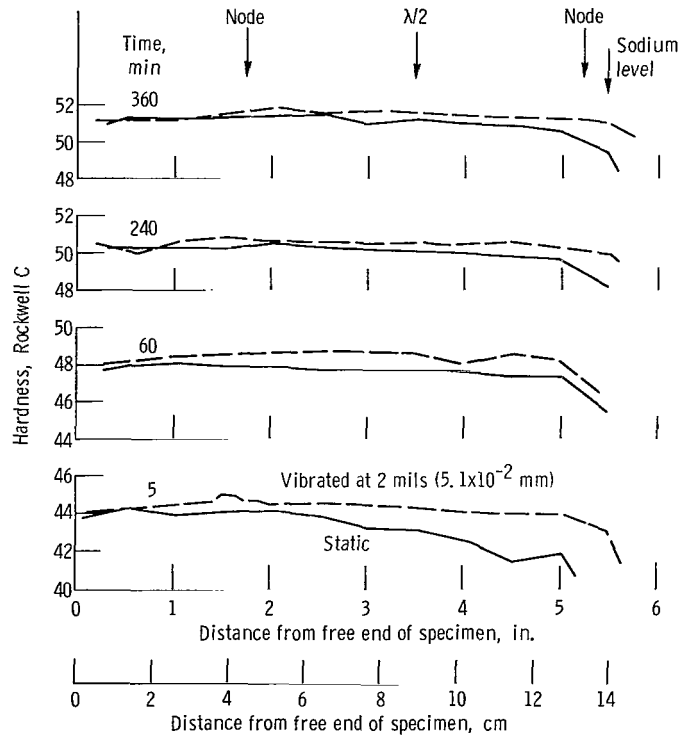

(b) Temperature, 900^o F (755 K). Hardness at 0 time: RC 28.9 to 30.0.

Figure 11. - Continued.

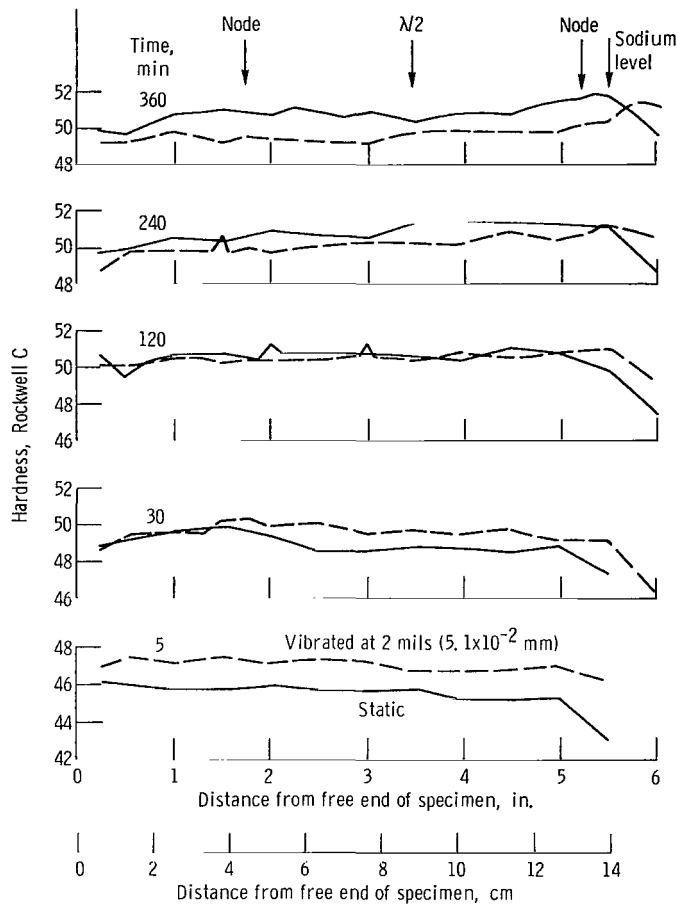

(c) Temperature, 1000° F (811 K). Hardness at 0 time: RC 27.2 to 29.1.

Figure 11. - Concluded.

At 1000° F (811 K) (fig. 11(c)) the vibrated specimen exhibited about a two-point increase in hardness after 5 minutes exposure over the statically aged specimen. However, at 30 and 120 minutes the two specimens were nearly equal in hardness. At 240 and 360 minutes the vibrated specimen decreased in hardness due to overaging compared to the statically aged specimen.

17-4 PH steel. - A comparison of hardness curves for vibrated and statically aged specimens of 17-4 PH steel is presented in figure 12. After 5 minutes the vibrated specimen showed a higher hardness than the statically aged specimen. A difference of about 2.5 Rockwell C scale units was noted.

The vibrated 17-4 PH steel specimen reached peak hardness in 15 minutes at 900° F (855 K) as compared to 30 minutes for the statically aged specimen. At 360 minutes the hardness of the vibrated specimen was as much as 2.5 Rockwell C units below that of the statically aged specimen, but both specimens overaged.

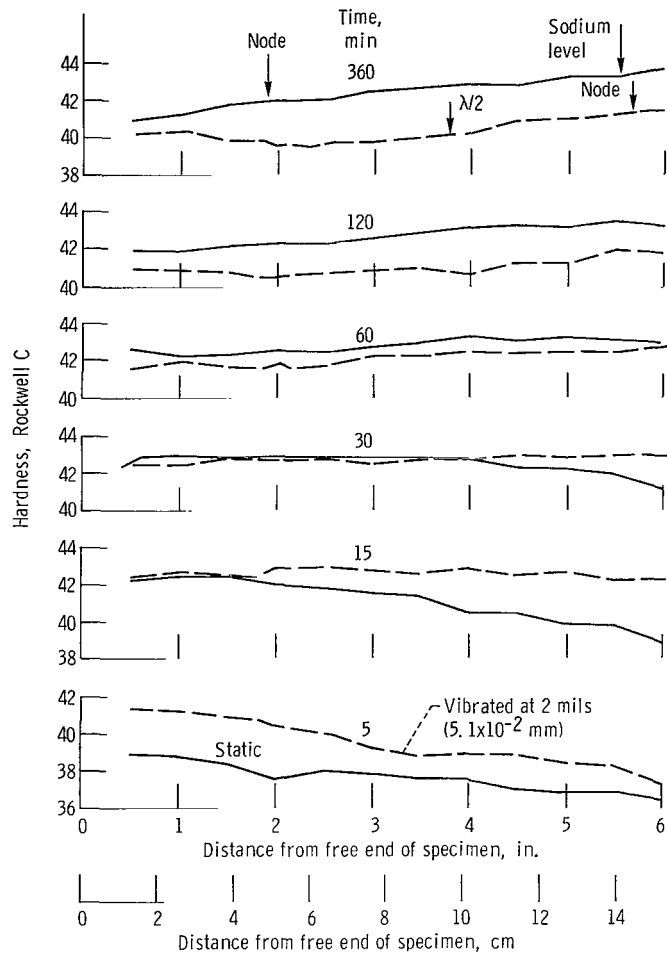

Figure 12. - Comparison of hardness results between static aging and ultrasonic vibration aging at various times at 900° F (755 K) for 17-4 PH steel. Heat treating medium, sodium. Hardness at 0 time: RC 31.9 to 32.6.

A-286. - Hardness curves for statically aged and vibrated A-286 specimens are shown in figure 13. Vibration displacements of 0.8, 1.5, and 2 mils (2.0 , 3.8 , and 5.1×10^{-2} mm) were used. Since these tests were run at 1300° F (978 K), which is near the upper limit of reasonable strength for this material, it was necessary to go to reduced vibrational displacements to permit test operation for relatively long times. In each of these tests, the displacement decreased continuously during the last 4 to 5 minutes of the test. When the displacement decreased to about 30 percent of the original displacement, the test was terminated.

After 5 minutes no improvement was observed for the vibrated specimens over the statically aged specimen. But after 30 minutes, specimens vibrated at both 0.8 and 1.5 mils showed an increase in hardness of about 2 Rockwell B scale units above the hardness of the statically aged specimen, and at the nodal point the increase was 4 Rockwell B units for 1.5 mil vibrated specimens. The specimen vibrated at 0.8 mils (2.0×10^{-2} mm) remained 1.5 Rockwell B units harder than the statically aged specimen after 120 minutes.

René 41. - Hardness curves for specimens of René 41 are shown in figures 14(a) and (b). Figure 14(a) shows the hardness results for the statically aged specimen and a specimen vibrated initially at 2 mils (5.1×10^{-2} mm) and figure 14(b) shows a similar comparison for the statically aged specimen and a specimen vibrated at 1 mil (2.5×10^{-2} mm).

The specimen vibrated at 2 mils (5.1×10^{-2} mm) failed after 18 minutes of testing. Failure was indicated by a gradual decrease in the vibration displacement from 2 mils (5.1×10^{-2} mm) to about 0.2 mils (0.5×10^{-2} mm) during the last 5 minutes of the 18 minute test. The vibrated specimen showed no improvement in the hardness over the static specimen. A zero time hardness plot is included in figure 14(a) to show that the two as-received specimens had an initial hardness difference of about 2 Rockwell C units.

A hardness peak was observed in the curve for the specimen that was vibrated for 18 minutes near the upper node. This portion of the specimen was above the heat-treating fluid level. Consequently, the effects observed in this region are considered to be outside of the scope of this investigation. It is believed that the hardness peak observed with the vibrating specimen near the upper node is not particularly significant, but it may be indicative of a possible optimum combination of vibratory stress, environment, time, and temperature for this alloy. Severe cracking was also observed near the upper node of this specimen. The specimen vibrated at 1 mil (2.5×10^{-2} mm), figure 14(b), showed no significant hardness increase over the statically aged specimen until after 120 minutes of vibration. At 240 minutes the vibrated specimen had a maximum hardness increase of 2 Rockwell C units above the hardness of the static specimen. The hardness (Rockwell C 40) reached by the vibrated specimen in 4 hours is equivalent to the optimum hardness that can be reached by statically aging this alloy for 16 hours.

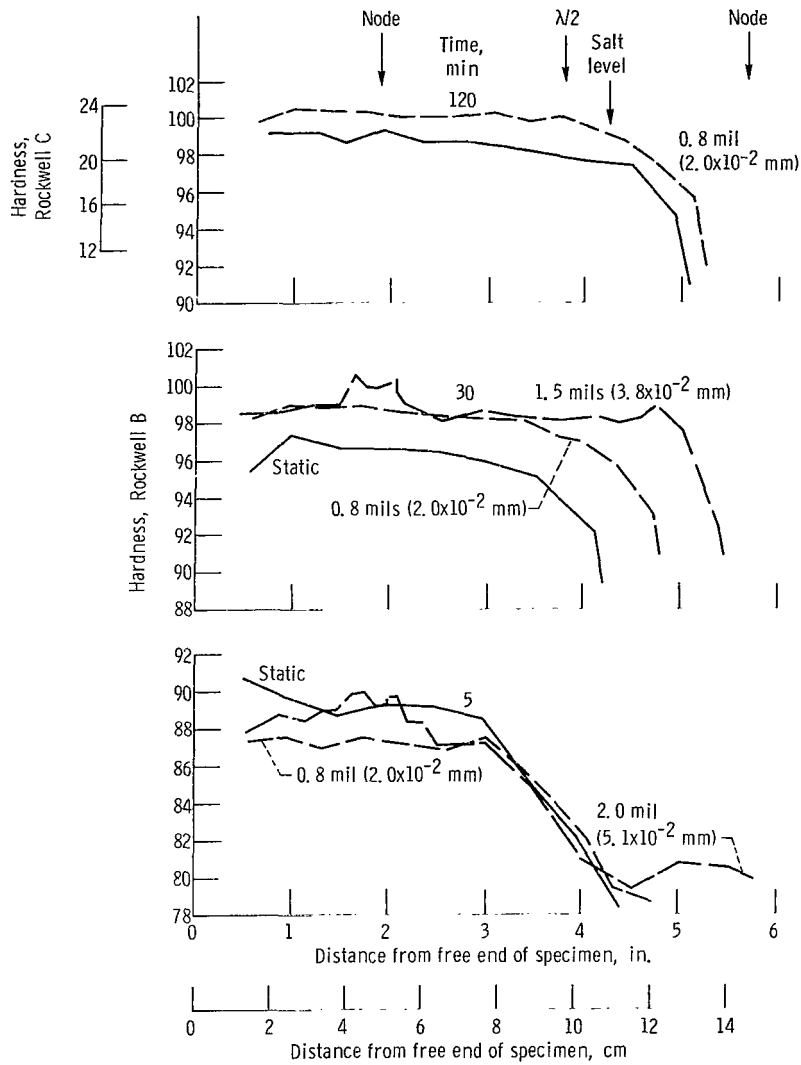
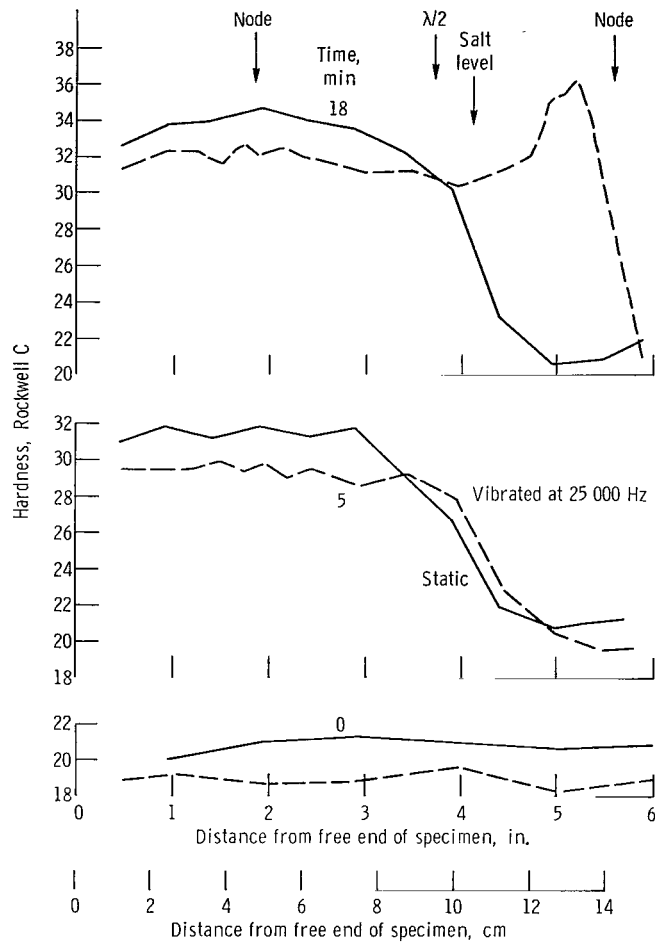
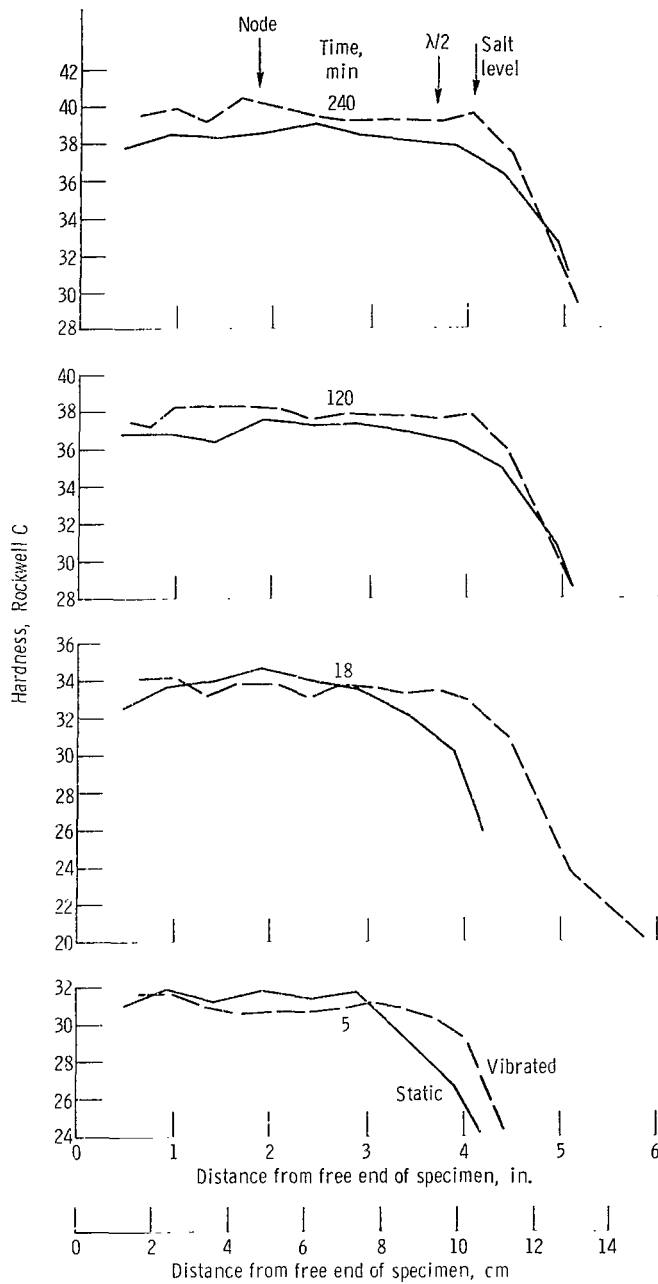

Figure 13. - Comparison of hardness results between static aging and ultrasonic vibration aging at various times at 1300° F (978 K) for A-286. Heat treating medium, chloride salts. Hardness at 0 time: RB 76.0 to 78.8.



(a) Ultrasonic vibration at 2 mils (5.1×10^{-2} mm).

Figure 14. - Comparison of hardness results between static aging and ultrasonic vibration aging at various times at 1400° F (1033 K) for René 41. Heat treating medium, chloride salts.



(b) Ultrasonic vibration at 1 mil (2.5×10^{-2} mm). Hardness at 0 time: RC 20.0 to 21.8.

Figure 14. - Concluded.

L-605. - Hardness curves are not shown for L-605 because no significant change in hardness was observed on aging the annealed material. This material was tested primarily to make metallographic studies of the precipitate distribution.

Effect of Vibration Stress on Aging

When ultrasonic vibration is applied to a straight bar type specimen by direct coupling to the transducer, the specimen will vibrate most efficiently at a resonant frequency, determined by its length. The specimen length is usually chosen to be a multiple of $1/2$ the wavelength of the applied frequency. When the specimen vibrates, stress within the specimen can vary from near zero at the free vibrating end to a maximum at the stationary nodes. Certain investigators considered the effect of this variable stress on diffusion of nitrogen in steel (ref. 24); and others showed that there was increased carburization of iron in the highly stressed nodal regions of their specimens (ref. 13). However, in most investigations of ultrasonic aging very little mention is made of the effect of variable stress in specimens. If applied stress were important in the aging process, it might be expected that large variations in the degree of age hardening should occur within each specimen.

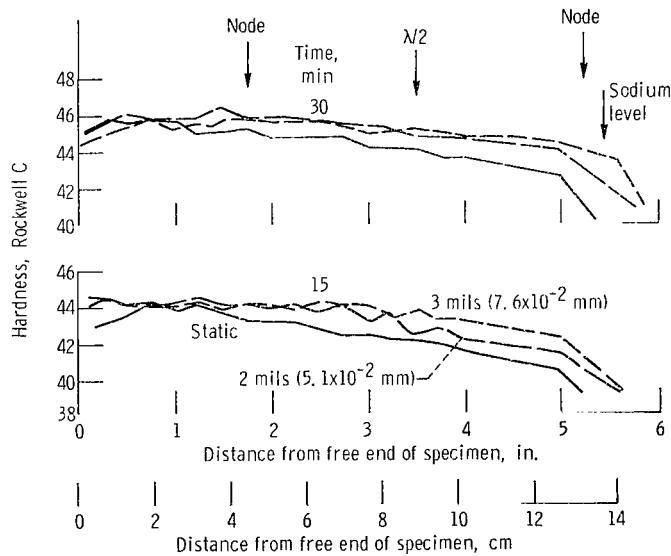

Figure 15. - Comparison of hardness results between static aging and ultrasonic vibration aging at various times at 800° F (700 K) for 300 grade maraging steel. Heat treating medium, sodium. Hardness at 0 time: RC 29.6 to 30.8.

Hardness curves for specimens vibrated at different displacements are shown in figures 13 to 17. It was observed in general that stresses resulting from different ultrasonic vibration displacements ranging from 0.8 mil (2.0×10^{-2} mm) (straight bar specimen) up to 6.4 mils (16.3×10^{-2} mm) (tapered specimens) had no consistent and apparently no appreciable effect on the aging results. Also, at the nodal points where stress and strain were maximum, essentially no difference was noted between the hardness at this part of the specimen and at other locations that were subjected to less stress and strain.

In the few cases where increased hardness was observed at nodes, cracks were also observed in the nodal region. The cracking may be due to a fatigue mechanism. This cracking may have also caused some scatter of hardness data in this region. Results for specific materials are discussed in the following sections:

300 grade maraging steel. - Specimens of the 300 grade maraging steel were aged at 800° F (700 K), and the hardness curves for a statically aged specimen and straight bar specimens vibrated at 2 and 3 mils (5.1 and 7.6×10^{-2} mm) are shown in figure 15. The curves for the 2- and 3-mil (5.1 - and 7.6×10^{-2} -mm) vibration specimens are essentially the same and also overlap the static specimen hardness curves. Also, in this figure the hardness at the lower node is not significantly higher than the hardness at the antinode. These curves support the conclusion that during aging an increased vibration stress does not increase the hardness of the alloy.

Figure 16 shows the hardness curves for the 900° F (755 K) aging tests of tapered specimens of the 300 grade maraging steel. The vibrated specimen was run until fracture occurred near the node. This specimen was vibrated at 6.4 mils (16.3×10^{-2} mm) and it

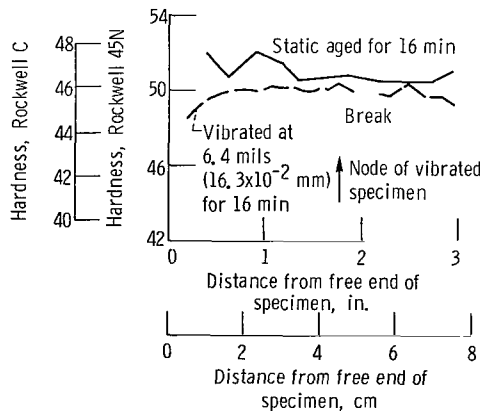

Figure 16. - Hardness results from static aging and ultrasonic aging of tapered specimens of 300 grade maraging steel at 900° F (755 K). Heat treating medium, sodium. Hardness at 0 time; Rockwell 45N 26.5 to 29.6

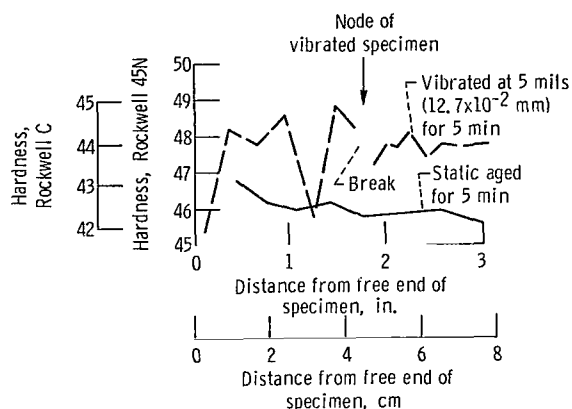

Figure 17. - Hardness results from static aging and ultrasonic aging of tapered specimens of 17-4 PH steel at 900° F (755 K). Heat treating medium, sodium. Hardness at 0 time: Rockwell 45N 38.8 to 39.4.

failed after approximately 16 minutes. After 16 minutes the hardness of this vibrated specimen was within 2 Rockwell 45 N units of the specimen statically aged for 16 minutes.

It is significant that the vibrated specimens showed no increase in hardness near the node as compared to the remaining portions of the specimen. Thus, in this case, ultrasonic vibration stress had no observable effect on the age-hardening reaction.

17-4 PH Steel. - Hardness curves for tapered specimens of 17-4 PH steel are presented in figure 17. Static and vibrated specimens were aged for approximately 5 minutes at 900° F (755 K). The vibrated specimen failed after 5 minutes. Although considerable scatter is evident in the hardness data of the vibrated specimen, most hardness values of this specimen were approximately 2 units on the Rockwell 45 N scale above those of the statically aged specimen. It was also noted that hardness values of the vibrated specimen were no higher in the highly stressed nodal region than they were in other parts of the specimen.

A-286 and René 41. - The effects of increased vibration stress on hardness for A-286 and René 41 are presented in figures 13 and 14, respectively, and have been discussed previously. These results also indicated that ultrasonic stress did not appreciably affect the hardness.

Comparison of Tensile Test Data from Statically Aged and Vibrated Aged Specimens

Tensile tests were made to determine if ultrasonic vibration of specimens during aging had any effect on tensile strength, yield strength, and ductility. The results of

TABLE IV. - ROOM TEMPERATURE TENSILE PROPERTY DATA OF 300 GRADE MARAGING
STEEL SPECIMENS AFTER AGING AT VARIOUS TEMPERATURES FOR 6 HOURS

Specimen	Aging temperature		Yield strength (0.2 percent)		Ultimate strength		Elongation, percent	Reduction in area, percent
	^o F	K	psi	N/m ²	psi	N/m ²		
Static	800	700	260 500	1.80×10 ⁹	267 700	1.84×10 ⁹	9.6	46.1
Vibrated ^a	800	700	264 900	1.83	270 700	1.87	9.6	47.1
Static	900	755	273 500	1.89	279 400	1.93	9.6	52.7
Vibrated ^a	900	755	277 000	1.91	281 900	1.94	9.2	52.8
Static	1000	811	256 700	1.77	268 900	1.85	10.0	52.4
Vibrated ^a	1000	811	241 400	1.67	255 900	1.77	11.2	45.2

^aNode of vibrated specimen at center of tensile specimen.

the tensile tests of the 300 grade maraging steel specimens are presented in table IV and shown in figure 18. The solid line represents the statically aged specimens and the dotted lines the vibrated specimens. From figure 18 it can be seen that at 800^o and 900^o F (700 and 755 K), the tensile strengths and yield strengths of the vibrated specimens were higher than those of the static specimens by approximately 1 and 2 percent, respectively. The effect of vibration on ductility, at 900^o F (755 K) was to decrease elongation from 9.6 to 9.2 percent. After aging at 1000^o F (811 K) the tensile and yield strengths of the vibrated specimen decreased by approximately 5 and 6 percent, respectively, below the strengths of the statically aged specimen. This drop was due to overaging of the material. The elongation increased by approximately 1 percent but the reduction in area of this specimen at fracture decreased from approximately 52 to 46 percent.

In general, changes in the tensile properties of specimens subjected to ultrasonic vibration were slight; but these changes were consistent with the results of hardness tests presented previously.

Metallographic Study of Precipitate in L-605

Most of the precipitates formed during the previous aging tests were submicroscopic in size and would have been visible only after overaging for very long times. L-605, however, is an alloy which forms an observable precipitate near the grain boundaries in relatively short aging times. Investigators have found that working this alloy before aging can cause precipitates to nucleate and grow within the matrix (ref. 19). In the present investigation it was desirable to see if ultrasonic vibration could similarly influence the location of the precipitate.

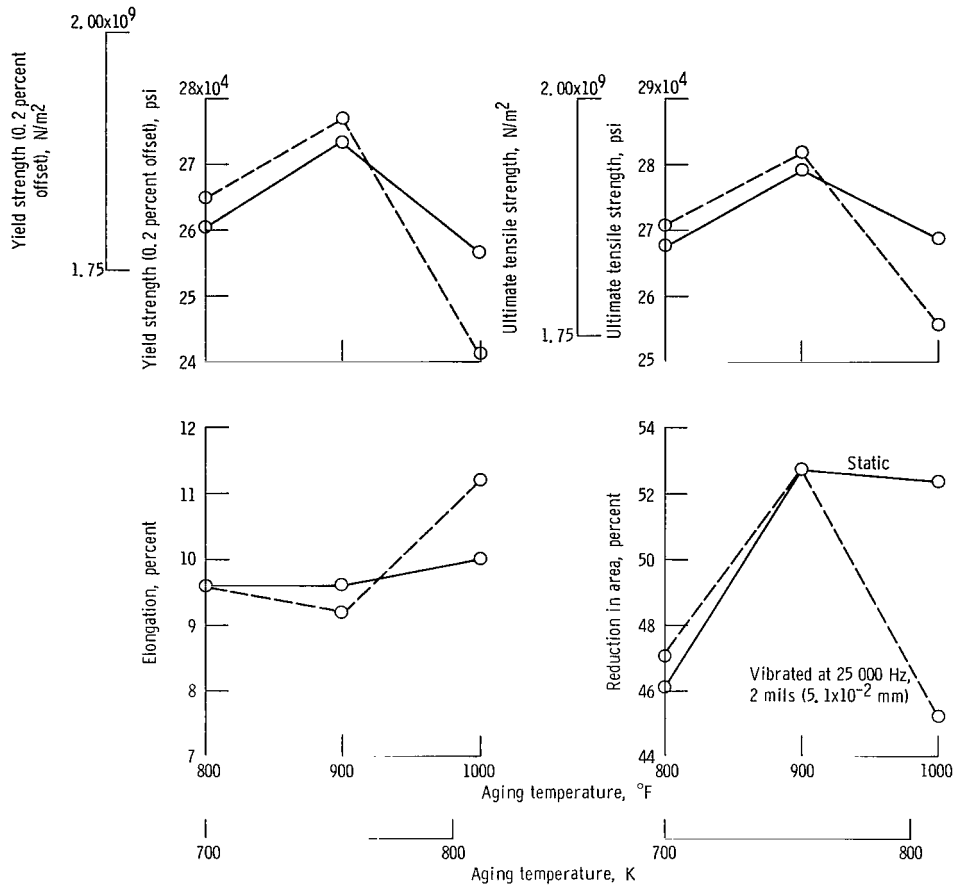
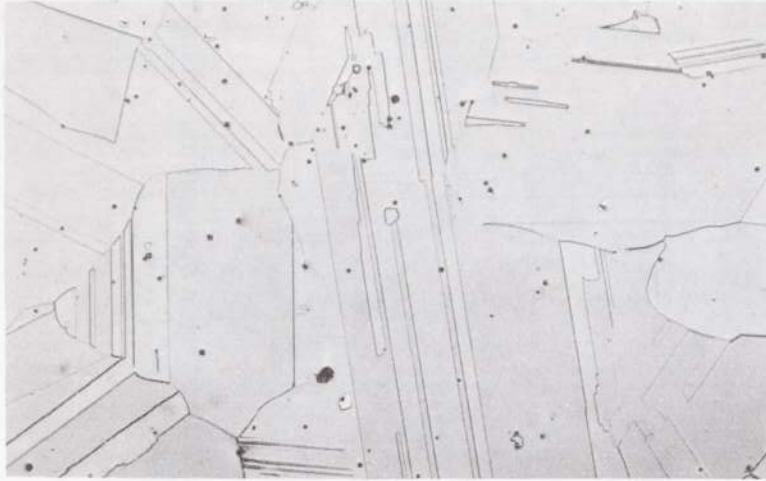
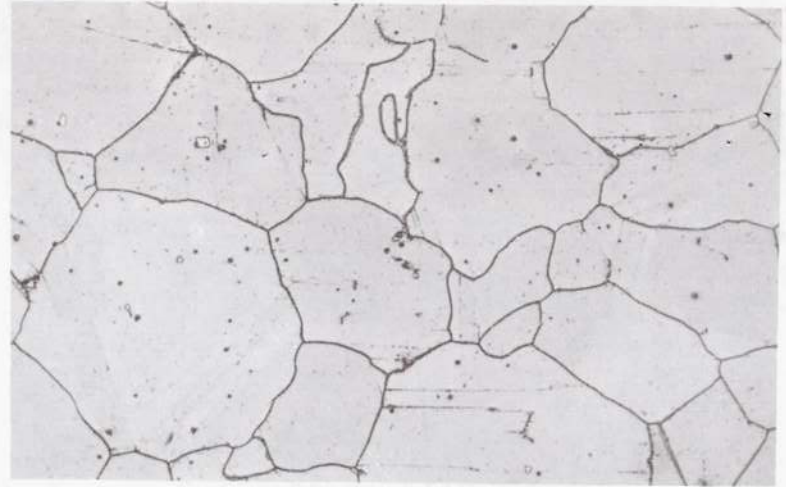

Figure 18. - Room temperature tensile property data of 300 grade maraging steel after aging for 6 hours. Heat treating medium, sodium.

Figure 19(a) shows the microstructure of the cobalt-base alloy, L-605, in the as-received, solution heat-treated condition. Figure 19(b) shows the structure of the alloy as aged statically at 1600^o F (1144 K) for 10 hours. Most of the precipitate is observed in or near the grain boundaries. Figure 19(c) shows the structure of the alloy that was subjected to vibration of 1.4 mils (3.6 × 10⁻² mm) for 10 minutes at 1600^o F (1144 K), and then statically aged at 1600^o F (1144 K) for 10 hours. The precipitates were still seen to form at or near the grain boundaries. Figure 19(d) shows the structure of the L-605 that was vibrated at 0.8 mil (2.0 × 10⁻² mm) for 10 hours while it was being heat treated at 1600^o F (1144 K). Again, as in the case of the other two aged specimens, most of the precipitates formed at or near the grain boundaries. Thus optical microscopy indicates that ultrasonic vibration did not induce nucleation sites for precipitates within the matrix of this alloy.



(a) L-605 as received.



(b) Aged statically at 1600° F (1144 K) for 10 hours.

(c) Vibrated at 1.4 mils (3.6×10^{-2} mm) for 10 minutes and statically aged for 10 hours at 1600° F (1144 K).(d) Vibrated at 0.8 mil (2.0×10^{-2} mm) at 1600° F (1144 K) for 10 hours.

Figure 19. - Microstructure of L-605 after various aging treatments. Etchant, as received. (Electrolytic etched in 100 cc of 30 percent HCl + a few drops of H₂O₂; others etched in 30 cc boric acid + 70 cc of 5 percent H₂SO₄.) X250.

Effect of Heat-Treating Environment

The present investigation has shown a relatively small improvement in the hardening rate of alloys due to ultrasonic vibration as compared with some other investigations (refs. 5 and 7). Many previous investigators did not consider the heat added to the system by the ultrasonic vibration itself. If specimens become heated from vibration and no provision is made to carry away the excess heat, diffusion will be accelerated. The resulting increases in hardening rates and changes in mechanical properties would then be due primarily to the temperature increase and not to some other aspect of the ultrasonic vibration. It is, therefore, not surprising that previous investigators who used liquid heat-treating baths (refs. 8 and 9) showed smaller increases in hardening rates and less diffusion effects than those who used powder or gas environments (refs. 7 and 13).

The heating that can develop from vibration alone is shown in figure 20 which presents the results of an infrared temperature scan of a specimen vibrated in air. No heat was supplied to the specimen except for the heat generated internally by the vibration of the specimen itself. The specimen was vibrated at approximately 2 mils (5.1×10^{-2} mm). Within 10 minutes the lower node of the specimen reached 310° F (428 K). After 30 minutes the lower node reached 395° F (475 K). This heating due to vibration would considerably influence results of ultrasonic aging tests if steps were not taken to remove the added heat, especially for materials such as aluminum that age harden at low temperatures.

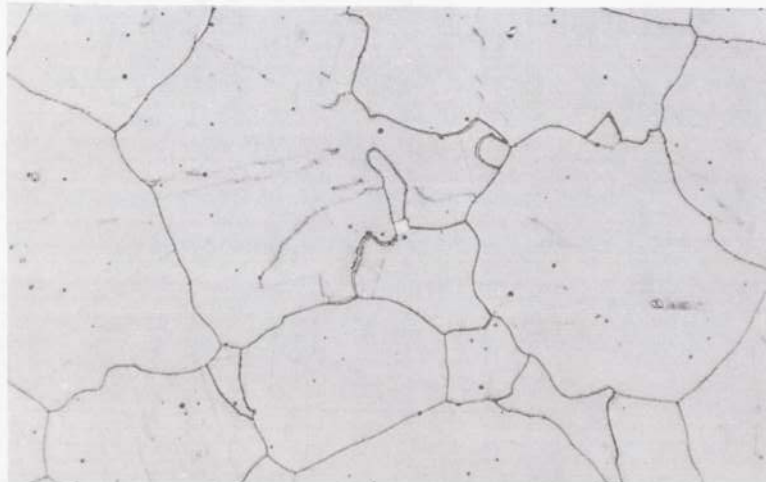
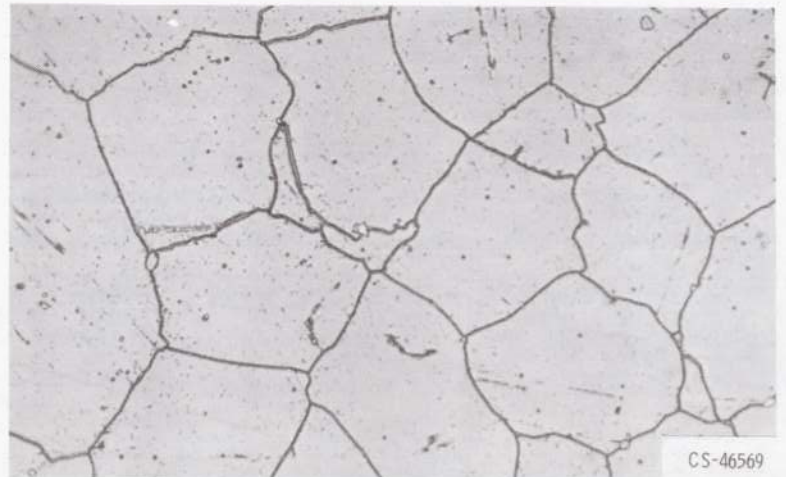
To further demonstrate this heating effect, specimens of 300 grade maraging steel were heat treated in an air furnace at 800° F (700 K). A static and vibrated specimen were subjected to the 800° F (700 K) temperature for 5 minutes. Only the lower half of the specimen was located in the furnace (see fig. 6). After the 5 minute aging tests, hardness measurements were made. The results of the hardness measurements are shown in figure 21. From the figure, it can be seen that the vibrated specimen was unquestionably harder than the statically aged specimen, and a possible nodal effect was observed. The hardness of this vibrated specimen aged in air at 800° F (700 K) for 5 minutes compares closely with the hardness of the vibrated specimen aged in sodium at 1000° F (811 K) for 5 minutes (fig. 11(c)). These results emphasize that the effects of ultrasonic vibration on aging can only be meaningfully evaluated if specimens are heat treated in a medium in which it can be assured that a fairly constant specimen temperature (close to the nominal desired heat-treating temperature) can be maintained.

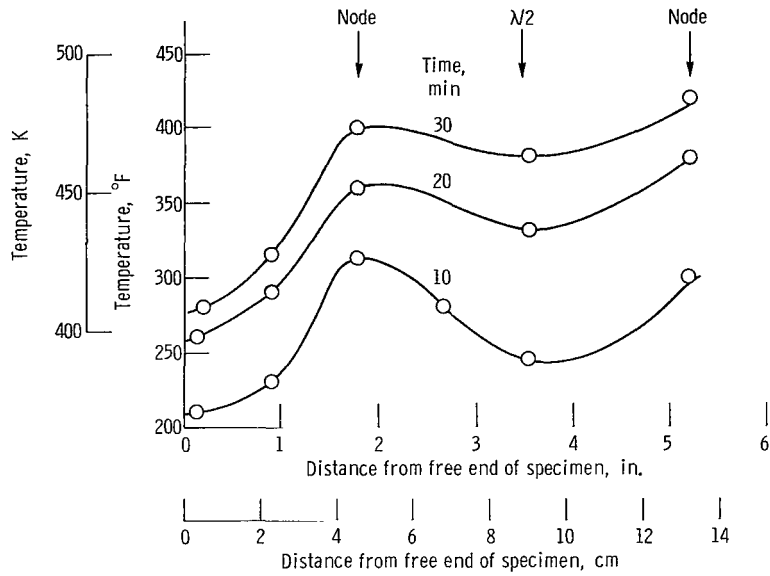

Figure 20. - Temperature profile of 300 grade maraging steel specimen vibrated in air at 25 000 hertz, 2 mils (5.1×10^{-2} mm). Temperature measured by infrared pyrometer (lower limit: 200° F or 366 K).

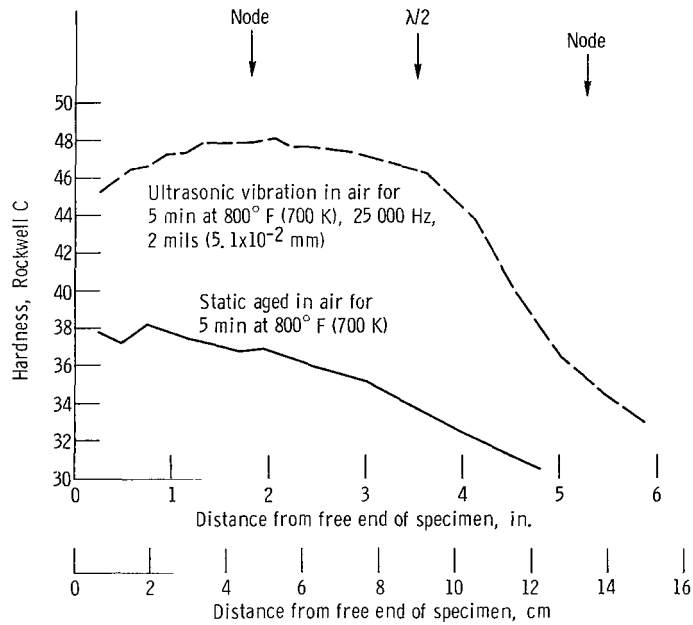

Figure 21. - Comparison of hardness results between static aging and ultrasonic vibration aging in air environment for 300 grade maraging steel. Hardness at 0 time: RC 28, 2 to 30, 8.

CONCLUDING REMARKS

Energy developed by ultrasonic vibration can heat specimens above the nominal desired temperature of the heat-treating medium. This, in effect, is equivalent to statically aging at a higher temperature. It is believed that certain beneficial effects previously attributed to ultrasonic vibration during aging may in fact be due to such heating.

Any attempts to further evaluate the true effects of ultrasonic vibration on precipitation hardening of a material require the use of heat-treating media with good heat transfer properties so as to carry away heat generated internally by vibration, and more closely maintain the desired specimen temperature.

In this study ultrasonic vibration was found to cause some increase in hardening rate for the materials studied. However, it is possible that this increase was due to unmeasured specimen temperature increases caused by vibration (less than those observed in air) even though the high heat transfer liquid media were used.

SUMMARY OF RESULTS

The effect of ultrasonic vibration at a frequency of 25 000 hertz on the aging process was investigated over a range of temperatures for a 300 grade maraging steel, 17-4 PH steel, A-286, René 41, and L-605, using a magnetostrictive vibratory apparatus. The following results were obtained:

1. Ultrasonic vibration superimposed on alloys during aging increased the hardening rate for most of the alloys tested. For example, the vibrated 17-4 PH steel specimen reached peak hardness in 15 minutes at 900^o F (855 K) compared to 30 minutes for the statically aged specimen.

2. The maximum hardness obtained by ultrasonic vibration, although reached at an earlier time, did not exceed that obtainable by statically aging any of the alloys.

3. Room temperature tensile tests of ultrasonically vibrated 300 grade maraging steel at 800^o and 900^o F (700 and 755 K) showed slight improvements in mechanical strength after 6 hours of aging. The tensile strength increased by about 1 percent and the yield strength increased by about 2 percent.

4. For all materials tested, variations in vibration stress had no consistent or appreciable effect on the aging results.

5. Metallographic examination of precipitates in vibrated L-605 specimens showed no differences from the precipitate distribution in statically aged specimens.

6. An ultrasonically vibrated specimen of a 300 grade maraging steel aged in an air furnace showed a considerable increase in the age hardening rate over that of a static

specimen aged in air at 800⁰ F (700 K). This increase was due to the increased specimen temperature induced by the ultrasonic vibration.

Lewis Research Center,
National Aeronautics and Space Administration,
Cleveland, Ohio, November 18, 1968,
129-03-03-03-22.

APPENDIX A

CALCULATION OF WAVELENGTH OF 25 000 HERTZ WAVE IN A 300 GRADE MARAGING STEEL

$$\text{Wavelength} = \lambda = c/f$$

f frequency = 25 000 Hz

c velocity of sound in metal = $\sqrt{Eg/\rho}$

E modulus of elasticity

g acceleration of gravity = 32.2 ft/sec² (980 cm/sec²)

ρ density

From reference 25 - for 300 grade maraging steel:

E 27.5 × 10⁶ lb/in.² (1.895 × 10¹¹ N/m²)

ρ 0.289 lb/in.³ (8.0 g/cm³)

Then:

$$\begin{aligned} c &= \sqrt{\frac{(2.75 \times 10^7)(32.2)(12)}{0.289}} \text{ in./sec} \\ &= 1.92 \times 10^5 \text{ in./sec} \quad (4.88 \times 10^5 \text{ cm/sec}) \end{aligned}$$

And:

$$\begin{aligned} \lambda &= \frac{c}{f} = \frac{1.92 \times 10^5}{2.5 \times 10^4} \\ &= 7.68 \text{ in.} \quad (19.5 \text{ cm}) \end{aligned}$$

APPENDIX B

EQUATIONS OF STRESS AND STRAIN BASED ON DISPLACEMENT FOR STRAIGHT BAR SPECIMENS SUBJECTED TO ULTRASONIC VIBRATION AT 25 000 HERTZ

(A) Derivation of stress and strain relations:

From reference 22:

displacement at any point of straight bar:

$$\delta = \delta_0 \sin kx, \text{ where } k = \frac{2\pi}{\lambda} = \frac{f}{c}$$

- δ_0 maximum displacement
 x distance from stationary node of specimen
 λ wavelength of sound in specimen material
 f frequency = 25 000 Hz
 c velocity of sound in material

Boundary conditions:

(1) At point of maximum displacement, $x = \lambda/4$, therefore

$$\delta = \delta_0 \sin \frac{2\pi}{\lambda} \frac{\lambda}{4} = \delta_0 \sin \frac{\pi}{2} = \delta_0$$

(2) At point of minimum displacement, $x = 0$

$$\delta = \delta_0 \sin 0 = 0$$

By definition: Strain (ϵ) = $\partial\delta/\partial x$

$$\delta = \delta_0 \sin \frac{2\pi x}{\lambda}$$

$$\epsilon = \frac{\partial\delta}{\partial x} = \delta_0 \frac{2\pi}{\lambda} \cos \frac{2\pi x}{\lambda}$$

ϵ_{\max} occurs at point of minimum displacement, $x = 0$

$$\epsilon_{\max} = \delta_o \frac{2\pi}{\lambda} (\cos 0), \quad \epsilon_{\max} = \delta_o \frac{2\pi}{\lambda}$$

Stress - maximum can be calculated from

$$\sigma_{\max} = E \epsilon_{\max}$$

where

σ_{\max} maximum stress

E modulus of elasticity

ϵ_{\max} maximum strain for displacement

Then, substituting for ϵ_{\max} :

$$\sigma_{\max} = E \delta_o \frac{2\pi}{\lambda}$$

(B) Calculation of maximum stress for a 300 grade maraging steel straight bar specimen with a 2-mil (5.1×10^{-2} -mm)(peak-to-peak) maximum displacement:

From reference 25:

$$E \quad 27.5 \times 10^6 \text{ lb/in.}^2 \quad (1.895 \times 10^{11} \text{ N/m}^2)$$

$$\lambda \quad 7.68 \text{ in.} \quad (19.5 \text{ cm})$$

Displacement of 2 mils (5.1×10^{-2} mm)(peak-to-peak) = 1 mil (2.5×10^{-2} mm) displacement from zero, then, from

$$\sigma_{\max} = E \delta_o \frac{2\pi}{\lambda}$$

$$= \frac{(27.5 \times 10^6)(0.001)(2)(\pi)}{7.68}$$

$$= 22\,500 \text{ lb/in.}^2 \quad (1.6 \times 10^8 \text{ N/m}^2)$$

REFERENCES

1. Kelley, A. ; and Nicholson, R. B. : Precipitation Hardening. Progress in Materials Science. Vol. 10, no. 3. Pergamon Press, 1963.
2. Lyman, Taylor, ed. : Heat Treating, Cleaning and Finishing. Vol. 2 of Metals Handbook. Eighth ed., Am. Soc. Metals, 1964.
3. Mehl, R. F. , et al. : Precipitation from Solid Solution. American Society for Metals, 1959.
4. Thomas, G. ; and Nutting, J. : The Aging Characteristics of Aluminum Alloys. J. Inst. Metals, vol. 88, 1959-1960, pp. 81-90.
5. Pogodina-Alekseeva, K. M. ; and Eskin, G. I. : Effect of Ultrasonic Vibrations on the Precipitation Hardening and Tempering of Some Alloys. Henry Bratcher Translation no. 4551, Jan. 1956.
6. Gorskiu, F. K. ; and Efremov, V. I. : Influence of Ultrasonic Vibrations on the Decomposition of Solid Solutions. Izvest. Akad. Nauk Beloruss. SSR, no. 3, 1953, pp. 155-164. Translation by H. E. Nowotny, Aluminum Labs. Ltd., Banbury.
7. Ermakov, V. S. ; and Al'ftan, E. A. : Aging of Creep-Resisting Nickel-Base Alloy EI 437 B Accelerated by Ultrasonic Vibrations. Henry Bratcher Translation no. 4278, 1958.
8. Anon. : Investigation of the Effects of Ultrasonics on the Deformation Characteristics of Metals. Wien Univ., Austria, 1964. (Available from DDC as AD-600383.)
9. Mes'kin, V. S. ; and Al'ftan, E. A. : Investigation of the Effect of Ultrasonics on the Results of the Heat Treatment of Alloys. Phys. Metals Metallography, vol. 11, no. 4, 1961, pp. 53-62.
10. Lee, Won Kak: Ultrasonic Treatment of Alloys to Produce Dispersion Strengthening. M. S. Thesis, West Virginia Univ., 1966.
11. Fairbanks, H. V. : Effect of Insonation During the Precipitation-Hardening of Alloys. Sound, vol. 1, no. 6, Nov. -Dec. 1962, pp. 35-39.
12. Fairbanks, H. V. ; and Dewez, F. J., Jr. : Effects of Acoustical Waves on the Annealing of Steels. J. Acoust. Soc. Am., vol. 29, no. 5, May 1957, pp. 588-592.
13. Rozanski, W. : Effect of Ultrasonic Vibrations upon Carburization of Steel. Henry Bratcher Translation no. 4860, 1958.
14. Pogodin-Alekseev, G. I. : Effect of Ultrasonic Vibrations on Diffusion in Steels and Alloys at Elevated Temperatures. Henry Bratcher Translation, no. 4247, 1958.

FIRST CLASS MAIL

POSTMASTER: If Undeliverable (Section 158
Postal Manual) Do Not Return

"The aeronautical and space activities of the United States shall be conducted so as to contribute . . . to the expansion of human knowledge of phenomena in the atmosphere and space. The Administration shall provide for the widest practicable and appropriate dissemination of information concerning its activities and the results thereof."

— NATIONAL AERONAUTICS AND SPACE ACT OF 1958

NASA SCIENTIFIC AND TECHNICAL PUBLICATIONS

TECHNICAL REPORTS: Scientific and technical information considered important, complete, and a lasting contribution to existing knowledge.

TECHNICAL NOTES: Information less broad in scope but nevertheless of importance as a contribution to existing knowledge.

TECHNICAL MEMORANDUMS: Information receiving limited distribution because of preliminary data, security classification, or other reasons.

CONTRACTOR REPORTS: Scientific and technical information generated under a NASA contract or grant and considered an important contribution to existing knowledge.

TECHNICAL TRANSLATIONS: Information published in a foreign language considered to merit NASA distribution in English.

SPECIAL PUBLICATIONS: Information derived from or of value to NASA activities. Publications include conference proceedings, monographs, data compilations, handbooks, sourcebooks, and special bibliographies.

TECHNOLOGY UTILIZATION PUBLICATIONS: Information on technology used by NASA that may be of particular interest in commercial and other non-aerospace applications. Publications include Tech Briefs, Technology Utilization Reports and Notes, and Technology Surveys.

Details on the availability of these publications may be obtained from:

SCIENTIFIC AND TECHNICAL INFORMATION DIVISION
NATIONAL AERONAUTICS AND SPACE ADMINISTRATION
Washington, D.C. 20546