

# Effect on Strength of Involute Spur Gear by Changing the Fillet Radius Using FEA

Ashwini Joshi, Vijay Kumar Karma

**Abstract** — Gearing is the special division of Mechanical Engineering concerned with the transmission of power and motion between the rotating shafts. Gears not only transmit motion and enormous power satisfactorily, but can do so with very uniform motion. It is the best and the economical means of achieving this transmission. Gear teeth fails due to the static and the dynamic loads acting over it, also the contact between the two mating gears causes the surface failures. The gear fails without any warning and the results due to this failure are catastrophic. Since the requirements are broad and are of varying difficulty, gearing is a complex and diversified field of engineering. It includes gear mathematics, geometrical design, strength and wear, material and metallurgy, fabrication and inspection. Therefore for all the reasons mentioned, this work is of more practical importance. To get the gear of more durability we can use improved material, hardening the gear surfaces with heat treatment and carburization, shot peening can be done to improve the surface finish, to change the pressure angle by using asymmetric teeth, introducing the stress relieving features of different shape, changing the addendum of the spur gear and altering the design of root fillet are the other methods. Present work deals with the effect on gear strength with variation of root fillet design using FEA. Circular root fillet design is considered for analysis. The loading is done at the highest point of single tooth contact (HPSTC).

**Index Terms**— Gear Design, Gear Strength, Fillet Radius, Circular Fillet, Trochoidal Fillet, Pro/ENGINEER, Pro/MECHANICA, Deflection.

## INTRODUCTION

Gears are usually used in the transmission system is also called a speed reducer, which consists of a set of gears, shafts and bearings that are factory mounted in an enclosed lubricated housing. Speed reducers are available in a broad range of sizes, capacities and speed ratios.

Wilfred Lewis developed the basic model for bending stress in gear teeth in 1892. In his analysis, Lewis considered a gear tooth to be a loaded cantilever beam with a force applied to the tip of the gear. He made the following assumptions;

1. The load is applied to the tip of a gear tooth;
2. Only the tangential component of the force will be a factor (the radial component is neglected);
3. The load is distributed uniformly across the entire face width of the gear;
4. Forces due to tooth sliding friction are negligible; and
5. No stress concentration is present in the tooth fillet. [1]

A pair of teeth in action is generally subjected to two types of cyclic stresses: bending stresses inducing bending fatigue and contact stress causing contact fatigue. Both these types of stresses may not attain their maximum values at the same point of contact. However, combined action of both of them is the reason of failure of gear tooth leading to fracture at the root of a tooth under bending fatigue and surface failure, like pitting or flaking due to contact fatigue.

These types of failures can be minimized by careful analysis of the problem during the design stage and creating

proper tooth surface profile with proper manufacturing methods.

The finite element method is capable of providing this information, but the time needed to create such a model is large. In order to reduce the modeling time, a preprocessor method that creates the geometry needed for a finite element analysis may be used, such as that provided by Pro Engineering. It can generate models of three-dimensional gears easily. The finite element method is very often used to analyze the stresses in an elastic body with complicated geometry, such as a gear.

In this work the effect on strength of involute spur gear with change in the design of root fillet radius is studied. The gear is modelled with circular fillet and then finite element analysis is carried out by taking the load at the highest point of the single tooth contact using Pro/ENGINEER wildfire software. The maximum and the minimum distortion produced at the fillet by both type of the loading are compared.

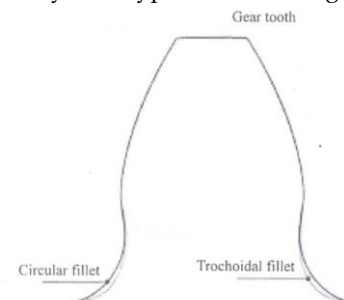

Fig. 1. Comparison of Circular Fillet and Trochoidal Fillet on a Tooth.

- Ashwini Joshi is currently pursuing masters degree program in Design and Thermal Engineering in Devi Ahilya University, Indore, India, PH-09826953449. E-mail: ashwinikjoshi@yahoo.com
- Vijay Kumar Karma is currently Lecturer in Mechanical Engineering Department in Devi Ahilya University, Indore, India. E-mail: vijaykarma@yahoo.com

## LITERATURE SURVEY

On this topic many scientists are working and many

of them find methods to increase the strength of the gear. Some technical papers published in the field related to the topic. Christos A. Spitas and Vasilis A. Spitas [2] did his work on a new spur gear 20° design that works interchangeably with standard 20° system and achieves increased tooth bending strength and hence the load carrying capacity. In this design, circular fillet replaces the normal trochoidal fillet, yielding large cross sectional at the tooth root and lower stress concentration. V. Spitas, Th. Costopoulos and C. Spitas [3] did his work on spur gear teeth with circular instead of the standard trochoidal root fillet is introduced and investigated numerically using FEA. M. Savage and Rubadeux [4] has propose a bending strength model for internal spur gear teeth, this model assist design efforts for unequal addendum gears and gears of mixed materials. M Koilraj, Dr G Muthuveerappan and Dr. J. Pattabiraman [5] on the basis of their work gives the conclusion that, the stress correction factor and the form factor increases with the increase in positive profile correction.

### MODELLING OF GEAR

In total 15 number of gears are modelled in Pro/ENGINEER Wildfire [6], which are having the following parameters.

Module 5mm; Three set of gears having number of teeth 14,18 and 30; Each set of gear having pitch circle diameter 70mm, 90mm, and 150mm; Radius of circular fillet for each set of gear 0.5mm, 1mm, 1.5mm, 2mm, 2.25mm; Pressure angle 20°; Load at highest point of single tooth contact 100kN; Gear Material  $f_e$  20. The following steps are showing the procedure to model the gear of 18 number of teeth with the combination of the all above mentioned parameters in the Pro/ENGINEER Wildfire, other set of gears are modelled in the similar way.

Part parameters are the basic parameters defining the gear. These part parameters determine all the other parameters that define the gear tooth profile by using the Tools/Relation menu. Figure 2 showing the part parameters.

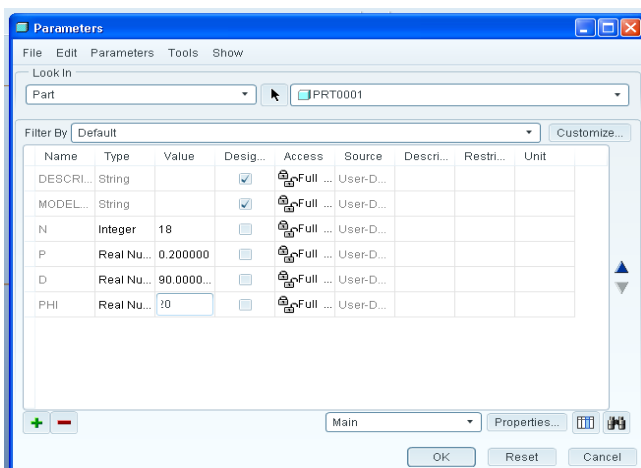

Fig. 2. Part Parameters

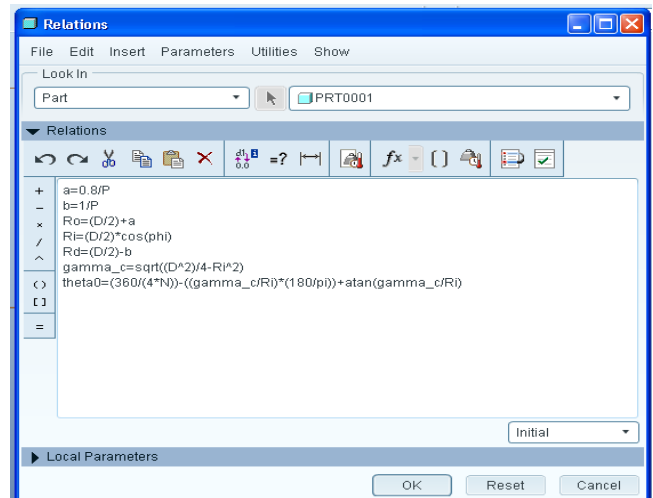

Fig. 3. Tools / Relations menu

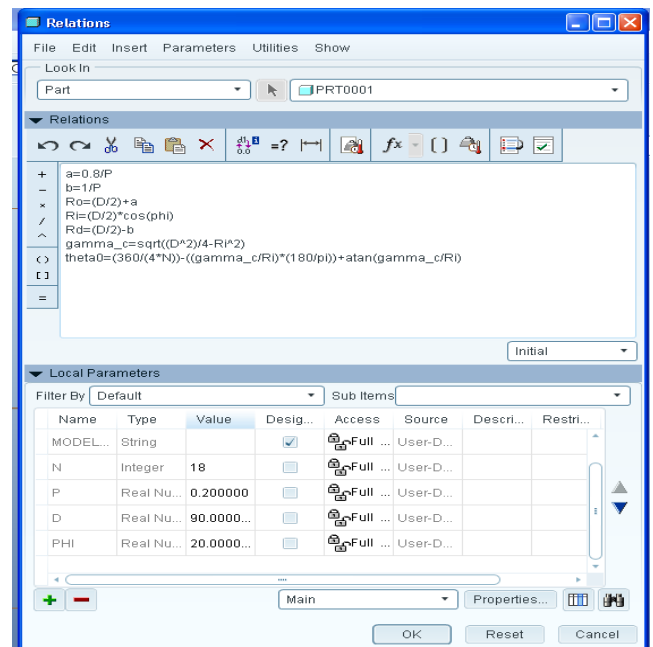

Fig. 4. Part Relations

Drawing the circle centered on the sketch references for the extrusion profile and taking the extrusion depth equals to the thickness of gear. By using the Tools / Relations Menu we define relations between the sketch dimensions and the part parameters. Figure 3 is showing the Tools/ Relations Menu. After defining these relations, the circle should have the diameter equals to the diameter of the addendum diameter of the gear blank. Figure 4 is showing the part relations for getting the addendum diameter and the Figure 5 is showing the gear blank.

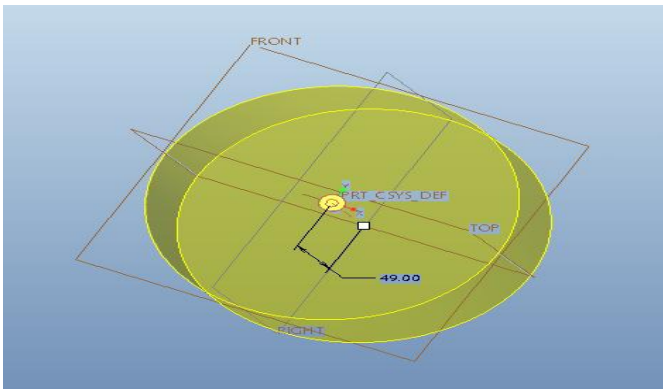

Fig. 5. Gear Blank

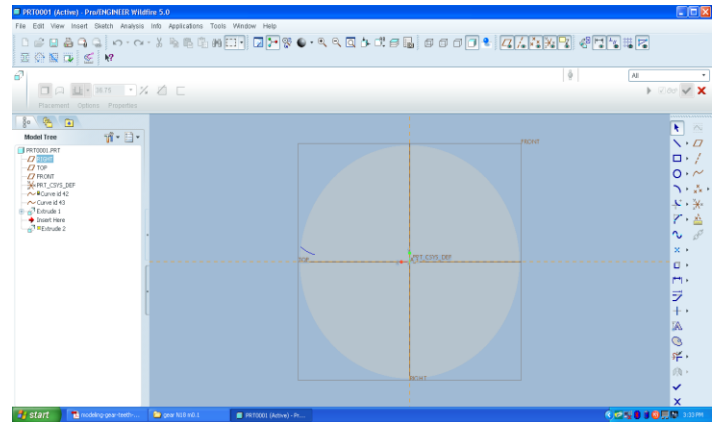

Fig. 7. Involute Profile over the Surface of Gear Blank

Selecting From Equation from the Insert/ Model Datum/ Curve Menu. we take "PRT\_CSYS\_DEF" as a default coordinate system. Taking coordinate system cylindrical type. In this point a Notepad window will pop up where we can enter all equations for the datum curve. As shown in the Figure 6 [7]. The preview after entry of all the parameters will show the involute curve over the gear blank as shown in the Figure 7.

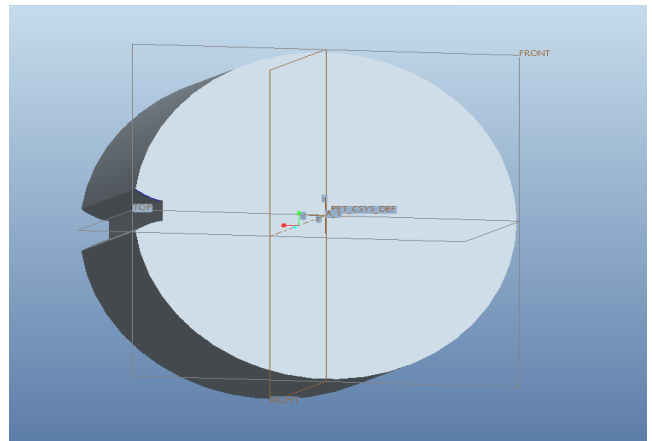

Fig. 8. Gear Blank with Tooth Space

```

rel.ptd - Notepad
File Edit Format View Help
/* For cylindrical coordinate system, enter parametric e
/* in terms of t (which will vary from 0 to 1) for r, th
/* For example: for a circle in x-y plane, centered at o
/* and radius = 4, the parametric equations will be:
/*
/*      r = 4
/*      theta = t * 360
/*      z = 0
/*-----
gamma = sqrt(Ro^2-Ri^2)*t
r = sqrt(gamma^2+Ri^2)
theta = theta0+((gamma/Ri)*(360/(2*pi)))-atan(gamma/Ri)
z = 0
    
```

Fig. 6. Datum Curve Relations

Now we have an involute curve at one side of the gear blank, by mirroring the curve about the axis we get the C shaped profile made up of made up of two involute profiles. In next step going to the Tools/ Relations menu and setting the inner arc to the value of parameter Rd. After extruding the C shaped profile through the whole depth of the gear blank finally we get the space between the two gear teeth. Figure 8 is showing the space between the two gear teeth.

From the newest extruded feature in the model tree and selecting the pattern, in the top dashboard we select the following parameters;

1. Pattern type : Axis pattern
2. Axis for pattern: A\_1 at the centre of the gear.
3. Number of copies: Equals to the number of teeth here 18.  
 Included angle of the pattern: 360°

After accepting the settings we get the involute gear with the desired number of the teeth. As shown in the Figure 9.

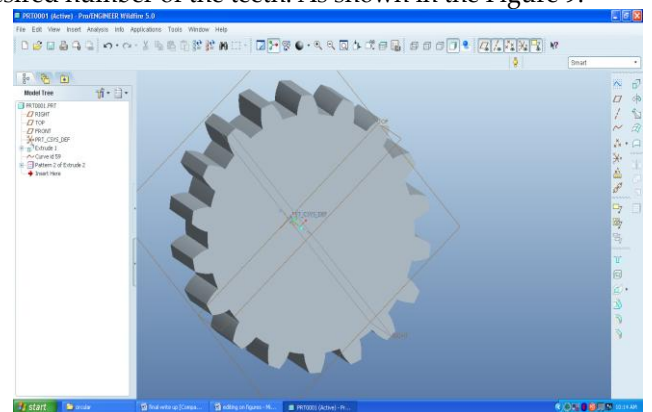

Fig. 9. Gear Model

As per the value of the coordinates calculated from the mathematical model [3], a part having the bottom edges equals to the radius of the circular fillet is cut from the base gear model; as shown in the Figure 10. The subtracted part gives the circular fillet at the root of the gear as shown in the Figure 11.

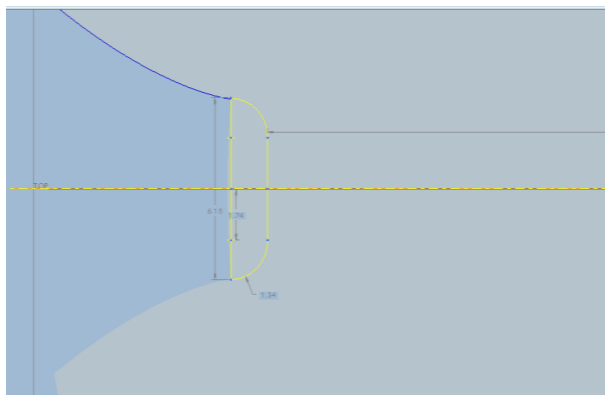

Fig. 10. Circular Fillet

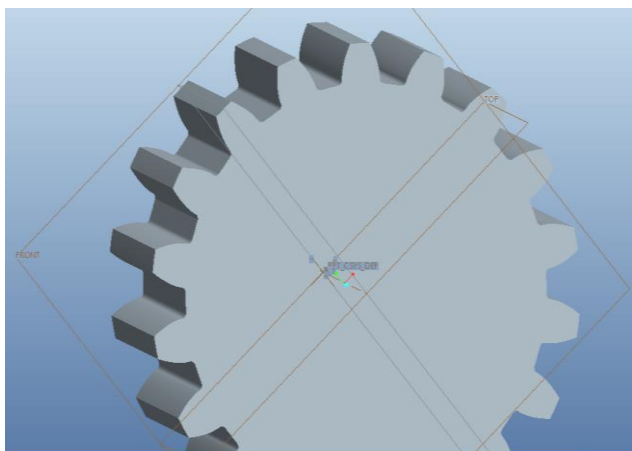

Fig. 11. Gear with circular Fillet

## STRUCTURAL ANALYSIS

The structural analysis of the spur gear tooth model is carried out using the finite element analysis in Pro/Mechanica which is an application of Pro/Engineer [8]. The load applied at the highest point of single tooth contact as shown in the Figure 12. All degree of freedom of the surfaces both side of the tooth being constrained. Figure 13, is showing the displacement constraint. At the Aspect Ratio of 7 the Mess is generated with tetrahedron nodes. Total 38430 elements and 7880 nodes are created. Figure 14, is showing mess generation. Maximum element size of 5 mm is selected for the Mess Control. By applying the analysis over the surface which is facing the load we get the maximum and minimum distortion in the numeric as well as in the form of colour scheme. Figure 15, is showing the element quality check, the highlighted part which is the root of the gear is showing weak part of the gear it also describes the number of poorly shaped elements. Figure 16, showing the finite element analysis in terms of the colour scheme with value of distortion produced due to loading.

## RESULTS AND DISCUSSION

A comparative study has been carried out between the gears of the different number of teeth having different fillet radius.

These teeth are having 14, 18 and 30 numbers of teeth with 0.5mm, 1.0mm, 1.5mm, 2.0mm and 2.25mm fillet radius.

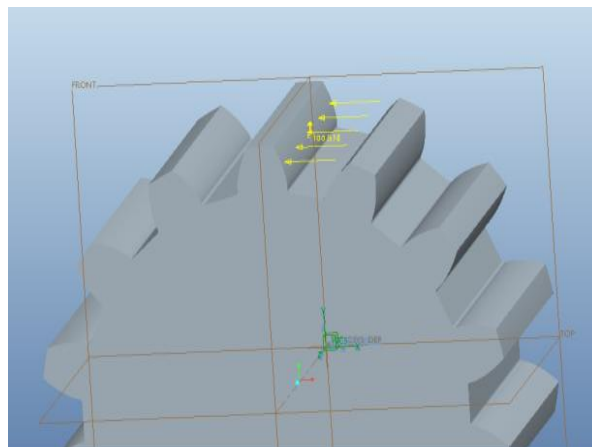

Fig. 12. Loading at HPSTC with 100 kN

The effect of change of fillet radius on the strength of spur gear involute teeth is investigated in Pro/Engineer by taking the load of 100 kN at the highest point of single tooth contact. By keeping all the degree of freedom of the surfaces both side of the tooth constrained and applying the quality checks for the generated mess, we get the list of the poorly shaped elements out of the total generated mess. We get the distortion of the each poorly shaped Tetrahedron Element..

In graph shown in the figure 10, the effect of change in fillet radius to the gears of different number of teeth is investigated; it shows the distortion produced in the gears of 14, 18 and 30 number of teeth. The gears having the lower value of the fillet radius are showing the lesser distortion, on the other hand the gear having the higher value of the fillet radius are showing the greater distortion on the same gear parameters.

Maximum distortion is shown by the gear having the maximum number of the tooth i.e. by the gear of 30 numbers of teeth and minimum distortion is produced in the gear of least number of teeth i.e. in the gear of 14 number of teeth.

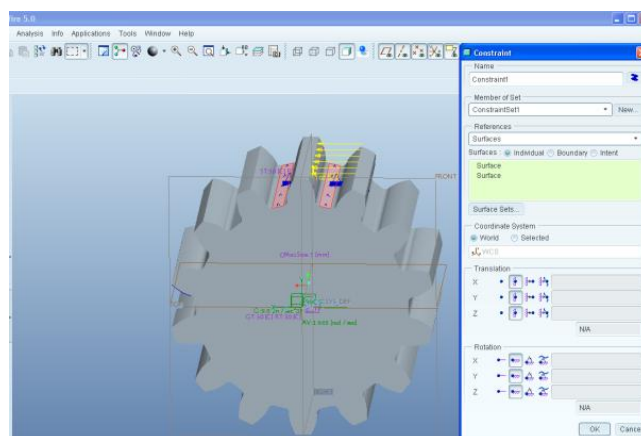

Fig. 13. Displacement Constraint

## CONCLUSION

The effect on the strength of spur involute gear by changing the radius of the circular fillet was investigated. Gears of different parameters but having same module and pressure angle was modelled and the distortion produced in the curvature due to the loading at the highest point of single tooth contact was analysed by using Finite Element Analysis.

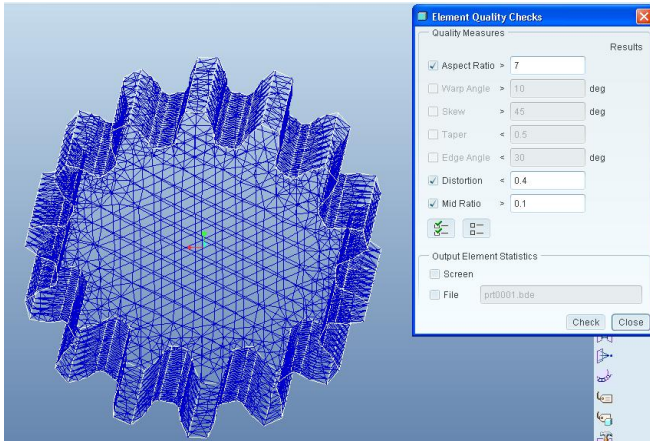

Fig. 14. Mesh Generation

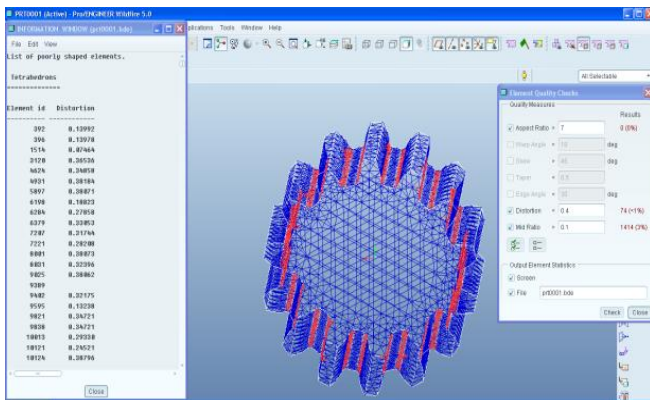

Fig. 15. Element Quality Check

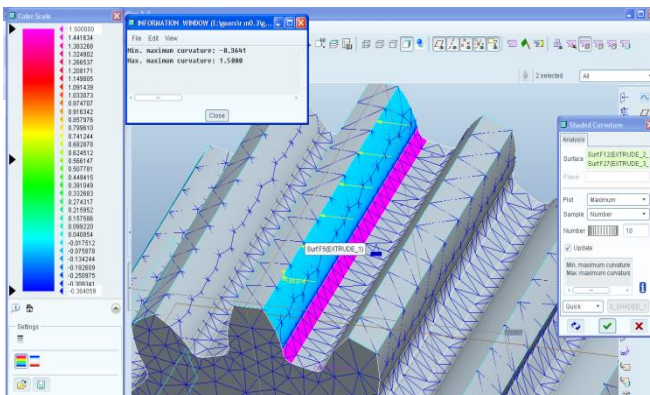

Fig. 16. Finite Element Analysis Result

From the analysis it is concluded that, as the fillet radius increases from 0.5 mm to 1.5 mm the curvature deflection de-

creases and for the fillet radius 1.5 mm to 2.25 it increases with the increase in the fillet radius in the gear of same number of teeth.

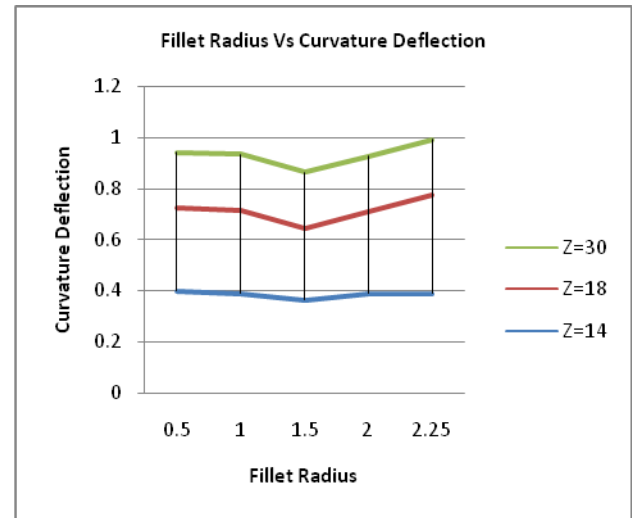

Fig. 17. Graph Fillet radius Vs Curvature Deflection

It is also concluded that, the value of the deflection in the curvature of the gear is more in the gear of more number of teeth. Here the gear of 30 numbers of teeth is showing the more deflection as compared to the gear of 18 numbers of teeth. The gear with 14 numbers of teeth is showing the least deflection in the gear curvature.

All the set of gears showing the least deflection for the fillet radius of the 1.5 mm, hence we can say that the fillet radius of 1.5 mm is the optimum value of the fillet radius for the taken set of the gears. At this value of the fillet radius the gears are stronger then at the other fillet radius.

## REFERENCES

- [1]. V.B. Bhandari, "Design of Machine Elements". pp. 522-575.
- [2]. Christos A. Spitas and Vasilis A. Spitas, "Generating Interchangeable 20° Spur Gear Sets with Circular Fillets to Increase Load Carrying Capacity", International Conference on Gears, Vol. I, VDI – Verlag, Dusseldorf, Germany, July/August 2006, pp. 927-941.
- [3]. V. Spitas, Th. Costopoulos and C. Spitas, "Increasing the Strength of Standard Involute Gear Teeth with Novel Circular Root Fillet Design", American Journal of Applied Sciences, Science Publication 2005, pp. 1058-1064.
- [4]. M.Savage, K.L. Rubadeux and H.H.Coe, "Bending Strength Model for Internal Spur Gear Teeth", Army Research Laboratory, Technical Memorandum San Diego, California, July 10-12, 1995.
- [5]. M. Koilraj, Dr. G.Muthuveerappan, Dr. J. Pattabiraman, "An Improvement in Gear Teeth Methodology Using Finite Element Method", IE Journal MC, Vol.88, October 2007.
- [6]. Pro/ENGINEER Wildfire 5.0
- [7]. Mike Renfro, "Modeling Gear Teeth in Pro/Engineer Wildfire 4.0, 2010.
- [8]. Roger Toogood, "Pro/Mechanica Tutorial". University of Ulberta.