

Title	Effects of Impurity in Aluminum on Diffusion Welding of Aluminum to Titanium(Materials, Metallurgy & Weldability)
Author(s)	Enjo, Toshio; Ikeuchi, Kenji; Horinouchi, Tsutomu
Citation	Transactions of JWRI. 15(1) P.61-P.68
Issue Date	1986-07
Text Version	publisher
URL	http://hdl.handle.net/11094/7714
DOI	
rights	本文データはCiNiiから複製したものである
Note	

Osaka University Knowledge Archive : OUKA

<https://ir.library.osaka-u.ac.jp/>

Osaka University

Effects of Impurity in Aluminum on Diffusion Welding of Aluminum to Titanium †

Toshio ENJO*, Kenji IKEUCHI** and Tsutomu HORINOCHI***

Abstract

The joint strength and the microstructure of the diffusion welding of aluminum to titanium have been investigated using a variety of base metals: commercially pure aluminum 1050 (6×10^{-2} mass%Si), nominally 99.99% (4N) aluminum (2×10^{-3} mass%Si), and aluminum alloys containing 1×10^{-3} to 0.14 mass% Si and 2×10^{-3} to 0.38 mass% Fe. The joint strength of 4N aluminum to titanium, which was much lower than that of 1050 to titanium, was increased significantly by introduction of Si into 4N aluminum by a diffusion treatment prior to the bonding. A marker experiment showed that an intermetallic compound layer consisting of Al_3Ti grew from the bond interface into titanium for joints both with 1050 and with 4N aluminum. When the Si content exceeded 7×10^{-3} mass%, a drastic decrease in the growing rate of this Al_3Ti layer was found, suggesting that Si more than 7×10^{-3} mass% reduced the amount of aluminum diffusing into the Al_3Ti layer. The Fe content, however, had no correlation with the growing rate. The effects of Si on the joint strength and the growth of the Al_3Ti layer can be accounted for by the decrease in the amount of aluminum diffusing into the Al_3Ti layer.

KEY WORDS: (Diffusion Welding) (Titanium) (Aluminum) (Silicon) (Intermetallic Compound) (Diffusion)

1. Introduction

It is well known that the diffusion and plastic flow of metals at high temperatures are influenced strongly by impurities. The diffusion welding, since its process is controlled by the diffusion and plastic flow¹⁾, should also be influenced by the impurity. However, there has been only a little amount of information about the effect of the impurity on the diffusion welding of metals^{2,3)}.

In the present investigation, we have found that joint strength and growth of an intermetallic compound layer in the diffusion welding of aluminum to titanium are influenced remarkably by minor impurity elements in commercially pure aluminum. In order to distinguish the element having such remarkable effects, strength and microstructure of the joint have been investigated using aluminum base metals containing Si and Fe of various contents which are main impurity elements in commercially pure aluminum.

2. Experimental Details

Aluminum base metals used were commercially pure aluminum 1050, nominally 99.99% (4N) aluminum, and specially prepared aluminum alloys (No. 1 ~ 7) with 1×10^{-3} ~ 0.14 mass% Si and 2×10^{-3} ~ 0.38 mass% Fe. Chemical composition of the base metals is shown in Table 1. Rod specimens $\phi 20 \times 37$ mm were cut from the

base metals of 1050 and 4N aluminum for the diffusion welding. Specimens made from base metals No. 1 ~ 7 were thin plates 0.3 mm thick. Titanium specimens were thin plates 0.5 mm thick cut from a cold-rolled commercially pure titanium.

The joint of titanium to 1050 or 4N aluminum was welded in the arrangement as shown in Fig. 1(a). The joint was cut into the shape shown in Fig. 1(b) for tensile test. In the joint of aluminum No. 1 ~ 7 to titanium, the aluminum specimen was set between a couple of titanium specimens, with 1050 specimens being on both sides of the titanium specimens as shown in Fig. 1(c). Since the joint with No. 1 ~ 7 aluminum was very small, the tensile test could not be carried out.

Faying surfaces of 1050 and 4N aluminum specimens were finished to JIS 3S by turning in a lathe, and those of No. 1 ~ 7 specimens were as-rolled surfaces. The faying surface of titanium specimen, on the other hand, were subjected to wire brushing, because a considerably thick oxide film was formed on the as-rolled surface of titanium⁴⁾.

The joint of titanium to 1050 or 4N aluminum in the arrangement shown in Fig. 1(a) was welded using an apparatus as shown in Fig. 2. The bond interface was heated with a radiant resistance heater of molybdenum foil 0.1 mm thick, and welding pressure to the bond interface was applied by a hydraulic press. The welding atmosphere was a vacuum of $1 \sim 5 \times 10^{-2}$ Pa. The temperature

† Received on April 28, 1986

* Professor

** Research Instructor

*** Technical Assistant

Table 1 Chemical composition of aluminum base metals (mass%).

Specimen	Si	Fe	Cu	Mn	Mg	Cr	Zn	Ti	Al
1050	0.06	0.15	<0.01	<0.01	<0.01	<0.01	0.01	<0.01	Bal.
4N	0.002	0.001	0.001	-	-	-	-	-	99.996
1	0.14	0.003	0.001	<0.0005	<0.0005	<0.0005	0.001	<0.0005	99.85
2	0.05	0.38	0.02	<0.01	<0.01	<0.01	0.01	0.02	99.52
3	0.05	0.11	<0.01	<0.01	<0.01	<0.01	0.01	0.01	99.82
4	0.04	0.09	<0.01	<0.01	<0.01	<0.01	0.01	<0.01	99.86
5	0.007	0.005	<0.001	<0.001	<0.001	<0.001	0.003	<0.001	99.988
6	0.002	0.002	0.004	<0.001	<0.001	<0.001	<0.001	<0.001	99.990
7	0.001	0.049	<0.001	<0.001	<0.001	<0.001	0.001	<0.001	99.949

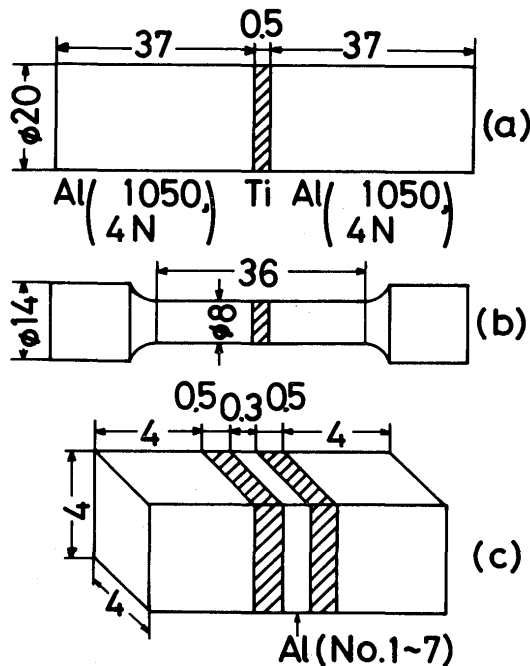

Fig. 1 (a) Dimensions and arrangement of specimens for the diffusion welding of titanium to 1050 or 4N aluminum. (b) Dimensions of a specimen for tensile test prepared from a joint as shown in (a). (c) Dimensions and arrangement of specimens for the diffusion welding of titanium to aluminum No. 1 ~ 7 in Table 1.

of the bond interface was monitored with a C-A thermocouple percussion-welded to the aluminum specimen immediately next to the bond interface. The joint of aluminum No. 1 ~ 7 to titanium as shown in Fig. 1. (c) was welded in a vacuum of $1 \sim 5 \times 10^{-2}$ Pa using a high temperature optical microscope installed with a pressing system.

The bond strength was estimated from tensile strength at a strain rate of $4.6 \times 10^{-4} \text{ s}^{-1}$. The etchant for the observation of microstructure was Keller's reagent, an aqueous solution containing 4 vol% HF and 9 vol% HNO_3 . Observation of fractured surfaces and electron probe microanalysis were carried out using a scanning electron microscope operated at an acceleration voltage of 20 kV.

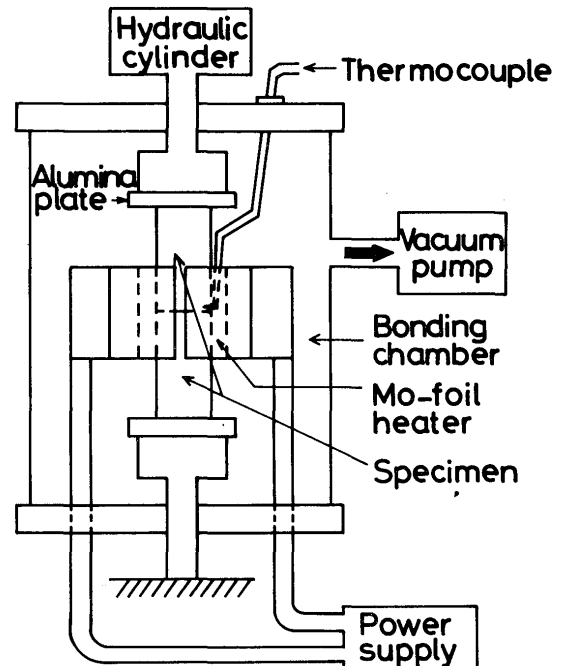

Fig. 2 Schematic diagram illustrating the apparatus for diffusion welding.

3. Results

3.1 Diffusion welding of commercially pure aluminum and nominally 99.99% aluminum to titanium

As shown in Fig. 3, tensile strength of the joint of 1050 to titanium was increased with a rise of welding temperature, and reached a strength not less than that of the base metal at a welding temperature of 923K. For the joint of 4N aluminum to titanium, on the other hand, tensile strength was much lower than that of the joint with 1050, and an increase in welding temperature did not result in an increase in tensile strength as shown in Fig. 4. No joint with 4N aluminum was fractured in the base metal on tensile test.

Thus, impurities in aluminum base metal had a remarkable effect on the bond strength of aluminum to titanium. In order to interpret the mechanism of such

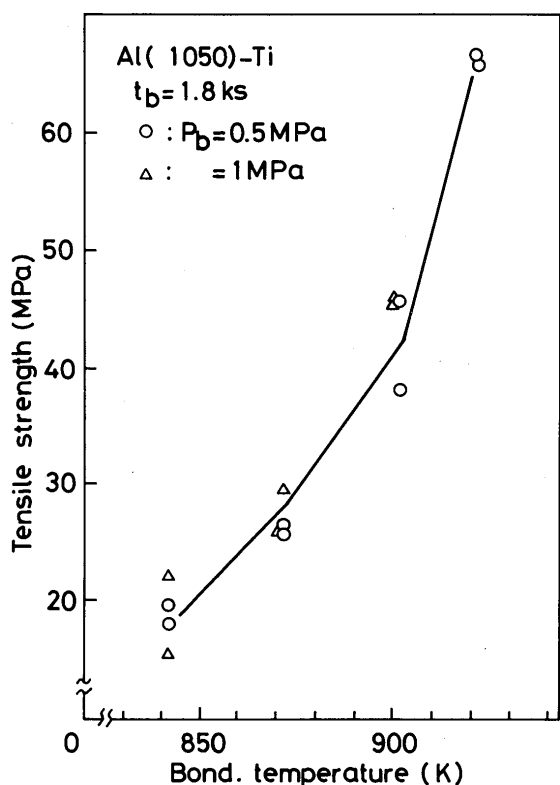

Fig. 3 Tensile strength vs. welding temperature for the diffusion-welded joint of titanium to 1050 at welding pressure P_b of 0.5 MPa and 1 MPa. Welding time t_b was 1.8 ks.

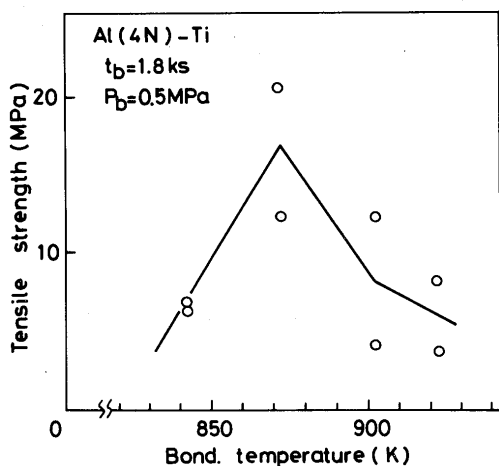

Fig. 4 Tensile strength vs. welding temperature for the diffusion-welded joint of titanium to 4N aluminum.

strong effect, the welding deformation, which played an important part in the intimate contact between faying surfaces, was investigated. The aluminum specimen was deformed by the welding pressure to the shape shown in Fig. 5, while the deformation of titanium specimen was very small. The amount of welding deformation δ is given by

$$\delta (\%) = \frac{1}{2} \left(\frac{d_1 - d_{10}}{d_{10}} + \frac{d_2 - d_{20}}{d_{20}} \right) \times 100, \quad (1)$$

where d_1 and d_2 are maximum diameters of aluminum specimens after the welding, and d_{10} and d_{20} diameters before the welding. Welding deformation for joints of titanium to 1050 and 4N aluminum is shown in Figs. 6 and 7, respectively. The welding deformation of 4N aluminum was much larger than that of 1050 at any welding temperature and pressure employed. Therefore, the impurity effect on the bond strength as shown in Figs. 3 and 4 cannot be accounted for by the difference in the plastic flow of aluminum base metals.

Figures 8(a) and (b), on the other hand, show the effect of impurities in aluminum base metal on the microstructure of joints. An intermetallic compound layer was

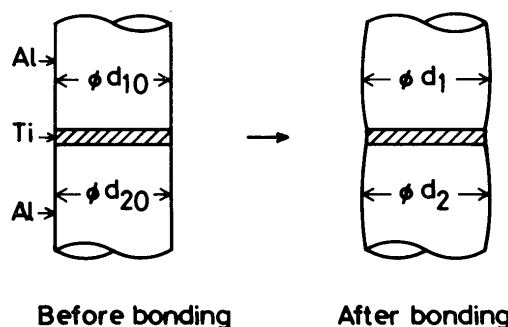

Fig. 5 Schematic diagram illustrating the deformation of aluminum specimen occurring during the diffusion welding.

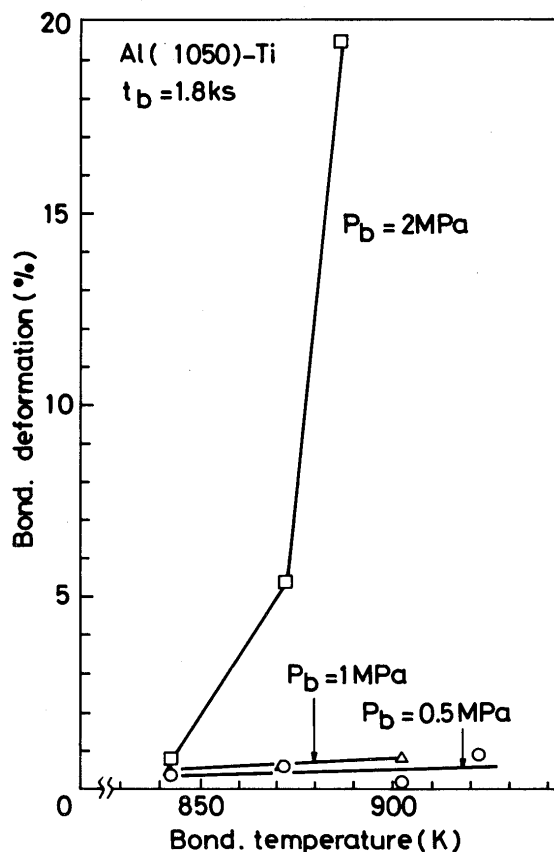

Fig. 6 Deformation of aluminum specimen δ (%) vs. welding temperature for the diffusion-welded joint of titanium to 1050.

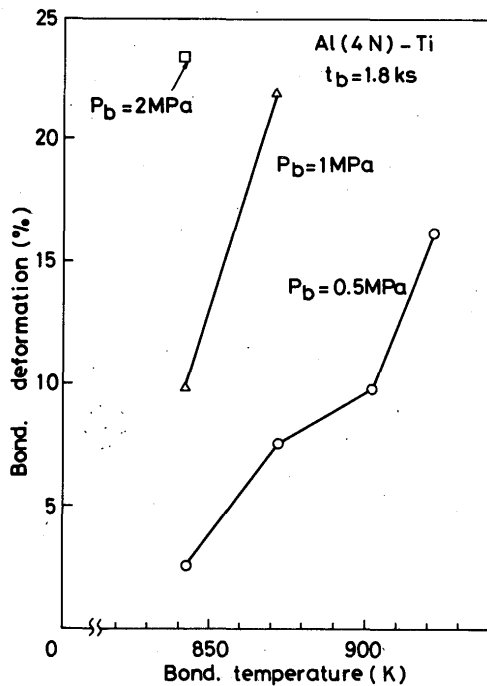

Fig. 7 Deformation of aluminum specimen δ (%) vs. welding temperature for the diffusion-welded joint of titanium to 4N aluminum.

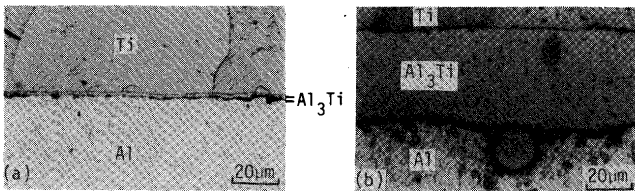

Fig. 8 Microstructures of joints of titanium to 1050 (a) and to 4N aluminum (b). Welding temperature T_b for the joints was 923 K, welding pressure P_b 0.5 MPa, and welding time t_b 1.8 ks.

observed both in the joint with 1050 and in the joint with 4N aluminum. As shown in Fig. 8, the thickness of the intermetallic compound layer was much larger in the joint with 4N aluminum than in the joint with 1050. This indicates that the amount of diffusion across the bond interface is much larger in the joint with 4N aluminum. As shown in Fig. 8(b), a marker of tungsten wire 20 μ m thick was inserted between faying surfaces in order to discern the bond interface of 4N aluminum to titanium*. The intermetallic compound layer, since forming on the titanium side of the marker, can be considered to grow from the bond interface to titanium. In order for the intermetallic compound layer to grow in this direction, aluminum atoms must be supplied to the interface of titanium and intermetallic compound layer through diffu-

* Since the flow stress of aluminum was much lower than that of titanium at the welding temperature of 923K, the marker was immediately pressed into the aluminum specimen by welding pressure. Therefore, the bond interface may be regarded as contacting with the titanium side surface of the marker.

sion. Therefore, the remarkable difference in the thickness of the intermetallic compound layer between 1050 and 4N aluminum indicates that the amount of aluminum diffused into the intermetallic compound layer is much larger from 4N aluminum than from 1050.

It has been suggested by many authors^{1,5,6,7)} that when an intermetallic compound layer forming at a bond interface is very brittle, the joint strength decreases with an increase in its thickness. If such is the case, the joint will be fractured in the intermetallic compound layer. As shown in Fig. 9, however, the joint of 4N aluminum to titanium was not fractured in the intermetallic compound layer, but at the interface of the intermetallic compound layer and aluminum, i.e., at the bond interface. Therefore, the effect of impurities on the bond strength of aluminum to titanium cannot be accounted for by the difference in the thickness of the intermetallic compound layer.

In order to identify the intermetallic compound formed at the bond interface, X-ray diffraction patterns were taken from fractured surfaces of joints broken at the bond interface on tensile test. It can be seen from Figs. 10 and 11 that only diffraction lines from Al_3Ti were observed except for those from aluminum and titanium. This result indicates the intermetallic compound layer to consist of Al_3Ti both in the joint with 1050 and in the joint with 4N aluminum. As seen from Figs. 10 and 11, the diffraction lines from Al_3Ti were observed only on fractured surfaces of titanium side, supporting that the fracture did not occur in the intermetallic compound layer as suggested by Fig. 9.

Fractured surfaces of a joint of 1050 to titanium are shown in Figs. 12(a) and (b). As shown in these figures, dimple-like patterns were observed on fractured surfaces of both titanium side and aluminum side. At places where

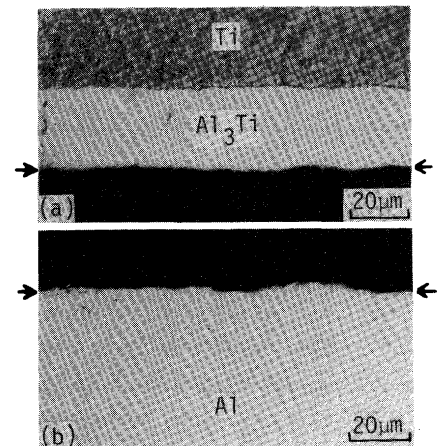

Fig. 9 Cross-sectional microstructures of a fractured zone in a joint of titanium to 4N aluminum fractured at the bond interface on tensile test: (a) titanium side and (b) aluminum side ($T_b = 923$ K, $P_b = 0.5$ MPa and $t_b = 1.8$ ks). The arrows on both sides of the photographs indicate the fractured surfaces.

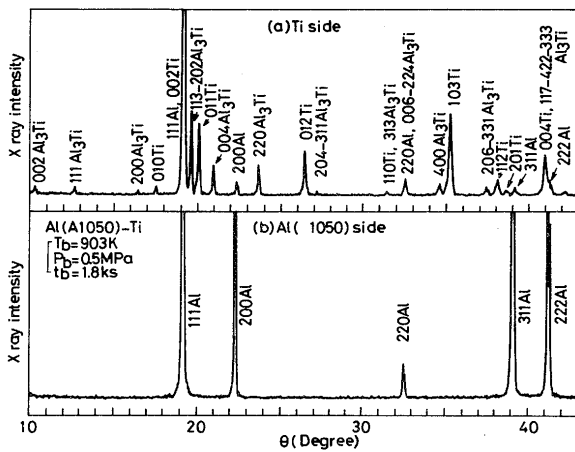

Fig. 10 X-ray diffraction patterns from fractured surfaces of a joint of titanium to 1050: (a) titanium side and (b) aluminum side.

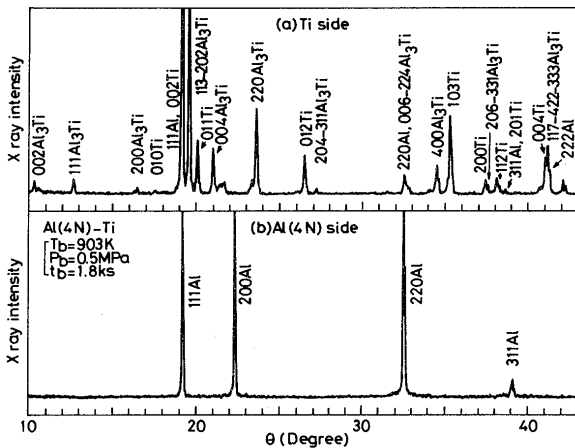

Fig. 11 X-ray diffraction patterns from fractured surfaces of a joint of titanium to 4N aluminum: (a) titanium side and (b) aluminum side.

dimple-like patterns were observed, the distribution curve of aluminum increased significantly as shown in Fig.12(b). Therefore, the place showing dimple-patterns may be regarded as a place where fracture occurred in aluminum. At places where a dimple-like pattern was not observed, on the other hand, fracture may be considered to occur at the bond interface, since grooves caused by turning of the faying surface were observed at these places as shown in Fig. 12(a).

In contrast to this, for the joint of 4N aluminum to titanium, many concaves were observed on the fractured surface of aluminum side as shown in Fig. 13(a). The concave increased in number and volume with a rise of welding temperature as seen from Fig. 13(b). The fractured surface of titanium side obtained from the same joint as that shown in Fig. 13(b) is shown in Fig. 13(c). From the comparison of these fractured surfaces, it can be seen that the concave shown in Figs. 13(a) and (b) is a void. The formation of the void is thought to cause the decrease in the bond strength of 4N aluminum to titanium. The increase in void number and volume with a rise

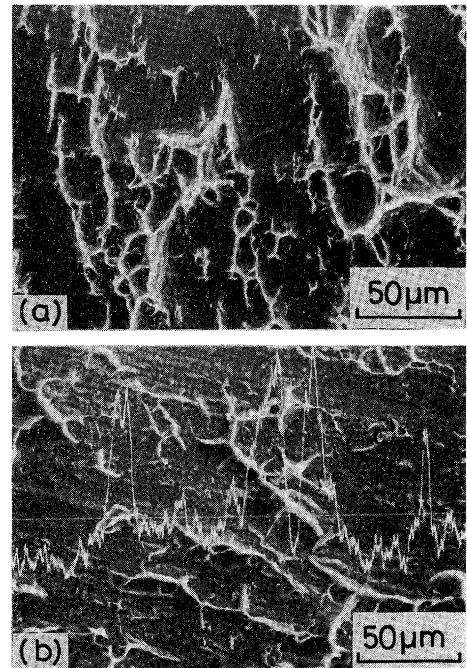

Fig. 12 Fractured surfaces of a joint of titanium to 1050 ($T_b = 903\text{K}$, $P_b = 0.5\text{ MPa}$ and $t_b = 1.8\text{ ks}$): (a) aluminum side and (b) titanium side. Intensity of the characteristic X-ray of aluminum ($K\alpha$) analyzed with EDX along the line A-A' is also shown in (b).

in welding temperature as seen from Figs. 13(a) and (b) probably suppressed the increase in bond strength, and for this reason a rise of welding temperature did not result in an increase in the bond strength as shown in Fig. 4.

3.2 Effects of Si and Fe on the growth of the intermetallic compound layer

In order to distinguish the impurity element having such strong effects on the bond strength and growth of the intermetallic compound layer as those shown in Figs. 3, 4 and 8, the microstructure of the bond interface was investigated using aluminum base metals No. 1 ~ 7 containing Si and Fe of various contents. The mean thickness of the intermetallic compound layer, which was estimated from the thickness measured at more than 20 points at an interval of $100\ \mu\text{m}$, is shown in Fig. 14 as a function of Si content. The error bar indicates the maximum and minimum thickness measured. As shown in Fig. 14, a sharp decrease in the thickness of the intermetallic compound layer was observed at Si contents of $2 \sim 7 \times 10^{-3}\text{ mass\%}$. On the other hand, no systematic dependence of the thickness on Fe content could be observed; i.e., the base metals which had thicker intermetallic compound layer were 4N aluminum with 0.001% Fe, No. 6 with 0.002% Fe and No. 7 with 0.049% Fe, but the base metals No. 1 and No. 5 with Fe contents between those of No. 6 and No. 7 had thinner intermetallic compound layer.

In order to obtain more direct evidence for the effect of Si on the growth of the intermetallic compound layer, Si was introduced into 4N aluminum by a diffusion treatment prior to the welding; a couple of 4N aluminum

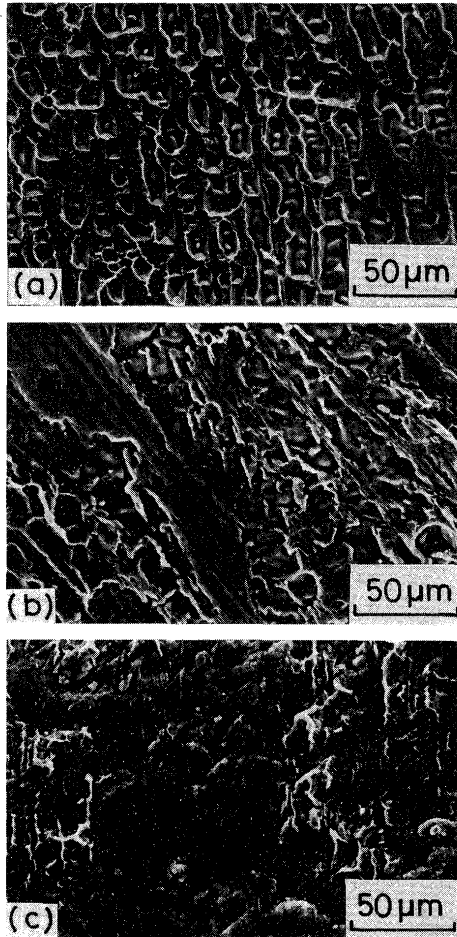

Fig. 13 Fractured surfaces of joints of titanium to 4N aluminum welded at 873K and 903K ($P_b = 0.5$ MPa, $t_b = 1.8$ ks): (a) aluminum side of the joint welded at 873K, (b) aluminum side and (c) titanium side of the joint welded at 903K.

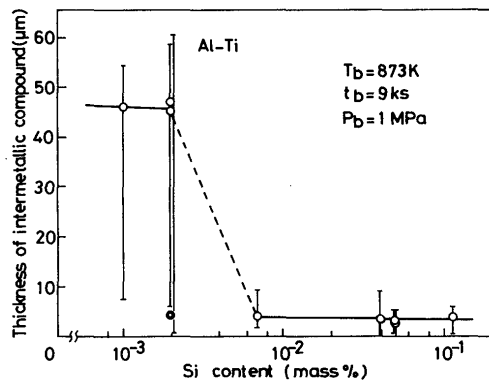

Fig. 14 Thickness of the intermetallic compound layer vs. Si content in aluminum for the diffusion welding of titanium to aluminum. When Si was introduced into the 4N aluminum, the thickness decreased to about 4 μm as shown by the mark ©.

specimens contacting with an Al-10% Si alloy plate (Fe content less than 0.001 mass%) was held at a high temperature to introduce Si from the Al-Si alloy by diffusion. The holding temperature was 883K, the holding time 7.2 ks, and the pressure to the contact interface 2 MPa. Under these conditions, the bond strength between 4N aluminum and Al-Si alloy plate was very small, and so the Al-Si alloy plate could be easily taken off from the 4N aluminum specimen. The holding was carried out in a vacuum by using the welding apparatus shown in Fig. 2. As shown in Fig. 14, the thickness of the intermetallic compound layer was reduced remarkably by the introduction of Si into 4N aluminum. The introduction of Si into 4N aluminum also increased the bond strength at a welding temperature of 923K to 34 ~ 36 MPa as compared with 4 ~ 9 MPa without the introduction of Si (see Fig. 4).

From these results, it can be concluded that Si is the impurity element which exerts such strong effects on the bond strength and growth of the intermetallic compound layer as those shown in Figs. 3, 4 and 8. The distribution of Si across the bond interface was investigated by using electron probe microanalysis for a joint of titanium to aluminum No. 1 with the highest Si content. As seen from Fig. 15, the distribution curve of Si had a peak in the intermetallic compound layer which was characterized by the step in the distribution curve of Al; that is, Si was concentrated in the intermetallic compound layer. It seems likely that the Si concentrated in the intermetallic compound layer decreases the growing rate of the intermetallic compound layer.

4. Discussion

As described in the preceding section, Si in aluminum was concentrated in the intermetallic compound layer, and decreased its growing rate. The growing direction of the intermetallic compound layer (see Fig. 8(b)) suggests

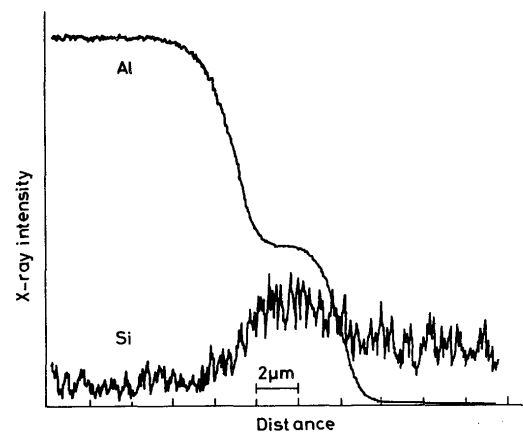

Fig. 15 Electron probe microanalysis of Si and Al for a joint of titanium to aluminum No. 1 in Table 1 ($T_b = 873$ K, $P_b = 1$ MPa and $t_b = 9$ ks).

that the decrease in the growing rate is caused by the decrease in the amount of aluminum supplied to the interface of the intermetallic compound layer and titanium.

When the growing rate of an intermetallic compound layer is controlled by the diffusion in the intermetallic compound layer and base metals, its thickness increases in proportion to square root of time⁸⁾. In a diffusion couple or joint of aluminum (including 1050 and 4N aluminum) to titanium, however, the intermetallic compound layer has been reported to increase proportionately with time^{9,10,11)}. van Loo and Rieck¹¹⁾ have interpreted this growing kinetics in terms of the rate-controlling process of the growth of the intermetallic compound layer; that is, they have suggested that the growth of the intermetallic compound layer is controlled by the flow rate of aluminum across the interface of the intermetallic compound layer and aluminum. **Figure 16** shows an example of growing kinetics of the intermetallic compound layer in a joint of 4N aluminum to titanium. The thickness of the intermetallic compound layer was nearly proportional to time, though the thickness scattered considerably depending on position. At places where the thickness was small, the growth of the intermetallic compound layer which initially obeyed the kinetics shown in Fig. 16 was saturated for a short time. The saturation of the growth is probably due to the formation of voids shown in Figs. 13(a) and (b). These results indicate that the growth of the intermetallic compound layer in the joint with 4N aluminum is controlled by a same process as that in the joint with 1050. Therefore, the decrease in the growing rate of the intermetallic compound layer with a rise of Si content can be accounted for by a decrease in the flow rate of aluminum into the intermetallic compound layer at the interface of the intermetallic compound layer and aluminum. It seems likely that Si concentrated in the intermetallic compound layer as shown in Fig. 15 has the effect of decreasing the flow rate of aluminum into the interme-

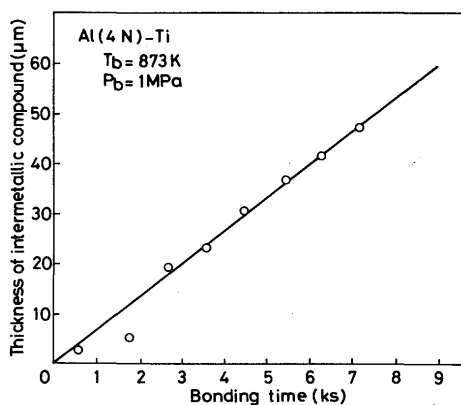

Fig. 16 Thickness of the intermetallic compound layer vs. welding time for the diffusion welding of titanium to 4N aluminum ($T_b = 873\text{K}$, $P_b = 1\text{MPa}$).

tallic compound layer.

On the other hand, it is thought that the bond strength is influenced strongly by the formation of voids observed on the fractured surface of aluminum side (see Figs. 13(a) and (b)). van Loo and Rieck¹¹⁾ suggested that in the binary system of aluminum and titanium the diffusion rate of aluminum is much higher than that of titanium. The result of the marker experiment shown in Fig. 8 suggests that the amount of aluminum diffusing into the intermetallic compound layer is much greater in the joint with 4N aluminum than in the joint with 1050. Therefore, if voids due to the Kirkendall effect are formed in the joint of aluminum to titanium, their formation site will be in aluminum, and their number and/or volume will be much more in the joint with 4N aluminum. Such formation site of the Kirkendall void and the dependence of its number and volume on the purity of the aluminum base metal agree quite well with those of the void shown in Fig. 13(a) and (b). This fact suggests that the void observed on the fractured surface of aluminum side is probably due to the Kirkendall effect. The increase in number and volume of voids with a rise of welding temperature (see Figs. 13(a) and (b)) can also be accounted for by the formation due to the Kirkendall effect. These results suggest that the formation of voids due to the Kirkendall effect decreases the bond strength of the joint of 4N aluminum to titanium.

5. Conclusions

An investigation has been made of effects of impurities in aluminum on the bond strength and growth of intermetallic compound layer in the diffusion welding of aluminum to titanium. Results obtained are summarized as follows:

- 1) The bond strength of the joint of 4N aluminum to titanium was much lower than that of 1050, and could not be increased by a rise of welding temperature.
- 2) An intermetallic compound layer consisting of Al_3Ti was formed both in the joint with 4N aluminum and in the joint with 1050. The thickness of the intermetallic compound layer was much larger in the joint with 4N aluminum.
- 3) The thickness of the intermetallic compound layer depended on Si content of aluminum base metal; a sharp decrease in the thickness was observed at Si contents of $2 \sim 7 \times 10^{-3}\text{mass\%}$. An introduction of Si into 4N aluminum by a diffusion treatment before the welding decreased the thickness of the intermetallic compound layer and increased the bond strength. Therefore, Si can be regarded as the impurity element which exerts such strong effects on the thickness of the intermetallic compound layer and bond strength as

described in (1) and (2).

- 4) A number of voids which can be ascribed to the Kirkendall effect were observed on the fractured surface of aluminum side for the joint of 4N aluminum to titanium. The number and volume of the void increased with a rise of welding temperature. Such voids, however, could not be observed in the joint of 1050 to titanium. It can be accounted for by the formation of the void that the bond strength of the joint of 4N aluminum to titanium was much lower than that of 1050.

Reference

- 1) M.M. Schwartz: *Modern Metal Joining Techniques*, John Wiley & Sons, (1969), 370.
- 2) T. Enjo and K. Ikeuchi: *Suiyokwaishi*, **19** (1983), 763.
- 3) K. Terai, S. Matsuda, H. Nagai and T. Yamada: *Trans. JWS*, **5** (1974), 14.
- 4) Y. Moriguchi: Private commu.
- 5) T. Enjo, K. Ikeuchi and N. Akikawa: *Trans. JWRI*, **8** (1979), 77.
- 6) G.K. Kharchenko: *Avt. Svarka*, **4** (1969), 29.
- 7) T. Enjo, M. Oouchi, S. Nasu, K. Ikeuchi and Y. Arata: *Trans. JWRI*, **6** (1977), 131.
- 8) S. Tsuji: *Trans. JIM*, **14** (1973), 377.
- 9) T. Enjo, K. Ikeuchi, M. Kanai and T. Maruyama: *Trans. JWRI*, **6** (1977), 123.
- 10) T. Enjo, K. Ikeuchi and N. Akikawa: *J. Japan Weld. Soc.*, **50** (1981), 977 (in Japanese).
- 11) J.J. van Loo and G.D. Rieck: *Acta Metall.*, **21** (1973), 61.