

Journal of Reinforced Plastics and Composites

<http://jrp.sagepub.com>

Effects of Material and Test Parameters on the Wear Behavior of Particulate Filled Composites Part 1: SiC-Epoxy and Gr-Epoxy Composites

M.S. Bhagyashekar and R.M.V.G.K. Rao

Journal of Reinforced Plastics and Composites 2007; 26; 1753

DOI: 10.1177/0731684407079523

The online version of this article can be found at:
<http://jrp.sagepub.com/cgi/content/abstract/26/17/1753>

Published by:



<http://www.sagepublications.com>

Additional services and information for *Journal of Reinforced Plastics and Composites* can be found at:

Email Alerts: <http://jrp.sagepub.com/cgi/alerts>

Subscriptions: <http://jrp.sagepub.com/subscriptions>

Reprints: <http://www.sagepub.com/journalsReprints.nav>

Permissions: <http://www.sagepub.co.uk/journalsPermissions.nav>

Citations <http://jrp.sagepub.com/cgi/content/refs/26/17/1753>

Effects of Material and Test Parameters on the Wear Behavior of Particulate Filled Composites Part 1: SiC-Epoxy and Gr-Epoxy Composites

M. S. BHAGYASHEKAR

*Dept of Mechanical Engineering
Ghousia College of Engineering, Ramanagaram - 571 511, India*

R. M. V. G. K. RAO*

*Fibre Reinforced Plastics Division, National Aerospace Laboratories
Bangalore - 560 017, India*

ABSTRACT: Studies were carried out on a (RT) cure epoxy (LY556 + HY951) composite system comprising of silicon carbide (SiC) and graphite (Gr) particulates. Results showed that the wear resistance and coefficient of friction of both the composites increased with sliding distance and contact load (contact pressure) for the range of filler contents (5–40% wt) considered. The Gr-composite exhibited its distinct (superior) tribological feature compared to the SiC-composite. A wear endurance index has been identified from the experimental data, to serve as a parameter to assess the long term wear life (residual wear life) of these composites.

KEY WORDS: polymer composite, particulate fillers, SiC-epoxy, Gr-epoxy, wear behavior.

INTRODUCTION

POLYMER MATRIX COMPOSITES are a special class of modern materials finding numerous applications [1]. Based on the reinforcement geometry, they are broadly classified as high aspect ratio-fiber reinforced composites and low aspect ratio particulate filled composites. Of these, the latter form a distinct class of composites, exhibiting unique properties [2] that have opened up several new areas of industrial applications. For this class of composites the thermoset polymers are the preferred matrix materials [3], with Diglycidyl of bisphenol A (DGEBA) type epoxy resin being the most widely used work horse matrix for innumerable applications, owing to its well balanced chemical, adhesive, thermal and processing characteristics. However, the high coefficient of linear expansion, low thermal conductivity and limited mechanical properties of epoxies limit their use in tribological applications. Nonetheless, the incorporation of low aspect ratio fillers [4] in these matrix systems improves several properties such as flexural modulus, dimensional stability, heat deflection temperature [5–7] and wear resistance [8].

*Author to whom correspondence should be addressed. E-mail: rmvgk@yahoo.com

The literature survey carried out revealed only a few studies on the tribological behavior of epoxy composites filled with either SiC or Gr particulates. Xiubing Li et al. [9], in their studies on Gr-Epoxy (up to 50 vol.% Gr.) using a ring on block wear tester at a constant speed and load condition, showed that increasing graphite content reduced the wear volume loss as well as the coefficient of friction in the composite. Durand et al. [10], in their studies on SiC-Epoxy by varying SiC up to 40 vol.%, described the effect of size and type of the ceramic filler on wear resistance of the composites. They conducted the test at a constant speed and load using a pin on disc test set up, but with the composite specimen serving as the disc and a steel ball as its counter surface. However, several other reports [11–18] show studies on epoxy composites filled with hybrid fillers, mainly constituting a few or many combinations of both organic and inorganic fillers.

The studies presented herein are for epoxy resin, filled with a highly abrasive type SiC in one case, and self-lubricating type Gr filler in another case. Further the studies carried out using a standard pin on disc apparatus encompassed an extensive array of compositional (% filler loading) and test (sliding distance, load) parameters; in order to clearly bring out their distinct effects on the material response parameters characterizing the tribological behavior of the two class of composites considered.

EXPERIMENTAL DETAILS

Materials

The host matrix used is a bifunctional RT-cure epoxy resin system (LY556/HY 951 of M/S Ciba-Geigy), and the particulate fillers used are 320-mesh SiC (of M/s. Gransilica, Bangalore) and Graphite (of M/s. Graphite India, Bangalore).

Specimen Preparation and Characterization

The fillers were preheated to remove any moisture present and cooled to ambient temperature. The required quantities of the filler were stirred gently into the liquid epoxy resin, taking care to avoid the introduction of air bubbles. The mixture was later placed in a vacuum chamber for about one hour to remove any entrapped air, and then the amine-hardener was added to the above mixture in the ratio of ten parts per 100 g resin, and stirred to ensure complete mixing. The mixture was then poured into a metallic mold coated with a release agent to yield specimens of 25 mm height and 10 mm diameter, upon curing and release from the mold after 24 hours. These wear test specimens were then post cured at 50°C for 30 min/70°C for 60 min/85°C for 120 min.

Composition of test specimens of both type of composites was varied up to 40% by weight of filler loading at intervals of 5%. Extreme care was taken to pre-empt any undesirable filler settling effect by casting the slurry just prior to its gelling stage, all the time keeping it in a stirred condition. This was done to ensure the uniform composition of the cast specimens across its volume.

Wear Test Procedure

The schematic of pin on disc apparatus (M/s. Ducom, Bangalore) used in these studies is shown in Figure 1. As shown in the figure, the composite specimen was mounted in the holder located on a loading lever arm and the normal load applied, using standard

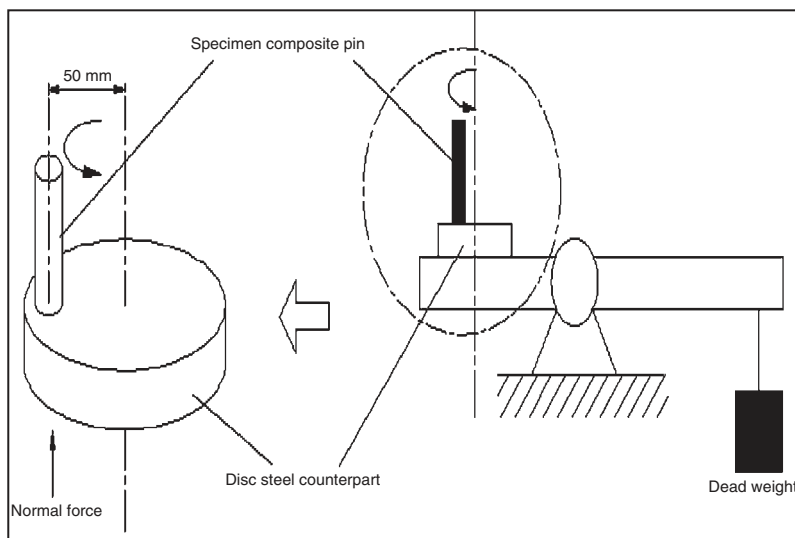

Figure 1. A schematic diagram of the pin on disc wear test apparatus.

weights (10 N, 20 N & 30 N in these experiments) to simulate different contact pressures. The C 60 disc was then set to a given rpm (200 rpm) and the tests run for different lengths of time to realise different sliding distances. The height loss and the tangential force experienced by the specimens as functions of compositional (filler contents) and test (normal load and sliding distance) parameters were digitally recorded. The results were tabulated, plotted and discussed in subsequent sections.

RESULTS AND DISCUSSION

In this section the results on the effects of filler loading (compositional parameter) are presented, as well as the sliding distance and load or contact pressure (test parameters) on the tribological response (wear loss, specific wear loss and coefficient of friction) of the SiC-Ep and Gr-Ep composites.

Effect of Test Parameters on Wear Loss of Unfilled Epoxy

Figure 2 shows the wear (Volume) loss of the unfilled epoxy casting as a function of sliding distance under three different applied loads viz, 10 N, 20 N and 30 N (contact pressures 127 KPa, 254 KPa and 381 KPa). It can be seen that the wear loss increases with the sliding distance and increases more as the contact pressure is increased. This is due to disintegration of the test specimen surface, by formation of microcracks, microcutting and microploughing [19] as it is sheared and ploughed through [20], as a result of the frictional force exerted by the disc material.

From the above figure, the dependency of wear loss (W_d) on the sliding distance (D_s) for the three loads considered can be represented by the following equations:

$$W_{10} = 0.0031 D_s + 5.055 \quad (1)$$

$$W_{I20} = 0.0051 D_s + 4.635 \tag{2}$$

$$W_{I30} = 0.0053 D_s + 5.319. \tag{3}$$

Further, it can be seen from these equations that the wear loss rate while being higher for higher loads in general, remains less prominently so at higher loads (20 N and 30 N), as reflected in the slopes of the above equations.

Effect of Filler Loading on Wear Loss of Filled Epoxy Composites

The effects of filler loading at different sliding distances and loads for SiC and Gr composites are shown in Figures 3–8.

In general, a notable feature of all these figures is that there is an initial sudden drop in wear loss up to around 5% filler loading, followed by a very gradual wear loss thereafter for all the cases in both the composites. This indicates a kind of “wear stabilization phenomenon”, clearly pointing to a less than proportionate effectiveness of the filler loading beyond this threshold value (5%). Figures 6–8 in particular clearly bring out the

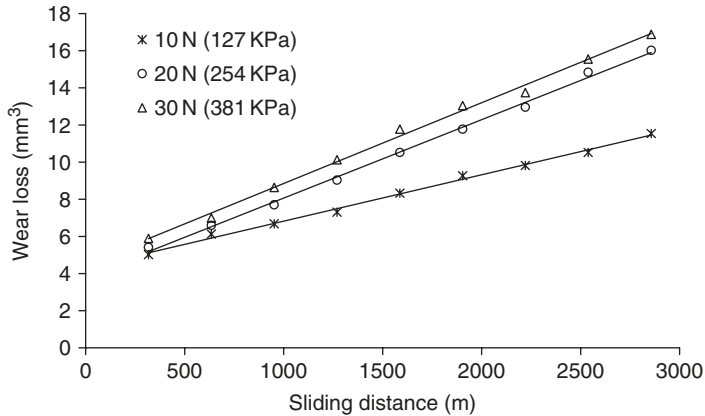

Figure 2. Effect of sliding distance and contact load on wear loss of unfilled epoxy.

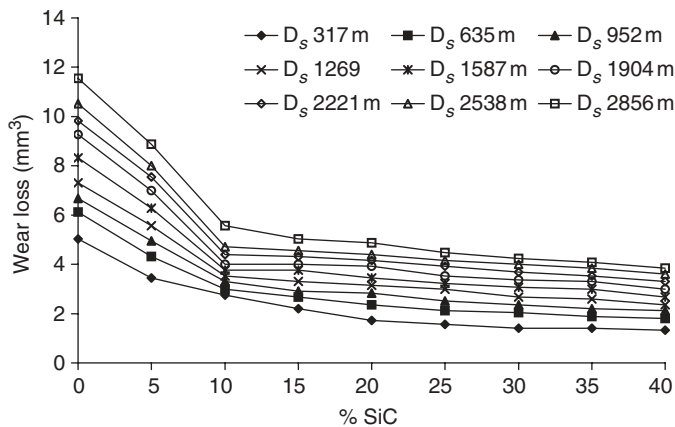

Figure 3. Effects of % filler and sliding distance (D_s) on the wear loss of SiC-Ep composites contact load 10 N (127 KPa).

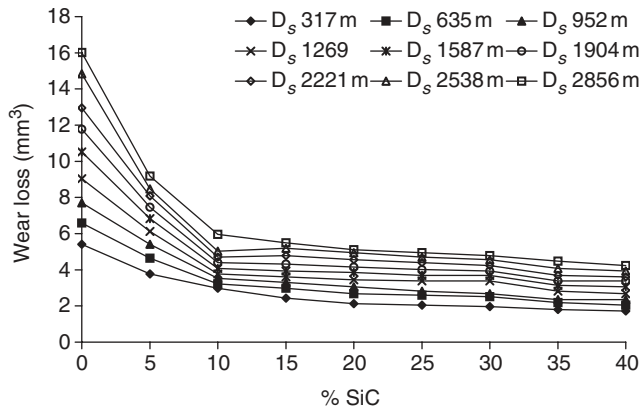

Figure 4. Effects of % filler and sliding distance (D_s) on the wear loss of SiC-Ep composites contact load 20 N (254 KPa).

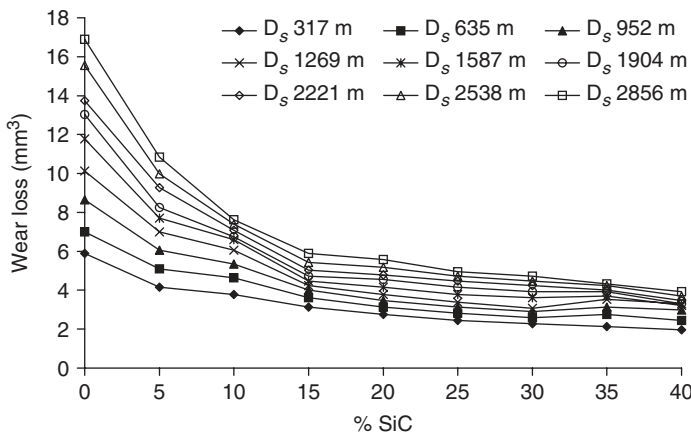

Figure 5. Effects of % filler and sliding distance (D_s) on the wear loss of SiC-Ep composites contact load 30 N (381 KPa).

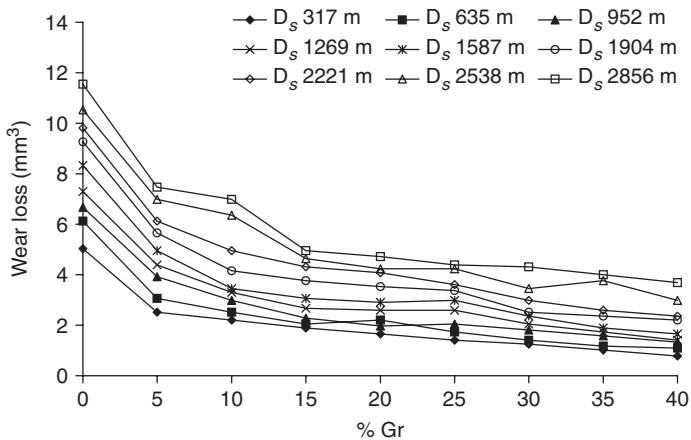

Figure 6. Effects of % filler and sliding distance (D_s) on the wear loss of Gr-Ep composites contact load 10 N (127 KPa).

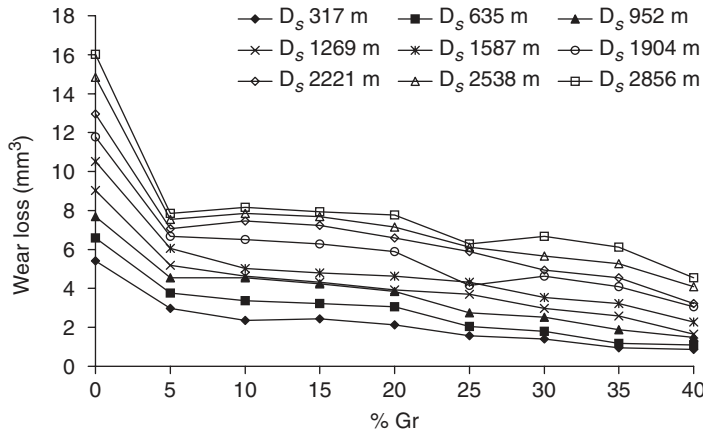

Figure 7. Effects of % filler and sliding distance (D_s) on the wear loss of Gr-Ep composites contact load 20 N (254 KPa).

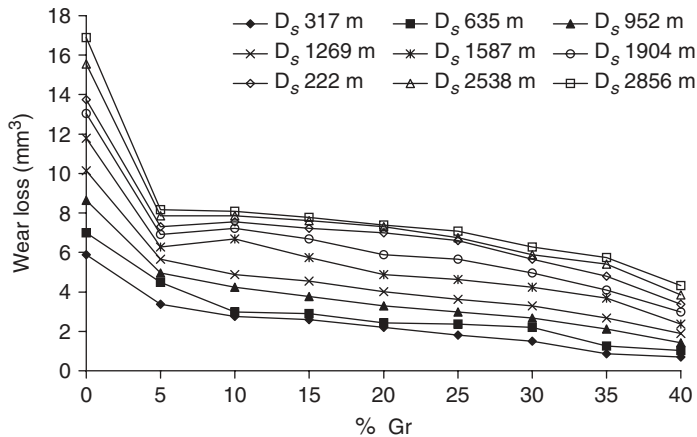

Figure 8. Effects of % filler and sliding distance (D_s) on the wear loss of Gr-Ep composites contact load 30 N (381 KPa).

overall superior wear resistance (or lower wear loss) characteristic of the Gr-Ep composites compared to the SiC-Ep composites (Figures 3–5). Table 1 presents a summary of the tribological characteristics of the SiC-Ep and Gr-Ep composites, considering the extreme wear test conditions.

The table reflects in general the lower wear loss characteristics exhibited by the Gr-Ep composites, indicating their inherent self-lubricating property. However, the Gr-Ep composites are seen to be more sensitive to the influence of filler content and sliding distance as compared to the SiC-Ep composites, obviously due to their lower hardness.

Effect of Filler Loading on Specific Wear loss (W_s)

The specific wear loss (W_s in mm³/N-m) parameter and provides a more comprehensive measure of the wear loss characteristics of the material. It is defined [21] as the reduction

Table 1. Quantitative summary of wear loss at extreme operating, loading and filler contents.

		Wear loss (mm ³) for composites at sliding distance of			
Filler	Load (N)	317 m		2856 m	
		5%	40%	5%	40%
SiC (hard)	10	3.456	1.335	8.875	3.848
	30	4.163	1.963	10.838	3.927
Gr (soft)	10	2.513	0.785	7.461	3.691
	30	3.377	0.707	8.168	4.320

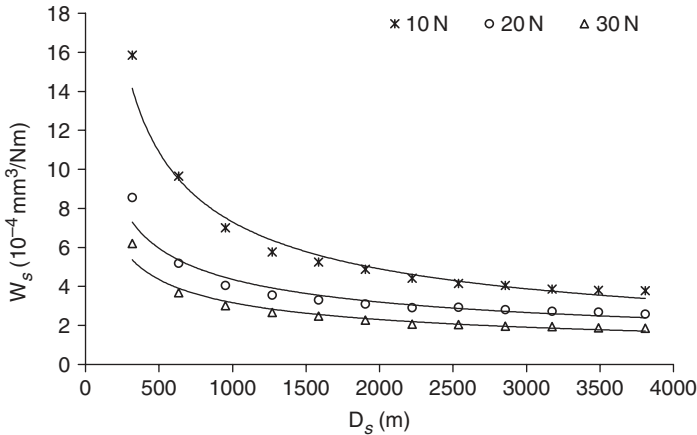

Figure 9. Effect of sliding distance (D_s) and contact load on specific wear loss (W_s) for unfilled epoxy.

of the specimen volume normalised with respect to the sliding distance and the load, as quantified below:

$$W_s = \Delta h * A / D_s F_N \tag{4}$$

where

Δh = reduction in height of the specimen, mm

A = specimen cross sectional area, mm²

D_s = sliding distance, m

F_N = normal load, N.

The specific wear loss as a function of sliding distance under the applied loads of 10, 20 and 30 N for unfilled epoxy is shown in Figure 9. From the figure it can be observed that the specific wear loss exhibits an initial steep drop up to a sliding distance of 500 m, and remains practically insensitive to sliding distance thereafter. This can be attributed to the fact [22] that the formation of transfer layer of the epoxy on the counterface surface acts to reduce the wear loss, as the epoxy is sliding against itself. It can be seen from the figure that the specific wear loss varies inversely with the load, which is expected. The above trends are represented by the following equations:

$$W_s = 390.13 D_s^{-0.5758} \tag{5}$$

$$W_s = 96.49 D_s^{-0.4482} \tag{6}$$

$$W_s = 75.85 D_s^{-0.4597} \tag{7}$$

Figures 10–12 present the effect of sliding distance on the specific wear loss of SiC-Ep composites for various filler loadings, under different applied loads of 10, 20 and 30 N. From these figures, it can be observed that SiC addition reduces the composites' specific wear loss, which means an improvement in the wear resistance of the SiC composites. Again similar to the effects noted for the wear loss (Figures 3–5), the specific wear loss is also seen to become independent of the sliding distance beyond a certain point. Further, it can be observed that the specific wear loss is less the greater the load applied, an effect similar to that observed in the case of unfilled epoxy.

The effects of the compositional and wear test parameters on the specific wear loss of the Gr-Ep composites are presented in Figures 13–15. Here also, while the tribological

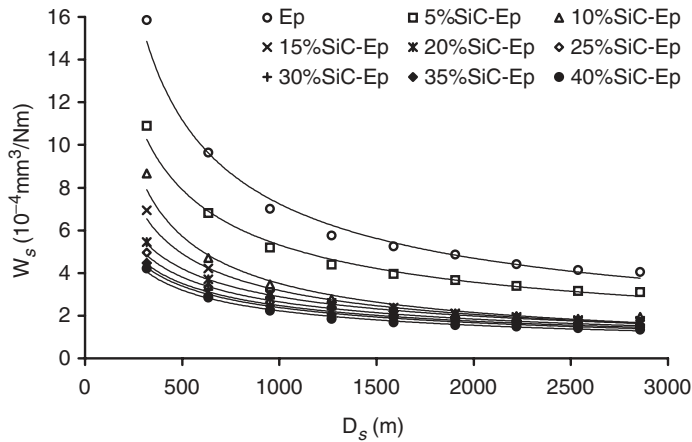

Figure 10. Effect of sliding distance (D_s) on the specific wear loss (W_s) of SiC-Ep composites contact load 10 (127 KPa).

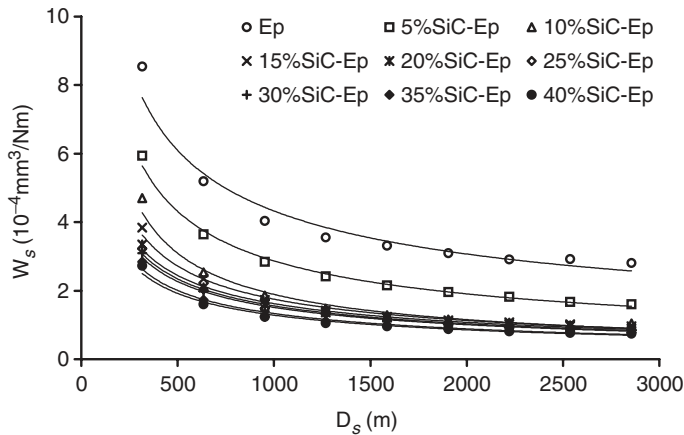

Figure 11. Effect of sliding distance (D_s) on the specific wear loss (W_s) of SiC-Ep composites contact load 20N (254 KPa).

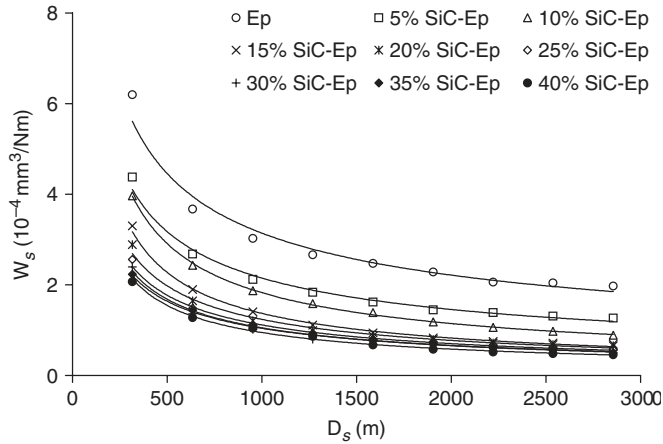

Figure 12. Effect of sliding distance (D_s) on the specific wear loss (W_s) of SiC-Ep composites contact load 30 N (381 KPa).

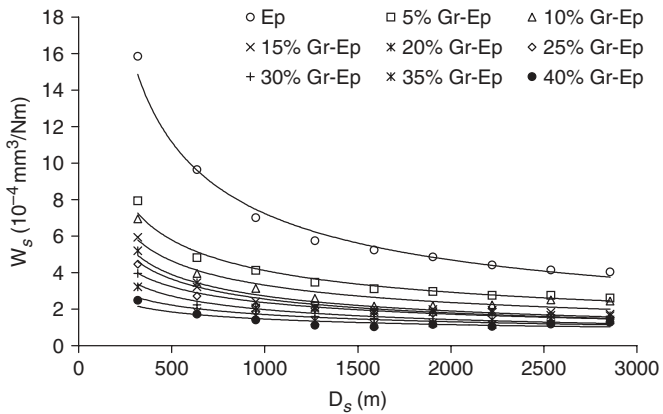

Figure 13. Effect of sliding distance (D_s) on the specific wear loss (W_s) of Gr-Ep composites contact load 10 N (127 KPa)

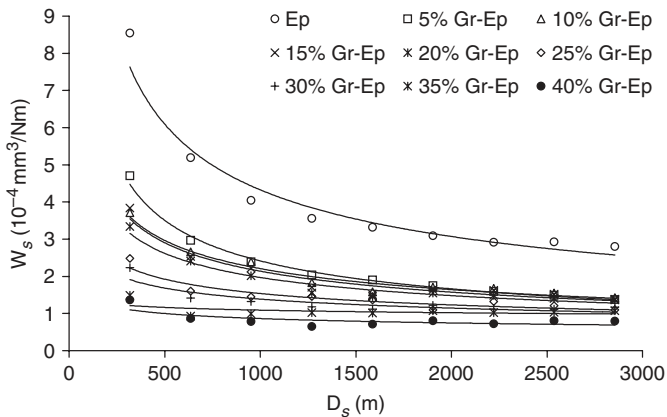

Figure 14. Effect of sliding distance (D_s) on the specific wear loss (W_s) of Gr-Ep composites contact load 20 N (254 KPa).

behavior of Gr-Ep composites are seen to be practically similar to that observed for SiC-Ep composites, the specific wear loss maxima corresponding to the extreme sliding distance are lower than those of the latter, clearly reflecting once again the superior wear resistance of Gr-Ep composites.

Wear Endurance Index - A New Parameter

From the nature of curves shown through Figures 9–15 (W_s V_s D_s plots) for the unfilled and filled epoxy composites, a very interesting phenomenon is observed. A careful look at these figures reveals a distinct “threshold sliding distance D_{sc} ” above which the specific wear loss (W_s) of the material becomes practically invariant with increased sliding distance; and below which it increases steeply, as shown schematically in Figure 16. Thus this D_{sc} parameter can be used as a “wear endurance index” for these composites. In Table 2 are presented D_{sc} values for the unfilled epoxy, SiC-Ep and Gr-Ep composites at contact load of 20 N.

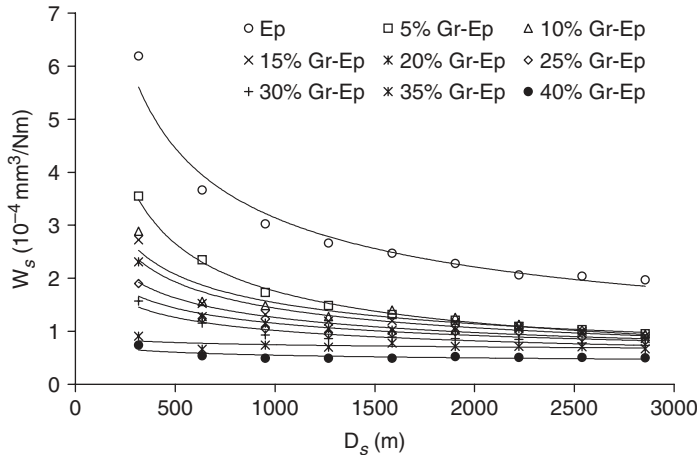

Figure 15. Effect of sliding distance (D_s) on the specific wear loss (W_s) of Gr-Ep composites contact load 30 N (381 KPa).

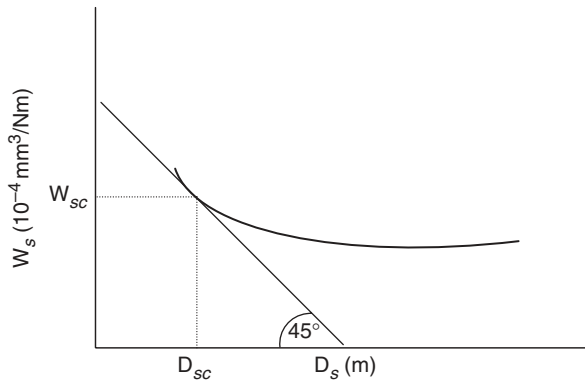

Figure 16. Schematic representation of threshold sliding distance (D_{sc}).

The parameters of the table are plotted in Figures 17 and 18 for both the composites. From these figures it can be seen that as filler loading is increased “the wear stabilization” is shifted towards a lower sliding distance, clearly indicating a longer leftover life. Once again the superiority of Gr-Ep composites is reflected, as shown in Figure 17 (i.e. a steeper specific wear loss reduction with % filler loading).

Table 2. Comparison of critical specific wear loss and corresponding sliding distance for epoxy and its composites under load 20 N.

Material	W_{sc} (10^{-4} mm ³ /Nm)	D_s (m)
Ep	7.10	360
10% SiC-Ep	2.55	650
20% SiC-Ep	2.40	525
30% SiC-Ep	2.30	475
40% SiC-Ep	2.05	430
10% Gr-Ep	2.90	525
20% Gr-Ep	2.65	475
30% Gr-Ep	1.90	340
40% Gr-Ep	1.10	330

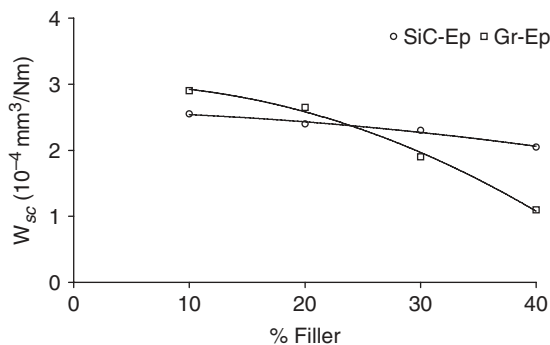

Figure 17. Effect of % filler on critical specific wear loss (W_{sc}) of the composites contact load 20 N (254 KPa).

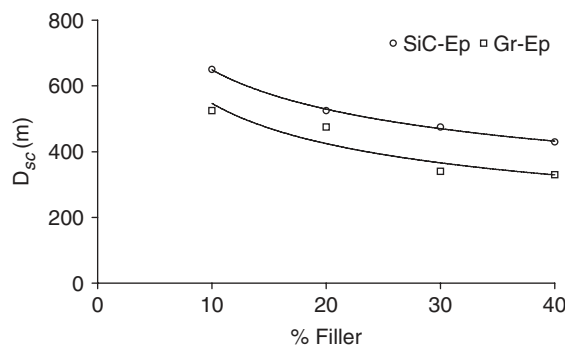

Figure 18. Effect of % filler on threshold sliding distance (D_{sc}) of the composites contact load 20 N (254 KPa).

Coefficient of Friction (COF)

Figure 19 shows the effect of sliding distance on the friction factor viz. COF of the unfilled epoxy at different contact pressures. The COF values plotted are the averaged values over the sliding distances. From the figure, it can be observed that the COF increases with increased sliding distance at all contact pressures. Further, Figures 20 and 21 show the COF verses % filler for the SiC-Ep and Gr-Ep composites respectively at different contact pressures, the trends of which are seen to be in line with their wear loss characteristics (Figures 3–8).

Figure 22 shows the effect of contact pressure on the average value of COF of unfilled epoxy and 20% particulate filled epoxy composites. It can be seen that for the unfilled epoxy the COF first increases and then decreases with the contact pressure, which can be attributed to the epoxy film formation on the countersurface, its fragmentation and the surface

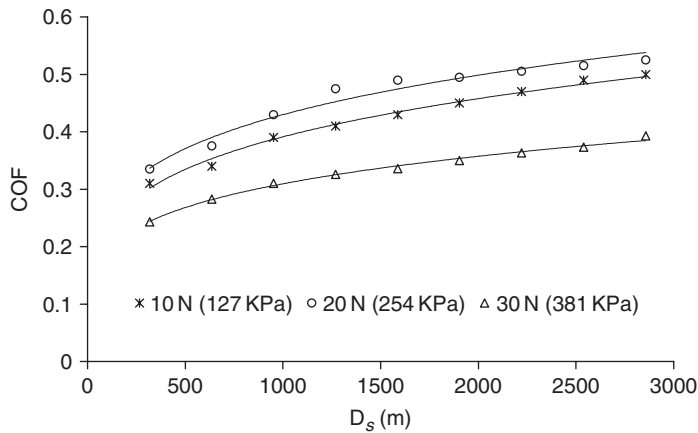

Figure 19. Effect of sliding distance and contact load (pressure) on COF of epoxy.

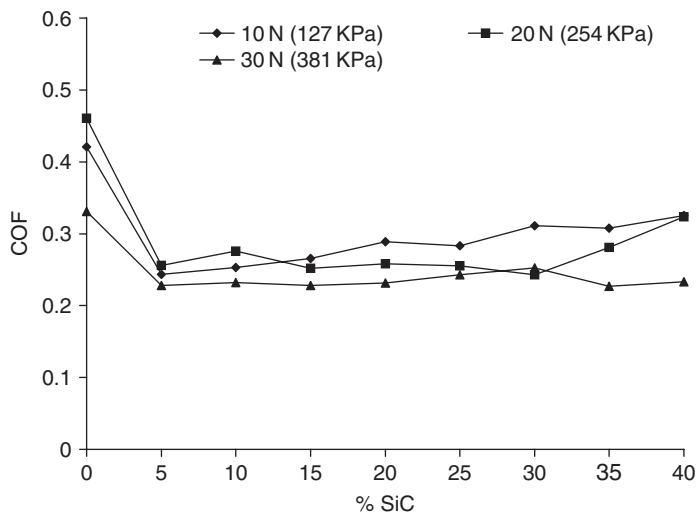

Figure 20. Effect of filler content and contact load (pressure) on COF of SiC-Ep composites.

unevenness caused thereof [23]. Further, Figure 22 also shows the COF vs. contact pressure relationship for SiC-Ep and Gr-Ep composites, reflecting again the unique tribological characteristics of Gr composites.

Effect of Filler on Wear Resistance (Reciprocal of Specific Wear loss)

The wear resistance of both types of composites is summarized as column diagrams in Figures 23 and 24. While it can be observed that the wear resistance of filled composites is superior to that of the unfilled epoxy, the Gr-Ep composite exhibits a higher wear resistance than the SiC-Ep composite for all the cases considered in these studies. Once again the superior wear resistance of the graphite composite is attributable to its layered structure, with its inherent self-lubricating characteristics [24].

Morphological (SEM) Studies

In Figure 25, unfilled epoxy (the top photo) shows features characteristic of typical unmodified resin casting, showing the wavy aspects of the wear track associated with the

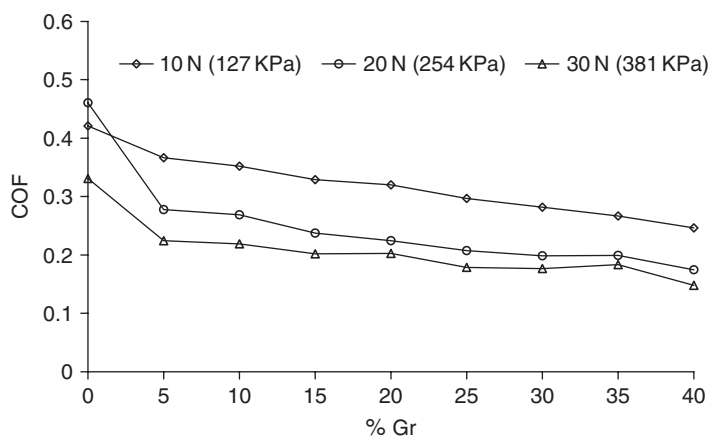

Figure 21. Effect of filler content and contact load (pressure) on COF of Gr-Ep composites.

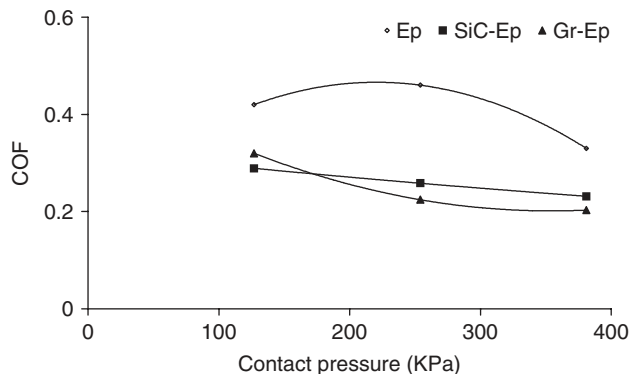

Figure 22. Effect of contact pressure on COF of epoxy and its particulate composites.

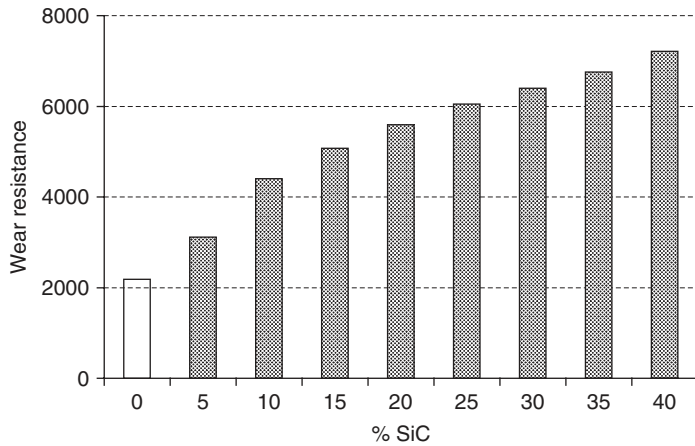

Figure 23. Influence of SiC content on the wear resistance of its epoxy composites.

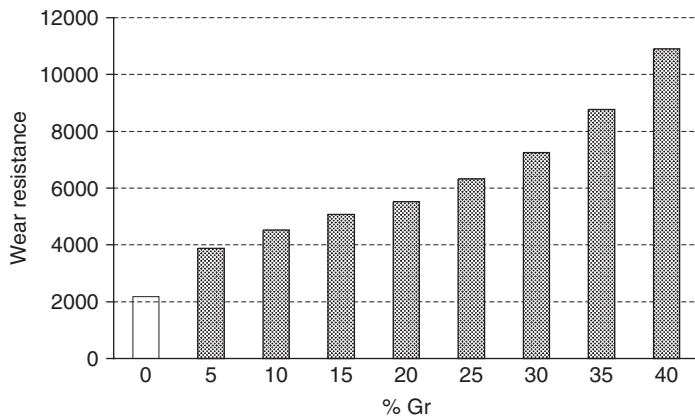
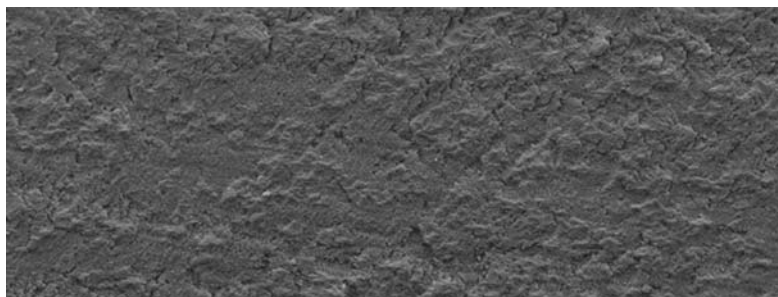

Figure 24. Influence of Gr content on the wear resistance of its epoxy composites.

presence of cracks, normal to the sliding direction; whereas by contrast the SiC-Ep (middle photo) shows granular fracture features with surface waves of lesser depth separated by frequent tracks, indicating the brittleness introduced due to the incorporation of the hard SiC particles into the relatively more ductile epoxy matrix chunks of the particulates. This clearly accounts for the increased wear resistance of the latter. The Gr-Ep (bottom photo) shows the fracture features typical of a layered composition, clearly showing the graphitic cleavage planes in the composite. The absence of any granular features (as in the SiC-Ep) or cohesive fracture features (as in the unfilled epoxy) seen in this photo clearly reflect the morphological features of the graphite composites.

CONCLUSION

The wear behavior of the SiC-Ep and Gr-Ep composites was studied in terms of wear loss and COF under varied experimental conditions. It was observed that wear parameters viz. the wear loss, the specific wear loss and the COF, characterising the wear resistance



(a) Top

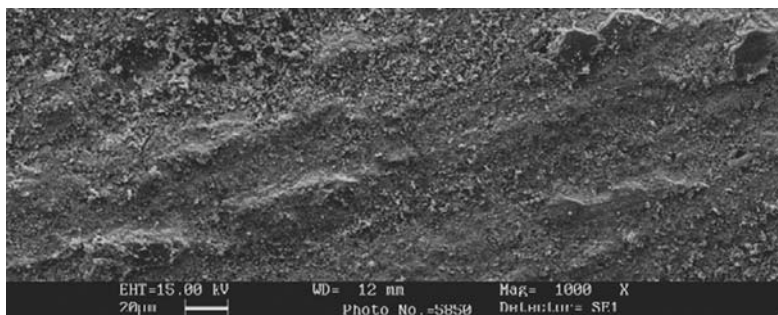

(b) Middle

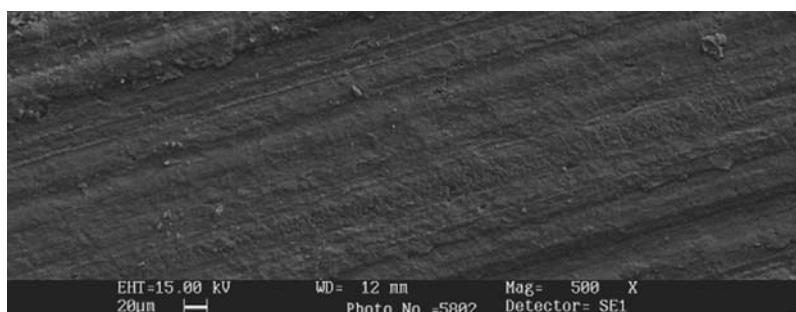

(c) Bottom

Figure 25. SEM photographs of the epoxy particulate composites: (a) unfilled epoxy; (b) 40% SiC-Ep; (c) 40% Gr-Ep.

of the composites, have shown expected trends both with reference to the compositional (% filler loading) and the wear test (sliding distance and contact pressure) parameters. However, results clearly showed the unique and superior wear resistance characteristics of the Gr-Ep composites. The concept of the wear endurance index parameter introduced in these studies is expected to help in assessing the wear endurance life of composites.

ACKNOWLEDGEMENT

The authors are thankful to Dr. A. R. Upadhy, Director, National Aerospace Laboratories, Bangalore, for his support and encouragement during the investigation.

REFERENCES

1. ASM International, *Engineered Materials Handbook*. (1987). Vol. 1, Composites, ASM International, Materials Park, Ohio, USA.
2. Seymour, R. B. (1981). *Conductive Polymers*, Plenum Press, NY.
3. Manas, C. and Salil, R. K. (1997). *Plastic Technology Handbook*, 3rd edn, Marcel Dekker, New York.
4. Kaushal, S. and Kishore (1992). Analysis of Deformation Behaviour and Fracture Features in Glass-epoxy Composites Toughened by Rubber and Carbon Additions, *Journal of Materials Science Letters*, **11**: 86–88.
5. Chacko, V. P., Karasz, F. E., Farris, R. J. and Thomas, E. L. (1982). Morphology of CaCO₃ Filled Polyethylene, *Journal of Polymer Science*, **20**: 2177–2195.
6. Oktem, G. A. and Tinner, T. (1994). Preparation and Characterization of Perlite-filled High-density Polyethylene. I. Mechanical Properties, *Journal of Applied Polymer Science*, **54**: 1103–1114.
7. Hashmi, S. A. R. and Chand, N. (1995). SEM Observations of Tensile Fractographs of Red Mud Filled Linear Low-density Polyethylene, *Journal of Materials Science Letters*, **14**: 377–379.
8. Vishwanath, B., Verma, A. P. and Kameshwararao, C. V. S. (1993). Effect of Reinforcement on Friction and Wear of Fabric Reinforced Polymer Composites, *Wear*, **167**: 93–99.
9. Xiubing Li, Yimin Gao, Jiandong Xing, Yu Wang, and Liang Fang. (2004). Wear Reduction Mechanism of Graphite and MoS₂ in Epoxy Composites, *Wear*, **257**: 279–283.
10. Durand, J. M., Vardavoulias, M. and Jeandin, M. (1995). Role of Reinforcing Ceramic Particles in the Wear Behaviour of Polymer-based Model Composites, *Wear*, **181–183**: 833–839.
11. Friedrich, K., Lu, Z. and Hager, A. M. (1995). Recent Advances in Polymer Composites Tribology, *Wear*, **190**: 139–144.
12. Hokao, M., Hironaka, S., Suda, Y. and Yamamoto, Y. (2000). Friction and Wear Properties of Graphite/Glassy Carbon Composites, *Wear*, **237**: 54–62.
13. Vasconcelos, P. V., Lino, F. J., Baptists, A. M. and Neto, R. J. L (2006). Tribological Behaviour of Epoxy Based Composites for Rapid Tooling, *Wear*, **260**: 30–39.
14. Chang, L., Zhang, Z., Breidt, C. and Friedrich, K. (2005). Tribological Properties of Epoxy Nanocomposites. I. Enhancement of the Wear Resistance by Nano TiO₂ Particles, *Wear*, **258**: 141–148.
15. Bassani, R., Levita, G., Meozzi, M. and Palla, G. (2001). Friction and Wear of Epoxy Resin on Inox Steel: Remarks on the Influence of Velocity, Load and Induced Thermal State, *Wear*, **247**: 125–132.
16. Xing, X. S. and Li, R. K. Y. (2004). Wear Behaviour of Epoxy Matrix Composites Filled with Uniform Sized Sub-micron Spherical Silica Particles, *Wear*, **256**: 21–26.
17. Jacobas, O., Jaskulka, R., Yang, F. and Wu, W. (2004). Sliding Wear of Epoxy Compounds against Different Counterparts under Dry and Aqueous conditions, *Wear*, **256**: 9–15.
18. Bloom, P. D., Baikerlikar, K. G., Anderegg, J. W. and Sheares, V. V. (2003). Fabrication and Wear Resistance of Al-Cu-Fe Quasicrystal-epoxy Composites Materials, *Materials and Engineering A*, **360**: 46–57.
19. Stachowiak, G. W. and Batchelor, A. W. (2001). *Engineering Tribology*, 2nd edn, Butterworth-Heinemann, Oxford.
20. Srivastava, V. K., Pathak, J. P. and Tahzibi, K. (1992). Wear and Friction Characteristics of Mica Filled Fiber Reinforced Epoxy Resin Composites, *Wear*, **152**: 343–350.
21. Vardavoulias, M., Jouanny-Tresy, C. and Jeandin, M. (1993). Sliding-wear Behaviour of Ceramic Particle-reinforced High-speed Steel Obtained by Powder Metallurgy, *Wear*, **165**: 141–149.
22. Kota, K. (2000). Wear in Relation to Friction-A Review, *Wear*, **241**: 151–157.
23. Ellis, B. (Ed.). (1993). *Chemistry and Technology of Epoxy Resins*, Blackie, London.
24. Chung, D. D. L. (2002). Review-Graphite, *Journal of Materials Science*, **37**: 1475–1489.