

Effects of roller burnishing process parameters on surface roughness of A356/5%SiC composite using response surface methodology

Shashi Prakash Dwivedi · Satpal Sharma ·
Raghvendra Kumar Mishra

Received: 3 October 2013 / Accepted: 12 June 2014 / Published online: 18 July 2014
© Shanghai University and Springer-Verlag Berlin Heidelberg 2014

Abstract In this study, a simple roller burnishing tool was made to operate burnishing processes on A356/5%SiC metal matrix composite fabricated by electromagnetic stir casting under different parameters. The effects of burnishing speed, burnishing force and number of burnishing passes on the surface roughness and tribological properties were measured. Scanning electron microscopy (SEM) graphs of the machined surface with PCD (insert-10) tool and roller burnished surface with tungsten carbide (WC) roller were taken into consideration to observe the surface finish of metal matrix composites. The mechanical properties (tensile strength, hardness, ductility) of A356/5%SiC metal matrix composites were studied for both unburnished samples and burnished samples. The results revealed that the roller burnished samples of A356/5%SiC led to the improvement in tensile strength, hardness and ductility. In order to find out the effects of roller burnishing process parameters on the surface roughness of A356/5%SiC metal matrix composite, response surface methodology (RSM) (Box–Behnken design) was used and a prediction model was developed to evaluate average surface roughness using experimental data. In the range of process parameters, the result shows that roller burnishing speed increases, and surface roughness decreases, but on the other hand roller burnishing force and number of passes increase, and surface roughness increases. Optimum values of burnishing speed (1.5 rpm), burnishing force (50 N) and number of passes (2) during roller burnishing of A356/5%SiC metal matrix composite to minimize the surface roughness (predicted 1.232 μm) have been found out. There was only 5.03% error in the experimental and modeled results of surface roughness.

Keywords Burnishing speed · Burnishing force · Response surface methodology (RSM) · Box–Behnken design · Desirability function

1 Introduction

Increasing need for new lightweight materials with good mechanical properties has led to the development of a new generation of composite materials over recent decades, even though these increased mechanical properties after the addition of reinforcement create major challenges for machining with good surface quality. Composite materials with good mechanical properties, such as good strength, toughness and greater hardness, cause serious tool wear when traditional machining is used [1]. Burnishing is a low-cost surface treatment process and can be applied to improve surface quality. During burnishing, the generated pressure exerted by the tool exceeds the yield point of part surface at the point of contact, and causes a small plastic deformation. This plastic deformation created by roll or ball burnishing is a displacement of the material that flows from the peaks into the valleys under pressure, and results in a mirror-like surface finish with a strain-hardened, wear, and corrosion-resistant surface [2]. Both ball burnishing and roller burnishing are cold-working processes that do not involve material removal, and can produce work hardening of the part surface. Roller burnishing is applied to cylindrical workpieces on both external and internal surfaces, and its tools are similar to roller bearings [3].

El-Axir [4] studied the influence of burnishing speed, force, feed, and number of passes on both surface microhardness and roughness. Mathematical models were presented for predicting the surface microhardness and roughness of St-37 caused by roller burnishing under

S. P. Dwivedi (✉) · S. Sharma · R. K. Mishra
Gautam Buddha University, Greater Noida,
Gautam Budh Nagar, U.P. 201310, India
e-mail: shashi_gla47@rediffmail.com

lubricated conditions. Variance analysis was conducted to determine the prominent parameters and the adequacy of the models. From an initial roughness of about surface roughness 4.5 μm , the specimen finished to a roughness of 0.5 μm . It is shown that the spindle speed, burnishing force, burnishing feed and number of passes have the most significant effect on both surface microhardness and surface roughness. El-Kha-beery and El-Axir [5] presented an investigation of the effects of roller-burnishing upon surface roughness, surface microhardness and residual stress of 6061-T6 Al alloy. Mathematical models correlating three process parameters including burnishing speed, burnishing depth of penetration and number of passes, were established. It is shown that low burnishing speeds and high depth of penetration produce much smoother surfaces, whereas a combination of high speed with high depth leads to rougher surfaces because of chatter. The optimum number of passes that produces a good surface finish is found to be 3 or 4. Luo et al. [6] conducted the experiments with a simply designed cylindrical surfaced polycrystalline diamond tool. It was found that smaller parameters did not mean lower surface roughness or waviness, and different optimum burnishing parameters could be got under different burnishing conditions. Luo et al. [7] examined the effects of the burnishing parameters on the burnishing force and the surface microhardness with theoretical analysis and concluded that the burnishing feed and depth were the most significant factors. Luo et al. [8] compared theoretical results with the experiments in which Al alloy LY12 was selected as material for making the specimens. A new cylindrical polycrystalline diamond tool was developed for the burnishing process, and it showed that the theoretical model was basically correct in describing the burnishing process. Yeldose and Ramamoorthy [9] presented an investigation for the comparison of the effects of the uncoated and TiN coating by reactive magnetron sputtering on 42CrNi1 rollers in burnishing with varying process parameters. It was observed that the burnishing speed, burnishing force and number of passes had almost equal effect on the performance of the roller in burnishing, particularly with reference to the surface finish of the components produced. El-Taweel and El-Axir [10] showed that the burnishing force with a contribution percent of 39.87% for surface roughness and 42.85% for surface microhardness had the dominant effect on both surface roughness and micro-hardness followed by burnishing feed, burnishing speed and then by number of passes. Klocke et al. [11] observed an additional influence on the surface roughness for high roller ball diameters. Franzen et al. [12] showed that the process parameters of the roller burnishing process had a strong influence on the surface topology of the friction elements and their tribological properties. Sagbas [13] developed a quadratic regression model to predict surface roughness using response surface methodology (RSM) with rotatable central composite design (CCD). In the development of

Table 1 Chemical composition of A356 alloy [19]

Element	Composition /wt.%
Si	6.5–7.5
Fe	0.2
Cu	0.2
Mn	0.1
Mg	7.5–14.5
Zn	0.1
Ti	0.1
Al	Balance

predictive models, burnishing force, number of passes, feed rate and burnishing speed were considered as model variables. Korzynski et al. [14] examined the effects of burnishing parameters on surface roughness and obtained the relevant mathematical models and multinomials of the second order that also allowed the interaction of input factors for burnished 42CrNi1 alloy steel shafts. From the analysis it was concluded that surface microhardness increased by up to 29%. Świrad [15] introduced the new diamond sinter with ceramic bonding phase in the form of Ti_3SiC_2 as the tool material for roller burnishing to eliminate existing defect of the applied composites. Tadic et al. [16] achieved high surface quality with relatively small burnishing forces for Al alloy EN AW-6082 (AlMgSi1) T651. Balland et al. [17] investigated the mechanics of roller burnishing through finite element simulation and experiments. Balland et al. [18] proposed a finite element modeling of the ball burnishing process and analyzed the effect of the burnishing process on the material.

On the basis of literature review, it was found that no researcher had investigated the mechanical properties and surface roughness of A356/SiC composite (Al/SiC composite) after roller burnishing with tungsten carbide rollers. Hence, in view of the above facts, an investigation was carried out to find the effects of roller burnishing process parameters on the surface roughness of A356/5%SiC metal matrix composite. The roller burnished A356/SiC composite was characterized in terms of the SEM micrograph of surface, tensile strength, ductility, hardness. In order to properly design a burnishing process, roller burnishing process parameters were optimized with respect to surface roughness using a Box–Behnken design RSM.

2 Materials and methods

2.1 Matrix alloy

In this study A356 alloy was selected. It has very good mechanical strength, ductility, hardness, fatigue strength,

Table 2 Properties of A356 alloy [19]

Properties	Values
Liquidus temperature /°C	615
Solidus temperature /°C	555
Density /(g·cm ⁻³)	2.685

Table 3 Silicon carbide (beta) particle parameters

Properties	Values
Purity /%	95
Average particle size /μm	25
Density /(g·cm ⁻³)	3.21
Morphology	Spherical

Table 4 Properties of silicon carbide

Properties	Values
Melting point temperature /°C	2,200–2,700
Hardness (Vickers)	2,800–3,300
Density /(g·cm ⁻³)	3.2
Crystal structure	Hexagonal

pressure tightness, fluidity, and machinability [19]. The chemical composition and properties of A356 are shown in Tables 1 and 2.

2.2 Reinforcement material

Silicon carbide was used as the reinforcement phase. To select a suitable reinforcement material for Al, important factors such as density, wettability, and thermal stability were considered. Silicon carbide is a widely used reinforcement material because of its good wettability with the Al matrix [20, 21]. The silicon carbide particle parameters and properties are shown in Tables 3 and 4.

2.3 Roller burnishing tool

A burnishing tool with changeable adapter roller was designed and fabricated for the purpose of the experimental tests. Figure 1 shows a schematic representation with dimension of the roller burnishing tool in which a shank is rigidly clamped on the lathe machine. A helical compression spring is used to exert the burnishing force during roller burnishing operations. A roller adapter is used to contain burnishing tungsten carbide (WC) roller with different rolls. A dial gauge is fixed at the end of the shank and directly placed in contact with the spring guide [22]. Thus, when roller burnishing force is applied, the axial

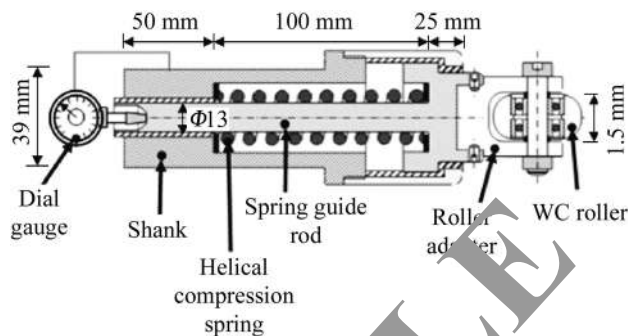
**Fig. 1** Detailed sectional view of roller burnishing tool assembly [22]

sliding motion of the spring guide rod is identified by the dial gauge.

2.4 Fabrication of metal matrix composite

Figure 2 shows the schematic of electromagnetic stir casting set-up. A356 alloy was heated to above 650 °C in muffle furnace. The temperature was controlled by connecting the relay from the muffle furnace and thermocouple up to 700 °C. Liquid A356 Al alloy at a given temperature (700 °C) was poured into a graphite crucible which was packed very well with the help of glass wool. Silicon carbide particles with average size of 25 μm were pre-heated at 450 °C for 1 h prior to introduction into the matrix. The argon gas was used at the tip of melt A356 alloy during the mixing of SiC. Coolant was used to provide the proper cooling to the windings of motor and vacuum box was used to provide vacuum inside the box to prevent casting defects. The prepared samples of A356/5%SiC metal matrix composites are shown in Fig. 3.

2.5 Selection of roller burnishing process parameters and their levels

Before the roller burnishing process of A356/5%SiC metal matrix composites, the turning processes [24, 25] were carried out in dry cutting conditions using CNC lathe with PCD (insert-10) tool. During turning of A356/5%SiC metal matrix composite, in all seventeen runs, depth of cut (0.20 mm), speed (3.16 m/s) and feed rate (0.14 mm/rev) were taken as fixed values [19]. After the machining of all seventeen turning samples, a lathe machine was used for roller burnishing process, as shown in Fig. 4. The roller burnishing processes were performed by clamping it on the tool post of lathe. The lathe machine has variable spindle speeds with a maximum power of 20 kW.

A calibration process was managed using the actual burnishing operation setting to obtain a relationship between the burnishing force, burnishing speed, number of passes and the

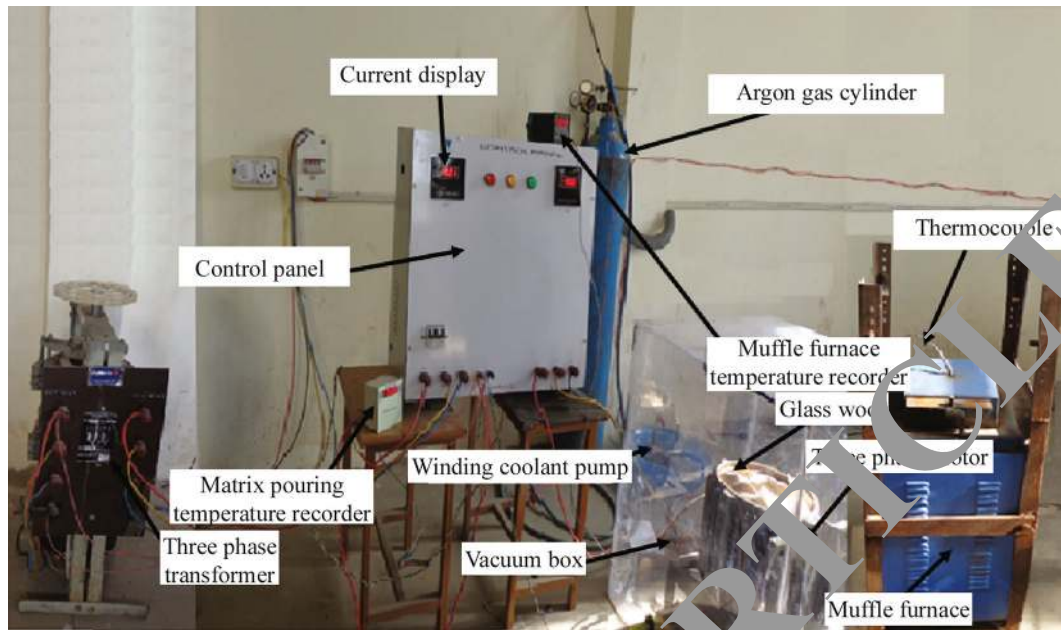

Fig. 2 Experimental set-up of electromagnetic stir casting process [23]

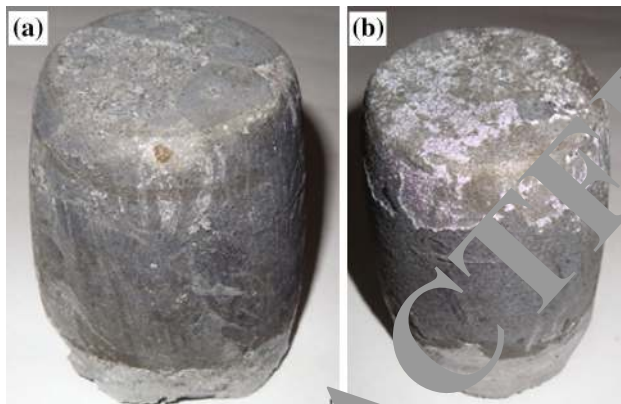

Fig. 3 Fabricated A356/5%SiC metal matrix composites by electromagnetic stir casting method

corresponding surface roughness of A356/5%SiC metal matrix composite. During the roller burnishing tool calibration process on the surface roughness of machined A356/5%SiC metal matrix composite, burnishing speed of 1.17 m/s, burnishing force of 100 N and number of passes of 3 were taken as fixed values. The experimental surface roughness values of the samples of machined A356/5%SiC composite corresponding to these parameters (burnishing speed of 1.17 m/s, burnishing force of 100 N and number of passes of 3) were found to be 1.15 μm , 1.18 μm , 1.22 μm , 1.20 μm , 1.18 μm , respectively. This shows that there is only 5.73% error in the experimental results. Hence, the developed set-up for the roller burnishing can be effectively used. Figure 5 shows the SEM micrographs of the surface layer of the

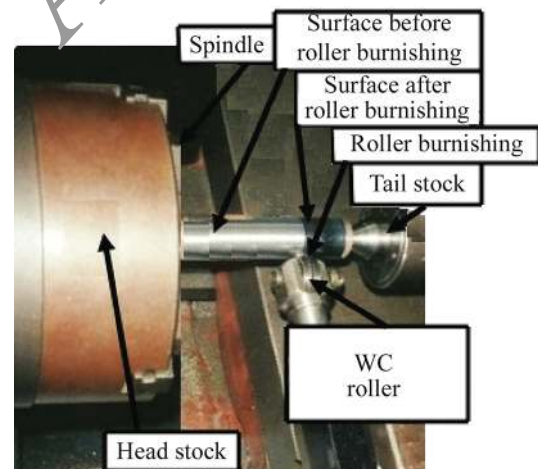

Fig. 4 Roller burnishing process

A356/5%SiC metal matrix composites during tool calibration process with WC roller.

There are various process parameters of roller burnishing affecting the surface roughness. On the basis of pilot run investigations, the following process parameters were selected for study. Their ranges are given in Table 5.

2.6 RSM

RSM covers statistical experimental design, regression modeling technique, and optimization method. It is useful for the prediction and optimization of process parameters on machining performances. Box–Behnken design is an

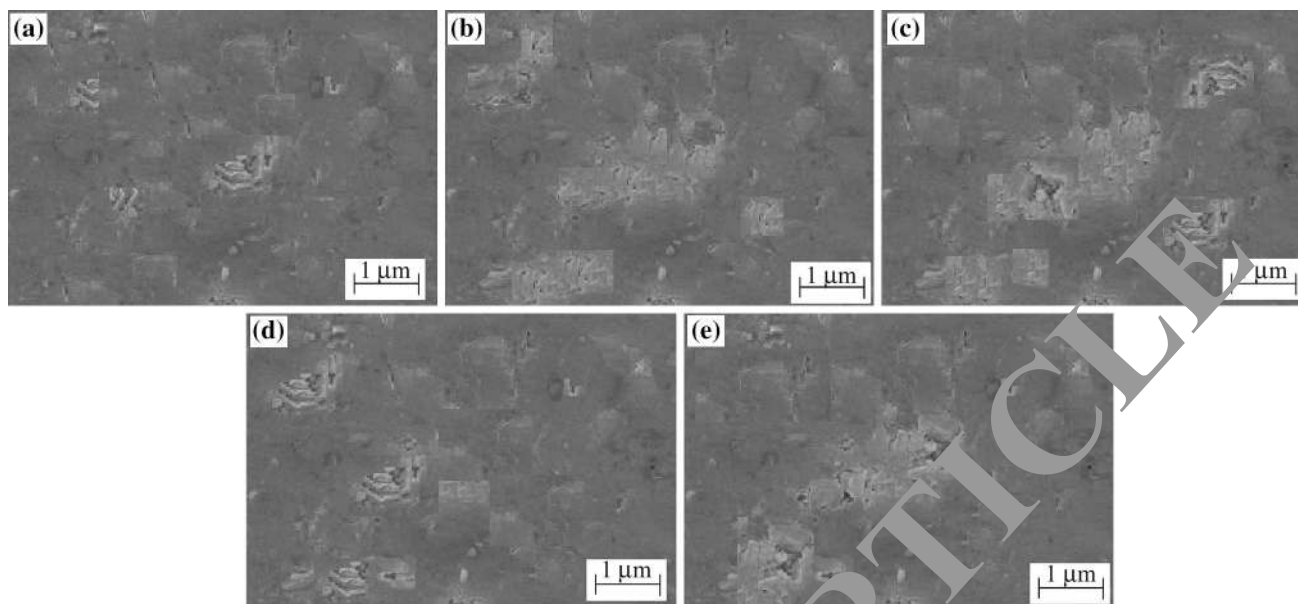

Fig. 5 SEM micrographs of the surfaces of A356/5%SiC metal matrix composites generated under conditions in roller burnishing with WC roller

Table 5 Process parameters with their ranges

Input parameters	Ranges
Burnishing speed /($\text{m}\cdot\text{s}^{-1}$)	0.83–1.5
Burnishing force /N	50–150
Number of passes	2–4

RSM design. It is used to study the quadratic effect of factors after identifying the significant factors using screening factorial experiments. Box–Behnken design does not contain any point at the vertices of the experimental region. This could be advantageous when the points on the corners of the cube represent factor level combinations that are prohibitively expensive or impossible to test because of physical process constraints [19,26]. Steps involved in Box–Behnken design are given in Fig. 6.

Objective of the present work is to concentrate on the second strategy: statistical modeling to develop an appropriate approximating model between the response y and independent variables, $\zeta_1, \zeta_2, \dots, \zeta_k$.

In general, the relationship is

$$y = f(\zeta_1, \zeta_2, \dots, \zeta_k) + \varepsilon. \tag{1}$$

If normal distribution is with mean 0 and variance σ^2 , then, it may be written as

$$E(y) = \eta = E(f(\zeta_1, \zeta_2, \dots, \zeta_k)) + E(\varepsilon) = f(\zeta_1, \zeta_2, \dots, \zeta_k), \tag{2}$$

where variables $\zeta_1, \zeta_2, \dots, \zeta_k$ are usually the natural variables.

In terms of the coded variables, the response function (Eq. (2)) will be written as

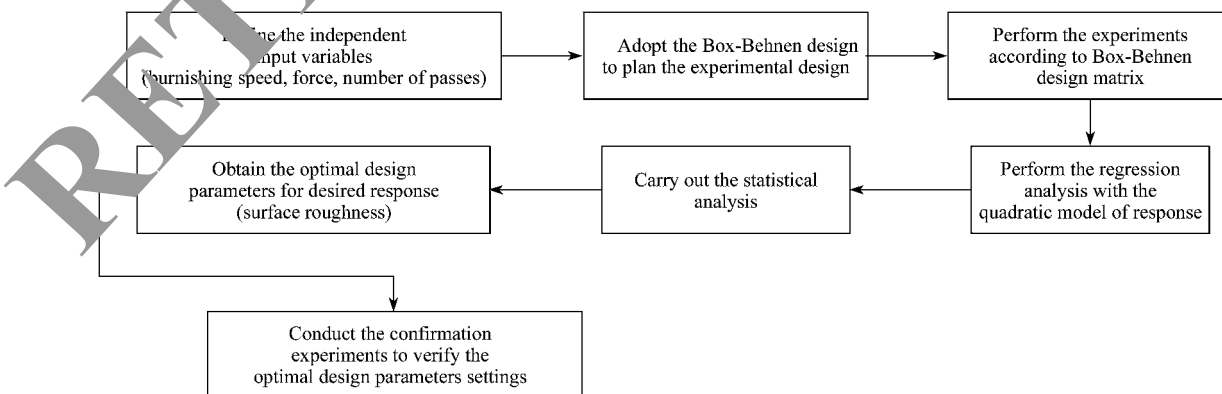

Fig. 6 Steps involved in Box–Behnken design

Table 6 Design matrix and experimental results

Standard order	Run	Burnishing speed $/(m \cdot s^{-1})$	Burnishing force /N	Number of passes	Surface roughness $/\mu m$
10	1	1.17	150	2	0.500
2	2	1.50	50	3	0.798
3	3	0.83	150	3	2.700
15	4	1.17	100	3	1.150
8	5	1.50	100	4	1.300
1	6	0.83	50	3	1.500
6	7	1.50	100	2	0.100
4	8	1.50	150	3	1.800
7	9	0.83	100	4	2.200
9	10	1.17	50	2	0.200
16	11	1.17	100	3	1.200
17	12	1.17	100	3	1.290
14	13	1.17	100	3	1.270
5	14	0.83	100	2	1.000
13	15	1.17	100	3	1.250
11	16	1.17	50	4	1.100
12	17	1.17	150	4	2.200

$$\eta = f(X_1, X_2, \dots, X_k). \quad (3)$$

For the case of two independent variables, the first-order model in terms of the coded variables will be written as

$$\eta = \beta_0 + \beta_1 X_1 + \beta_2 X_2. \quad (4)$$

The form of the first-order model in Eq. (4) is sometimes called main effects model, because it includes only the main effects of the two variables X_1 and X_2 . If there is an interaction between these variables, it can be added to the model easily as follows

$$\eta = \beta_0 + \beta_1 X_1 + \beta_2 X_2 + \beta_{12} X_1 X_2. \quad (5)$$

2.7 Planning of experiments

The arrangement and the results of the 17 experiments carried out in this work based on the Box-Behnken design are shown in Table 6. The design is prepared with the help of Design Expert Software, which is used to create experimental designs.

3 Results and discussion

3.1 Microstructure of metal matrix composite

The microstructures of A356/5%SiC metal matrix composites are exposed in Fig. 7. The microstructures point out the indication of minimum porosity in the A356/5%SiC metal matrix composites. The distribution of SiC in a

matrix alloy is reasonably homogeneous. Further the microphotographs of A356/5%SiC composite exhibit a good bond between the matrix alloy (A356) and the SiC particles (see Fig. 8). Three major causes determine the properties and performance of metal matrix composites of A356/SiC: (i) properties of the constituent materials, (ii) the size, shape, quantity, and distribution of the reinforcement (SiC), and (iii) the effectiveness of the bond between matrix (A356 alloy) and reinforcement (SiC) in transferring stress across the interface.

3.2 Surface layer of A356/5%SiC composites

Figure 9 shows the SEM micrographs [27] of the surface layer of the A356/5%SiC metal matrix composites generated under turning with PCD (insert-10) tool and roller burnishing with WC roller. Cracks and pits are observed on the machined surfaces of A56/5%SiC composites under turning with PCD (insert-10) tool. Comparing Figs. 9a, b, it is found that the amounts of cracks and pits are significantly reduced and a better surface integrity is obtained after the roller burnishing with constant burnishing speed (1.5 m/s), constant burnishing force (50 N) and constant number of passes (2). After the roller burnishing process, reduced amounts of plastic deformation results in smaller amounts of cracks and pits (see Fig. 9b). It shows that average surface roughness of A356/5%SiC metal matrix composite under turning with PCD (insert-10) tool is 3.732 μm . While average surface roughness of A356/5%SiC metal matrix

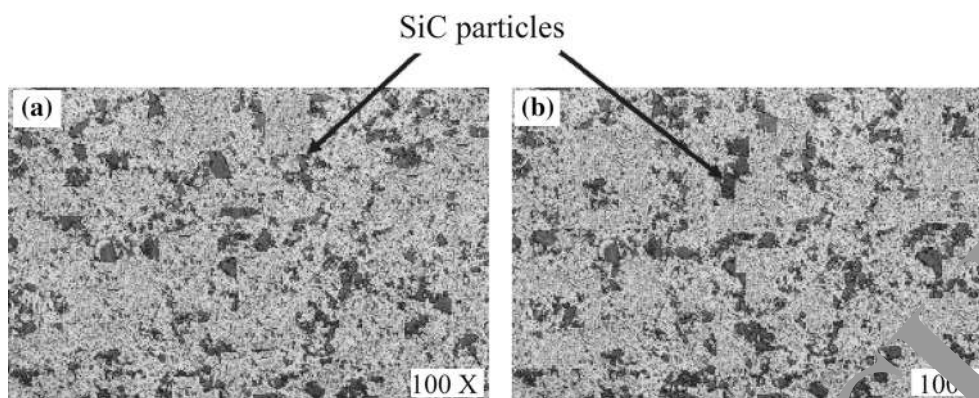

Fig. 7 Microstructures of A356/SiC metal matrix composites

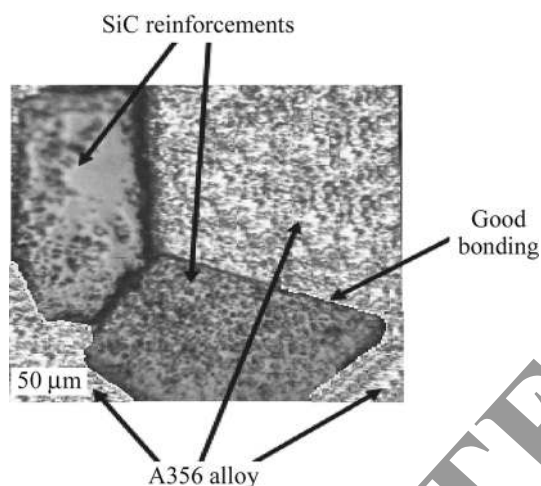

Fig. 8 Optical micrograph of A356/5% SiC indicating good bond between the matrix and reinforcements

composite under roller burnishing is $1.2 \mu\text{m}$ (predicted). Reduced surface roughness of A356/5%SiC metal matrix composite under roller burnishing is 66.98%.

Plastic deformation mechanisms of the surfaces of A356/5%SiC metal matrix composites before and after roller burnishing are shown in Figs. 10a–d, respectively. It can be seen from Figs. 10c, d that grain numbers within the sampling area increase (grain size reduces) after roller burnishing. This is an indication of the occurrence of grain refinement. This shows that the large grains with small size on the surface of A356/5%SiC composite give better surface finish. Turning with PCD (insert-10) tool leads to the generation of dislocations (see Figs. 10a, b). After the roller burnishing, dislocations are reduced.

3.3 Mechanical properties

For tensile and hardness testing, five samples of A356/5%SiC metal matrix composites have been prepared, as shown in Table 7. In this study the experimental result

shows that the tensile strength of the samples A356/5% SiC metal matrix composite under turning with PCD (insert-10) tool is lower than roller burnishing with WC roller. Average tensile strength of metal matrix composites under turning with PCD (insert-10) tool is 300.24 MPa. While average tensile strength of metal matrix composite under roller burnishing is 305.80 MPa. Improved tensile strength under roller burnishing is 1.81%. Ductility is a solid material's ability to deform under tensile stress, and it is often characterized by being stretched into a wire. Improved ductility of A356/5%SiC metal matrix composite under roller burnishing is 14.49% (see Table 7). It can be seen from Table 7 that average hardness of A356/5%SiC metal matrix composite under turning with PCD (insert-10) tool is 83.38 BHN. While average hardness of A356/5%SiC metal matrix composite under roller burnishing is 88.83 BHN. Improved hardness of metal matrix composite under roller burnishing is 6.13%.

3.4 Analysis of surface roughness of A356/5%SiC roller burnished samples

The aim of the present investigation is to analyze the effects of burnishing speed (m/s), burnishing force (N) and number of passes of roller burnishing with WC roller on surface roughness of A356/5%SiC metal matrix composite. The selected experimental design is Box–Behnken design and the design matrix is shown in Table 6. The analysis of response was done using Design Expert Software. Analysis of variance (ANOVA) for surface roughness is shown in Table 8. F value is defined as the ratio of mean square model to mean square error, and the probability of F value greater than calculated F value is expressed by p value due to noise. If p value is less than 0.05, significance of corresponding term is found. Significant p value ($p < 0.05$) means that the testing sample data are a normal subset of the population data. For lack of fit p value must be greater than

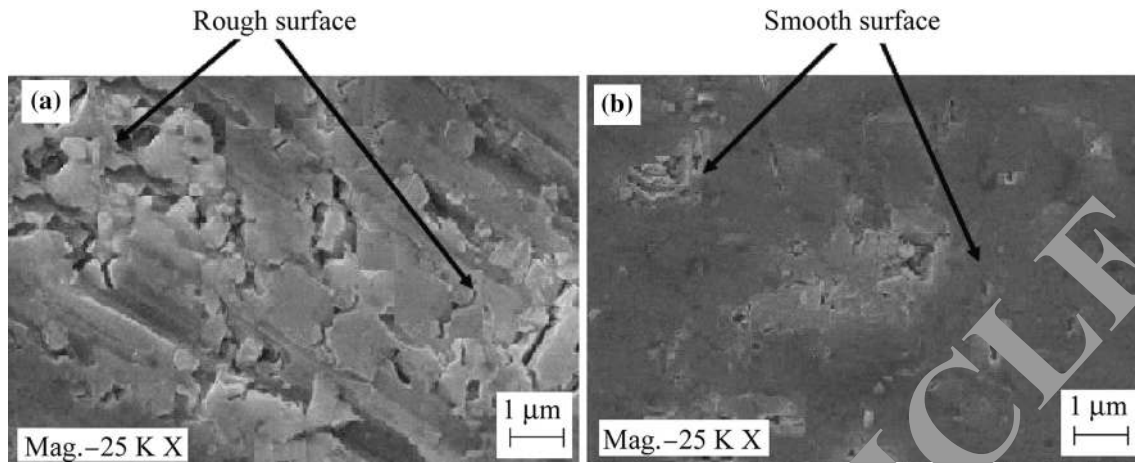

Fig. 9 SEM micrographs of the surfaces of A356/5%SiC metal matrix composites generated under condition: **a** turning with PCD (insert-10) tool **b** roller burnishing with WC roller

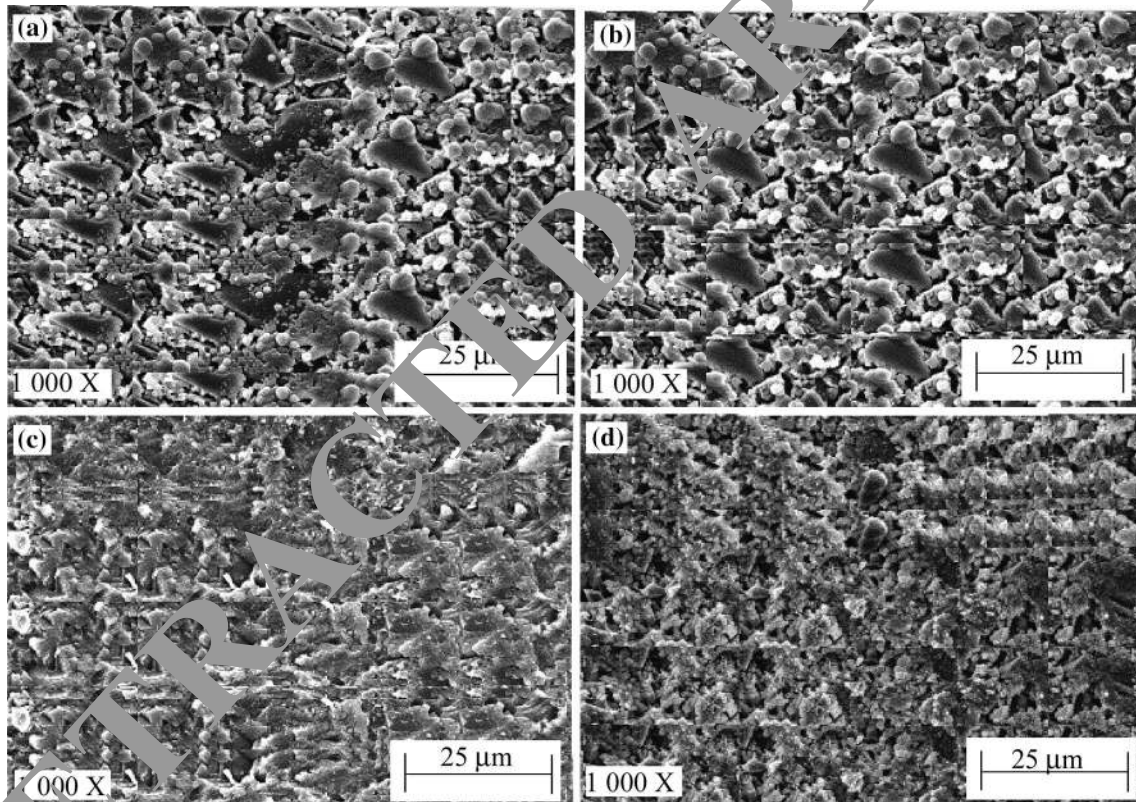

Fig. 10 Plastic deformation mechanism of the surfaces of A356/5%SiC metal matrix composites at higher magnification: **a, b** turning with PCD (insert-10) tool, **c, d** roller burnishing with WC roller

0.05. An insignificant lack of fit is desirable as it implies anything left out of model is not significant and the model developed fits. Based on ANOVA test, the full quadratic model was found to be relevant for surface roughness of A356/5%SiC metal matrix composite under roller burnishing with WC roller with regression p value less than 0.05 and lack of fit greater than 0.05. From

Table 8, terms burnishing speed, burnishing force, number of passes, square terms of burnishing speed, burnishing force, number of passes and interaction terms between burnishing force and number of passes are significant model terms. The regression equation can be expressed in Eqs. (3) and (4) in terms of coded factors and actual factors, respectively.

Table 7 Observations of tensile strength, ductility and hardness of composites

Sample No.	Turning with PCD (insert-10) tool			Roller burnishing with WC roller		
	Tensile strength /MPa	Percentage elongation (ductility) /%	Hardness /BHN	Tensile strength /MPa	Percentage elongation (ductility) /%	Hardness /BHN
1	292.60	4.50	75.60	299.45	5.50	82.00
2	298.50	5.20	82.35	303.56	6.80	83.66
3	304.45	6.65	86.66	307.55	7.25	86.33
4	301.22	6.40	84.80	306.45	7.11	89.36
5	304.45	6.45	87.50	312.00	7.50	94.50
Average values	300.24	5.84	83.38	305.80	6.83	88.83

Table 8 ANOVA for surface roughness

Source	Sum of square	DF	Mean square	F value	p value Prob. >F	
Model	7.63	9	0.85	93.90	< 0.0001	Significant
A (Burnishing speed)	1.62	1	1.62	179.68	< 0.0001	
B(Burnishing force)	1.45	1	1.45	160.28	< 0.0001	
C(Number of passes)	3.13	1	3.13	333.77	< 0.0001	
AB	1.000 x 10 ⁻⁶	1	1.000 x 10 ⁻⁶	1.108 x 10 ⁻⁴	0.9919	
AC	0.000	1	0.000	0.000	1.0000	
BC	0.16	1	0.16	17.73	0.0040	
A ²	0.47	1	0.47	51.96	0.0002	
B ²	0.14	1	0.14	15.75	0.0054	
C ²	0.73	1	0.73	80.63	< 0.0001	
Residual	0.063	7	9.000 x 10 ⁻³			
Lack of fit	0.050	3	0.017	5.21	0.0724	Not significant
Pure error	0.013	4	3.220 x 10 ⁻³			
Cor total	7.69	16				
Std. dev.	0.095		R-square		0.9918	
Mean	1.28		Adj-R squared		0.9812	
C.V./%	7.42		Pred R-squared		0.8927	
Press	0.82		Adeq precision		34.993	

$$\begin{aligned} \text{Surface roughness} = & 2.37 - 0.14A - .022B + 2.72C \\ & + 5.00 \times 10^{-7} AB - 7.70 \times 10^{-17} AC \\ & - 4.00 \times 10^{-3} BC + 8.34 \times 10^{-4} A^2 \\ & + 7.35 \times 10^{-5} B^2 - 0.42C^2 \end{aligned} \quad (6)$$

The determination coefficient (R^2) was used to check the goodness of fit of the model. The coefficient of determination value (0.9918) was calculated for response. This indicates that 99.18% of experimental data certify the rapport with the data predicted by the model. The R^2 value is always between 0 and 1, and its value illustrates correctness of the model. Coefficient of determination value (0.9918) should be close to 1.0 for a good statistical model. The adjusted R^2 value regenerates the phrases with the

significant terms. Adj R^2 (0.9812) is also high to proponent for a high significance of the model. The Pred R^2 (0.8927) suggests that the model could explain 95% of the changeability in anticipating new observations. Low value of coefficient of variation (7.42) expresses that deviations between experimental values and predicted values are low. Signal to noise ratio measures by Adeq precision. Adeq precision greater than 4 is desirable. In this study, Adeq precision value is 34.993, which reveals adequate signal.

Figure 11 displays the interaction between the predicted values and experimental values for surface roughness of A356/5%SiC metal matrix composite under roller burnishing with carbide rollers [28]. The points should be randomly dispersed along the 45° line. Majority of points below or above the line show areas of over or under prediction. The

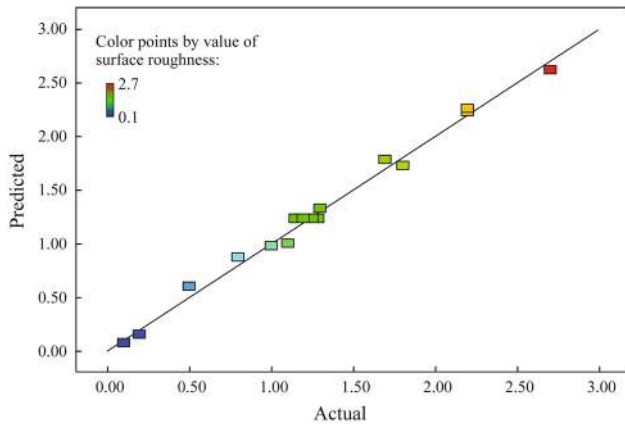

Fig. 11 Correlation between the predicted and actual values

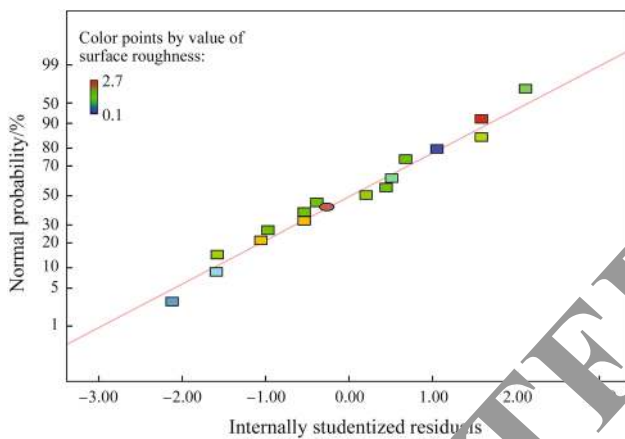

Fig. 12 The normal probability of residuals

normal probabilities of residuals are presented in Fig. 12. After developing the regression model of surface roughness, the model adequacy investigation was achieved in order to authenticate that the underlying assumption of regression investigation was not disrupted. Figure 12 represents the normal probability plot of the residual which generates no sign of the offense since each point in the plot pursues a straight line pattern. The normal probability plot is used to verify the normality assumption.

Figure 13 displays the studentized residuals versus predicted values to investigate for constant error. Residuals versus predicted values should be distributed at irregular intervals. In a linear regression investigation it is expected that the scattering of residuals is in the population (total number of testing data). Here is a plot of the residuals versus predicted.

Figure 14 displays the correlation between the residuals and experimental runs. Residuals versus runs should be random scatter and no trends.

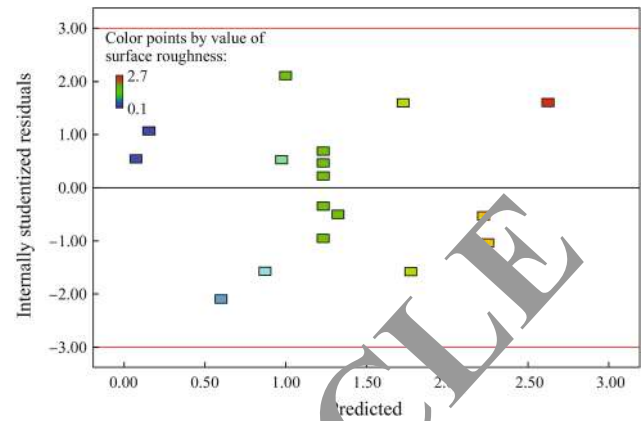

Fig. 13 Residuals versus predicted

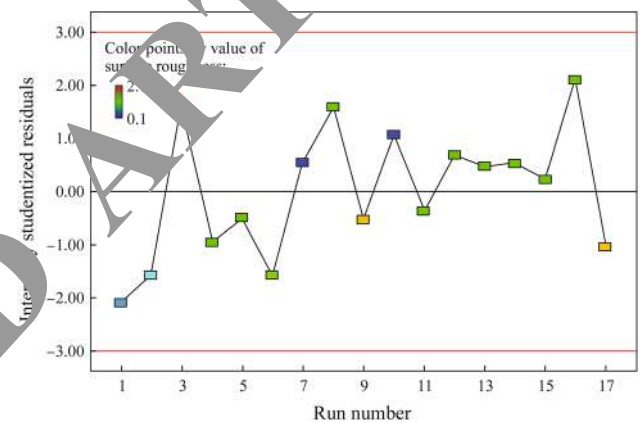

Fig. 14 Residuals versus run

3.5 Analysis of desirability

3D graphs between desirability, burnishing speed, burnishing force and number of passes are shown in Fig. 15. The basic idea of the desirability function approach is to transform a multiple response problem into a single response problem by means of mathematical transformations. Desirabilities range from 0 to 1 for given response. The program combines the individual desirabilities into a single number and then searches for the greatest overall desirability. Value 1 represents the ideal case. Value 0 indicates that one or more responses fall outside desirable limits. RSM (Box-Behnken design) and desirability function analysis have been demonstrated to be efficient to optimize burnishing process parameters (burnishing speed, burnishing force and number of passes) for surface roughness of A356/5%SiC under roller burnishing with WC roller. Single response optimization determines how input parameters affect desirability of individual response. The numerical optimization finds a point that maximizes the desirability function.

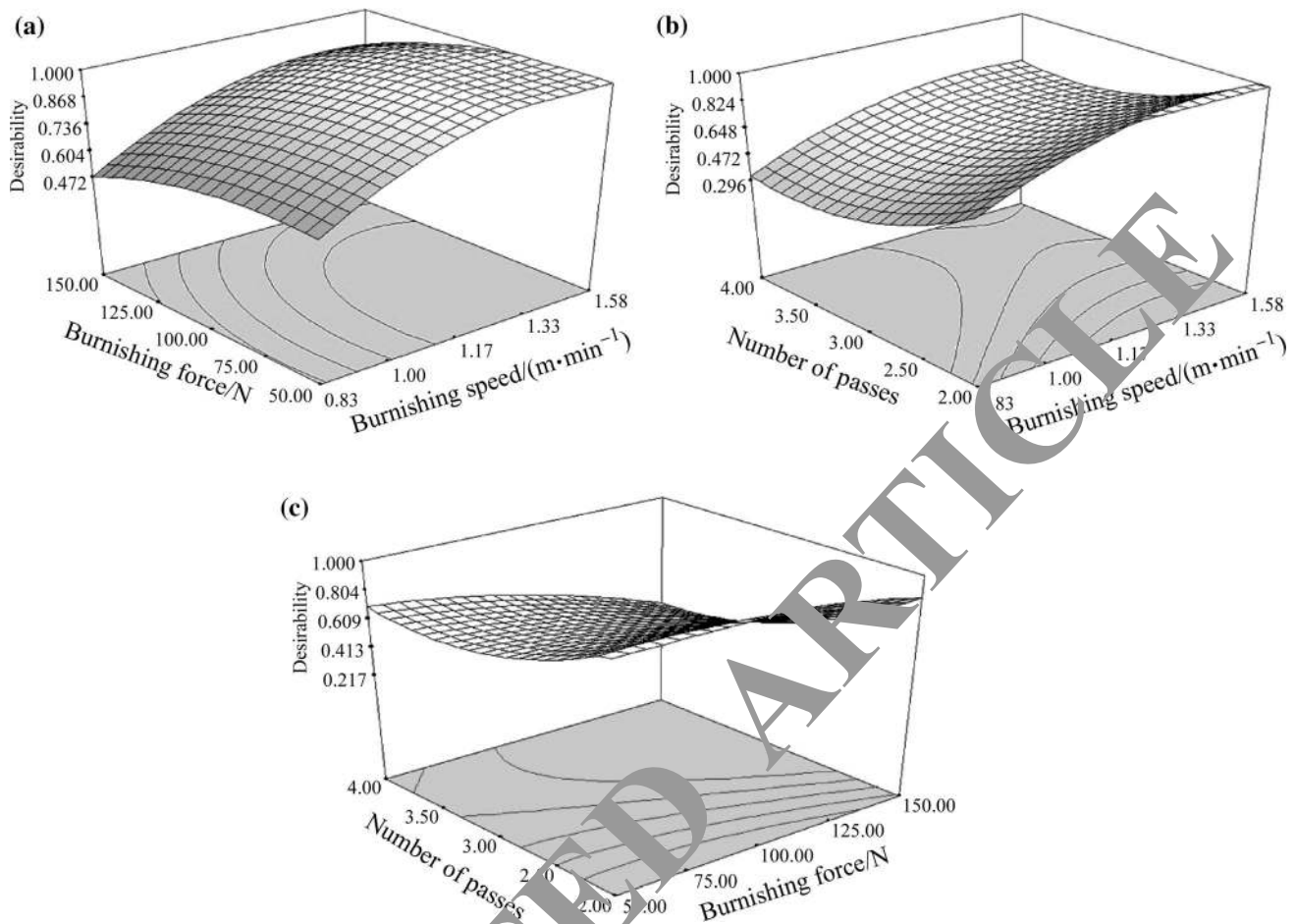

Fig. 15 3D relation between desirability, burnishing speed, burnishing force and number of passes with desirability one. **a** desirability = 1.00, number of passes = 2.05, **b** desirability = 1.00, burnishing force = 61.30 N, **c** desirability = 1.00, burnishing speed = 1.28 m/s

From the ramp function graph, it can be observed that when burnishing speed, burnishing force and number of passes are taken into consideration. The mathematical models, in terms of roller burnishing process parameters, were developed for surface roughness prediction using RSM on the basis of experimental results. The significance of these parameters on surface roughness of A356/5%SiC had been established by ANOVA.

3.6 Effect of roller burnishing process parameters on surface roughness

Burnishing is a superficial plastic deformation process used as a surface smoothing and surface enhancement finishing treatment after some machining processes to generate a compact and wear-resistant surface for longer and efficient component life [29]. In this study, the surface roughness of A356/5%SiC metal matrix composite under roller burnishing with WC roller was established, in which roller

burnishing speed, roller burnishing force and numbers of passes are taken into consideration. The mathematical models, in terms of roller burnishing process parameters, were developed for surface roughness prediction using RSM on the basis of experimental results. The significance of these parameters on surface roughness of A356/5%SiC had been established by ANOVA.

3.6.1 Effect of burnishing speed on surface roughness

The outcomes of the roller burnishing speed with respect to surface roughness are shown in Figs. 17 and 18, respectively. It can be noticed that surface roughness decreases with the increase in roller burnishing speed. There are variations in the surface roughness, when the roller burnishing speed varies. Higher roller burnishing speed (1.5 m/s) increases the surface temperature of workpiece. Metallic bond of metal matrix composite materials becomes soft due to increased surface temperature of

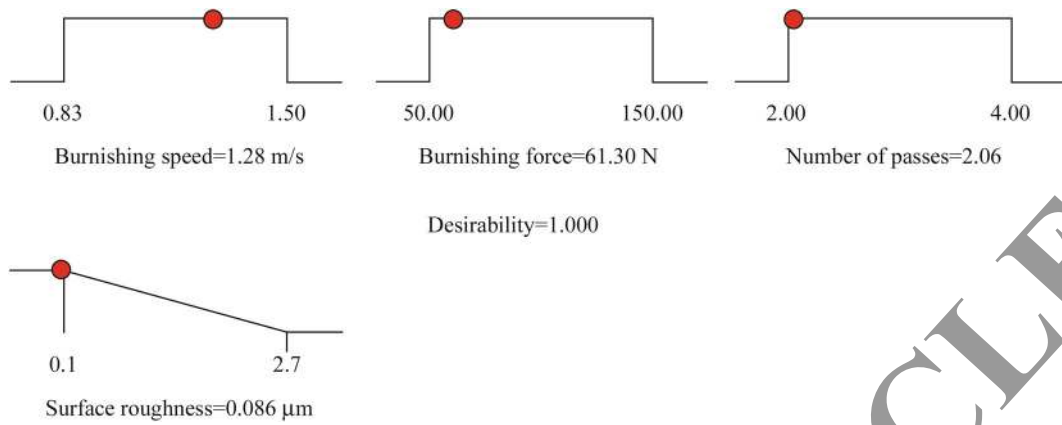

Fig. 16 Ramp function graph for minimum surface roughness with desirability 1

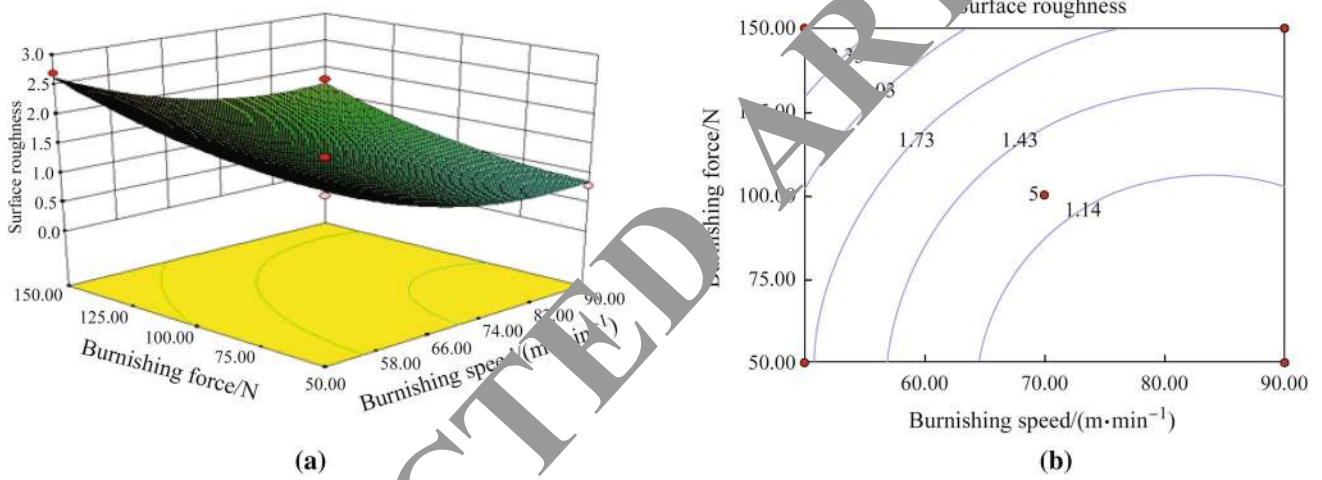

Fig. 17 Interaction effect of surface roughness, burnishing speed and burnishing force a 3D interaction b the contour plot

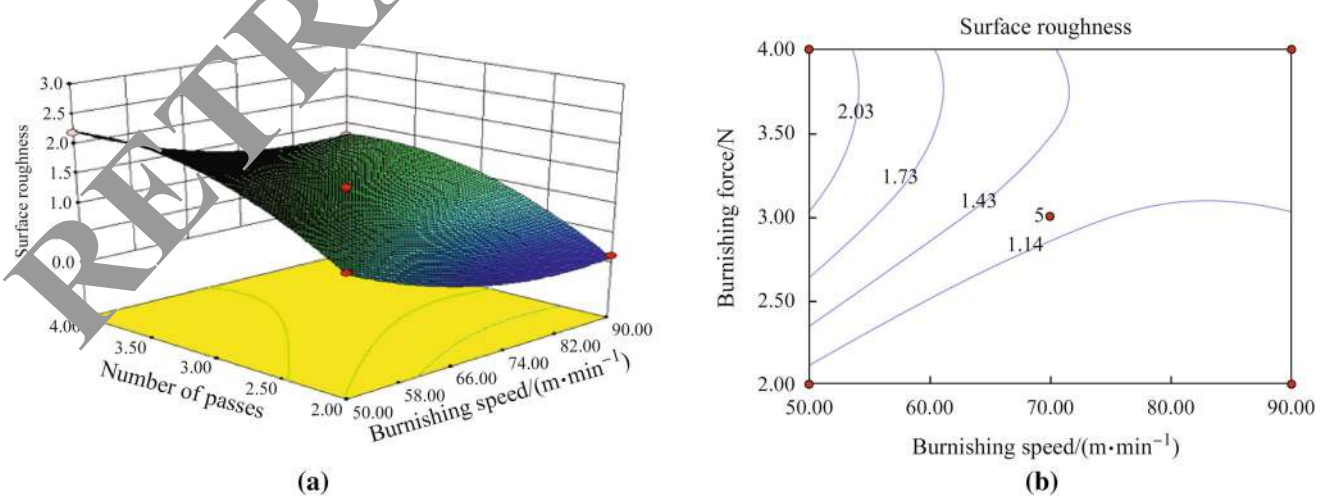

Fig. 18 Interaction effect of surface roughness, burnishing speed and number of passes a 3D interaction b the contour plot

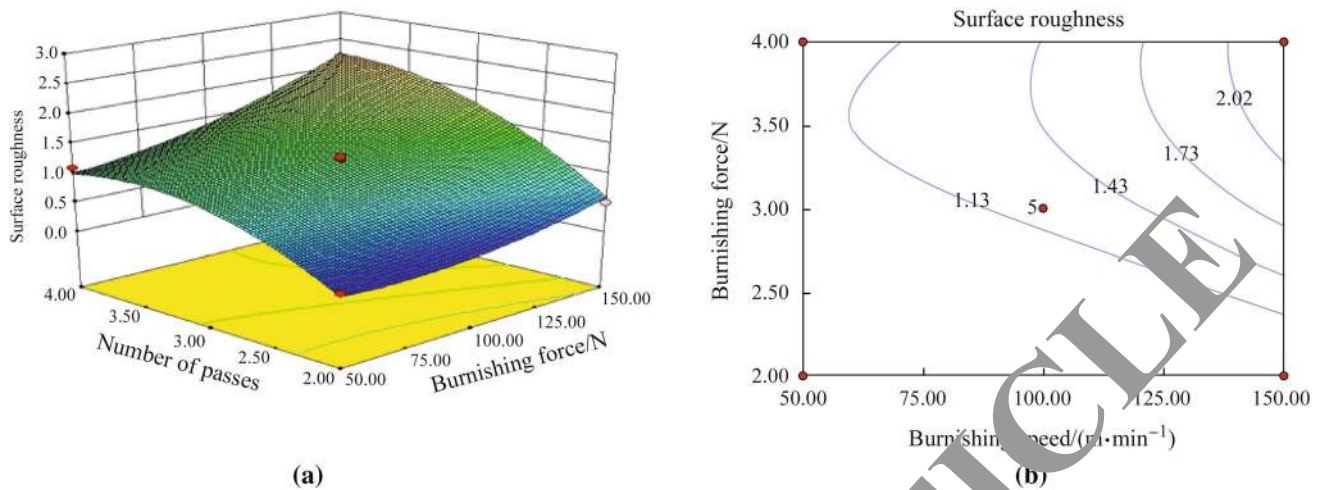

Fig. 19 Interaction effect of surface roughness, burnishing force and number of passes **a** 3D interaction **b** the contour plot

Table 9 Confirmation result

Response	Surface roughness
Prediction / μm	1.232
SD	0.095
SE ($n = 1$)	0.104
95% PI low	0.9859
95%PI high	1.4781

workpiece, and resistance offered by metal matrix composite material against roller burnishing tool becomes low.

3.6.2 Effect of burnishing force on surface roughness

The effect of variation in burnishing force (from 50 N to 150 N) on the surface roughness of roller burnished A356/5%SiC metal matrix composite is evaluated, as shown in Figs. 17 and 19. The low surface roughness values of roller burnished A356/5%SiC composites are observed at lower burnishing force (50 N). It was observed that an opposite effect was seen when increasing the burnishing force as compared to burnishing speed. By increasing the burnishing force, the surface roughness is increased. The increase in burnishing force increases friction between roller burnishing and A356/5%SiC composite. Due to higher friction, higher surface roughness is observed.

3.6.3 Effect of number of passes on surface roughness

The surface roughness, roller burnishing speed, roller burnishing force and number of passes are plotted in Figs. 18 and 19 for variable roller burnishing process parameters. It is observed that surface roughness at lower

number of passes (2) is lesser, whereas at higher number of passes (4) is higher. It means that, with an increase number of passes, the surface roughness increases. It can be described as the increase in the number of passes value from 2 to 4, friction between WC roller and silicon carbide particles (SiC_p) of A356/5%SiC composite during roller burnishing increases. This increased friction between roller and composite material produces rough surface of carbide rollers, and increases the value of surface roughness of A356/5%SiC metal matrix composites.

3.7 Confirmation experiment

By evaluating the surface roughness of A356/5%SiC metal matrix composites under roller burnishing with WC roller, the average feasible predicted surface roughness is found to be 1.232 μm , as exhibited in Table 9. Importance of process parameters can be ranked from their F values which are indicated in Table 8. From Table 8, it can be concluded that number of passes of WC roller is contributing more and it is followed by roller burnishing speed and roller burnishing force. The experimental surface roughness (average of three test samples) corresponding to these parameters (burnishing speed of 1.5 m/s, burnishing force of 50 N and number of passes of 2) is found to be 1.17 μm . This shows that there is approximately 5.032% error between the experimental and modeled results. Hence, the developed model can be effectively used in the process parameter range to predict the surface roughness.

4 Conclusions

The following conclusions can be drawn from above analysis:

- (i) SEM micrographs of the surfaces of A356/5%SiC metal matrix composites generated under conditions in roller burnishing with WC roller show much smooth surface as compared to surface generated under condition in turning with PCD (insert-10) tool. Average surface roughness of machined A356/5%SiC composites with PCD (insert-10) tool is observed 3.732 μm , while the average surface roughness of roller burnished samples with WC roller is observed 1.232 μm (predicted). Reduced surface roughness of A356/5%SiC metal matrix composite under roller burnishing is 66.98%. Average tensile strength of machined A356/5%SiC composite with PCD (insert-10) tool is 300.2 MPa. While after the roller burnishing with WC rollers, it is 305.80 MPa. Tensile strength has improved by 1.81%. The average value of percentage elongation (ductility) of machined A356/5%SiC composites with PCD (insert-10) tool is 5.84. On the other hand average percentage of elongation of composite under roller burnishing was found to be 6.83. Improved ductility of A356/5%SiC metal matrix composite under roller burnishing is found 14.49%. From the results, average hardness of machined A356/5%SiC composite with PCD (insert-10) tool is 83.38 BHN, after the roller burnishing with WC roller 6.13% hardness improves. Within the chosen roller burnishing process parameters range, higher roller burnishing speed (1.5 m/s), lower roller burnishing force (50 N), and lower number of passes (2) are preferred for good surface finish of A356/5%SiC metal matrix composite under roller burnishing with WC roller.
- (ii) Within the roller burnishing process parameters range, surface roughness of A356/5%SiC decreases. By increasing the roller burnishing speed while increasing the roller burnishing force and number of passes from minimum to maximum values, the surface roughness of A356/5%SiC composite increases. Based on ANOVA, roller burnishing speed, roller burnishing force, and number of passes are found to be suitable for surface roughness with regression p -value less than 0.05 and lack of fit more than 0.05. Within the roller burnishing process parameters range, it is found that the parameters which affect the surface roughness in descending order are as follows: number of passes, roller burnishing speed and roller burnishing force. The minimum value of surface roughness with desirability 1 is obtained to be 0.086 μm at roller burnishing speed of 1.28 m/s, burnishing force of 61.30 N and number of passes of 2.06. An empirical relationship has been developed to predict the surface roughness incorporat-

ing roller burnishing process parameters at 95% confidence level. The predicted value for surface roughness is found 1.232 μm . There is only 5.032% error in the experimental and modeled results.

References

1. Yan BH, Wang CC, Chow HM et al (2000) Feasibility study of rotary electrical discharge machining with ball burnishing for $\text{Al}_2\text{O}_3/6061\text{Al}$ composite. *Int J Machine Tools Manuf* 40(10): 1403–1421
2. Gharbi F, Sghaier S, Hamdi H et al (2012) Ductility improvement of Al 1050A rolled sheet by a newly designed ball burnishing tool device. *Int J Adv Manuf Technol* 67:67–99
3. Lopez de Lacalle LN, Lamikiz A, Sanchez JA et al (2007) The effect of ball burnishing on heat-treated steel and Inconel 718 milled surfaces. *Int J Adv Manuf Technol* 32:958–968
4. El-Axir MH (2000) An investigation into roller burnishing. *Int J Machine Tools Manuf* 40(11):1603–1617
5. El-Khabaz M, El-Axir MH (2001) Experimental techniques for studying the effects of milling roller-burnishing parameters on surface integrity. *Int J Machine Tools Manuf* 41(12):1705–1719
6. Luo H, Liu J, Wang L, Zhong Q (2005) Investigation of the burnishing process with PCD tool on non-ferrous metals. *Int J Adv Manuf Technol* 25:454–459
7. Luo H, Liu J, Wang L, Wang Q (2006) The effect of burnishing parameters on burnishing force and surface microhardness. *Int J Adv Manuf Technol* 28:707–713
8. Luo H, Liu J, Wang L, Zhong Q (2006) Study of the mechanism of the burnishing process with cylindrical polycrystalline diamond tools. *J Mater Process Technol* 180:9–16
9. Yeldose BC, Ramamoorthy B (2008) An investigation into the high performance of TiN-coated rollers in burnishing process. *J Mater Process Technol* 207:350–355
10. El-Taweel TA, El-Axir MH (2009) Analysis and optimization of the ball burnishing process through the Taguchi technique. *Int J Adv Manuf Technol* 41:301–310
11. Klocke F, Backer V, Wegner H et al (2009) Influence of process and geometry parameters on the surface layer state after roller burnishing of IN718. *Prod Eng Res Dev* 3:391–399
12. Franzen V, Trompeter M, Brosius A et al (2010) Finishing of thermally sprayed tool coatings for sheet metal forming operations by roller burnishing. *Int J Mater Form* 3(1):147–150
13. Aysun S (2011) Analysis and optimization of surface roughness in the ball burnishing process using response surface methodology and desirability function. *Adv Eng Softw* 42:992–998
14. Korzynski M, Lubas J, Swirad S et al (2011) Surface layer characteristics due to slide diamond burnishing with a cylindrical-ended tool. *J Mater Process Technol* 211:84–94
15. Swirad S (2011) The surface texture analysis after sliding burnishing with cylindrical elements. *Wear* 271:576–581
16. Tadic B, Todorovic PM, Luzanin O et al (2013) Using specially designed high-stiffness burnishing tool to achieve high-quality surface finish. *Int J Adv Manuf Technol* 67:601–611
17. Balland P, Tabourot L, Degre F et al (2013) An investigation of the mechanics of roller burnishing through finite element simulation and experiments. *Int J Machine Tools Manuf* 65:29–36
18. Balland P, Tabourot L, Degre F et al (2013) Mechanics of the burnishing process. *Precis Eng* 37:129–134
19. Dwivedi SP, Kumar S, Kumar A (2012) Effect of turning parameters on surface roughness of A356/5% SiC composite

- produced by electromagnetic stir casting. *J Mech Sci Technol* 26(12):3973–3979
20. Muralidharan R, Ramana GR (2013) Thermal plasma synthesis of SiC. *Adv Manuf* 1:50–61
 21. Rao TB, Gopala Krishna A (2013) Simultaneous optimization of multiple performance characteristics in WEDM for machining ZC63/SiCp MMC. *Adv Manuf* 1:265–275
 22. El-Tayeb NSM, Low KO, Brevern PV (2007) Influence of roller burnishing contact width and burnishing orientation on surface quality and tribological behaviour of Aluminium 6061. *J Mater Process Technol* 186:272–278
 23. Dwivedi SP, Sharma S, Mishra K (2014) Microstructure and mechanical behavior of A356/SiC/Fly-ash hybrid composites produced by electromagnetic stir casting. *J Braz Soc Mech Sci Eng* 1–11
 24. Wang G, Rong YM (2013) Advances of physics-based precision modeling and simulation for manufacturing processes. *Adv Manuf* 1:75–81
 25. Chen SL, Cao WS, Zhang F et al (2013) Development of a computational tool for materials design. *Adv Manuf* 1:123–129
 26. Kosaraju S, Anne VG (2013) Optimal machining conditions for turning Ti–6Al–4V using response surface methodology. *Adv Manuf* 1:329–339
 27. Xu Y, Gao F, Zhang B et al (2013) Technology of self-repairing and reinforcement of metal worn surface. *Adv Manuf* 1:102–105
 28. Lu WC, Ji XB, Li MJ et al (2013) Using support vector machine for materials design. *Adv Manuf* 1:151–159
 29. Li FL, Xia W, Zhou ZY et al (2015) Analytical prediction and experimental verification of surface roughness during the burnishing process. *Int J Machine Tools Manuf* 92:67–75

RETRACTED ARTICLE