



## Effects of surfaces nanocrystallization induced by shot peening on material properties : a Review

Sara Bagheri Fard, Mario Guagliano

*Dipartimento di Meccanica, Politecnico di Milano, Via La Masa 1, 20156 Milan, Italy*

---

**RIASSUNTO.** Si presenta una breve descrizione del processo di nanocristallizzazione delle superfici per mezzo di deformazioni plastiche severe. In particolare, si concentra l'attenzione sui processi di pallinatura che fino ad oggi si sono dimostrati efficaci per ottenere superfici nano strutturate e se ne descrive lo stato dell'arte. L'influenza del processo utilizzato sul comportamento del materiale in relazione alle differenti proprietà di interesse è, poi, analizzata criticamente.

Infine, sulla base delle attuali conoscenze si tracciano e sottolineano alcuni possibili sviluppi di ricerca in questo settore.

**ABSTRACT.** A brief description of surface nanocrystallization process via severe plastic deformation is presented. To come to the point different shot peening methods which have proved to be able to create nanocrystalline layers are demonstrated clarifying the actual state of the art. Then the influence of the process is reviewed on material behavior and a wide range of affected properties are investigated. On this basis some possible addresses for future research in this field are drawn and underlined.

**KEYWORDS.** Shot peening, Nanocrystallization, High energy, Surface treatments, Severe plastic deformation (SPD).

---

### INTRODUCTION

In the last few decades, ultrafine-grained materials, especially nanocrystalline (NC) characterized by crystal grains with dimensions up to 100 nm, have attracted considerable scientific interest, since nanostructured materials are expected to possess superior mechanical properties in simple chemical compositions fundamentally different from their conventional coarse-grained polycrystalline counterparts [1-10].

Actually, the majority of failures of engineering materials such as fatigue fracture, fretting fatigue, wear and corrosion, etc are very sensitive to the structure and properties of the material surface, and in most cases material failures originate from the surface. Accordingly, it is recommended that the entire components made of NC materials may not be necessary in many applications, particularly in components subjected to fatigue and merely optimization of the surface structure and properties may effectively enhance the global behavior and the service lifetime of materials. Thus surface nanocrystallization is expected to greatly enhance the surface property without changing the chemical compositions and shape of materials [11].

Among various methods proposed to produce ultrafine-grained materials, severe plastic deformation (SPD) technique has received the greatest attention due to its simplicity and applicability for all classes of materials. Although submicron grained materials can be successfully produced by most SPD processes, NC materials are obtained only by non-homogeneous deformation processes with large strain gradients[12-19].

The basis of the SPD method is to increase the free energy of the polycrystals and generate much more defects and interfaces (grain boundaries) in various nonequilibrium processes such as high-pressure torsion [6, 8, 20-23], ball milling [24-35], sliding wear [36, 37], drilling [38-42], shot blasting and annealing [43-46], ultrasonic shot peening [15, 47-52] and air blast shot peening [16, 17, 39, 50, 53-55].

---



Among the mentioned techniques, shot peening is a very well known method used to increase the performance of components in different service conditions. Fatigue, rolling contact fatigue, fretting and stress corrosion are operative situations where shot peening can strongly improve the performance of mechanical parts and structural elements. The present study focuses on the application of shot peening processes to obtain NC surfaces as this technique is a popular process in industries widely used due to its flexibility, which makes it possible to be used for components of almost any shape. It can be performed on commercial scale to provide NC layers with a high productivity. The paper is written with the aim to describe the actual state of the art and review different properties of NC layered materials in order to describe the effect of Nanocrystallization on material behavior. On this basis some possible addresses for future research in this field are drawn and underlined.

## SURFACE NANOCRYSTALLIZATION

As stated before, the key point of surface nanocrystallization process of a bulk material is to introduce a large amount of defects and/or interfaces into the surface layer so that its microstructure is transformed into nano-sized crystallites while the structure of the coarse-grained matrix remains unchanged without any associated changes in the cross sectional dimensions of the samples [56].

Observations of these processes have revealed a rearrangement of dislocations during the process in the way that they move from the grain interiors to the region near the grain boundaries [10]. A schematic illustration of the defect rearrangement is presented in Fig. 1. The figure emphasizes that the local density of dislocations at grain boundaries grows, thus increasing their non-equilibrium.

Typical optical microscopic images of treated surfaces which can describe the initiation of nanocrystals are shown in Fig. 2.

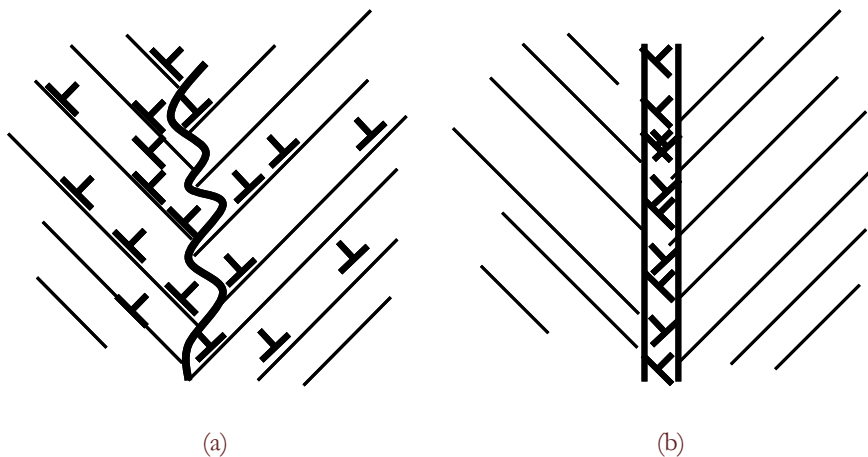

Figure 1: Arrangement of grain boundaries in nanostructured layers:  
 (a) the dislocation structure during SPD processing  
 (b) the dislocation structure after SPD processing leading to formation of non-equilibrium grain boundaries.

## SHOT PEENING

Shot peening (SP) is a mechanical surface treatment in which small spherical peening media with sufficient hardness are accelerated in peening device of various kinds and impact with the surface of the treated work piece with a quantity of energy able to cause surface plastic deformation. The aim of the process is the creation of compressive residual stresses close to the surface and the work hardening of the same layer of material. These effects are very useful in order to totally prevent or greatly retard the failure of the part [58-62]. There are a lot of papers about the ability of SP to improve the mechanical behavior of materials [62-66]. And most of them affirm that the effect of shot peening is mainly related to the induced residual stresses. Miller also hypothesized that shot peening effect could be related to grain distortion and to the increased microstructural barriers. He proposed that due to the multiplication of structural defects and dislocations, a crack would propagate with more difficulty in work-hardened surfaces [67]. Recent results show that in some cases surface hardening can be considered as the main cause of modified behavior of shot peened materials [68, 69].

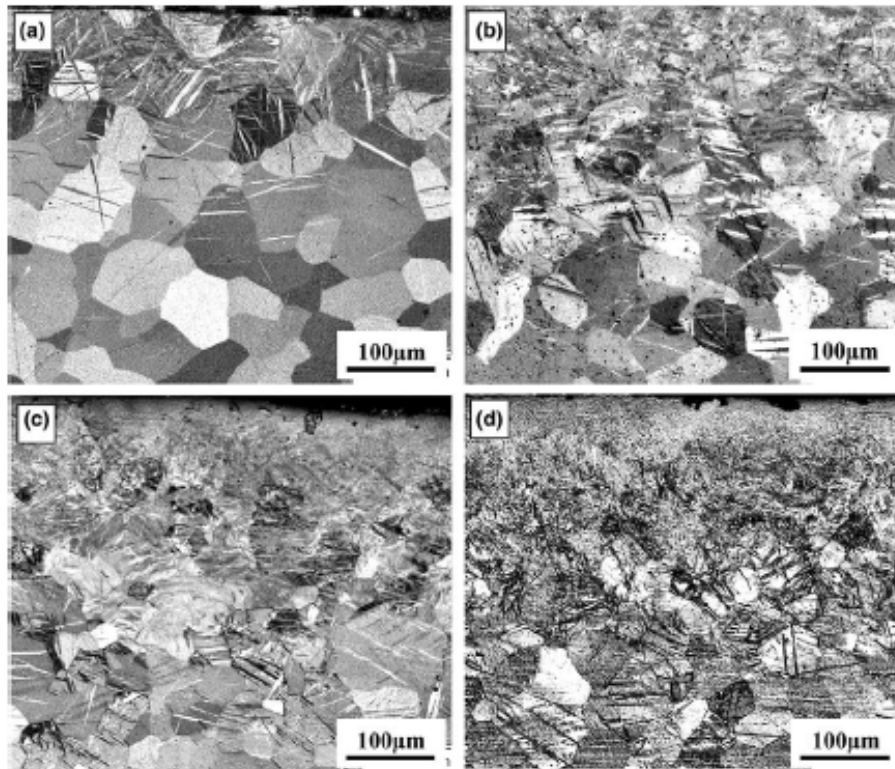

Figure 2: Typical cross-sectional optical micrographs close to the SMAT-treated surfaces under different treating conditions (annealed, commercially pure titanium specimens): (a) vibration amplitude 50%, treatment time 10s; (b) vibration amplitude 50%, treatment time 16s; (c) vibration amplitude 100%, treatment time 30s; (d) vibration amplitude 100%, treatment time 60s [57].

Bearing this fact in mind, it is natural to think to shot peening as a treatment effectual to obtain nanostructured materials. The concept of nanocrystallization by shot peening is that during the process with the hit of high energy particles, many pits and also extruded ridges around the edge of the pit are formed on the surface. When the ridge is hit by another particle, the contact area between sample and the particle can decrease significantly, therefore the strain and strain rate can be increased. Additionally, the collision mode also is changed from single direction to multiple directions due to the ridge, which is more favorable to the accumulation of dislocations. With the proceeding of collisions, some areas will approach the critical condition of nanocrystallization after several suitable hits [19].

Recent researches have successfully shown that different shot peening processes are able to introduce nanostructured layers with different characteristics, as concern their depth, the dimension of the crystals and microstructural properties. These methods are different both for the needed technological facilities and also for the mechanics of the treatment itself. Here is a very brief introduction about each of these processes:

### *Shot blasting*

In this method, in order to obtain nanolayers the specimen's surface is sandblasted repeatedly by high-speed sand particles and then subsequently annealed [43-46]. In contrast to other SP methods, in shot blasting the size and also the geometry of shots are typically random and accidental and generally speaking shot sizes are smaller in comparison with the shots used in air blast shot peening. The sandblasted surface layer is heavily (plastically) deformed and consequently have high-density dislocations. After annealing, the initially formed dislocation network or fine "sub-grains" will change to nanosized grains with sharper grain boundaries. It is observed that the mechanical properties of the sandblasted surface are commonly inferior to those of the sandblast-annealed surface [44,45] and it can attributed to the different characteristics of nanograins after annealing.

### *Air blast shot peening (ABSP)*

ABSP is a SP process through which the shots are projected by compressed air. The schematic of the equipment is illustrated in Fig.3. In air blast shot peening, NC is produced when higher shot speed and larger coverage than

conventional operation is applied [17]. In ABSP, the shot velocity has a narrow distribution and the impact direction of shot to specimen is almost perpendicular [50].

Air pressure, shot size and shot materials are the process parameters that mainly affect the results of the treatment and the characteristic of the NC surface.

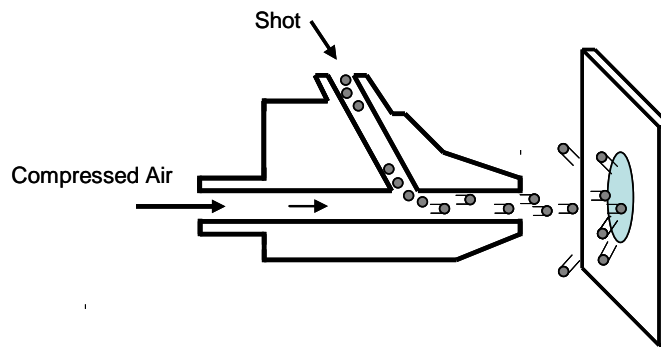

Figure 3: Schematic illustration showing the equipment of ABSP.

#### *Ultra sonic shot peening*

In Fig. 4 experimental set-up of USSP called at times (SMAT) is illustrated. In this method shots are resonated by vibration of an ultrasonic transducer and the impact directions of the balls onto the sample surface are rather random. Repeated multidirectional impacts at high strain rates onto the sample surface result in severe plastic deformation and grain refinement progressively down to the nanometer regime in the entire sample surface [64-70]. Obvious enhancement in the overall properties and performance of the materials is observed after the SMAT treatment [15, 47, 48, 70-76].

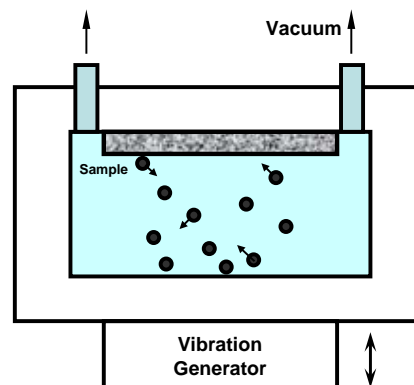

Figure 4: Sketch of SMAT

#### *Surface nanocrystallization and hardening*

In SNH method the specimen is loaded at one end of a cylindrical container. The disc is held in place via mechanical locking. Some balls with diameters normally bigger with those used in other peening methods are loaded into the container. The high velocity of the balls is commonly achieved by shaking the container three dimensionally using a Spex 8000 Mill. Such 3D shaking provides kinetic energy to the balls and generates the complex pattern of motion of the balls inside the container [77-80].

This method like previous mentioned ones can provide structural metallic components with several desired features, such as compressive residual stress, work hardened surface layer and also nanocrystalline surface [81-85].

#### *High energy shot peening*

High-energy shot peening (HESP) is another method reported to be capable of synthesis of nanostructured surface layers. The principle of the HESP treatment is very similar to that of the USSP method, but with lower frequency and bigger shots. Similar to previous methods, the entire surface of the sample to be treated is peened by the flying shots with a high energy and the NC layer is achieved using different durations for peening [86].

## EXPERIMENTAL INVESTIGATIONS ON NC SURFACES OBTAINED BY SHOT PEENING

SP processes to obtain NC layers have been successfully used on a variety of materials including pure metals, alloys and intermetallics. Majority of these experiments have included characterization of structure and properties of the surface layers by scanning electron microscopy (SEM), transmission electron microscopy (TEM), microhardness, scratch and so many other tests in order to assess the contribution of the process to improvement of material behavior. Here some notable effects of surface nanocrystallization on special properties which have been studied in literature are discussed.

### *Fatigue*

Since most fatigue cracks initiate from the surface and propagate to the interior, a component with a nanostructured surface layer and coarse-grained interior is expected to have highly improved fatigue properties because both fatigue-crack initiation and propagation are inhibited by fine grains near the surface and coarse grains in the interior, respectively. Moreover, the residual compressive stresses introduced during the severe plastic-deformation process can also effectively stop or retard the initiation and propagation of fatigue cracks [71-74].

There are so many results confirming improvement of fatigue life of different materials using SP nanocrystallization methods [46, 62, 80, 81, 84, 85, 87].

In an experiment conducted by SNH process, a C-2000 alloy was treated by Five tungsten carbide and cobalt balls with a diameter of 7.9 mm for duration times of 30, 60, 90, and 180 min. load-controlled four-point-bend fatigue tests revealed that the surface nanocrystallization process affected the fatigue behavior of the material in two ways: the nanostructured surface layer, work-hardened region, and residual compressive stresses could enhance the fatigue strength especially in the high-cycle fatigue range ( $> 10^6$  cycles), while the surface contamination and micro-damages caused by the SNH process could somehow deteriorate the fatigue strength. As shown in Fig. 5, the 30 min treatment resulted in the best improvement in the fatigue resistance, while prolonged treatments (60, 90, and 180 min) either led to no improvements or even decreases in the fatigue resistance. In the shorter cycle fatigue range ( $< 10^6$  cycles), the fatigue lifetimes of all the treated samples except the 30-min treated sample were lower than those of the as-received one. The longer the processing time, the lower the fatigue lifetimes in shorter cycle fatigue range. Thus, to fully utilize the SNH process to improve the fatigue behavior of the material with a nanostructured surface layer, processing conditions need to be optimized [80].

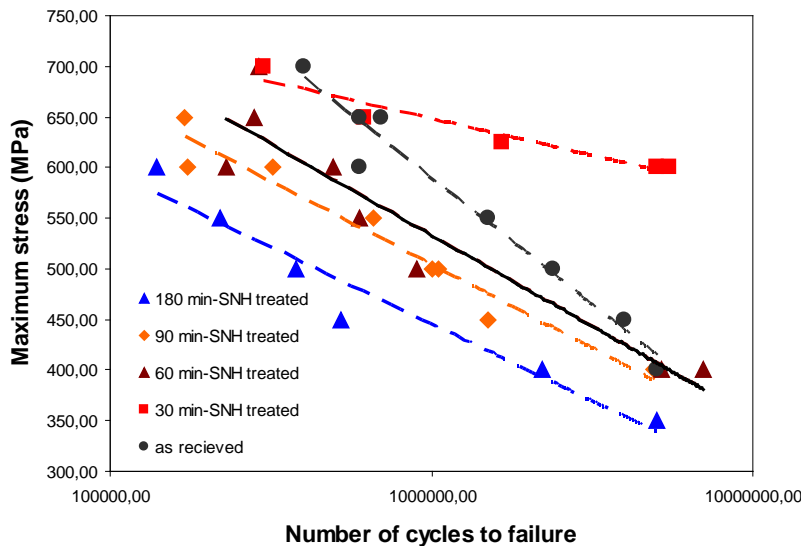

Figure 5: Fatigue behavior of SNH treated Ni-based C-2000 super alloy samples [80].

Specimens of the austenitic stainless steel AISI 304 were also shot peened using S170R with coverage of 98% and Almen intensities of 0.175, or 0.120 mmA, respectively. Tension/compression fatigue tests were performed under stress control without mean stresses ( $R = -1$ ) with a cycling frequency of 5 Hz. The investigations revealed that the microstructural changes severely influence the cyclic deformation behavior of the near surface regions as well as of the soft specimen



core: plastic strain amplitudes and cyclic creep were drastically decreased by shot peening. Furthermore, fatigue crack growth rates are markedly reduced by this mechanical surface treatment.

Remarkably, as illustrated in Fig. 6, the initial residual stress profile and surface strain hardening were not completely eliminated even by applying high cyclic stress amplitudes [62].

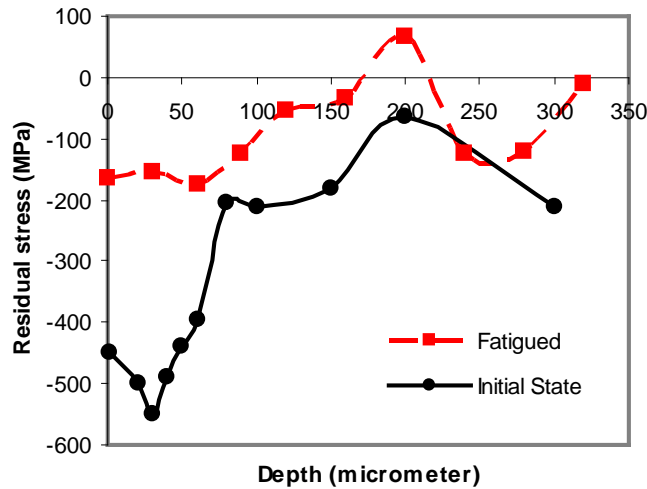

Figure 6: Residual stress depth profiles of shot peened (Almen intensity 0.175 mmA) AISI 304 before and after cyclic loading with  $\sigma_a = 320 MPa$  after  $N_f/2$  cycles [62].

### Elastic modulus

Elastic modulus is another improved characteristic of SP surface crystallized specimens studied by some researchers [44, 88].

In an SMAT experiment conducted on annealed commercially pure titanium, the results demonstrated that maximum value of the elastic modulus at the top surface showed an increase of about 16% in comparison with the untreated sample. The SMAT was performed in air at room temperature with stainless steel balls 3 mm in diameter, for 30 min, at a vibration frequency of 20. The results seem to indicate that the increase of modulus from the bulk to the surface follows the grain refinement and as it can be seen in Fig. 7 the elasticity modulus decreases as a function of distance from the treated surface [88].

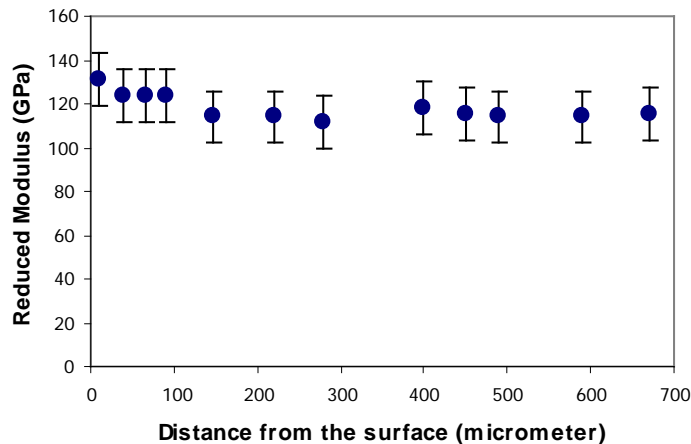

Figure 7: Reduced modulus versus the distance for the sample surface for a load  $P=10$  mN [88].

In another experiment performed on commercial brass, samples were sand blasted under a blasting pressure of 300 kPa for 10 min to produce nanocrystalline surface layers. The sand flow rate was  $5 \text{ gs}^{-1}$ . The samples were then annealed at 150, 250, 350, 500 and 600 °C, respectively, for 1h and cooled in air to obtain different grain sizes in the sandblasted surface layer. The nanocrystallization resulted in improved elastic behavior. It is said that this happened because the elastic limit or the yield strength was increased when the dislocation motion was retarded by grain boundaries [44].

### *Chemical reaction kinetics*

Gaseous nitriding is one of the most widely used surface modification techniques to improve the surface hardness, anticorrosion properties and wear resistance of metallic materials by formation of a surface nitrided layer. However nitriding processes are performed at relatively high temperatures (550°C-600°C) for a long duration and may induce serious deterioration of the substrate in many families of materials. It has been experimentally demonstrated that chemical reaction kinetics are greatly enhanced when the grain size is significantly reduced to the nanometer scale. Since mechanically induced nanostructures store a large excess energy in the grain boundaries and grain interior in the form of non-equilibrium defects, which constitute an extra driving force for the nitride formation process that may further facilitate their chemical reactivity [89-92].

Investigations have reported that surface nanocrystallization of elemental iron samples with a purity of 99.95 wt. % specimens via SMAT performed in an apparatus in which steel balls (8 mm in diameter) vibrated by a generator with a frequency of 3 kHz repeatedly stroke the sample surface, greatly enhances the nitriding kinetics and reduces the activation energy for the diffusion of nitrogen significantly. It has been found that the nitriding temperature of iron processed by SMAT can be reduced to 300 °C, which is at least 200 °C below the conventional nitriding temperature [93].

In another experiment stainless steel balls (with a mirror like surface and a diameter of 8 mm) struck an iron sample with a purity of 99.95 wt.% at the bottom of a cylinder-shaped vacuum chamber attached to a vibration generator (50 Hz) within 60 min, the grains in the surface layer were effectively refined into the nanometer scale. The sample was protected by a high-purity Argon atmosphere during the SMAT to avoid oxidation. The experimental evidence confirmed that the mechanically induced surface nanocrystallization of Fe created a considerable amount of stored energy in the surface layer that constituted an effective driving force for the nitriding process at low temperatures [94].

The reduced nitriding temperature is of considerable importance seeing that it may allow for the nitriding of material families (such as alloys and steels) and work-pieces that cannot be treated by conventional nitriding.

### *Wear, coefficients of friction and scratch resistance*

The process of microstructure refinement also has proved to lead to an enhancement of the wear, friction and scratch resistance [44,73,88,93-95].

The coefficients of friction and penetration curves for iron SMAT treated samples (stainless steel shots with a diameter of 8 and the vibration generator of 50 Hz within duration of 60 min) were measured in an experiment. Results showed that the coefficient of friction of the treated sample ( $0.38 \pm 0.06$ ) was considerably smaller than that of the original sample ( $0.52 \pm 0.03$ ).

The nanoscratch experiments were repeated several times with very consistent results, indicating enhanced wear and friction resistance of the surface layer after SMAT and nitriding [94].

In another experiment the hardness on top surface nanostructured layer of SMAT treated pure Fe bulk samples, reaches a value as high as about twice that of the coarse-grained matrix. Also the wear and friction measurements on a SMAT low-carbon steel sheet showed that the wear volume loss is lower than that of the untreated original one. As it is clear in Fig. 8, the friction coefficient values at different applied loads for the as-treated sample are evidently smaller (about a half) than those of the original sample [73].

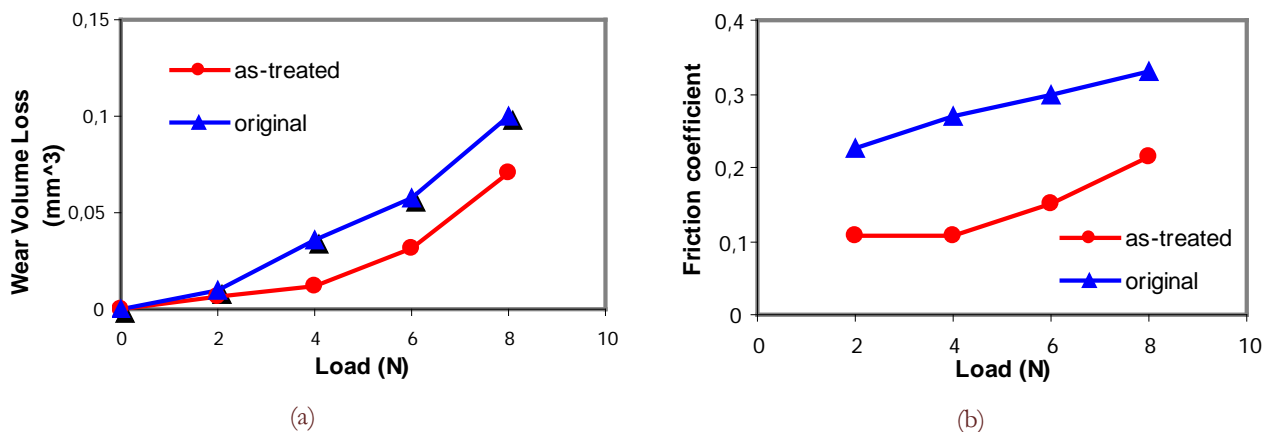

Figure 8. Variations of the wear volume loss with load (a) and variations of the coefficient of friction with load (b) for the SMAT and the original low-carbon steel samples [73].

The nanostructured surface layer of pure titanium SMAT treated in air at room temperature with stainless steel (balls 3 mm in diameter, for 30 min, at a vibration frequency of 20 kHz), also revealed a lower friction coefficient, almost 50% smaller than that of the untreated titanium. And approximately 50% higher scratch resistance at the level of the top nanolayer than its value in the bulk. It can be noticed that the variations of the scratch resistance are very similar to that of the hardness [88].

In another experiment, standard nanoscratch tests have been performed using particular nanoindenters on elemental iron plates (with a purity of 99.95 wt. %) which were SMAT treated: 8 mm diameter steel balls vibrated by a generator with a frequency of 3 kHz. Repeated nanoscratch experiments indicated that the wear and friction resistance of the surface layer treated by SMAT were greatly enhanced [93].

Micro-scratch tests were also performed to evaluate the wear resistances of sandblast-annealed brass samples. The wear resistance of the brass was also considerably improved by nanocrystallization. It was also revealed that with an increase in the annealing temperature; the scratch resistance was lowered significantly. The difference in volume loss reached one order of magnitude larger, when the grain size changed from 20 nm to 80 nm. The increase in the wear resistance by nanocrystallization is consistent with the associated improvement in the mechanical behavior of the material [44].

### Corrosion

There are some results indicating that the corrosion resistance can also be markedly improved by shot peening methods [43, 44, 46,54,55,93].

Jiang et al. carried out corrosive immersion tests on sand blasted 35A commercially pure titanium specimens (treated with SiO<sub>2</sub> particles of 200–300 μm in diameter and compressed air pressure of about 300 psi followed by a recovery treatment below 300 °C, for 30 min with subsequent air cooling). The results indicated that in the surface nano-crystalline layer, the high density of grain boundaries was beneficial to the formation of a thin passive film, which could restrict the movement of metal ions from metal surface to the solution, thus minimizing corrosion and improving polarization behavior of the sandblast-annealed titanium [46].

The effect of air blast shot peening on corrosion resistance in surface nanocrystallization of 1Cr18Ni9Ti stainless steel was also investigated by polarization curves and pit corrosion tests. Shot peening was carried out by a flow of stainless steel balls with a diameter of 0.8 mm under 0.5 MPa for 5 min. It was reported that compared with the as-received coarse crystalline counterpart, the passive film on the surface of shot peened sample is easier to form and is more stable. Shot-peening-induced surface nanocrystallization can markedly enhance the overall and local corrosion resistance of steel in chlorine-ion-contained solution [55]. Fig. 9 shows potentiodynamic polarization curves obtained in 3.5% NaCl solution for shot-peened and as received samples. It is demonstrated that shot peening significantly improved the polarization behavior of stainless steel, not only markedly decreasing anodic current density and passivation-maintaining current density, but also having the tendency of shifting cathodic current density to lower value, and slightly lowering the free corrosion potential. Additionally, shot peening induced a considerably enlarged passive region of stainless steel and raised the breakdown potential of passive film, and for as-received reference samples, there was no remarkable passive region in polarization curve.

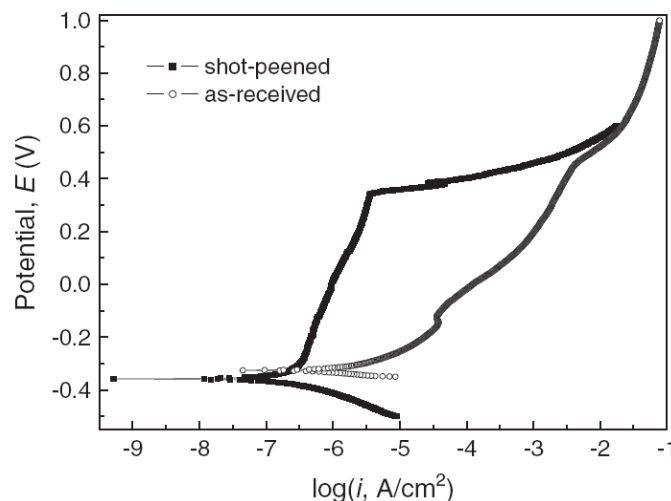

Figure 9: Potentiodynamic polarization curves of shot-peened and as-received samples of 1Cr18Ni9Ti stainless steel obtained in 3.5% NaCl solution [55].



### Thermal stability

In order to investigate thermal stability of nanostructured surface layer, NC layer was fabricated on silicon steel Fe-3.29Si (and also on an ultra low carbon steel) by means of air blast shot peening with different conditions: (shot size and material: SUS304 /0.3 mm- Fe0.8C /0.8 mm- Fe1.0C /0.05 mm, air pressure (MPa) and speed (ms<sup>-1</sup>): 0.4, 50–100, 0.8, 50–100, 0.5, 150–200). After annealing, the nanolayer showed good thermal stability up to 873 K and also a sharp boundary to the underlying work-hardened area which was completely recrystallized. The microstructure of samples with subsequent annealing is shown in Fig. 10. It can be seen that the typical recrystallization occurred in the former work hardening region. On the contrary, no obvious change can be detected in nano region by SEM. The experience indicates that only slight grain growth may be possible in nanograins. However, the grain coalescence due to grain rotation might be the responsible mechanism to slight grain growth in nanocrystallite [19].

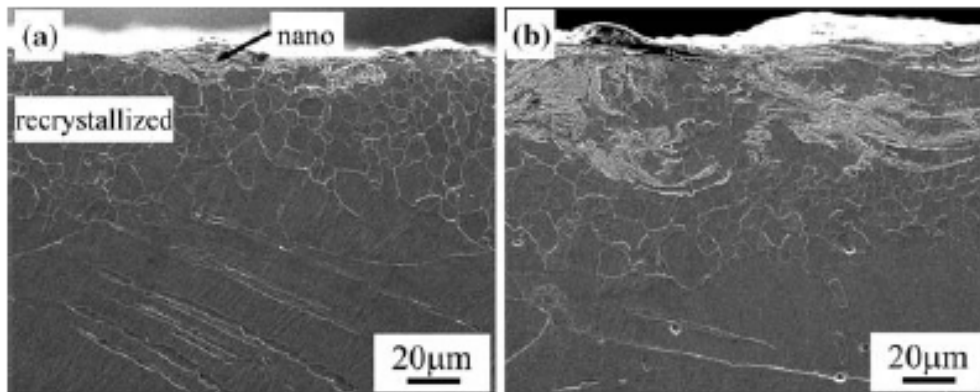

Figure 10. Microstructure of shot peened Fe-3.29Si after annealing at 873 K for 3.6 ks: (a) 3,000%, (b) 10,000% [19].

### Hardness

Some experiments have been conducted in order to investigate the influence of NC process via SP methods on hardness of different materials [73, 80, 93].

All results indicate that the hardness near the treated surface significantly increases, by the SP process, and that the increase of hardness from the bulk to the surface seems to follow the grain refinement as observed by TEM. The variation in hardness with depth agrees well with the structural and compositional analysis results [88, 93].

Published results also demonstrate that the hardness increment from the bulk to the surface cannot be explained by the existence of residual stresses but it is certainly due to another mechanism related to the grain size diminution as the increase of dislocation density and deformation bands [73].

Technological potential of the SNH process has become apparent in preliminary studies where hardness increases dramatically with respect to untreated components. Hardness tests were conducted on C-2000 alloy SNH treated samples (five tungsten carbide and cobalt (94%WC+ 6%Co, in wt%) balls with a diameter of 7.9mm for the duration times of 30, 60, 90, and 180 min). the results showed that compared with the as-received sample, the hardness of the treated sample has been increased substantially [80].

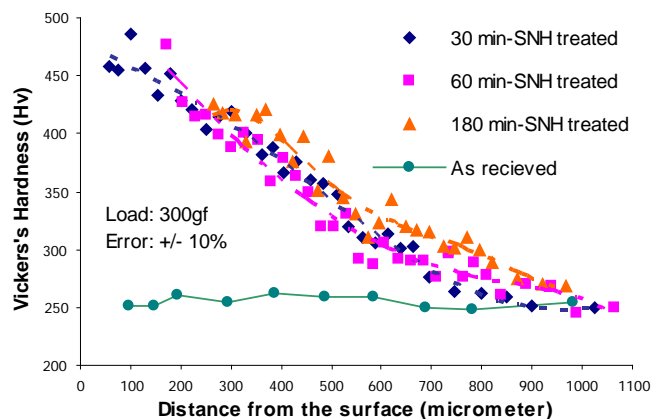

Figure 11: Hardness profile of the samples [80].

Fig. 11 exhibits the microhardness distribution along the depth of the samples. Compared with the as-received sample, hardness of the treated sample has been increased significantly, but the hardness profile does not change much with the processing time. Since work hardening is a consequence of severe plastic-deformation process, it can be seen that after a 30 min treatment, the depth of the deformation-affected zone changes only slightly. In other words, because the intensity of the impact of balls does not change, the plastic-deformation zone remains nearly constant, although it has already been known that the surface nanolayer could continue to extend with the processing time.

### Thermal properties

Thermal properties of shot peened surface nanocrystallized materials have also been studied in some experiments [96,97]. Surface nanocrystallized iron obtained by ultrasonic shot peening with the following process parameters were investigated for thermal properties: material Iron with a purity of 99.95 wt. %, vibration frequency of the chamber driven by ultrasonic generator 20 kHz and the shot diameter of 3 mm. The samples used in the study were treated in vacuum for 400 s at room temperature [97].

It was found that the thermal conductivity of the nanostructured surface layer decreases clearly compared with that of coarse-grained matrix of the sample. The conducted analysis shows that the decrease of thermal conductivity is mainly due to the decrease of the electron and phonon mean free path and to electron and phonon scattering at the grain boundaries. Small grain size with large volume fraction of interfaces within which a large amount of defects as well as high random atomic arrangement may exist, would strongly lead to electron and phonon scattering at grain boundaries. Hence, when electrons and phonons pass the interfaces, they are scattered intensely, that inevitably leads to the reduction of thermal conductivity of the microstructure [97]. In Fig. 12, it is interesting to observe that, from positions 1 to 2, the average image voltage is almost the same, and from positions 3 to 7, the voltage values increase clearly, then they become approximately stable again. The variations in average image voltage imply that, with the refinement of the microstructure, the thermal conductivity decreases clearly.

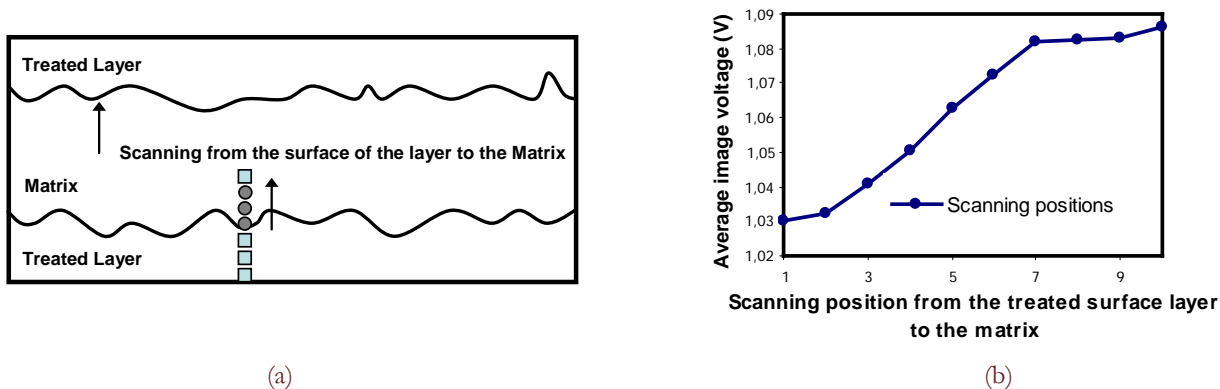

Figure 12: (a) Schematic diagram of the scanning positions from the surface layer to the matrix on the cross-sectional surface. (b) Variation in average image voltage while scanning from the treated surface layer to the matrix as indicated in (a) [97].

In the treated layers, a large value of residual stress was induced by the ultrasonic shot peening, which leads to an important lattice distortion and a high dislocation density. These residual stresses and dislocations can act as both phonon and electron scatterers and thereby reduce the thermal conductivity of the microstructure [96].

### Magnetic properties

Magnetic properties, as an important physical property, have attracted many researchers in ferromagnetic nanocrystalline materials. This phenomenon largely shows dependence on the composition, microstructure, and grain size [98, 99].

Magnetic properties were measured for SMAT Fe-30 wt. % Ni alloy. The samples were first heated and water quenched in order to obtain uniform grain size. Then they were treated at a 50 Hz frequency with spherical stainless steel balls of 8 mm in diameter under vacuum at ambient temperature for different durations from 30 to 90 mins.

The results indicated that the saturation magnetization ( $M_s$ ) and specially coercivity ( $H_c$ ) of the nanostructured surface layer increase significantly compared to the coarse grains sample prior to SMAT. Experimental and theoretical analysis attributed the increase of  $M_s$  to the change of lattice structure resulting from strain-induced martensitic transformation. Meanwhile,  $H_c$  was further increased from residual microstress and superfined grains [98]. The enhancement of material's magnetic properties is significantly favorable for its application in several fields of engineering.



### *Discussion*

It is verified experimentally that the NC regions produced by all SP methods have the following characteristics however in different extents:

- Equiaxed grains of around 20nm
- Extremely high hardness
- Separated from adjacent deformed structure regions with sharp boundaries
- No recrystallization and substantially slow grain growth by annealing
- Dissolution of cementite when it exists
- Surface compressive residual stresses and also work hardening of the surface layer. Accordingly it seems that the main properties of the NC structure are independent of the SP techniques used in the experiment [18].

In order to obtain the desired NC region via any of the mentioned SP methods, a proper combination of different parameters attributable to the enhancement of kinetic energy of the shots shall be chosen. It has been reported that the increase in the kinetic energy per one shot such as the increase in the shot velocity and/or the shot size is the most effective parameter to increase the thickness of NC layer. It is also found that there is a certain critical initial hardness of specimens to produce the NC structure by SP: the NC structure forms when the specimen hardness is lower than the shot hardness [18].

Another important parameter in the formation of NC layers is the coverage technically defined as: the area fraction of specimen surface deformed by shot bombarding. It is revealed that the NC thickness tends to saturate with coverage irrespective of the shot size. On the other hand, the increasing in the coverage is ineffective to increase the maximum thickness of NC layer, the thickness of NC layer is initially increased with coverage but tends to saturate. It is possible to produce the surface NC layers with several 10  $\mu\text{m}$  thick by SP when the kinetic energy (shot size and/or shot velocity) and the coverage are properly controlled [18].

Actually so far apart from assessment of some particular characteristics, no comprehensive comparison between different methods of NC creating SP methods and also no detailed comparison between them and the conventional SP process is available in literature. Just some researchers have studied the effect of a number of parameters and have found some results about the contribution of each to the whole process.

### **CONCLUSION AND SUGGESTIONS**

**T**he formation of NC surface by means of some SP processes is a promising way to improve mechanical properties of metal alloys and in recent years has been the subject of increasing scientific and technological interests. Initial work has been performed to prove the possibility of obtaining NC surfaces by these methods and also to assess the microstructural characteristics of the obtained layers. More recently, Researches have been done to evaluate the mechanical properties of NC surfaces obtained by SP processes. The results of SP experiments demonstrate that these methods are so efficient and undemanding to produce nanocrystalline surfaces and have potential application in various fields of industry. The experiments show that a remarkable improvement can be achieved as regards wear, corrosion and hardness. Fewer investigations are performed on fatigue but also in this case all the results demonstrate an improved behavior after formation of NC layers.

The enhanced material properties of NC materials demonstrate the technological significance of nanomaterials in improving traditional processing techniques even if a clear relation between the modified characteristics and the process parameters is not identified. Therefore it seems commendable to perform more comprehensive investigations on SP methods which provide a new approach for selective surface reactions.

Moreover, it can be concluded that NC layers may not be induced by SP if the impacted energy of small balls is not large enough. Therefore, to fully utilize the SP processes to improve the behavior of the material with a nanostructured surface layer there is an optimized processing condition, which shall be investigated in conjunction with microstructural analysis in future.

Finally SP methods seem to have the potentiality to improve many other material properties not studied in detail up to now such as different surface chemical treatments that are controlled by the diffusion of foreign atoms and many other treatments which may take effect from the grain size. This fact can open new fields of application for shot peening processes, which today are mostly used for enhancing fatigue and fatigue related damage processes.

Accordingly more investigations shall be planned in future to improve the performance of engineering materials used in industry.



## REFERENCES

- [1] R. Birringer, H. Gleiter, H. Klein, P. Marquardt, *Phys Lett A*, 102 (1984) 365.
- [2] R.W. Cahn, *Nature*, 348 (1990) 389.
- [3] R. Bohn, T. Haubopld, R. Birringer, H. Gleiter, *Scr. Metall. Mater.*, 25 (1991) 811.
- [4] K. Lu, J. Wang, W. Wei, *J Appl Phys*, 69 (1991) 522.
- [5] C. Koch, *Mater Sci Forum*, 243 (1992) 88.
- [6] R. Valiev, A. Korznikov, R. Mulyukov, *Mater Sci Eng A*, 168 (1993) 141.
- [7] D. Morris, 'Mechanical behavior of nanostructured materials', Clausthal, Germany: Trans. Tech. Publications Ltd. (1998) 70.
- [8] J. Nagahora, K. Kita, K. Ohtera, *Mater. Sci. Forum.*, 304 (1999) 825.
- [9] T. Kulik, *J. Non-crystalline Solids*, 287 (2001) 145.
- [10] R. Valiev, *Nature materials*, (2004) 3.
- [11] U. Erb, A. El-Sherik, G. Palumbo, K. Aust, *Nanostruct. Mater.*, 2 (1993) 383.
- [12] K. Lu, J. Lu, *J. Mater Sci Technol*, 15 (1999) 193.
- [13] L.C. Jang, C.C. Koch, *Scripta Metal*, 24 (1990) 159.
- [14] R. Valiev, Y. Ivanisenko, E. Rauch, B. Baudelet, *Acta Mater.*, 44 (1996) 4705.
- [15] N.R. Tao, M.L. Sui, J. Ku, K. Lu: *Nanostructured Mater.*, 11 (1999) 433.
- [16] M. Umemoto, Y. Todaka, K. Tsuchiya, *Mater. Trans.*, 44 (2003) 1488.
- [17] M. Umemoto, Y. Todaka, Y. Watanabe, J. Li, K. Tsuchiya, *J. of Metastable and Nanocrystalline Materials*, 24-25 (2005) 571.
- [18] Y. Todaka, M. Umemoto, Y. Watanabe, K. Tsuchiya, *Materials Science Forum*, 503-504 (2006) 669.
- [19] J.L. Liu, M. Umemoto, Y. Todaka, K. Tsuchiya, *J Mater Sci*, 42 (2007) 7716.
- [20] A.V.Korznikov, I.M.Safarov, V.P.Pilyugin, R.Z.Valiev, *Nanostructured Mater.*, 4 (1994) 156.
- [21] R.Z.Valiev, R.K.Islamgaliev, I.V.Alexandrov, *Progress in materials science*, 45 (2000) 103.
- [22] G.E. Abrosimova, A. S. Aronin, S. V. Dobatkin, I. I. Zverkova, D. V. Matveev, O. G. Rybchenko, E. V. Tatyaniin, *Physics of the Solid State*, 49-6 (2007) 1034.
- [23] Y.Todaka, M.Umemoto, J.Yin, Zh.Liu, K.Tsuchiya, *Materials Science and Engineering A*, 462 (2007) 264-268.
- [24] J.S.C. Jang, C.C. Koch, *Scripta Metallurgica et Materialia*, 24 (1990) 1599.
- [25] H. J. Fecht, E. Hellstern, Z. Fu, W.L. Johnson: *Metallurgical and Materials Transactions A*, 21 (1990) 2333.
- [26] C.H. Moelle, H.J. Fecht, *Thermal, Nanostructured Materials*, 6 (1995) 421.
- [27] J. Yin, M. Umemoto, Z. G. Liu, K. Tsuchiy, *ISIJ Int.*, 41 (2001) 1389.
- [28] Y. Todaka, M. Umemoto, K. Tsuchiya, *ISIJ Int.*, 42 (2002) 1429.
- [29] Y. Xu, M. Umemoto, K. Tsuchiya, *Materials Transactions*, 43 (2002) 2205.
- [30] Y. Xu, Z.G. Liu, M. Umemoto, K. Tsuchiya, *Metallurgical and Materials Transactions A*, 33A (2002) 2195.
- [31] Y. Todaka, M. Nakamura, S. Hattori, K. Tsuchiya, M. Umemoto, *J. Japan Inst. Metals*, 66-1 (2002) 34.
- [32] Y. Todaka, P.G. McCormick, K. Tsuchiya, M. Umemoto, *Materials Transactions*, 43 (2002) 667.
- [33] A.L. Ortiz, L. Shaw, *Acta Materialia*, 52 (2004) 2185.
- [34] L. Shaw, H. Lou, *Journal of Materials Science*, 42 (2007) 1415.
- [35] J.W. Tian, K. Dai, J.C. Villegas, L. Shaw, P.K. Liaw, D.L. Klarstrom, A.L. Ortiz: *Material Science and Engineering A*, in press.
- [36] P. Heilmann, W.A.T. Clark, D.A. Rigney, *Acta Metall.*, 31 (1983) 1293.
- [37] D.A. Hughes, D.B. Dawson, J.S. Korellis, L.I. Weingarten, *Wear*, 181-183 (1995) 458.
- [38] Y. Todaka, M. Umemoto, S. Tanaka, K. Tsuchiya, *Materials Transactions*, 45 (2004) 2209.
- [39] Y. Todaka, M. Umemoto, J. Li, K. Tsuchiya, *Review on Advanced Materials Science*, 10 (2005) 409.
- [40] Y. Todaka, M. Umemoto, J. Li, K. Tsuchiya, *J. of Metastable and Nanocrystalline Materials*, 24-25 (2005) 601.
- [41] M. Umemoto, Y. Todaka, J. Li, K. Tsuchiya, *Material Science Forum*, 539-543 (2007) 2787.
- [42] J.G. Li, M. Umemoto, Y. Todaka, K. Tsuchiya, *Journal of Alloys and Compounds*, 434-435 (2007) 290.
- [43] X.Y. Wang, D.Y. Li, *Electrochim. Acta.*, 47 (2002) 3939.
- [44] L. Wang, D.Y. Li, *Surface and coating technology*, 167 (2003) 188.
- [45] L. Wang, D.Y. Li, *Wear*, 255 (2003) 836.
- [46] X.P. Jiang, X.Y. Wang, J.X. Li, D.Y. Li, C.S. Manc, M.J. Shepard, T. Zhai, *Material Science and Engineering A*, 429 (2006) 30.
- [47] G. Liu, J. Lu, K. Lu, *Materials Science and Engineering A*, 286 (2000) 91.



- [48] X. Wu, N. Tao, Y. Hong, B. Xu, J. Lu, K. Lu, *Acta Materialia*, 50 (2002) 2075.
- [49] Z.G. Liu, H.J. Fecht, M. Umemoto, *Material science and Engineering A*, 375-377 (2004) 839.
- [50] Y. Todaka, M. Umemoto, K. Tsuchiya, *Materials Transactions*, 45 (2004) 376.
- [51] F.A. Gao, N. Trannoy, J. Lu, *Material Science and Engineering A*, 369 (2004) 36.
- [52] C. Wen, Z. Chen, B. Huang, Y. Rong, *Metallurgical and Materials Transactions*, 37A (2006) 1413.
- [53] Y. Todaka, M. Umemoto, Y. Watanabe, K. Tsuchiya, *Transactions of Materials Research Society of Japan*, 29 (2004) 3523.
- [54] K.S. Raja, S.A. Namjoshi, M. Misra, *Materials letters*, 59 (2005) 570.
- [55] T. Wang, J. Yu, B. Dong, *Surface & Coatings Technology*, 200 (2006) 4777.
- [56] Y. T. Zhu, T. G. Langdon, *JOM*, 58 (2004) 63.
- [57] K.Y. Zhu, A. Vassel, F. Brisset, K. Lu, J.Lu, *Acta Materialia*, 52 (2004) 4101.
- [58] K.J. Marsh, 'Shot Peening: Techniques and Applications' (1993) London, EMAS.
- [59] J. O. Almen, P.H. Black, 'Residual stresses and fatigue in metals' (1963) McGraw-Hill Publ. Company.
- [60] L. Wagner, *Materials Science and Engineering A*, 263 (1999) 210.
- [61] A. Blarasin, M. Guagliano, L.Vergani, *Fatigue Fract. Engng. Mater. Struct.*, 20 (1997) 1171.
- [62] I. Altenberger, B. Scholtes, U.Martin, H. Oettel, *Materials Science and Engineering A*, 264 (1999) 1.
- [63] M. Guagliano, *Journal of Materials Processing Technology*, 110 (2001) 277.
- [64] M. Guagliano, E.Riva, M.Giudetti, *Engineering Failure Analysis*, 9 (2002) 147.
- [65] C. Colombo, M. Guagliano, L.Vergani, *SID*, 1 (2005) 253.
- [66] V. Schulze, 'Modern Mechanical surface treatment' (2006) Wiley-VCH.
- [67] K.J. Miller: The 27<sup>th</sup> John Player Lecture (The Institution of Mechanical Engineers) (1991) 205.
- [68] I.F. Pariente, M. Guagliano, *Surface and Coating technology*, 202 (2008) 3072.
- [69] K. Dai, L. Shaw, *Materials Science and Engineering A*, 463 (2007) 46.
- [70] N.R. Tao, Z.B. Wang, W.P. Tong, M.L. Sui, J. Lu, K. Lu, *Acta Materialia*, 50 (2002) 4603.
- [71] H.W. Zhang, Z.K. Hei, G. Liu, J. Lu, K. Lu, *Acta Materialia*, 51 (2003) 1871.
- [72] K.Y. Zhu, A. Vassel, F. Brisset, K. Lu, J.Lu, *Acta Materialia*, 52 (2004) 4101.
- [73] K. Lu, J. Lu, *Materials Science and Engineering A*, 375-377 (2004) 38.
- [74] Z.G. Liu, H.J. Fecht, M. Umemoto, *Materials Science and Engineering A*, 375-377 (2004) 839.
- [75] J. Ren, A. Shan, J. Zhang, H. Song, J. Liu, *Materials Letters*, 60 (2006) 2076.
- [76] Y. Lin, J. Lu, L. Wang, T. Xua, Q. Xue, *Acta Materialia*, 54 (2006) 5599.
- [77] K. Dai, J. Villegas, Z. Stone, L. Shaw, *Acta Materialia*, 52 (2004) 5771.
- [78] K. Dai, J. Villegas, L. Shaw, *Scripta Materialia*, 52 (2005) 259.
- [79] J. Villegas, K. Dai, L. Shaw, P. Liaw, *Materials Science and Engineering A*, 410-411 (2005) 257.
- [80] J.W. Tian, J.C. Villegas, W. Yuan, D. Fielden, L. Shaw, P.K. Liaw, D.L. Klarstrom, *Materials Science and Engineering A*, 468-470 (2007) 164.
- [81] Y. Ochi, K. Masaki, T. Matsumura, T. Sekino, *International Journal of Fatigue*, 23 (2001) 441.
- [82] J. Villegas, K. Dai, L. Shaw, 'Surface roughness evolution in surface nanocrystallization and hardening (SNH) process' T.Srivatsan, R.Varin, editors. *Processing and fabrication of advanced materials: XII. Materials Park, OH: ASM International* (2003) 358-372.
- [83] J. Villegas, K. Dai, L. Shaw, P. Liaw, 'Experiments and modeling of the surface nanocrystallization and hardening (SNH) process', Shaw L, Suryanarayana C, Mishra R, editors. *Processing and properties of structural nanomaterials. Warrendale, PA: TMS* (2003) 61-68.
- [84] T. Hanlon, Y.N. Kwon, S. Suresh, *Scripta Mater.*, 49 (2003) 675.
- [85] W. Yuan, C. Stephens, P. Liaw, L. Shaw, R.A. Buchanan, R. McDaniel, *Fatigue properties of surface nanocrystalline and hardened titanium*, presented at the undergraduate poster competition, University of Tennessee; (March 2003).
- [86] G. Liu, S.C. Wang, X.F. Lou, J. Lu, K. Lu, *Scripta Mater.*, 44 (2001) 1791.
- [87] U. Martin, I. Altenberger, B. Scholtes, K. Kremmer, H. Oettel, *Materials Science and Engineering A*, 246 (1998) 69.
- [88] L. Huang, J. Lu, M. Troyon, *Nanomechanical, Surface & Coatings Technology*, 201 (2006) 208.
- [89] W.P. Tong, N.R. Tao, Z.B. Wang, H.W. Zhang, J. Lu, K. Lu, *Scripta Materialia*, 50 (2004) 647.
- [90] C.C. Koch, *Nanostruct. Mater.*, 2 (1993) 109.
- [91] H. J. Fecht, 'in *Nanophase Materials: Synthesis, Properties, Applications*, G. C. Hadjipanayis, R. W. Siegel, Eds. (1994) Dordrecht, Netherlands, Kluwer Academic.
- [92] C. Suryanarayana, *Progress in Materials Science*, 46 (2001) 1.
- [93] W.P. Tong, C.Z. Liu, W. Wang, N.R. Tao, Z.B. Wang, L. Zuoa, J.C. He, *Scripta Materialia*, 57 (2007) 533.



- [94] W. P. Tong, N. R. Tao, Z. B. Wang, J. Lu, K. Lu, *Science*, 299 (2003) 686.
- [95] Z.B. Wang, N.R. Tao, S. Li, W. Wang, G. Liu, J. Lu, K. Lu, *Mater. Sci. Eng. A*, 352 (2003) 144.
- [96] A.L. Geiger, D.P.H. Hasselman, P. Welch, *Acta Mater.*, 45 (1997) 3911.
- [97] F.A. Guo, N. Trannoy, J. Lu, *Materials Science and Engineering A*, 369 (2004) 36.
- [98] R.C. O'Handley, 'Modern Magnetic Materials', New York, John Wiley & Sons Inc. (2000) 432-466.
- [99] Y. Q. Wu, T. Bitoh, K. Hono, A. Makino, A. Inoue, *Acta Mater.*, 49 (2001) 4069–4077.