

NASA TECHNICAL NOTE

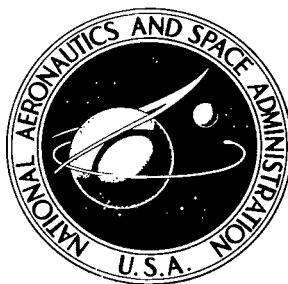

NASA TN D-6411

2.1

NASA TN D-6411



LOAN COPY: RETURN TO
AFWL (DOGL)
KIRTLAND AFB, N. M.

ELASTOHYDRODYNAMIC FILM THICKNESS
BETWEEN ROLLING DISKS WITH
A SYNTHETIC PARAFFINIC OIL
TO 589 K (600° F)

by Richard J. Parker and Jerrold W. Kannel
Lewis Research Center
Cleveland, Ohio 44135

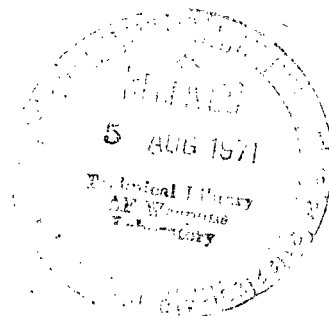



0132837

1. Report No. NASA TN D-6411		2. Government Accession No.		3. Recipient 0132837	
4. Title and Subtitle ELASTOHYDRODYNAMIC FILM THICKNESS BETWEEN ROLLING DISKS WITH A SYNTHETIC PARAFFINIC OIL TO 589 K (600 ⁰ F)				5. Report Date July 1971	
				6. Performing Organization Code	
7. Author(s) Richard J. Parker and Jerrold W. Kannel				8. Performing Organization Report No. E-6151	
				10. Work Unit No. 126-15	
9. Performing Organization Name and Address Lewis Research Center National Aeronautics and Space Administration Cleveland, Ohio 44135				11. Contract or Grant No.	
				13. Type of Report and Period Covered Technical Note	
12. Sponsoring Agency Name and Address National Aeronautics and Space Administration Washington, D.C. 20546				14. Sponsoring Agency Code	
				15. Supplementary Notes	
16. Abstract <p>Elastohydrodynamic (EHD) film thickness measurements were made in an X-ray rolling-disk machine with a synthetic paraffinic oil at temperatures from 339 to 589 K (150⁰ to 600⁰ F). The synthetic paraffinic oil both with and without an organic phosphonate antiwear additive is capable of providing an EHD film throughout the range of test conditions. The measured film thicknesses were less than predicted by EHD theory when the lubricant was used without the antiwear additive. The antiwear additive caused an increase in the measured EHD film thickness. The measured film thickness was more sensitive to contact stress than predicted by EHD theory. For the oil without the antiwear additive, variations of measured film thickness with speed and viscosity were similar to those predicted by EHD theory. The film thickness measurements verified results of 120-mm- and 25-mm-bore ball bearing tests with the same lubricant.</p>					
17. Key Words (Suggested by Author(s)) Bearings Ball bearings Lubrication High-temperature Elastohydrodynamic lubrication lubrication Film thickness Rolling-element measurement bearings Synthetic lubricants				18. Distribution Statement Unclassified - unlimited	
19. Security Classif. (of this report) Unclassified		20. Security Classif. (of this page) Unclassified		21. No. of Pages 26	22. Price* \$3.00

ELASTOHYDRODYNAMIC FILM THICKNESS BETWEEN ROLLING DISKS WITH A SYNTHETIC PARAFFINIC OIL TO 589 K (600° F)

by Richard J. Parker and Jerrold W. Kannel*

Lewis Research Center

SUMMARY

Elastohydrodynamic (EHD) film thickness measurements were made in an X-ray rolling-disk machine with a synthetic paraffinic oil. Disk temperature was varied from 339 to 589 K (150° to 600° F). Load was varied such that the calculated maximum Hertz stress ranged from 1.04×10^9 to 2.42×10^9 newtons per square meter (150 000 to 350 000 psi). Shaft speeds of 5000 to 20 000 rpm resulted in surface speeds from 9.4 to 37.6 meters per second (370 to 1480 in./sec).

The synthetic paraffinic oil both with and without an organic phosphonate antiwear additive is capable of providing an EHD film throughout the range of test conditions. The measured film thicknesses were less than predicted by EHD theory when the oil was used without the antiwear additive. The antiwear additive caused an increase in the measured EHD film thickness. This effect may be attributed to surface film formations either directly or indirectly by influencing the rheological character of the lubricant within the contact area.

In general, the measured film thickness was more sensitive to contact stress than predicted by EHD theory. The behavior of the pressure coefficient of viscosity may be partially responsible for this anomaly in the higher stress region. In addition, the X-ray technique measures a minimum film thickness which varies more with applied stress than does the average or center film thickness predicted by theory.

The variation of measured film thickness for the oil without the antiwear additive with the speed-viscosity parameter $\left(\mu_o \alpha u / R_x'\right)^{0.74}$ was similar to that predicted by EHD theory.

The film thickness measurements verified results of 120-millimeter- and 25-millimeter-bore ball bearing tests with the same lubricant. Very low film thicknesses were measured at conditions similar to those where the bearings suffered surface damage.

* Battelle Memorial Institute, Columbus, Ohio.

INTRODUCTION

A primary function of a liquid lubricant in a rolling-element bearing is to form a film separating two rolling elements in contact. This film, which is referred to as an elastohydrodynamic (EHD) film, is formed by the combination of the hydrodynamic action of the lubricant and the elastic properties of the rolling elements. The thickness of this EHD film is typically of the order of a few microinches to something less than 100 microinches (250×10^{-6} cm). This thickness depends on the lubricant viscosity, bearing geometry, and such operating conditions as load and speed. The lubricant viscosity is dependent on bearing operating temperature, contact pressure of the rolling-element bodies, and possibly shear rate.

Predictions and measurements of elastohydrodynamic film thicknesses have been the subject of much research and analysis. A monograph by Dowson and Higginson (ref. 1) documents the bulk of the theoretical and experimental work that has been performed in this area up to about 1964.

Bearing temperatures in the range of 478 to 589 K (400° to 600° F) are anticipated in advanced gas turbine engines and accessory drive systems, such as those related to high-performance supersonic aircraft (ref. 2). Severe speed and load conditions are also anticipated for main shaft thrust bearings in these engines. Reliable bearing-lubrication systems are required for these and other high-temperature, high-speed applications. New classes of liquid lubricants are being studied for these applications to determine their thermal stability, their oxidation and corrosion resistance, and their effect on rolling-element fatigue (refs. 3 to 9).

In reference 7, groups of 120-millimeter-bore, angular-contact ball bearings were fatigue tested at temperatures from 478 to 589 K (400° to 600° F) with a synthetic paraffinic oil containing an organic phosphonate antiwear additive as the lubricant. Bearing life exceeded AFBMA-predicted (catalog) life by a factor greater than 13. Examination of the bearings run at 589 K (600 F) showed only a slight amount of glazing or minor surface distress and no measurable wear of the race surfaces. This indicated that an EHD film was present but the lubricant was operating near its limiting temperature and load conditions. At the lower temperatures, 478 and 533 K (400° and 500° F), no surface distress or wear of the race surfaces was evident.

Bearing tests such as those described in references 6 to 8 are very expensive and time consuming. With the use of a rolling-disk machine and a means of measuring the lubricant EHD film thickness between the disks, it is anticipated that temperature and load limitations for a particular lubricant can be determined relatively inexpensively without extensive testing. The geometry of the disks must be such that the dynamic conditions of the ball-race contact in a bearing are simulated. Such a facility has been developed (ref. 10) which closely simulates the ball - inner-race contact of a

120-millimeter-bore, angular-contact ball bearing with consideration given to elastic, thermal, and hydrodynamic effects.

The research reported herein was conducted (1) to determine the EHD film thickness with a synthetic paraffinic oil at temperatures up to 589 K (600° F) under a variety of load and speed conditions, (2) to compare these results with existing EHD theory, and (3) to compare the results with results of bearing tests under similar test conditions.

In order to accomplish these objectives, EHD film thickness measurements were made in an X-ray rolling-disk machine with the synthetic paraffinic oil. Disk temperatures were varied from 339 to 589 K (150° to 600° F). Load was varied such that the calculated maximum Hertz stress varied from 1.04×10^9 to 2.42×10^9 newtons per square meter (150 000 to 350 000 psi). Shaft speeds of 5000 to 20 000 rpm yielded surface speeds from 9.4 to 37.6 meters per second (370 to 1480 in./sec). AISI M-50 steel-crowned disks were used both with and without a 10° cone angle. Nitrogen blanketing was used in all tests to provide a low-oxygen environment and to minimize lubricant oxidation. All tests were conducted at the Battelle Memorial Institute, Columbus, Ohio, under NASA Contract NAS3-11152.

SYMBOLS

a	major semiaxis of Hertzian contact, m (in.)
b	minor semiaxis of Hertzian contact, m (in.)
E_1, E_2	modulus of elasticity of elements 1 and 2, N/m ² (psi)
E'	$\left(\frac{1 - \nu_1^2}{\pi E_1} + \frac{1 - \nu_2^2}{\pi E_2} \right)^{-1}$, N/m ² (psi)
h_o	minimum film thickness, m (in.)
m, n, p	exponents
R_1, R_2	radius of elements 1 and 2 in rolling direction, m (in.)
R'_x	$\left(\frac{1}{R_1} + \frac{1}{R_2} \right)^{-1}$, m (in.)
S_{\max}	maximum Hertz stress, N/m ² (psi)
u	1/2 ($u_1 + u_2$), m/sec (in./sec)
u_1, u_2	surface velocities of elements 1 and 2, m/sec (in./sec)
w	load, N (lbf)

- α pressure-viscosity coefficient, m^2/N ($\text{in.}^2/\text{lbf}$)
- μ_0 ambient viscosity, $\text{N}\cdot\text{sec}/\text{m}^2$ ($\text{lb}\cdot\text{sec}/\text{in.}^2$)
- ν_1, ν_2 Poisson's ratio of elements 1 and 2

APPARATUS AND PROCEDURE

X-ray Disk Machine

The disk machine used in this study is shown pictorially in figure 1 and is described in detail in reference 10. Each of the two contacting disks is driven by a 5-horsepower, variable-speed, high-frequency induction motor. The disks are integral with the motor shafts, which are supported by precision duplex ball bearings. These support bearings are lubricated and cooled by a jet lubrication system. Disk loading is accomplished through a cantilever beam actuated by a pneumatic cylinder. Adjustment devices allow accurate positioning of the disks with respect to the X-ray alignment.

Lubricant for the disks is circulated by a pump submerged in the oil sump, is fed to the contact zone by an oil jet, and is scavenged by a gravity return to the sump. The lubricant is filtered and preheated before entering the contact zone. The disks are enclosed in a container-heater unit designed to operate above 589 K (600°F). A nitrogen atmosphere is maintained in the container to prevent oxidation of the lubricant.

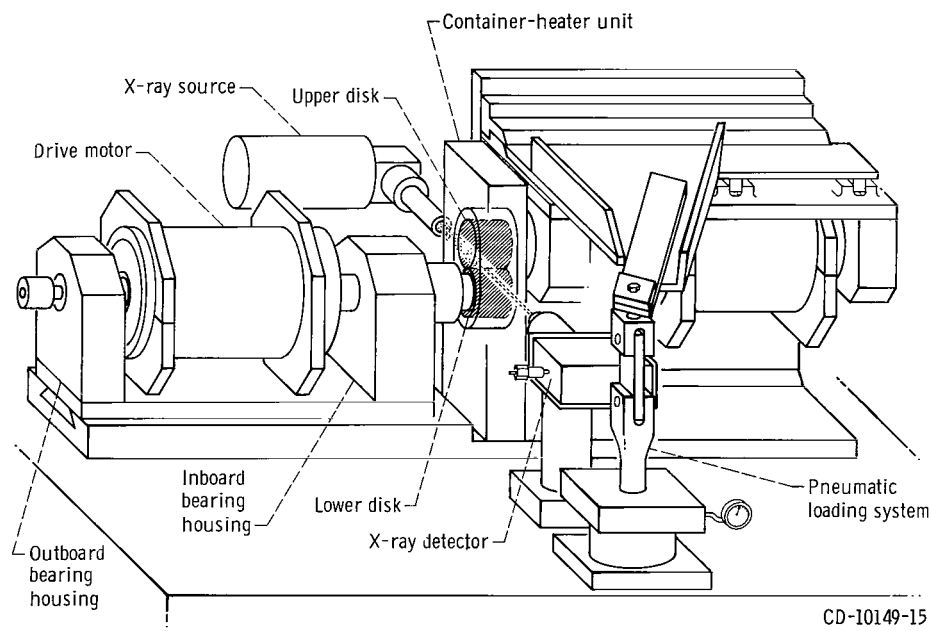

Figure 1. - Rolling-contact disk machine.

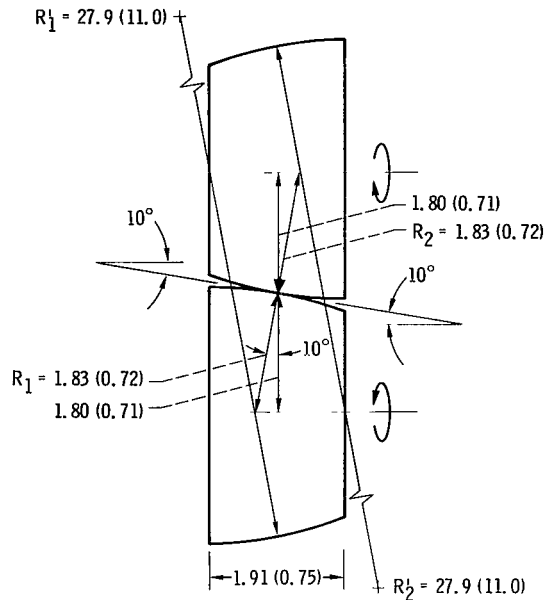

Figure 2. - Contacting disk geometry. (All linear dimensions in cm (in.))

Disks

The geometry of the disks is shown in figure 2. The design of these disks is the result of a simulation study (ref. 10). The contact between the two disks closely simulates the ball - inner-race contact of a 120-millimeter-bore, angular-contact ball bearing. Crowned disks (without the 10° cone angle) were also used.

The disks are made of AISI M-50 steel. They are finish lapped after mounting to a surface finish of 2.5×10^{-6} to 5.0×10^{-6} centimeter (1 to 2 μ in.) rms.

Instrumentation

The X-ray technique used for measuring film thickness consists essentially of flooding the contact region with X-rays and counting those transmitted by the film. Since the X-rays find the steel opaque and are absorbed only slightly by the lubricant, a count of transmitted X-rays by a scintillation counter can be calibrated to find the film thickness. X-rays are projected in the rolling direction, and only a narrow band in the axial direction (0.025 cm (0.01 in.)) is counted. By shifting the band axially, complete axial profiles of film thickness can be found. Care is taken to assure that X-rays are not lost through misalignment of the disks.

Provision for observing contact between the disk in the event of film breakdown is available by observing the resistance between the disks with an ohmmeter circuit.

Disk temperature was measured by thermocouples located at the sides of the disks near the crowned surface. Oil-in temperature was measured and maintained within a few degrees of the disk temperature.

Synthetic Paraffinic Oil

This synthetic paraffinic oil has been extensively tested in previous high-temperature lubrication work (refs. 5 to 9). It has shown good thermal stability and has provided long bearing life at temperatures to 589 K (600^o F) in a low-oxygen environment. It was used in this program both with and without an organic phosphonate antiwear additive. Properties of this lubricant are listed in table I.

TABLE I. - PROPERTIES OF THE SYNTHETIC PARAFFINIC OIL

Kinematic viscosity, cS (or 10 ⁻⁶ m ² /sec), at -	
233 K (-40 ^o F)	>100 000
311 K (100 ^o F)	443
372 K (210 ^o F)	40
478 K (400 ^o F)	5.8
589 K (600 ^o F)	^a 2.3
Flash point, K (^o F)	541 (515)
Fire point, K (^o F)	589 (600)
Autoignition temperature, K (^o F)	703 (805)
Volatility (6.5 hr at 533 K (500 ^o F)), wt%	14.2
Specific heat at 533 K (500 ^o F), J/(kg)(K) (Btu/(lb)(^o F))	2910 (0.695)
Thermal conductivity at 533 K (500 ^o F), J/(m)(sec)(K) (Btu/(hr)(ft)(^o F))	0.12 (0.070)
Specific gravity at 533 K (500 ^o F)	0.71

^aExtrapolated.

Procedure

The loading mechanism is calibrated by using a load cell in place of the lower disk. Following careful alinement of the disks both statically and dynamically, a calibration of the X-ray measuring system is performed.

Calibration of the X-ray measuring system is obtained by separating the disks by means of a precise adjusting screw (250×10⁻⁶ cm (100 μin.) increments), and observing the X-ray count for the known separations. The calibration was performed with the synthetic paraffinic oil at 5000 rpm and 422 K (300^o F) disk temperature.

The series of film thickness measurements are performed at each stable operating

condition of speed, load, and disk temperature. For each condition, X-ray counts are averaged over 15 seconds.

RESULTS AND DISCUSSION

Experimental Results

The measured minimum film thicknesses between crowned-cone disks with the synthetic paraffinic oil without the antiwear additive are plotted against maximum Hertz stress, surface speed, and lubricant viscosity at inlet conditions in figures 3 to 5, respectively, and are tabulated in table II.

The effect of stress on measured minimum film thickness is seen in figure 3. Throughout the range of speeds and viscosities (temperatures), a consistent trend of decreasing film thickness with increasing stress is seen. The decrease is greater in the 1.72×10^9 to 2.42×10^9 newtons per square meter (250 000 to 350 000 psi) stress range than at lower stresses.

The variation of measured film thickness with disk surface speed is linear on the log-log plots in figure 4. However, as disk temperature increases and films get thinner, the effect of speed appears to be greater.

The effect of lubricant viscosity (at the disk temperature) on measured minimum film thickness is shown in figure 5. The variation in lubricant absolute viscosity is a result of varying disk temperature from 339 to 505 K (150° to 450° F). A linear (on log-log plot) decrease in film thickness with decreased viscosity prevails except at low viscosity. Here the thinner films deviate from the linear trend. Judging from the increased slope, the effect of viscosity on film thickness appears to be greater at lower speeds.

Minimum film thickness measurements between crowned disks (without the 10° cone angle) with the synthetic paraffinic oil are given in table II. No significant differences exist between these data and those for the crowned-cone disks. The only difference in conditions between these two tests is the spinning component of relative velocity that exists in the crowned-cone disk contact but does not exist in the crowned-disk contact. Under these test conditions, this spinning velocity does not appear to affect minimum film thickness.

Effect of Antiwear Additive

The effect of the presence of an antiwear additive (organic phosphonate) in the synthetic paraffinic oil is shown in figure 6. The trend of decreasing film thickness with in-

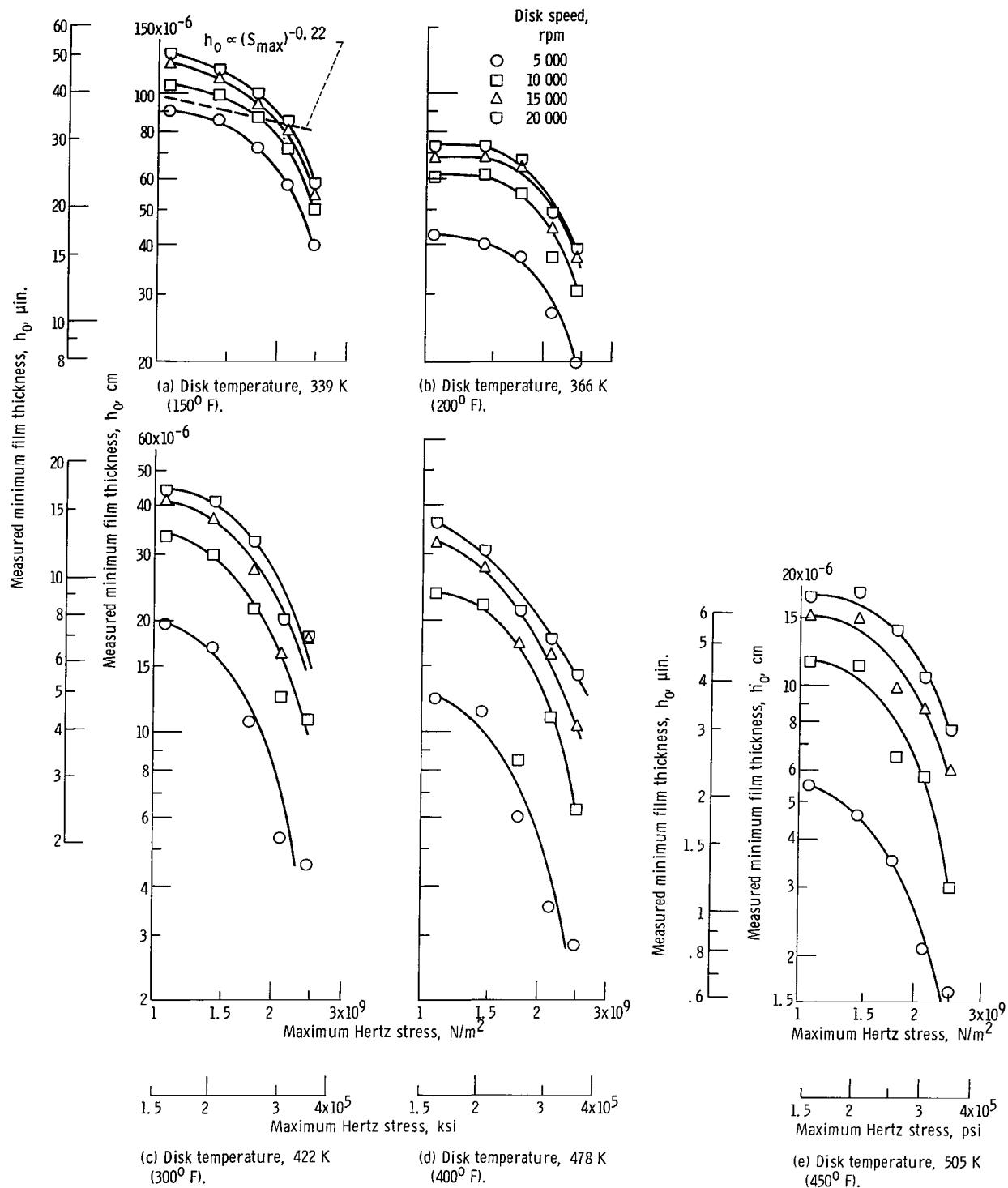

Figure 3. - Effect of maximum Hertz stress on measured minimum film thickness. Crowned-cone disks; synthetic paraffinic oil.

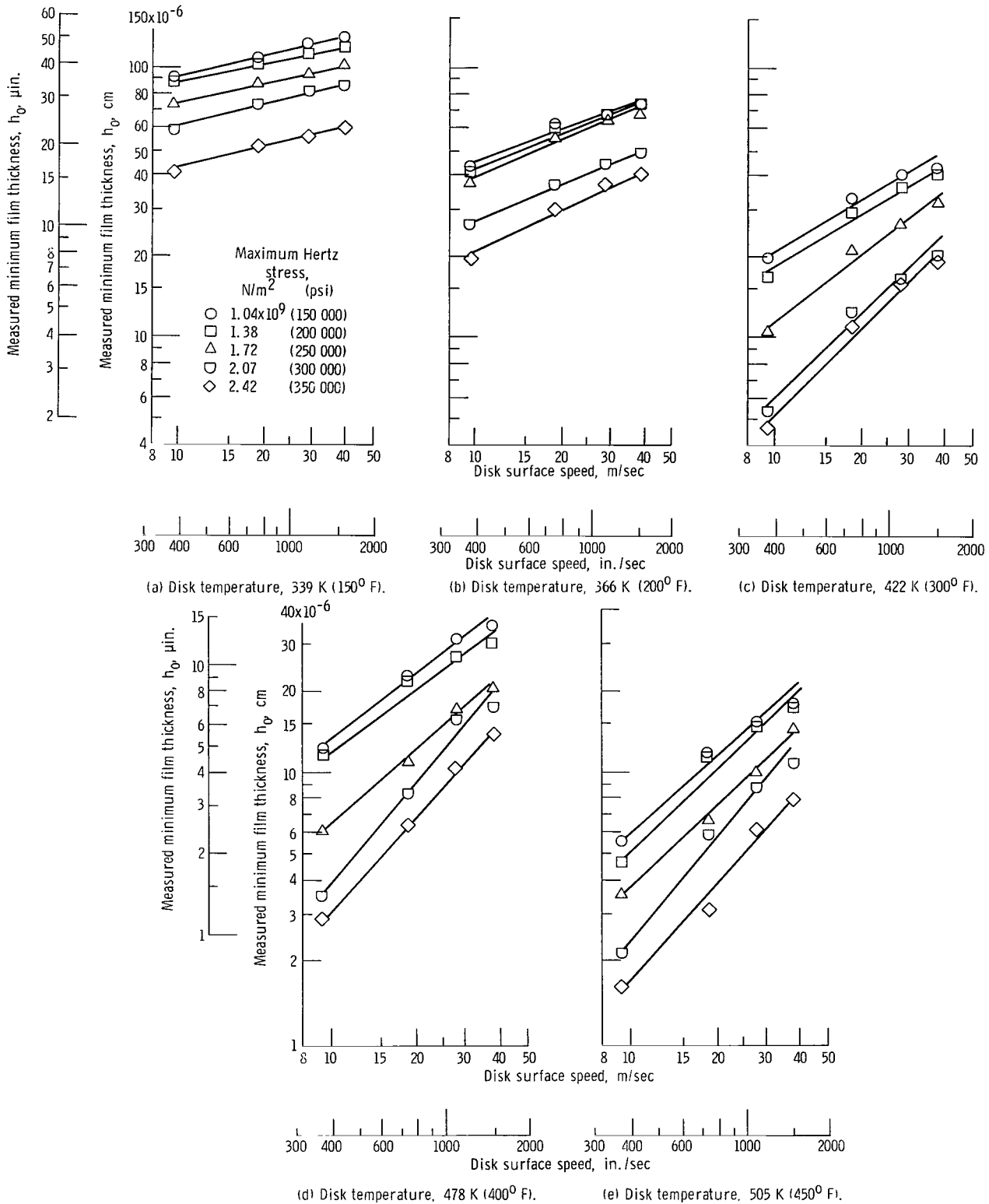
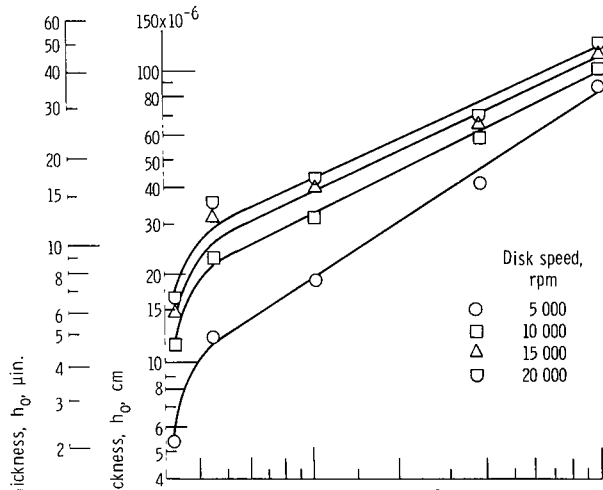
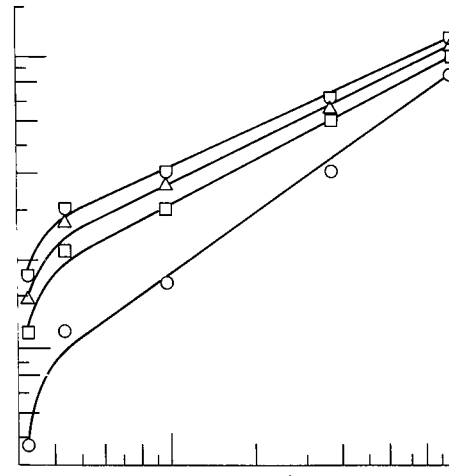

Figure 4. - Effect of disk surface speed on measured minimum film thickness. Crowned-cone disks; synthetic paraffinic oil.



(a) Maximum Hertz stress, 1.04×10^9 newtons per square meter (150 000 psi).



(b) Maximum Hertz stress, 1.38×10^9 newtons per square meter (200 000 psi).

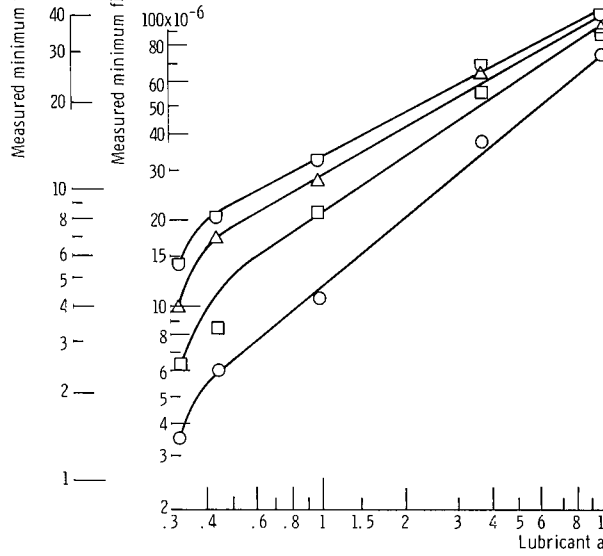

(c) Maximum Hertz stress, 1.72×10^9 newtons per square meter (250 000 psi).

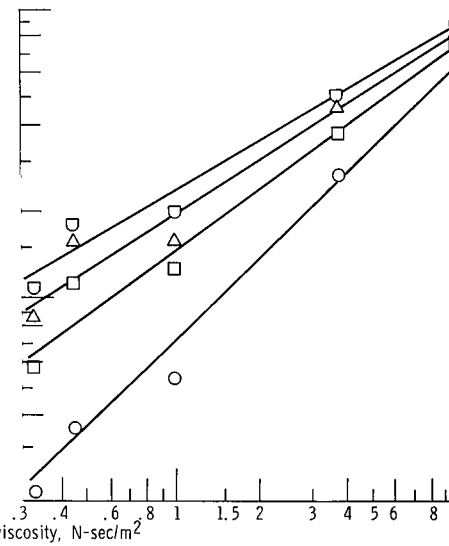

(d) Maximum Hertz stress, 2.02×10^9 newtons per square meter (300 000 psi).

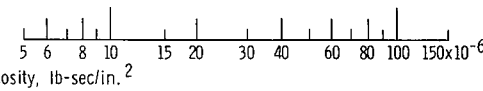
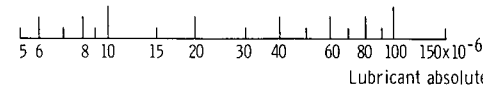

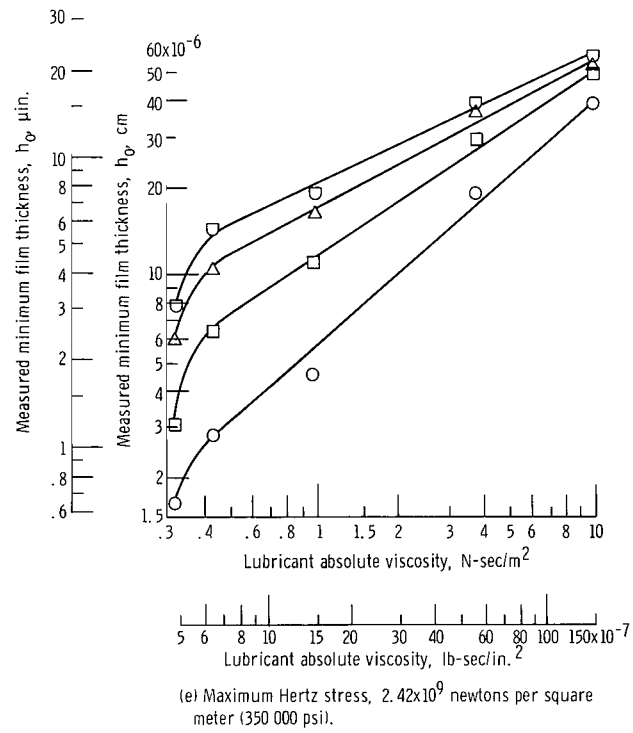
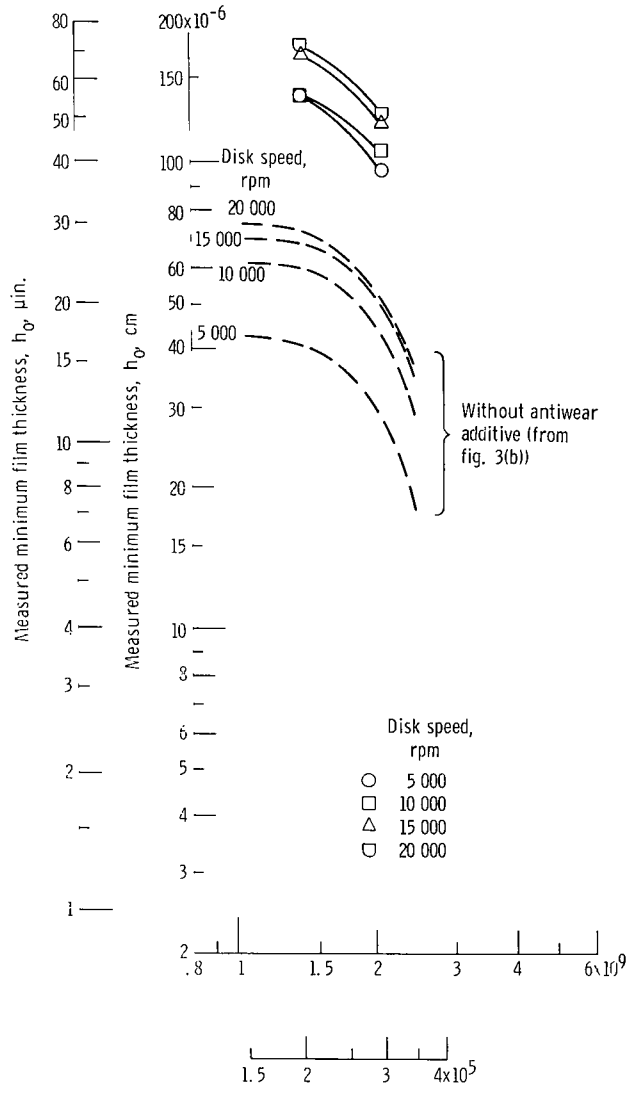
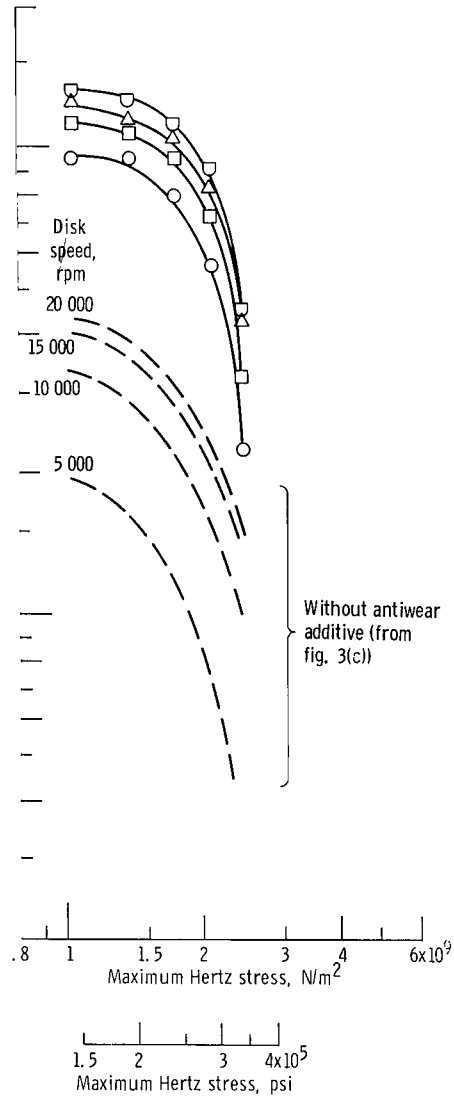

Figure 5. - Effect of lubricant viscosity at operating temperature on measured minimum film thickness. Synthetic paraffinic oil; crowned-cone disks.



(a) Disk temperature, 366 K (200° F).



(b) Disk temperature, 422 K (300° F).

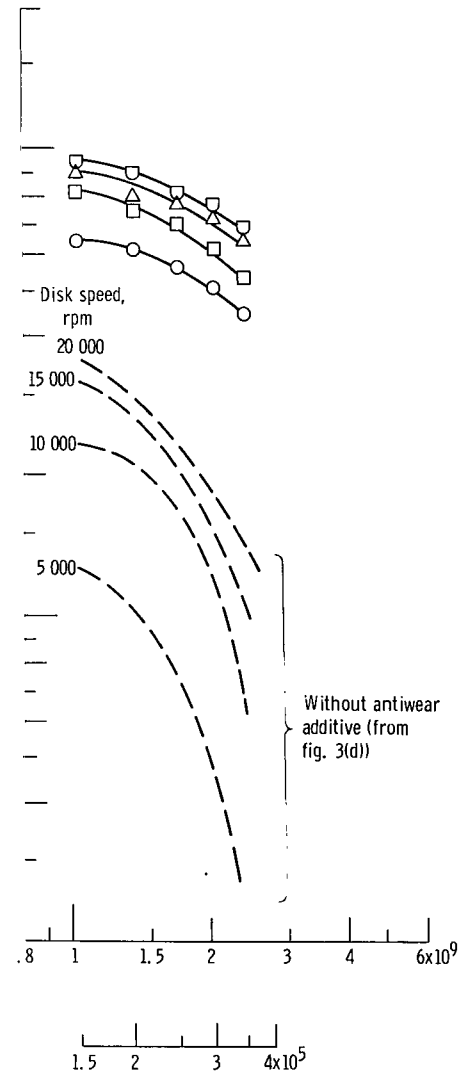

(c) Disk temperature, 478 K (400° F).

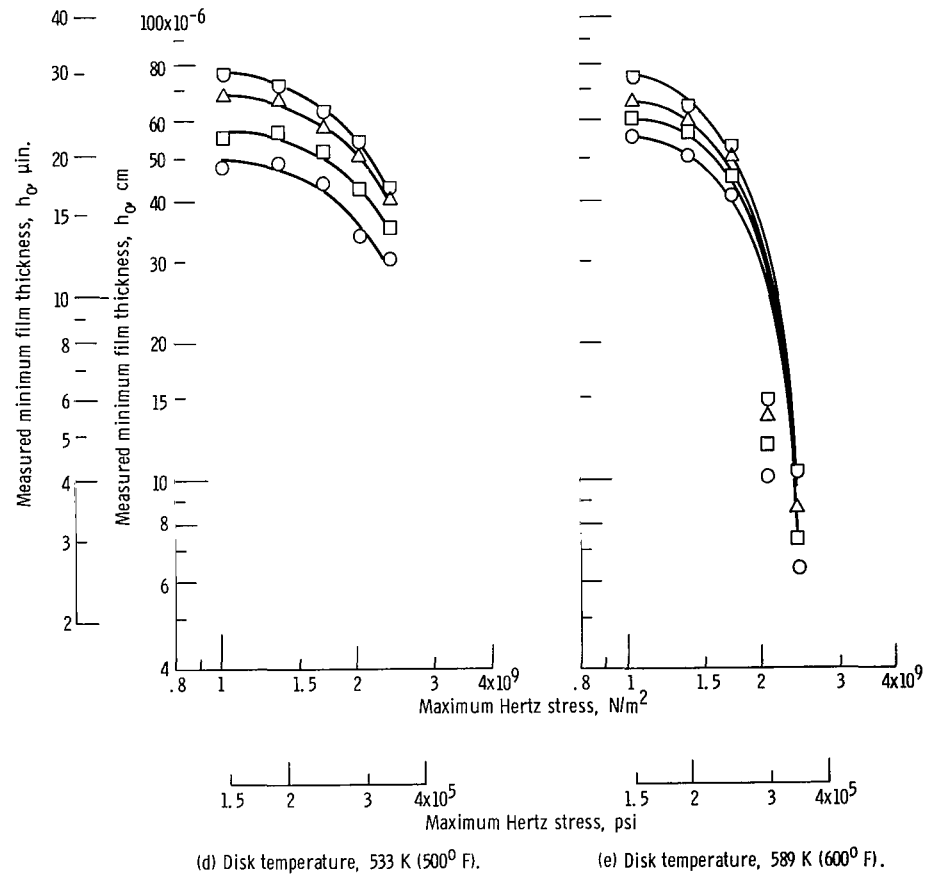

(d) Disk temperature, 533 K (500^o F). (e) Disk temperature, 589 K (600^o F).
 Figure 6. - Measured minimum film thickness with synthetic paraffinic oil containing an organic phosphonate antiwear additive. Crowned-cone disks.

TABLE II. - MEASURED MINIMUM FILM THICKNESS BETWEEN PAIRS OF EITHER CROWNED DISKS OR CROWNED-CONE DISKS

[Synthetic paraffinic oil without additive.]

(a) SI units								(b) U.S. customary units													
Disk temperature, K	Disk speed, rpm	Stress, ^a N/m ²	Minimum film thickness, h ₀ , cm		Disk temperature, K	Disk speed, rpm	Stress, ^a N/m ²	Minimum film thickness, h ₀ , cm		Disk temperature, °F	Disk speed, rpm	Stress, ^a psi	Minimum film thickness, h ₀ , μin.		Disk temperature, °F	Disk speed, rpm	Stress, ^a psi	Minimum film thickness, h ₀ , μin.			
			(b)	(c)				(b)	(c)				(b)	(c)				(b)	(c)		
339	5 000	1.04×10 ⁹	96×10 ⁻⁶	89×10 ⁻⁶	422	15 000	1.04×10 ⁹	48×10 ⁻⁶	41×10 ⁻⁶	150	5 000	1.5×10 ⁵	38	35	300	15 000	1.5×10 ⁵	19	16		
		1.38	94	86			1.38	43	35			2.0	37	34			2.0	17	14		
		1.72	76	71			1.72	38	25			2.5	30	28			2.5	15	10		
		2.07	69	58			2.07	25	15			3.0	27	23			3.0	10	6		
		2.42	46	41			2.42	20	15			3.5	18	16			3.5	8	6		
	10 000	1.04×10 ⁹	112×10 ⁻⁶	107×10 ⁻⁶		20 000	1.04×10 ⁹	58×10 ⁻⁶	43×10 ⁻⁶		10 000	1.5×10 ⁵	44	42		20 000	1.5×10 ⁵	23	17		
		1.38	112	99			1.38	56	41			2.0	44	39			2.0	22	16		
		1.72	84	86			1.72	43	30			2.5	33	34			2.5	17	12		
		2.07	79	71			2.07	33	20			3.0	31	28			3.0	13	8		
		2.42	58	51			2.42	25	20			3.5	23	20			3.5	10	8		
	15 000	1.04×10 ⁹	117×10 ⁻⁶	119×10 ⁻⁶		478	5 000	1.04×10 ⁹	12×10 ⁻⁶		12×10 ⁻⁶	15 000	1.5×10 ⁵	46		47	400	5 000	1.5×10 ⁵	5	5
		1.38	119	109			1.38	10	10		2.0		47	43		2.0		4	4		
1.72		89	94	1.72	10		5	2.5	35	37	2.5		4	2							
2.07		89	81	2.07	5		2	3.0	35	32	3.0		2	1							
2.42		66	53	2.42	2		2	3.5	26	21	3.5		1	1							
20 000	1.04×10 ⁹	135×10 ⁻⁶	127×10 ⁻⁶	10 000	1.04×10 ⁹	20×10 ⁻⁶	23×10 ⁻⁶	20 000	1.5×10 ⁵	53	50	10 000	1.5×10 ⁵	8	9						
	1.38	124	117		1.38	15	23		2.0	49	46		2.0	6	9						
	1.72	96	102		1.72	15	8		2.5	38	40		2.5	6	3						
	2.07	89	84		2.07	10	10		3.0	35	33		3.0	4	4						
	2.42	71	58		2.42	8	8		3.5	28	23		3.5	3	3						
366	5 000	1.04×10 ⁹	43×10 ⁻⁶	43×10 ⁻⁶	505	15 000	1.04×10 ⁹	25×10 ⁻⁶	30×10 ⁻⁶	200	5 000	1.5×10 ⁵	17	17	15 000	1.5×10 ⁵	10	12			
		1.38	41	41			1.38	20	28			2.0	16	16		2.0	8	11			
		1.72	36	38			1.72	20	18			2.5	14	15		2.5	8	7			
		2.07	23	25			2.07	15	15			3.0	9	10		3.0	6	6			
		2.42	20	20			2.42	10	10			3.5	8	8		3.5	4	4			
	10 000	1.04×10 ⁹	61×10 ⁻⁶	61×10 ⁻⁶		20 000	1.04×10 ⁹	28×10 ⁻⁶	36×10 ⁻⁶		10 000	1.5×10 ⁵	24	24		20 000	1.5×10 ⁵	11	14		
		1.38	58	61			1.38	25	30			2.0	23	24			2.0	10	12		
		1.72	51	56			1.72	25	20			2.5	20	22			2.5	10	8		
		2.07	38	38			2.07	18	18			3.0	15	15			3.0	7	7		
		2.42	30	30			2.42	15	15			3.5	12	12			3.5	6	6		
	15 000	1.04×10 ⁹	79×10 ⁻⁶	66×10 ⁻⁶		5 000	1.04×10 ⁹	8×10 ⁻⁶	5×10 ⁻⁶		15 000	1.5×10 ⁵	31	26		450	5 000	1.5×10 ⁵	3	2	
		1.38	74	66			1.38	8	5			2.0	29	26			2.0	3	2		
1.72		66	64	1.72	5		2	2.5	26	25		2.5	2	1							
2.07		41	43	2.07	2		2	3.0	16	17		3.0	1	1							
2.42		41	38	2.42	2		2	3.5	16	15		3.5	1	1							
20 000	1.04×10 ⁹	84×10 ⁻⁶	71×10 ⁻⁶	10 000	1.04×10 ⁹	12×10 ⁻⁶	12×10 ⁻⁶	20 000	1.5×10 ⁵	33	28	10 000	1.5×10 ⁵	5	5						
	1.38	84	71		1.38	12	10		2.0	33	28		2.0	5	4						
	1.72	76	66		1.72	10	8		2.5	30	26		2.5	4	3						
	2.07	43	48		2.07	8	5		3.0	17	19		3.0	3	2						
	2.42	48	41		2.42	5	2		3.5	19	16		3.5	2	1						
422	5 000	1.04×10 ⁹	23×10 ⁻⁶	20×10 ⁻⁶	15 000	1.04×10 ⁹	18×10 ⁻⁶	15×10 ⁻⁶	300	5 000	1.5×10 ⁵	9	8	15 000	1.5×10 ⁵	7	6				
		1.38	20	18			1.38	18			15	2.0	8		7	2.0	7	6			
		1.72	12	10			1.72	15			10	2.5	5		4	2.5	6	4			
		2.07	8	5			2.07	12			8	3.0	3		2	3.0	5	3			
		2.42	5	5			2.42	8			5	3.5	2		2	3.5	3	2			
	10 000	1.04×10 ⁹	38×10 ⁻⁶	33×10 ⁻⁶		20 000	1.04×10 ⁹	25×10 ⁻⁶		18×10 ⁻⁶	10 000	1.5×10 ⁵	15		13	20 000	1.5×10 ⁵	10	7		
		1.38	33	30			1.38	25		18		2.0	13		12		2.0	10	7		
		1.72	30	20			1.72	20		15		2.5	12		8		2.5	8	6		
		2.07	18	12			2.07	15		10		3.0	7		5		3.0	6	4		
		2.42	12	10			2.42	10		8		3.5	5		4		3.5	4	3		

^aMaximum Hertz stress.

^bMeasured minimum film thickness with crowned disks.

^cMeasured minimum film thickness with crowned-cone disks.

creasing stress is similar with or without the additive, but the magnitude of the film thickness is much greater with the additive. This difference is of the order of 50×10^{-6} to 100×10^{-6} centimeter (20 to 40μ in.).

One unique result observed in using the additive-containing lubricant in the initial disk experiments was the formation of a very obvious surface film on the disks. This film exhibited very pronounced dielectric properties when the disks were loaded together statically. This film was not present after tests with the lubricant without the additive.

As shown in figure 7, the experiments with the additive-containing oil using crowned disks (without the 10° cone angle) did not yield films so thick as were experienced with the crowned-cone disk experiments. (Also, the surface film was not apparent.) These crowned-disk experiments were, however, conducted late in the program with a modified induction-resistance heating system which heated the disks more rapidly than did the earlier resistance system. Possible effects of this variable are discussed in the section entitled SPECULATIONS.

Comparison with EHD Theory

Theoretical solutions for elastohydrodynamic film thickness all take the general form

$$h_o \propto \frac{\mu_o^n u^m}{w^p} \quad (1)$$

where

- h_o film thickness
- μ_o viscosity at atmospheric pressure
- u surface speed
- w load
- n, m, p exponents

Theories have been developed for line contact (refs. 1 and 11) and for point contact (refs. 12 and 13). The contact between the disks used in the present investigation is elliptical with $b/a = 5.9$, where b is the semiaxis of the contact ellipse perpendicular to the roll-

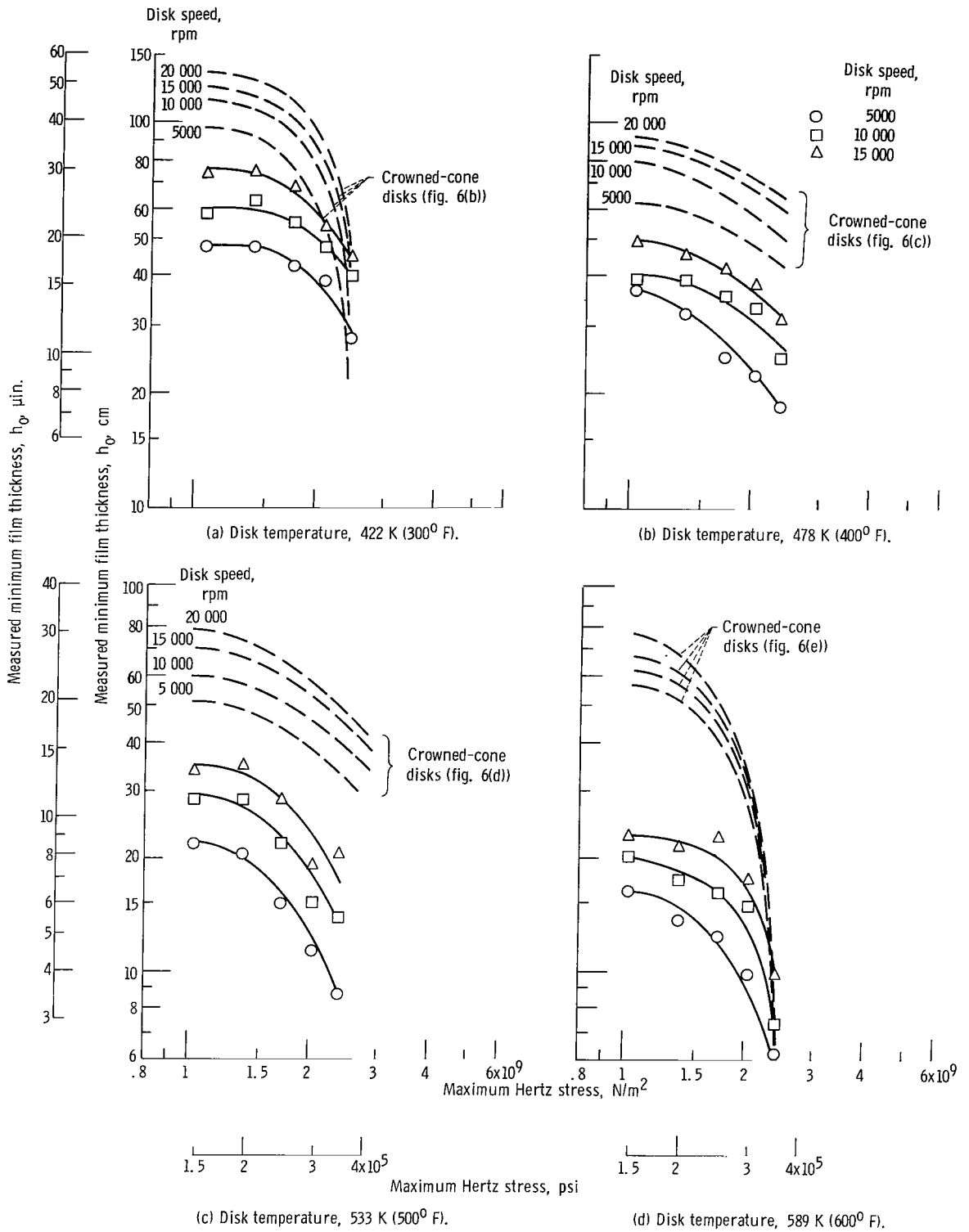

Figure 7. - Measured minimum film thickness with synthetic paraffinic oil containing an organic phosphonate antiwear additive. Pure crown disks.

ing direction. In reference 13, for ellipses with $b/a \geq 5$, line contact is assumed. The film thickness equation for line contact (ref. 13) is

$$\frac{h_o}{R'_x} = 1.47 \left(\frac{\mu_o \alpha u}{R'_x} \right)^{0.74} \left(\frac{S_{max}}{E'} \right)^{-0.22} \quad (2)$$

The theory presented in reference 12 predicts films about 15 percent thinner than that of equation (2); but the exponents on the speed, viscosity, and stress terms are identical. Equation (2), based on reference 13, is thus considered typical of existing elastohydrodynamic theory.

In figure 8, the film thickness h_o is plotted against the speed-viscosity parameter

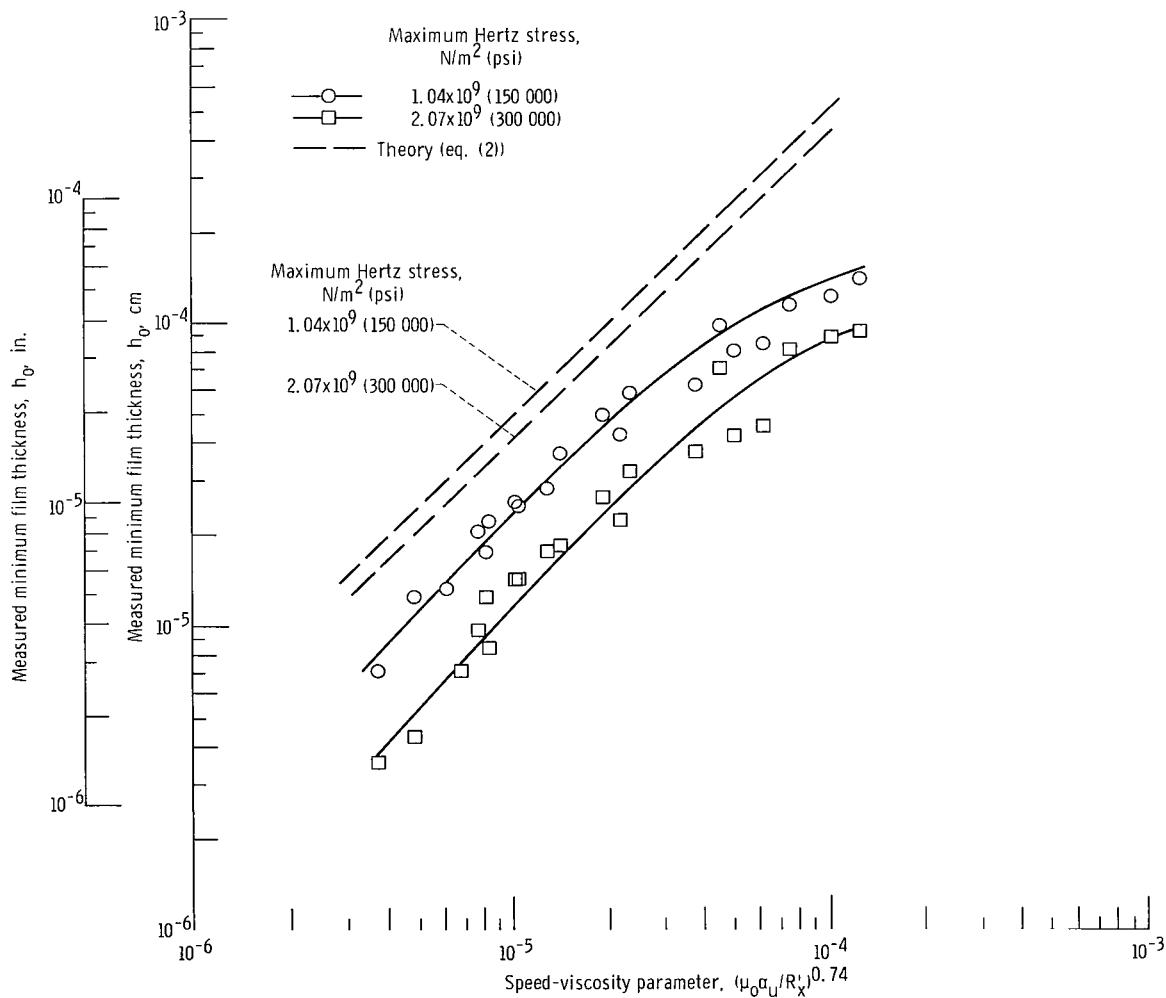

Figure 8. - Measured minimum film thickness as function of speed-viscosity parameter. Synthetic paraffinic oil; crowned disks.

$(\mu_o \alpha u / R'_x)^{0.74}$. Equation (2) is compared with experimental data for the crowned disks with the synthetic paraffinic oil without additives. The magnitude of the measured films is less than that predicted by equation (2). The slope of the experimental data is similar to the predicted curve, but deviates for high values of $(\mu_o \alpha u / R'_x)^{0.74}$. A much greater effect of stress is seen with the experimental data than would be predicted by equation (2).

Experimental data plotted in figure 9 for the crowned disks with the synthetic paraffi-

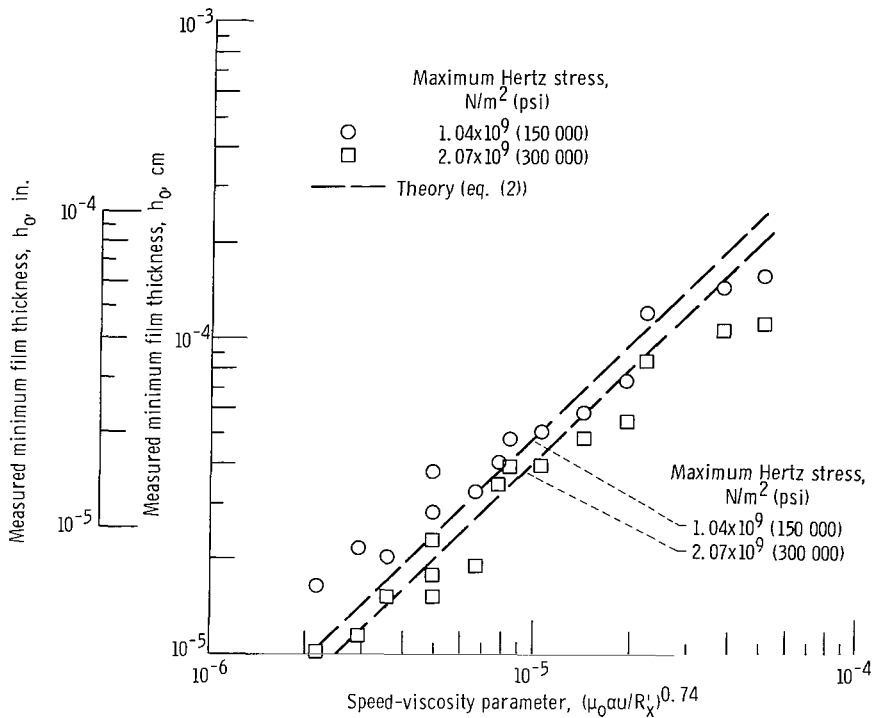

Figure 9. - Measured minimum film thickness as function of speed-viscosity parameter. Synthetic paraffinic oil containing an organic phosphonate antiwear additive; crowned disks.

nic oil with the antiwear additive show a closer correlation to the magnitude of film thickness predicted by equation (2). The slope of the experimental data more closely follows a $(\mu_o \alpha u / R'_x)^{0.6}$ relation rather than the $(\mu_o \alpha u / R'_x)^{0.74}$ of equation (2). A greater effect of stress is seen with these experimental data also.

Considerable deviation of the experimental data from predicted film thicknesses is seen in figure 10 for the additive-containing oil with the crowned-cone disks. Not only is the magnitude of the measured film thickness considerably greater than predicted, but the sensitivity to speed and viscosity (i. e., the parameter $(\mu_o \alpha u / R'_x)^{0.74}$) is much less than predicted.

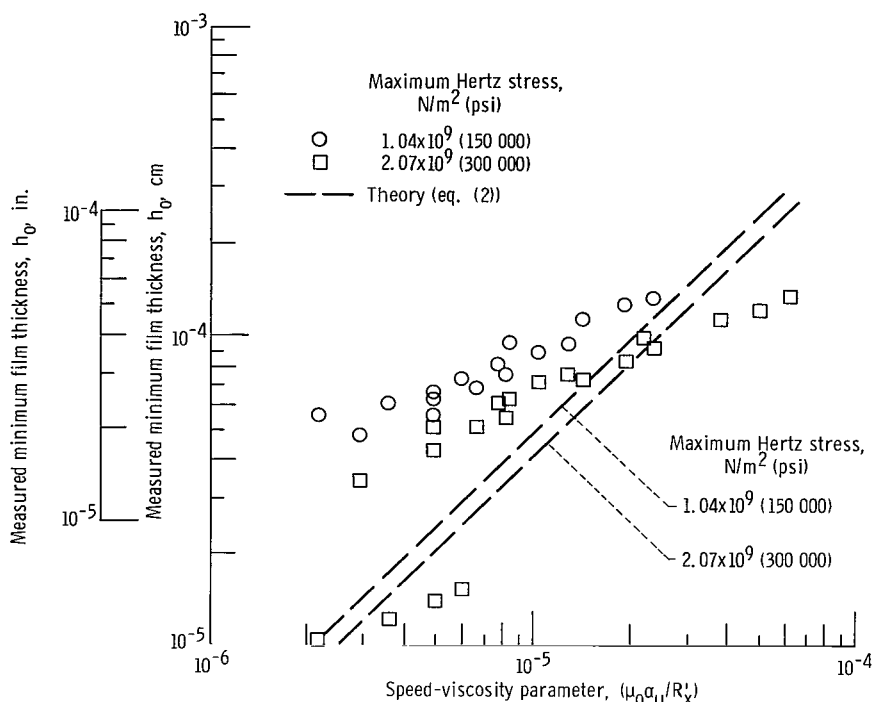

Figure 10. - Measured minimum film thickness as function of speed-viscosity parameter. Synthetic paraffinic oil containing an organic phosphonate antiwear additive; crowned-cone disks.

An explanation for experimental film thicknesses greater than predictions for the additive-containing oil may be due to surface film influence. It should be recalled that for the oil without the antiwear additive, no differences are seen between the crowned disks and the crowned-cone disks. However, with the additive present, the crowned-cone disks gave greater film thicknesses than did the crowned disks. The existence of the spin velocity component in the crowned-cone disk tests may influence the surface film effect due to the additive.

The theory does not, of course, provide for the surface film formation. Thus the comparisons in figures 9 and 10 are not as meaningful as that in figure 8. Where surface films are not present, as with the oil without the antiwear additive, all measured film thicknesses were less than theoretical predictions. The differences ranged from a few microinches at low values of the speed-viscosity parameter to nearly 200 microinches (500×10^{-6} cm) at the highest values.

The stresses (applied loads) and temperatures in this experimental investigation are considerably higher than in other published data which have shown good correlation with predicted film thickness magnitude (such as refs. 14 and 15). As shown in figure 3, the effect of stress on film thickness is greater as stress increases. In the low range of stresses (1.04×10^9 to 1.38×10^9 N/m² (150 000 to 200 000 psi)) the variation in film thick-

ness varies with stress as predicted by the term $(S_{\max})^{-0.22}$ in equation (2). This is shown in figure 3(a), for example. At higher stresses, film thickness decreases at a much greater rate than predicted.

The behavior of the pressure coefficient of viscosity α at these higher stresses and temperatures is not well understood. There is considerable evidence that the effect of pressure on viscosity cannot be described by a single pressure-viscosity coefficient when shear effects are present (ref. 16). Lower pressure-viscosity coefficients at higher temperatures have also been observed (ref. 14). The use of a smaller α for prediction of film thickness at the higher temperatures would provide a closer correlation between predicted and experimental film thicknesses.

These film thickness data correlate well with data in reference 17, which show film thicknesses measured by an X-ray technique to be consistently smaller than predicted. The theory used for comparison was that of reference 11 and is for line contact. The contact between the disks used in reference 17 more closely simulated line contact than those of the present investigation. The greater effect of stress on film thickness is apparent in reference 17, as well as in the present work. The highest maximum Hertz stress reported in reference 17 was only about 1.24×10^9 newtons per square meter (180 000 psi).

It has been shown, both theoretically (ref. 1) and experimentally (ref. 18), that the minimum film thickness in an elastohydrodynamic contact occurs in the exit region or at the sides of the contact. It is expected that the X-ray transmission technique measurement is indicative of this minimum film at the exit rather than being an average or center film thickness. The difference between the minimum and the center film thickness is, however, probably of the order of 10 to 20 percent (ref. 18). This difference would account for only a small portion of the deviation between the predicted and experimental film thicknesses of this investigation. It may, however, be significant in the lower film thickness range (i.e., less than 25×10^{-6} cm (10 μ in.)). It has also been shown (ref. 18) that this minimum film thickness varies more with applied stress than does the center film thickness.

When the separation of two rolling disks approaches the height of the surface asperities, the effect of these asperities on X-ray transmission must be considered. The disks used in these tests had surface finishes of 2.5×10^{-6} to 5.0×10^{-6} centimeter (1 to 2 μ in.) rms. This means that surface irregularities may have peak-to-peak heights of as much as 25×10^{-6} centimeter (10 μ in.). Thus, when the films measured by the X-ray technique are of the order of a few microinches, the probability that some asperity contact is occurring is great. Some X-ray passage between asperities must occur. It is expected that the film thickness reflected by the X-ray transmission technique represents a separation between some average surfaces between the peaks and valleys of each disk surface. Thus the measured film thickness must be somewhat greater than the minimum distance between asperity peaks.

Comparison with Bearing Test Results

The crowned-cone disks used in these experiments were designed such that their contact simulates the ball - inner-race contact of the 120-millimeter-bore ball bearings that were fatigue tested in reference 7. All bearing test conditions were included in the X-ray film thickness measurements except disk surface speed. A surface speed of approximately 51 meters per second (2000 in./sec) would simulate bearing tangential speeds. The maximum disk surface speeds attained were 37.6 meters per second (1480 in./sec). The same synthetic paraffinic oil with the same antiwear additive was used for both the disk tests and the bearing tests. The maximum Hertz stress at the inner-race - ball contact was 2.23×10^9 newtons per square meter (323 000 psi).

After tests at temperatures of 478 and 533 K (400° and 500° F), no surface distress or wear of the bearing race and ball surfaces was evident. At 589 K (600° F) only a slight amount of glazing or minor surface distress was apparent after tests as long as 500 hours. These observations reveal that under these test conditions, the bearings were operating in the elastohydrodynamic lubrication regime.

These results could have been predicted by the X-ray film thickness measurements reported herein. As seen in figure 6, film thicknesses in the range of 50×10^{-6} to 75×10^{-6} centimeter (20 to 30 μ in.) were measured at 478 and 533 K (400° and 500° F) at 20 000 rpm and 2.42×10^9 newtons per square meter (350 000 psi) maximum Hertz stress. However, at 589 K (600° F), the measured film thickness was of the order of 10×10^{-6} to 12×10^{-6} centimeter (4 to 5 μ in.). One would expect more marginal lubrication conditions at this lower film thickness, as confirmed by the bearing test results.

Bearing tests results reported in reference 19 also show good correlation with the film thickness measurements reported herein. In reference 19, 25-millimeter-bore ball bearings tested at 533 to 589 K (500° to 500° F) suffered many early failures both by smearing (severe surface distress) and by fatigue when tested with the synthetic paraffinic oil without the antiwear additive. Another group of bearings tested under the same conditions, except with the lubricant containing the organic phosphonate antiwear additive, showed no signs of surface distress or wear. These results are understandable based on the large differences in measured film thickness between the lubricant with and without the antiwear additive.

SPECULATIONS

The exact nature of the surface film that was observed on the crowned-cone disks after testing with the additive-containing oil was not determined. However, the formation of this film was confirmed with several repeated experiments, and its dielectric

properties were repeatedly observed. The surface film was not as apparent after tests with the crowned disks with the additive-containing oil where the induction heating system was used.

The induction system heated the disks more rapidly than did the resistance system. Therefore, with the induction system, the lubricant was exposed for a shorter time to temperatures which may cause thermal degradation of the lubricant. This effect would be greater on the additive, since the additive is probably not as stable as the base oil. It is speculated that this thermal degradation plays a large part in the formation of the surface film. Further, this behavior is strongly dependent on the time-temperature condition to which the lubricant is exposed.

It is, of course, possible that under the more severe temperature conditions when the resistance heaters were used the lubricant was degraded by hot spots on the container-heater unit. However, since the film enhancement phenomenon also occurred at lower temperatures, it is unlikely that this degradation had a great influence on the formation of the boundary films. In addition, over a long period of exposure, there may be enough access to air even in the nitrogen-blanketed system that oxidative stability may be a factor in surface-film formation, and its influence on the resulting EHD film thickness.

A possible mechanism for additive effects on film formation involves the physical action of chemically adsorbed surface films that probably impart an improved rheological character to the EHD film of lubricant as the bulk lubricant is swept through the contact area. Observations of similar phenomena have been made in the USSR (ref. 20) and in studies of the rheology of boundary films (ref. 21). In short, the sphere of influence of surface films adsorbed on materials from solutions containing surface-active additives is greater than is the thickness of the chemisorbed molecular layers typical of boundary films.

SUMMARY OF RESULTS

Elastohydrodynamic (EHD) film thickness measurements were made in an X-ray rolling-disk machine with a synthetic paraffinic oil and with and without an organic phosphonate antiwear additive. Disk temperature was varied from 339 to 589 K (150^o to 600^o F). Load was varied such that the calculated maximum Hertz stress ranged from 1.04×10^9 to 2.42×10^9 newtons per square meter (150 000 to 350 000 psi). Shaft speeds of 5000 to 20 000 rpm yielded surface speeds from 9.4 to 37.6 meters per second (370 to 1480 in./sec). The results of these measurements were as follows:

1. The synthetic paraffinic oil both with and without the antiwear additive is capable of providing an EHD film throughout the range of test conditions listed here.

2. In general, the measured film thickness was more sensitive to contact stress (applied load) than predicted by EHD theory.

3. Measured film thicknesses were less than predicted by EHD theory throughout the range of test conditions for the synthetic paraffinic oil without the antiwear additive.

4. The antiwear additive (organic phosphonate type) caused an increase in measured EHD film thickness.

5. The variation of measured film thickness for the non-additive-containing oil with the speed-viscosity parameter $\left(\mu_0 \alpha u / R'_x\right)^{0.74}$ was similar to that predicted by EHD theory. (μ_0 is ambient viscosity, α is the pressure-viscosity coefficient, u is the surface velocity, and R'_x is $\left[1/R_1 + 1/R_2\right]^{-1}$ where R_1 and R_2 are radii of the elements 1 and 2 in the rolling direction.)

6. The film thickness measurements verified results of 120-millimeter- and 25-millimeter-bore bearing tests with the same lubricants. Very low film thicknesses were measured at conditions similar to those where the bearings suffered surface damage.

Lewis Research Center,
National Aeronautics and Space Administration,
Cleveland, Ohio, April 6, 1971,
126-15.

REFERENCES

1. Dowson, D.; and Higginson, G. R.: Elasto-Hydrodynamic Lubrication: The Fundamentals of Roller Gear Lubrication. Pergamon Press, 1966.
2. Zaretsky, Erwin V.; and Ludwig, Lawrence P.: Advancements in Bearings Proceedings of the NASA Lewis Research Center Conference on Aircraft Propulsion. NASA SP-259, 1970.
3. Shevchenko, Richard P.: Lubricant Requirements for High Temperature Bearings. Paper 660072, SAE, Jan. 1966.
4. Klaus, E. E.; and Tewksbury, E. J.: High Temperature Fluids and Their Evaluation. Presented at the Air Force Materials Laboratory Hydraulic Fluids Conference. Dayton, Ohio, Sept. 6-8, 1967.
5. Parker, R. J.; Bamberger, E. N.; and Zaretsky, E. V.: Evaluation of Lubricants for High-Temperature Ball Bearing Applications. J. Lubr. Tech., vol. 90, no. 1, Jan. 1968, pp. 106-112.

6. Bamberger, Eric N.; Zaretsky, Erwin V.; and Anderson, William J.: Fatigue Life of 120-mm Bore Ball Bearings at 600^o F with Fluorocarbon, Polyphenyl Ether, and Synthetic Paraffinic Base Lubricants. NASA TN D-4850, 1968.
7. Zaretsky, Erwin V.; Anderson, William J.; and Bamberger, Eric N.: Rolling-Element Bearing Life from 400^o to 600^o F. NASA TN D-5002, 1969.
8. Bamberger, E. N.; Zaretsky, E. V.; and Anderson, W. J.: Effect of Three Advanced Lubricants on High-Temperature Bearing Life. J. Lub. Tech., vol. 92, no. 1, Jan. 1970, pp. 23-33.
9. Parker, Richard J.; and Zaretsky, Erwin V.: Effect of Oxygen Concentration on the Performance of Synthetic Paraffinic Oils in Short Term Bearing Tests from 400^o to 500^o F. NASA TN D-5152, 1969.
10. Bell, J. C.; and Kannel, J. W.: Simulation of Ball-Bearing Lubrication with a Rolling-Disk Apparatus. J. Lub. Tech., vol. 92, no. 1, Jan. 1970, pp. 1-15.
11. Grubin, A. N.; and Vinogradova, I. A.: Fundamentals of the Hydrodynamic Theory of Heavily Loaded Cylindrical Surfaces. Symposium on Investigation Into the Contact of Machine Components. Book No. 30, Central Scientific Institute for Technology and Mechanical Engineering, Moscow, 1949. (D.S.I.R. Trans. No. 337).
12. Archard, J. F.; and Cowking, E. V.: Elastohydrodynamic Lubrication of Point Contacts. Proc. Inst. Mech. Eng., vol. 180, pt. 3b, 1965-1966, pp. 47-56.
13. Cheng, H. S.: A Numerical Solution of Elastohydrodynamic Film Thickness in an Elliptical Contact. J. Lub. Tech., vol. 92, no. 1, Jan 1970, pp. 155-162.
14. Dyson, A.; Naylor, H.; and Wilson, A. R.: The Measurement of Oil-Film Thickness in Elastohydrodynamic Contacts. Proc. Inst. Mech. Eng., vol. 180, pt. 3B, 1965-1966, pp. 119-134.
15. Greenwood, J. A.: A Re-examination of EHL Film-Thickness Measurements. Wear, vol. 15, no. 4, Apr. 1970, pp. 281-290.
16. Allen, C. W.; Townsend, D. P.; and Zaretsky, E. V.: Elastohydrodynamic Lubrication of a Spinning Ball in a Nonconforming Groove. J. Lub. Tech., vol. 92, no. 1, Jan. 1970, pp. 89-96.
17. Sibley, L. B.; and Orcutt, F. K.: Elasto-Hydrodynamic Lubrication of Rolling-Contact Surfaces. ASLE Trans., vol. 4, no. 2, Nov. 1961, pp. 234-249.
18. Foord, C. A.; Hammann, W. C.; and Cameron, A.: Evaluation of Lubricants Using Optical Elastohydrodynamics. ASLE Trans., vol. 11, no. 1, Jan. 1968, pp. 31-43.

19. Zaretsky, Erwin V.; and Anderson, William J.: Preliminary Determinations of Temperature Limitations of Ester, Ether, and Hydrocarbon Base Lubricants in 25-mm Bore Ball Bearings. NASA TN D-4146, 1967.
20. Deryagin, B. V.; Karassev, V. V.; Zakhavaeva, N. N.; and Lazarev, V. P.: The Mechanism of Boundary Lubrication and the Properties of the Lubricating Film. *Wear*, vol. 1, 1957-1958, pp. 277-290.
21. Drauglis, E.; Allen, C. M.; and Hartman, N. F.: Thin-Film Rheology of Boundary Lubricating Surface Films, Part I. Final Rep., Battelle Memorial Inst., Dec. 1970. (Under Contract N00019-70-C-0139.)

NATIONAL AERONAUTICS AND SPACE ADMINISTRATION

WASHINGTON, D. C. 20546

OFFICIAL BUSINESS

PENALTY FOR PRIVATE USE \$300

FIRST CLASS MAIL



POSTAGE AND FEES PAID
NATIONAL AERONAUTICS AND
SPACE ADMINISTRATION

002 001 C1 U 15 710723 S00903DS
DEPT OF THE AIR FORCE
WEAPONS LABORATORY /WLOL/
ATTN: E LOU BOWMAN, CHIEF TECH LIBRARY
KIRTLAND AFB NM 87117

POSTMASTER: If Undeliverable (Section 158
Postal Manual) Do Not Return

"The aeronautical and space activities of the United States shall be conducted so as to contribute . . . to the expansion of human knowledge of phenomena in the atmosphere and space. The Administration shall provide for the widest practicable and appropriate dissemination of information concerning its activities and the results thereof."

— NATIONAL AERONAUTICS AND SPACE ACT OF 1958

NASA SCIENTIFIC AND TECHNICAL PUBLICATIONS

TECHNICAL REPORTS: Scientific and technical information considered important, complete, and a lasting contribution to existing knowledge.

TECHNICAL NOTES: Information less broad in scope but nevertheless of importance as a contribution to existing knowledge.

TECHNICAL MEMORANDUMS: Information receiving limited distribution because of preliminary data, security classification, or other reasons.

CONTRACTOR REPORTS: Scientific and technical information generated under a NASA contract or grant and considered an important contribution to existing knowledge.

TECHNICAL TRANSLATIONS: Information published in a foreign language considered to merit NASA distribution in English.

SPECIAL PUBLICATIONS: Information derived from or of value to NASA activities. Publications include conference proceedings, monographs, data compilations, handbooks, sourcebooks, and special bibliographies.

TECHNOLOGY UTILIZATION PUBLICATIONS: Information on technology used by NASA that may be of particular interest in commercial and other non-aerospace applications. Publications include Tech Briefs, Technology Utilization Reports and Technology Surveys.

Details on the availability of these publications may be obtained from:

SCIENTIFIC AND TECHNICAL INFORMATION OFFICE

NATIONAL AERONAUTICS AND SPACE ADMINISTRATION

Washington, D.C. 20546