

Electrical Excitability of Isolated Frog Skin and Toad Bladder

ALAN FINKELSTEIN

From The Rockefeller Institute, New York. Dr. Finkelstein's present address is Department of Neurology, Albert Einstein School of Medicine, New York

ABSTRACT When current of proper polarity and sufficient intensity is passed across isolated frog skin or toad bladder, an action potential of about 200 mv and 10 msec. duration with a sharp threshold and refractory period of several seconds' duration is elicited. Interruption of current during the action potential abolishes the response, and, as shown by appropriate bridge measurements, this occurs because the action potential results from resistance variations during the current flow. The ionic composition of the medium bathing the frog skin was varied, and it was found that the response is relatively insensitive to changes in the solution bathing the inner surface, but rapidly and reversibly affected by changes in the outer solution, particularly by replacement of sodium with potassium and by variations of calcium concentration. It was also observed that the resistance of the skin and action potential across it are reversibly altered by metabolic inhibitors and that these alterations occur *independently* of any changes in the intrinsic EMF of the system. From the finding that the action potential across frog skin and toad bladder results from a time-variant resistance, it is argued that this same phenomenon can be the basis of electrical excitability in general. This would attribute physical significance to the equivalent circuit commonly employed to represent the plasma membrane; *i.e.*, the plasma membrane would be a mosaic structure of spatially separate permselective regions.

INTRODUCTION

The isolated frog skin and toad bladder have been for some time familiar preparations to physiologists interested in the transport of water and electrolytes across cell membrane systems. As is well known, both of these organs under appropriate conditions can maintain for several hours a significant electrical potential difference between symmetrical solutions bathing their two surfaces, can transport certain ions against electrochemical potential gradients, and can undergo large changes in both of these properties and in their water permeability when exposed to certain hormones and pharmaceutical agents. It has recently been found, however, that these two structures

have the additional property of being electrically excitable (Finkelstein, 1961), and it is with the investigation of this phenomenon that this paper is concerned. The purpose of this study is threefold: First, to describe the excitable response (action potential) in frog skin and toad bladder and to discuss some of the parameters affecting it; second, to show that this action potential is the result of a time-variant resistance element which can be completely decoupled from any intrinsic EMF in the system; and third, to discuss the implications of the resistive nature of the action potential in these structures with respect to the general phenomenon of electrical excitability in more familiar systems; *i.e.*, nerve and muscle.

MATERIALS AND METHODS

All the experiments to be described were performed *in vitro* on the abdominal skin of the frog *Rana pipiens* (occasionally *Rana temporaria*) and on half-bladders of the toad *Bufo marinus*; they were conducted over a 2 year period on both male and female animals during all seasons of the year. The skin (or bladder) upon removal was immediately mounted between two cylindrical Lucite compartments, 6.5 cm long, 1.15 cm² cross-sectional area; in most experiments the compartments were filled with Gray-Ringer solution.¹ A pair of Ag/AgCl electrodes was used for passing steps of current (obtained from an A.E.L. model No. 104A stimulator with a 100 k Ω series resistance) across the preparation, and the resulting voltage response was measured by a pair of saturated calomel electrodes coupled to the two surfaces of the preparation through saturated agar-KCl bridges. (The calomel electrodes were connected to a Tektronix 502 dual beam oscilloscope with an input impedance of 10 megohms.) In control experiments it was found that the results were unaffected by stirring in the two compartments; consequently, in most cases, stirring was dispensed with for the sake of convenience. In those experiments in which nitrogen and air were bubbled through the solutions bathing the preparation, the Ringer solution consisted of 116 mM NaCl; 2.0 mM KCl; 1.8 mM CaCl₂; 1.0 mM NaH₂PO₄; 2.0 mM Na₂HPO₄. This change of solution from that used in the other experiments was made in order to avoid precipitation of calcium.

RESULTS

Within an hour after mounting either preparation in the chamber a steady-state DC potential of from 20 to 100 mv was obtained across the system with Gray-Ringer solution on both sides. In the skin, the serosal (inside) surface is positive with respect to the anatomical outside; in the bladder the serosal surface is positive with respect to the mucosal (luminal) side.

A. The Basic Responses Fig. 1 shows a typical set of responses of the skin to square waves of current of 35 msec. duration. For small values of inward

¹ 72 mM NaCl; 5.0 mM KCl; 2.5 mM CaCl₂; 1.6 mM MgCl₂; 20 mM NaHCO₃; 1.03 mM Na₂HPO₄; 0.12 mM NaH₂PO₄; 0.26 mM glucose. Solution was saturated with a 97 per cent O₂, 3 per cent CO₂ gas mixture.

(depolarizing) and outward (hyperpolarizing) current² the voltage responses are symmetrical (Fig. 1 a), and the skin is phenomenologically equivalent to a network consisting of a resistance and capacitance in parallel (parallel RC network). The resistances observed range from 0.2 to 1.0 k Ω /cm², and the capacitances range from 2 to 5 μ f/cm². As the magnitude of the current pulse is increased, the potential changes begin to show non-linearity and rectification, with the larger response occurring for outward current (Fig. 1 b). At still higher current densities, the system is very non-linear, and for an outward current pulse, overshoot (a graded response) occurs (Fig. 1 c). As the magnitude of the inward current pulse is continually increased, a value is eventually reached at which the skin is near threshold; this value occurs around 300 mv; *i.e.*, the inside surface of the skin is -300 mv with respect to the outside. At this point, if the magnitude of the current pulse is increased slightly, the skin responds with an "action potential" for inward current pulses, while continuing to give an overshoot for outward currents (Fig. 1 d). (In some skins, instead of an overshoot response for outward currents, there occurs an action potential with a sharp threshold and a form essentially the mirror image of the type shown in Fig. 1 d; this is illustrated in Fig. 2.) In Fig. 3, the response is shown for current of longer duration. Note that there is *not* repetitive firing, although a second, graded oscillation does occur.

Following an action potential, the skin becomes refractory for several seconds (5 to 20 sec.), not exhibiting an active response to the same stimulus that previously elicited it (Fig. 4). If during this period the skin is stimulated at the rate of 10/sec. or faster, it will continue to remain refractory and show only an RC type of response; stimulation at the rate of 1/sec. or less, on the other hand, has no appreciable effect on the duration of the refractory period.

In Fig. 5 is seen a striking example of the recovery of excitability following a full response. In this experiment, a small short (2.5 msec.) pulse is superimposed on a 40 msec., just subthreshold pulse. The interval between successive records is 3 sec. Curves a, b, and c show a characteristic subthreshold "local response," curve d is the full action potential. A pulse 3 sec. after this would give curve a again, etc.

Turning to the toad bladder, we find qualitatively the same behavior as described above for the frog skin. The resistances of the bladders are generally higher than those of the skins, ranging from 0.75 to 2.5 k Ω /cm², but the capacitances are within the same range of values as in the skin. Fig. 6 illus-

² Inward current means a current produced with the cathode in the solution bathing the inner surface of the skin (serosal surface of the bladder) and the anode in the solution bathing the outer surface (mucosal surface of the bladder); the reverse is the case for outward current. Thus, an inward current causes the inner surface of the skin (serosal surface of bladder) to go negative with respect to the outer surface (mucosal surface of bladder), hence reducing (for small currents) and reversing (for larger currents) the resting potential of the preparation.

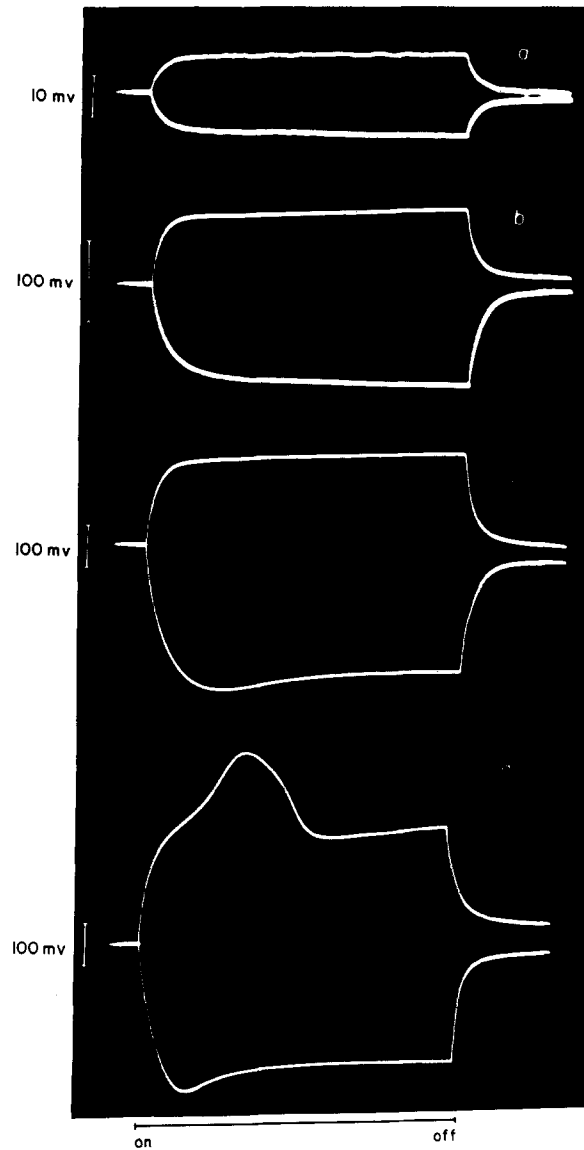

FIGURE 1. The change in potential across isolated frog skin produced by 35 msec. square waves of current. Upward response is the result of inward current; downward response is the result of outward current. Currents are 20, 210, 500, and 550 $\mu\text{a}/\text{cm}^2$ for a, b, c, and d, respectively. Resting potential is 30 mv, inside positive. Gray-Ringer's solution on both sides.

trates the action potential for inward current and a small overshoot response for outward current. (Unlike the skin, the bladder has never displayed an action potential with a sharp threshold for outward current.) Note that the action potential of the bladder is of longer duration than that for the skin;

and in particular, the falling phase is considerably extended in time. As in the skin, the refractory period is of several seconds' duration, but it is generally not so long as in that system, being only about 5 sec.

Very often the bladder preparation failed to exhibit a response with a sharp threshold for inward current, displaying instead a graded overshoot behavior. The full all-or-none response could frequently be initiated, however, by first repetitively stimulating for several seconds with threshold currents at a frequency of 10/sec. or faster. This phenomenon is illustrated in Fig. 7. It was observed that during the repetitive current stimulation the magnitude of the

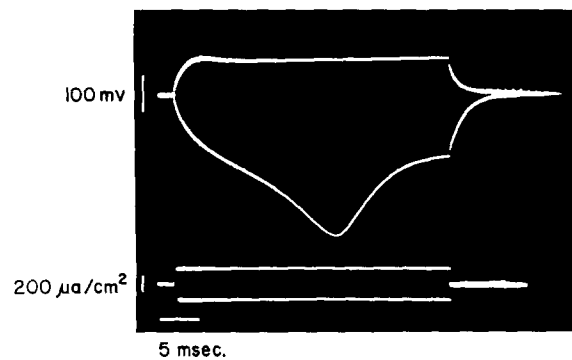

FIGURE 2. Record illustrating an action potential for outward current across isolated frog skin. The upward response is the result of inward current; the downward response is the result of outward current. (At higher current densities, an action potential of the form shown in Fig. 1 d occurs for inward current.) Resting potential is 50 mv; inside positive. Gray-Ringer's solution on both sides.

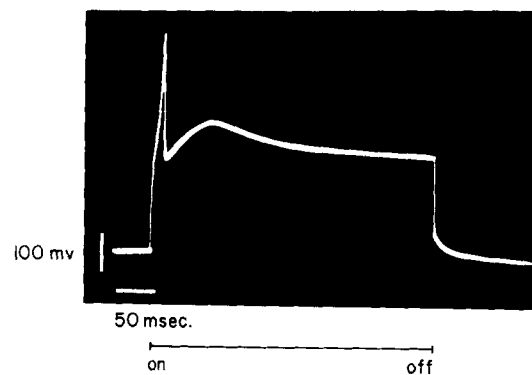

FIGURE 3. The action potential across isolated frog skin in response to a prolonged (350 msec.) inward current of intensity $700 \mu\text{a}/\text{cm}^2$. (Note the difference in time scale as compared to Fig. 1.) Resting potential is 32 mv; inside positive. Gray-Ringer's solution on both sides.

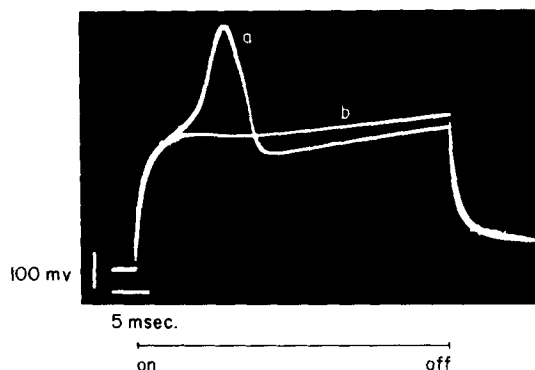

FIGURE 4. Record illustrating the refractory period following an action potential across isolated frog skin. Both tracings are in response to an inward current of $800 \mu\text{a}/\text{cm}^2$; tracing b was obtained 5 sec. after a. (The stimulating current is slightly above threshold.) Resting potential is 35 mv; inside positive. Gray-Ringer's solution on both sides.

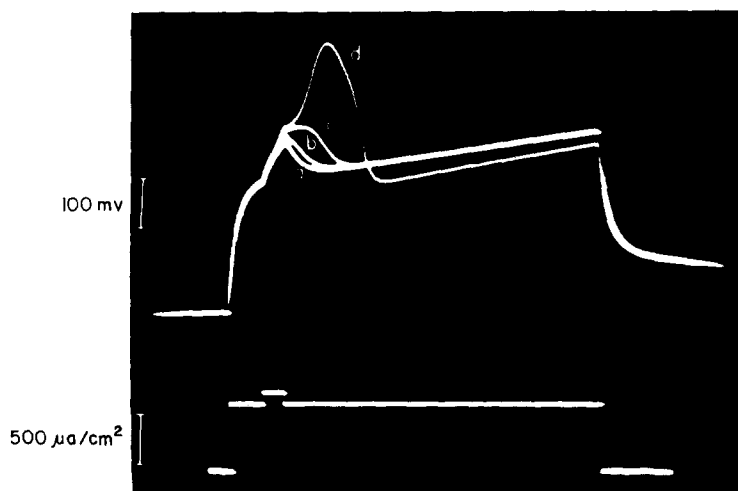

FIGURE 5. Recovery of excitability of isolated frog skin during the refractory period. The stimulus is a 40 msec. just subthreshold inward square wave of current with a superimposed 2.5 msec. small inward square wave. Successive responses a, b, c, and d are 3 sec. apart. Resting potential is 60 mv; inside positive. Gray-Ringer's solution on both sides.

resulting transbladder voltage decreased; we shall comment later on this point.

In summary, when the potential across the frog skin or toad bladder preparation, bathed on both sides by Gray-Ringer solution, has reached an appropriate value (about 300 mv inside negative in the skin and about 200 mv serosal side negative in the bladder), there occurs at a sharp threshold an

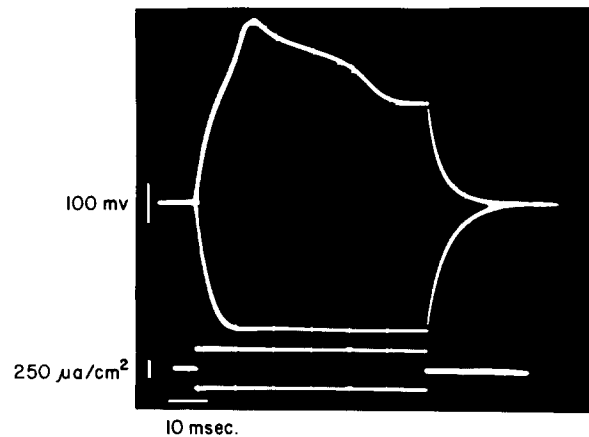

FIGURE 6. The action potential across isolated toad bladder in response to a 60 msec. square wave of superthreshold current. The upward response (action potential) is the result of inward current; the downward response is the result of outward current. Resting potential is 80 mv; serosal side positive. Gray-Ringer's solution on both sides.

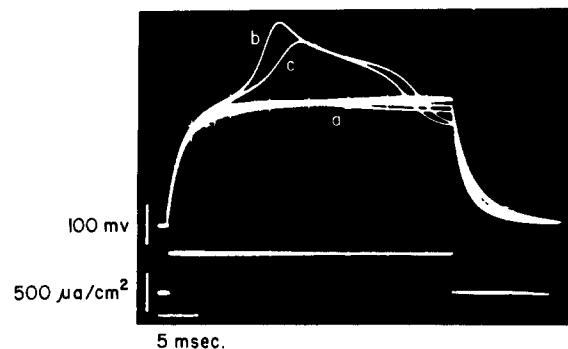

FIGURE 7. The production of action potentials across isolated toad bladder following repetitive stimulation. Initially, this preparation was unexcitable. Following repetitive stimulation at the rate of 10/sec. for 20 sec., with a sufficiently large inward current (in this case $500 \mu\text{a}/\text{cm}^2$), the preparation became excitable. In this record the intensity of the repetitive stimulating current and of the current producing the action potential was the same. The a tracings were obtained during the repetitive stimulation; tracings b and c were obtained 4 and 5 sec., respectively, after the repetitive stimulation. Note the short refractory period, as evidenced by the fact that tracing c was obtained 1 sec. after b. This is a distinguishing feature of a bladder that has been repetitively stimulated. Resting potential is 90 mv; serosal side positive. Gray-Ringer's solution on both sides.

action potential of from 100 to 300 mv magnitude. Following this response, the preparation is refractory for several seconds.

B. The Resistive Nature of the Responses If at any time during the occurrence of the action potential (in either the skin or bladder) the stimulating

current is interrupted, the response fails to proceed, and the potential across the preparation rapidly decays to its resting level (Fig. 8). (It is interesting that a refractory period does *not* develop if the current is interrupted at some time during the early or middle part of the rising phase of the spike. Refractoriness begins to appear near the end of the rising phase, and if the current is removed at any time after the peak in the potential has been reached, a full length refractory period follows. It appears, therefore, that the events re-

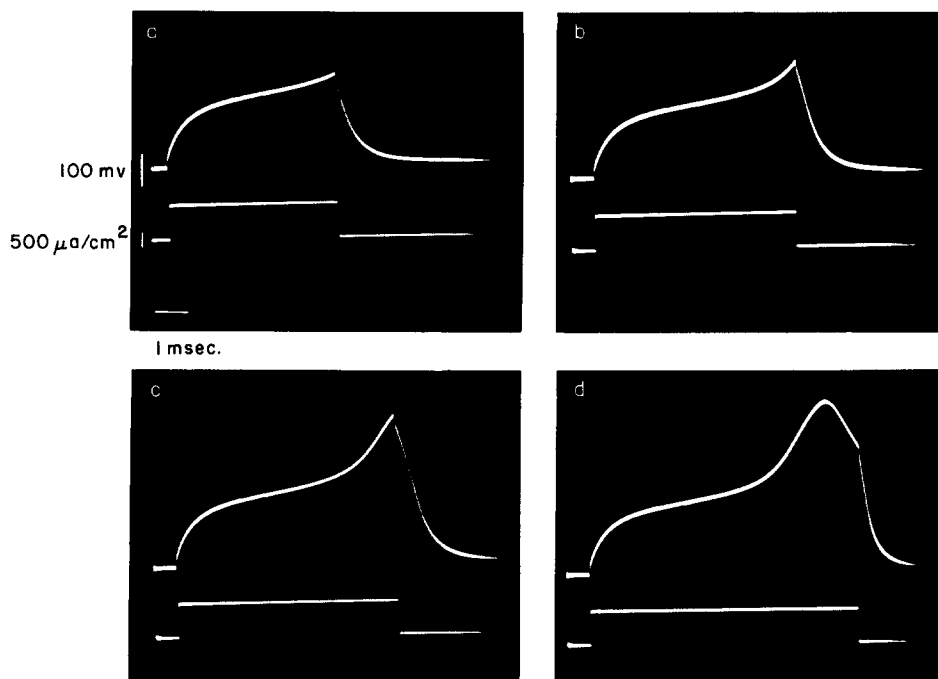

FIGURE 8. Records demonstrating that removal of the current during any phase of the action potential causes an interruption of the response. (These records were obtained on frog skin; similar results are obtained for the toad bladder.) Gray-Ringer's solution on both sides.

sponsible for refractoriness are those associated with the production of the falling phase of the response.) Thus, the action potential occurs only in the face of a current passing across the preparation. This immediately suggests that the observed response is due to the fact that the preparation is behaving as a time-variant resistance; that is, the observed voltage changes result from resistance variations during the steady current flow.

In order to determine whether this is indeed the case, a bridge measurement was performed. The reference arm consisted of a resistance in series with a parallel RC network. The frequencies used to operate the bridge were

1000 to 2000 cps, and the maximum voltage introduced across the preparation was less than 10 mv. The measurements were performed as follows: the bridge was first balanced for a just subthreshold stimulating current. Then, the stimulating current was increased slightly so as to produce an action potential. During the action potential the bridge became unbalanced, and this could be seen superimposed on the response. In order to determine the direction and magnitude of the unbalance, the bridge was balanced at various times during the response. This could always be accomplished by changing the parallel resistance element in the reference arm with little change in the capacitance and series resistance element in that arm. By such a procedure it was found that during the early and middle part of the rising phase of the response, the resistance increased, and that following this it began to fall, actually reaching a value below that which existed during the subthreshold period.³ These results are completely in accord with and confirm the view that the voltage response is due to a time-variant resistance. (Notice that the fact that at the end of the spike the potential falls to a value below that of the subthreshold potential (see Figs. 4 and 7) is the result of the resistance falling below the subthreshold value. We now see also that the decrease in the transbladder voltage response during repetitive stimulation (Fig. 7) is the result of a fall in the transbladder resistance; once this low resistance state has been reached, the previously graded response is converted to an all-or-none response. That is, once in the low resistance state, the bladder can be electrically stimulated to pass in an all-or-none manner to a high resistance state.)

C. The Current-Voltage Characteristic In Fig. 9 is shown a plot of the peak voltage response of the frog skin as a function of current. (A similar curve is obtained for the toad bladder.) Notice that the height of the action potential barely increases with increasing current. (The effect of increased current is to shorten the latency and duration of the active response.) This means that although the spike is produced by an increased total chord resistance of the preparation, the slope resistance at the peak is markedly decreased. In fact, we see in Fig. 10 that following the action potential, the skin remains in a state of small slope resistance, which in a sense is another manifestation of the refractory period. We further observe in Fig. 9 that also for large outward currents the slope resistance of the skin decreases. Since in this region the peak of the graded overshoot response is being plotted, we may infer (considering also the fact that in some skins an all-or-none action potential occurs for outward currents) that the graded response is not basically a different phenomenon from the all-or-none response.

³ If the current is interrupted during the rising phase of the response (as in Fig. 8), the resistance change does not proceed as described above, but instead decays monotonically to the resting level. Thus, the resistance variation does not proceed in the absence of current flow.

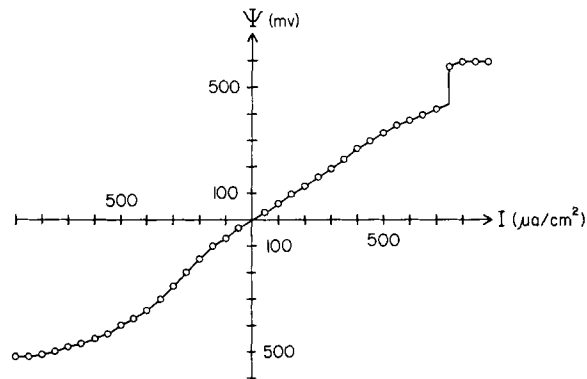

FIGURE 9. The peak voltage response across frog skin as a function of current. The duration of the current pulse is 180 msec. The abrupt rise in voltage at $750 \mu\text{a}/\text{cm}^2$ inward current indicates the occurrence of the action potential. Resting potential is 45 mv; inside positive. (The curve has been displaced upward 45 mv on the Ψ -axis.) Gray-Ringer's solution on both sides.

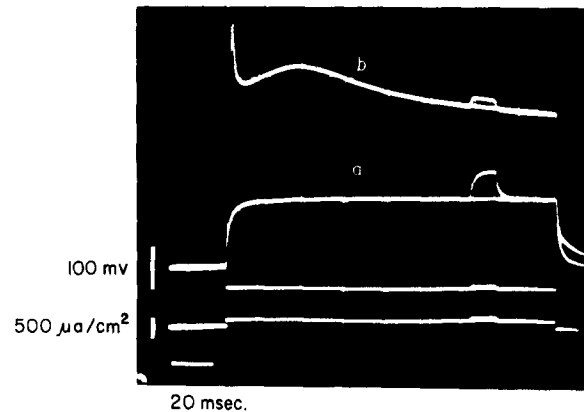

FIGURE 10. Record illustrating the small slope resistance of the frog skin following an action potential. Superimposed upon a 160 msec. inward square wave of current is a small 10 msec. inward square wave. Note that the same 10 msec. pulse produces a much larger voltage (tracing a) when added on a subthreshold current than when added on a current pulse that has given rise to an action potential (tracing b). Resting potential is 60 mv; inside positive. Gray-Ringer's solution on both sides.

D. *The Effect of Changing the Ionic Compositions of the Solutions*⁴ In general, alteration of the ionic composition of the solution bathing the inner surface of the skin produces negligible effects on the action potential. These altera-

⁴ In this and the succeeding section the experiments to be discussed will be confined to the frog skin. The reason for this is that the all-or-none action potential is much less frequently obtained in the bladder than in the skin, where it is almost always present. Furthermore, alterations of the ionic composition in the bladder preparation frequently produce irreversible changes, and in these sections we are particularly interested in reversible effects.

tions include substitution of all of the sodium by potassium or rubidium, varying the calcium concentration from 0 to 30 mM, and substitution on an equivalent basis of all of the chloride by sulfate. (In the calcium experiments, the irreversible loss of excitability sometimes occurred upon prolonged (30 min. or longer) exposure to calcium-free solutions or to high calcium concentrations.) On the other hand, the active response is markedly affected by similar changes in the ionic composition of the solution bathing the outer surface, and it is these results which we shall now discuss.

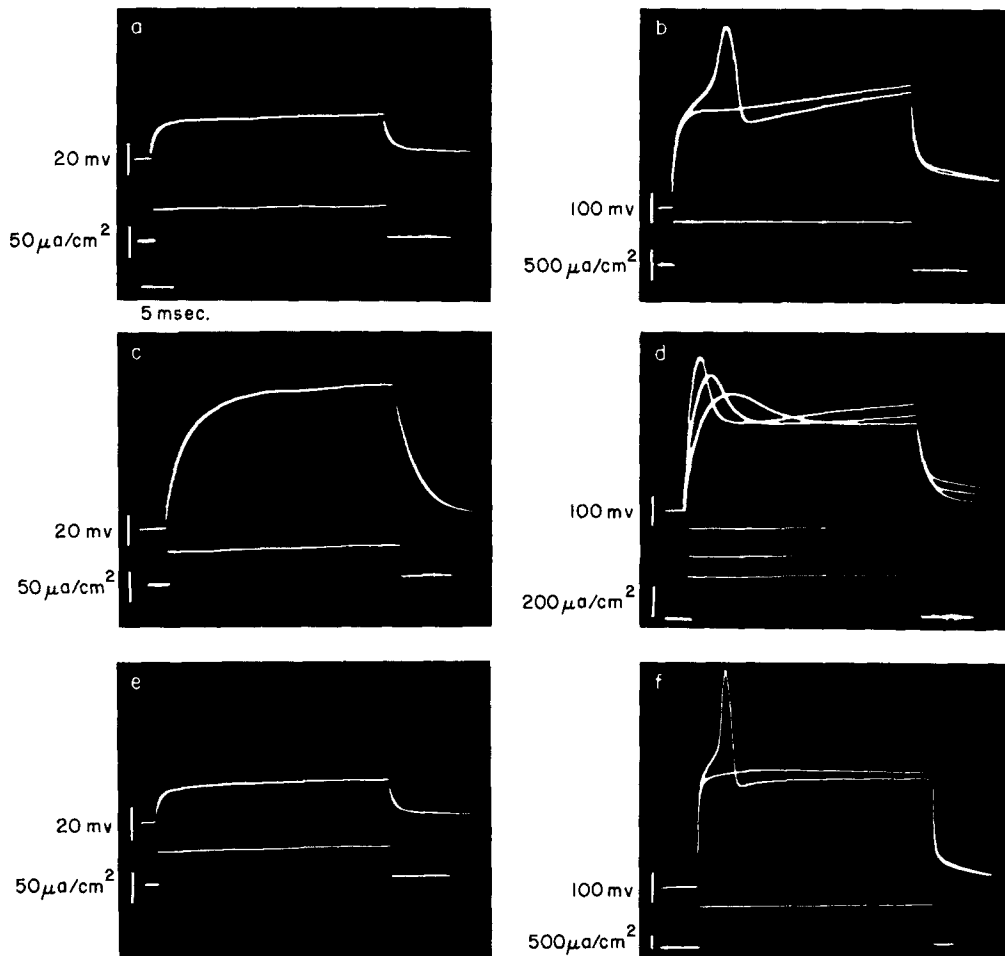

FIGURE 11. Results of substituting K^+ for Na^+ on the inside and outside of isolated frog skin. In records a and b the solution on both sides is sulfate Ringer's (50 mM Na_2SO_4 ; 2.5 mM K_2SO_4 ; 2.5 mM $CaCl_2$); in records c and d the inside solution is still sulfate Ringer's, but the outside solution has been changed to 50 mM K_2SO_4 + 2.5 mM $CaCl_2$; in records e and f, the outside solution has been changed to sulfate Ringer's and the inside solution to 50 mM K_2SO_4 + 2.5 mM $CaCl_2$. (In records b and f, the interval between the two responses is 3 sec.; the first response is the larger.)

A "normal" all-or-none action potential occurs when virtually all of the chloride is replaced by sulfate on either one side or both sides of the skin. In Fig. 11 b is seen such a response with sulfate Ringer on both sides. In several experiments we replaced the sulfate on an equivalent basis by methylsulfate without observing any marked change in the response.

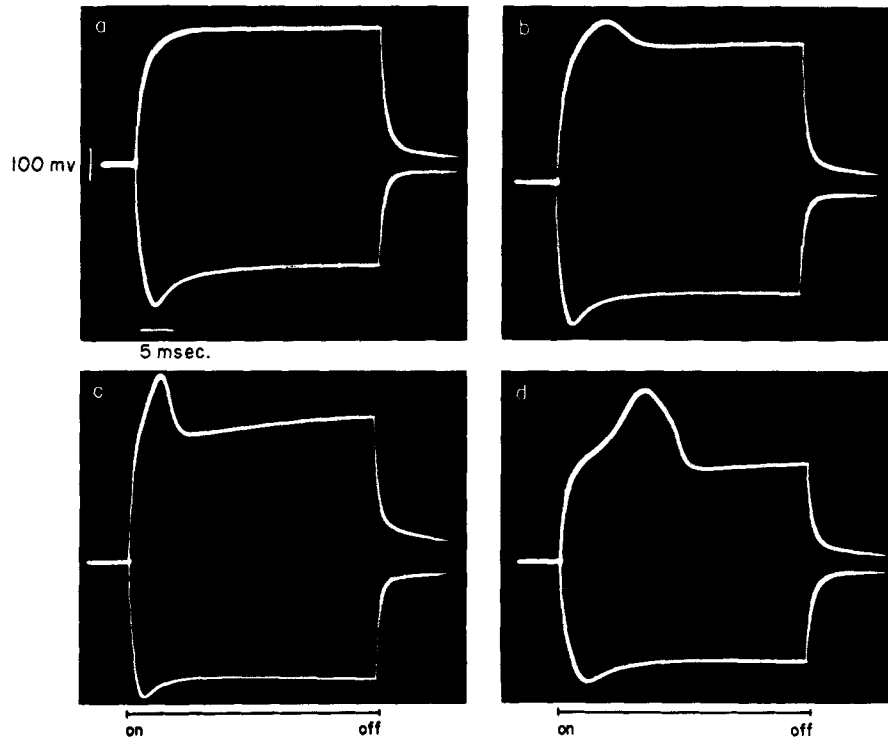

FIGURE 12. Effect of removal of Ca^{++} from the outside solution on the excitability of isolated frog skin. In all records the inside solution consists of 0.1 M NaCl + 2.5 mM CaCl_2 . In records a, b, and c the outside solution contains only 0.1 M NaCl. Record d was taken 10 sec. after the outside solution had been changed to 0.1 M NaCl + 2.5 mM CaCl_2 . The currents are 700, 800, 900, and 550 $\mu\text{a}/\text{cm}^2$ for a, b, c, and d, respectively. (In all records the upward tracing is the response to inward current and the downward tracing is the response to outward current.)

If the Na^+ concentration is reduced on the outside to 20 mM either with or without replacement by K^+ , there is little change in the active response. Below this level, however, the response begins to lose its all-or-none character and becomes graded. In Fig. 11, we see the result of replacing all of the Na^+ by K^+ in the outer solution. We observe that the small-signal resistance of the preparation markedly increases when K^+ replaces Na^+ (compare Figs. 11 a and 11 c), and that for large inward current, the all-or-none action potential has changed to a graded overshoot response (Figs. 11 b and 11 d). For com-

parison we see in Fig. 11 f that replacement of Na^+ by K^+ in the inner solution does not produce a change in the all-or-none character of the response. We wish to point out that the alteration in the response produced by substitution of K^+ for Na^+ (as seen in Figs. 11 c and 11 d) on the outside occurs within the time it takes to change the solutions (not more than 10 sec.). Furthermore, the

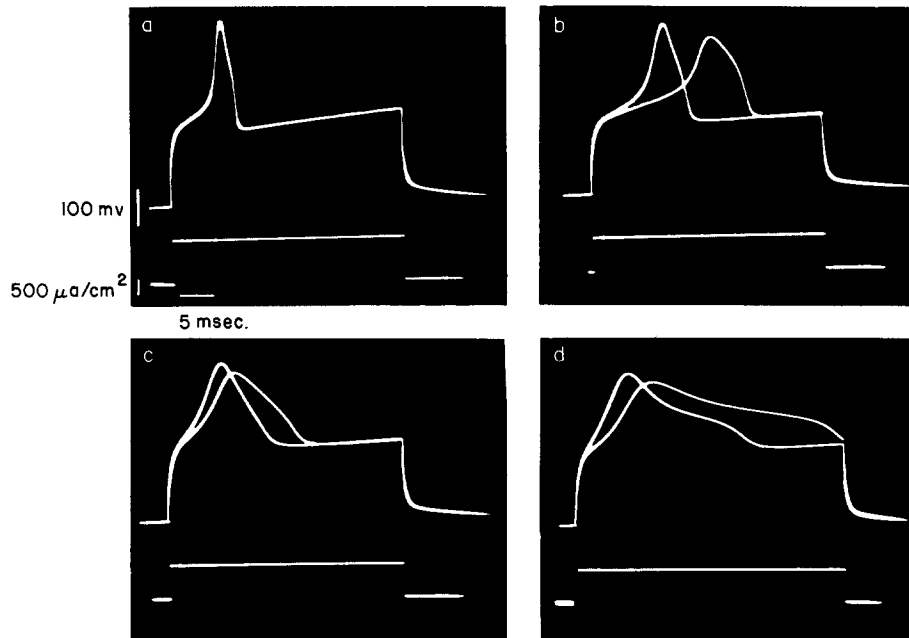

FIGURE 13. Effect on the action potential of isolated frog skin of increasing Ca^{++} concentration in the outside solution. In all records the inside solution is Gray-Ringer's and the outside solution has 100 mM NaCl, 5 mM KCl + x mM CaCl_2 . The Ca^{++} concentration is 2.5 mM, 10 mM, 20 mM, and 30 mM, in a, b, c, and d, respectively. In those records in which there are two tracings the interval of time between responses is 2 sec. and the more prolonged response is the second. Note that the current necessary to produce an action potential is smaller the higher the Ca^{++} concentration. (All currents are inward.)

effect is completely reversible. Even after the skin has been exposed for over 2 hours to the sodium-free solution, replacement of the K^+ by Na^+ leads "immediately" to a return of the system to its previous state; that is, the resistance drops to its normal value and the all-or-none response reappears.

The character of the response is dramatically affected by the concentration of Ca^{++} in the outside solution.⁵ If the Ca^{++} concentration is reduced to 0, the threshold of the action potential rises considerably, and in about half of the

⁵ There were no dramatic changes observed in resting potential or small-signal resistance when the Ca^{++} concentration was varied.

experiments the all-or-none character is lost, the response becoming graded. This is particularly true if the potassium concentration is also brought to 0 along with the Ca^{++} . A typical set of records is seen in Fig. 12. The full magnitude of the effect produced by removal of Ca^{++} from the outer solution requires from 5 to 15 min. to develop, although an observable effect is seen within a few seconds. The effect of the calcium-free solution, however, is completely reversible; replacement of Ca^{++} to a concentration of 2.5 mM leads to an "immediate" (within 10 sec.) return of the all-or-none response (see Fig. 12 d), even after the skin has been exposed to Ca^{++} -free solution on its outer surface for an hour or longer.

Elevation of the Ca^{++} concentration in the outer solution causes a lengthening of the action potential; this is particularly true of the falling phase. Also, the refractory period is shortened in high Ca^{++} solutions. A typical set of records is shown in Fig. 13. Again this is a reversible phenomenon, although it may require several minutes for full recovery from prolonged high Ca^{++} treatment. It is interesting to note that changes of Mg^{++} concentration over the same range produce no noticeable effect on the response.

E. Effect of Anoxia In all the experiments reported above there was no attempt made to control the O_2 level in the bathing solutions. The Ringer's solution is initially saturated with 97 per cent O_2 , and it is certainly safe to say that the O_2 tension, even in prolonged experiments, does not fall below 20 per cent (air). In the experiments to be described in this section, however, the O_2 in solution is removed by bubbling with N_2 and replaced by rebubbling with air.

Let us first consider what happens to the electrical properties of frog skin when we replace the O_2 in solution by N_2 . Over a period of from 1 to 2 hours, the resting potential gradually declines, eventually reaching zero potential. If during this period the response to small steps of current is observed, it is found that for about 45 min. there is no change in the response from that which existed in the presence of O_2 . There then occurs, within a period of 5 min., a rise of the resistance to a new steady-state value of from two to three times that of the previous value. (This change occurs even before the resting potential has fallen completely to zero.) Prior to this rise in resistance, the action potential still occurs for large inward currents. After the resistance rise, an all-or-none action potential can no longer be elicited; at best a graded, overshoot response is evoked. This behavior is illustrated in Fig. 14. In Figs. 14 a and 14 b are seen the responses of the skin in O_2 to small and large inward currents, and in Figs. 14 c and 14 d are seen the responses after the preparation has been exposed to a nitrogen atmosphere for 90 min.

As stated above, continued exposure to nitrogen brings the resting potential down to 0, without any further changes in the skin resistance. If now, O_2 is

readmitted into the system, within 3 min., the resistance of the skin falls to its previous value, and the full, all-or-none action potential reappears. These results are shown in Figs. 14 e and 14 f. During this 3 min. interval, the resting potential across the skin remains at zero. (The recovery of the resting potential

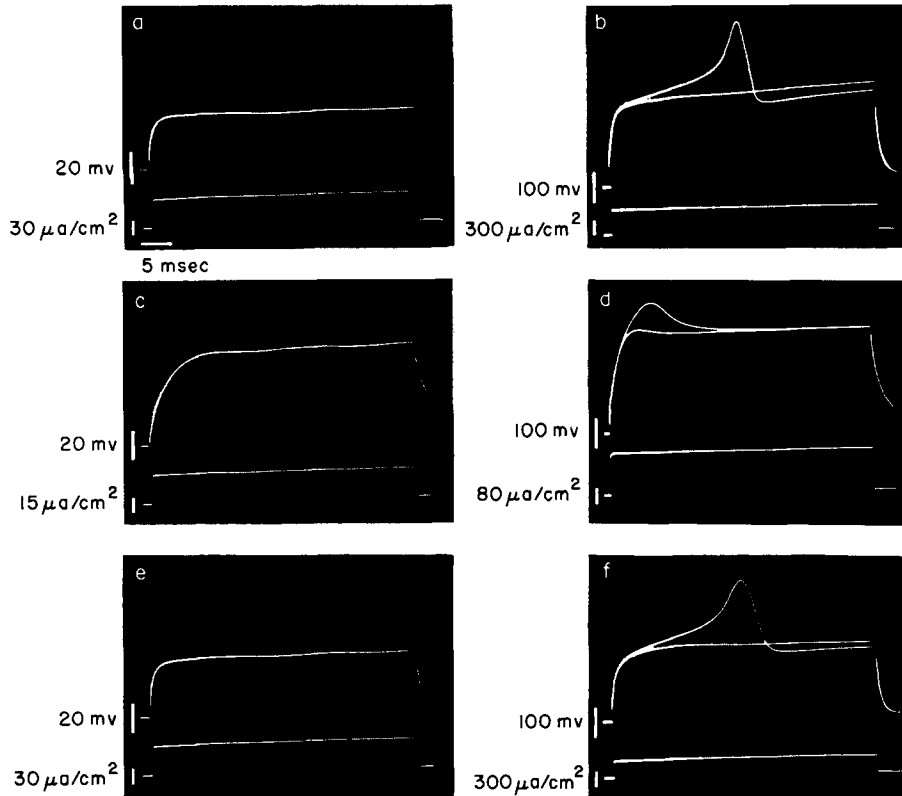

FIGURE 14. Effect of anoxia on the voltage response of isolated frog skin to inward current. Records a and b were taken after the skin had been exposed to oxygenated Ringer's solution for over 2 hours. The resting potential was 20 mv. Following these records, the Ringer solution was bubbled with N_2 for 90 min. and then records c and d were taken. The resting potential was then 0. Following these records, the Ringer solution was bubbled with O_2 for 3 min. and then records e and f were taken. The resting potential was still 0 at this time. (In those records with two tracings, the interval between responses is 2 sec.; the first response is the larger.)

is a very slow process, occurring over a period of an hour or longer.) The experiment can be repeated several times. Thus, again replacing O_2 by N_2 , the skin resistance rises by two- or threefold and the action potential disappears. (The time required for the resistance rise in the second exposure to N_2 is much shorter than the 45 min. necessary in the first exposure.) Readmitting O_2

causes a drop in resistance and reappearance of the action potential. We wish to emphasize that these events can take place without any concomitant changes in the resting potential, and that the oxygen effect occurs even after the skin has been in a nitrogen atmosphere for over 3 hours. We shall comment further on these experiments in the Discussion.

We have fixated on the effect of anoxia, because of the rapid reversibility of this effect. But we wish to mention that cyanide, azide, and dinitrophenol produce the same effect. Namely, in their presence,⁶ the skin resistance rises by a factor of 2 or 3 and the action potential can no longer be evoked. The difficulty with these metabolic inhibitors is that it requires a considerable length of time to wash them out of the system and return the resistance to its former level and restore the action potential. Thus, the phenomenon is not as dramatic as for the simple anoxia experiments, where reversibility is obtained within 3 min.

DISCUSSION

A. Site of Response Although both the skin and bladder are complex, multicellular organs, it is generally recognized that the layer of primary electrical and physiological importance is the epithelial layer (Ussing, 1948; Leaf *et al.*, 1958). In the bladder this is a single sheet of epithelial cells, while in the skin it is a more complex structure containing a cornified layer, and even some multicellular glands; the germinital layer of the epidermis, however, which is one or two cell layers thick, is regarded as the physiologically important one. Recently, it has been established directly, by the use of micropipettes, that the resting potential and the DC resistance of the bladder occur across the mucosal layer of cells, with about half of the total transbladder potential and resistance being associated with each of the two plasma membranes of these cells (Frazier, 1962). Similar results are reported with respect to the germinital layer in the skin (Engbaek and Hoshiko, 1957), although there has been some controversy over this point (Scheer and Mumbach, 1960).⁷

The question therefore arises as to which of the two plasma membranes of the epithelial cells is responsible for the action potential which we have described. Because of technical difficulties, we were unable to answer this question directly by the use of the micropipette technique. We may surmise, however, from the experiments in which the ionic composition of the solutions on the two sides of the skin was varied, that it is across the outer facing membrane

⁶ The concentration of CN^- used was from 1 to 2 mM; the concentration of azide used was 5 mM and that of DNP was 0.5 mM.

⁷ The question might be raised whether the measured electrical properties are characteristics of the cells or of the spaces between the cells. Recent electron microscopic studies have shown that the epithelial cells are very tightly fused together (Peachey and Rasmussen, 1961; Choi, 1963; Palade). It may therefore be safely assumed that the properties of interest are related to the cells themselves rather than to the intercellular spaces.

in the skin (and by inference the luminal facing membrane in the bladder) that the action potential occurs, since changes in the composition of the solution bathing the inner surface produce no significant alteration in the response, while similar changes in the solution bathing the outer surface produce rapid and reversible alteration in the character of the response (see part D of the Results section).

It is of some interest to note that the outer membrane in the skin and the luminal membrane in the bladder have been shown to be much more permeable to Na^+ than to K^+ and other ions (Koefoed-Johnsen and Ussing, 1958; Frazier *et al.*, 1962). This is consistent with Figs. 11 a and 11 c, where we see that the resistance of the skin rises considerably when Na^+ in the outer solution is replaced by K^+ . Now if the active membrane is indeed the outer one, then, since the basis of the rising phase of the all-or-none action potential is a rise in resistance, this must mean that *at least* the Na^+ resistance must increase during the action potential, which is just the opposite of what occurs in nerve. We see further in Fig. 11 d that when K^+ replaces Na^+ in the outside medium, there is no longer an all-or-none response but instead a graded response which appears to be primarily a manifestation of a fall in resistance (from the high resting values in K^+ Ringer's) during the current flow rather than first an increase in resistance *followed* by a decrease.

B. Related Phenomena We have continually emphasized that the action potential in frog skin and toad bladder is a consequence of current flow through a time-variant resistance element rather than the result of a variation in any intrinsic EMF of the system. Because, as we shall argue below, this may be the general basis of electrical excitability in more familiar structures (*i.e.*, nerve and muscle), it is useful to note several other examples in the literature of responses which appear to be basically resistance phenomena. The one bearing a most striking similarity to the behavior we have described in frog skin and toad bladder is the hyperpolarizing response in lobster muscle⁸ as reported by Reuben *et al.* (1961). By somewhat indirect (but rather convincing) means, these authors conclude that the action potential which they observe is a consequence of a rise and fall in transmembrane resistance during the passage of hyperpolarizing current; the figures and data which they present are very similar to some of our records (compare especially their Fig. 4 with our Fig. 9). The response of the plant cell *Halicystis* to outward current as reported by Blinks (1936 *b*) also bears a close resemblance to the basic response we have described. While Blinks does not address himself to the problem of whether he is in fact dealing with a time-variant resistance phenomenon, this would appear to be a reasonable conclusion from his data.

In the frog node of Ranvier bathed by isotonic KCl there occurs a response

⁸ A phenomenon very similar to this is the hyperpolarizing response of squid axon in potassium-enriched sea water (Tasaki, 1959).

reported by Mueller (1959) which also appears to be the result of resistance variation. In this case, however, the resistance first falls and then rises rather than the reverse, which occurs in our systems. The phenomenon is as follows: hyperpolarizing current is passed across the node until its potential is brought back approximately to the resting value (-60 mv). If now a short cathodal (depolarizing) current is passed across the node, then *superimposed on the hyperpolarizing current*, the potential rises to a value always less than 0, and then falls back to the resting value. Although Mueller does not interpret this action potential as being due to resistance changes, his data are clearly consistent with such an interpretation.⁹

Finally, we may mention some recent interesting experiments by Mueller *et al.* (1962) on *in vitro* bimolecular lipid films. If certain (as yet unidentified) substances are introduced into these films, the following behavior is described: When sufficient current is passed across this membrane, a threshold value of potential is reached from which the potential rises from its previous level to a new steady-state value, and remains at this value so long as current flows. These authors have shown that the basis of this potential rise is an increase in the membrane resistance. Note, however, that the potential does not fall back to its subthreshold level so long as current is flowing. Thus, the response of these films corresponds phenomenologically to the first half (rising phase) of the action potential in frog skin and toad bladder. (Compare also the behavior of *Valonia* (Blinks, 1936 a).)

C. *The Anoxia Experiments* Let us now consider some of the implications of the anoxia experiments which were previously described (part E of Results). The first point which deserves emphasis is the *independence* of the resting potential across the skin and the resistance response. We have seen that prolonged anoxia can bring the resting potential down to zero and approximately double the resting resistance; in this state the skin is not excitable. Upon the readmission of oxygen to the system, the resistance quickly decreases, with a simultaneous return of excitability, without any change in the resting potential. Without becoming involved in the various hypotheses put forth to explain the resting potential across the skin (Linderholm, 1952; Koefoed-Johnsen and Ussing, 1958), we can assert from our data that quite dramatic changes in the resistance of this system can occur without any noticeable alteration in its intrinsic EMF properties.

The second point of interest is that the resistance of the skin (the plasma membranes) is a function of metabolic activity. The rapidity with which the resistance changes when oxygen is readmitted to the previously anoxic system precludes any significant changes of the ionic composition within the cells and clearly demonstrates that the physical state of the cell membrane can be al-

⁹ A similar phenomenon occurs in the squid axon (Moore, 1959).

tered by metabolic events. Furthermore, and this brings us to the third point, it would appear that the changes in the membrane produced by metabolism are related to the changes that occur during electrical stimulation. Thus, in the normal oxygenated skin there occurs, at a threshold potential, a regenerative rise and fall of the resistance. If, however, the system has been previously brought into the high resistant state by anoxia, then there is no further regenerative increase to a higher state during current flow. A possible inference from this is that the same site in the plasma membrane is responsive to both metabolic and electrical stimulation.¹⁰

D. General Implications It is interesting to note an essential similarity in the nature of the action potentials in the skin and bladder to the more familiar action potentials of nerve and muscle. In Fig. 15 a is shown the well known equivalent circuit to describe the electrical events in nerve (Hodgkin and Huxley, 1952). (We have omitted for simplicity the parallel capacitance element and "leakage" resistance which are not essential for the occurrence of an action potential.) The essence of this circuit and the theory based on it is that the sodium and potassium EMF's are invariant (being the so called "Nernst" EMF's which are fixed by the concentrations of sodium and potassium on the two sides of the membrane), while the sodium and potassium resistances are time-variant. If we choose to draw an equivalent circuit for the skin and bladder, it will consist of a single branch with an EMF and resistance in series, where the EMF is invariant and the resistance is time-variant (Fig. 15 b). (In this figure the EMF and resistance are the transepithelial potential and resistance respectively.)

As has been pointed out previously (Finkelstein and Mauro, 1963), if the axonal membrane is a mosaic structure consisting of separate regions of exclusive permeability to either sodium or potassium, then the currents depicted in Fig. 15 a have physical significance; that is, there are local currents flowing within the membrane even in the resting state. Now compare this circuit with that for frog skin and toad bladder in Fig. 15 b. In this latter case, there is no current flow in the membrane unless it is introduced by means of external electrodes; this, however, can always be done, and is in fact the manner in which our experiments were conducted. Suppose that we pass a just subthreshold current across the preparation and *define* this state of the system as the resting state. Then, from a phenomenological point of view, the resting state in nerve (as depicted in Fig. 15 a) is basically the same as the resting state

¹⁰ Blinks (1949, 1955) has observed that the resistance across the plant cell *Halicystis* rises when O₂ is removed from the surrounding solution. As mentioned earlier, *Halicystis* also shows electrical excitability bearing a close resemblance to the response we have been describing. Blinks also suggests that O₂ and electrical stimulation may be acting through a common mechanism. We may also mention that Rehm *et al.* (1962) report that anoxia produces a rise in resistance of frog gastric mucosa

in the skin and bladder (Fig. 15 b); in both cases, there are time-variant resistances across which a resting current is flowing.

With the above remarks in mind, let us turn our attention back to Fig. 5 d. In this figure, we see that a small step of current of short duration superimposed on a constant subthreshold current is able to trigger a full blown action potential, and that this action potential occurs after the small step of current has been removed; remember, however, that the subthreshold current is still flowing during this time and is absolutely essential for a response to occur. In the same way, the action potential of nerve occurs while (local) currents are flowing through the membrane. In both cases, the action potentials result

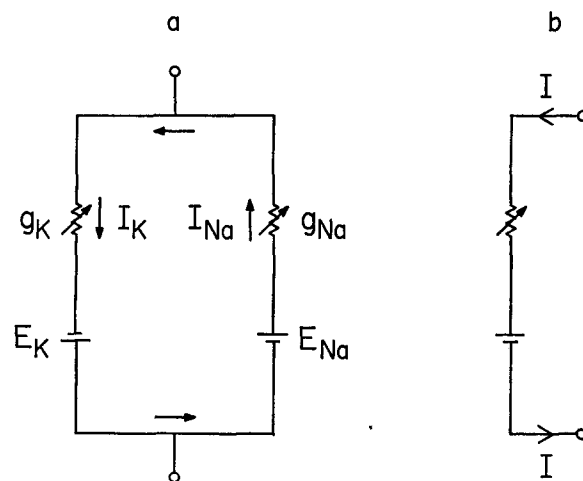

FIGURE 15. (a) Equivalent circuit for the axonal membrane. (b) Equivalent circuit for frog skin and toad bladder.

from resistance variations in the face of current flow. The local currents in the nerve would then be analogous to and performing the same role as the subthreshold current in the action potential of frog skin as seen in Fig. 5 d.

The material of this paper forms part of a thesis submitted to the Faculty of The Rockefeller Institute in partial fulfillment of the requirements for the degree of Doctor of Philosophy.

I wish to thank Dr. Alexander Mauro for his constant interest and advice throughout the course of this work.

Received for publication, June 26, 1963.

REFERENCES

- BLINKS, L. R., 1963 *a*, The effects of current flow on bioelectric potential. I. *Valonia*, *J. Gen. Physiol.*, **19**, 633.
 BLINKS, L. R., 1963 *b*, The effects of current flow on bioelectric potential. II. *Halicystis*, *J. Gen. Physiol.*, **19**, 867.
 BLINKS, L. R., 1949, The source of the bioelectric potentials in large plant cells, *Proc. Nat. Acad. Sc.*, **35**, 566.

- BLINKS, L. R., 1955, Some electrical properties of large plant cells, in *Electrochemistry in Biology and Medicine*, (T. S. Shedlovsky, editor), New York, John Wiley and Sons, Inc., 187.
- CHOI, J. K., 1963, The fine structure of the urinary bladder of the toad, *Bufo marinus*, *J. Cell Biol.*, **16**, 53.
- ENGBAER, L., and HOSHIKO, H., 1957, Electrical potential gradients through frog skin, *Acta Physiol. Scand.*, **39**, 348.
- FINKELSTEIN, A., 1961, Electrical excitability of isolated frog skin, *Nature*, **190**, 1119.
- FINKELSTEIN, A., and MAURO, A., 1963, Equivalent circuits as related to ionic systems, *Biophysic. J.*, **3**, 215.
- FRAZIER, H. S., 1962, The electrical potential profile of the isolated toad bladder, *J. Gen. Physiol.*, **45**, 515.
- FRAZIER, H. S., DEMPSEY, E. F., and LEAF, A., 1962, Movement of sodium across the mucosal surface of the isolated toad bladder and its modification by vasopressin, *J. Gen. Physiol.*, **45**, 529.
- HODGKIN, A. L., and HUXLEY, A. F., 1952, A quantitative description of membrane current and its application to conduction and excitation in nerve, *J. Physiol.*, **117**, 500.
- KOEFOD-JOHNSEN, V., and USSING, H. H., 1958, The nature of the frog skin potential, *Acta. Physiol. Scand.*, **42**, 298.
- LEAF, A., ANDERSON, J., AND PAGE, L. B., 1958, Active sodium transport by the isolated toad bladder, *J. Gen. Physiol.*, **41**, 657.
- LINDERHOLM, H., 1952, Active transport of ions through frog skin with special reference to the action of certain diuretics; a study of the relation between electrical properties, the flux of labelled ions, and respiration, *Acta Physiol. Scand.*, suppl. 97, 1.
- MOORE, J. W., 1959, Excitation of the squid axon membrane in isosmotic potassium chloride, *Nature*, **183**, 265.
- MUELLER, P., 1959, Prolonged action potentials from single nodes of Ranvier, *J. Gen. Physiol.*, **42**, 137.
- MUELLER, P., RUDIN, D. O., TIEN, H. T., and WESCOTT, W. C., 1962, Reconstitution of excitable cell membrane structure *in vitro*, *Circulation* **26**, 1167.
- PALADE, G. E. personal communication.
- PEACHEY, L. D., and RASMUSSEN, H., 1961, Structure of the toad's urinary bladder as related to its physiology, *J. Biophysic. and Biochem. Cytol.*, **10**, 529.
- REHM, W. S., CHANDLER, C., DAVIS, T. L., GOHMANN, E. J., BASHIRELAHI, A., and BAJANDAS, F. J., 1962, Effect of anoxia and re-oxygenation on potential difference, resistance and acid secretion of frog's gastric mucosa, *Biophysic. Soc. Abstr.* TD8.
- REUBEN, J. P., WERMAN, R., and GRUNDFEST, H., 1961, The ionic mechanisms of hyperpolarizing responses in lobster muscle fibers, *J. Gen. Physiol.*, **45**, 243.
- SCHEER, B. T., and MUMBACH, M. W., 1960, The locus of the electromotive force in frog skin, *J. Cell and Comp. Physiol.*, **55**, 259.
- TASAKI, I., 1959, Demonstration of two stable states of the nerve membrane in potassium-rich medium, *J. Physiol.*, **148**, 306.
- USSING, H. H., 1948, The use of tracers in the study of active ion transport across animal membranes, *Cold Spring Harbor Symp. Quant. Biol.*, **13**, 193.