

Lawrence Berkeley National Laboratory

Lawrence Berkeley National Laboratory

Title

ELECTROCHEMISTRY OF EXCITED MOLECULES: PHOTO-ELECTROCHEMICAL REACTIONS OF CHLOROPHYLLS.

I

Permalink

<https://escholarship.org/uc/item/2nq0v839>

Authors

Tributsch, Helmut
Calvin, Melvin.

Publication Date

2008-05-21

Submitted to Photochemistry
and Photobiology

RECEIVED
LAWRENCE
RADIATION LABORATORY

UCRL-20228
Preprint

C.2

JAN 27 1971

LIBRARY AND
DOCUMENTS SECTION

ELECTROCHEMISTRY OF EXCITED MOLECULES:
PHOTO-ELECTROCHEMICAL REACTIONS OF
CHLOROPHYLLS. I

Helmut Tributsch and Melvin Calvin

December 1970

AEC Contract No. W-7405-eng-48

TWO-WEEK LOAN COPY

*This is a Library Circulating Copy
which may be borrowed for two weeks.
For a personal retention copy, call
Tech. Info. Division, Ext. 5545*

48
LAWRENCE RADIATION LABORATORY
UNIVERSITY of CALIFORNIA BERKELEY

UCRL-20228
C.2

ELECTROCHEMISTRY OF EXCITED MOLECULES: PHOTO-ELECTROCHEMICAL REACTIONS
OF CHLOROPHYLLS. I

(in part, presented at the III IUPAC-Symposium on Photochemistry,
St. Moritz, Switzerland, 1970)

HELMUT TRIBUTSCH and MELVIN CALVIN

Laboratory of Chemical Biodynamics, Lawrence Radiation Laboratory, and
Department of Chemistry, University of California, Berkeley, California
94720, U.S.A.

Abstract--Semiconductors with a sufficiently large energy gap,
in contact with an electrolyte, can be used as electrodes for the
study of electrochemical reactions of excited molecules.

The behavior of excited chlorophyll molecules at single crystal
ZnO-electrodes has been investigated. These molecules inject
electrons from excited levels into the conduction band of the
electrode, thus giving rise to an anodic photocurrent. The
influence of various agents on this electron transfer has been
studied. In the presence of suitable electron donors (e.g.,
hydroquinone, phenylhydrazine) in the electrolyte chlorophyll
molecules, absorbing quanta, mediate the pumping of electrons
from levels of the reducing agents into the conduction band of
the semiconductor-electron acceptor. The electron capture by
the semiconductor electrode is irreversible, when an adequate
electrochemical gradient is provided in the electrode surface.
An experimental technique for the study of the kinetics of
photoelectrochemical reactions of chlorophyll molecules is

introduced and a theoretical approach for its calculation is given. Some properties of excited chlorophyll at semiconductor electrodes (unidirectional electron transfer, highly efficient charge separation, chlorophyll as electron pump and able to convert electronic excitation into electric energy) show similarity to the behavior of chlorophyll in photosynthetic reaction centers.

INTRODUCTION

One of the authors (HT) and H. Gerischer recently proposed the use of semiconductor electrodes to study photoelectrochemical reactions of excited molecules [1].

It has been found that, depending on the relative position of energy bands in the semiconductor and the energy levels in the molecule, excited molecules are able either to inject an electron into the conduction band or to accept an electron from the valence band of the semiconductor-electrode. The latter process is equivalent to the injection of a hole into the valence band. The two possibilities are shown in Fig. 1 where the energy schemes of two semiconductors with different work functions (ionization energy) are depicted beside the potential model of an excited molecule. Both electron exchange mechanisms have been observed with various p- and n-conducting semiconductor electrodes [1-5].

At a semiconductor electrode, which is placed in contact with an electrolyte, the injected electrons or holes can be measured directly as anodic or cathodic photocurrents, which spectrally coincide with the absorption spectrum of the injecting adsorbed dye.

An essential prerequisite for the appearance of unidirectional electron transfer between excited molecules and solid state electrodes appears to be the existence of an energy gap, which is sufficiently wide, so that energy transfer reactions to the electrode are suppressed and electron exchange is possible with only one of the two levels of the excited molecules [1]. At metals, which don't have an energy gap as do semiconductors, energy transfer reactions and electron exchange with both levels of the excited molecules would, essentially, lead to a quenching of the excited molecule. The photoeffects, measured primarily as photopotentials, that have been reported for metal electrodes [6,7], dipped into dye solutions or coated with dye films, could be produced by photochemical reaction products of the dye, which can change the redox potential of the solution, or by photochemical processes in the dye layers.

In contrast, with the help of semiconductor electrodes, at a constant electrode potential, a photocurrent can be measured which is the result of a direct electron exchange between one level of the excited species and an appropriate energy band in the electrode. Consequently, a direct correlation between these photocurrents and the reaction behavior of the excited molecules can be expected.

It has been found that reactions of the injecting excited molecule with other reaction partners in the electrolyte result in a change of the photocurrent to the semiconductor electrode (Fig. 1). Photocurrents could thus be used to investigate photochemical reactions. Moreover, some interesting differences between homogeneous and heterogeneous

photochemical reactions are to be expected because of the electron exchange with a solid state electrode.

It seemed to be especially interesting to investigate the photoelectrochemical properties of chlorophyll molecules. They play an important part in energy conversion and electron transfer in photosynthesis and some of their essential properties in the chloroplast are difficult to understand on the basis of photochemical experiments in homogeneous solutions.

These investigations represent an attempt to use the electrochemical method in this way.

MATERIALS AND METHODS

The experiments have been performed in an electrochemical cell, consisting of a semiconductor electrode, a platinum counterelectrode and a saturated calomel-reference electrode (Beckman), dipping into an electrolyte.

As semiconductor electrodes, single crystals of ZnO have been used. Several experiments also have been performed with single crystal-CdS and p-type GaP-electrodes. Experiments with two kinds of ZnO-single crystals were made. Needle crystals of 1-2 cm length and 2 to 4 mm² cross-section were kindly supplied by Prof. G. Heiland, Technische Hochschule, Aachen, Germany. Plate crystals of 1 mm thickness and up to 1 cm² area were obtained from the 3M Company, St. Paul, Minnesota. All ZnO crystals used were not doped with any additional elements, but contained an inevitable excess of Zn that makes the crystal n-conducting.

To get ohmic contacts indium was diffused into the crystal surfaces for 1 hour at 700°C. A copper wire then was contacted to the crystal

with the help of a conducting silver-emulsion. The crystal was isolated and fitted into a teflon-support with the help of an epoxy glue. The electrochemical investigations were all made at the polar $\langle 0001 \rangle$ and $\langle 000\bar{1} \rangle$ surfaces. Differences in the behavior of the two crystal faces have not been observed.

The CdS-crystals were obtained from Semi-elements, Inc. Before contacting they were pretreated by electrolytic reduction.

The electrochemical cell and the experimental set-up are depicted in Fig. 2. The semiconductor electrode in the electrochemical glass cell could be illuminated through a quartz window.

In the electrochemical measurements the photocurrent passed through the semiconductor-electrolyte interface, the electrolyte and the Pt-counterelectrode. The potential of the semiconductor electrode was measured against the reference electrode. The electrolyte could be flushed with nitrogen or oxygen and be kept at constant temperature with the help of a thermostat. The experimental cell and all electrical cables were shielded against electromagnetic perturbations.

The potential, which was applied to the electrode was regulated by a fast rise Wenking Potentiostat (1 μ sec) (Brinkmann, Inc.).

As light source, a high pressure 900 W Xenon lamp (Ostrom XBO 900) and a Xenon flash lamp (20 μ sec) were used in conjunction with a Bausch and Lomb grating monochromator and filters (Corning).

In the measurements light was chopped and split into two beams. One illuminated the crystal electrode, the other the thermocouple (Reader, 20 msec rise time). The chopper frequency was regulated electronically (11.3 cps). The lock-in amplifiers used were models of

Brewer and PAR. The electrode photocurrents were corrected to the same light intensity, which was measured by the thermocouple. The electrode dark currents were measured for control purposes with a Keithley picoammeter.

Before every experiment the semiconductor surface was ground with sandpapers and rinsed with electrolyte solution. Etching treatment was only applied in special cases and was generally avoided because of a pH-dependent double layer which is formed at the ZnO surface and which equilibrates only very slowly with an aqueous electrolyte of neutral pH [8]. Eleven crystals (7 needle shaped and 4 plate crystals) have been used up in the experiments. A new surface could be produced more than 300 times.

For the investigation of electrochemical reactions of the excited chlorophyll molecules two techniques have been used. In the one, chlorophyll was simply added to the electrolyte. In this case an electrolyte had to be chosen in which chlorophyll could be dissolved. Because of the low photocurrents a high ion concentration in the solvent was not needed. In the second technique one or two drops (1 μ l) of a defined chlorophyll solution (10^{-6} to 5×10^{-5} M in benzene) were deposited on the semiconductor with the help of a micropipette. After evaporation of the solvent the semiconductor electrode was placed in contact with an aqueous electrolyte, which doesn't dissolve the chlorophyll (a, b, or bacteriochlorophyll).

The surface areas of the crystal electrodes measured between 2 and 20 mm^2 . In a typical experiment one μ l of a 3×10^{-5} M chlorophyll a solution (benzene) corresponding to 3×10^{-11} Mol or 1.8×10^{13} chlorophyll

molecules were deposited on a 10 mm^2 semiconductor surface. Considering a reasonable roughness factor of 4 for the electrode surface, 220 \AA^2 surface area per Chl a molecule is available on the average (the mean area need for a chlorophyll a molecule in a monolayer is 75 to 125 \AA) [9a]. Only on the larger crystals did the whole benzene-chlorophyll drop evaporate within the semiconductor surface area. With the small crystals corrections had to be made. With careful deposition of the benzene drop the chlorophyll-sensitized photocurrents at the electrode were quantitatively reproducible within 10%.

Care was taken that less than a monolayer, on the average, was present at the semiconductor electrode in the kinetic measurements.

In all experiments the illumination was monochromatic.

Mesochlorine e_6 and mesochlorine monomethyl ester was kindly provided by Dr. Koller, Munich. Chlorophyll a, b and bacteriochlorophyll were isolated in a procedure according to Sauer, Smith and Schultz [10]. They were checked spectroscopically for their purity.

The experiments have been performed with unbuffered electrolyte solutions of neutral pH. If necessary, the pH was adjusted by addition of small quantities of acid or base and periodically checked during the experiment. Buffering of the electrolyte was avoided in order to prevent adsorption and possible photochemical reactions of the buffer agents. For quantum measurements a calibrated thermocouple (Reader) was used. The temperature in the electrochemical cell was kept at 20°C .

RESULTS

General properties of excited chlorophyll molecules at semiconductor electrodes:

An initial aim of the investigations has been to find suitable

semiconductor electrodes and experimental conditions for the investigation of molecules of the chlorophyll group (chlorins, chlorophyllides, chlorophyll a, b, and bacteriochlorophyll).

Mesochlorine e_6 or chlorine e_6 monomethyl ester (chlorophyll a - Mg - phytol + cleavage 6c-6d) can easily be dissolved in water. When added to an aqueous electrolyte (1 N KCl) which is in contact with a ZnO semiconductor electrode (0.5 volt positive voltage) they produce an anodic electrode photocurrent.

In Fig. 3 the spectral dependence of the photocurrent, which is produced by chlorin e_6 monomethyl ester at a ZnO electrode is shown. It can be seen that electron transitions within electronic levels of the semiconductor itself already produce anodic photocurrents [11]. They decrease towards longer wavelengths as electron transitions become more improbable because of the forbidden energy gap (3.2 eV). The sharpness of this "band edge" is somewhat dependent on the purity and the crystalline state of the semiconductor crystal. The photocurrent injected by excited chlorine e_6 monomethyl ester is superimposed on the background photocurrent of the semiconductor electrodes. In order to obtain an electron injection spectrum for the dye, the background has to be subtracted. This is easily possible in the spectral range beyond 600 nm but increasingly difficult at shorter wavelengths, where the background photocurrents increase. The photocurrent which is produced by the transfer of electrons from the excited molecule into the conduction band of ZnO reaches a limiting value at very low positive electrode potentials [2,3]. When the external voltage is disconnected the photocurrents decrease somewhat; however, they still flow in the same

direction (Fig. 3). In this arrangement, the electrochemical system is operating as photoelement and photochemical energy is converted into electric energy.*

Also at CdS-single crystals anodic photocurrents could be injected by dyes. This is shown in Fig. 4 for mesochlorine e_6 + phenylhydrazine in an aqueous electrolyte. However, the band edge of this semiconductor appears at unfavorably long wavelengths and detailed measurements have not been continued with this system.

An attempt was made to find chlorophyll-sensitized hole injection into GaP electrodes, at which fluorescein dyes, cyanine dyes, and tri-phenylmethan dyes were found to be active [5]. These experiments, however, have not been successful. Consequently, only experiments with ZnO-electrodes have been continued.

Chlorophyllides, chlorophyll a, b, and bacteriochlorophyll are not soluble in aqueous electrolytes. For this reason alcohol (+ salt) and mixtures with benzene, acetone and mineral oil have been used. Because of the low photocurrents, the electrolytic conduction in these organic solvents was adequate. Electron injection effects at the ZnO-electrode were observed with the chlorophyll molecules dissolved in these solvents. Compared with the chlorine e_6 effects, however, the observed photocurrents were rather low with chlorophyll a, b, and bacteriochlorophyll, probably because of a weak adsorption at the electrode surface.

Moreover, we were not so much interested in studying the photochemistry of chlorophyll in organic solvents since, to have comparable

*The principle of energy conversion is discussed elsewhere in more detail [12].

conditions to those in photosynthesis, an aqueous medium is more desirable. For this reason the technique of evaporating a drop of benzene solution of chlorophyll on the electrode surface was adopted. An aqueous electrolyte in contact with this electrode prevented the dissolution of the adsorbed chlorophyll molecules. With this preparation, satisfactory photoeffects were found. As the amount of deposited molecules was known and usually an average coverage of less than a monolayer was prepared, some interesting advantages for kinetic experiments were obtained: Information about the consumption of chlorophyll molecules was to be expected and an inhibition of the semiconductor surface by reaction products of the molecules could be prevented.

Fig. 5a shows the course of the photocurrents on illumination in the red band (670 nm) of Chl a, when 1.55×10^{-12} Mol of chlorophyll a were deposited on a 4 mm^2 electrode. Fig. 5b shows the analogous photocurrent course for the 20-fold amount of chlorophyll a.

When the illumination is interrupted during the decay of the photocurrents following illumination, the photocurrent continues its decay from the point of interruption upon reillumination (Fig. 6), so that the unperturbed decline function can be constructed from partial functions (dotted line).

When the decay curves of the photocurrent are depicted in a logarithmic scale over a longer time (Fig. 7) it can be seen that they are composed of two portions mainly: a fast decay and a slower, exponential decay. As the excited chlorophyll molecules are producing an anodic electron-photocurrent at the semiconductor electrode, it is reasonable

to assume that the decay of the photocurrents results from the photo-electrochemical oxidation of the molecules.

Further, there seems to be an exponential decay process, not only after longer illumination, but also at the very beginning of the illumination (Fig. 8). The superposition of the two extreme exponentials is not sufficient, however, to describe the experimental curve in the transition area. Here a somewhat higher photocurrent was generally observed.

The qualitative decay process of the chlorophyll photocurrents was reproducible at both needle-shaped crystals and plate crystals. Also, qualitative reproducibility was found with various conduction salts in the electrolyte and different electrode pretreatments (Figs. 7 and 8). Quantitatively, however, slight deviations were observed. They may arise from small differences in the illumination conditions and in the distribution of the deposited dye at different electrodes. A salt effect was found: With 1 N KCl solution the magnitude of the photocurrents was about two times higher than with sat. (~ 0.3 M) K_2SO_4 solution. The nature of this effect is not clear at the present time. With some exceptions, the experiments which are discussed here have been performed in aqueous 1 N KCl solution.

A reaction of excited chlorophyll with an agent which is added to the electrolyte, will affect the decline characteristic of the photocurrents. This is shown in Fig. 9 with hydroquinone. This reducing agent can suppress the consumption of chlorophyll a at the semiconductor electrode. The assumption of a regeneration of chlorophyll a alone, however, cannot explain why the photocurrent can rise over the initial value, which is quantum limited, when all molecules are unconsumed. In

Fig. 10 some more examples are shown that demonstrate how agents, which are added to the electrolyte and don't absorb the incident 670 nm light can increase the chlorophyll-sensitized electron injection. In these experiments the onset of the enhancement effect after the addition of the reacting agents is determined by the diffusion of the added agents to the electrode surface.

In the presence of hydroquinone, which stabilizes the photocurrents best among the reducing agents used, the spectral dependence of the electron injection by chlorophyll can conveniently be measured. Figs. 11 and 12 show the spectral dependence of the photocurrents, which are produced by chlorophyll a and b respectively, after subtraction of the electrode-background currents. The dashed lines indicate the region where the photocurrent values are somewhat more uncertain. As compared with the absorption spectra in benzene the bands are shifted towards longer wavelengths by about 10 nm. A red shift was also observed with bacteriochlorophyll, which injects photocurrents into ZnO-electrodes in the same way. The electron injection spectrum for chlorophyll a, however, is fairly comparable to its absorption spectrum in pyridine or the absorption spectrum of a monolayer on water [9b]. The red shift, observed in the electron injection spectrum is probably due to the polar environment at the electrode/water interface.

The results presented demonstrate that with the photoelectrochemical technique it is possible to measure absorption spectra of adsorbed molecules. In favorable cases, less than 10^{-12} Mol of a dye, adsorbed at a semiconductor surface, are sufficient for the measurement. In contrast to ordinary spectroscopic measurements, in which the relative

intensity of two light beams is detected with the photoelectrochemical technique an absolute measurement of injected electrons is made. Its sensitivity may thus be compared with that of fluorescence measurements.

Fig. 13a depicts the photocurrent-voltage characteristic for chlorophyll a and hydroquinone, as measured with the lock-in technique at 670 nm. In Fig. 13b a graph of the potential dependence of the dark current for the same plate crystal is shown. The anodic dark current was somewhat different from crystal to crystal and with the lock-in measuring technique it is automatically separated from the photocurrents.

Kinetics of photoelectrochemical reactions:

As shown in Figs. 9 and 10, the interaction of chlorophyll with certain agents, dissolved in the electrolyte, results in a change of the injected photocurrents. In Fig. 14 this is demonstrated for various agents, which have been added to the electrolyte before the onset of the illumination. Compared with the decay function of chlorophyll a alone, reducing agents can remarkably increase the initial photocurrents (Fig. 14). On the other hand, these agents don't react with the semiconductor electrode in the absence of excited chlorophyll a. Their highest occupied electronic levels lie energetically in the range of the forbidden energy gap and cannot exchange electrons with the energy bands of the electrode.

In Fig. 14 it can be seen that H_2O_2 is among the agents which increase the electron injection by chlorophyll a. In the reaction with chlorophyll a it apparently behaves as a reducing agent. Quinone was found to decrease the initial chlorophyll a photocurrents; however, it

had to be present in the electrolyte as a saturated solution. While quinone decreases the initial photocurrent, it seems not to decrease the overall charge gain from excited chlorophyll.

In Fig. 15 the initial decay characteristic of photocurrents, sensitized by a small, defined amount of chlorophyll a, is depicted when various concentrations of hydroquinone are present in the electrolyte. Fig. 16 shows the result of the same experiment with phenylhydrazine.

The enhancement effect of phenylhydrazine appears only at higher concentrations when compared with that of hydroquinone. The relative increase of the initial effect, however, is much more pronounced with phenylhydrazine than with hydroquinone. Nevertheless, the photocurrent decay is much faster, even when calculated for the same electronic flow.

It is clear that the decay functions of the photocurrents reflect the result of the individual reactions of photoexcited chlorophyll a with these agents.

The behavior of chlorophyll b is similar to that of chlorophyll a. Hydroquinone also increases the photocurrents which are produced by excited bacteriochlorophyll.

Consumption and regeneration of chlorophyll a:

According to the Faraday law with the assumption of one equivalent of charge passed for each chlorophyll molecule consumed, the faster decay process of the photocurrents (Fig. 7) corresponds to only about 5% of the deposited chlorophyll a being consumed at the electrode. When hydroquinone is present in the electrolyte, many more electrons

are injected into the conduction band of the semiconductor as a result of light absorption by chlorophyll a than the total number of chlorophyll a molecules that are absorbed at the semiconductor surface. This can be seen in Fig. 17, where the chlorophyll a photocurrents are depicted in the presence and absence of hydroquinone in the electrolyte and compared with the charge that would theoretically be available from oxidation of excited chlorophyll a. According to the time course of the photocurrents in the presence of hydroquinone (Fig. 17), after 15 hr Chl a should have been consumed 20 times over (lower of the two experimental curves). The decay function is dependent upon the hydroquinone concentration, and higher turnovers have been observed. Hydroquinone thus reacts with excited chlorophyll in such a way that the electron transfer to the semiconductor is increased (initial photocurrent increases) and chlorophyll a tends to remain unchanged in the reaction. As a consequence, hydroquinone has to become oxidized. Similar observations have been made with another reducing agent (phenylhydrazine). The ultimate consumption of chlorophyll, however, occurred faster with this than in the presence of hydroquinone.

The small portion of chlorophyll molecules ($\sim 5\%$) with a high electron transfer probability, which contribute to the primary faster decay of the photocurrents, also effectively contribute to the enhanced electron injection in the presence of a reducing agent. When a reducing agent is added after the initial fast decline of the photocurrent, i.e., when only a few percent of the most efficiently situated molecules are already consumed, the observed absolute increase of the

photocurrents is much smaller than when the reducing agent is present at the beginning of the illumination.

Oxygen had only a small effect on the fast photocurrent decline. It appeared to accelerate it somewhat. An oxygen effect was observed primarily on the long-time experiments, and it seems to be to a large extent irreversible. Obviously, oxygen destroys adsorbed chlorophyll by photooxidation.

Time response of photocurrents:

In the search for the time constants for the electron injection effects it was recognized that the decay times of the injected photocurrents, after light has been turned off, were dependent on an RC-value of the electrode system. By making the semiconductor electrode continuously smaller, it was possible to obtain a photocurrent response that coincided with the applied 20 μ sec flash. From this result it can be concluded that the time constant for electron injection from chlorophyll a is smaller than 2×10^{-5} sec and that the discharge of the electrode is determined by an RC constant.

Quantum efficiency:

From the optical density of the chlorophyll a solution, which was deposited on the semiconductor electrode and from the area in which the defined benzene drop evaporated the absorption coefficient of the thin chlorophyll layer can be obtained. The quantum efficiency for electron injection by excited chlorophyll a is calculated, with the help of the Faraday law, separately for the fast decay section (~ 3 min; $\sim 5\%$ of the chlorophyll molecules) and the subsequent slow one. The splitting of the decay into only two sections is arbitrary.

For those chlorophyll a molecules that contribute to the faster primary decay of the photocurrents, the average quantum yield for electron transfer from excited levels into the conduction band of the semiconductor electrode was found to be approximately 2.5×10^{-2} electrons/quantum.

The main portion of chlorophyll molecules showed a lower quantum efficiency for electron transfer of approximately 4×10^{-4} . In the transition range an intermediate value obtains.

In the presence of reducing agents the quantum efficiency increases considerably. However, it is more difficult to distinguish separate electron transfer rates. The observation that the portion of molecules which contribute to the fast decay is also active in the high electron donor-stimulated increase of the photocurrent at the beginning of illumination suggests an analogous participation of efficient electron injecting molecules in the photocurrent production in the presence of reducing agents. Then, for the more effective portion of chlorophyll molecules in the presence of hydroquinone, the quantum efficiency increases towards 5×10^{-2} and with phenylhydrazine towards 1.25×10^{-1} .

DISCUSSION

It has been found that excited chlorophyll molecules at a suitable electrode (ZnO) give rise to an anodic photocurrent. The experimental results are consistent with the assumption that in a primary step electrons from excited chlorophyll levels are transferred into the conduction band of the semiconductor (probably by tunneling).

The electron transfer mechanism is (most evidently) supported by the observation that chlorophyll is consumed at the electrode surface and that reducing agents, which react with excited chlorophyll, can increase electron transfer and prevent chlorophyll consumption. An anodic voltage of as little as 0.5 V is sufficient to transfer the injected electrons irreversibly away from the semiconductor surface. When the applied voltage is decreased or when no external voltage is applied, a portion of the injected electrons leaves the semiconductor electrode again and is lost in a reverse reaction with Chl^+ or other oxidizing agents. Two mechanisms by which reducing agents can stimulate photoelectron transfer and regenerate the injecting molecules have been discussed in a previous paper [2]. They are also applicable to photoelectrochemical reactions of chlorophyll. The simplest explanation for the action of reducing agents like hydroquinone or phenylhydrazine on the electron transfer reaction from the excited chlorophyll molecule into the semiconductor conduction band is that these agents reduce excited chlorophyll molecules at the semiconductor surface as they do in homogeneous solution [13,14]. The resulting reduced chlorophyll molecule, an anion radical, will have an increased capacity for donation of electrons to the electrode.

According to this mechanism the same electron injecting chlorophyll intermediate would appear with different electron donors and consequently similar qualitative kinetic behavior of the chlorophyll-induced electron photocurrent might be expected in the presence of various agents. To account for the variety in the kinetics of the photocurrent decay (Fig. 14) a more complex reaction mechanism has to be assumed. The

reducing molecules could form weak charge transfer complexes with a groundstate absorbed chlorophyll, or with the excited absorbed chlorophyll molecules. In a complex formed by the semiconductor, the adsorbed chlorophyll molecule, and the reducing molecule, electron transfer reactions from the excited level of chlorophyll to the semiconductor and from the reducing agent into the ground level of the chlorophyll molecule may occur more or less simultaneously and support each other.

Both mechanisms could explain the enhancement effect of reducing agents on the electron transfer reaction, as well as the regeneration of the chlorophyll molecules.

In Fig. 18 the main reactions of excited chlorophyll at a ZnO-semiconductor electrode are depicted.

When in a first step an electron is transferred from an excited chlorophyll molecule into the conduction band of the semiconductor [18a], a reverse reaction of the injected electron with the oxidized chlorophyll can be prevented by an electrochemical gradient in the semiconductor surface, by which the electron is led away from the interface. Until the oxidized chlorophyll molecule is stabilized by a suitable reaction, it constitutes a strong oxidizing agent, able to oxidize compounds with fairly high oxidation potential.

In the presence of a reducing agent which reacts with excited chlorophyll molecules a primary reduction mechanism and a charge transfer mechanism [18 b and c resp.] can explain the enhancement of electron injection and the regeneration of chlorophyll.

An attempt at a quantitative analysis based on any of these models only confirms the already evident qualitative result, that the chlorophyll

molecules on the ZnO surface exist in a continuous variety of sites with at least one preferred adsorption position. Each of these differently adsorbed molecules may be expected to have a different efficiency for electron transfer into the semiconductor band as well as differing reaction properties with the reducing agents, and consequently differing rates of irreversible consumption.

The nature of the variety of adsorption sites on the surface of single crystal ZnO-electrodes, prepared by grinding, is clearly visible in the scanning-electron-microscope pictures of Fig. 19.

At the beginning of illumination those chlorophyll molecules with a high quantum efficiency for electron transfer are the principle contributors to the photocurrent. Energy transfer reactions between chlorophyll molecules may contribute to the probability that excitation energy reaches favorably situated chlorophyll molecules for electron injection. The photocurrents will then continuously decrease as chlorophyll molecules are consumed and less efficient electron transfer reactions determine the photocurrent.

These experiments do not yet permit a decision as to whether the singlet or the triplet state of chlorophyll or both are involved in the electron transfer to the semiconductors. When the ionization energy for chlorophyll a (4.8 eV)[15] and the work function of ZnO (6.3 eV) [16] (band gap 3.2 eV) are plotted in the same energy scale, it is apparent that the triplet level of chlorophyll a is situated about 0.3 eV below the edge of the conduction band of ZnO, so that activation energy is needed for electron transfer from this level. These values, however, can be somewhat influenced by the special conditions at the electrode.

The time constant of the chlorophyll photocurrents ($\tau < 2 \times 10^{-5}$ sec) and the observation that oxygen and paramagnetic ions (Co^{++} , Ni^{++}) don't decrease photocurrents very much, indicate that if a metastable chlorophyll state is involved in the electron transfer, its natural lifetime is already shortened for the adsorbed molecule.

At the present time there is no indication that the assumption, that the singlet state is active in the electron transfer reaction, is untenable. A charge transfer mechanism could then account for the action of reducing agents on the electron transfer rate and the regeneration of chlorophyll. A participation of the triplet in the electron transfer reaction, especially with the aid of reducing agents, cannot be excluded; in any case, triplet state chlorophyll can undergo side reactions which can lead to non-injecting reaction products.

CONCLUSION

With the use of a suitable single crystal semiconductor as acceptor for electrons from excited chlorophyll molecules the following observations could be made:

Excited chlorophyll molecules are able to produce an electron flow into the conduction band of a semiconductor electrode. The unidirectionality of the electron flow is guaranteed by an electrochemical gradient in the surface of the semiconductor electron acceptor. It prevents a reverse reaction of the accepted electron with the oxidized chlorophyll as it would occur in homogeneous solution (e.g., in a reaction between excited chlorophyll a and quinone). [17].

In the presence of reducing agents (hydroquinone, phenylhydrazine) electron transfer from excited chlorophyll molecules to the semiconductor

is increased and chlorophyll molecules can be regenerated. From this result it can be concluded that a cooperation of a suitable electron acceptor (semiconductor crystal) and a donor increases the efficiency of charge separation at excited chlorophyll molecules. Chlorophyll molecules then, under these conditions, are acting as photon-powered electron pumps for electrons from electronic levels of a donor to electronic levels of an acceptor (here a semiconductor). When no external potential is applied to the semiconductor electrode and a suitable electrochemical gradient for electrons still exists in the semiconductor-electrolyte interface (as in the case of a ZnO electrode [11]), unidirectional electron flow is maintained albeit with decreased efficiency, and photochemical energy of excited chlorophyll is converted into electrical energy and thus is also available for transformation into chemical energy. The experiments have shown that chlorophyll sensitized unidirectional electron transfer, i.e., charge separation with fairly high quantum efficiency and energy conversion can be generated with the help of an electron acceptor that provides an electrochemical gradient for electrons, which are accepted from excited chlorophylls. Moreover, they have demonstrated that reducing agents like hydroquinone or ascorbate, which are also oxidized by photosystem II of chloroplasts [18,19] are readily oxidized in a reaction with excited chlorophyll a at the semiconductor electrode.

The observation that excited chlorophyll molecules at a suitable semiconductor electrode show some properties which also characterize the behavior of chlorophyll sensitized reactions in photosynthetic reaction centers suggest an investigation of the possibility that a

suitable organic acceptor complex in these is able to provide the physical-chemical properties which are essential for the occurrence of photoelectrochemical reaction. A theoretical study of this question is in preparation.

Acknowledgements

The authors want to thank the "Deutsche Forschungsgemeinschaft" which made this work possible by granting a fellowship to one of us (HT). They also wish to thank Dr. Thomas Hayes for the electron microscope pictures, Dr. Melvin Klein for helpful discussions, and Dr. John Mowbray for correcting the manuscript. The work was supported, in part, by the U. S. Atomic Energy Commission.

REFERENCES

1. H. Tributsch and H. Gerischer, Ber. Bunsenges. Phys. Chem. 73, 851 (1969) (English).
2. H. Tributsch and H. Gerischer, Ber. Bunsenges. Phys. Chem. 73, 251 (1969).
3. H. Tributsch, Ber. Bunsenges. Phys. Chem. 73, 582 (1969).
4. K. Hauffe, H. J. Danzmann, H. Pusch, J. Ranga, and H. Volz, J. electrochem. Soc. 8, 993 (1970).
5. R. Memming and H. Tributsch, J. Phys. Chem., in press.
6. V. B. Evstigneev, in Elementary Photoprocesses in Molecules (Edited by Bertol'd S. Neporent), Transl. from Russian: Consultants Bureau, New York (1968).
7. W. H. Simpson, R. A. Freeman and P. J. Reucroft, Photochem. Photobiol. 11, 319 (1970).

8. J. F. Dewald, in The Surface Chemistry of Metals and Semiconductors (Edited by H. C. Gatos), p. 205, J. Wiley & Sons, Inc., New York (1969) and ref.
9. Bacon Ke, in The Chlorophylls (Edited by Leo P. Vernon and Gilbert R. Seely), a) p. 256, b) p. 263, Academic Press, New York and London (1966).
10. Kenneth Sauer, John R. Lindsay Smith and Alfred J. Schultz, J. Am. Chem. Soc. 88, 2681 (1966).
11. H. Gerischer, J. electrochem. Soc. 112, 1174 (1966).
12. H. Tributsch and H. Gerischer, in preparation.
13. Eiji Fujimori and Marion Towles, Photochem. Photobiol. 5, 877 (1966).
14. A. A. Krasnovskii and G. P. Brin, Dokl. Akad. Nauk. SSSR 89, 527 (1952).
15. F. I. Viselov and M. E. Akopyan, in Elementary Processes in Molecules (Edited by Bertol'd S. Neporent), Transl. from Russian: Consultants Bureau, New York (1968).
16. F. I. Viselov, Dokl. Akad. Nauk SSSR 132, 632 (1960); 141, 1068 (1961).
17. K. Seifert and H. T. Witt, in Progress in Photosynthetic Research (Edited by H. Metzner), Vol. II, p. 750, Tübingen (1969).
18. A. Trebst, H. Eck, and S. Wagner, in Photosynthetic Mechanisms of Green Plants (Edited by B. Kok and A. T. Jagendorf), pp. 174-194, Nat. Acad. Sci.-Nat. Res. Comm. Publ. 1145 (1963).
19. Y. Chiba and S. Okoyama, Plant Cell Physiol. 3, 379 (1962).

FIGURE LEGENDS

Fig. 1. Energy potential scheme of a molecule at a semiconductor-electrolyte interface: a) electron injection at semiconductor with high ionization energy; b) hole injection at semiconductor with low ionization energy. D^* : excited dye molecule; VB: valence band; CB: conduction band; E_F : Fermi level; R: electronic level of reducing agent; O: electronic level of oxidizing agent.

Fig. 2. Scheme of electrochemical cell and experimental set-up: 1) semiconductor electrode; 2) Teflon support; 3) electrolyte; 4) counter electrode; 5) reference electrode; 6) heat exchanger. P: potentiostat; L: light source; Mon: monochromator; Ch: chopper; T: thermocouple; AD: analog computing units; Mot: motor; i_p = photocurrent.

Fig. 3. Spectral dependence of photocurrents at a ZnO-plate crystal. Electrode surface 12 mm^2 . 0: electrolyte: 1 N KCl in water; 1: $5 \times 10^{-5} \text{ M}$ chlorin e_6 monomethyl ester (Chl e_6 m); 2: $2 \times 10^{-4} \text{ M}$ Chl e_6 m; 3: $2 \times 10^{-4} \text{ M}$ Chl e_6 m + 1 M phenylhydrazine, electrode potential: 0.5 volt; 4: like 3, without external potential.

Fig. 4. Spectral dependence of photocurrents at a CdS-electrode. Anodic potential: 0.25 volt. ---o--- , aqueous electrolyte (1 N KCl); ---●--- , addition of $5 \times 10^{-4} \text{ M}$ mesochlorine e_6 + 1 M phenylhydrazine.

Fig. 5. Decay of chlorophyll a-sensitized photocurrents. Monochromatic illumination at 670 nm. Electrode surface: 4 mm^2 . 0: without chlorophyll a; 1: with chlorophyll a, A) $1.55 \times 10^{-12} \text{ M}$ chlorophyll a deposited on the electrode; B) $3.1 \times 10^{-11} \text{ M}$ deposited chlorophyll a.

Fig. 6. Effect of interruption of illumination on the decay of chlorophyll a-sensitized photocurrents.

Fig. 7. Longtime decay of chlorophyll-sensitized photocurrents.

—●—, chlorophyll b, aqueous 1 N KCl, electrolyte, $\lambda = 650$ nm;

—○—, chlorophyll a, aqueous 1 N KCl, electrolyte, $\lambda = 670$ nm;

—△—, chlorophyll a, aqueous saturated K_2SO_4 , electrolyte. Anodic potential: 0.5 volt, plate crystals.

Fig. 8. Initial decay of chlorophyll sensitized photocurrents:

—○—, chlorophyll a, sat. aqueous K_2SO_4 , needle crystal;

—△—, chlorophyll b, 1 N KCl, needle crystal;

—●—, chlorophyll a, 1 N KCl, plate crystal, after etching in 3 M KOH;

—▲—, chlorophyll a, 1 N KCl, needle crystal.

Fig. 9. Influence of hydroquinone on the decay of chlorophyll a photocurrent:

0: photocurrents in the absence of chlorophyll a; 1: photocurrents in the presence of chlorophyll a; 2: photocurrents after the addition of hydroquinone (4×10^{-2} M) (arrow).

Fig. 10. Influence of various agents on the decay of chlorophyll a-sensitized

photocurrents. Electrolyte: aqueous 1 N KCl. A: addition of Mn^{++} (4×10^{-2} M) and hydroxylamine (4×10^{-2} M); B: addition of ascorbic acid (4×10^{-2} M); C: addition of phenylhydrazine (4×10^{-2} M).

Fig. 11. Spectral dependence of chlorophyll a-sensitized photocurrents.

Electrolyte: aqueous 1 N KCl plus 4×10^{-2} M hydroquinone.

Fig. 12. Spectral dependence of chlorophyll b-sensitized photocurrents.

Electrolyte: aqueous 1 N KCl plus 4×10^{-2} M hydroquinone.

Fig. 13. Potential dependence of chlorophyll a-induced photocurrents (A) and of the dark current at a ZnO plate crystal (B).

Fig. 14. Comparison of the influence of various agents on the decay of chlorophyll a-sensitized photocurrents. Electrolyte: 1 N aqueous KCl solution. 0: in the absence of additional agents; 1: in the presence of phenylhydrazine (4×10^{-2} M); 2: in the presence of hydroquinone (4×10^{-2} M); 3: in the presence of hydroxylamine (4×10^{-2} M); 4: in the presence of hydrogen peroxide (5%); 5: in the presence of ascorbic acid (4×10^{-2} M); 6: benzoquinone (saturated).

Fig. 15. Influence of hydroquinone on the decay of chlorophyll a-sensitized photocurrents (numbers indicate molar concentration of hydroquinone).

Fig. 16. Influence of phenylhydrazine on the decay of chlorophyll a-sensitized photocurrents (numbers indicate molar concentration of phenylhydrazine).

Fig. 17. Decay of chlorophyll a-induced photocurrents in the absence (lower curves) and in the presence of hydroquinone. Q: charge, corresponding to amount of adsorbed chlorophyll. —, ———: different experiments.

Fig. 18. Energy potential schemes of photoelectrochemical reactions of a molecule at an electron-accepting semiconductor electrode (numbers indicate reaction steps; SC = semiconductor; Chl^* = excited chlorophyll molecule; R = reducing agent). a) primary step: electron transfer from excited dye to Sc. b) primary step: excited dye is reduced by reducing agent. c) charge transfer mechanism.

Fig. 19. Scanning electron microscope picture of ZnO-single crystal electrode surface $\langle 000T \rangle$, prepared by grinding. Fig. b is a magnification of the area shown by dashed line in Fig. a.

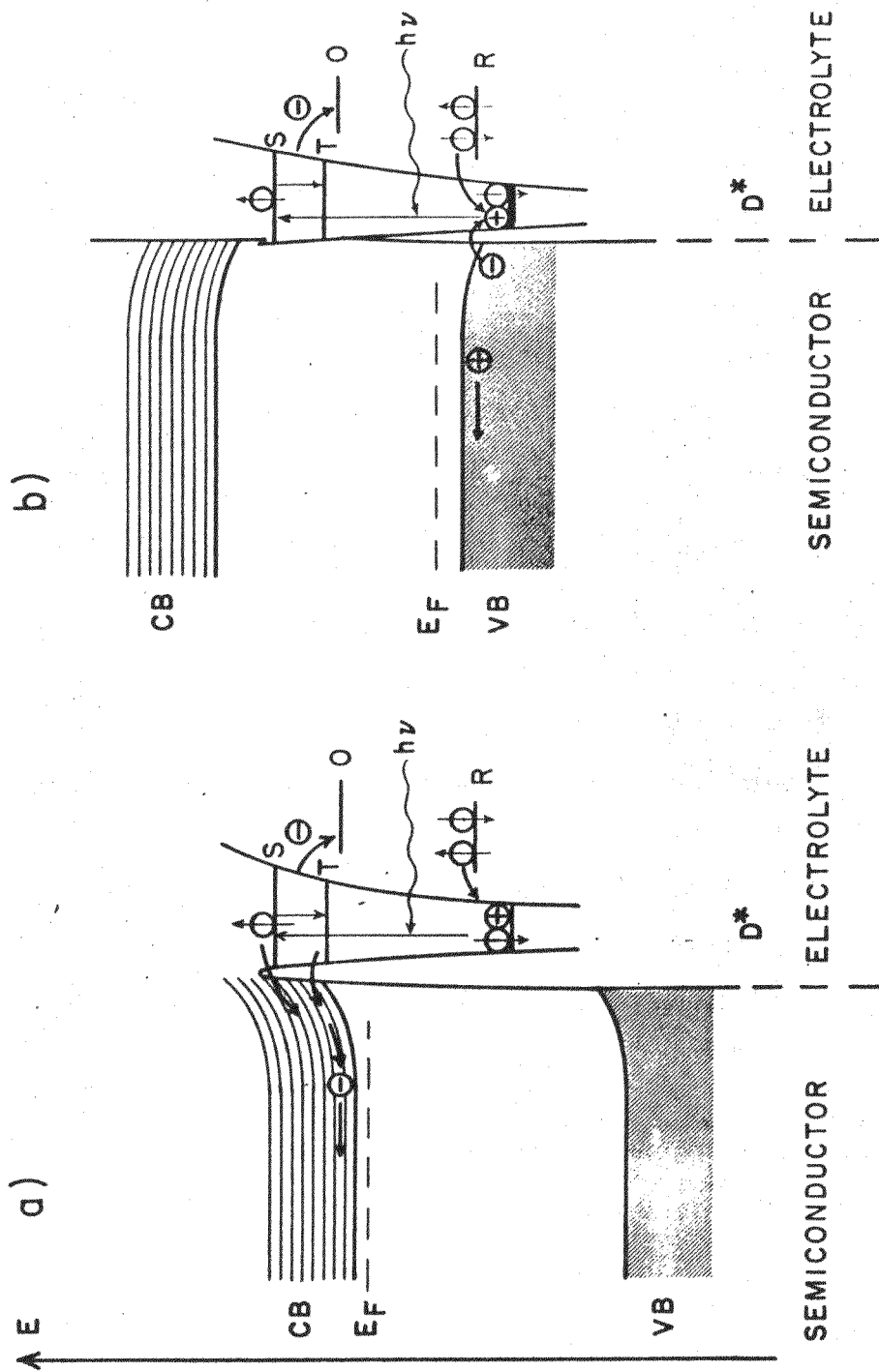

ELECTROLYTE

SEMICONDUCTOR

ELECTROLYTE

SEMICONDUCTOR

XBL 706-5243

Tributsch & Calvin
Figure 1

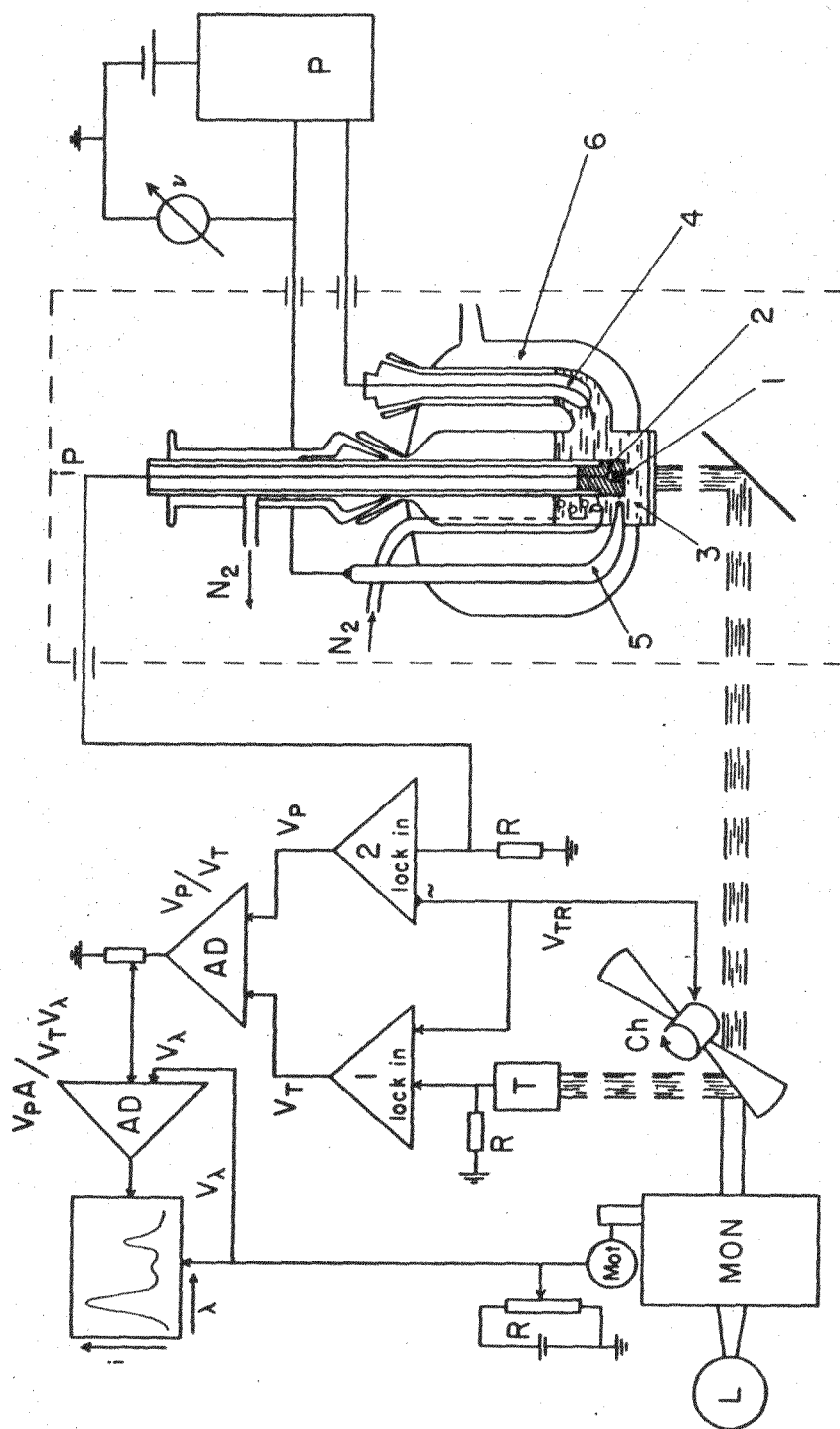

XBL 706-5246

Tributsch & Calvin

Figure 2

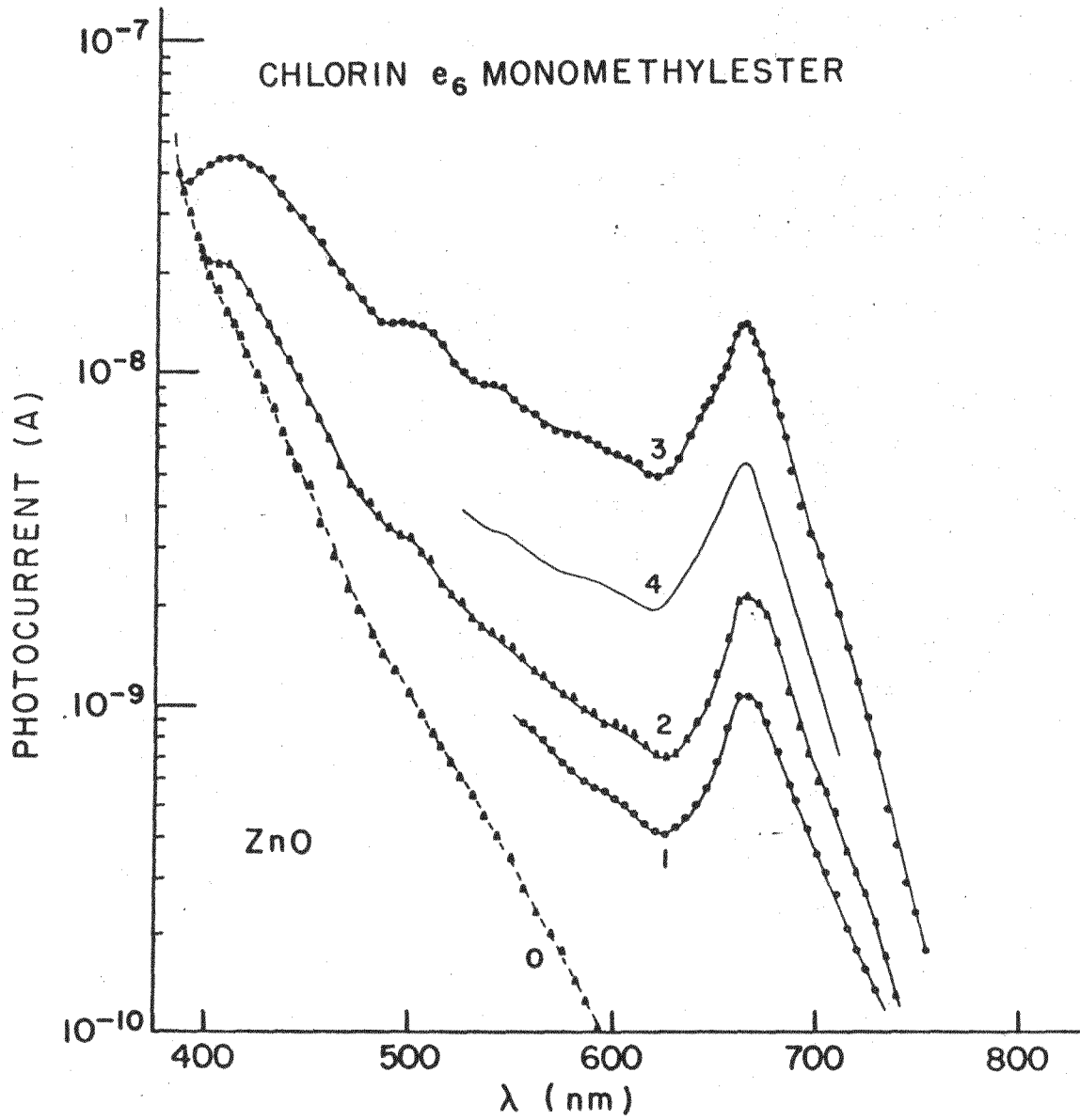

XBL706-5248

Tributsch & Calvin

Figure 3

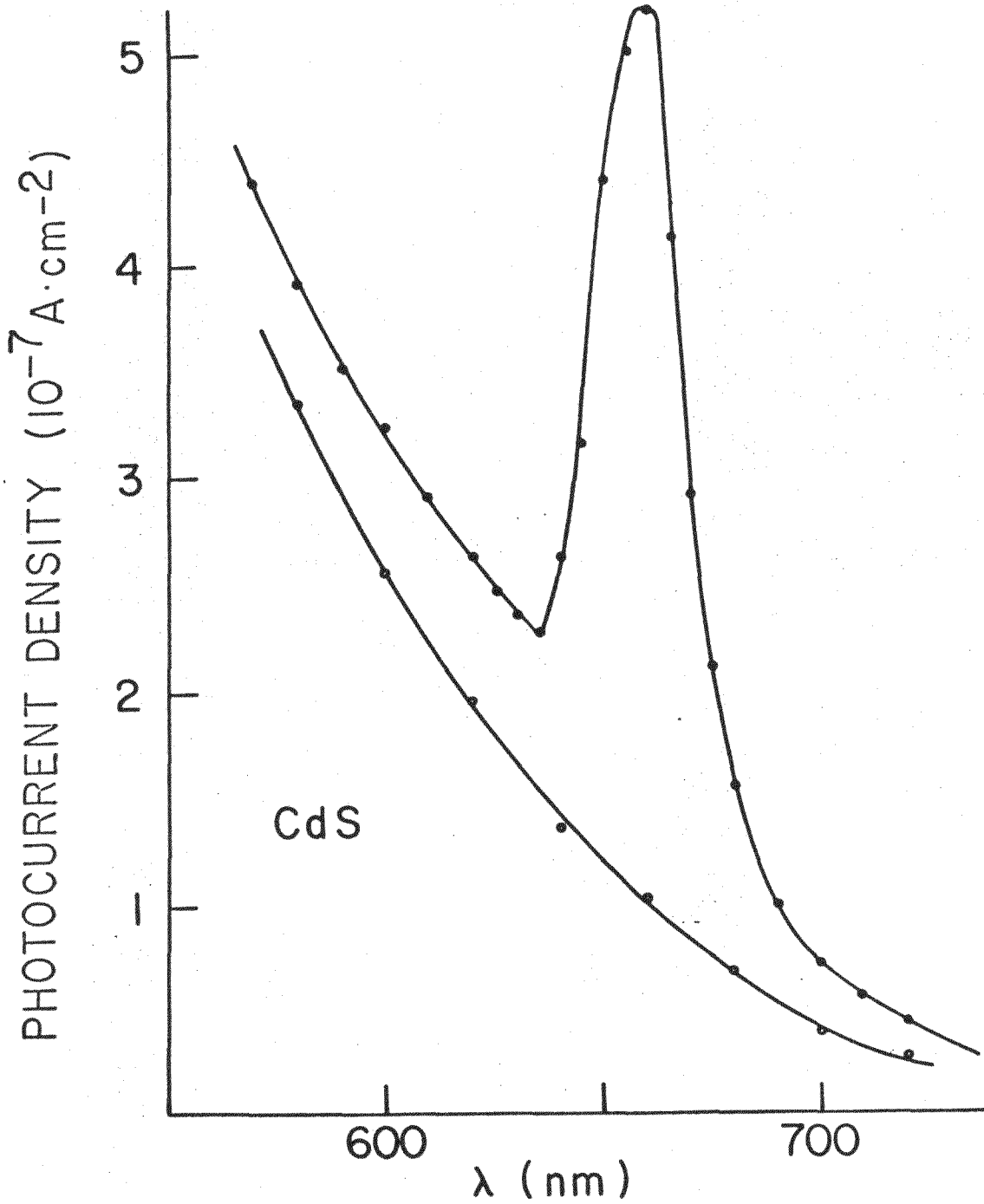

CdS

XBL 705-5213

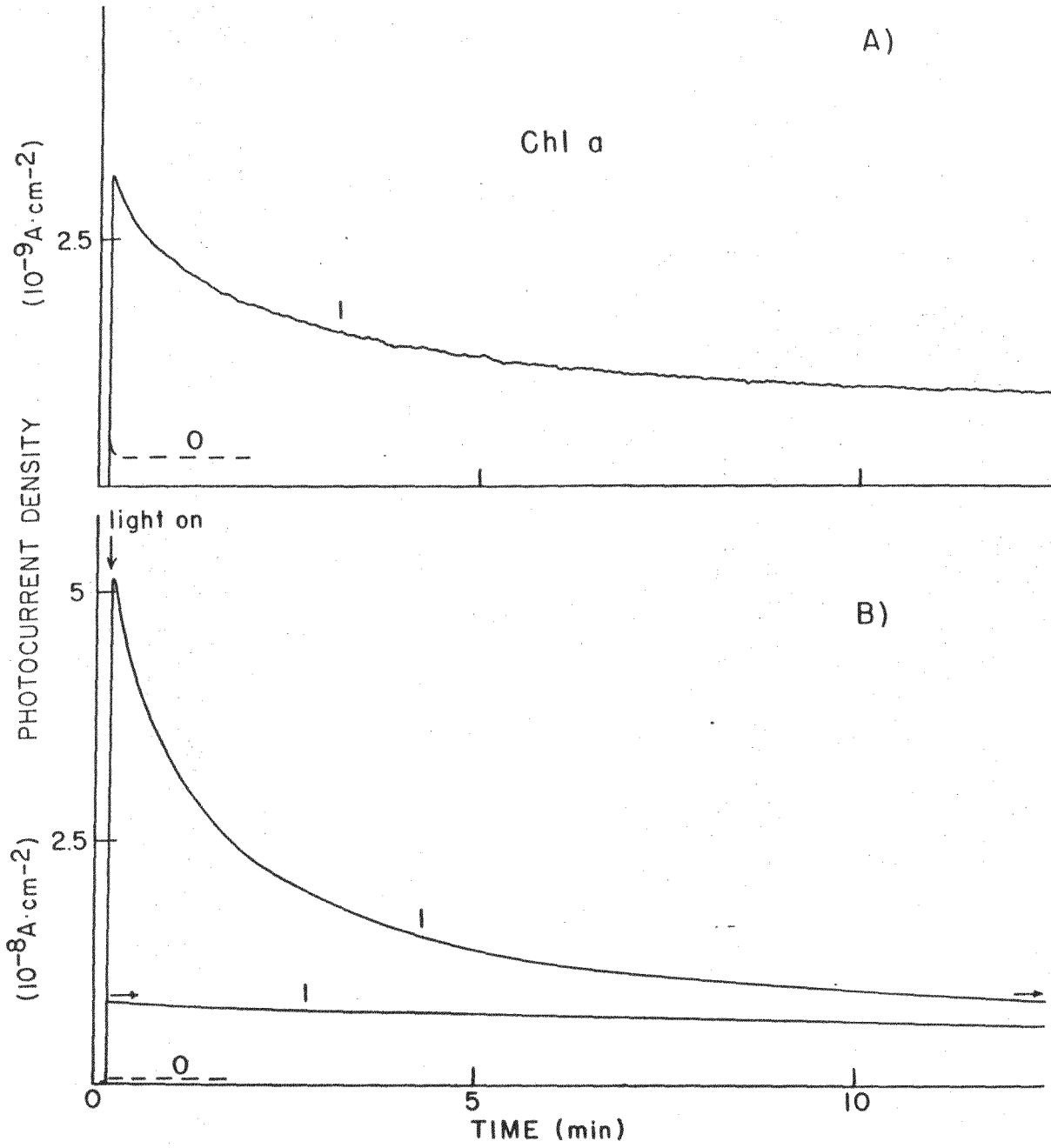

XBL 705-5204

Tributsch & Calvin

Figure 5

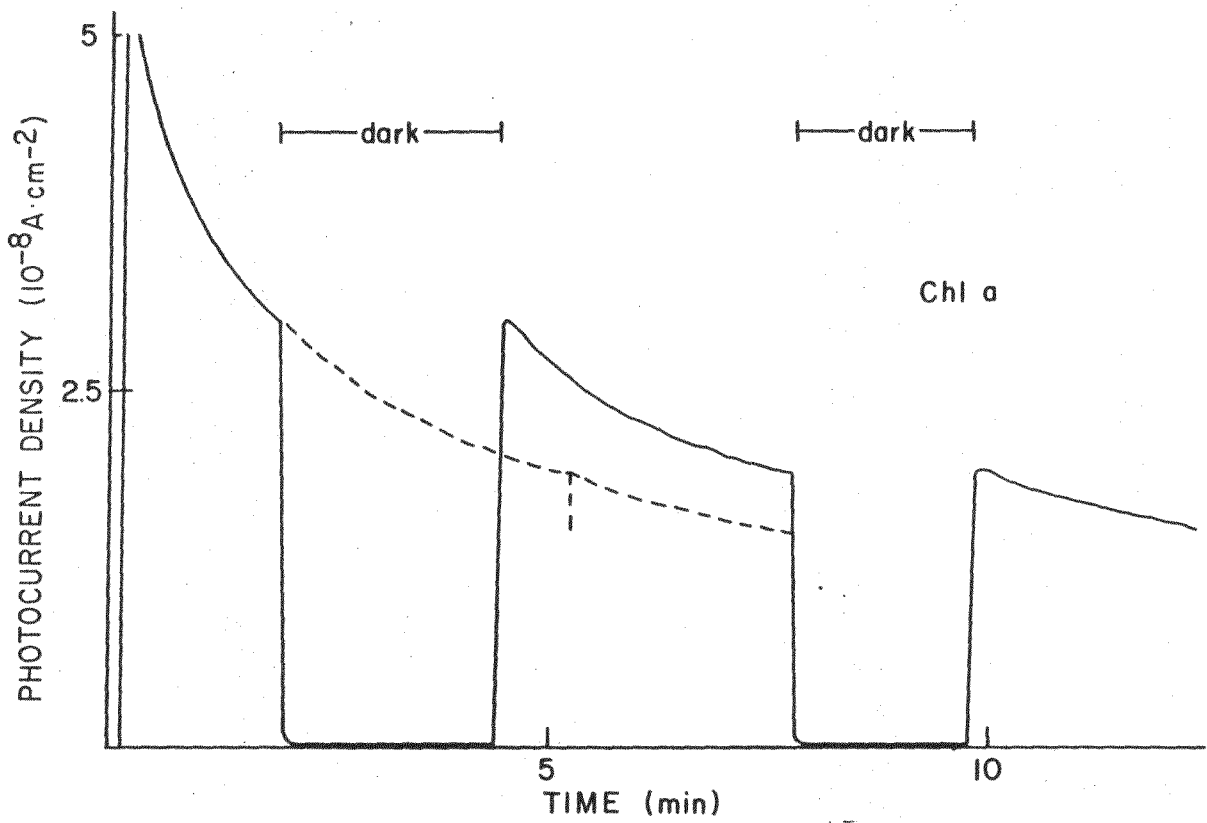

XBL 705-5203

Tributsch & Calvin

Figure 6

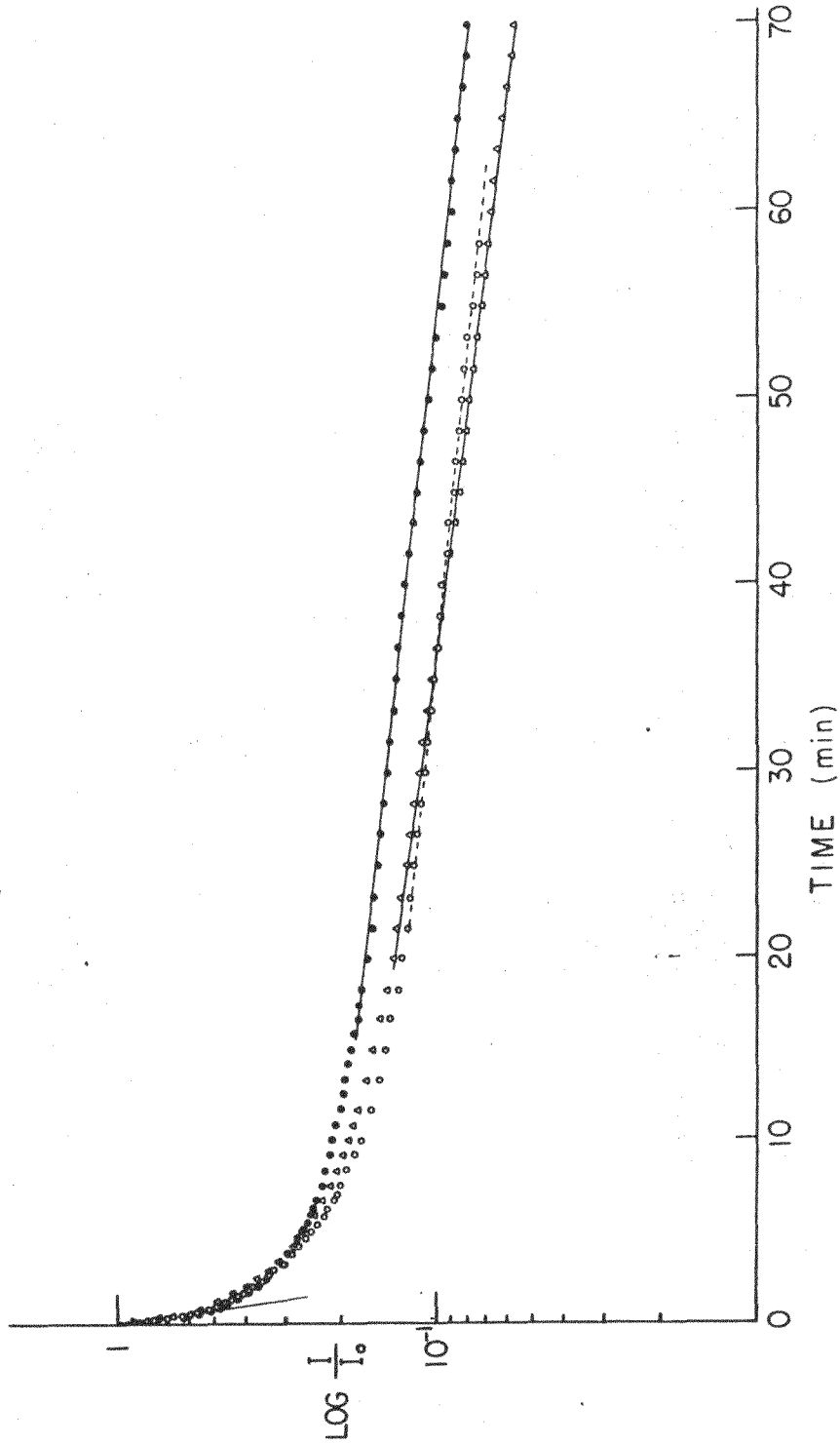

XBL706-5247

Tributsch & Calvin

Figure 7

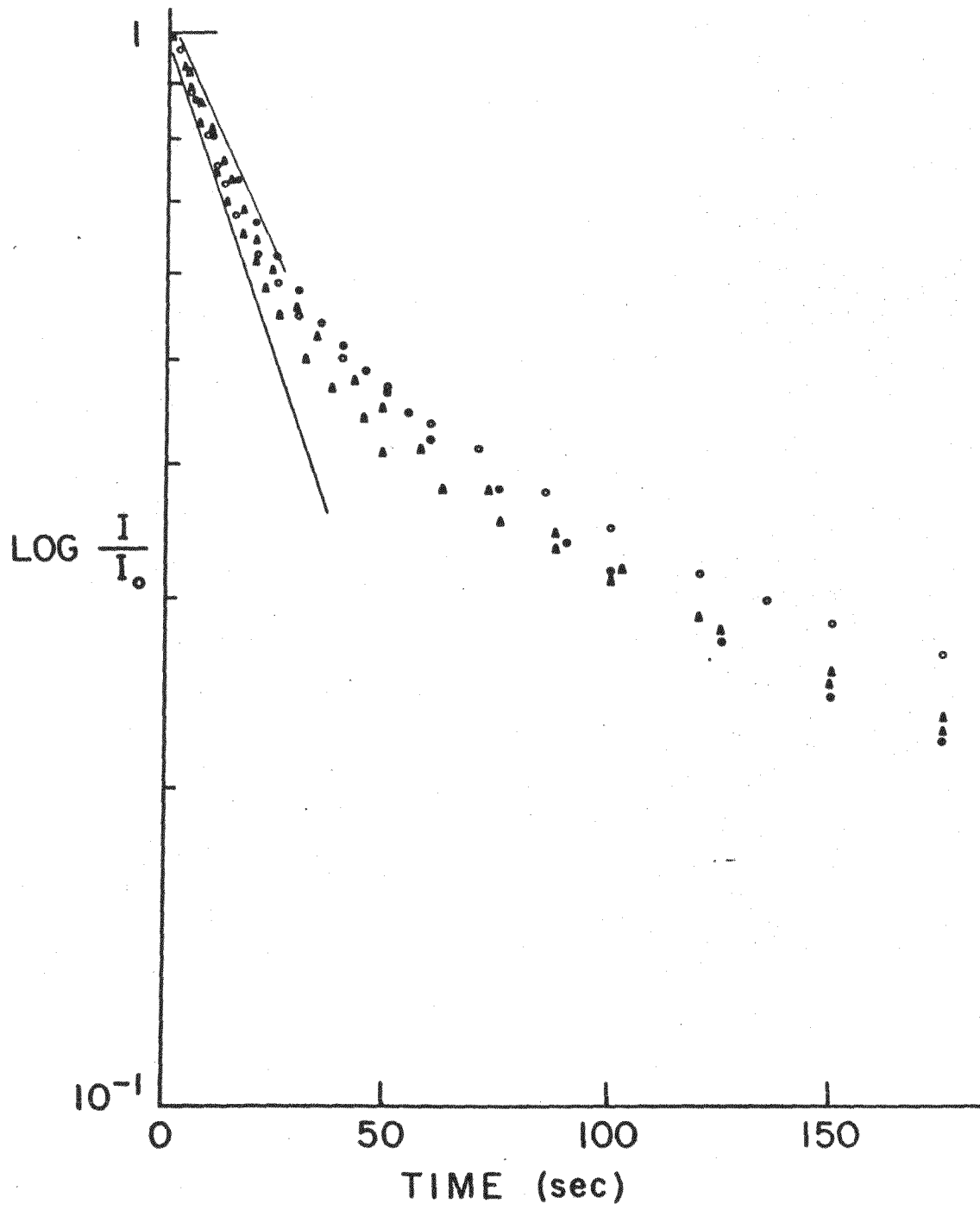

XBL 706-5249

Tributsch & Calvin

Figure 8

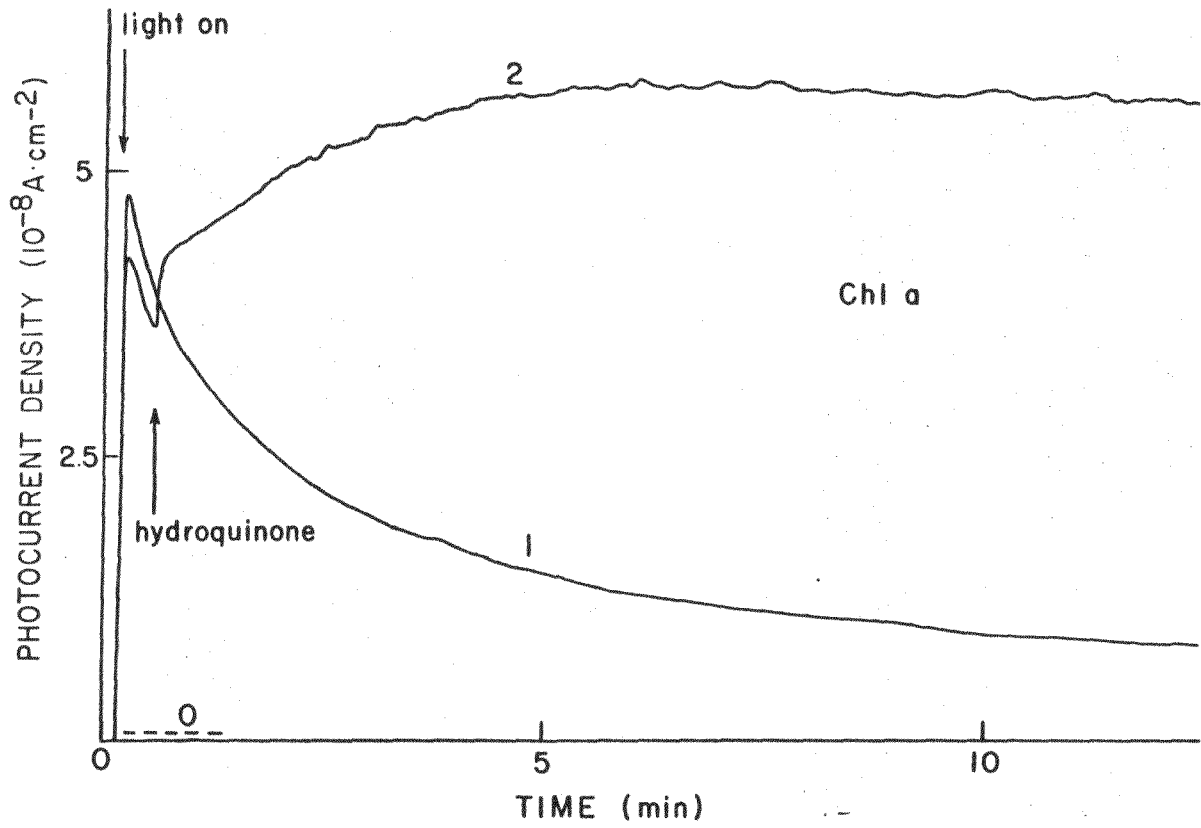

XBL 705-5202

Tributsch & Calvin

Figure 9

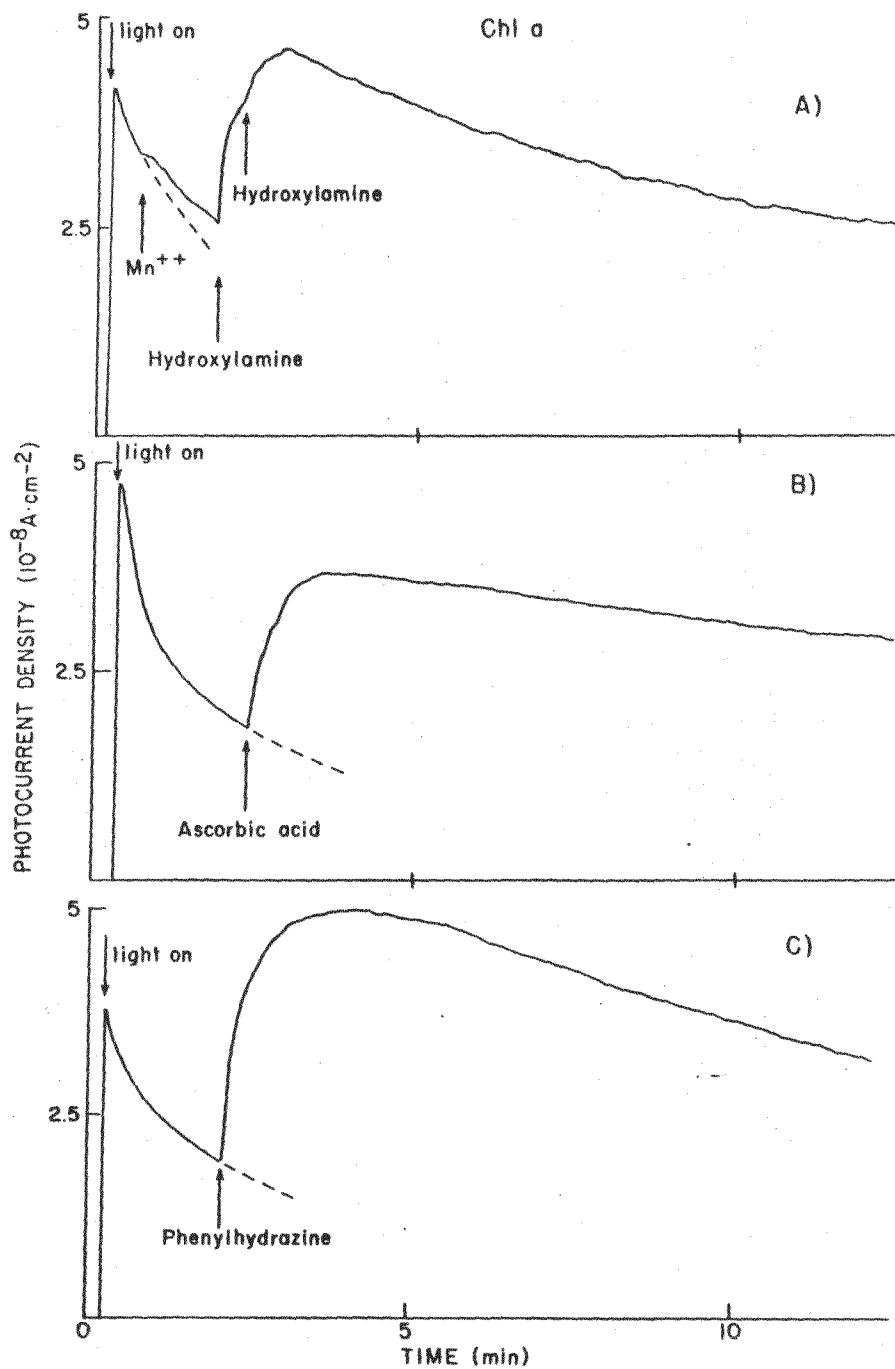

XBL 705-5205

Tributsch & Calvin
Figure 10

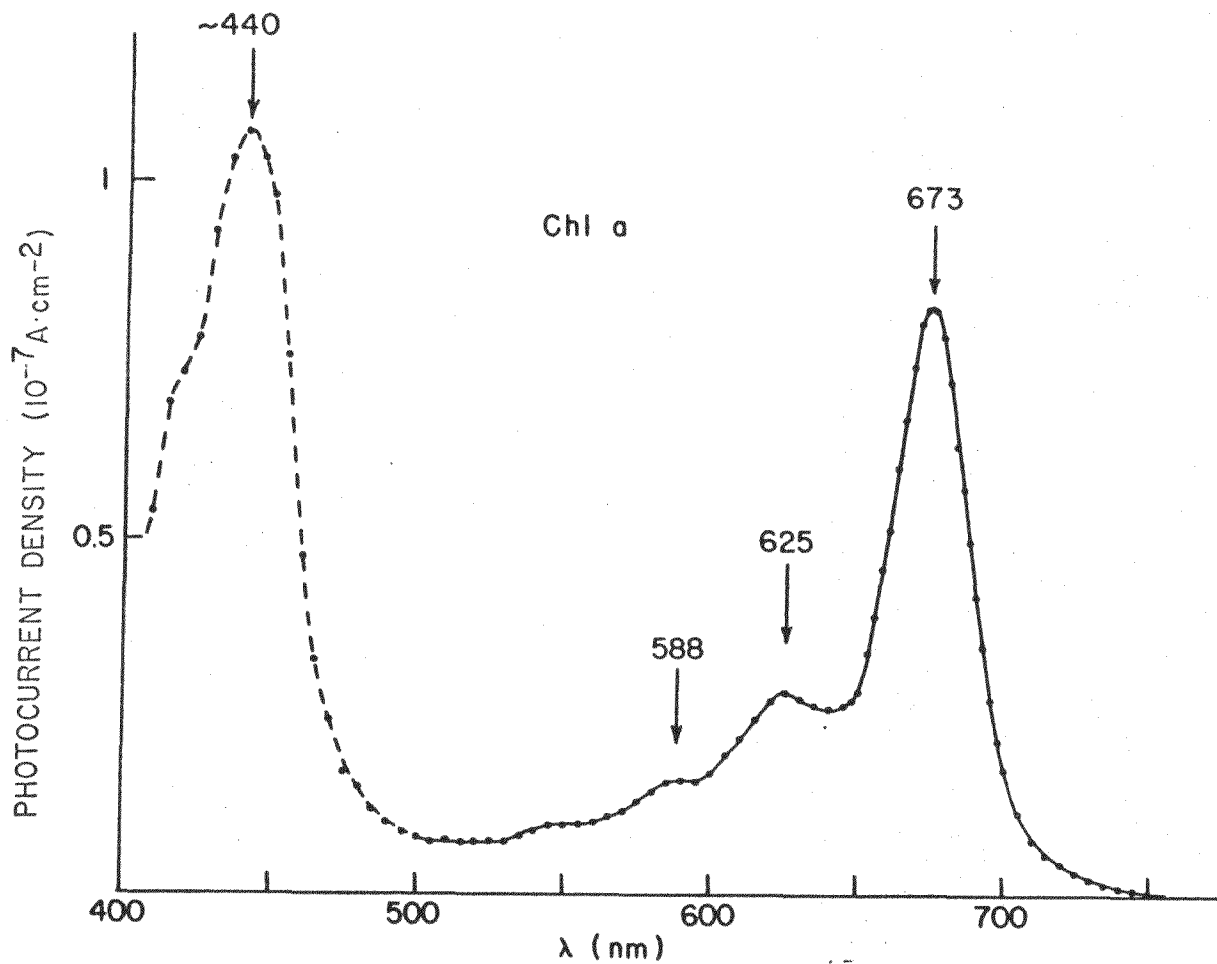

XBL 705-5207

Tributsch & Calvin

Figure 11

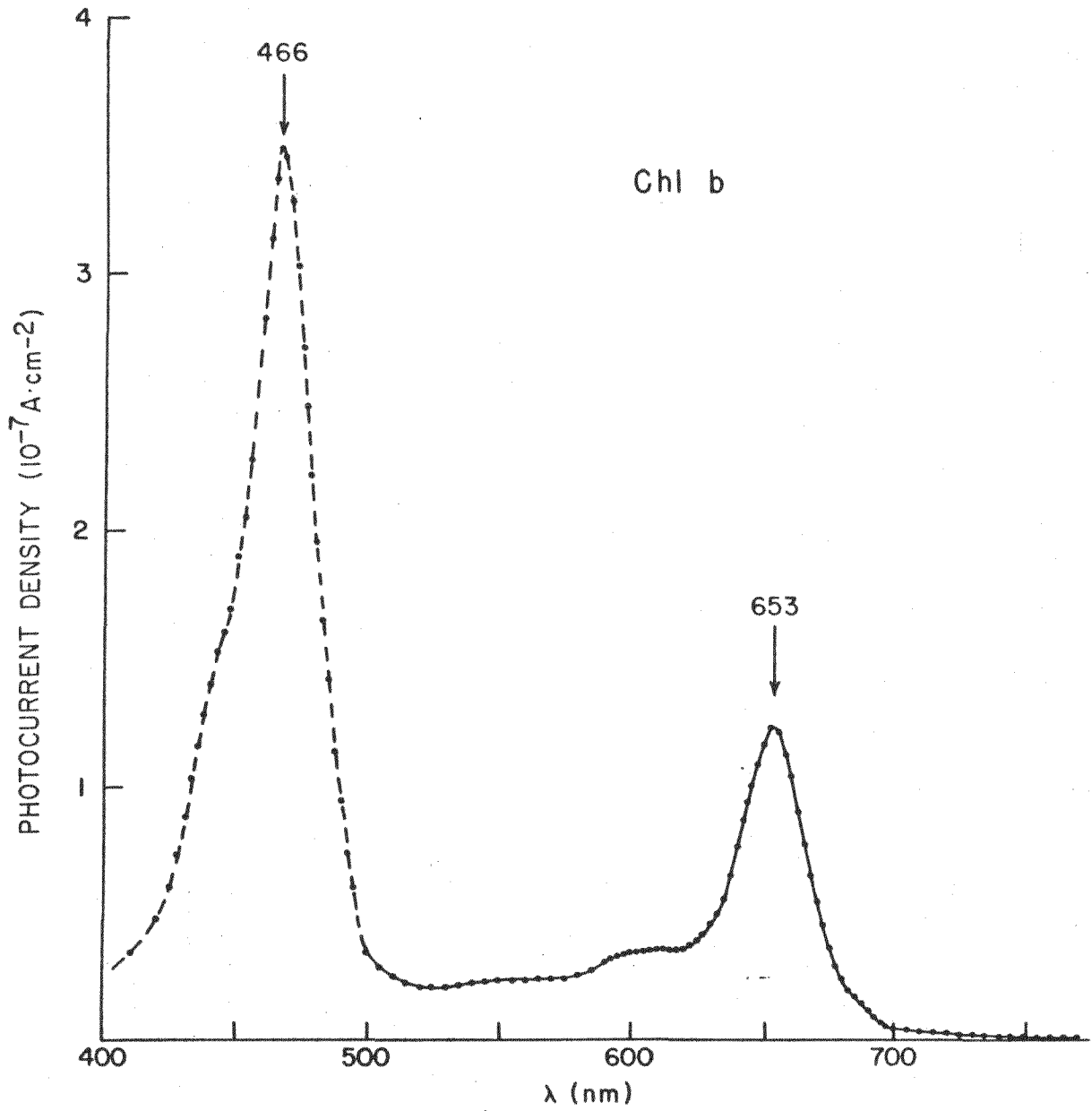

XBL 705-5206

Tributsch & Calvin

Figure 12

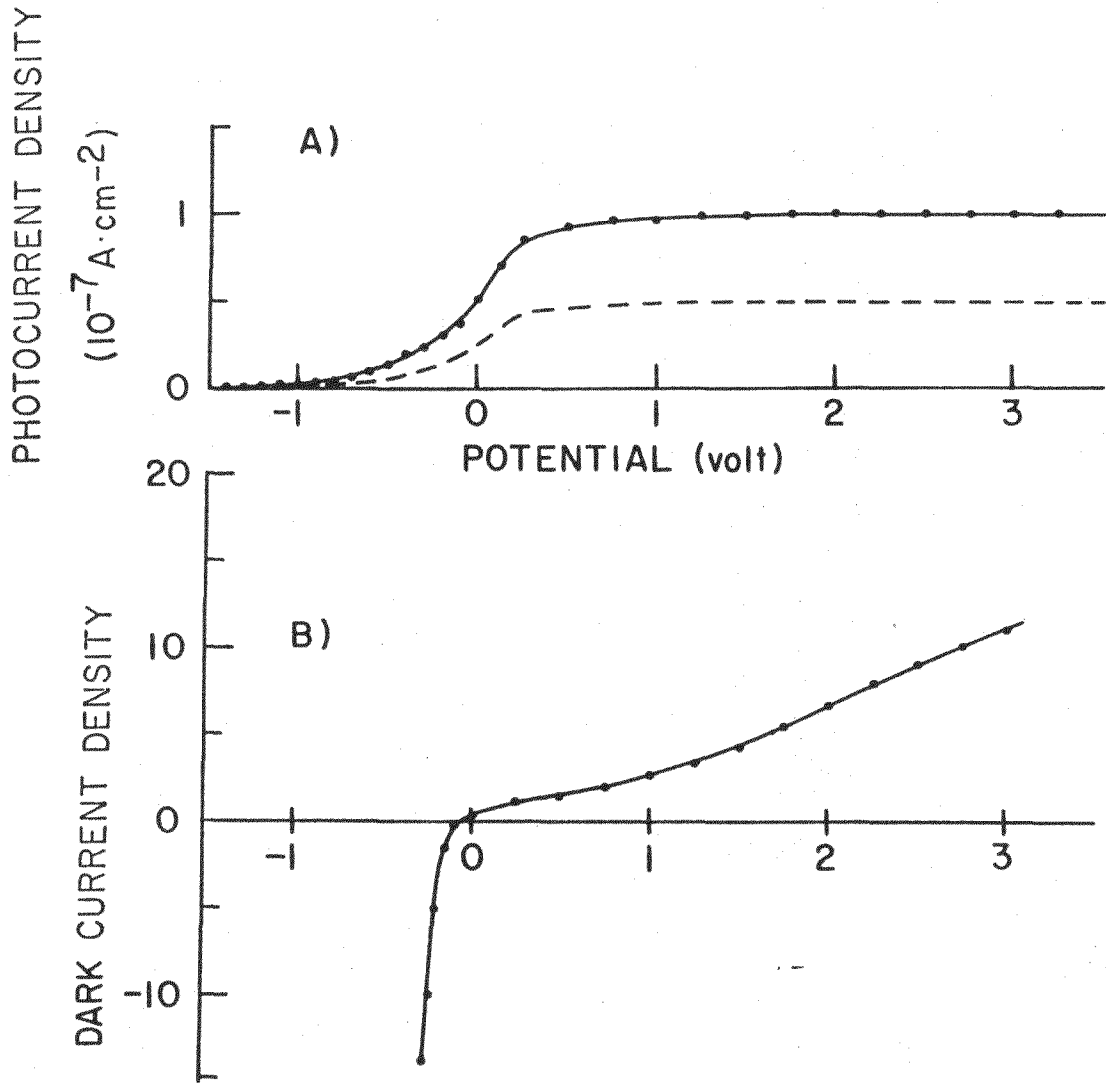

XBL 705-5212

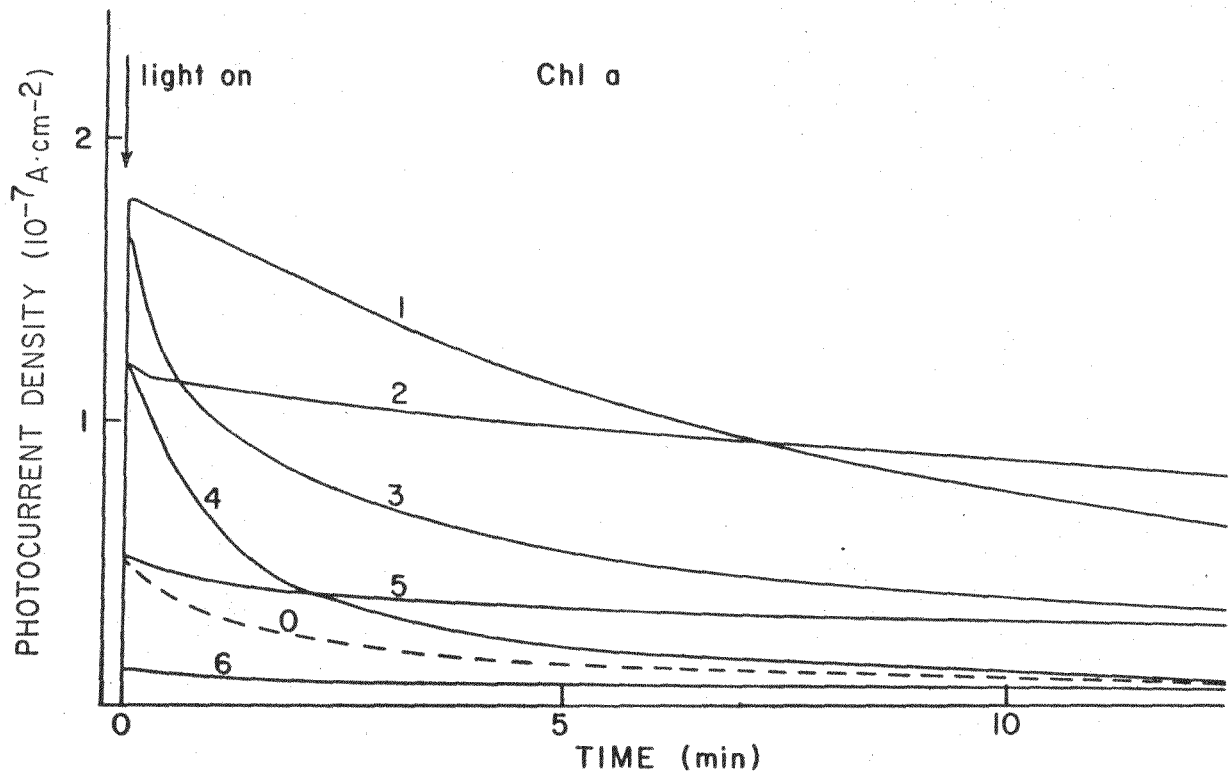

XBL 705-5211

Tributsch & Calvin

Figure 14

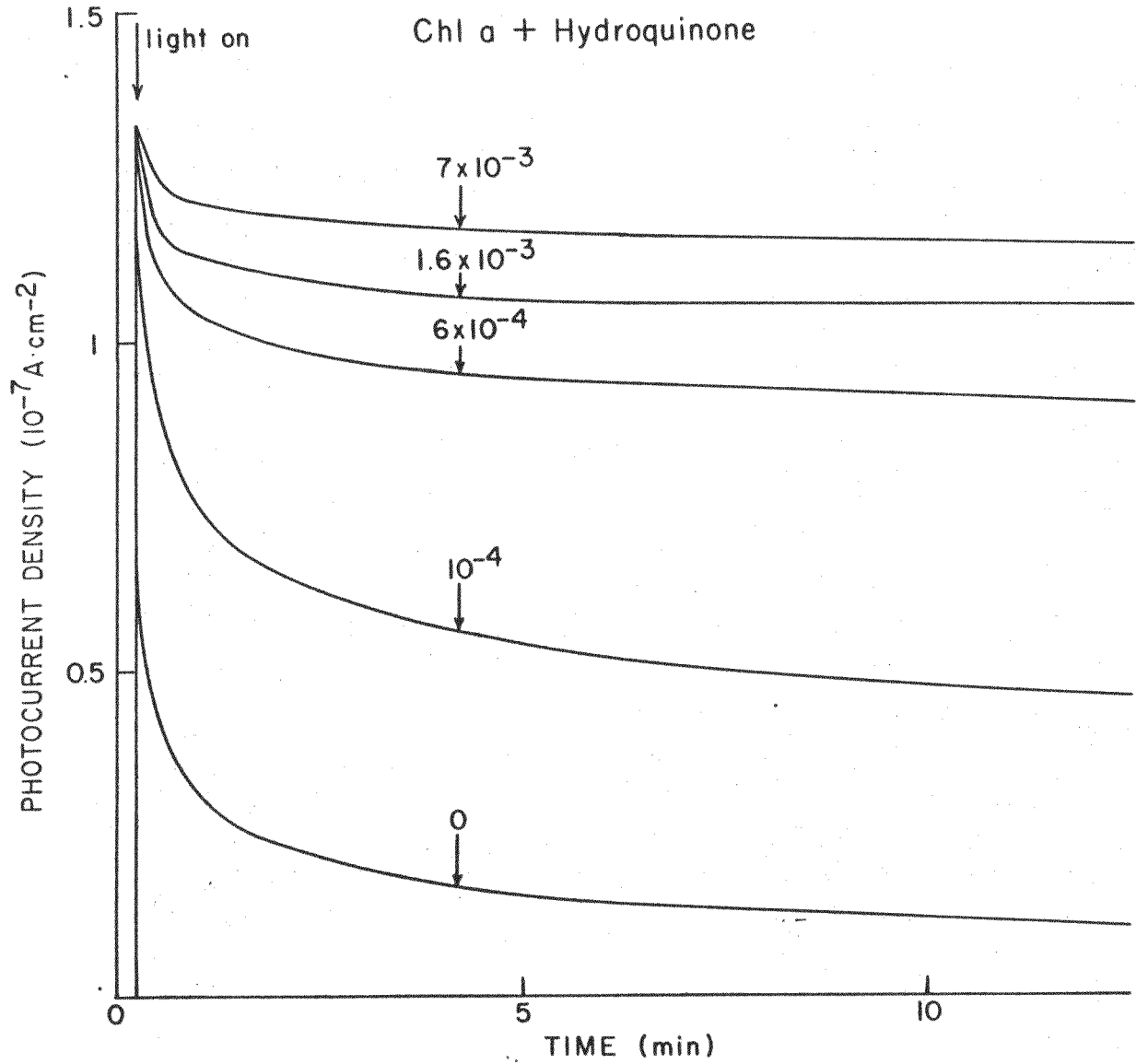

XBL 705-5209

Tributsch & Calvin

Figure 15

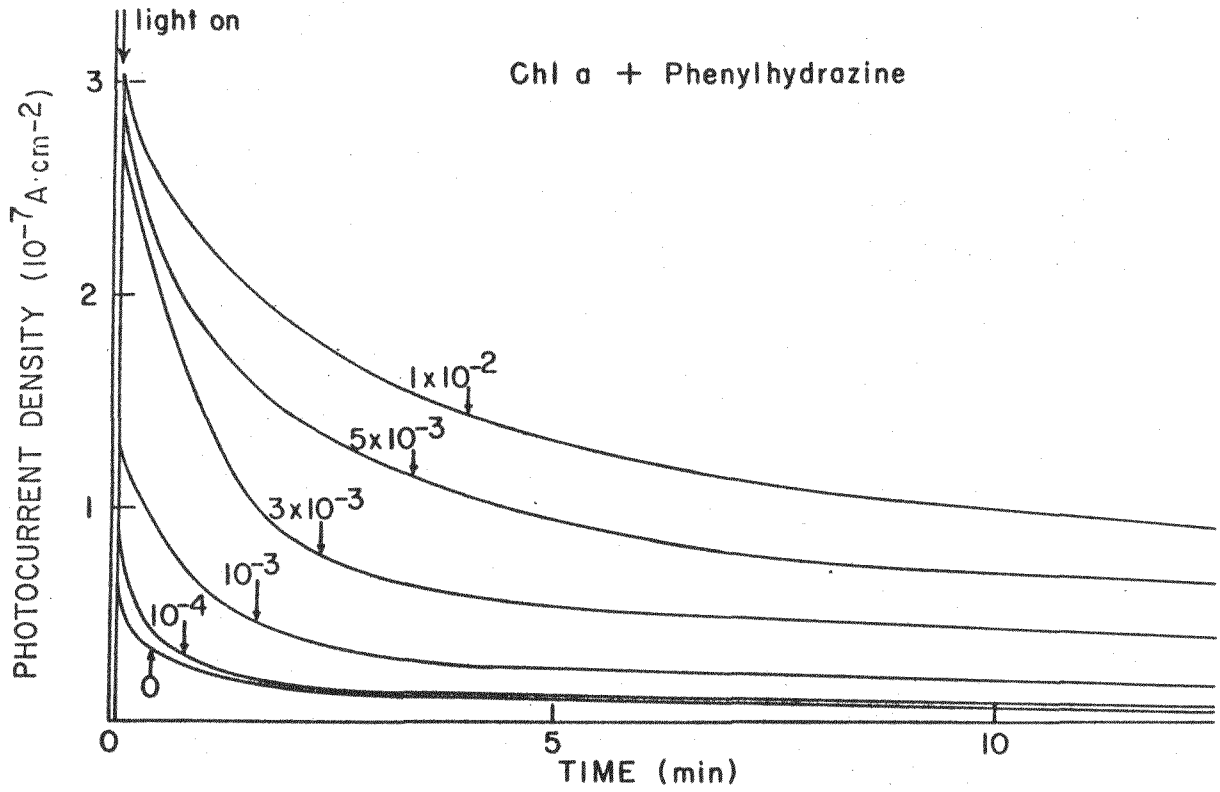

Tributsch & Calvin

Figure 16

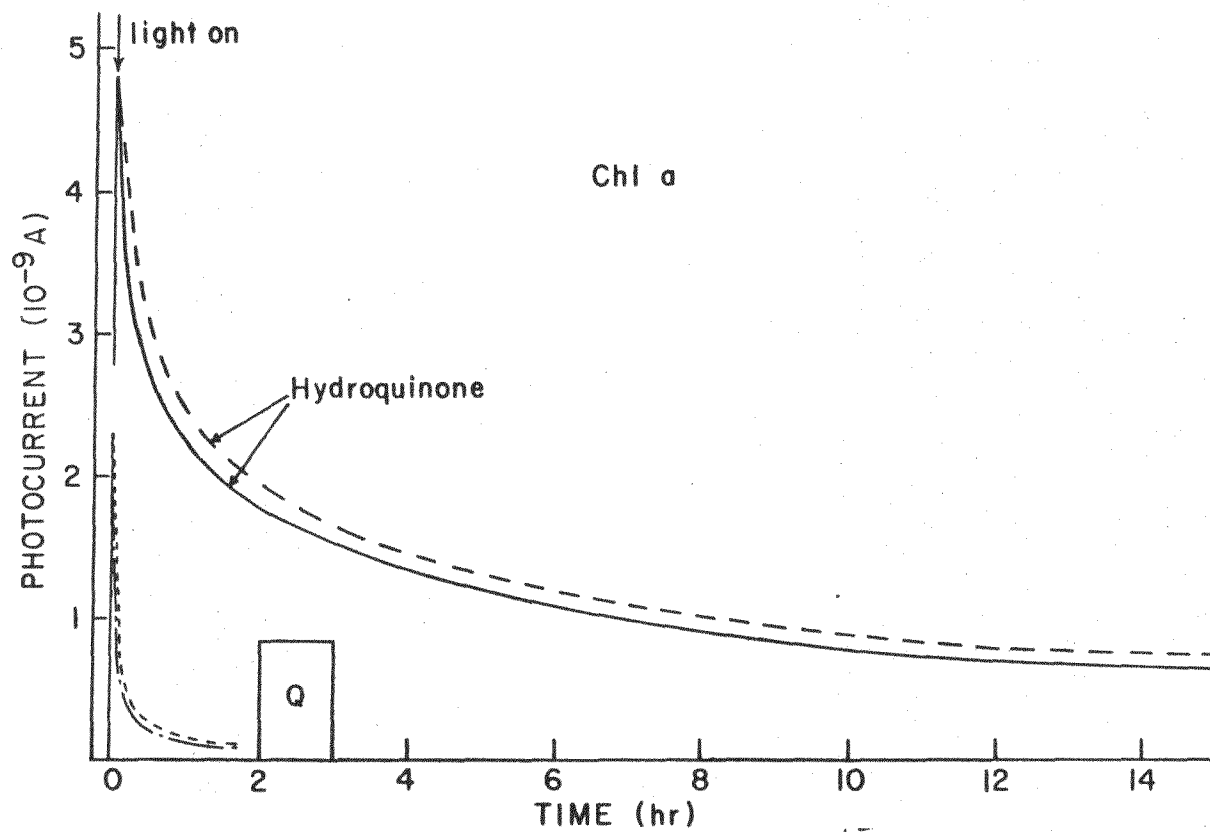

XBL 705-5210

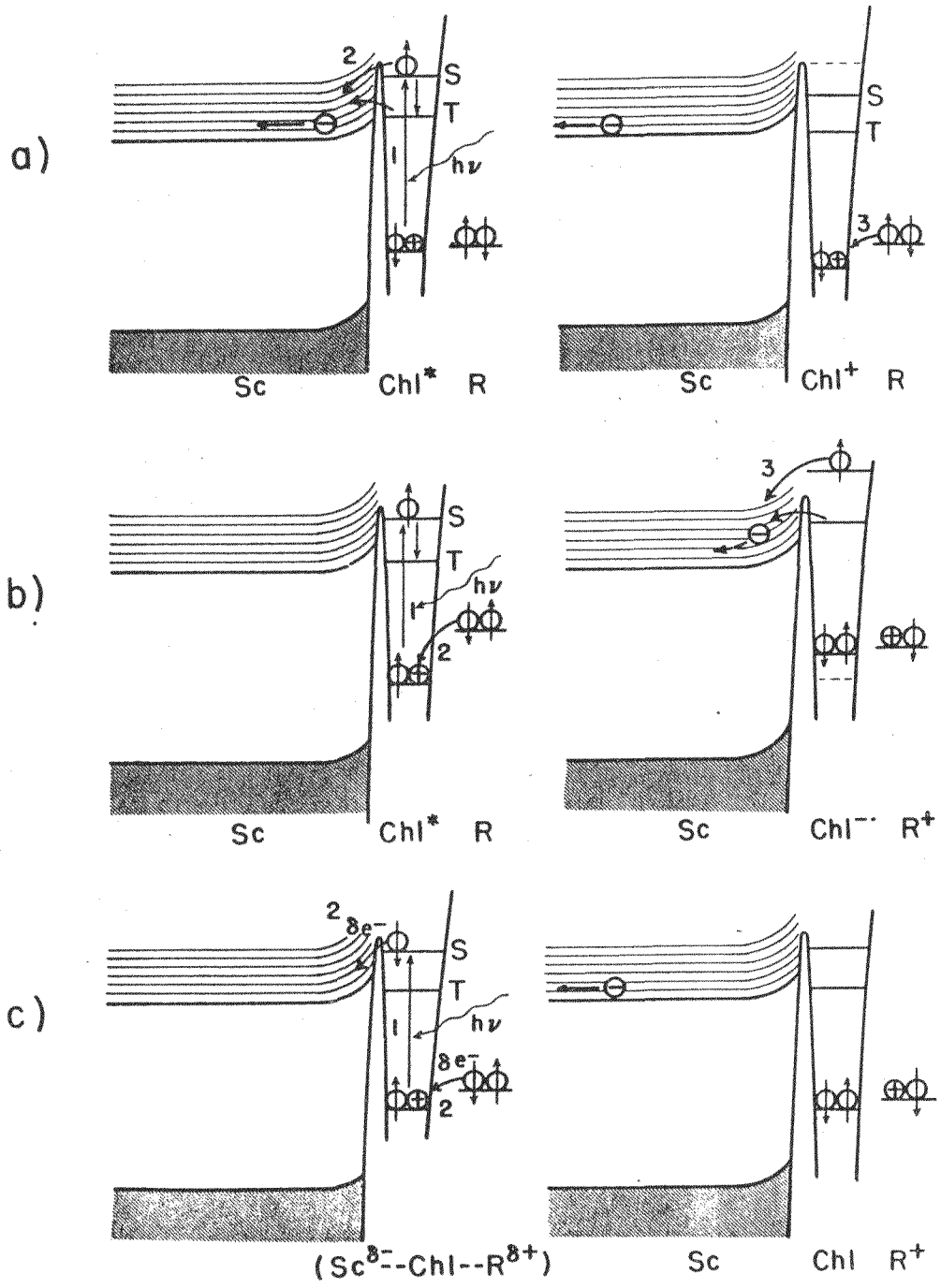

XBL 706-5245

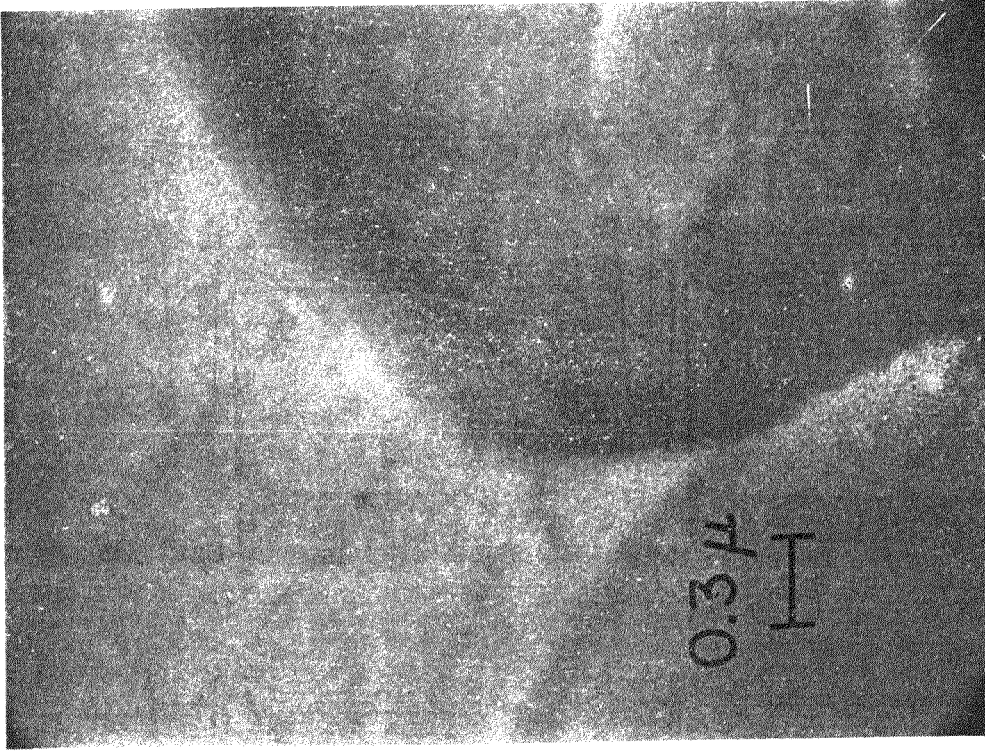

b)

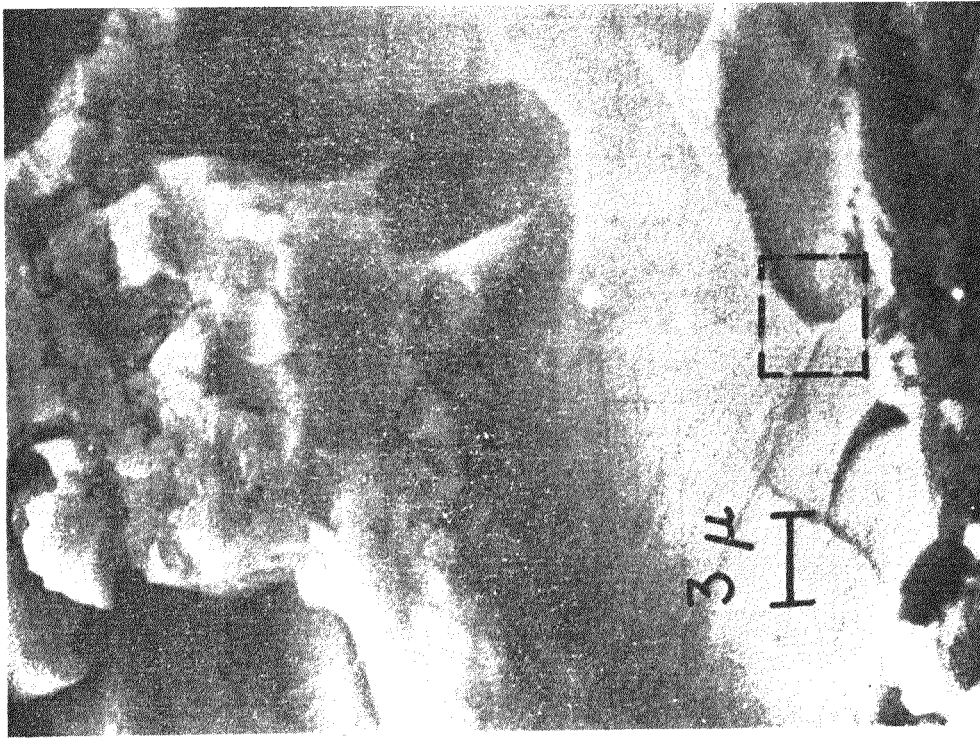

a)

XBB 7012-5403

Fig. 19

LEGAL NOTICE

This report was prepared as an account of Government sponsored work. Neither the United States, nor the Commission, nor any person acting on behalf of the Commission:

- A. Makes any warranty or representation, expressed or implied, with respect to the accuracy, completeness, or usefulness of the information contained in this report, or that the use of any information, apparatus, method, or process disclosed in this report may not infringe privately owned rights; or*
- B. Assumes any liabilities with respect to the use of, or for damages resulting from the use of any information, apparatus, method, or process disclosed in this report.*

As used in the above, "person acting on behalf of the Commission" includes any employee or contractor of the Commission, or employee of such contractor, to the extent that such employee or contractor of the Commission, or employee of such contractor prepares, disseminates, or provides access to, any information pursuant to his employment or contract with the Commission, or his employment with such contractor.